

FOURTH EDITION

TEXTBOOK OF

BIOCHEMISTRY

WITH CLINICAL CORRELATIONS

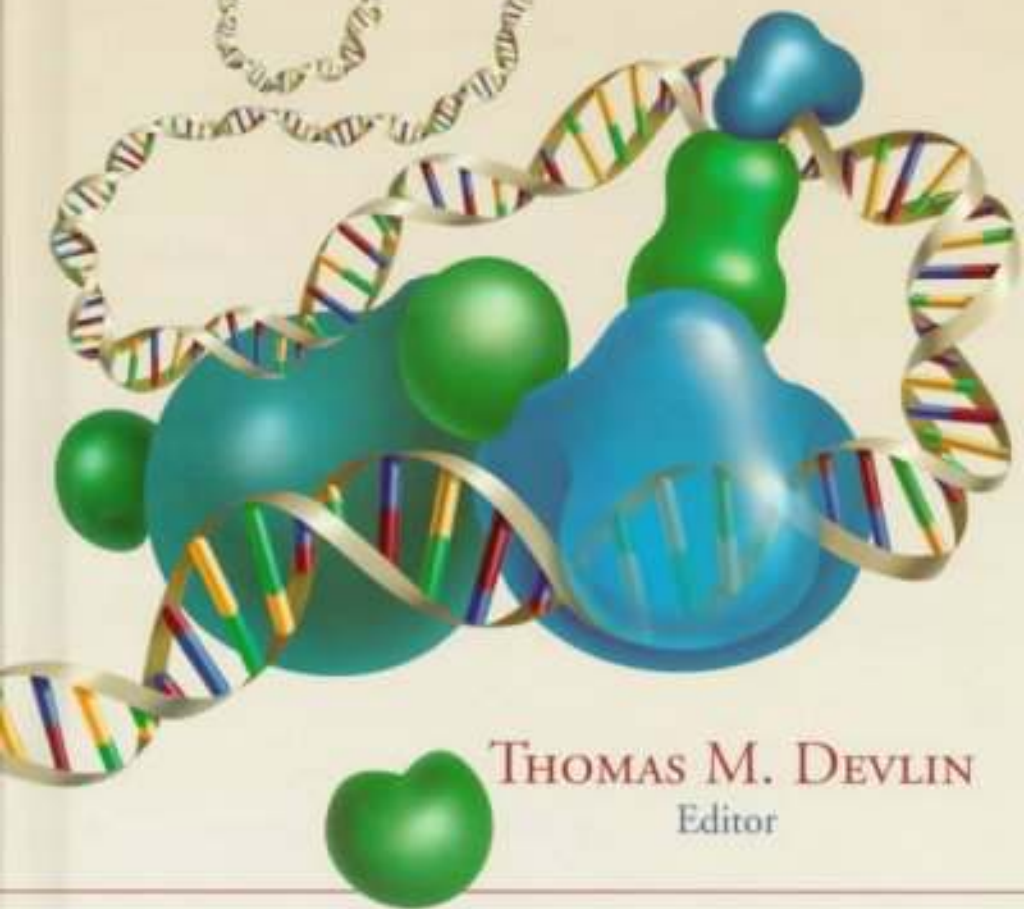

THOMAS M. DEVLIN

Editor

Textbook of Biochemistry with Clinical Correlations

Fourth Edition

Abbreviations in Biochemistry

A (or Ade)	adenine
ACP	acyl carrier protein
ACTH	adrenocorticotrophic hormone
acyl coA	acyl derivative of CoA
ADH	antidiuretic hormone
AdoMet	adenosylmethionine
Ala	alanine
ALA	aminolevulinic acid
AMP	adenosine monophosphate
cAMP	cyclic AMP
Arg	arginine
Asn	asparagine
Asp	aspartate
ATP	adenosine triphosphate
ATPase	adenosine triphosphatase
BMR	basal metabolic rate
BPG	D-2,3 bisphosphoglycerate
C (or Cyt)	cytosine
CDP	cytidine diphosphate
CMP	cytidine monophosphate
CTP	cytidine triphosphate
CoA or CoASH	coenzyme A
CoQ	coenzyme Q (ubiquinone)
cyclic AMP	adenosine 3',5' -cyclic monophosphate
cyclic GMP	guanosine 3',5' -cyclic monophosphate
Cys	cysteine
d	2'-deoxyribo
DNA	deoxyribonucleic acid
cDNA	complementary DNA
dopa	3,4-dihydroxyphenylalanine
EcoRI	EcoRI restriction endonuclease
FAD	flavin adenine dinucleotide (oxidized form)
FADH₂	flavin adenine dinucleotide (reduced form)
fMet	formylmethionine
FMN	flavin mononucleotide (oxidized form)
FMNH₂	flavin mononucleotide (reduced form)
Fp	flavoprotein
G (or Gua)	guanine
GABA	γ -aminobutyric acid
Gal	galactose
Glc	glucose
Gln	glutamine
Glu	glutamate
Gly	glycine
GDP	guanosine diphosphate
GMP	guanosine monophosphate
GTP	guanosine triphosphate
GSH	glutathione
Hb	hemoglobin
HbCO	carbon monoxide hemoglobin
HbO₂	oxyhemoglobin
HDL	high density lipoprotein
HMG CoA	β -hydroxy- β -methylglutaryl CoA
Hyp	hydroxyproline
IDL	intermediate density lipoprotein
IgG	immunoglobulin G
Ile	isoleucine
IP₃	inositol 1,4,5 trisphosphate
ITP	inosine triphosphate
K_m	Michaelis–Menten constant
kb	kilo base pair
LDL	low density lipoprotein
Leu	leucine
Lys	lysine
Mb	myoglobin
MbO₂	oxymyoglobin
Met	methionine
MetHb	methemoglobin
NAD⁺	nicotinamide adenine dinucleotide (oxidized form)
NADH	nicotinamide adenine dinucleotide (reduced form)
NADP⁺	nicotinamide adenine dinucleotide phosphate (oxidized form)
NADPH	nicotinamide adenine dinucleotide phosphate (reduced form)
NANA	N-acetylneuraminic acid
PEP	phosphoenolpyruvate
Phe	phenylalanine
P_i	inorganic orthophosphate
PG	prostaglandin
PP_i	inorganic pyrophosphate
Pro	proline
PRPP	phosphoribosylpyrophosphate
Q	ubiquinone (CoQ)
RNA	ribonucleic acid
mRNA	messenger RNA
rRNA	ribosomal RNA
tRNA	transfer RNA
RNase	ribonuclease
RQ	respiratory quotient (CO ₂ production/O ₂ consumption)
S	Svedberg unit
SAM	S-adenosylmethionine
Ser	serine
SH	sulfhydryl
T (or Thy)	thymine
TCA	Tricarboxylic acid cycle (Krebs cycle)
TG	triacylglycerol
THF	tetrahydrofolic acid
Thr	threonine
TPP	thiamine pyrophosphate
Trp	tryptophan
TTP	thymidine triphosphate
Tyr	tyrosine
U (or Ura)	uracil
UDP	uridine diphosphate
UDP-galactose	uridine diphosphate galactose
UDP-glucose	uridine diphosphate glucose
UMP	uridine monophosphate
UTP	uridine triphosphate
Val	valine
VLDL	very low density lipoprotein

**Textbook of Biochemistry with Clinical Correlations:
Fourth Edition**

Edited by
Thomas M. Devlin, Ph.D.

Professor Emeritus
Department of Biochemistry
MCP-Hahnemann School of Medicine
Allegheny University of the Health Sciences
Philadelphia, Pennsylvania

 **WILEY-LISS**

A JOHN WILEY & SONS, INC., PUBLICATION

New York / Chichester / Weinheim / Brisbane / Singapore / Toronto

Address All Inquiries to the Publisher
Wiley-Liss, Inc., 605 Third Avenue, New York, NY 10158-0012

Copyright © 1997 Wiley-Liss, Inc.

Printed in the United States of America.

This text is printed on acid-free paper.

Under the conditions stated below the owner of copyright for this book hereby grants permission to users to make photocopy reproductions of any part or all of its contents for personal or internal organizational use, or for personal or internal use of specific clients. This consent is given on the condition that the copier pay the stated per-copy fee through the Copyright Clearance Center, Incorporated, 27 Congress Street, Salem, MA 01970, as listed in the most current issue of "Permissions to Photocopy" (Publisher's Fee list, distributed by CCC, Inc.), for copying beyond that permitted by sections 107 or 108 of the US Copyright Law. This consent does not extend to other kinds of copying for general distribution, for advertising or promotional purposes, for creating new collective works, or for resale.

Cover Illustration: An artist's conception of the initiation of the DNA transcription mechanism catalyzed by RNA polymerase and involving protein transcription factors.

Subject Editor: Stephanie Diment

Design: Laura Jerardi

Senior Managing Editor: John Sollami

Marketing Managers: David Stier and David Steltenkamp

Manufacturing Manager: Rick Mumma

Illustration Coordinator: Barbara Kennedy

Illustrations and Cover: Page Two

This book was set in ITC Garamond Light by Bi-Comp Incorporated, and was printed and bound by Von Hoffmann Press.

Library of Congress Cataloging-in-Publication Data

Textbook of biochemistry: with clinical correlations/edited by

Thomas M. Devlin — 4th ed.

p. cm.

Includes bibliographical references and index.

ISBN 0-471-15451-2

1. Biochemistry. 2. Clinical biochemistry. I. Devlin, Thomas M.

[DNLN: 1. Biochemistry. QU 4 T355 1997]

QP514.2.T4 1997

612'.015—dc21

97-1078

CIP

10 9 8 7 6 5 4 3

*To
Katie, Matthew, Ryan, and Laura*

Contributors

Stelios Aktipis, Ph.D.

Professor
Department of Molecular and Cellular Biochemistry
Stritch School of Medicine
Loyola University of Chicago
2160 S. First Avenue
Maywood, IL 60153

Carol N. Angstadt, Ph.D.

Professor
Department of Biomedical Sciences, M.S.# 456
Allegheny University of the Health Sciences
Broad and Vine Streets
Philadelphia, PA 19102-1192

email: angstadt@allegheny

William Awad, JR., M.D., Ph.D.

Professor
Departments of Medicine and of Biochemistry
University of Miami School of Medicine
P.O. Box 016960
Miami, FL 33101

email: wawad@mednet.med.miami.edu

James Baggott, Ph.D.

Associate Professor
Department of Biochemistry
MCP-Hahnemann School of Medicine
Allegheny University of the Health Sciences
2900 Queen Lane
Philadelphia, PA 19129

email: baggottj@allegheny.edu

Stephen G. Chaney, Ph.D.

Professor
Departments of Biochemistry and Biophysics and of Nutrition
Mary Ellen Jones Building
University of North Carolina at Chapel Hill School of Medicine CB# 7260
Chapel Hill, NC 27599-7260

email: schaney.biochem@mhs.unc.edu

Marguerite W. Coomes, Ph.D.

Associate Professor
Department of Biochemistry and Molecular Biology
Howard University College of Medicine
520 W Street, N.W.
Washington, DC 20059-0001

email: mwcoomes@erols.com

Joseph G. Cory, Ph.D.

Professor and Chair
Department of Biochemistry
Brody Medical Sciences Building
East Carolina University School of Medicine
Greenville, NC 27858-4354

David W. Crabb, M.D.

Professor
Departments of Medicine and of Biochemistry and Molecular Biology
Emerson Hall 317
Indiana University School of Medicine
545 Barnhill Drive
Indianapolis, IN 46202-5124

email: dcrabb@-medicine.dmed.iupi.edu

Thomas M. Devlin, Ph.D.

Professor Emeritus
Department of Biochemistry
MCP-Hahnemann School of Medicine
Allegheny University of the Health Sciences
Broad and Vine Streets
Philadelphia, PA 19102-1192

email: devlint@allegheny.edu

John E. Donelson, Ph.D.

Professor
Howard Hughes Medical Institute and Department of Biochemistry
University of Iowa College of Medicine
300 Eckstein Medical Research Building
Iowa City, IA 52242

email: jedonels@vaxa.weeg.uiowa.edu

Robert H. Glew, Ph.D.

Professor and Chair
 Department of Biochemistry
 Basic Medical Science Building, Room 249
 University of New Mexico
 School of Medicine
 915 Camino de Salud NE
 Albuquerque, NM 87131

email: rglew@medusa.unm.edu

Dohn G. Glitz, Ph.D.

Professor
 Department of Biological Chemistry
 UCLA School of Medicine
 Los Angeles, CA 90095-1737

email: dglitz@biochem.medsch.ucla.edu

Robert A. Harris, Ph.D.

Showalter Professor and Chair
 Department of Biochemistry and Molecular Biology
 Indiana University School of Medicine
 635 Barnhill Drive
 Indianapolis, IN 46202-5122

email: raharris@indyvax.dupui.edu

Ulrich Hopfer, M.D., Ph.D.

Professor
 Department of Physiology and Biophysics
 Case Western Reserve University
 2109 Abington Road
 Cleveland, OH 44106-4970

email: uxh@po.cwru.edu

Michael N. Liebman, Ph.D.

Director, Bioinformatics and Genomics
 VYSIS, Inc.
 3100 Woodcreek Drive
 Downers Grove, IL 60515

email: mliebman@vysis.com

Gerald Litwack, Ph.D.

Professor and Chair
 Department of Biochemistry and Molecular Pharmacology
 Deputy Director Kimmel Cancer Institute
 Jefferson Medical College
 Thomas Jefferson University
 233 South 10th Street
 Philadelphia, PA 19107

email: litwack@lac.jci.tju.edu

Bettie Sue Siler Masters, Ph.D.

Robert A. Welch Foundation Professor in Chemistry
 Department of Biochemistry
 University of Texas Health Science Center at San Antonio
 7703 Floyd Curl Drive
 San Antonio, TX 78284-7760

email: masters@uthscsa.edu

Denis McGarry, Ph.D.

Professor
 Departments of Internal Medicine and of Biochemistry
 Bldg. G5, Room 210
 University of Texas Southwestern Medical Center at Dallas
 5323 Harry Hines Blvd
 Dallas, TX 75235-9135

email: utsmc.lnparke@mednet.swmed.edu

Richard T. Okita, Ph.D.

Professor
 Department of Pharmaceutical Science
 105 Wegner Hall
 College of Pharmacy
 Washington State University
 Pullman, WA 99164-6510

email: okitar@mail.wsu.edu

Merle S. Olson, Ph.D.

Professor and Chair
 Department of Biochemistry
 University of Texas Health Science Center
 7703 Floyd Curl Drive
 San Antonio, TX 78284-7760

email: olson@bioc02.uthscsa.edu

Francis J. Schmidt, Ph.D.

Professor
 Department of Biochemistry
 M121 Medical Sciences
 University of Missouri-Columbia
 Columbia, MO 65212-0001

email: bcfranks@muccmail.missouri.edu

Thomas J. Schmidt, Ph.D.

Associate Professor
 Department of Physiology and Biophysics
 5-610 Bowen Science Building
 University of Iowa, College of Medicine
 Iowa City, IA 52242-1109

email: thomas-schmidt@uiowa.edu

Richard M. Schultz, Ph.D.

Professor and Chair
Department of Molecular and Cellular Biochemistry
Stritch School of Medicine
Loyola University of Chicago
2160 South First Avenue
Maywood, IL 60153

email: rschult@luc.edu

Nancy B. Schwartz, Ph.D.

Professor
Departments of Pediatrics and of Biochemistry and Molecular Biology
University of Chicago, MC 5058
5841 S. Maryland Ave.
Chicago, IL 60637-1463

email: n-schwartz@u.chicago.edu

Thomas E. Smith, Ph.D.

Professor and Chair
Department of Biochemistry and Molecular Biology
College of Medicine
Howard University
520 W Street, N.W.
Washington, DC 20059-0001

email: tesmith@erols.com

Gerald Soslau, Ph.D.

Professor
Department of Biochemistry and Director, IMS Program
MCP-Hahnemann School of Medicine, M.S. 344
Allegheny University of the Health Sciences
Broad and Vine Streets
Philadelphia, PA 19102-1192

email: soslaug@allegheny.edu

J. Lyndal York, Ph.D.

Professor
Department of Biochemistry and Molecular Biology
College of Medicine
University of Arkansas for Medical Science
4301 W. Markham St.
Little Rock, AR 72205-7199

email: jlyork@life.uams.edu

Foreword

These are very exciting times for biochemistry and especially for that part that pertains to human biology and human medicine. The much discussed Human Genome Project is likely to be completed very early in the next millennium, by the time most users of *Textbook of Biochemistry With Clinical Correlations* have graduated. The Human Genome Project should provide a blueprint of the 100,000 or so genes that the human genome is estimated to contain and lead to an explosion of amazing proportions in knowledge on complex physiological processes and multigenic disorders. This mapping will reveal undreamed of interrelationships and elucidate control mechanisms of the fundamental processes of development of the human organism and of their interactions with both milieus (the internal and external). Already, one eukaryotic genome (that of brewer's yeast, comprising 14 million base pairs in 16 chromosomes) was completed just before I set out to write this Foreword, while three microbial genomes (that of *Mycoplasma genitalium*—580,070 base pairs, *Hemophilus influenzae*—1.83 million base pairs, and *Synechosystis*—a photosynthetic organism—3.57 million base pairs) have been completed within 3 to 18 months of isolation of their DNA. Work on the genomes of *Mycobacterium tuberculosis* (4.5 million base pairs) and of *Plasmodium falciparum*—the malarial parasite (27 million base pairs in 14 chromosomes)—is now being undertaken and should lead to knowledge that can produce novel approaches to the treatment and control of these two scourges of humankind. The theoretical and technical principles involved in this type of work are clearly described in Chapters 14, 15, and 18 of *Textbook of Biochemistry With Clinical Correlations*, which will ensure that readers will understand and appreciate future developments in the field.

Discoveries on the molecular basis of human disease are also being reported at an unprecedented and dizzying rate, opening wider and wider the window to many less frequent afflictions produced by mutated genes accumulating in the human gene pool. The era of molecular medicine has already arrived. Since the very first edition of *Textbook of Biochemistry With Clinical Correlations*, the correlations have been a feature that has made the book truly unique. In this new edition, the correlations are numerous, succinct, and integrated with, but also independent of, the text. They not only reflect current progress but indicate more than ever before how biochemistry, molecular biology, and human genetics have become the foundation stones of all areas of modern medicine. These previously separate disciplines have become so intimately and inextricably intertwined that little knowledge and understanding of one can occur without knowledge and understanding of others. One of the many strengths of this book is that clear examples of the convergence and integration of biological disciplines can be found in the clinical correlations.

In this fourth edition of *Textbook of Biochemistry With Clinical Correlations*, the contributors have provided an up-to-date and logical coverage of basic biochemistry, molecular biology, and normal and abnormal aspects of physiological chemistry. This material is appropriate and relevant for medical and other health science students, particularly as we approach the third millenium in the midst of amazing and pervasive progress in medical science and biotechnology. To enhance the text, a completely new series of vivid illustrations has been added, which will undoubtedly further the readers' understanding of the complexity of many of the concepts. Students of medical and health sciences should appreciate that the time and effort invested in learning the material presented here will be very well spent. This knowledge will provide the framework within which further developments will be understood and applied as the readers begin to care for the physical and mental well-being of those entrusted to them. Furthermore, the knowledge derived from this book will also provide satisfying insight into the processes that underlie human life and the amazing power of the human mind to explore and understand it. As in previous editions, the fourth edition includes many multiple choice questions (and answers) at the end of each chapter that should facilitate this learning while ensuring success in professional and other examinations.

I am happy and privileged to have watched the growth of human biochemistry (because of my teaching and research responsibilities) since my medical student days nearly half-a-century ago. It has been an amazing spectacle, full of thrills and exciting adventures into aspects of human cells that were previously shrouded in mystery and ignorance. As my knowledge has increased, so has my sense of awe and wonder at the unfolding beauty of this marvelous display of nature's secrets.

As the late Alberto Sols frequently said: "The Biochemistry of today is the Medicine of tomorrow." *Textbook of Biochemistry With Clinical Correlations* illustrates the veracity of this insight.

FRANK VELLA
UNIVERSITY OF SASKATCHEWAN

Preface

The purposes of the fourth edition of the *Textbook of Biochemistry With Clinical Correlations* remain unchanged from the earlier editions: to present a clear discussion of the biochemistry of mammalian cells; to relate the biochemical events at the cellular level to the physiological processes occurring in the whole animal; and to cite examples of deviant biochemical processes in human disease.

The continued rapid advances in knowledge, particularly due to the techniques of molecular biology, required a critical review and evaluation of the entire content of the previous edition. Every chapter has been revised and updated. Significant additions of new material, clarifications, and some deletions were made throughout. Amino acid metabolism was combined into a single chapter and DNA structure and function was divided into two chapters for better coverage of this rapidly expanding field. Topics for inclusion were selected to cover the essential areas of both biochemistry and physiological chemistry for upper-level undergraduate, graduate-level and especially professional school courses in biochemistry. Since the application of biochemistry is so important to human medicine, the text has an overriding emphasis on the biochemistry of mammalian cells.

The textbook is written such that any sequence considered most appropriate by an instructor can be presented. It is not formally divided into major sections, but related topics are grouped together. After an introductory chapter on cell structure, Chapters 2 to 5 concern the **Major Structural Components of Cells**, that is, proteins and their many functions, and cell membranes and their major roles. **Metabolism** is discussed in the following eight chapters, starting with the conservation of energy, then the synthesis and degradation of the major cellular components, and concluding with a chapter on the integration of these pathways in humans. The next section of six chapters covers **Information Transfer and Its Control**, describing the structure and synthesis of the major cellular macromolecules, that is, DNA, RNA, and protein. A separate chapter on **Biotechnology** is included because information from this area has had such a significant impact on the development of our current state of biochemical knowledge. The section concludes with a chapter on the **Regulation of Gene Expression** in which mechanisms in both prokaryotes and eukaryotes are presented. The fourth major section represents **Signal Transduction and Amplification** and includes two chapters on hormones that emphasize their biochemical functions as messengers and a chapter on **Molecular Cell Biology** describes four major mammalian signal transducing systems. The textbook concludes with six chapters on topics that comprise **Physiological Chemistry**, including cytochrome P450 enzymes and xenobiotic metabolism, iron and heme metabolism, gas transport and pH regulation, digestion and absorption, and human nutrition.

A major addition from previous editions is the extensive use of color in the **illustrations** as a means to emphasize important points. All figures were reviewed and new drawings were prepared to illustrate the narrative discussion. In many cases the adage "A picture is worth a thousand words" is appropriate and the reader is encouraged to study the illustrations because they are meant to illuminate often confusing aspects of a topic.

In each chapter the relevancy of the topic to human life processes are presented in **Clinical Correlations**, which describe the aberrant biochemistry of disease states. A number of new correlations have been included. The correlations are not intended to review all of the major diseases but rather to cite examples of disease processes where the biochemical implications are well established. In addition, we specifically avoided presenting clinical case reports because it was considered more significant to deal with the general clinical condition. References are included to facilitate exploration of the topic in more detail. In some cases similar clinical problems are presented in different chapters, but each from a different perspective. All pertinent biochemical information is presented in the main text, and an understanding of the material does not require a reading of the correlations. In a few cases, clinical discussions are part of the principal text because of the close relationship of some topics to medical conditions.

Each chapter concludes with a set of **Questions and Answers**; the multiple-choice format was retained as being valuable to students for self-assessment of their knowledge. The question type was limited to the types now occurring in national examinations. All questions were reviewed and many new ones added. The questions cover a range of topics in each chapter, and each has an annotated answer, with references to the page in the textbook covering the content of the question.

The appendix, **Review of Organic Chemistry**, is designed as a ready reference for the nomenclature and structures of organic molecules encountered in biochemistry and is not intended as a comprehensive review of organic chemistry. The material is presented in the Appendix rather than at the beginning of those chapters dealing with the metabolism of each class of organic molecules. The reader might find it

valuable to become familiar with the content and then use the Appendix as a ready reference when reading related sections in the main text.

We still believe that a multicontributor textbook is the best approach to achieve an accurate and current presentation of biochemistry. Each author is involved actively in teaching biochemistry in a medical or graduate school and has an active research interest in the field in which he or she has written. Thus, each has the perspective of the classroom instructor, with the experience to select the topics and determine the emphasis required for students in a course of biochemistry. Every contributor, however, brings to the book an individual approach, leading to some differences in presentation. However, every chapter was critically edited and revised in order to have a consistent writing style and to eliminate repetitions and redundancies. A limited repetition of some topics in different chapters was permitted when it was considered that the repetition would facilitate the learning process.

The individual contributors were requested to prepare their chapters for a **teaching book**. The book is not intended as a compendium of biochemical facts or a review of the current literature, but each chapter contains sufficient detail on the subject to make it useful as a resource. Each contributor was requested not to refer to specific researchers; our apologies to those many biochemists who rightfully should be acknowledged for their outstanding research contributions to the field of biochemistry. Each chapter contains a **Bibliography** that can be used as an entry point to the research literature.

In any project one person must accept the responsibility for the final product. The decisions concerning the selection of topics and format, reviewing the drafts, and responsibility for the final checking of the book were entirely mine. I welcome comments, criticisms, and suggestions from the students, faculty, and professionals who use this textbook. It is our hope that this work will be of value to those embarking on the exciting experience of learning biochemistry for the first time and to those who are returning to a topic in which the information is expanding so rapidly.

THOMAS M. DEVLIN

Acknowledgments

Without the encouragement and participation of many people, this project would never have been accomplished. My personal and very deep appreciation goes to each of the contributors for accepting the challenge of preparing the chapters, for sharing their ideas and making recommendations to improve the book, for accepting so readily suggestions to modify their contributions, and for cooperating throughout the period of preparation. To each I extend my sincerest thanks for a job well done.

The contributors received the support of associates and students in the preparation of their chapters, and, for fear of omitting someone, it was decided not to acknowledge individuals by name. To everyone who gave time unselfishly and shared in the objective and critical evaluation of the text, we extend a sincere thank you. In addition, every contributor has been influenced by former teachers and colleagues, various reference resources, and, of course, the research literature of biochemistry; we are deeply indebted to these many sources of inspiration.

I am particularly indebted to Dr. Frank Vella, Professor of Biochemistry at the University of Saskatchewan, Canada, who assisted me in editing the text. Dr. Vella is a distinguished biochemist who has made a major personal effort to improve the teaching of biochemistry throughout the world. He read every chapter in draft form and made significant suggestions for clarifying and improving the presentation. Dr. Vella also honored me by writing the Foreword to the fourth edition of this textbook. I extend to him my deepest appreciation and thanks for his participation and friendship.

A very special thanks to two friends and colleagues who again have been of immeasurable value to me during the preparation of this edition: My gratitude goes to Dr. James Baggott, who patiently allowed me to use him as a sounding board for ideas and who unselfishly shared with me his suggestions and criticisms of the text, and to Dr. Carol Angstadt, who reviewed many of the chapters and gave me valuable suggestions. To each I extend my deepest gratitude.

I extend my sincerest appreciation and thanks to the members of the staff of the STM Division of John Wiley & Sons who participated in the preparation of this edition. Special recognition and thanks go to Dr. Brian Crawford, Vice President and General Manager of Life Sciences and Medicine, who gave his unqualified support to the preparation of the fourth edition. I am indebted to Joe Ingram, Publisher, Life Sciences, who conscientiously guided the planning of this edition. I am very indebted to Dr. Stephanie Diment, Associate Editor, for always being available to answer questions and to make valuable suggestions, and who has patiently kept me on track. She has been a constant support; thank you. My deepest appreciation is extended to John Sollami, Senior Managing Editor, who with constant good humor meticulously oversaw the production. He kept the flow of activities reasonable, listened patiently to my suggestions and concerns, and kept us on schedule. It has been a real pleasure to work with a really knowledgeable and conscientious professional and to him I extend a very special thanks. I extend to Louise Page, New Media Editor, my deepest appreciation for her skillful organization of the CD containing the figures from the textbook. Credit for the design of the book goes to Laura Ierardi, to whom I extend my appreciation. My thanks to Christina Della Bartolomea, copyeditor, and Maria Coughlin, indexer, both of whom did an excellent job. A significant improvement in this edition is the addition of many original illustrations. My most heartfelt thanks go to Dean Gonzalez, STM Illustration Manager, and Barbara Kennedy, Illustration Supervisor, at Wiley, who handled the details and flow of illustrations. A special recognition is extended to Dr. Lisa Gardner, Production Manager and Editor of Page Two, and her staff who transformed the rough drawings of the contributors into meaningful illustrations. No book is successful without the activities of a Marketing Department; special thanks are due to Reed Elfenbein, Vice President, Marketing and Sales, David Stier, Senior Marketing Manager, David Steltenkamp, Associate Marketing Manager, and their colleagues at Wiley for their new ideas and efforts.

Finally, a very special thanks to my loving, supportive, and considerate wife, Marjorie, who had the foresight to encourage me to undertake this project, who again supported me during the days of intensive work, and who again created an environment in which I could devote the many hours required for the preparation of this textbook. To her my deepest appreciation.

THOMAS M. DEVLIN

Contents in Brief

1	1
Eukaryotic Cell Structure	
2	23
Proteins I: Composition and Structure	
3	87
Proteins II: Structure-Function Relationships in Protein Families	
4	127
Enzymes: Classification, Kinetics, and Control	
5	179
Biological Membranes: Structure and Membrane Transport	
6	217
Bioenergetics and Oxidative Metabolism	
7	267
Carbohydrate Metabolism I: Major Metabolic Pathways and their Control	
8	335
Carbohydrate Metabolism II: Special Pathways	
9	361
Lipid Metabolism I: Utilization and Storage of Energy in Lipid Form	
10	395
Lipid Metabolism II: Pathways of Metabolism of Special Lipids	
11	445
Amino Acid Metabolism	
12	489
Purine and Pyrimidine Nucleotide Metabolism	
13	525
Metabolic Interrelationships	
14	563
DNA I: Structure and Conformation	
15	621
DNA II: Repair, Synthesis, and Recombination	
16	677
RNA: Structure, Transcription, and Processing	
17	713
Protein Synthesis: Translation and Posttranslational Modifications	
18	757
Recombinant DNA and Biotechnology	
19	799
Regulation of Gene Expression	
20	839
Biochemistry of Hormones I: Polypeptide Hormones	
21	893
Biochemistry of Hormones II: Steroid Hormones	
22	919
Molecular Cell Biology	
23	981
Biotransformations: The Cytochromes P450	
24	1001
Iron and Heme Metabolism	
25	1025
Gas Transport and pH Regulation	
26	1055
Digestion and Absorption of Basic Nutritional Constituents	
27	1087
Principles of Nutrition I: Macronutrients	
28	1107
Principles of Nutrition II: Micronutrients	
Appendix	1137
Review of Organic Chemistry	
Index	1149

Contents

1	1
Eukaryotic Cell Structure	
<i>Thomas M. Devlin</i>	
1.1 Overview: Cells and Cellular Compartments	2
1.2 Cellular Environment: Water and Solutes	4
1.3 Organization and Composition of Eukaryotic Cells	12
1.4 Functional Role of Subcellular Organelles and Membrane Systems	15
Clinical Correlations	
1.1 Blood Bicarbonate Concentration in Metabolic Acidosis	12
1.2 Mitochondrial Diseases: Luft's Disease	16
1.3 Lysosomal Enzymes and Gout	18
1.4 Lysosomal Acid Lipase Deficiency	19
1.5 Zellweger Syndrome and the Absence of Functional Peroxisomes	20
2	23
Proteins I: Composition and Structure	
<i>Richard M. Schultz and Michael N. Liebman</i>	
2.1 Functional Roles of Proteins in Humans	24
2.2 Amino Acid Composition of Proteins	25
2.3 Charge and Chemical Properties of Amino Acids and Proteins	30
2.4 Primary Structure of Proteins	39
2.5 Higher Levels of Protein Organization	42
2.6 Other Types of Proteins	49
2.7 Folding of Proteins from Randomized to Unique Structures: Protein Stability	62
2.8 Dynamic Aspects of Protein Structure	68
2.9 Methods for Characterization, Purification, and Study of Protein Structure and Organization	69
Clinical Correlations	
2.1 Plasma Proteins in Diagnosis of Disease	37
2.2 Differences in Primary Structure of Insulins Used in Treatment of Diabetes Mellitus	41
2.3 A Nonconservative Mutation Occurs in Sickle Cell Anemia	42
2.4 Symptoms of Diseases of Abnormal Collagen Synthesis	50
2.5 Hyperlipidemias	56
2.6 Hypolipoproteinemias	59
2.7 Glycosylated Hemoglobin, HbA _{1c}	62
2.8 Use of Amino Acid Analysis in Diagnosis of Disease	74
3	87
Proteins II: Structure-Function Relationships in Protein Families	
<i>Richard M. Schultz and Michael N. Liebman</i>	
3.1 Overview	88
3.2 Antibody Molecules: The Immunoglobulin Superfamily	88
3.3 Proteins with a Common Catalytic Mechanism: Serine Proteases	97
3.4 DNA-Binding Proteins	108
3.5 Hemoglobin and Myoglobin	114
Clinical Correlations	
3.1 The Complement Proteins	91
3.2 Functions of Different Antibody Classes	92
3.3 Immunization	92
3.4 Fibrin Formation in a Myocardial Infarct and the Action of Recombinant Tissue Plasminogen Activator (rt-PA)	98
3.5 Involvement of Serine Proteases in Tumor Cell Metastasis	99
4	127
Enzymes: Classification, Kinetics and Control	
<i>J. Lyndal York</i>	
4.1 General Concepts	128
4.2 Classification of Enzymes	129
4.3 Kinetics	133
4.4 Coenzymes: Structure and Function	142
4.5 Inhibition of Enzymes	147
4.6 Allosteric Control of Enzyme Activity	151
4.7 Enzyme Specificity: The Active Site	155
4.8 Mechanism of Catalysis	159
4.9 Clinical Applications of Enzymes	166
4.10 Regulation of Enzyme Activity	174
Clinical Correlations	
4.1 A Case of Gout Demonstrates Two Phases in the Mechanism of Enzyme Action	138

4.2 The Physiological Effect of Changes in Enzyme K_m Values	139
4.3 Mutation of a Coenzyme-Binding Site Results in Clinical Disease	142
4.4 A Case of Gout Demonstrates the Difference between an Allosteric and Substrate-Binding Site	152
4.5 Thermal Lability of Glucose-6-Phosphate Dehydrogenase Results in Hemolytic Anemia	166
4.6 Alcohol Dehydrogenase Isoenzymes with Different pH Optima	167
4.7 Identification and Treatment of an Enzyme Deficiency	169
4.8 Ambiguity in the Assay of Mutated Enzymes	169
5	179
Biological Membranes: Structure and Membrane Transport	
<i>Thomas M. Devlin</i>	
5.1 Overview	180
5.2 Chemical Composition of Membranes	180
5.3 Micelles and Liposomes	187
5.4 Structure of Biological Membranes	189
5.5 Movement of Molecules through Membranes	196
5.6 Channels and Pores	201
5.7 Passive Mediated Transport Systems	204
5.8 Active Mediated Transport Systems	206
5.9 Ionophores	211
Clinical Correlations	
5.1 Liposomes As Carriers of Drugs and Enzymes	189
5.2 Abnormalities of Cell Membrane Fluidity in Disease States	195
5.3 Cystic Fibrosis and the Cl^- Channel	202
5.4 Diseases Due to Loss of Membrane Transport Systems	212
6	217
Bioenergetics and Oxidative Metabolism	
<i>Merle S. Olson</i>	
6.1 Energy-Producing and Energy-Utilizing Systems	218
6.2 Thermodynamic Relationships and Energy-Rich Components	220
6.3 Sources and Fates of Acetyl Coenzyme A	226
6.4 The Tricarboxylic Acid Cycle	231
6.5 Structure and Compartmentation by Mitochondrial Membranes	238
6.6 Electron Transfer	246
6.7 Oxidative Phosphorylation	261
Clinical Correlations	
6.1 Pyruvate Dehydrogenase Deficiency	233
6.2 Fumarase Deficiency	237
6.3 Mitochondrial Myopathies	247
6.4 Subacute Necrotizing Encephalomyelopathy	258
6.5 Cyanide Poisoning	259
6.6 Hypoxic Injury	261
7	267
Carbohydrate Metabolism I: Major Metabolic Pathways and their Control	
<i>Robert A. Harris</i>	
7.1 Overview	268
7.2 Glycolysis	269
7.3 The Glycolytic Pathway	272
7.4 Regulation of the Glycolytic Pathway	283
7.5 Gluconeogenesis	299
7.6 Glycogenolysis and Glycogenesis	312
Clinical Correlations	
7.1 Alcohol and Barbiturates	281
7.2 Arsenic Poisoning	283
7.3 Fructose Intolerance	285
7.4 Diabetes Mellitus	287
7.5 Lactic Acidosis	291
7.6 Pickled Pigs and Malignant Hyperthermia	291
7.7 Angina Pectoris and Myocardial Infarction	292
7.8 Pyruvate Kinase Deficiency and Hemolytic Anemia	299
7.9 Hypoglycemia and Premature Infants	300
7.10 Hypoglycemia and Alcohol Intoxication	312
7.11 Glycogen Storage Diseases	317
8	335
Carbohydrate Metabolism II: Special Pathways	
<i>Nancy B. Schwartz</i>	
8.1 Overview	336
8.2 Pentose Phosphate Pathway	336
8.3 Sugar Interconversions and Nucleotide Sugar Formation	341
8.4 Biosynthesis of Complex Carbohydrates	346
8.5 Glycoproteins	348
8.6 Proteoglycans	351
Clinical Correlations	
8.1 Glucose 6-Phosphate Dehydrogenase: Genetic Deficiency or Presence of Genetic Variants in Erythrocytes	338
8.2 Essential Fructosuria and Fructose Intolerance: Deficiency of Fructokinase and Fructose 1-Phosphate Aldolase	342
8.3 Galactosemia: Inability to Transform Galactose into Glucose	343
8.4 Pentosuria: Deficiency of Xylitol Dehydrogenase	345
8.5 Glucuronic Acid: Physiological Significance of Glucuronide Formation	346
8.6 Blood Group Substances	348
8.7 Aspartylglycosylaminuria: Absence of 4-L-Aspartylglycosamine Amidohydrolase	349
8.8 Heparin Is an Anticoagulant	350
8.9 Mucopolysaccharidoses	352

9	361
Lipid Metabolism I: Utilization and Storage of Energy in Lipid Form	
<i>J. Denis McGarry</i>	
9.1 Overview	362
9.2 Chemical Nature of Fatty Acids and Acylglycerols	363
9.3 Sources of Fatty Acids	365
9.4 Storage of Fatty Acids As Triacylglycerols	375
9.5 Methods of Interorgan Transport of Fatty Acids and their Primary Products	378
9.6 Utilization of Fatty Acids for Energy Production	381
Clinical Correlations	
9.1 Obesity	378
9.2 Leptin and Obesity	378
9.3 Genetic Abnormalities in Lipid-Energy Transport	380
9.4 Genetic Deficiencies in Carnitine Transport or Carnitine Palmitoyltransferase	384
9.5 Genetic Deficiencies in the Acyl-CoA Dehydrogenases	385
9.6 Refsum's Disease	387
9.7 Diabetic Ketoacidosis	390
10	395
Lipid Metabolism II: Pathways of Metabolism of Special Lipids	
<i>Robert H. Glew</i>	
10.1 Overview	396
10.2 Phospholipids	397
10.3 Cholesterol	409
10.4 Sphingolipids	420
10.5 Prostaglandins and Thromboxanes	431
10.6 Lipoxygenase and Oxy-Eicosatetraenoic Acids	436
Clinical Correlations	
10.1 Respiratory Distress Syndrome	400
10.2 Treatment of Hypercholesterolemia	416
10.3 Atherosclerosis	417
10.4 Diagnosis of Gaucher's Disease in an Adult	430
11	445
Amino Acid Metabolism	
<i>Marguerite W. Coomes</i>	
11.1 Overview	446
11.2 Incorporation of Nitrogen into Amino Acids	447
11.3 Transport of Nitrogen to Liver and Kidney	452
11.4 Urea Cycle	453
11.5 Synthesis and Degradation of Individual Amino Acids	456
Clinical Correlations	
11.1 Carbamoyl Phosphate Synthetase and N-Acetylglutamate Synthetase Deficiencies	456
11.2 Deficiencies of Urea Cycle Enzymes	457
11.3 Nonketotic Hyperglycinemia	461
11.4 Folic Acid Deficiency	463
11.5 Phenylketonuria	465
11.6 Disorders of Tyrosine Metabolism	467
11.7 Parkinson's Disease	467
11.8 Hyperhomocysteinemia and Atherogenesis	471
11.9 Other Diseases of Sulfur Amino Acids	471
11.10 Diseases of Metabolism of Branched-Chain Amino Acids	479
11.11 Diseases of Propionate and Methylmalonate Metabolism	480
11.12 Diseases Involving Lysine and Ornithine	481
11.13 Histidinemia	482
11.14 Diseases of Folate Metabolism	483
12	489
Purine and Pyrimidine Nucleotide Metabolism	
<i>Joseph G. Cory</i>	
12.1 Overview	490
12.2 Metabolic Functions of Nucleotides	490
12.3 Chemistry of Nucleotides	492
12.4 Metabolism of Purine Nucleotides	493
12.5 Metabolism of Pyrimidine Nucleotides	503
12.6 Deoxyribonucleotide Formation	507
12.7 Nucleoside and Nucleotide Kinases	511
12.8 Nucleotide-Metabolizing Enzymes As a Function of the Cell Cycle and Rate of Cell Division	511
12.9 Nucleotide Coenzyme Synthesis	514
12.10 Synthesis and Utilization of 5-Phosphoribosyl-1-Pyrophosphate	516
12.11 Compounds that Interfere with Cellular Purine and Pyrimidine Nucleotide Metabolism: Chemotherapeutic Agents	517
Clinical Correlations	
12.1 Gout	498
12.2 Lesch-Nyhan Syndrome	499
12.3 Immunodeficiency Diseases Associated with Defects in Purine Nucleoside Degradation	503
12.4 Hereditary Orotic Aciduria	505
13	525
Metabolic Interrelationships	
<i>Robert A. Harris and David W. Crabb</i>	
13.1 Overview	526
13.2 Starve-Feed Cycle	528
13.3 Mechanisms Involved in Switching the Metabolism of Liver between the Well-Fed State and the Starved State	539
13.4 Metabolic Interrelationships of Tissues in Various Nutritional and Hormonal States	547

Clinical Correlations	
13.1 Obesity	526
13.2 Protein Malnutrition	527
13.3 Starvation	527
13.4 Reye's Syndrome	533
13.5 Hyperglycemic, Hyperosmolar Coma	537
13.6 Hyperglycemia and Protein Glycation	538
13.7 Noninsulin-Dependent Diabetes Mellitus	549
13.8 Insulin-Dependent Diabetes Mellitus	550
13.9 Complications of Diabetes and the Polyol Pathway	551
13.10 Cancer Cachexia	553
14	563
DNA I: Structure and Conformation	
<i>Stelios Aktipis</i>	
14.1 Overview	564
14.2 Structure of DNA	565
14.3 Types of DNA Structure	584
14.4 DNA Structure and Function	609
Clinical Correlations	
14.1 DNA Vaccines	565
14.2 Diagnostic Use of Probes in Medicine	583
14.3 Topoisomerases in Treatment of Cancer	594
14.4 Hereditary Persistence of Fetal Hemoglobin	600
14.5 Therapeutic Potential of Triplex DNA Formation	600
14.6 Expansion of DNA Triple Repeats and Human Disease	602
14.7 Mutations of Mitochondrial DNA: Aging and Degenerative Diseases	617
15	621
DNA II: Repair, Synthesis, and Recombination	
<i>Stelios Aktipis</i>	
15.1 Overview	622
15.2 Formation of the Phosphodiester Bond <i>in Vivo</i>	622
15.3 Mutation and Repair of DNA	627
15.4 DNA Replication	642
15.5 DNA Recombination	661
15.6 Sequencing of Nucleotides in DNA	671
Clinical Correlations	
15.1 Mutations and the Etiology of Cancer	633
15.2 Defects in Nucleotide Excision Repair and Hereditary Diseases	638
15.3 DNA Ligase Activity and Bloom Syndrome	639
15.4 DNA Repair and Chemotherapy	639
15.5 Mismatch DNA Repair and Cancer	641
15.6 Telomerase Activity in Cancer and Aging	658
15.7 Inhibitors of Reverse Transcriptase in Treatment of AIDS	661
15.8 Immunoglobulin Genes Are Assembled by Recombination	663
15.9 Transposons and Development of Antibiotic Resistance	670
15.10 DNA Amplification and Development of Drug Resistance	671
15.11 Nucleotide Sequence of the Human Genome	672
16	677
RNA: Structure, Transcription, and Processing	
<i>Francis J. Schmidt</i>	
16.1 Overview	678
16.2 Structure of RNA	679
16.3 Types of RNA	681
16.4 Mechanisms of Transcription	689
16.5 Posttranscriptional Processing	699
16.6 Nucleases and RNA Turnover	708
Clinical Correlations	
16.1 Staphylococcal Resistance to Erythromycin	683
16.2 Antibiotics and Toxins that Target RNA Polymerase	692
16.3 Fragile X Syndrome: A Chromatin Disease?	697
16.4 Involvement of Transcriptional Factors in Carcinogenesis	701
16.5 Thalassemia Due to Defects in Messenger RNA Synthesis	705
16.6 Autoimmunity in Connective Tissue Disease	706
17	713
Protein Synthesis: Translation and Posttranslational Modifications	
<i>Dohn Glitz</i>	
17.1 Overview	714
17.2 Components of the Translational Apparatus	714
17.3 Protein Biosynthesis	724
17.4 Protein Maturation: Modification, Secretion, and Targeting	735
17.5 Organelle Targeting and Biogenesis	739
17.6 Further Posttranslational Protein Modifications	743
17.7 Regulation of Translation	748
17.8 Protein Degradation and Turnover	750
Clinical Correlations	
17.1 Missense Mutation: Hemoglobin	721
17.2 Disorders of Terminator Codons	722
17.3 Thalassemia	722
17.4 Mutation in Mitochondrial Ribosomal RNA Results in Antibiotic-Induced Deafness	734
17.5 I-Cell Disease	740
17.6 Familial Hyperproinsulinemia	743
17.7 Absence of Posttranslational Modification: Multiple Sulfatase Deficiency	746
17.8 Defects in Collagen Synthesis	749

17.9 Deletion of a Codon, Incorrect Posttranslational Modification, and Premature Protein Degradation: Cystic Fibrosis	752
18 Recombinant DNA and Biotechnology <i>Gerald Soslau</i>	757
18.1 Overview	758
18.2 Polymerase Chain Reaction	759
18.3 Restriction Endonuclease and Restriction Maps	760
18.4 DNA Sequencing	762
18.5 Recombinant DNA and Cloning	765
18.6 Selection of Specific Cloned DNA in Libraries	770
18.7 Techniques for Detection and Identification of Nucleic Acids	773
18.8 Complementary DNA and Complementary DNA Libraries	777
18.9 Bacteriophage, Cosmid, and Yeast Cloning Vectors	778
18.10 Techniques to further Analyze Long Stretches of DNA	781
18.11 Expression Vectors and Fusion Proteins	783
18.12 Expression Vectors in Eukaryotic Cells	784
18.13 Site-Directed Mutagenesis	786
18.14 Applications of Recombinant DNA Technologies	790
18.15 Concluding Remarks	795
Clinical Correlations	
18.1 Polymerase Chain Reaction and Screening for Human Immunodeficiency Virus	760
18.2 Restriction Mapping and Evolution	762
18.3 Direct Sequencing of DNA for Diagnosis of Genetic Disorders	766
18.4 Multiplex PCR Analysis of HGPRTase Gene Defects in Lesch–Nyhan Syndrome	770
18.5 Restriction Fragment Length Polymorphisms Determine the Clonal Origin of Tumors	776
18.6 Site-Directed Mutagenesis of HSV I gD	789
18.7 Normal Genes Can Be Introduced into Cells with Defective Genes in Gene Therapy	793
18.8 Transgenic Animal Models	795
19 Regulation of Gene Expression <i>John E. Donelson</i>	799
19.1 Overview	800
19.2 Unit of Transcription in Bacteria: The Operon	800
19.3 Lactose Operon of <i>E. Coli</i>	802
19.4 Tryptophan Operon of <i>E. Coli</i>	807
19.5 Other Bacterial Operons	813
19.6 Bacterial Transposons	816
19.7 Inversion of Genes in <i>Salmonella</i>	818
19.8 Organization of Genes in Mammalian DNA	820
19.9 Repetitive DNA Sequences in Eukaryotes	822
19.10 Genes for Globin Proteins	824
19.11 Genes for Human Growth Hormone-Like Proteins	829
19.12 Mitochondrial Genes	830
19.13 Bacterial Expression of Foreign Genes	832
19.14 Introduction of Rat Growth Hormone Gene into Mice	835
Clinical Correlations	
19.1 Transmissible Multiple Drug Resistances	816
19.2 Duchenne/Becker Muscular Dystrophy and the Dystrophin Gene	822
19.3 Huntington's Disease and Trinucleotide Repeat Expansions	823
19.4 Prenatal Diagnosis of Sickle Cell Anemia	828
19.5 Prenatal Diagnosis of Thalassemia	829
19.6 Leber's Hereditary Optic Neuropathy (LHON)	831
20 Biochemistry of Hormones I: Polypeptide Hormones <i>Gerald Litwack and Thomas J. Schmidt</i>	839
20.1 Overview	840
20.2 Hormones and the Hormonal Cascade System	841
20.3 Major Polypeptide Hormones and their Actions	846
20.4 Genes and Formation of Polypeptide Hormones	849
20.5 Synthesis of Amino Acid-Derived Hormones	853
20.6 Inactivation and Degradation of Hormones	857
20.7 Cell Regulation and Hormone Secretion	859
20.8 Cyclic Hormonal Cascade Systems	866
20.9 Hormone–Receptor Interactions	871
20.10 Structure of Receptors: β -Adrenergic Receptor	875
20.11 Internalization of Receptors	876
20.12 Intracellular Action: Protein Kinases	878
20.13 Oncogenes and Receptor Functions	888
Clinical Correlations	
20.1 Testing Activity of the Anterior Pituitary	844
20.2 Hypopituitarism	846
20.3 Lithium Treatment of Manic–Depressive Illness: The Phosphatidylinositol Cycle	863
21 Biochemistry of Hormones II: Steroid Hormones <i>Gerald Litwack and Thomas J. Schmidt</i>	893
21.1 Overview	894
21.2 Structures of Steroid Hormones	894
21.3 Biosynthesis of Steroid Hormones	896
21.4 Metabolic Inactivation of Steroid Hormones	901
21.5 Cell–Cell Communication and Control of Synthesis and Release of Steroid Hormones	901

21.6 Transport of Steroid Hormones in Blood	908
21.7 Steroid Hormone Receptors	909
21.8 Receptor Activation: Upregulation and Downregulation	914
21.9 A Specific Example of Steroid Hormone Action at Cell Level: Programmed Death	915
Clinical Correlations	
21.1 Oral Contraception	907
21.2 Apparent Mineralocorticoid Excess Syndrome	911
21.3 Programmed Cell Death in the Ovarian Cycle	916
22	919
Molecular Cell Biology	
<i>Thomas E. Smith</i>	
22.1 Overview	920
22.2 Nervous Tissue: Metabolism and Function	920
22.3 The Eye: Metabolism and Vision	932
22.4 Muscle Contraction	946
22.5 Mechanism of Blood Coagulation	960
Clinical Correlations	
22.1 Lambert–Eaton Myasthenic Syndrome	927
22.2 Myasthenia Gravis: A Neuromuscular Disorder	929
22.3 Macula Degeneration: Other Causes of Vision Loss	936
22.4 Niemann–Pick Disease and Retinitis Pigmentosa	938
22.5 Retinitis Pigmentosa Resulting from a De Novo Mutation in the Gene Coding for Peripherin	940
22.6 Abnormalities in Color Perception	946
22.7 Troponin Subunits As Markers for Myocardial Infarction	954
22.8 Voltage-Gated Ion Channelopathies	956
22.9 Intrinsic Pathway Defects: Prekallikrein Deficiency	963
22.10 Classic Hemophilia	969
22.11 Thrombosis and Defects of the Protein C Pathway	971
23	981
Biotransformations: The Cytochromes P450	
<i>Richard T. Okita and Bettie Sue Siler Masters</i>	
23.1 Overview	982
23.2 Cytochromes P450: Nomenclature and Overall Reaction	982
23.3 Cytochromes P450: Multiple Forms	984
23.4 Inhibitors of Cytochromes P450	986
23.5 Cytochrome P450 Electron Transport Systems	987
23.6 Physiological Functions of Cytochromes P450	989
23.7 Other Hemoprotein- and Flavoprotein-Mediated Oxygenations: The Nitric Oxide Synthases	995
Clinical Correlations	
23.1 Consequences of Induction of Drug-Metabolizing Enzymes	986
23.2 Genetic Polymorphisms of Drug-Metabolizing Enzymes	987
23.3 Deficiency of Cytochrome P450 Steroid 21-Hydroxylase (CYP21A2)	992
23.4 Steroid Hormone Production during Pregnancy	993
23.5 Clinical Aspects of Nitric Oxide Production	996
24	1001
Iron and Heme Metabolism	
<i>William M. Awad, Jr.</i>	
24.1 Iron Metabolism: Overview	1002
24.2 Iron-Containing Proteins	1003
24.3 Intestinal Absorption of Iron	1005
24.4 Molecular Regulation of Iron Utilization	1006
24.5 Iron Distribution and Kinetics	1007
24.6 Heme Biosynthesis	1009
24.7 Heme Catabolism	1017
Clinical Correlations	
24.1 Iron Overload and Infection	1003
24.2 Duodenal Iron Absorption	1005
24.3 Mutant Iron-Responsive Element	1007
24.4 Ceruloplasmin Deficiency	1008
24.5 Iron-Deficiency Anemia	1009
24.6 Hemochromatosis: Molecular Genetics and the Issue of Iron-Fortified Diets	1011
24.7 Acute Intermittent Porphyria	1013
24.8 Neonatal Isoimmune Hemolysis	1020
24.9 Bilirubin UDP-Glucuronosyltransferase Deficiency	1020
24.10 Elevation of Serum Conjugated Bilirubin	1021
25	1025
Gas Transport and pH Regulation	
<i>James Baggott</i>	
25.1 Introduction to Gas Transport	1026
25.2 Need for a Carrier of Oxygen in Blood	1026
25.3 Hemoglobin and Allosterism: Effect of 2,3-Bisphosphoglycerate	1029
25.4 Other Hemoglobins	1030
25.5 Physical Factors that Affect Oxygen Binding	1031
25.6 Carbon Dioxide Transport	1031
25.7 Interrelationships among Hemoglobin, Oxygen, Carbon Dioxide, Hydrogen Ion, and 2,3-Bisphosphoglycerate	1036
25.8 Introduction to pH Regulation	1036
25.9 Buffer Systems of Plasma, Interstitial Fluid, and Cells	1036
25.10 The Carbon Dioxide–Bicarbonate Buffer System	1038
25.11 Acid–Base Balance and its Maintenance	1041
25.12 Compensatory Mechanisms	1046
25.13 Alternative Measures of Acid–Base Imbalance	1049
25.14 The Significance of Na ⁺ and Cl [−] in Acid–Base Imbalance	1050
Clinical Correlations	
25.1 Diaspirin Hemoglobin	1026
25.2 Cyanosis	1028

25.3 Chemically Modified Hemoglobins: Methemoglobin and Sulfhemoglobin	1030
25.4 Hemoglobins with Abnormal Oxygen Affinity	1032
25.5 The Case of the Variable Constant	1039
25.6 The Role of Bone in Acid–Base Homeostasis	1042
25.7 Acute Respiratory Alkalosis	1047
25.8 Chronic Respiratory Acidosis	1048
25.9 Salicylate Poisoning	1049
25.10 Evaluation of Clinical Acid–Base Data	1051
25.11 Metabolic Alkalosis	1052
26 Digestion and Absorption of Basic Nutritional Constituents <i>Ulrich Hopfer</i>	1055
26.1 Overview	1056
26.2 Digestion: General Considerations	1059
26.3 Epithelial Transport	1063
26.4 Digestion and Absorption of Proteins	1070
26.5 Digestion and Absorption of Carbohydrates	1073
26.6 Digestion and Absorption of Lipids	1077
26.7 Bile Acid Metabolism	1083
Clinical Correlations	
26.1 Cystic Fibrosis	1067
26.2 Bacterial Toxigenic Diarrheas and Electrolyte Replacement Therapy	1068
26.3 Neutral Amino Aciduria (Hartnup Disease)	1073
26.4 Disaccharidase Deficiency	1075
26.5 Cholesterol Stones	1081
26.6 A- β -Lipoproteinemia	1082
27 Principles of Nutrition I: Macronutrients <i>Stephen G. Chaney</i>	1087
27.1 Overview	1088
27.2 Energy Metabolism	1088
27.3 Protein Metabolism	1089
27.4 Protein–Energy Malnutrition	1093
27.5 Excess Protein–Energy Intake	1094
27.6 Carbohydrates	1095
27.7 Fats	1097
27.8 Fiber	1097
27.9 Composition of Macronutrients in the Diet	1098
Clinical Correlations	
27.1 Vegetarian Diets and Protein–Energy Requirements	1091
27.2 Low-Protein Diets and Renal Disease	1092
27.3 Providing Adequate Protein and Calories for the Hospitalized Patient	1093
27.4 Carbohydrate Loading and Athletic Endurance	1096
27.5 High-Carbohydrate Versus High-Fat Diets for Diabetics	1096
27.6 Polyunsaturated Fatty Acids and Risk Factors for Heart Disease	1099
27.7 Metabolic Adaptation: The Relationship between Carbohydrate Intake and Serum Triacylglycerols	1100
28 Principles of Nutrition II: Micronutrients <i>Stephen G. Chaney</i>	1107
28.1 Overview	1108
28.2 Assessment of Malnutrition	1108
28.3 Recommended Dietary Allowances	1109
28.4 Fat-Soluble Vitamins	1109
28.5 Water-Soluble Vitamins	1118
28.6 Energy-Releasing Water-Soluble Vitamins	1119
28.7 Hematopoietic Water-Soluble Vitamins	1123
28.8 Other Water-Soluble Vitamins	1127
28.9 Macrominerals	1128
28.10 Trace Minerals	1130
28.11 The American Diet: Fact and Fallacy	1132
28.12 Assessment of Nutritional Status in Clinical Practice	1133
Clinical Correlations	
28.1 Nutritional Considerations for Cystic Fibrosis	1112
28.2 Renal Osteodystrophy	1113
28.3 Nutritional Considerations in the Newborn	1117
28.4 Anticonvulsant Drugs and Vitamin Requirements	1118
28.5 Nutritional Considerations in the Alcoholic	1120
28.6 Vitamin B ₆ Requirements for Users of Oral Contraceptives	1124
28.7 Diet and Osteoporosis	1129
28.8 Nutritional Considerations for Vegetarians	1134
28.9 Nutritional Needs of Elderly Persons	1134
Appendix Review of Organic Chemistry <i>Carol N. Angstadt</i>	1137
Index	1149

Chapter Questions and Answers

The questions at the end of each chapter are provided to help you test your knowledge and increase your understanding of biochemistry. Since they are intended to help you strengthen your knowledge, their construction does not always conform to principles for assessing your retention of individual facts. Specifically, you will sometimes be expected to draw on your knowledge of several areas to answer a single question, and some questions may take longer to analyze than the average time allowed on certain national examinations. Occasionally, you may disagree with the answer. If this occurs, we hope that after you read the commentary that accompanies the answer to the question, you will see the point and your insight into the biochemical problem will be increased.

The question types conform to those currently used in objective examinations. They are:

Type 1: Choose the one best answer

Type 2: Match the numbered statement or phrase with one of the lettered options given above.

Chapter 1— Eukaryotic Cell Structure

Thomas M. Devlin

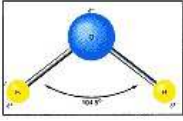

1.1 Overview: Cells and Cellular Compartments	2
1.2 Cellular Environment: Water and Solutes	4
Hydrogen Bonds Form between Water Molecules	4
Water Has Unique Solvent Properties	5
Some Molecules Dissociate with Formation of Cations and Anions	5
Weak Electrolytes Dissociate Partially	6
Water Is a Weak Electrolyte	6
Many Biologically Important Molecules Are Acids or Bases	7
The Henderson–Hasselbalch Equation Defines the Relationship between pH and Concentrations of Conjugate Acid and Base	9
Buffering Is Important to Control pH	10
1.3 Organization and Composition of Eukaryotic Cells	12
Chemical Composition of Cells	13
1.4 Functional Role of Subcellular Organelles and Membrane Systems	15
Plasma Membrane Is the Limiting Boundary of a Cell	16
Nucleus Is Site of DNA and RNA Synthesis	16
Endoplasmic Reticulum Has a Role in Many Synthetic Pathways	16
The Golgi Apparatus Is Involved in Sequestering of Proteins	17
Mitochondria Supply Most Cell Needs for ATP	17
Lysosomes Are Required for Intracellular Digestion	17
Peroxisomes Contain Oxidative Enzymes Involving Hydrogen Peroxide	19
Cytoskeleton Organizes the Intracellular Contents	19
Cytosol Contains Soluble Cellular Components	20
Conclusion	20
Bibliography	20
Questions and Answers	21
Clinical Correlations	
1.1 Blood Bicarbonate Concentration in Metabolic Acidosis	12
1.2 Mitochondrial Diseases: Luft's Disease	16
1.3 Lysosomal Enzymes and Gout	18
1.4 Lysosomal Acid Lipase Deficiency	19
1.5 Zellweger Syndrome and the Absence of Functional Peroxisomes	20

1.1—

Overview:

Cells and Cellular Compartments

Over three billion years ago, under conditions not entirely clear and in a time span difficult to comprehend, elements such as carbon, hydrogen, oxygen, nitrogen, sulfur, and phosphorus formed simple chemical compounds. They combined, dispersed, and recombined to form a variety of larger molecules until a combination was achieved that was capable of replicating itself. These macromolecules consisted of simpler molecules linked together by chemical bonds. With continued evolution and formation of ever more complex molecules, the water environment around some of these self-replicating molecules became enclosed by a membrane. This development gave these primordial structures the ability to control their own environment to some extent. A form of life had evolved and a unit of three-dimensional space—a cell—had been established. With the passing of time a diversity of cells evolved, and their chemistry and structure became more complex. They could extract nutrients from the environment, chemically converting these nutrients to sources of energy or to complex molecules, control chemical processes that they catalyzed, and carry out cellular replication. Thus the vast diversity of life observed today began. The cell is the basic unit of life in all forms of living organisms, from the smallest bacterium to the most complex animal.

The limiting outer membrane of cells, the **plasma membrane**, delineates the space occupied by a cell and separates the variable and potentially hostile environment outside from the relatively constant milieu within. It is the communication link between the cell and its surroundings.

On the basis of microscopic and biochemical differences, living cells are divided into two major classes: **prokaryotes**, which include bacteria, blue-green algae, and rickettsiae, and **eukaryotes**, which include yeasts, fungi, and plant and animal cells. Prokaryotes have a variety of shapes and sizes, in most cases being 1/1000 to 1/10,000 the size of eukaryotic cells. They lack intracellular membrane-bound structures that can be visualized by a microscope (Figure 1.1). The deoxyribonucleic acid (DNA) of prokaryotes is often segregated into a discrete mass, the nucleoid region, that is not surrounded by a membrane or envelope. The plasma membrane is often invaginated. In contrast, eukaryotic cells have a well-defined membrane surrounding a central nucleus and a variety of intracellular structures and organelles (Figure 1.1*b*). Intracellular membrane systems establish distinct subcellular compartments, as described in Section 1.4, that permit a unique degree of subcellular specialization. By compartmentalization different chemical reactions that require different environments can occur simultaneously. Many reactions occur in or on specific membranes, thus creating an additional environment for the diverse functions of cells.

Besides these structural variations between prokaryotic and eukaryotic cells (Figures 1*a* and 1*b*), there are differences in chemical composition and biochemical activities. Prokaryotes lack histones, a class of proteins that complex with DNA in eukaryotes. There are major structural differences in the ribonucleic acid–protein complexes involved in biosynthesis of proteins between the cell types, as well as differences in transport mechanisms across the plasma membrane and in enzyme content. The many similarities, however, are equally striking. The emphasis throughout this book is on the chemistry of eukaryotes, particularly mammalian cells, but much of our knowledge of the biochemistry of living cells has come from studies of prokaryotic and nonmammalian eukaryotic cells. The basic chemical components and fundamental chemical reactions of all living cells are very similar. Availability of certain cell populations, for example, bacteria in contrast to human liver, has led to much of our knowledge about some cells; in some areas our knowledge is derived nearly exclusively from studies of prokaryotes. The universality of many biochemical phenomena, however, permits many extrapolations from bacteria to humans.

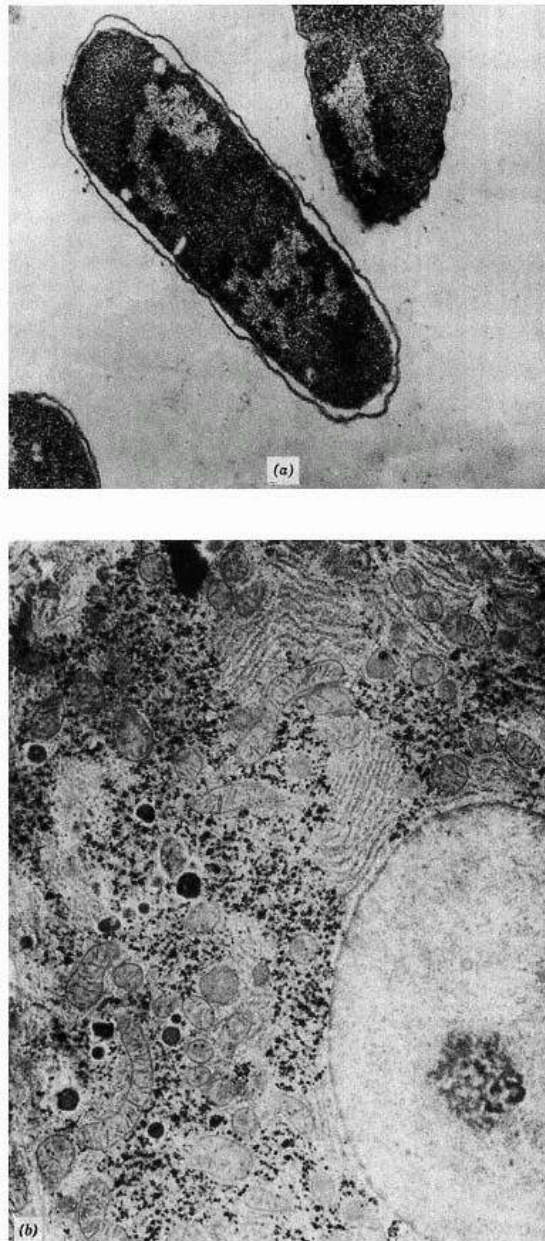

Figure 1.1

Cellular organization of prokaryotic and eukaryotic cells.

- (a) Electron micrograph of *Escherichia coli*, a representative prokaryote; approximate magnification $\times 30,000$. There is little apparent intracellular organization and no cytoplasmic organelles. Chromatin is condensed in a nuclear zone but not surrounded by a membrane. Prokaryotic cells are much smaller than eukaryotic cells.
- (b) Electron micrograph of a thin section of a liver cell (rat hepatocyte), a representative eukaryotic cell; approximate magnification $\times 7500$. Note the distinct nuclear membrane, different membrane-bound organelles or vesicles, and extensive membrane systems. Various membranes create a variety of intracellular compartments.
- Photograph (a) generously supplied by Dr. M. E. Bayer, Fox Chase Cancer Institute, Philadelphia, PA; photograph (b) reprinted with permission of Dr. K. R. Porter, from Porter, K. R., and Bonneville, M. A. In: *Fine Structure of Cells and Tissues*. Philadelphia: Lea & Febiger, 1972.

Before we dissect the complexities of mammalian cells and tissues in the following chapters, it is appropriate to review some of the chemical and physical characteristics of the environment in which the various biochemical phenomena occur. This environment places many constraints on the cell's activities. The concluding section outlines the activities and roles of subcellular compartments.

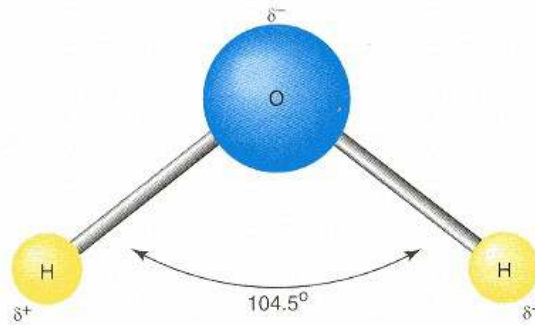

Figure 1.2
Structure of a water molecule.
The H–O–H bond angle is 104.5°. Both hydrogen atoms carry a partial positive charge and the oxygen a partial negative charge, creating a dipole.

1.2— Cellular Environment: Water and Solutes

All biological cells contain essentially the same building blocks and types of macromolecules. The general classes of substances in cells are presented in Table 1.1. There are significant variations in concentration of specific components in different cell types and in organelles of eukaryotic cells. **Microenvironments** are also created by macromolecules and membranes in which the composition differs from that of the surrounding milieu. Cells depend on the external environment for nutrients required for replacement of components, growth, and energy needs. They have a variety of mechanisms to cope with variations in composition of the external environment. **Water** is the one common component of all environments. It is the solvent in which the substances required for the cell's existence are dissolved or suspended. The unique physicochemical properties of water make life on earth possible.

Hydrogen Bonds Form between Water Molecules

Two hydrogen atoms share their electrons with an unshared pair of electrons of an oxygen atom to form a water molecule. The oxygen nucleus has a stronger attraction for shared electrons than hydrogen, and positively charged hydrogen nuclei are left with an unequal share of electrons, creating a partial positive charge on each hydrogen and a partial negative charge on oxygen. The bond angle between hydrogens and oxygen is 104.5°, making the molecule electrically asymmetric and producing an electric dipole (Figure 1.2). Water molecules interact because positively charged hydrogen atoms on one molecule are attracted to the negatively charged oxygen atom on another, with formation of a weak bond between two water molecules (Figure 1.3a). This bond, indicated by a dashed line, is a **hydrogen bond**. A detailed discussion of noncovalent interactions between molecules, including electrostatic, van der Waals, and hydrophobic, is presented on page 64. Five molecules of water form a tetrahedral structure (Figure 1.3b), because each oxygen shares its electrons with four hydrogen atoms and each hydrogen with another oxygen. A tetrahedral lattice structure is formed in ice and gives ice its crystalline structure. Some hydrogen bonds are broken as ice is transformed to liquid water. Each bond is relatively

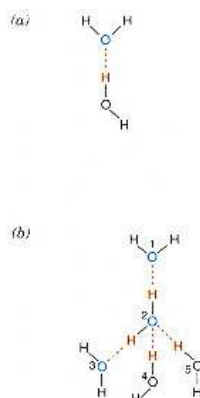

Figure 1.3
Hydrogen bonding.
(a) Hydrogen bonding, indicated by dashed lines, between two water molecules.
(b) Tetrahedral hydrogen bonding of five water molecules. Water molecules 1, 2, and 3 are in the plane of the page, 4 is below, and 5 is above.

TABLE 1.1 Chemical Components of Biological Cells

Component	Range of Molecular Weights
H ₂ O	18
Inorganic ions Na ⁺ , K ⁺ , Cl ⁻ , SO ₄ ²⁻ , HCO ₃ ⁻ , Ca ²⁺ , Mg ²⁺ , etc.	23–100
Small organic molecules Carbohydrates, amino acids, lipids, nucleotides, peptides	100–1200
Macromolecules Proteins, polysaccharides, nucleic acids	50,000–1,000,000,000

weak compared to a covalent bond but the large number of hydrogen bonds between molecules in liquid water is the reason for the stability of water. Liquid water actually has a definite structure due to hydrogen bonding that is in a dynamic state as these bonds break and reform. Hydrogen bonds in water have a half-life of less than 1×10^{-10} s. Liquid water contains a significant number of hydrogen bonds even at 100°C , which accounts for its high heat of vaporization; in the transformation from liquid to vapor state, hydrogen bonds are disrupted.

Water molecules hydrogen bond to different chemical structures. Hydrogen bonding also occurs between other molecules and within a molecule wherever electronegative oxygen or nitrogen comes in close proximity to hydrogen covalently bonded to another electronegative atom. Representative hydrogen bonds are presented in Figure 1.4. Intramolecular hydrogen bonding occurs extensively in large macromolecules such as proteins and nucleic acids and is partially responsible for their structural stability.

Many models for the structure of liquid water have been proposed, but none adequately explains all its properties.

Water Has Unique Solvent Properties

The polar nature and ability to form hydrogen bonds are the basis for the unique **solvent properties** of water. Polar molecules are readily dispersed in water. **Salts** in which a crystal lattice is held together by attraction of positive and negative groups dissolve in water because electrostatic forces in the crystal can be overcome by attraction of charges to the dipole of water. NaCl is an example where electrostatic attraction of individual Na^+ and Cl^- atoms is overcome by interaction of Na^+ with the negative charge on oxygen atoms, and Cl^- with positive charges on the hydrogen atoms. Thus a shell of water surrounds the individual ions. The number of weak charge-charge interactions between water and Na^+ and Cl^- ions is sufficient to separate the two charged ions.

Many organic molecules that contain nonionic but weakly polar groups are soluble in water because of attraction of these groups to molecules of water. Sugars and alcohols are readily soluble in water for this reason. **Amphipathic** molecules, compounds that contain both polar and nonpolar groups, disperse in water if attraction of the polar group for water can overcome hydrophobic interactions of nonpolar portions of the molecules. Very hydrophobic molecules, such as compounds that contain long hydrocarbon chains, however, do not readily disperse as single molecules in water but interact with one another to exclude the polar water molecules.

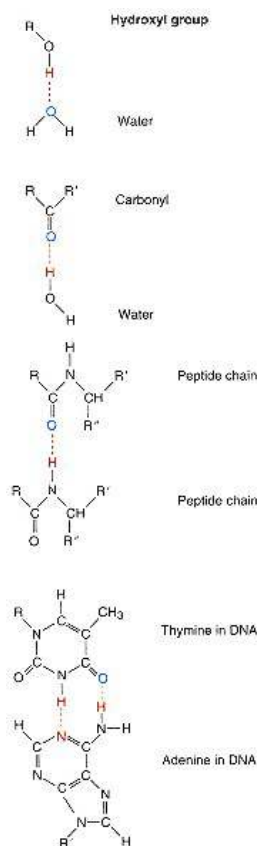

Figure 1.4
Representative hydrogen bonds of importance in biological systems.

Some Molecules Dissociate with Formation of Cations and Anions

Substances that dissociate in water into a **cation** (positively charged ion) and an **anion** (negatively charged ion) are classified as **electrolytes**. The presence of charged ions facilitates conductance of an electrical current through an aqueous solution. Sugars or alcohols, which readily dissolve in water but do not carry a charge or dissociate into charged species, are classified as **nonelectrolytes**.

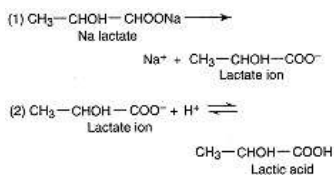
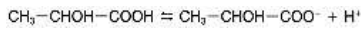

Figure 1.5
Reactions that occur when sodium lactate is dissolved in water.

Salts of alkali metals (e.g., Li, Na, and K), dissolved in water at low concentrations, dissociate completely; at high concentrations, however, there is increased potential for interaction of anions and cations. With biological systems it is customary to consider such compounds as totally dissociated because their concentrations are low. Salts of organic acids, for example, sodium lactate, also dissociate totally and are classified as electrolytes; the dissociated anion, lactate ion, reacts to a limited extent with a proton to form undissociated acid (Figure 1.5). When such salts are dissolved in water, individual ions are present in solution rather than the undissociated salt. If a solution has been prepared with

several different salts (e.g., NaCl, K₂SO₄, and Na lactate), the original molecules do not exist as such in solution, only the ions (e.g., Na⁺, K⁺, SO₄²⁻ and lactate⁻).

Many acids, however, when dissolved in water do not totally dissociate but rather establish an equilibrium between undissociated and dissociated components. Thus lactic acid, an important metabolic intermediate, partially dissociates into lactate anions and H⁺ as follows:



Because of their partial dissociation, however, such compounds have a lower capacity to carry an electrical charge on a molar basis when compared to those that dissociate totally; they are termed **weak electrolytes**.

Weak Electrolytes Dissociate Partially

In partial dissociation of a weak electrolyte, represented by HA, the concentration of the various species can be determined from the equilibrium equation:

$$K'_{\text{eq}} = \frac{[\text{H}^+][\text{A}^-]}{[\text{HA}]}$$

A⁻ represents the dissociated anion and square brackets indicate concentration of each component in concentration units such as moles per liter (mol L⁻¹) or millimol L⁻¹. The **activity** of each species rather than concentration should be employed in the equilibrium equation but since most compounds of interest in biological systems are present in low concentration, the value for activity approaches that of concentration. Thus the equilibrium constant is indicated as K'_{eq} cannot be determined because at equilibrium there is no remaining undissociated solute.

Water Is a Weak Electrolyte

Water dissociates as follows:

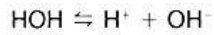

A proton that dissociates interacts with oxygen of another water molecule to form the hydronium ion, H₃O⁺. For convenience, in this book the proton will be presented as H⁺ rather than H₃O⁺, even though the latter is the actual chemical species. At 25°C the value of K'_{eq} for dissociation of water is very small and is about 1.8×10^{-16} :

$$K'_{\text{eq}} = 1.8 \times 10^{-16} = \frac{[\text{H}^+][\text{OH}^-]}{[\text{H}_2\text{O}]} \quad (1.1)$$

With such a small K'_{eq} an insignificant number of water molecules actually dissociate relative to the number of undissociated molecules. Thus the concentration of water, which is 55.5 M, is essentially unchanged. Equation 1.1 can be rewritten as follows:

$$K'_{\text{eq}} \times [\text{H}_2\text{O}] = [\text{H}^+][\text{OH}^-] \quad (1.2)$$

$K'_{\text{eq}} \times [55.5]$ is a constant and is termed the **ion product of water**. Its value at 25°C is 1×10^{-14} . In pure water the concentration of H⁺ equals OH⁻, and by substituting [H⁺] for [OH⁻] in the equation above, [H⁺] is 1×10^{-7} M. Similarly,

$[\text{OH}^-]$ is also 1×10^{-7} M. The equilibrium of H_2O , H^+ , and OH^- always exists in dilute solutions regardless of the presence of dissolved substances. If dissolved material alters either the H^+ or OH^- concentration, as occurs on addition of an acid or base, a concomitant change in the other ion must occur in order to satisfy the equilibrium relationship. By using the equation for the ion product, $[\text{H}^+]$ or $[\text{OH}^-]$ can be calculated if concentration of one of the ions is known.

TABLE 1.2 Relationships Between $[\text{H}^+]$ and pH and $[\text{OH}^-]$ and pOH

$[\text{H}^+]$ (M)	pH	$[\text{OH}^-]$ (M)	pOH
1.0	0	1×10^{-14}	14
0.1 (1×10^{-1})	1	1×10^{-13}	13
1×10^{-2}	2	1×10^{-12}	12
1×10^{-3}	3	1×10^{-11}	11
1×10^{-4}	4	1×10^{-10}	10
1×10^{-5}	5	1×10^{-9}	9
1×10^{-6}	6	1×10^{-8}	8
1×10^{-7}	7	1×10^{-7}	7
1×10^{-8}	8	1×10^{-6}	6
1×10^{-9}	9	1×10^{-5}	5
1×10^{-10}	10	1×10^{-4}	4
1×10^{-11}	11	1×10^{-3}	3
1×10^{-12}	12	1×10^{-2}	2
1×10^{-13}	13	0.1 (1×10^{-1})	1
1×10^{-14}	14	1.0	0

The importance of hydrogen ions in biological systems will become apparent in subsequent chapters. For convenience $[\text{H}^+]$ is usually expressed in terms of **pH**, calculated as follows:

$$\text{pH} = \log \frac{1}{[\text{H}^+]} \quad (1.3)$$

In pure water $[\text{H}^+]$ and $[\text{OH}^-]$ are both 1×10^{-7} M, and $\text{pH} = 7.0$. $[\text{OH}^-]$ is expressed as the pOH. For the equation describing dissociation of water, $1 \times 10^{-14} = [\text{H}^+][\text{OH}^-]$; taking negative logarithms of both sides, the equation becomes $14 = \text{pH} + \text{pOH}$. Table 1.2 presents the relationship between pH and $[\text{H}^+]$.

The pH values of different **biological fluids** are presented in Table 1.3. In blood plasma, $[\text{H}^+]$ is 0.00000004 M or a pH of 7.4. Other cations are between 0.001 and 0.10 M, well over 10,000 times higher than $[\text{H}^+]$. An increase in hydrogen ion to 0.0000001 M (pH 7.0) leads to serious medical consequences and is life threatening; a detailed discussion of mechanisms by which the body maintains intra- and extracellular pH is presented in Chapter 25.

Many Biologically Important Molecules Are Acids or Bases

The definitions of an acid and a base proposed by Lowry and Brønsted are most convenient in considering biological systems. An **acid** is a **proton donor** and a **base** is a **proton acceptor**. Hydrochloric acid (HCl) and sulfuric acid (H_2SO_4) are strong acids because they dissociate totally, and OH^- ion is a base because it accepts a proton, shifting the equilibrium

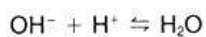

When a strong acid and OH^- are combined, H^+ from the acid and OH^- interact and are in equilibrium with H_2O . Neutralization of H^+ and OH^- occurs because the ion product for water is so small.

Anions produced when strong acids dissociate totally, such as Cl^- from HCl, are not bases because they do not associate with protons in solution. When an organic acid, such as lactic acid, is dissolved in water it dissociates only partially, establishing an equilibrium between an acid (proton donor), an anion of the acid, and a proton as follows:

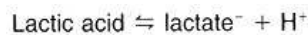

Lactic acid is a **weak acid**. The anion is a base because it accepts a proton and reforms the acid. The weak acid and the base formed on dissociation are referred to as a **conjugate pair**; other examples are presented in Table 1.4. Ammonium ion (NH_4^+) is an acid because it dissociates to yield H^+ and ammonia (NH_3), an uncharged species, which is a **conjugate base**. Phosphoric acid (H_3PO_4) is an acid and PO_4^{3-} is a base, but H_2PO_4^- and HPO_4^{2-} are either a base or acid depending on whether the phosphate group is accepting or donating a proton.

TABLE 1.3 pH of Some Biological Fluids

Fluid	pH
Blood plasma	7.4
Interstitial fluid	7.4
Intracellular fluid	
Cytosol (liver)	6.9
Lysosomal matrix	Below 5.0
Gastric juice	1.5–3.0
Pancreatic juice	7.8–8.0
Human milk	7.4
Saliva	6.4–7.0
Urine	5.0–8.0

The tendency of a conjugate acid to dissociate H^+ can be evaluated from the K'_{eq} of 1×10^{-14} at 25°C.

A convenient method of stating the K'_{eq} is in the form of **pK'**, as

$$\text{pK}' = \log \frac{1}{K'_{\text{eq}}} \quad (1.4)$$

TABLE 1.4 Some Conjugate Acid–Base Pairs of Importance in Biological Systems

Proton Donor (Acid)		Proton Acceptor (Base)
CH ₃ –CHOH–COOH	⇌	H ⁺ + CH ₃ –CHOH–COO ⁻
(lactic acid)		(lactate)
CH ₃ –CO–COOH	⇌	H ⁺ + CH ₃ –CO–COO ⁻
(pyruvic acid)		(pyruvate)
HOOC–CH ₂ –CH ₂ –COOH	⇌	2H ⁺ + ⁻ OOC–CH ₂ –CH ₂ –COO ⁻
(succinic acid)		(succinate)
⁺ H ₃ NCH ₂ –COOH	⇌	H ⁺ + ⁺ H ₃ N–CH ₂ –COO ⁻
(glycine)		(glycinate)
H ₃ PO ₄	⇌	H ⁺ + H ₂ PO ₄ ⁻
H ₂ PO ₄ ⁻	⇌	H ⁺ + HPO ₄ ²⁻
HPO ₄ ²⁻	⇌	H ⁺ + PO ₄ ³⁻
Glucose 6-PO ₃ H ⁻	⇌	H ⁺ + glucose 6-PO ₃ ²⁻
H ₂ CO ₃	⇌	H ⁺ + HCO ₃ ⁻
NH ₄ ⁺	⇌	H ⁺ + NH ₃
H ₂ O	⇌	H ⁺ + OH ⁻

Note the similarity of this definition with that of pH; as with pH and [H⁺], the relationship between pK' and K'_{eq} and pK for conjugate acids of importance in biological systems are presented in Table 1.5.

A special case of a weak acid important in medicine is **carbonic acid** (H₂CO₃). Carbon dioxide when dissolved in water is involved in the following equilibrium reactions:

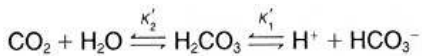

TABLE 1.5 Apparent Dissociation Constant and pK' of Some Compounds of Importance in Biochemistry

Compound		K' _{eq} (M)	pK'
Acetic acid	(CH ₃ –COOH)	1.74 × 10 ⁻⁵	4.76
Alanine	(CH ₃ –CH–COOH) NH ₃ ⁺	4.57 × 10 ⁻³ 2.04 × 10 ⁻¹⁰	2.34 (COOH) 9.69 (NH ₃ ⁺)
Citric acid	(HOOC–CH ₂ –COH–CH ₂ –COOH) COOH	8.12 × 10 ⁻⁴ 1.77 × 10 ⁻⁵ 3.89 × 10 ⁻⁶	3.09 3.74 5.41
Glutamic acid	(HOOC–CH ₂ –CH ₂ –CH–COOH) NH ₃ ⁺	6.45 × 10 ⁻³ 5.62 × 10 ⁻⁵ 2.14 × 10 ⁻¹⁰	2.19 (COOH) 4.25 (COOH) 9.67 (NH ₃ ⁺)
Glycine	(CH ₂ –COOH) NH ₃ ⁺	4.57 × 10 ⁻³ 2.51 × 10 ⁻¹⁰	2.34 (COOH) 9.60 (NH ₃ ⁺)
Lactic acid	(CH ₃ –CHOH–COOH)	1.38 × 10 ⁻⁴	3.86
Pyruvic acid	(CH ₃ –CO–COOH)	3.16 × 10 ⁻³	2.50
Succinic acid	(HOOC–CH ₂ –CH ₂ –COOH)	6.46 × 10 ⁻⁵	4.19
		3.31 × 10 ⁻⁶	5.48
Glucose 6-PO ₃ H ⁻		7.76 × 10 ⁻⁷	6.11
H ₃ PO ₄		1 × 10 ⁻²	2.0
H ₂ PO ₄ ⁻		2.0 × 10 ⁻⁷	6.7
HPO ₄ ²⁻		3.4 × 10 ⁻¹³	12.5
H ₂ CO ₃		1.70 × 10 ⁻⁴	3.77
NH ₄ ⁺		5.62 × 10 ⁻¹⁰	9.25
H ₂ O		1 × 10 ⁻¹⁴	14.0

Carbonic acid is a relatively strong acid with a pK'_1 of 3.77. The equilibrium equation for this reaction is

$$K'_1 = \frac{[H^+][HCO_3^-]}{[H_2CO_3]} \quad (1.5)$$

Carbonic acid is, however, in equilibrium with dissolved CO_2 and the equilibrium equation for this reaction is

$$K'_2 = \frac{[H_2CO_3]}{[CO_2][H_2O]} \quad (1.6)$$

Solving Eq. 1.6 for H_2CO_3 and substituting for the H_2CO_3 in Eq. 1.5, the two equilibrium reactions are combined into one equation:

$$K'_1 = \frac{[H^+][HCO_3^-]}{K'_2[CO_2][H_2O]} \quad (1.7)$$

Rearranging to combine constants, including the concentration of H_2O , simplifies the equation and yields a new combined constant, K'_3 , as follows:

$$K'_1 K'_2 [H_2O] = K'_3 = \frac{[H^+][HCO_3^-]}{[CO_2]} \quad (1.8)$$

It is common practice to refer to dissolved CO_2 as a conjugate acid; it is the acid anhydride of H_2CO_3 . The term K'_3 has a value of 7.95×10^{-7} and $\frac{[H^+][HCO_3^-]}{[CO_2]}$. If the aqueous system is in contact with an air phase, dissolved CO_2 will also be in equilibrium with CO_2 in the air phase. A decrease or increase of one component—that is, CO_2 (air), CO_2 (dissolved), H_2CO_3 , H^+ or $\frac{[H^+][HCO_3^-]}{[CO_2]}$ —will cause a change in all the other components.

The Henderson–Hasselbalch Equation Defines the Relationship between pH and Concentrations of Conjugate Acid and Base

A change in concentration of any component in an equilibrium reaction necessitates a concomitant change in every component. For example, an increase in $[H^+]$ will decrease the concentration of conjugate base (e.g., lactate ion) with an equivalent increase in the conjugate acid (e.g., lactic acid). This relationship is conveniently expressed by rearranging the equilibrium equation and solving for H^+ , as shown for the following dissociation:

Conjugate acid \rightleftharpoons conjugate base + H^+

$$K'_{eq} = \frac{[H^+][conjugate\ base]}{[conjugate\ acid]} \quad (1.9)$$

Rearranging Eq. 1.9 by dividing through by both $[H^+]$ and K'_{eq} leads to

$$\frac{1}{[H^+]} = \frac{1}{K'_{eq}} \cdot \frac{[conjugate\ base]}{[conjugate\ acid]} \quad (1.10)$$

Taking the logarithm of both sides gives

$$\log \frac{1}{[H^+]} = \log \frac{1}{K'_{eq}} + \log \frac{[conjugate\ base]}{[conjugate\ acid]} \quad (1.11)$$

Since $pH = \log 1/[H^+]$ and $pK' = \log 1/K'_{eq}$, Eq. 1.11 becomes

$$pH = pK' + \log \frac{[conjugate\ base]}{[conjugate\ acid]} \quad (1.12)$$

Equation 1.12, developed by Henderson and Hasselbalch, is a convenient way of viewing the relationship between pH of a solution and relative amounts of conjugate base and acid present. Analysis of Eq. 1.12 demonstrates that when the ratio of [base]/[acid] is 1 : 1, pH equals the pK' of the acid because $\log 1 = 0$,

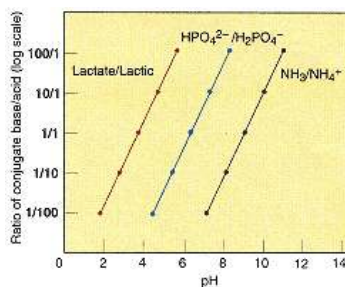

Figure 1.6
Ratio of conjugate [base]/[acid] as a function of the pH.
 When the ratio of [base]/[acid] is 1, pH equals pK of weak acid.

and thus $pH = pK$. If pH is one unit less than pK , the [base]/[acid] ratio is 1 : 10, and if pH is one unit above pK , the [base]/[acid] ratio is 10 : 1. Figure 1.6 is a plot of ratios of conjugate base to conjugate acid versus pH of several weak acids; note that ratios are presented on a logarithmic scale.

Buffering Is Important to Control pH

When NaOH is added to a solution of a weak acid such as lactic acid, the ratio of [conjugate base]/[conjugate acid] changes. NaOH dissociates totally and the OH^- formed is neutralized by existing H^+ to form H_2O . The decrease in $[H^+]$ will cause further dissociation of weak acid to comply with requirements of its equilibrium reaction. The amount of weak acid dissociated will be so nearly equal to the amount of OH^- added that it is considered to be equal. Thus the decrease in amount of conjugate acid is equal to the amount of conjugate base that is formed. These series of events are represented in titration curves of two weak acids presented in Figure 1.7. When 0.5 equiv of OH^- is added, 50% of the weak acid is dissociated and the [acid]/[base] ratio is 1.0; pH at this point is equal to pK of the acid. Shapes of individual titration curves are similar but displaced due to differences in pK values. There is a rather steep rise in pH when only 0.1 equiv of OH^- are added, but between 0.1 and 0.9 equiv of added OH^- , the pH change is only ~ 2 . Thus a large amount of OH^- is added with a relatively small change in pH. This is called **buffering** and is defined as the ability of a solution to resist a change in pH when an acid or base is added. If weak acid were not present, the pH would be very high with only a small amount of OH^- because there would be no source of H^+ to neutralize the OH^- .

The best buffering range for a conjugate pair is in the pH range near the pK of the weak acid. Starting from a pH one unit below to a pH one unit above pK , $\sim 82\%$ of a weak acid in solution will dissociate, and therefore an amount of base equivalent to about 82% of original acid can be neutralized with a change in pH of 2. The maximum buffering range for a conjugate pair is considered to be between 1 pH unit above and below the pK . Lactic acid with $pK = 3.86$ is an effective buffer in the range of pH 3 to 5 but has no buffering capacity at $pH = 7.0$. The $HPO_4^{2-}/H_2PO_4^-$ pair with $pK = 6.7$, however, is an effective buffer at $pH = 7.0$. Thus at the pH of the cell's cytosol (~ 7.0), the lactate–lactic acid pair is not an effective buffer but the phosphate system is.

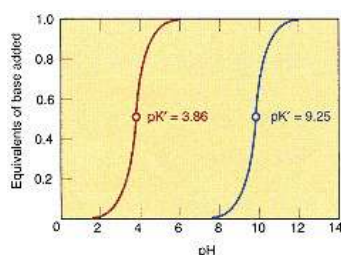

Figure 1.7
Acid–base titration curves for lactic acid (pK' 3.86) and NH_4^+ (pK' 9.25).
 At pH equal to respective pK values, there will be an equal amount of acid and base for each conjugate pair.

Buffering capacity also depends on the concentrations of conjugate acid and base. The higher the concentration of conjugate base, the more added H^+ with which it can react. The more conjugate acid the more added OH^- can be

neutralized by the dissociation of the acid. A case in point is blood plasma at pH 7.4. For $\text{HPO}_4^{2-}/\text{H}_2\text{PO}_4^-$ the pK' of 6.7 would suggest that this conjugate pair would be an effective buffer; the concentration of the phosphate pair, however, is low compared to that of the $\text{HCO}_3^-/\text{CO}_2$ system with a pK' of 6.1, which is present at a 20-fold higher concentration and accounts for most of the buffering capacity. In considering the buffering capacity both the pK' and the concentration of the conjugate pair must be taken into account. Most organic acids are relatively unimportant as buffers in cellular fluids because their pK' values are more than several pH units lower than the pH of the cell, and their concentrations are too low in comparison to such buffers as $\text{HPO}_4^{2-}/\text{H}_2\text{PO}_4^-$ and the $\text{HCO}_3^-/\text{CO}_2$ system.

The importance of pH and buffers in biochemistry and clinical medicine will become apparent, particularly in Chapters 2, 4, and 25. Figure 1.8 presents

1. Calculate the ratio of $\text{HPO}_4^{2-}/\text{H}_2\text{PO}_4^-$ ($pK'=6.7$) at pH 5.7, 6.7, and 8.7.

Solution:
$$\text{pH} = \text{pK} + \log \frac{[\text{HPO}_4^{2-}]}{[\text{H}_2\text{PO}_4^-]}$$

$5.7 = 6.7 + \log$ of ratio; rearranging

$5.7 - 6.7 = -1 = \log$ of ratio

The antilog of $-1 = 0.1$ or $1/10$. Thus, $\text{HPO}_4^{2-}/\text{H}_2\text{PO}_4^- = 1/10$ at pH 5.7. Using the same procedure, the ratio at pH 6.7 = $1/1$ and at pH 8.7 = $100/1$.

2. If the pH of blood is 7.1 and the HCO_3^- concentration is 8 mM, what is the concentration of CO_2 in blood (pK' for $\text{HCO}_3^-/\text{CO}_2 = 6.1$)?

Solution:
$$\text{pH} = \text{pK} + \log \frac{[\text{HCO}_3^-]}{[\text{CO}_2]}$$

$7.1 = 6.1 + \log 8 \text{ mM} / [\text{CO}_2]$; rearranging

$7.1 - 6.1 = 1 = \log 8 \text{ mM} / [\text{CO}_2]$.

The antilog of 1 = 10. Thus, $10 = 8 \text{ mM} / [\text{CO}_2]$, or $[\text{CO}_2] = 8 \text{ mM}/10 = 0.8 \text{ mM}$.

3. At a normal blood pH of 7.4, the sum of $[\text{HCO}_3^-] + [\text{CO}_2] = 25.2 \text{ mM}$. What is the concentration of HCO_3^- and CO_2 (pK' for $\text{HCO}_3^-/\text{CO}_2 = 6.1$)?

Solution:
$$\text{pH} = \text{pK} + \log \frac{[\text{HCO}_3^-]}{[\text{CO}_2]}$$

$7.4 = 6.1 + \log [\text{HCO}_3^-] / [\text{CO}_2]$; rearranging

$7.4 - 6.1 = 1.3 = \log [\text{HCO}_3^-] / [\text{CO}_2]$.

The antilog of 1.3 is 20. Thus $[\text{HCO}_3^-] / [\text{CO}_2] = 20$. Given $[\text{HCO}_3^-] + [\text{CO}_2] = 25.2$, solve these two equations for $[\text{CO}_2]$ by rearranging the first equation:

$$[\text{HCO}_3^-] = 20 [\text{CO}_2]$$

Substituting in the second equation,

$$20 [\text{CO}_2] + [\text{CO}_2] = 25.2$$

or

$$\text{CO}_2 = 1.2 \text{ mM}$$

Then substituting for CO_2 , $1.2 + [\text{HCO}_3^-] = 25.2$, and solving, $[\text{HCO}_3^-] = 24 \text{ mM}$.

Figure 1.8
Typical problems of pH and buffering.

some typical problems using the Henderson–Hasselbalch equation and Clin. Corr. 1.1 is a representative problem encountered in clinical practice.

CLINICAL CORRELATION 1.1

Blood Bicarbonate Concentration in Metabolic Acidosis

Blood buffers in a normal adult control blood pH at about 7.40; if the pH should drop below 7.35, the condition is referred to as an acidosis. A blood pH of near 7.0 could lead to serious consequences and possibly death. Thus in acidosis, particularly that caused by a metabolic change, it is important to monitor the acid–base parameters of a patient's blood. Values of interest to a clinician include the pH and HCO_3^- and CO_2 concentrations. Normal values for these are pH = 7.40, $[\text{HCO}_3^-] = 24.0$ mM, and $[\text{CO}_2] = 1.20$ mM.

Blood values of a patient with a metabolic acidosis were pH = 7.03 and $[\text{CO}_2] = 1.10$ mM. What is the patient's blood $[\text{HCO}_3^-]$ and how much of the normal $[\text{HCO}_3^-]$ has been used in buffering the acid causing the condition?

1. The Henderson–Hasselbalch equation is

$$\text{pH} = \text{pK}' + \log([\text{HCO}_3^-]/[\text{CO}_2])$$

The pK' value for $[\text{HCO}_3^-]/[\text{CO}_2]$ is 6.10.

2. Substitute the given values in the equation.

$$7.03 = 6.10 + \log([\text{HCO}_3^-]/1.10 \text{ mM})$$

or

$$7.03 - 6.10 = 0.93 \\ = \log([\text{HCO}_3^-]/1.10 \text{ mM})$$

The antilog of 0.93 is 8.5; thus

$$8.5 = [\text{HCO}_3^-]/1.10 \text{ mM}$$

or

$$[\text{HCO}_3^-] = 9.4 \text{ mM}$$

3. Since the normal value of $[\text{HCO}_3^-]$ is 24 mM, there has been a decrease of 14.6 mmol of HCO_3^- per liter of blood in this patient. If much more HCO_3^- is lost, a point would be reached when this important buffer would be unavailable to buffer any more acid in the blood and the pH would drop rapidly. In Chapter 25 there is a detailed discussion of the causes and compensations that occur in such conditions.

1.3—

Organization and Composition of Eukaryotic Cells

As described above, eukaryotic cells are organized into compartments, each delineated by a membrane (Figure 1.9). These are well-defined cellular organelles such as nucleus, mitochondria, lysosomes, and peroxisomes. Membranes also form a tubule-like network throughout the cell enclosing an interconnecting space or cisternae, as is the case of the endoplasmic reticulum or Golgi complex. As described in Section 1.4, these compartments have specific functions and activities.

The semipermeable nature of **cellular membranes** prevents the ready diffusion of many molecules from one side to the other. Specific mechanisms in membranes for translocation of large and small, charged and uncharged molecules allow membranes to modulate concentrations of substances in various compartments.

Macromolecules, such as proteins and nucleic acids, do not cross biological membranes unless there is a specific mechanism for their translocation or the membrane is damaged. Thus the fluid matrix of various cellular compartments has a distinctive composition of inorganic ions, organic molecules, and macromolecules. Partitioning of activities and components in membrane-enclosed compartments and organelles has a number of advantages for the economy of the cell. These include the sequestering of substrates and cofactors where they are required, and adjustments of pH and ionic composition for maximum activity of biological processes.

The activities and composition of cellular structures and organelles have been determined with intact cells by a variety of histochemical, immunological, and fluorescent staining methods. Continuous observation in real time of cellular events in intact viable cells is possible. Examples are studies that involve changes of ionic calcium concentration in the cytosol by the use of fluorescent calcium indicators. Individual organelles, membranes, and components of the cytosol can be isolated and analyzed following disruption of the plasma membrane. Permeability of the plasma membrane can be altered to permit the release of subcellular components. Techniques for disrupting membranes include use of detergents, osmotic shock, and homogenization of tissues, where shearing forces break down the plasma membrane. In an appropriate isolation medium, cell organelles and membrane systems can be separated by centrifugation because of differences in size and density. Chromatographic procedures have been employed for isolation of individual cellular fractions and components. These techniques have permitted isolation of cellular fractions from most mammalian tissues. In addition, components of organelles such as nuclei and mitochondria can be isolated following disruption of the organelle membrane.

In many instances the isolated structures and cellular fractions appear to retain the chemical and biochemical characteristics of the structure *in situ*. But biological membrane systems are very sensitive structures, subject to damage even under very mild conditions, and alterations can occur during isolation, which can lead to change in composition of the structure. The slightest damage to a membrane alters its permeability properties, allowing substances that would normally be excluded to traverse the membrane barrier. In addition, many proteins are only loosely associated with membranes and easily dissociate when damage occurs (see p. 186).

Not unexpectedly, there are differences in structure, composition, and activities of cells from different tissues due to the diverse functions of tissues. Major biochemical activities of the cellular organelles and membrane systems, however, are fairly constant from tissue to tissue. Thus biochemical pathways in liver are often present in other tissues. The differences between cell types are

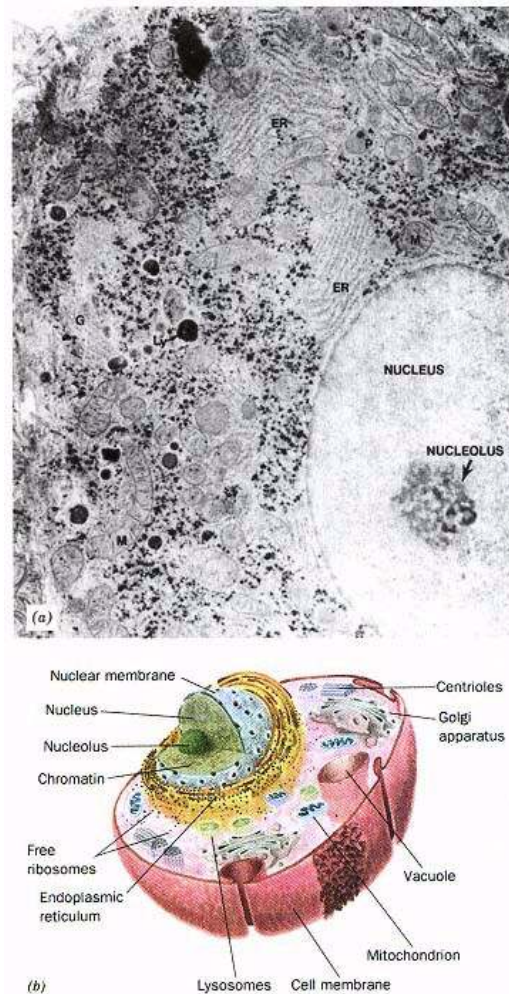

Figure 1.9
(a) Electron micrograph of a rat liver cell labeled to indicate the major structural components of eukaryotic cells and (b) a schematic drawing of an animal cell.

Note the number and variety of subcellular organelles and the network of interconnecting membranes enclosing channels, that is, cisternae. All eukaryotic cells are not as complex in their appearance, but most contain the major structures shown in the figure. ER, endoplasmic reticulum; G, Golgi zone, Ly, lysosomes, P, peroxisomes; M, mitochondria. Photograph (a) reprinted with permission of Dr. K. R. Porter from Porter, K. R., and Bonneville, M. A. In: *Fine Structure of Cells and Tissues*. Philadelphia: Lea & Febiger, 1972; schematic (b) reprinted with permission from Voet, D., and Voet, J. G. *Biochemistry*, 2nd ed. New York: Wiley, 1995.

usually in distinctive specialized activities. Even within one tissue, cells of different origin have qualitative and quantitative differences in cell organelle composition.

Chemical Composition of Cells

Each cellular compartment has an aqueous fluid or **matrix** that contains various ions, small molecular weight organic molecules, different proteins, and nucleic acids. Localization of specific macromolecules, such as enzymes, has been

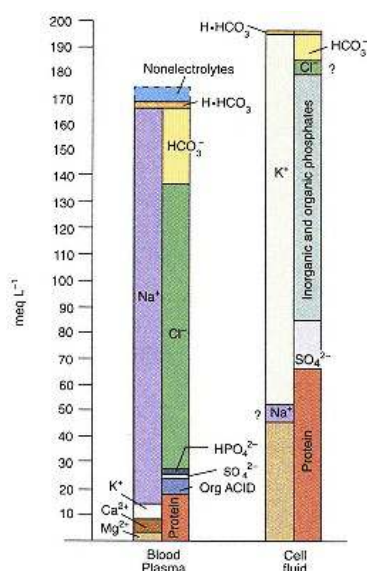

Figure 1.10
Major chemical constituents of blood plasma and cell fluid.

Height of left half of each column indicates total concentration of cations; that of right half, concentrations of anions. Both are expressed in milliequivalents per liter (meq L⁻¹) of fluid. Note that chloride and sodium values in cell fluid are questioned.

It is probable that, at least in muscle, the cytosol contains some sodium but no chloride.

Adapted from Gregersen, M. I. In: P. Bard (Ed.), *Medical Physiology*, 11th ed. St Louis, MO: Mosby, 1961, p. 307.

determined but the exact ionic composition of the matrix of organelles is still uncertain. Each has a distinctly different ionic composition and pH. The overall ionic composition of intracellular fluid, considered to represent the cytosol primarily, compared to blood plasma is presented in Figure 1.10. Na⁺ is the major extracellular cation, with a concentration of ~140 meq L⁻¹ (mM); very little Na⁺ is present in intracellular fluid. K⁺ is the major intracellular cation. Mg²⁺ is present in both extra- and intracellular compartments at concentrations much lower than Na⁺ and K⁺. The major extracellular anions are Cl⁻ and HCO₃⁻, with lower amounts of phosphate and sulfate. Most proteins have a negative charge at pH 7.4 (Chapter 2), being anions at the pH of tissue fluids. Major intracellular anions are inorganic phosphate, organic phosphates, and proteins. Other inorganic and organic anions and cations are present in concentrations well below the milliequivalent per liter (millimolar) level. Except for very small differences created by membranes and leading to development of membrane potentials, the total anion concentration equals the total cation concentration in the different fluids.

Intracellular concentrations of most small molecular weight organic molecules, such as sugars, organic acids, amino acids, and phosphorylated intermediates, are in the range of 0.01–1.0 mM but can have significantly lower concentrations. Coenzymes, organic molecules required for activity of some enzymes, are in the same range of concentration. Substrates for enzymes are present in relatively low concentration in contrast to inorganic ions, but localization in a

specific organelle or cellular microenvironment can increase their concentrations significantly.

It is not very meaningful to determine the molar concentration of individual proteins in cells. In many cases they are localized with specific structures or in combination with other proteins to create a functional unit. It is in a restricted compartment that individual proteins carry out their role, whether structural, catalytic, or regulatory.

1.4—

Functional Role of Subcellular Organelles and Membrane Systems

The subcellular localization of various metabolic pathways will be described throughout this book. In some cases an entire pathway is located in a single compartment but many are divided between two locations, with the intermediates in the pathway moving or being translocated from one compartment to another. In general, organelles have very specific functions and the enzymatic activities involved are used to identify them during isolation.

The following describes briefly some major roles of eukaryotic cell structures to indicate the complexity and organization of cells. A summary of functions and division of labor within eukaryotic cells is presented in Table 1.6 and the structures are presented in Figure 1.9.

TABLE 1.6 Summary of Eukaryotic Cell Compartments and Their Major Functions

<i>Compartment</i>	<i>Major Functions</i>
Plasma membrane	Transport of ions and molecules
	Recognition
	Receptors for small and large molecules
Nucleus	Cell morphology and movement
	DNA synthesis and repair
Nucleolus	RNA synthesis
	RNA processing and ribosome synthesis
Endoplasmic reticulum	Membrane synthesis
	Synthesis of proteins and lipids for some organelles and for export
	Lipid synthesis
Golgi apparatus	Detoxication reactions
	Modification and sorting of proteins for incorporation into organelles and for export
	Export of proteins
Mitochondria	Energy conservation
	Cellular respiration
	Oxidation of carbohydrates and lipids
Lysosomes	Urea and heme synthesis
	Cellular digestion: hydrolysis of proteins, carbohydrates, lipids, and nucleic acids
Peroxisomes	Oxidative reactions involving O ₂
	Utilization of H ₂ O ₂
Microtubules and microfilaments	Cell cytoskeleton
	Cell morphology
	Cell motility
Cytosol	Intracellular movements
	Metabolism of carbohydrates, lipids, amino acids, and nucleotides
	Protein synthesis

CLINICAL CORRELATION 1.2

Mitochondrial Diseases: Luft's Disease

A disease specifically involving mitochondrial energy transduction was first reported in 1962. A 30-year-old patient was described with general weakness, excessive perspiration, a high caloric intake without increase in body weight, and an excessively elevated basal metabolic rate (a measure of oxygen utilization). It was demonstrated that the patient had a defect in the mechanism that controls mitochondrial oxygen utilization (see Chapter 6). The condition is referred to as Luft's disease. Since that time, over 100 mitochondrial-based diseases have been identified, including those involving a variety of enzymes and transport systems required for the proper maintenance and control of energy conservation. Many involve skeletal muscle and the central nervous system. Replication of mitochondria depends on the mitochondrial DNA (mtDNA) and inheritance of mitochondria is by maternal transmission. Mutations of mtDNA as well as nuclear DNA lead to genetic diseases. Mitochondrial damage may also occur due to free-radical (superoxides) formation which can damage mtDNA. Thus age-related degenerative diseases, such as Parkinson's and Alzheimer's, and cardiomyopathies may have a component of mitochondrial damage. For details of specific diseases see Clin. Corr. 13.4 and 14.6.

Luft, R. The development of mitochondrial medicine. *Proc. Natl. Acad. Sci. USA* 91:8731,1994.

Plasma Membrane Is the Limiting Boundary of a Cell

The **plasma membrane** of every cell has a unique role in maintenance of that cell's integrity. One surface is in contact with a variable external environment and the other with a relatively constant environment provided by the cell's cytoplasm. As will be discussed in Chapter 5, the two sides of the plasma membrane, and all intracellular membranes, have different chemical compositions and functions. A major role of the plasma membrane is to permit entrance of some substances but exclude many others. With cytoskeletal elements, the plasma membrane is involved in cell shape and movements. Through this membrane cells communicate; the membrane contains many specific receptor sites for chemical signals, such as hormones (Chapter 20), released by other cells. The inner surface of plasma membranes is the site for attachment of some enzymes involved in various metabolic pathways. Plasma membranes from a variety of cells have been isolated and studied extensively; details of their structure and biochemistry and those of other membranes are presented in Chapter 5.

Nucleus Is Site of DNA and RNA Synthesis

Early microscopists divided the interior of cells into a **nucleus**, the largest membrane-bound compartment, and the **cytoplasm**. The nucleus is surrounded by two membranes, termed the **nuclear envelope**, with the outer membrane being continuous with membranes of the endoplasmic reticulum. The nuclear envelope has numerous pores about 90 Å in diameter that permit flow of all but the largest molecules between nuclear matrix and cytoplasm. The nucleus contains a subcompartment, seen clearly in electron micrographs, the **nucleolus**. The vast amount of cellular **deoxyribonucleic acid (DNA)** is located in the nucleus as a DNA-protein complex, **chromatin**, that is organized into chromosomes. DNA is the repository of genetic information and the importance of the nucleus in cell division and for controlling phenotypic expression of genetic information is well established. Biochemical reactions in the nucleus are replication of DNA during mitosis, repair of DNA following damage (Chapter 15), and transcription of the information stored in DNA into a form that can be translated into cell proteins (Chapter 16). Transcription of DNA involves synthesis of ribonucleic acid (RNA) that is processed into a variety of forms following synthesis. Part of this processing occurs in the nucleolus, which is very rich in RNA.

Endoplasmic Reticulum Has a Role in Many Synthetic Pathways

The cytoplasm of most eukaryotic cells contains a network of interconnecting membranes that enclose channels, **cisternae**, that thread from the perinuclear envelope to the plasma membrane. This extensive subcellular structure, termed **endoplasmic reticulum**, consists of membranes with a rough appearance in some areas and smooth in other places. The rough appearance is due to the presence of **ribonucleoprotein particles**, that is, **ribosomes**, attached on the cytosolic side of the membrane. Smooth endoplasmic reticulum does not contain bound ribosomes. During cell fractionation the endoplasmic reticulum network is disrupted, with the membrane resealing into small vesicles called **microsomes** that can be isolated by differential centrifugation. Microsomes per se do not occur in cells.

A major function of ribosomes on **rough endoplasmic reticulum** is biosynthesis of proteins for export to the outside of the cell and proteins for incorporation into cellular organelles such as the endoplasmic reticulum, Golgi apparatus, plasma membrane, and lysosomes. **Smooth endoplasmic reticulum** is involved in membrane lipid synthesis and contains an important class

of enzymes termed **cytochromes P450** that catalyze hydroxylation of a variety of endogenous and exogenous compounds. These enzymes are important in biosynthesis of steroid hormones and removal of toxic substances (see Chapter 23). Endoplasmic reticulum with the Golgi apparatus has a role in formation of other cellular organelles such as lysosomes and peroxisomes.

The Golgi Apparatus Is Involved in Sequestering of Proteins

The **Golgi apparatus** is a network of flattened smooth membranes and vesicles responsible for the secretion to the external environment of a variety of proteins synthesized on the endoplasmic reticulum. Golgi membranes catalyze the transfer of carbohydrate and lipid precursors to proteins to form glycoproteins and lipoproteins and is a major site of new membrane formation. Membrane vesicles are formed in the Golgi apparatus in which various proteins and enzymes are encapsulated to be secreted from the cell after an appropriate signal. Digestive enzymes synthesized by the pancreas are stored in intracellular vesicles formed by the Golgi apparatus and released when needed in the digestive process (see p. 1059). The role in membrane synthesis also includes the formation of intracellular organelles such as lysosomes and peroxisomes.

TABLE 1.7 Representative Lysosomal Enzymes and Their Substrates

<i>Type of Substrate and Enzyme</i>	<i>Specific Substrate</i>
POLYSACCHARIDE-	
HYDROLYZING	
ENZYMES	
α -Glucosidase	Glycogen
α -Flucosidase	Membrane fucose
	Galactosides
β -Galactosidase	Mannosides
α -Mannosidase	Glucuronides
β -Glucuronidase Hyaluronidase	Hyaluronic acid and chondroitin sulfates
Arylsulfatase	Organic sulfates
Lysozyme	Bacterial cell walls
PROTEIN-HYDROLYZING	
ENZYMES	
Cathepsins	Proteins
Collagenase	Collagen
Elastase	Elastin
Peptidases	Peptides
NUCLEIC ACID-	
HYDROLYZING	
ENZYMES	
Ribonuclease	RNA
Deoxyribonuclease	DNA
LIPID-HYDROLYZING	
ENZYMES	
Lipases	Triglyceride and cholesterol esters
Esterase	Fatty acid esters
Phospholipase	Phospholipids
PHOSPHATASES	
Phosphatase	Phospho- monoesters
Phosphodiesterase	Phosphodiesters
SULFATASES	
Heparan sulfate	
Dermatan sulfate	

Mitochondria Supply Most Cell Needs for ATP

Mitochondria appear as spheres, rods, or filamentous bodies that are usually about 0.5–1 μm in diameter and up to 7 μm in length. The internal matrix, the **mitosol**, is surrounded by two membranes, distinctively different in appearance and biochemical function. The inner membrane convolutes into the matrix to form **cristae** and contains numerous small spheres attached by stalks on the inner surface. Outer and inner membranes contain different enzymes. The components of the respiratory chain and the mechanism for ATP synthesis are part of the inner membrane and are described in detail in Chapter 6. Major metabolic pathways involved in oxidation of carbohydrates, lipids, and amino acids, and parts of special biosynthetic pathways involving urea and heme synthesis are located in the mitosol. The outer membrane is relatively permeable but the inner membrane is highly selective and contains a variety of transmembrane transport systems.

Mitochondria contain a specific DNA, with genetic information for some of the mitochondrial proteins, and the biochemical equipment for limited protein synthesis. The presence of this biosynthetic capacity indicates the unique role that mitochondria have in their own destiny. See Clin. Corr. 1.2 for descriptions of diseases attributed to deficits in mitochondrial function.

Lysosomes Are Required for Intracellular Digestion

Intracellular digestion of a variety of substances occurs inside structures designated as **lysosomes**. They have a single limiting membrane and maintain a pH lower in the lysosomal matrix than that of the cytosol. Encapsulated in lysosomes is a group of glycoprotein enzymes—hydrolases—that catalyze hydrolytic cleavage of carbon-oxygen, carbon-nitrogen, carbon-sulfur, and oxygen-phosphorus bonds in proteins, lipids, carbohydrates, and nucleic acids. A partial list of lysosomal enzymes is presented in Table 1.7. As in gastrointestinal digestion, lysosomal enzymes split complex molecules into simple low molecular weight compounds that can be utilized by metabolic pathways of the cell. Enzymes of the lysosome are characterized by being most active when the pH of the medium is acidic, that is, pH 5 and below. The relationship between pH and enzyme activity is discussed in Chapter 4. The pH of the cytosol is close to pH 7.0 and lysosomal enzymes have little activity at this pH.

CLINICAL CORRELATION 1.3

Lysosomal Enzymes and Gout

Catabolism of purines, nitrogen-containing heterocyclic compounds found in nucleic acids, leads to formation of uric acid, which is excreted in the urine (see Chapter 12 for details). Gout is an abnormality in which there is excessive uric acid production with an increase in uric acid in blood and deposition of urate crystals in joints. The consequences are clinical manifestations in the joint, particularly the big toe, including inflammation, pain, swelling, and increased warmth. Uric acid is not very soluble and some of the clinical symptoms of gout can be attributed to damage done by urate crystals. Crystals are phagocytosed by cells in the joint and accumulate in digestive vacuoles that contain lysosomal enzymes. Crystals cause physical damage to the vacuoles, releasing lysosomal enzymes into the cytosol. Even though the pH optima of lysosomal enzymes are lower than the pH of the cytosol, they have some hydrolytic activity at the higher pH. This activity causes digestion of cellular components, release of substances from the cell and autolysis.

Weissmann, G. Crystals, lysosomes and gout. *Adv. Intern. Med.* 19:239, 1974; and Burt, H. M., Kalkman, P. H., and Mauldin, D. Membranolytic effects of crystalline monosodium urate monohydrate. *J. Rheumatol.* 10:440, 1983.

The enzyme content of lysosomes in different tissues varies and depends on specific needs of individual tissues. The lysosomal membrane is impermeable to both small and large molecules and specific protein mediators in the membrane are necessary for translocation of substances. Carefully isolated lysosomes do not catalyze hydrolysis of substrates until this membrane is disrupted. The activities of lysosomal enzymes are termed "**latent**." Membrane disruption *in situ* can lead to cellular digestion, and various pathological conditions have been attributed to release of lysosomal enzymes, including arthritis, allergic responses, several muscle diseases, and drug-induced tissue destruction (see Clin. Corr. 1.3).

Lysosomes are involved in normal digestion of intra- and extracellular substances that must be removed by a cell. Through **endocytosis**, external material is taken into cells and encapsulated in membrane-bound vesicles (Figure 1.11). The plasma membrane invaginates around formed foreign substances, such as microorganisms, by **phagocytosis** and takes up extracellular fluid containing suspended material by **pinocytosis**. Vesicles containing external material fuse with lysosomes to form organelles that contain the materials to be digested and enzymes capable of carrying out the digestion. These vacuoles are identified microscopically by their size and often by the presence of partially formed structures in the process of being digested. Lysosomes in which the

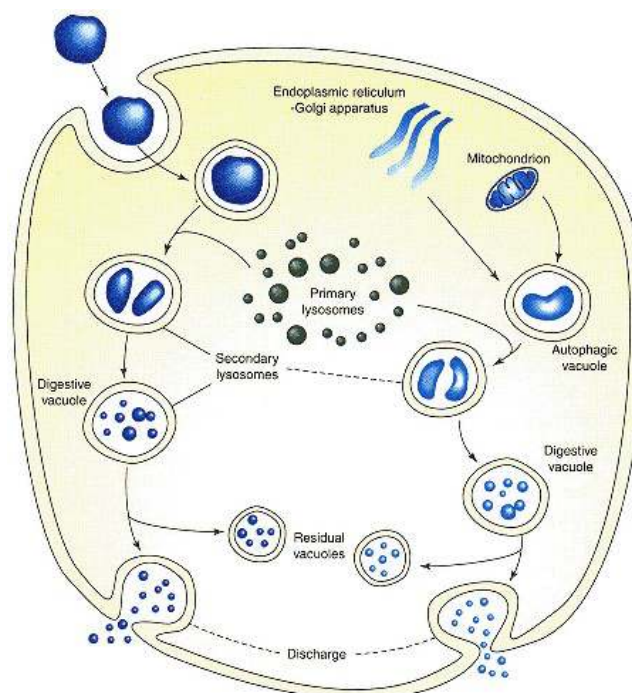

Figure 1.11
Diagrammatic representation of the role of lysosomes in intracellular digestion of substances internalized by phagocytosis (heterophagy) and of cellular components (autophagy).

In both processes substances to be digested are enclosed in a membrane vesicle, followed by fusing with a primary lysosome to form a secondary lysosome.

enzymes are not as yet involved in the digestive process are termed **primary lysosomes**, whereas those in which digestion of material is under way are **secondary lysosomes** or **digestive vacuoles** that will vary in size and appearance.

CLINICAL CORRELATION 1.4

Lysosomal Acid Lipase Deficiency

Two phenotypic forms of a genetic deficiency of lysosomal acid lipase are known. Wolman's disease occurs in infants and is usually fatal by age 1, while cholesterol ester-storage disease usually is diagnosed in adulthood. Both are autosomal recessive disorders. There is deposition of triacylglycerols and cholesterol esters in tissues, particularly the liver. In the latter disease there is early onset of severe atherosclerosis. Acid lipase catalyzes hydrolysis of mono-, di-, and triglycerols as well as cholesterol esters. It is a critical enzyme in cholesterol metabolism, serving to make available free cholesterol for cell needs.

Hegele, R. A., Little, J. A., Vezina, C., et al., Hepatic lipase deficiency: clinical, biochemical, and molecular genetic characteristics. *Atherosclerosis and Thrombosis* 13:720, 1993.

Cell constituents are synthesized and degraded continuously, and lysosomes function in digesting this cellular debris. The dynamic synthesis and degradation includes proteins and nucleic acids, as well as structures such as mitochondria and endoplasmic reticulum. During this normal self-digestion process, that is, **autolysis**, cell substances are encapsulated within a membrane vesicle that fuses with a lysosome to complete the degradation. The overall process is termed **autophagy** and is also represented in Figure 1.11.

Products of lysosomal digestion diffuse across lysosomal membranes and are reutilized by the cell. Indigestible material accumulates in vesicles referred to as residual bodies, whose contents are removed from the cell by exocytosis. In some cases, residual bodies that contain a high concentration of lipid persist for long periods of time. Lipid is oxidized and a pigmented substance, which is chemically heterogeneous and contains polyunsaturated fatty acids and proteins, accumulates in the cell. This material, **lipofuscin**, is also called the "**age pigment**" or "**wear and tear pigment**" because it accumulates in cells of older individuals. It occurs in all cells but particularly in neurons and muscle cells and has been implicated in the aging process.

Under controlled conditions lysosomal enzymes are secreted from the cell for the digestion of extracellular material; an extracellular role for some lysosomal enzymes has been demonstrated in connective tissue and prostate gland and in the process of embryogenesis. Thus they have a role in programmed cell death or **apoptosis**.

Absence of specific lysosomal enzymes occurs in a number of genetic diseases in which there is accumulation in the cell of specific cellular components that cannot be digested. Lysosomes of affected cells become enlarged with undigested material, which interferes with normal cell processes. Lysosomal storage diseases are discussed in Chapter 10 (see p. 427); see Clin. Corr. 1.4 for a description of a deficiency of lysosomal lipase.

Peroxisomes Contain Oxidative Enzymes Involving Hydrogen Peroxide

Most eukaryotic cells of mammalian origin and those of protozoa and plants have organelles, designated **peroxisomes** or **microbodies**, which contain enzymes that either produce or utilize **hydrogen peroxide** (H_2O_2). They are small (0.3–1.5 μm in diameter), spherical or oval in shape, with a granular matrix and in some cases a crystalline inclusion termed a nucleoid. Peroxisomes contain enzymes that oxidize D-amino acids, uric acid, and various 2-hydroxy acids using molecular O_2 with formation of H_2O_2 . Catalase, an enzyme present in peroxisomes, catalyzes the conversion of H_2O_2 to water and oxygen and oxidation by H_2O_2 of various compounds (Figure 1.12). By having both peroxide-producing and peroxide-utilizing enzymes in one compartment, cells protect themselves from the toxicity of H_2O_2 .

Peroxisomes also contain enzymes involved in lipid metabolism, particularly oxidation of very long-chain fatty acids, and synthesis of glycerolipids and glycerol ether lipids (plasmalogens) (see Chapter 10). See Clin. Corr. 1.5 for a discussion of Zellweger syndrome in which there is an absence of peroxisomes.

Peroxisomes of different tissues contain different complements of enzymes, and the peroxisome content of cells can vary depending on cellular conditions.

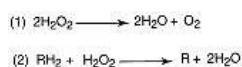

Figure 1.12
Reactions catalyzed by catalase.

Cytoskeleton Organizes the Intracellular Contents

Eukaryotic cells contain microtubules and actin filaments (microfilaments) as parts of the cytoskeletal network. The **cytoskeleton** has a role in maintenance

of cellular morphology, intracellular transport, cell motility, and cell division. **Microtubules**, multimers of the protein **tubulin**, can be rapidly assembled and disassembled depending on the cell's needs. Two very important cellular filaments, actin and myosin, occur in striated muscle and are responsible for muscular contraction (see Chapter 22). Three **mechanochemical proteins**—**myosin**, **dynein**, and **kinesin**—convert chemical energy into mechanical energy for movement of cellular components. These molecular motors are associated with the cytoskeleton; the actual mechanism for the energy conversion, however, has not been defined completely. Dynein is involved in ciliary and flagellar movement, whereas kinesin is a driving force for the movement of vesicles and organelles along microtubules.

CLINICAL CORRELATION 1.5

Zellweger Syndrome and the Absence of Functional Peroxisomes

Zellweger syndrome is a rare, autosomal recessive disease characterized by abnormalities of the liver, kidney, brain, and skeletal system. It usually results in death by age 6 months. A number of seemingly unrelated biochemical abnormalities have been described including decreased levels of glycerol-ether lipids (plasmalogens) and increased levels of very long-chain fatty acids (C-24 and C-26) and cholestanic acid derivatives (precursors of bile acids). These abnormalities are due to the absence of functional peroxisomes in the afflicted children. Peroxisomes are responsible for synthesis of glycerol ethers, for shortening very long-chain fatty acids so that mitochondria can completely oxidize them, and for oxidation of the side chain of cholesterol needed for bile acid synthesis. Evidence indicates that there is a defect in the transport of peroxisomal enzymes between the cytosol and the interior of peroxisomes during synthesis. Cells of afflicted individuals contain empty ghosts of peroxisomes. The disease can be diagnosed prenatally by assaying amniotic fluid cells for peroxisomal enzymes or analyzing the fatty acids in the fluid.

Datta, N. S., Wilson, G. N., and Hajra, A. K. Deficiency of enzymes catalyzing the biosynthesis of glycerol-ether lipids in Zellweger syndrome. *N. Engl. J. Med.* 311:1080, 1984; Moser, A. E., Singh, I., Brown, F. R., Solish, G. I., Kelley, R. I., Benke, P. J., and Moser, H. W. The cerebrohepato renal (Zellweger) syndrome. Increased levels and impaired degradation of very long chain fatty acids and their use for prenatal diagnosis. *N. Engl. J. Med.* 310:1141, 1984; and Wanders, R. J., Schutgens, R.B., and Barth, P. G. Peroxisomal disorders: a review. *J. Neuropathol. Exp. Neurol.* 54:726, 1995.

Cytosol Contains Soluble Cellular Components

The least complex in structure, but not in chemistry, is the organelle-free cell sap, or **cytosol**. It is here that many of the chemical reactions of metabolism occur and where substrates and cofactors interact with various enzymes. Although there is no apparent structure to the cytosol, the high protein content precludes it from being a truly homogeneous mixture of soluble components. Many reactions are localized in selected areas where substrate availability is more favorable. The actual physicochemical state of the cytosol is poorly understood. A major role of the cytosol is to support synthesis of proteins on the rough endoplasmic reticulum by supplying cofactors and energy. The cytosol also contains free ribosomes, often in a polysome form, for synthesis of intracellular proteins.

Studies with isolated cytosol suggest that many reactions are catalyzed by soluble enzymes, but in the intact cell some of these enzymes may be loosely attached to one of the many membrane structures or to cytoskeletal components and are readily released upon cell disruption.

Conclusion

A eukaryotic cell is a complex structure whose purpose is to replicate itself when necessary, maintain an intracellular environment to permit a myriad of complex reactions to occur as efficiently as possible, and to protect itself from the hazards of its surrounding environment. Cells of multicellular organisms also participate in maintaining the well-being of the whole organism by exerting influences on each other to maintain all tissue and cellular activities in balance. Thus, as we proceed to study the separate chemical components and activities of cells in subsequent chapters, it is important to keep in mind the concurrent and surrounding activities, constraints, and influences of the environment. Only by bringing together all the parts and activities of a cell, that is, reassembling the puzzle, will we appreciate the wonder of living cells.

Bibliography

Water and Electrolytes

Dick, D. A. T. *Cell Water*. Washington, DC: Butterworths, 1966.

Eisenberg, D., and Kauzmann, W. *The Structures and Properties of Water*. Fairlawn, NJ: Oxford University Press, 1969.

Morris, J. G. *A Biologist's Physical Chemistry*. Reading, MA: Addison-Wesley, 1968.

Stillinger, F. H. Water revisited. *Science* 209:451, 1980.

Westof, E., *Water and Biological Macromolecules*. Boca Raton, FL: CRC Press, 1993.

Cell Structure

Alberts, B., Bray, D., Lewis, J., Raff, M., Roberts, K., and Watson, J. D. *Molecular Biology of the Cell*. New York: Garland, 1989.

Becker, W. M., and Deamer, D. W. *The World of the Living Cell*, 2nd. ed. Redwood City, CA: Benjamin, 1991.

DeDuke, C. *Guided Tour of the Living Cell*, Vols. 1 and 2. New York: Scientific American Books, 1984.

Dingle, J. T., Dean, R. T., and Sly, W. S. (Eds.). *Lysosomes in Biology and Pathology*. Amsterdam: Elsevier (a serial publication covering all aspects of lysosomes).

Fawcett, D. W. *The Cell*. Philadelphia: Saunders, 1981.

Holtzman, E., and Novikoff, A. B. *Cells and Organelles*, 3rd ed. New York: Holt, Rinehart & Winston, 1984.

Porter, K. R., and Bonneville, M. A. *Fine Structure of Cells and Tissues*. Philadelphia: Lea & Febiger, 1972.

Vale, R. D. Intracellular transport using microtubule-based motors. *Annu. Rev. Cell Biol.* 3:347, 1987.

Cell Organelles

Attardi, G., and Chomyn, A. *Mitochondrial Biogenesis and Genetics*. San Diego, CA: Academic Press, 1995.

Holtzman, E. *Lysosomes*. New York: Plenum Press, 1989.

Latruffe, N., and Bugaut, M. *Peroxisomes*. New York: Springer-Verlag, 1994.

Pavelka, M. *Functional Morphology of the Golgi Apparatus*. New York: Springer-Verlag, 1987.

Preston, T. M., King, C. A., and Hyams, J. S. *The Cytoskeleton and Cell Motility*. New York: Chapman and Hall, 1990.

Strauss, P. R., and Wilson, S. H. *The Eukaryotic Nucleus: Molecular Biochemistry and Macromolecular Assemblies*. Caldwell, NJ: Telford Press, 1990.

Tyler, D. D. *Mitochondrion in Health and Disease*. New York: VCH, 1992.

Tzagoloff, A. *Mitochondria*. New York: Plenum Press, 1982.

Questions

J. Baggot and C. N. Angstadt

1. Prokaryotic cells, but not eukaryotic cells, have:

- A. endoplasmic reticulum.
- B. histones.
- C. nucleoid.
- D. a nucleus.
- E. a plasma membrane.

2. Factors responsible for the polarity of the water molecule include:

- A. the similarity in electron affinity of hydrogen and oxygen.
- B. the tetrahedral structure of liquid water.
- C. the magnitude of the H–O–H bond angle.
- D. the ability of water to hydrogen bond to various chemical structures.
- E. the difference in bond strength between hydrogen bonds and covalent bonds.

3. Hydrogen bonds can be expected to form only between electronegative atoms such as oxygen or nitrogen and a hydrogen atom bonded to:

- A. carbon.
- B. an electronegative atom.
- C. hydrogen.
- D. iodine.
- E. sulfur.

4. Which of the following is least likely to be soluble in water?

- A. nonpolar compound
- B. weakly polar compound
- C. strongly polar compound
- D. weak electrolyte
- E. strong electrolyte

5. Which of the following is most likely to be partly associated in weak aqueous solution?

- A. alcohol
- B. lactic acid
- C. potassium sulfate (K_2SO_4)
- D. sodium chloride (NaCl)
- E. sodium lactate

6. The ion product of water:

- A. is independent of temperature.
- B. has a numerical value of 10^{-14} at $25^\circ C$.
- C. is the equilibrium constant for the reaction $HOH \rightleftharpoons H^+ + OH^-$
- D. requires that $[H^+]$ and $[OH^-]$ always be identical.
- E. is an approximation that fails to take into account the presence of the hydronium ion, H_3O^+ .

7. Which of the following is both a Brønsted acid and a Brønsted base in water?

- A. $H_2PO_4^-$
- B. H_2CO_3
- C. NH_3
- D. NH_4^+
- E. Cl^-

Refer to the following information for Questions 8 and 9.

A. pyruvic acid	$pK = 2.50$
B. acetoacetic acid	$pK = 3.6$
C. lactic acid	$pK = 3.86$
D. β -hydroxybutyric acid	$pK = 4.7$
E. propionic acid	$pK = 4.86$

8. Which weak acid will be 91% neutralized at pH 4.86?

9. Assuming that the sum of [weak acid] + [conjugate base] is identical for buffer systems based on the acids listed above, which has the greatest buffer capacity at pH 4.86?

10. All of the following subcellular structures can be isolated essentially intact EXCEPT:

- A. endoplasmic reticulum.
- B. lysosomes.
- C. mitochondria.
- D. nuclei.
- E. peroxisomes.

11. Biological membranes are associated with all of the following EXCEPT:

- A. prevent free diffusion of ionic solutes.
- B. release of proteins when damaged.
- C. contain specific systems for the transport of uncharged molecules.
- D. sites for biochemical reactions.
- E. proteins and nucleic acids cross freely.

12. Mitochondria are associated with all of the following EXCEPT:

- A. ATP synthesis.
- B. DNA synthesis.
- C. protein synthesis.
- D. hydrolysis of various macromolecules at low pH.
- E. two different membranes.

13. Analysis of the composition of the major fluid compartments of the body shows that:

- A. the major blood plasma cation is K^+ .
- B. the major cell fluid cation is Na^+ .
- C. one of the major intracellular anions is Cl^- .
- D. one of the major intracellular anions is phosphate.
- E. plasma and the cell fluid are all very similar in ionic composition.

Refer to the following for Questions 14–17.

- A. peroxisome
- B. nucleus
- C. cytoskeleton
- D. endoplasmic reticulum
- E. Golgi apparatus

14. Consists of microtubules and actin fibers.

15. Oxidizes very long-chain fatty acids.

16. Connected to the plasma membrane by a network of membranous channels.

17. Transfers carbohydrate precursors to proteins during glycoprotein synthesis.

Answers

1. C Prokaryotic DNA is organized into a structure that also contains RNA and protein, called nucleoid. A, B, and D are found in eukaryotic cells, and E is an element of both prokaryotic and eukaryotic cells (p. 2).

2. C Water is a polar molecule because the bonding electrons are attracted more strongly to oxygen than to hydrogen. The bond angle gives rise to asymmetry of the charge distribution; if water were linear, it would not be a dipole (p. 4). A: Hydrogen and oxygen have very different electron affinity. B and D are consequences of water's structure, not factors responsible for it.

3. B Only hydrogen atoms bonded to one of the electronegative elements (O, N, F) can form hydrogen bonds (p. 5). A hydrogen atom participating in hydrogen bonding must have an electronegative element on both sides of it.

4. A In general, compounds that interact with the water dipoles are more soluble than those that do not. Thus ionized compounds and polar compounds tend to be soluble. Nonpolar compounds prefer to interact with one another rather than with polar solvents such as water (p. 5).

5. B Lactic acid is a weak acid, and weak acids dissociate only partially in aqueous solution (p. 6) A: Alcohol is fully associated. C–E: These are salts and are considered to be fully dissociated under physiological conditions, although at high concentration some association occurs.

6. B The constant is a function of temperature and is numerically equal to the equilibrium constant for the dissociation of water divided by the molar concentration of water (p. 6). D: $[H^+] = [OH^-]$ in pure water, but not in solutions of solutes that contribute H^+ or OH^- .

7. A $H_2PO_4^-$ can donate a proton to become HPO_4^{2-} . It can also accept a proton to become H_3PO_4 . B and D are Brønsted acids; C is a Brønsted base. The Cl^- ion in water is neither (p. 8).

8. C If weak acid is 91% neutralized, 91 parts are present as conjugate base and 9 parts remain as the weak acid. Thus the conjugate base/acid ratio is 10 : 1. Substituting into the Henderson–Hasselbalch equation, $4.86 = pK + \log(10/1)$, and solving for pH gives the answer (p. 9).

9. E The buffer capacity of any system is maximal at $pH = pK$ (p. 10). Buffer concentration also affects buffer capacity, but in this case concentrations are equal.

10. A Gentle disruption of cells will not destroy B–E. The tube-like endoplasmic reticulum, however, is disrupted and forms small vesicles. These vesicles, not the original structure from which they were derived, may be isolated (pp. 12, 16).

11. E (p. 17).

12. D This is a lysosomal function (p. 17). Mitochondrial properties are described on p. 17.

13. D Phosphate and protein are the major intracellular anions. A, B, and E: Plasma and cell fluid are strikingly different. The Na^+ ion is the major cation of plasma. C: Most chloride is extracellular (p. 14, Figure 1.10).

14. C (p. 19).

15. A Fatty acid oxidation occurs in the mitochondria, but the oxidation of very long-chain fatty acids involves the peroxisomes (p. 19).

16. B This describes only the nucleus (p. 16).

17. E Lipids, too, are attached covalently to certain proteins in the Golgi apparatus (p. 17).

Chapter 2— Proteins I: Composition and Structure

Richard M. Schultz and Michael N. Liebman

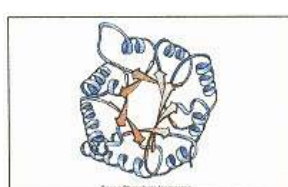

2.1 Functional Roles of Proteins in Humans	24
2.2 Amino Acid Composition of Proteins	25
Proteins Are Polymers of α -Amino Acids	25
Common Amino Acids Have a General Structure	25
Side Chains Define Chemical Nature and Structures of Different Amino Acids	25
Amino Acids Have an Asymmetric Center	28
Amino Acids Are Polymerized into Peptides and Proteins	28
Cystine Is a Derived Amino Acid	30
2.3 Charge and Chemical Properties of Amino Acids and Proteins	30
Ionizable Groups of Amino Acids and Proteins Are Critical for Biological Function	30
Ionic Form of an Amino Acid or Protein Can Be Determined at a Given pH	32
Titration of a Monoamino Monocarboxylic Acid: Determination of the Isoelectric pH	32
Titration of a Monoamino Dicarboxylic Acid	33
General Relationship between Charge Properties of Amino Acids and Proteins and pH	34
Amino Acids and Proteins Can Be Separated Based on pI Values	35
Amino Acid Side Chains Have Polar or Apolar Properties	38
Amino Acids Undergo a Variety of Chemical Reactions	38
2.4 Primary Structure of Proteins	39
2.5 Higher Levels of Protein Organization	42
Proteins Have a Secondary Structure	43
α -Helical Structure	43
β -Structure	44
Supersecondary Structures	44
Proteins Fold into a Three-Dimensional Structure Called the Tertiary Structure	44
Homologous Three-Dimensional Domain Structures Are Often Formed from Common Arrangements of Secondary Structures	47
A Quaternary Structure Occurs When Several Polypeptide Chains Form a Specific Noncovalent Association	48
2.6 Other Types of Proteins	49
Fibrous Proteins Include Collagen, Elastin, α -Keratin, and Tropomyosin	50
Distribution of Collagen in Humans	50
Amino Acid Composition of Collagen	50
Amino Acid Sequence of Collagen	50
Structure of Collagen	52
Formation of Covalent Cross-links in Collagen	54
Elastin Is a Fibrous Protein with Allysine-Generated Cross-links	54
α -Keratin and Tropomyosin	55
Lipoproteins Are Complexes of Lipids with Proteins	56
Glycoproteins Contain Covalently Bound Carbohydrate	60
Types of Carbohydrate-Protein Covalent Linkages	61
2.7 Folding of Proteins from Randomized to Unique Structures: Protein Stability	62
The Protein Folding Problem: A Possible Pathway	62
Chaperone Proteins May Assist the Protein Folding Process	63
Noncovalent Forces Lead to Protein Folding and Contribute to a Protein's Stability	63
Hydrophobic Interaction Forces	64
Hydrogen Bonds	66
Electrostatic Interactions	66
Van der Waals-London Dispersion Forces	66
Denaturation of Proteins Leads to Loss of Native Structure	67
2.8 Dynamic Aspects of Protein Structure	68
2.9 Methods for Characterization, Purification, and Study of Protein Structure and Organization	69
Separation of Proteins on Basis of Charge	69
Capillary Electrophoresis	70
Separation of Proteins Based on Molecular Mass or Size	71
Ultracentrifugation: Definition of Svedberg Coefficient	71
Molecular Exclusion Chromatography	72

Polyacrylamide Gel Electrophoresis in the Presence of a Detergent	72
HPLC Chromatographic Techniques Separate Amino Acids, Peptides, and Proteins	72
Affinity Chromatography	73
General Approach to Protein Purification	73
Determination of Amino Acid Composition of a Protein	74
Techniques to Determine Amino Acid Sequence of a Protein	74
X-Ray Diffraction Techniques Are Used to Determine the Three-Dimensional Structure of Proteins	76
Various Spectroscopic Methods Are Employed in Evaluating Protein Structure and Function	79
Ultraviolet Light Spectroscopy	79
Fluorescence Spectroscopy	79
Optical Rotatory Dispersion and Circular Dichroism Spectroscopy	80
Nuclear Magnetic Resonance	81
Bibliography	82
Questions and Answers	83
Clinical Correlations	
2.1 Plasma Proteins in Diagnosis of Disease	37
2.2 Differences in Primary Structure of Insulins used in Treatment of Diabetes Mellitus	41
2.3 A Nonconservative Mutation Occurs in Sickle Cell Anemia	42
2.4 Symptoms of Diseases of Abnormal Collagen Synthesis	50
2.5 Hyperlipidemias	56
2.6 Hypolipoproteinemias	59
2.7 Glycosylated Hemoglobin, HbA _{1c}	62
2.8 Use of Amino Acid Analysis in Diagnosis of Disease	74

2.1—

Functional Roles of Proteins in Humans

Proteins perform a surprising variety of essential functions in mammalian organisms. These may be grouped into dynamic and structural. Dynamic functions include transport, metabolic control, contraction, and catalysis of chemical transformations. In their structural functions, proteins provide the matrix for bone and connective tissue, giving structure and form to the human organism.

An important class of dynamic proteins are the enzymes. They catalyze chemical reactions, converting a substrate to a product at the enzyme's active site. Almost all of the thousands of chemical reactions that occur in living organisms require a specific enzyme catalyst to ensure that reactions occur at a rate compatible with life. The character of any cell is based on its particular chemistry, which is determined by its specific enzyme composition. Genetic traits are expressed through synthesis of enzymes, which catalyze reactions that establish the phenotype. Many genetic diseases result from altered levels of enzyme production or specific alterations to their amino acid sequence. Transport is another major function for proteins. Particular examples discussed in greater detail in this text are hemoglobin and myoglobin, which transport oxygen in blood and in muscle, respectively. Transferrin transports iron in blood. Transport proteins bind and carry steroid hormones in blood from their site of synthesis to their site of action. Many drugs and toxic compounds are transported bound to proteins. Proteins participate in contractile mechanisms. Myosin and actin function in muscle contraction.

Proteins have a protective role through a combination of dynamic functions. Immunoglobulins and interferon are proteins that protect the human against bacterial or viral infection. Fibrin stops the loss of blood on injury to the vascular system.

Many hormones are proteins or peptides. Protein hormones include insulin, thyrotropin, somatotropin (growth hormone), luteinizing hormone, and follicle-stimulating hormone. Many diverse polypeptide hormones have a low molecular weight (<5000) and are referred to as peptides. In general, the term **protein** is used for molecules composed of over 50 amino acids and the term **peptide** is used for molecules of less than 50 amino acids. Important peptide hormones include adrenocorticotropin hormone, antidiuretic hormone, glucagon, and calcitonin.

Proteins control and regulate gene transcription and translation. These include histones that are closely associated with DNA, repressor and enhancer transcription factors that control gene transcription, and proteins that form a part of the heteronuclear RNA particles and ribosomes.

Structural proteins function in "brick-and-mortar" roles. They include collagen and elastin, which form the matrix of bone and ligaments and provide structural strength and elasticity to organs and the vascular system. α -Keratin forms the structure of epidermal tissue.

An understanding of both the normal functioning and the pathology of the mammalian organism requires a clear understanding of the properties of the proteins.

2.2—

Amino Acid Composition of Proteins

Proteins Are Polymers of α -Amino Acids

It is notable that all the different types of proteins are initially synthesized as polymers of only 20 amino acids. These **common amino acids** are defined as those for which at least one specific codon exists in the DNA genetic code. There are 20 amino acids for which DNA codons are known. Transcription and translation of the DNA code result in polymerization of amino acids into a specific linear sequence characteristic of a protein (Figure 2.1). In addition to the common amino acids, proteins may contain **derived amino acids**, which are usually formed by an enzyme-facilitated reaction on a common amino acid after that amino acid has been incorporated into a protein structure. Examples of derived amino acids are cystine (see p. 30), desmosine and isodesmosine found in elastin, hydroxyproline and hydroxylysine found in collagen, and γ -carboxyglutamate found in prothrombin.

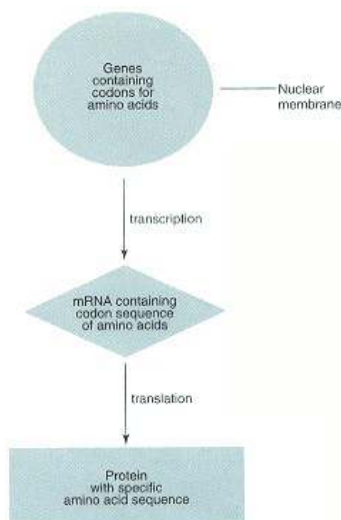

Figure 2.1
Genetic information is transcribed from a DNA sequence into mRNA and then translated to the amino acid sequence of a protein.

Common Amino Acids Have a General Structure

Common amino acids have the general structure depicted in Figure 2.2. They contain in common a central **alpha (α)-carbon** atom to which a carboxylic acid group, an amino group, and a hydrogen atom are covalently bonded. In addition, the α -carbon atom is bound to a specific chemical group, designated R and called the side chain, that uniquely defines each of the 20 common amino acids. Figure 2.2 depicts the ionized form of a common amino acid in solution at pH 7. The α -amino group is protonated and in its ammonium ion form; the carboxylic acid group is in its unprotonated or carboxylate ion form.

Side Chains Define Chemical Nature and Structures of Different Amino Acids

Structures of the common amino acids are shown in Figure 2.3. Alkyl amino acids have alkyl group side chains and include glycine, alanine, valine, leucine, and isoleucine. **Glycine** has the simplest structure, with R = H. **Alanine** contains a methyl (CH_3) side chain group. **Valine** has an isopropyl R group (Figure 2.4). The leucine and isoleucine R groups are butyl groups that are structural isomers of each other. In **leucine** the branching in the isobutyl side chain occurs on the **gamma (γ)-carbon** of the amino acid. In **isoleucine** it is branched at the **beta (β)-carbon**.

The aromatic amino acids are phenylalanine, tyrosine, and tryptophan. The **phenylalanine** R group contains a benzene ring, **tyrosine** contains a phenol group, and the **tryptophan** R group contains the heterocyclic structure, indole.

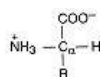

Figure 2.2
General structure of the common amino acids.

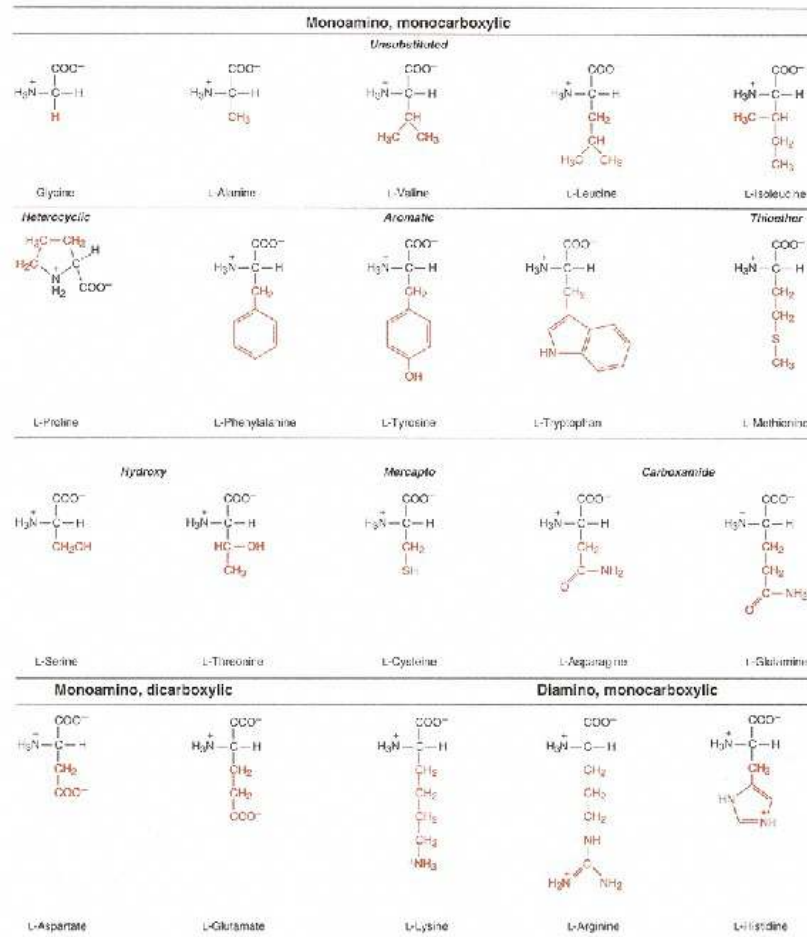

Figure 2.3
Structures of the common amino acids. Charge forms are those present at pH 7.0.

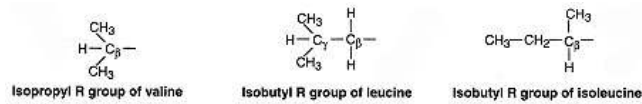

Figure 2.4
Alkyl side chains of valine, leucine, and isoleucine.

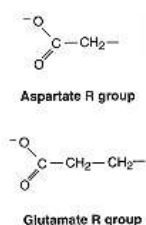

Figure 2.5
Side chains
of aspartate
and glutamate.

In each case the aromatic moiety is attached to the α -carbon through a methylene ($-\text{CH}_2-$) carbon (Figure 2.3).

Sulfur-containing common amino acids are cysteine and methionine. The **cysteine** side chain group is a thiomethyl (HSCH_2-). In **methionine** the side chain is a methyl ethyl thiol ether ($\text{CH}_3\text{SCH}_2\text{CH}_2-$).

There are two hydroxy (alcohol)-containing common amino acids, serine and threonine. The **serine** side chain is a hydroxymethyl (HOCH_2-). In **threonine** an ethanol structure is connected to the α -carbon through the carbon containing the hydroxyl substituent, resulting in a secondary alcohol structure ($\text{CH}_3-\text{CHOH}-\text{CH}_\alpha-$).

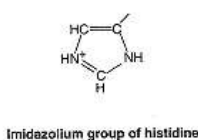
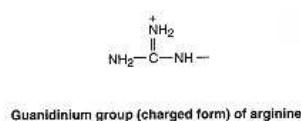

Figure 2.6
Guanidinium and imidazolium groups
of arginine and histidine.

The **proline** side chain is unique in that it incorporates the α -amino group. Thus proline is more accurately classified as an α -imino acid, since its α -amine is a secondary amine with its α -nitrogen having two covalent bonds to carbon (to the α -carbon and side chain carbon), rather than a primary amine. Incorporation of the α -amino nitrogen into a five-membered ring constrains the rotational freedom around the $-\text{N}_\alpha-\text{C}_\alpha-$ bond in proline to a specific rotational angle, which limits participation of proline in polypeptide chain conformations.

TABLE 2.1 Abbreviations for the Amino Acids

Amino Acid	Abbreviation	
	Three Letter	One Letter
Alanine	Ala	A
Arginine	Arg	R
Asparagine	Asn	N
Aspartic	Asp	D
Asparagine or aspartic	Asx	B
Cysteine	Cys	C
Glycine	Gly	G
Glutamine	Gln	Q
Glutamic	Glu	E
Glutamine or glutamic	Glx	Z
Histidine	His	H
Isoleucine	Ile	I
Leucine	Leu	L
Lysine	Lys	K
Methionine	Met	M
Phenylalanine	Phe	F
Proline	Pro	P
Serine	Ser	S
Threonine	Thr	T
Tryptophan	Trp	W
Tyrosine	Tyr	Y
Valine	Val	V

The amino acids discussed so far contain side chains that are uncharged at physiological pH. The **dicarboxylic monoamino acids** contain a carboxylic group in their side chain. **Aspartate** contains a carboxylic acid group separated by a methylene carbon ($-\text{CH}_2-$) from the α -carbon (Figure 2.5). In **glutamate** (Figure 2.5), the carboxylic acid group is separated by two methylene ($-\text{CH}_2-\text{CH}_2-$) carbon atoms from the α -carbon (Figure 2.2). At physiological pH, side chain carboxylic acid groups are unprotonated and negatively charged. **Dibasic monocarboxylic acids** include lysine, arginine, and histidine (Figure 2.3). In these structures, the R group contains one or two nitrogen atoms that act as a base by binding a proton. The **lysine** side chain is a *N*-butyl amine. In **arginine**, the side chain contains a guanidino group (Figure 2.6) separated from the α -carbon by three methylene carbon atoms. Both the guanidino group of arginine and the ϵ -amino group of lysine are protonated at physiological pH (pH~7) and in their charged form. In **histidine** the side chain contains a five-membered heterocyclic structure, the imidazole (Figure 2.6). The $\text{p}K_a$ of the imidazole group is approximately 6.0 in water; physiological solutions contain relatively high concentrations of both basic (imidazole) and acidic (imidazolium) forms of the histidine side chain (see Section 2.3).

The last two common amino acids are glutamine and asparagine. They contain an amide moiety in their side chain. **Glutamine** and **asparagine** are structural analogs of glutamic acid and aspartic acid with their side chain carboxylic acid groups amidated. Unique DNA codons exist for glutamine and asparagine separate from those for glutamic acid and aspartic acid. The amide side chains of glutamine and asparagine cannot be protonated and are uncharged at physiological pH.

In order to represent the sequence of amino acids in a protein, three-letter and one-letter abbreviations for the common amino acids have been established (Table 2.1). These abbreviations are universally accepted and will be used

throughout the book. The three-letter abbreviations of aspartic acid (Asp) and glutamic acid (Glu) should not be confused with those for asparagine (Asn) and glutamine (Gln). In experimentally determining the amino acids of a protein by chemical procedures, one cannot easily differentiate between Asn and Asp, or between Gln and Glu, because the side chain amide groups in Asn and Gln are hydrolyzed and generate Asp and Glu (see Section 2.9). In these cases, the symbols of Asx for Asp or Asn, and Glx for Glu or Gln indicate this ambiguity. A similar scheme is used with the one-letter abbreviations to symbolize Asp or Asn, and Glu or Gln.

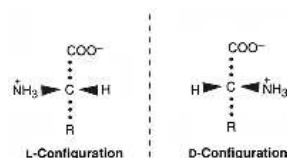

Figure 2.7
Absolute configuration of an amino acid.

Amino Acids Have an Asymmetric Center

The common amino acids with the general structure in Figure 2.2 have four substituents (R, H, COO⁻, NH₃⁺) covalently bonded to the α-carbon atom in the α-amino acid structure. A carbon atom with four different substituents arranged in a tetrahedral configuration is asymmetric and exists in two enantiomeric forms. Thus each of the amino acids exhibits optical isomerism except glycine, in which R = H and thus two of the four substituents on the α-carbon atom are hydrogen. The absolute configuration for an amino acid is depicted in Figure 2.7 using the Fischer projection to show the direction in space of the tetrahedrally arranged α-carbon substituents. The α-COO⁻ group is directed up and behind the plane of the page, and the R group is directed down and behind the plane of the page. The α-H and α-NH₃⁺ groups are directed toward the reader. An amino acid held in this way projects its α-NH₃⁺ group either to the left or right of the α-carbon atom. By convention, if the α-NH₃⁺ is projected to the left, the amino acid has an L absolute configuration. Its optical enantiomer, with α-NH₃⁺ projected toward the right, has a D absolute configuration. In mammalian proteins only amino acids of L configuration are found. The L and D designations refer to the ability to rotate polarized light to the left (L, levo) or right (D, dextro) from its plane of polarization. As the amino acids in proteins are asymmetric, the proteins that contain them also exhibit asymmetric properties.

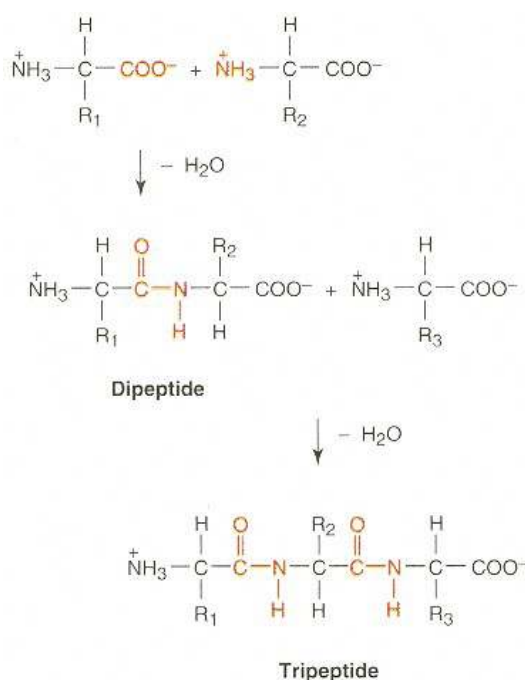

Figure 2.8
Peptide bond formation.

Amino Acids Are Polymerized into Peptides and Proteins

Polymerization of the 20 common amino acids into polypeptide chains in cells is catalyzed by enzymes and is associated with the ribosomes (Chapter 15). Chemically, this polymerization is a dehydration reaction (Figure 2.8). The α-carboxyl group of an amino acid with side chain R₁ forms a covalent **peptide bond** with the α-amino group of the amino acid with side chain R₂ by elimination of a molecule of water. The **dipeptide** (two amino acid residues joined by a single peptide bond) can then form a second peptide bond through its terminal carboxylic acid group and the α-amino of a third amino acid (R₃), to generate a tripeptide (Figure 2.8). Repetition of this process generates a **polypeptide** or protein of specific amino acid sequence (R₁-R₂-R₃-R₄···R_n). The amino acid sequence of the polypeptide chains is the **primary structure** of the protein, and it is predetermined by the DNA sequence of its gene (Chapter 14). It is the unique primary structure that enables a polypeptide chain to fold into a specific three-dimensional structure that gives the protein its chemical and physiological properties.

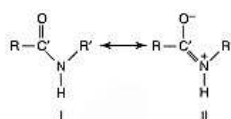
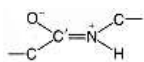

Figure 2.9
Electronic isomer structures of a peptide bond.

A peptide bond can be represented using two **resonance isomers** (Figure 2.9). In structure I, a double bond is located between the carbonyl carbon and carbonyl oxygen (C=O), and the carbonyl carbon to nitrogen (C-N) linkage is a single bond. In structure II, the carbonyl carbon to oxygen bond (C-O⁻) is a single bond and the bond located between the carbonyl carbon and nitrogen is a double bond (C=N⁺). In structure II there is a negative charge on the oxygen and a positive charge on the nitrogen. Actual peptide bonds are a

resonance hybrid of these two electron isomer structures, the carbonyl carbon to nitrogen bond having a 50% double-bond character. The hybrid bond is supported by spectroscopic measurements and X-ray diffraction studies, the latter showing that the carbonyl carbon to nitrogen peptide bond length (1.33 Å) is approximately half-way between that found for a C–N single bond (~1.45 Å) and a C=N double bond (~1.25 Å).

A consequence of this partial double-bond character is that, as for normal double-bond structures, rotation does not occur about the carbonyl carbon to nitrogen of a peptide bond at physiological temperatures. Also, a consequence of the C=N double-bond's chemistry is that the atoms attached to C and N



all lie in a common plane. Thus a polypeptide chain is a polymer of peptide-bond planes interconnected at the α -carbon atoms. The α -carbon interconnects peptide bonds through single bonds that allow rotation of adjacent peptide planes with respect to each other. Each **amino acid residue** contributes one α -carbon (two single bonds and a peptide bond, Figure 2.10) to the polypeptide chain. The term residue refers to the atoms contributed by an amino acid to a polypeptide chain including the atoms of the side chain.

The peptide bond in Figure 2.11a shows a **trans configuration** between the oxygen (O) and the hydrogen (H) atoms of the peptide bond. This is the most stable configuration for the peptide bond with the two side chains (R and R') also in *trans*. The **cis configuration** (Figure 2.11b) brings the two side chain groups to the same side of the C=N bond, where unfavorable repulsive steric forces occur between the two side chain (R) groups. Accordingly, *trans*-peptide bonds are always found in proteins except where there are proline residues. In proline the side chain is linked to its α -amino group, and the *cis*- and *trans*-peptide bonds with the proline α -imino group have near equal energies. The configuration of the peptide bond actually found for a proline in a protein will depend on the specific forces generated by the unique folded three-dimensional structure of the protein molecule.

One of the largest natural polypeptide chains in humans is that of apolipo-protein B-100, which contains 4536 amino acid residues in one polypeptide chain. Chain length alone, however, does not determine the function of a polypeptide. Many small peptides with less than ten amino acids perform important biochemical and physiological functions in humans (Table 2.2). Primary structures are written in a standard convention and sequentially numbered from their NH₂-terminal end toward their COOH-terminal end, consistent with the order of addition of the amino acid to the chain during biosynthesis. Accordingly, for thyrotropin-releasing hormone (Table 2.2) the glutamic acid residue written on the left is the NH₂-terminal amino acid of the tripeptide and is designated amino acid residue 1 in the sequence. The proline is the COOH-terminal amino acid and is designated residue 3. The defined direction of the polypeptide chain is from Glu to Pro (NH₂-terminal amino acid to COOH-terminal amino acid).

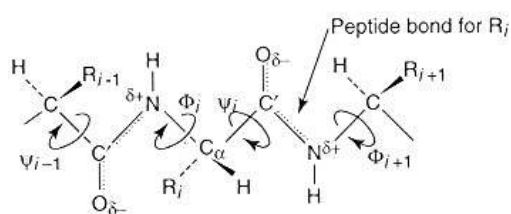
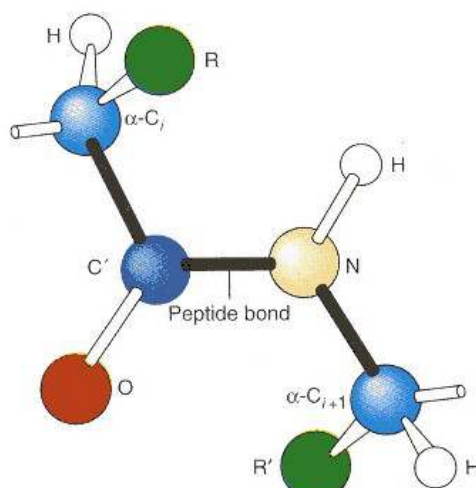

Figure 2.10

Amino acid residue.

Each amino acid residue of a polypeptide contributes two single bonds and one peptide bond to the chain. The single bonds are those between the C α and carbonyl C' atoms, and the C α and N atoms. See p. 43 for definition of ϕ and ψ .



(a) *trans* configuration

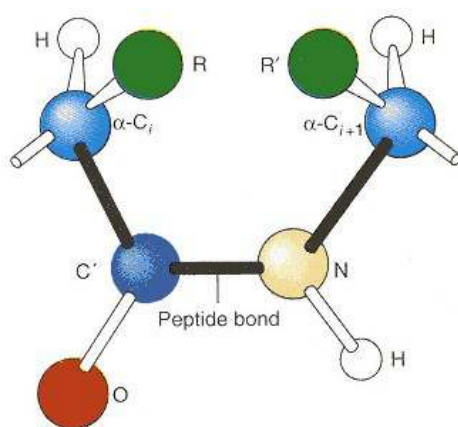

(b) *cis* configuration

Figure 2.11

(a) *Trans*-peptide bond and (b) the rare *cis*-peptide bond.

The C'-N have a partial double-bond character.

TABLE 2.2 Some Examples of Biologically Active Peptides

Amino Acid Sequence	Name	Function
1 3 pyroGlu-His-Pro(NH ₂) ^a	Thyrotropin-releasing hormone	Secreted by hypothalamus; causes anterior pituitary gland to release thyrotropic hormone
1 9 H-Cys-Tyr-Phe-Gln-Asn-Cys-Pro-Arg-Gly(NH ₂) ^b S S	Vasopressin (antidiuretic hormone)	Secreted by posterior pituitary gland; causes kidney to retain water from urine
1 5 H-Tyr-Gly-Gly-Phe-Met-OH	Methionine enkephalin	Opiate-like peptide found in brain that inhibits sense of pain
1 10 pyroGlu-Gly-Pro-Trp-Leu-Glu-Glu-Glu-Glu-Glu- 11 17 Ala-Tyr-Gly-Trp-Met-Asp-Phe(NH ₂) ^{a,c} SO ₃	Little gastrin (human)	Hormone secreted by mucosal cells in stomach; causes parietal cells of stomach to secrete acid
1 10 H-His-Ser-Gln-Gly-Thr-Phe-Thr-Ser-Asp-Tyr-	Glucagon (bovine)	Pancreatic hormone involved in regulating glucose metabolism
11 20 Ser-Lys-Tyr-Leu-Asp-Ser-Arg-Arg-Ala-Gln-		
21 29 Asp-Phe-Val-Gln-Trp-Leu-Met-Asn-Thr-OH		
1 8 H-Asp-Arg-Val-Tyr-Ile-His-Pro-Phe-OH	Angiotensin II (horse)	Pressor or hypertensive peptide; also stimulates release of aldosterone from adrenal cortex
1 9 H-Arg-Pro-Gly-Phe-Ser-Pro-Phe-Arg-OH	Plasma bradykinin (bovine)	Vasodilator peptide
1 10 H-Arg-Pro-Lys-Pro-Gln-Phe-Phe-Gly-Leu-Met(NH ₂)	Substance P	Neurotransmitter

^a The NH₂ terminal Glu is in the pyro form in which its -COOH is covalently joined to its -NH₂ via amide linkage; the COOH terminal amino acid is amidated and thus also not free.

^b Cysteine-1 and cysteine-6 are joined to form a disulfide bond structure within the nonapeptide.

^c The Tyr 12 is sulfonated on its phenolic side chain OH.

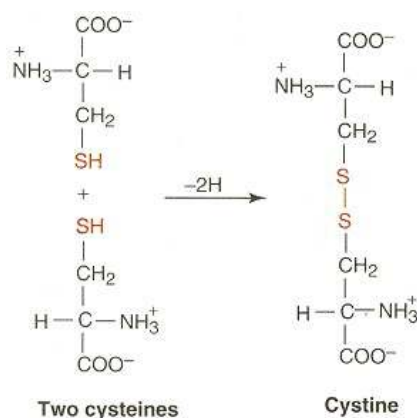

Figure 2.12
Cystine bond formation.

Cystine Is a Derived Amino Acid

A derived amino acid found in many proteins is cystine. It is formed by the oxidation of two cysteine thiol side chains, joined to form a disulfide covalent bond (Figure 2.12). Within proteins disulfide links of cystine formed from cysteines, separated from each other in the primary structure, have an important role in stabilizing the folded conformation of proteins.



2.3—

Charge and Chemical Properties of Amino Acids and Proteins

Ionizable Groups of Amino Acids and Proteins Are Critical for Biological Function

Ionizable groups common to proteins and amino acids are shown in Table 2.3. The acid forms are on the left of the equilibrium sign and the base forms on the right side. In forming its conjugate base, the acid form releases a proton. In reverse, the base form associates with a proton to form the respective acid. The proton dissociation of an acid is characterized by an acid **dissociation constant** pK'_a depends on the environment in which an acid group is placed. For example, when a

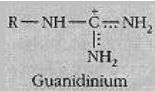
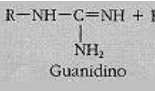
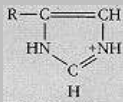
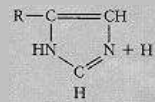
TABLE 2.3 Characteristic pK_a Values for the Common Acid Groups in Proteins

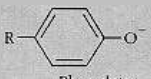
Where Acid Group Is Found	Acid Form		Base Form	Approximate pK_a Range for Group
NH ₂ -terminal residue in peptides, lysine	R-NH ₃ ⁺ Ammonium	⇌	R-NH ₂ + H ⁺ Amine	7.6–10.6
COOH-terminal residue in peptides, glutamate, aspartate	R-COOH Carboxylic acid	⇌	R-COO ⁻ + H ⁺ Carboxylate	3.0–5.5
Arginine	 Guanidinium	⇌	 Guanidino	11.5–12.5
Cysteine	R-SH Thiol	⇌	R-S ⁻ + H ⁺ Thiolate	8.0–9.0
Histidine	 Imidazolium	⇌	 Imidazole	6.0–7.0
Tyrosine	 Phenol	⇌	 Phenolate	9.5–10.5

positive-charged ammonium group ($-NH_3^+$) is placed near a negatively charged group within a protein, the negative charge stabilizes the positively charged acid form of the amino group, making it more difficult to dissociate its proton. The pK_a values are called **acidic amino acids**. They are predominantly in their unprotonated forms and are negatively charged at physiological pH. Proteins in which the ratio (Lys + Arg)/(Glu + Asp) is greater than 1 are referred to as **basic proteins**. Proteins in which the above ratio is less than 1 are referred to as **acidic proteins**.

TABLE 2.4 pK_a of Side Chain and Terminal Acid Groups in Protein Ribonuclease

	$-NH_3^+$	$-COOH$
Side chain	Lysines \approx 4.6	
Chain end	N-terminal = 7.8	C-terminal = 3.8

Ionic Form of an Amino Acid or Protein Can Be Determined at a Given pH

$$\text{pH} = \text{p}K_a + \log \frac{[\text{conjugate base}]}{[\text{conjugate acid}]}$$

or

$$\text{pH} - \text{p}K_a = \log \frac{[\text{conjugate base}]}{[\text{conjugate acid}]}$$

Figure 2.13

Henderson–Hasselbalch equation.

For a more detailed discussion of this equation, see p. 9.

From a knowledge of the $\text{p}K_a'$ and the ratio of [imidazole]/[imidazolium] is 10:1 (Table 2.5). Based on this ratio, the enzyme exhibits $10/(10 + 1) \times 100 = 91\%$ of its maximum potential activity. Thus a change in pH has a dramatic effect on the enzyme's activity. Most protein activities demonstrate similar pH dependency due to their acid and base group(s).

Titration of a Monoamino Monocarboxylic Acid:

Determination of the Isoelectric pH

An understanding of a protein's acid and base forms and their relation to charge is made more clear by following the titration of the ionizable groups for a simple amino acid. As presented in Figure 2.14, leucine contains an $\alpha\text{-COOH}$ with $\text{p}K_a' = 9.6$. At pH 1.0 the predominant ionic form (form I) has a charge of +1 and migrates toward the cathode in an

TABLE 2.5 Relationship Between the Difference of pH and Acid $\text{p}K_a'$ and the Ratio of the Concentrations of Base to Its Conjugate Acid

$\text{pH} - \text{p}K_a'$ (Difference Between pH and $\text{p}K_a'$)	Ratio of Concentration of Base to Conjugate Acid
0	1
1	10
2	100
3	1000
-1	0.1
-2	0.01
-3	0.001

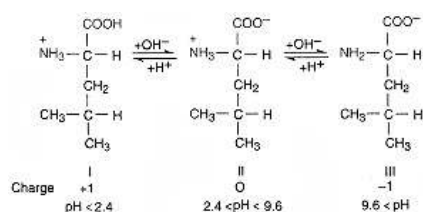

Figure 2.14

Ionic forms of leucine.

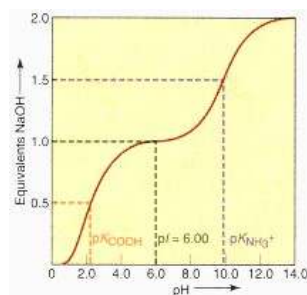

Figure 2.15
Titration curve of leucine.

electrical field. The addition of 0.5 equivalent of base half-titrates the α -COOH group of the leucine; that is, the ratio of $[\text{COO}^-]/[\text{COOH}]$ will equal 1. The Henderson–Hasselbalch equation, with the second term on the right side of the equation $\log_{10}[(\text{base})/(\text{acid})] = \log_{10}[1] = 0$ at a ratio of conjugate base to acid of 1 : 1, shows that the pH (when the α -COOH is half-titrated) is directly equal to the $\text{p}K_{\text{a}(\alpha\text{-COOH})}$ (Figure 2.15).

Addition of 1 equivalent of base completely titrates the α -COOH but leaves the α - NH_3^+ group intact. In the resulting form (II), the negatively charged α - COO^- and positively charged α - NH_3^+ cancel each other and the net charge of this ionic form is zero. Form II is thus the **zwitterion** form, that is, the ionic form in which the total of positive charges is exactly equal to the total of the negative charges. As the net charge on a zwitterion molecule is zero, it will not migrate toward either the cathode or anode in an electric field. Further addition of 0.5 equivalent of base to the zwitterion form of leucine (total base added is 1.5 equivalents) will then half-titrate the α - NH_3^+ group. At this point in the titration, the ratio of $[\text{NH}_2]/[\text{NH}_3^+] = 1$, and the pH is equal to the value of the $\text{p}K_{\text{a}}$ for the α - NH_3^+ group (Figure 2.15). Addition of a further 0.5 equivalent of base (total of 2 full equivalents of base added; Figure 2.15) completely titrates the α - NH_3^+ group to its base form (α - NH_2). The solution pH is greater than 11, and the predominant molecular species has a negative charge of -1 (form III).

It is useful to calculate the exact pH at which an amino acid is electrically neutral and in its zwitterion form. This pH is known as the **isoelectric pH** for the molecule, and the symbol is **pI**. The pI value is a constant of a compound at a particular ionic strength and temperature. For simple molecules, such as leucine, pI is directly calculated as the average of the two $\text{p}K_{\text{a}}$ values that regulate the boundaries of the zwitterion form. Leucine has two ionizable groups that regulate the zwitterion form boundaries, and the pI is calculated as follows:

$$\text{pI} = \frac{\text{p}K_{\text{a}}(\text{COOH}) + \text{p}K_{\text{a}}(\text{NH}_3^+)}{2} = \frac{2.4 + 9.6}{2} = 6.0$$

At $\text{pH} > 6.0$, leucine assumes a partial negative charge that formally rises at high pH to a full negative charge of -1 (form III) (Figure 2.14). At $\text{pH} < 6$, leucine has a partial positive charge until at very low pH it has a charge of $+1$ (form I) (Figure 2.14). The partial charge at any pH can be calculated from the Henderson–Hasselbalch equation or from extrapolation from the titration curve of Figure 2.15.

Titration of a Monoamino Dicarboxylic Acid

A more complicated example of the relationship between molecular charge and pH is provided by glutamic acid. Its ionized forms and titration curve are

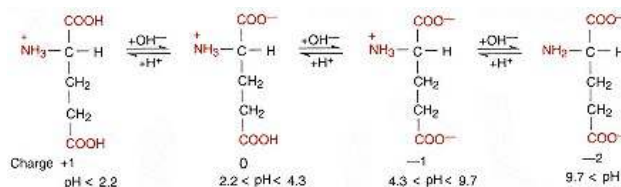

Figure 2.16
Ionic forms of glutamic acid.

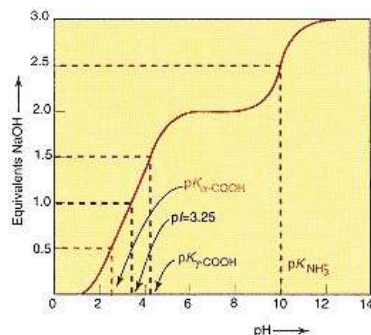

Figure 2.17
Titration curve of glutamic acid.

shown in Figures 2.16 and 2.17. In glutamic acid the α -COOH pK'_a values that control the boundaries of the zwitterion form:

$$pI = \frac{2.2 + 4.3}{2} = 3.25$$

Accordingly, at values above pH 3.25 the molecule assumes a net negative charge until at high pH the molecule has a net charge of -2 . At pH < 3.25 glutamic acid is positively charged, and at extremely low pH it has a net positive charge of $+1$.

General Relationship between Charge Properties of Amino Acids and Proteins and pH

Analysis of charge forms present in other common amino acids shows that the relationship observed between pH and charge for leucine and glutamate is generally true. That is, at a solution pH less than pI , the amino acid is positively charged. At a solution pH greater than pI , the amino acid is negatively charged. The degree of positive or negative charge is a function of the magnitude of the difference between pH and pI . As a protein is a complex polyelectrolyte containing multiple ionizable acid groups that regulate the boundaries of its zwitterion form, calculation of a protein's isoelectric pH from its acid pK'_a values utilizing the Henderson–Hasselbalch relationship would be difficult. Accordingly, the pI values for proteins are always experimentally measured by determining the pH value at which the protein does not move in an electrical field. pI values for some representative proteins are given in Table 2.6.

TABLE 2.6 pI Values for Some Representative Proteins

Protein	pI
Pepsin	~ 1
Human serum albumin	5.9
α_1 -Lipoprotein	5.5
Fibrinogen	5.8
Hemoglobin A	7.1
Ribonuclease	7.8
Cytochrome-c	10.0
Thymohistone	10.6

pH > pI, then protein charge negative
 pH < pI, then protein charge positive

Figure 2.18
 Relationship between solution
 pH, protein pI, and protein charge.

As with the amino acids, at a pH greater than the pI, a protein has a net negative charge. At a pH less than the pI, a protein has a net positive charge (Figure 2.18). The magnitude of the net charge of a protein increases as the difference between pH and pI increases. An example is human plasma albumin with 585 amino acid residues of which there are 61 glutamates, 36 aspartates, 57 lysines, 24 arginines, and 16 histidines. The titration curve for this complex molecule is shown in Figure 2.19. Albumin's pI = 5.9, at which pH its net charge is zero. At pH 7.5 the imidazolium groups of histidines have been partially titrated and albumin has a negative charge of -10. At pH 8.6 additional groups have been titrated to their base forms, and the net charge is approximately -20. At pH 11 the net charge is approximately -60. On the acid side of the pI value, at pH 3, the approximate net charge of albumin is +60.

Amino Acids and Proteins Can Be Separated Based on pI Values

The techniques of electrophoresis, isoelectric focusing, and ion-exchange chromatography separate and characterize biological molecules on the basis of differences in their pI (see p. 34). In clinical medicine, separation of plasma proteins by electrophoresis has led to the classification of the proteins based on their relative electrophoretic mobility. The separation is commonly carried out at pH 8.6, which is higher than the pI values of the major plasma proteins.

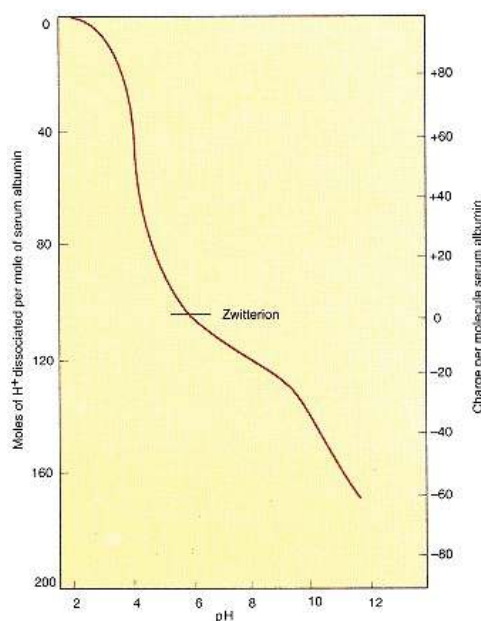

Figure 2.19
 Titration curve of human serum albumin at 25°C and an
 ionic strength of 0.150.
 Redrawn from Tanford, C. *J. Am. Chem. Soc.* 72:441, 1950.

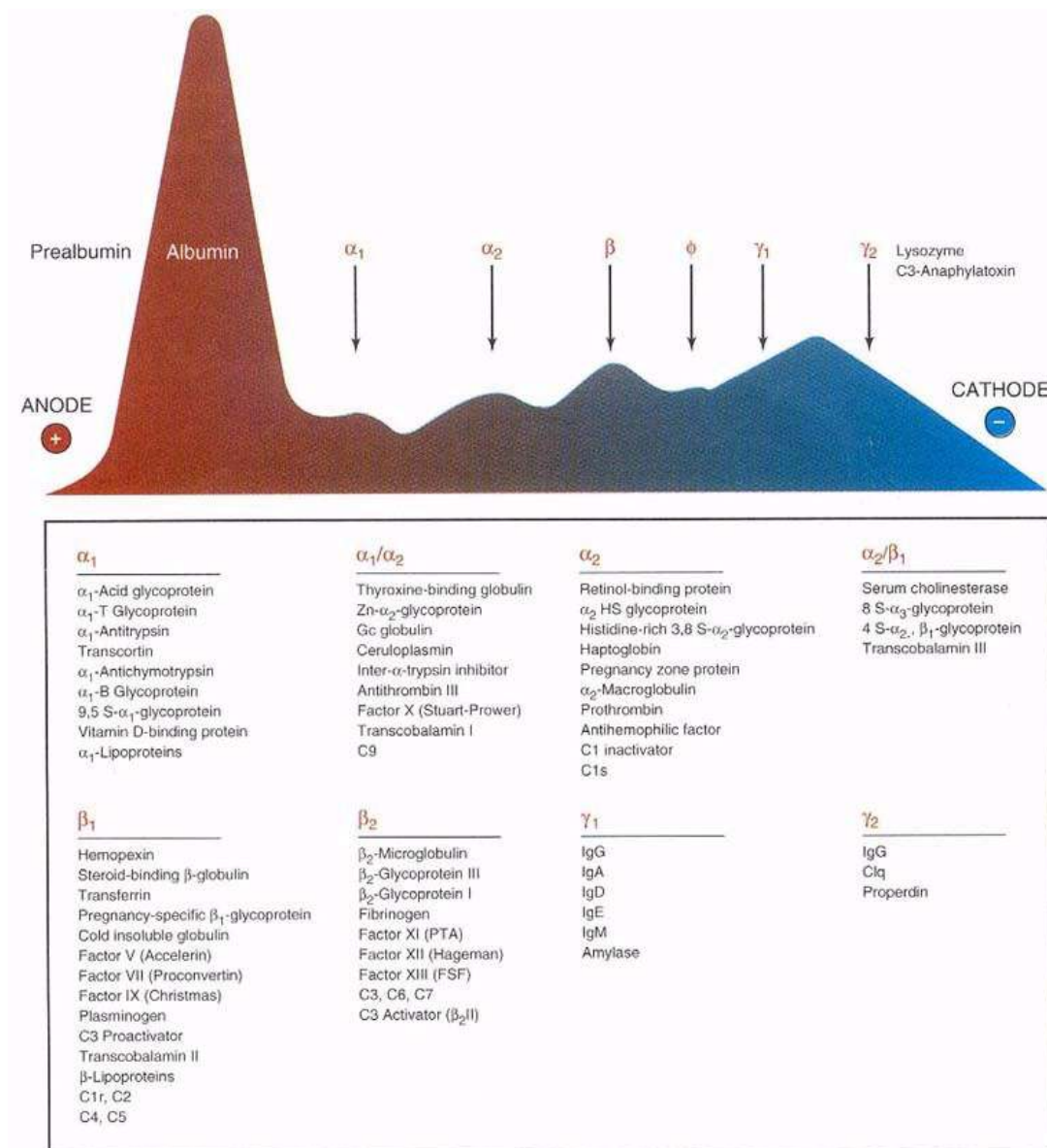

Figure 2.20
Electrophoresis pattern for plasma proteins at pH 8.6.

Plot shows the order of migration along the horizontal axis with proteins of highest mobility closest to the anode. Height of the band along the vertical axis shows the protein concentration. Different major proteins are designated underneath their electrophoretic mobility peaks.

Reprinted with permission from Heide, K., Haupt, H., and Schwick, H. G. In: F. W. Putnam (Ed.), *The Plasma Proteins*, 2nd ed., Vol. III. New York Academic Press, 1977, p. 545.

Accordingly, the proteins are negatively charged and move toward the anode at a rate dependent on their net charge. Major peaks observed in order of their migration are those of albumin, α_1 , α_2 , and β -globulins, fibrinogen, and the γ_1 and γ_2 -globulins (Figure 2.20). Some of these peaks represent tens to hundreds of different plasma proteins that have a similar migration rate at pH 8.6. However, certain proteins predominate in each peak and variation in their relative amounts is characteristic of certain diseases (Figures 2.20 and 2.21; see Clin. Corr. 2.1).

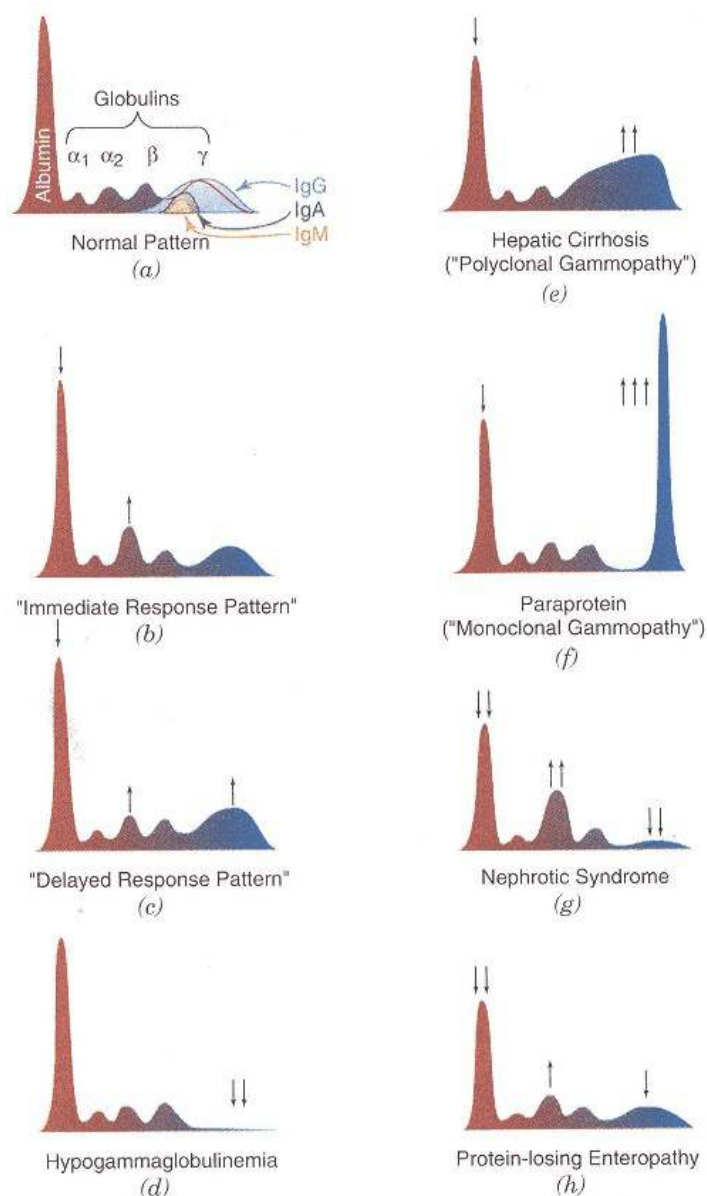

Figure 2.21
Examples of the electrophoretic mobility patterns observed for a normal individual and patients with abnormal concentrations of serum proteins, analyzed by agarose gel electrophoresis.

Redrawn from McPherson, R. A. Specific proteins. In: J. B. Henry (Ed.), *Clinical Diagnosis and Management*, 17th ed. Philadelphia: Saunders Co, 1984.

CLINICAL CORRELATION 2.1

Plasma Proteins in Diagnosis of Disease

Electrophoretic analysis of the plasma proteins is commonly used in diagnosis of disease. Electrophoresis of plasma buffered at pH 8.6 separates the major plasma proteins as they migrate to the anode in the electric field into bands or peaks, based on their charge differences (see text). Examples of abnormal electrophoresis patterns are shown in Figure 2.21. An "immediate response" that occurs with stress or inflammation caused by infection, injury, or surgical trauma is shown in pattern (b) in which haptoglobins in the α₂ mobility band are selectively increased. A "late response" shown in pattern (c) is correlated with infection and shows an increase in the γ-globulin peaks due to an increase in immunoglobulins. An example of a hypogammaglobulinemia due to an immunosuppressive disease is shown in pattern (d). In hepatic cirrhosis there is a broad elevation of the τ-globulins with reduction of albumin, as in pattern (e). Monoclonal gammopathies are due to the clonal synthesis of a unique immunoglobulin and give rise to a sharp τ-globulin band, as in pattern (f). Nephrotic syndrome shows a selective loss of lower molecular weight proteins from plasma, as in pattern (g). The pattern shows a decrease in albumin (65 kDa), but a retention of the bands composed of the higher molecular weight proteins α₂-macroglobulin (725 kDa) and β₂-lipoproteins (2000 kDa) in the α₂ band. Pattern (h) is from a patient with a protein-losing enteropathy. The slight increase in the α₂-band in pattern (h) is due to an immediate or late response from a stressful stimulus, as previously observed in patterns (b) and (c).

Ritzmann, S. E., and Daniels, J. C. Serum protein electrophoresis and total serum proteins. In: S. E. Ritzmann and J. C. Daniels (Eds.), *Serum Protein Abnormalities, Diagnostic and Clinical Aspects*. Boston: Little, Brown and Co., 1975, pp. 3–25; and McPherson, R. A. Specific proteins. In: J. B. Henry (Ed.), *Clinical Diagnosis and Management by Laboratory Methods*, 17th ed. Philadelphia: Saunders, 1984, pp. 204–215.

Amino Acid Side Chains Have Polar or Apolar Properties

The relative **hydrophobicity** of amino acid side chains is critical for the folding of a protein to its native structure and for the stability of the folded protein. Figure 2.22 plots the values of relative hydrophobicity of the common amino acids based on the tendency of each amino acid to partition itself in a mixture of water and a nonpolar solvent. The scale is based on a value of zero for glycine. The side chains that preferentially dissolve in the nonpolar solvent relative to glycine show a positive (+) hydrophobicity value, the more positive the greater the preference for the nonpolar solvent. Most hydrophobic are those amino acids found buried in folded protein structures away from the water solvent that interacts with the surface of a soluble protein. However, the general correlation is not perfect due to the amphoteric nature of many of the hydrophobic amino acids that place the more polar portions of their side chain structure near the surface to interact with the polar solvent water on the outside. In addition, contrary to expectation, not all hydrophobic side chains are in a buried position in a folded three-dimensional structure of a globular protein. When on the surface, the hydrophobic groups are generally dispersed among the polar side chains. When clustering of nonpolar side chains occurs on the surface, it is usually associated with a function of the protein, such as to provide a site for binding of substrate molecules through hydrophobic interactions.

Most charged side chains are found on the surface of soluble globular proteins where they are stabilized by favorable energetic interactions with the water solvent. The rare positioning of a charged side chain in the interior of a globular protein usually implies an important functional role for that "buried" charge within the nonpolar interior in stabilizing conformation of the folded protein or participation in a catalytic mechanism.

Amino Acids Undergo a Variety of Chemical Reactions

Amino acids in proteins undergo a variety of chemical reactions with reagents that may be used to investigate the function of specific side chains. Some common chemical reactions are presented in Table 2.7. Reagents for amino acid side chain modification have also been synthesized that bind to specific sites in a folded protein's structure, like the substrate-binding site. The strategy

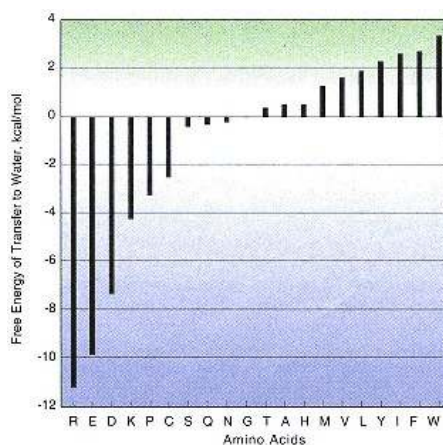

Figure 2.22

Relative hydrophobicity of the amino acid side chains.

Based on the partition of the amino acid between organic solvent and water. Negative values indicate preference for water and positive values preference for nonpolar solvent (ethanol or dioxane) relative to glycine (see text).

Based on data from Von Heijne, G., and Blomberg, C. *Eur. J. Biochem.* 97:175, 1979; and from Nozaki, Y., and Tanford, C. *J. Biol. Chem.* 246:2211, 1971.

TABLE 2.7 Some Chemical Reactions of the Amino Acids

Reactive Group	Reagent or Reaction	Product
Amine ($-\text{NH}_2$) groups	Ninhydrin	Blue colored product that absorbs at 540 nm ^a
	Fluorescamine	Product that fluoresces
Carboxylic acid groups	Alcohols	Ester products
	Amines	Amide products
$-\text{NH}_2$ of Lys	Carbodiimide	Activates for reaction with nucleophiles
	2,3,6-Trinitrobenzene sulfonate	Product that absorbs at 367 nm
	Anhydrides	Acetylates amines
	Aldehydes	Forms Schiff base adducts
Guanidino group of Arg	Sakaguchi reaction	Pink-red product that can be used to assay Arg
Phenol of Tyr	I_2	Iodination of positions ortho to hydroxyl group on aromatic ring
	Acetic anhydride	Acetylation of $-\text{OH}$
S atom of Met side chain	CH_3I	Methyl sulfonium product
	$[\text{O}^-]$ or H_2O_2	Methionine sulfoxide or methionine sulfone
$-\text{SH}$ of Cys	Iodoacetate	Carboxymethyl thiol ether product
	<i>N</i> -Ethylmaleimide	Addition product with S
	Organic mercurials	Mercurial adducts
	Performic acid	Cysteic acid ($-\text{SO}_3\text{H}$) product
	Dithionitrobenzoic acid	Yellow product that can be used to quantitate $-\text{SH}$ groups
Imidazole of His and phenol of Tyr	Pauly's reagent	Yellow to reddish product

^a Proline imino group reacts with ninhydrin to form product that absorbs light at 440 nm (yellow color).

is to model the structural features of the enzyme's natural substrate into the modifying reagent. The reagent binds to the active site like a natural substrate and, while within the active site, reacts with a specific side chain in the enzyme active site. This identifies the modified amino acid as being located in the substrate-binding site and helps identify its role in the catalytic mechanism.

2.4— Primary Structure of Proteins

The **primary structure** (amino acid sequence) of a protein is required for an understanding of a protein's structure, its mechanism of action at a molecular level, and its relationship to other proteins with similar physiological roles. The primary structure of **insulin** illustrates the value of this knowledge for understanding a protein's biosynthesis and physiological forms. Insulin is produced in pancreatic islet cells as a single chain precursor, **proinsulin**, with the primary structure shown in Figure 2.23. The polypeptide chain contains 86 amino acids and 3 intrachain cystine disulfide bonds. It is transformed into biologically active insulin by proteolytic modifications in its primary structure as it is secreted from the islet cells. Proinsulin is cleaved by proteases present in the islet cells that cleave two peptide bonds in proinsulin between residues 30 and 31 and 65 and 66. This releases a 35 amino acid segment (the **C-peptide**)

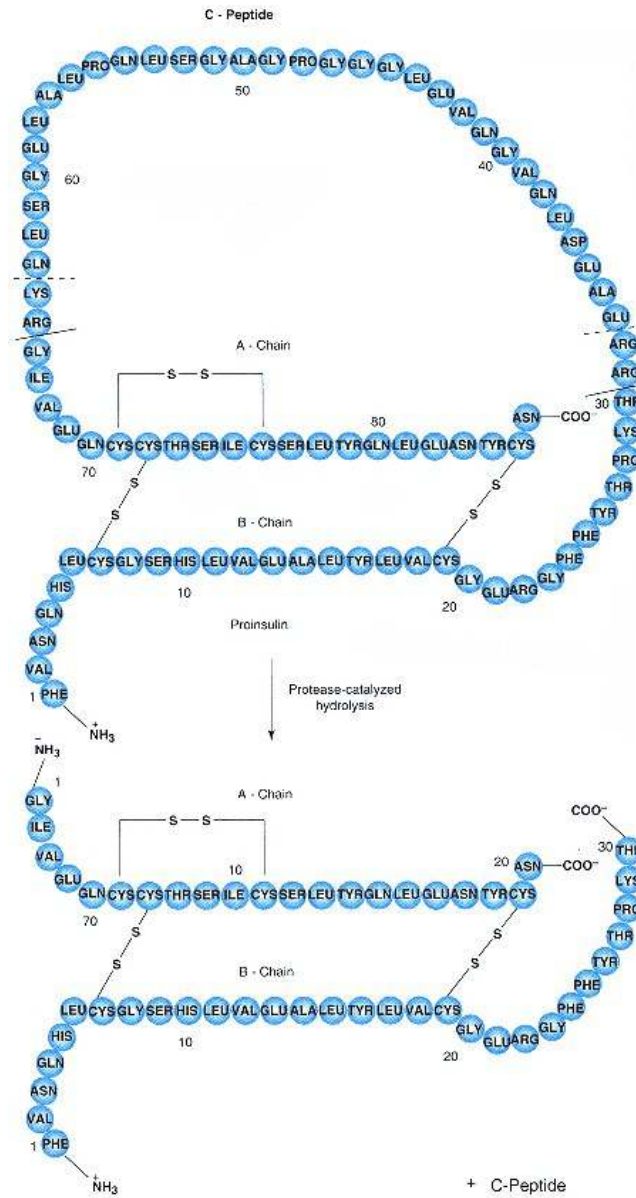

Figure 2.23

Primary structures of human proinsulin, insulin, and C-peptide.

In proinsulin, the B-chain peptide extends from Phe at position 1 to Thr at position 30, the C-peptide from Arg at position 31 to Arg at position 65, and the A-chain peptide from Gly at position 66 to Asn at position 86. Cystine bonds from positions 7 to 72, 19 to 85, and 71 to 76 are found in proinsulin. Redrawn from Bell, G. I., Swain, W. F., Pictet, R., Cordell, B., Goodman, H. M., and Rutter, W. J. *Nature* 282:525, 1979.

and the active insulin molecule. The active insulin consists of two polypeptide chains (A and B) of 21 amino acids and 30 amino acids, respectively, covalently joined by the same disulfide bonds present in proinsulin (Figure 2.23). The C-

TABLE 2.8 Variation in Positions A8, A9, A10, and B30 of Insulin

<i>Species</i>	<i>A8</i>	<i>A9</i>	<i>A10</i>	<i>B30</i>
Human	Thr	Ser	Ile	Thr
Cow	Ala	Ser	Val	Ala
Pig	Thr	Ser	Ile	Ala
Sheep	Ala	Gly	Val	Ala
Horse	Thr	Gly	Ile	Ala
Dog	Thr	Ser	Ile	Ala
Chicken ^a	His	Asn	Thr	Ala
Duck ^a	Glu	Asn	Pro	Thr

^a Positions 1 and 2 of B chain are both Ala in chicken and duck; whereas in the other species in the table, position 1 is Phe and position 2 is Val in B chain.

peptide is further processed in the pancreatic islet cells by proteases that hydrolyze a dipeptide from the COOH terminal and a second dipeptide from the NH₂ terminal of the C-peptide. The modified C-peptide is secreted into the blood with the active insulin. Besides giving information on the pathway for formation of active insulin, knowledge of primary structures shows the role of particular amino acids in the structure of insulin through comparison of the primary structures of the insulins from different animal species. The aligned primary structures show a residue identity in most amino acid positions, except for residues 8, 9, and 10 of the A chain and residue 30 of the B chain. Amino acids in these positions vary widely in different animal insulins (Table 2.8) and apparently do not affect the biological properties of the insulin molecule (see Clin. Corr. 2.2). Other amino acids of the primary structure are rarely substituted, suggesting that they have an essential role in insulin function.

Comparison of primary structures is commonly used to predict the similarity in structure and function between proteins. Sequence comparisons typically require aligning sequences to maximize the number of identical residues while minimizing the number of insertions or deletions required to achieve this alignment. Two sequences are termed **homologous** when their sequences are highly alignable. In its correct usage homology only refers to proteins that have evolved from the same gene. **Analogy** is used to describe sequences from proteins that are structurally similar but for which no evolutionary relationship has been demonstrated. Substitution of an amino acid by another amino acid of similar

CLINICAL CORRELATION 2.2

Differences in Primary Structure of Insulins Used in Treatment of Diabetes Mellitus

Both pig (porcine) and cow (bovine) insulins are commonly used in the treatment of human diabetics. Because of the differences in amino acid sequence from the human insulin, some diabetic individuals will have an initial allergic response to the injected insulin as their immunological system recognizes the insulin as foreign, or develop an insulin resistance due to a high anti-insulin antibody titer at a later stage in treatment. However, the number of diabetics who have a deleterious immunological response to pig and cow insulins is small; the great majority of human diabetics can utilize the nonhuman insulins without immunological complication. The compatibility of cow and pig insulins in humans is due to the small number and the conservative nature of the changes between the amino acid sequences of the insulins. These changes do not significantly perturb the three-dimensional structure of the insulins from that of human insulin. Pig insulin is usually more acceptable than cow insulin in insulin-reactive individuals because it is more similar in sequence to human insulin (see Table 2.8). Human insulin is now available for clinical use. It can be made using genetically engineered bacteria or by modifying pig insulin.

Brogdon, R. N., and Heel, R. C. Human insulin: a review of its biological activity, pharmacokinetics, and therapeutic use. *Drugs* 34:350, 1987.

CLINICAL CORRELATION 2.3

A Nonconservative Mutation Occurs in Sickle Cell Anemia

Hemoglobin S (HbS) is a variant form of the normal adult hemoglobin in which a nonconservative substitution occurs in the sixth position of the β -polypeptide chain of the normal hemoglobin (HbA₁). Whereas in HbA₁ this position is taken by a glutamic acid residue, in HbS the position is occupied by a valine. Consequently, in HbS a polar side chain group on the molecule's outside surface has been replaced with a nonpolar hydrophobic side chain (a nonconservative mutation). Through hydrophobic interactions with this nonpolar valine, HbS in its deoxy conformation polymerizes with other molecules of deoxy-HbS, leading to a precipitation of the hemoglobin within the red blood cell. This precipitation makes the red blood cell assume a sickle shape that results in a high rate of hemolysis and a lack of elasticity during circulation through the small capillaries, which become clogged by the abnormal shaped cells.

Only individuals homozygous for HbS exhibit the disease. Individuals heterozygous for HbS have approximately 50% HbA₁ and 50% HbS in their red blood cells and do not exhibit symptoms of the sickle cell anemia disease except under extreme conditions of hypoxia.

Individuals heterozygous for HbS have a resistance to the malaria parasite, which spends a part of its life cycle in red blood cells. This is a factor selecting for the HbS gene in malarial regions of the world and is the reason for the high frequency of this lethal gene in the human genetic pool. Approximately 10% of American blacks are heterozygous for HbS, and 0.4% of American blacks are homozygous for HbS and exhibit sickle cell anemia.

HbS is detected by gel electrophoresis. Because it lacks a glutamate, it is less acidic than HbA. HbS therefore does not migrate as rapidly toward the anode as does HbA. It is also possible to diagnose sickle cell anemia by recombinant DNA techniques.

Embury, S. H. The clinical pathophysiology of sickle-cell disease. *Annu. Rev. Med.* 37:361, 1986.

polarity (i.e., Val for Ile in position 10 of insulin) is called a **conservative** substitution and is commonly observed in amino acid sequences of the same protein from different animal species. If a particular amino acid is always found at the same position in these comparisons, then these are designated **invariant residues** and it can be assumed that these residues have an essential role in the structure or function of the protein. In contrast, a **nonconservative** substitution involves replacement of an amino acid by another of dramatically different polarity. This may produce severe changes in the properties of the resultant protein or occur in regions that are apparently unimportant functionally (see Clin. Corr. 2.3). Polarity is only one physical property of amino acids that determines whether a substitution will significantly alter the protein's function. Other physical properties of importance are the volume and surface area.

2.5—

Higher Levels of Protein Organization

Primary structure of a protein refers to the covalent structure of a protein. It includes amino acid sequence and location of disulfide (cystine) bonds. Higher levels of protein organization refer to noncovalently generated conformational properties of the primary structure. These higher levels of protein conformation and organization are defined as the secondary, tertiary, and quaternary structures of a protein. **Secondary structure** refers to the local three-dimensional folding of the polypeptide chain in the protein. The polypeptide chain in this context is the covalently interconnected atoms of the peptide bonds and α -carbon linkages that sequentially link the amino acid residues of the protein. Side chains are not considered at the level of secondary structure. **Tertiary structure** refers to the three-dimensional structure of the polypeptide. It includes the conformational relationships in space of the side chains and the geometric relationship between distant regions of the polypeptide chain. **Quaternary structure** refers to the structure and interactions of the noncovalent association of discrete polypeptide subunits into a multisubunit protein. Not all proteins have a quaternary structure.

Proteins generally assume unique secondary, tertiary, and quaternary conformations as determined by their particular amino acid sequence and termed the **native conformation**. Folding of the primary structure into the native

conformation occurs, in most cases, spontaneously through noncovalent interactions. This unique conformation is the one of lowest total Gibbs free energy kinetically accessible to the polypeptide chain(s) for the particular conditions of ionic strength, pH, and temperature of the solvent in which the folding occurs. Chaperone proteins may facilitate the rate of protein folding.

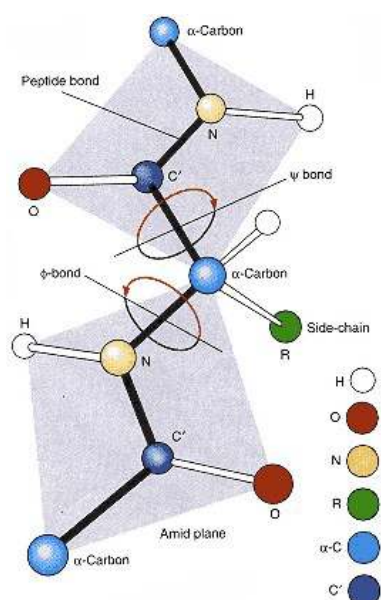

Figure 2.24
Polypeptide chain showing ϕ , ψ , and peptide bonds for residue R_i within a polypeptide chain.
Redrawn with permission from Dickerson, R. E., and Geis, I. *The Structure and Action of Proteins*. Menlo Park, CA: Benjamin, 1969, p. 25.

Proteins Have a Secondary Structure

The conformation of a polypeptide chain may be described by the rotational angles of the covalent bonds that contribute to the polypeptide chain. These are the bonds contributed by each of the amino acids between (1) the nitrogen and α -carbon and (2) the α -carbon and the carbonyl carbon. The first of these is designated the **phi (ϕ) bond** and the second is called the **psi (ψ) bond** for an amino acid residue in a polypeptide chain (Figure 2.24). The third bond contributed by each amino acid to the polypeptide chain is the peptide bond. As previously discussed, due to the partial double-bond character of the $C'=\text{N}$ bonds, there is a barrier to free rotation about this peptide bond.

Regular secondary structure conformations in segments of a polypeptide chain occur when all ϕ bond angles in that polypeptide segment are equal, and all the ψ bond angles are equal. The rotational angles for ϕ and ψ bonds for common regular secondary structures are given in Table 2.9.

The α -helix and β -structure conformations for polypeptide chains are the most thermodynamically stable of the regular secondary structures. However, a particular sequence may form regular conformations other than α -helical or β -structure. There are also regions of unordered secondary structure, in which neither the ϕ bond angles nor the ψ bond angles are equal. Proline interrupts α -helical conformations since the pyrrolidine side chain of proline sterically interacts with the amino acid preceding it in the polypeptide sequence when in an α -helical structure. This repulsive steric interaction tends to prevent formation of α -helical structure in sections of a polypeptide chain that contain proline.

Helical structures of polypeptide chains are characterized by the number of amino acid residues per turn of helix (n) and the distance between α -carbon atoms of adjacent amino acids measured parallel to the axis of the helix (d). The **helix pitch (p)**, defined as the product of $n \times d$, then measures the distance between repeating turns of the helix on a line drawn parallel to the helix axis (Figure 2.25):

$$p = n \times d$$

α -Helical Structure

An amino acid sequence in an α -helical conformation is shown in Figure 2.26.

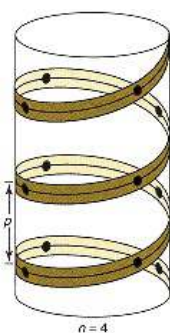

Figure 2.25
The helix pitch (p) for a helix with $n = 4$.
Each circle on a line represents an α -carbon from an amino acid residue. The rise per residue would be p/n (see equation in text).
From Dickerson, R. E., and Geis, I. *The Structure and Action of Proteins*. Menlo Park, CA: Benjamin, 1969, p. 26.

TABLE 2.9 Helix Parameters of Regular Secondary Structures

Structure	Approximate Bond Angles ($^\circ$)		Residues per turn, n	Helix Pitch, ^a p (Å)
	ϕ	ψ		
Right-handed α -helix [$3_6, 1_3$ -helix)	-57	-47	3.6	5.4
3_{10} -helix	+49	-26	3.0	6.0
Parallel β -strand	-119	+113	2.0	6.4
Antiparallel β -strand	-139	+135	2.0	6.8
Polyproline type II ^b	-78	+149	3.0	9.4

^a Distance between repeating turns on a line drawn parallel to helix axis.

^b Helix type found for polypeptide chains of collagen.

360° turn ($n = 3.6$). The peptide bond planes in the α -helix are parallel to the axis of the helix. In this geometry each peptide forms two hydrogen bonds, one to the peptide bond of the fourth amino acid above and the second to the peptide bond of the fourth amino acid below in the primary structure. Other α -helix parameters, such as the pitch (p), are given in Table 2.9. In the hydrogen bonds between the peptide groups of an α -helical structure, the distance between the hydrogen-donor atom and the hydrogen-acceptor atom is 2.9 Å. Also, the donor, acceptor, and hydrogen atoms are approximately collinear, in that they determine a straight line. This is an optimum geometry and distance for maximum hydrogen-bond strength (see Section 2.7).

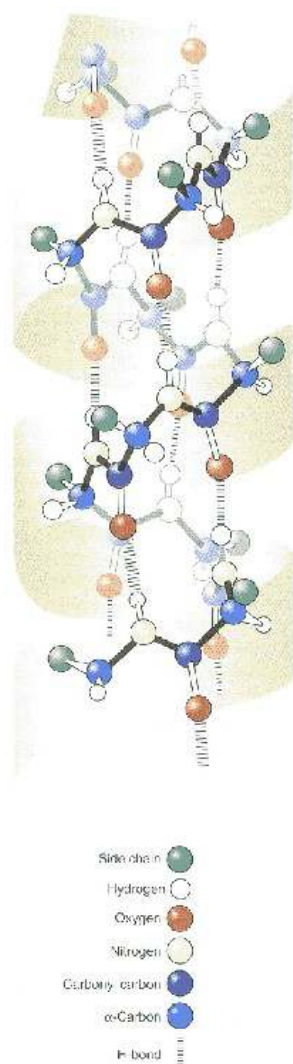

Figure 2.26
An α -helix.

Redrawn with permission, based on figure from Pauling, L. *The Nature of the Chemical Bond*, 3rd ed. Ithaca, NY: Cornell University Press, 1960.

The side chains in an α -helical conformation are on the outside of the spiral structure generated by the polypeptide chain. Due to the characteristic 3.6 residues per turn, the first and every third and fourth R group of the amino acid sequence in the helix come close to the other. Helices often present separable polar and nonpolar faces based on their amino acid sequences, which place polar or nonpolar side chains three or four amino acids apart in the sequence, which folds into the α -helix. This will give rise to unique functional characteristics of the helix. However, if every third or fourth side chain that come close together have the same charge sign or are branched at their β -carbon (valine and isoleucine), their unfavorable ionic or steric interactions destabilize the helix structure. The α -helix may theoretically form its spiral in either a left-handed or right-handed sense, giving the helix asymmetric properties and correlated optical activity. In the structure shown, a right-handed α -helix is depicted; this is more stable than the left-handed helix.

β -Structure

A polypeptide chain in a β -strand conformation (Figure 2.27) is hydrogen bonded to another similar strand aligned either in a parallel or antiparallel direction (Figure 2.28). Hydrogen-bonded β -strands appear like a pleated sheet (Figure 2.29). The side chains project above and below the pleated sheet-like structure.

Supersecondary Structures

Certain combinations of secondary structure can be observed in different folded protein structures. They are referred to as **structural motifs** and include helix-turn-helix (see p. 108), leucine zipper (see p. 110), calcium binding EF hand (see p. 209), and zinc finger (see p. 108). Even longer orderings may occur to form a domain (see below) such as the β -barrel and the immunoglobulin fold. These longer pattern lengths of secondary structure may include multiple structural motifs and when commonly observed in more than one protein are referred to as **supersecondary structures**.

Proteins Fold into a Three-Dimensional Structure Called the Tertiary Structure

The **tertiary structure** of a protein is the three-dimensional structure of a protein. It includes the geometric relationship between distant segments of primary structure and the relationship of the side chains with one another in three-dimensional space. As an example of a protein's tertiary structure, the structure for trypsin is shown in Figure 2.30. In Figure 2.30a the ribbon structure shows the conformation of polypeptide strands and the overall pattern of polypeptide chain folding (supersecondary structure). The tertiary structure is then further built upon in Figure 2.30b by showing the side chain groups and their interconnections with a stick model. Active site catalytic side chains are shown in yellow, which include the hydroxymethyl group of serine (residue 177 in the sequence), the imidazole of histidine (residue 40), and the carboxylate-containing side chain of aspartate (residue 85). Although these catalytic residues

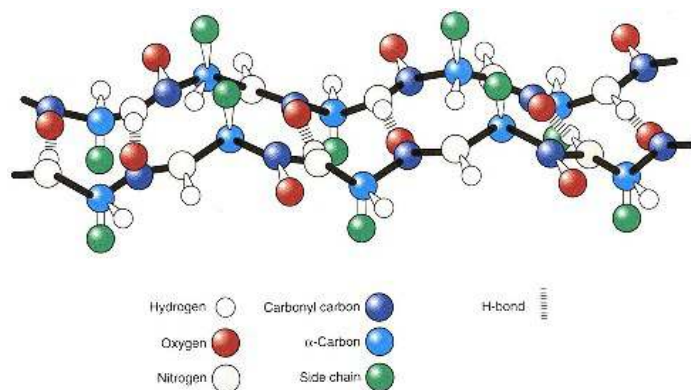

Figure 2.27

Two polypeptide chains in a β -structure conformation.

Additional polypeptide chains may be added to generate more extended structure.
Redrawn with permission from Fersht, A. *Enzyme Structure and Mechanism*, San Francisco: Freeman, 1977, p. 10.

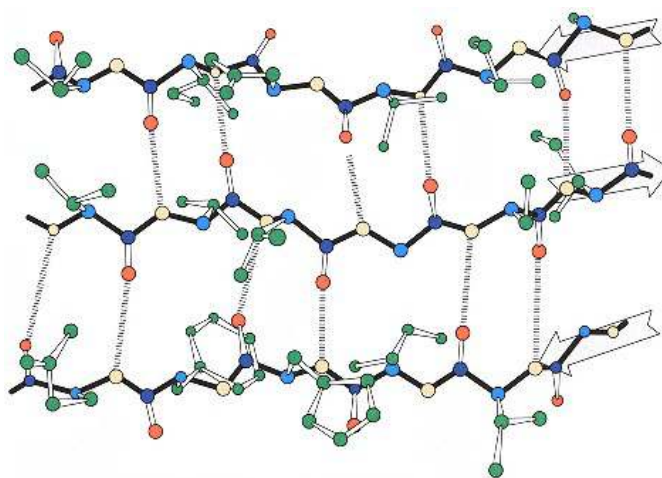

Figure 2.28

Example of antiparallel β -structure (residues 93–98, 28–33, and 16–21 of Cu,Zn superoxide dismutase).

Dashed line shows hydrogen bonds between carbonyl oxygen atoms and peptide nitrogen atoms; arrows show direction of polypeptide chains from N terminal to C terminal. In the characteristic antiparallel β -structure, pairs of closely spaced interchain hydrogen bonds alternate with widely spaced hydrogen bond pairs.
Redrawn with permission from Richardson, J. S. *Adv. Protein Chem.* 34:168, 1981.

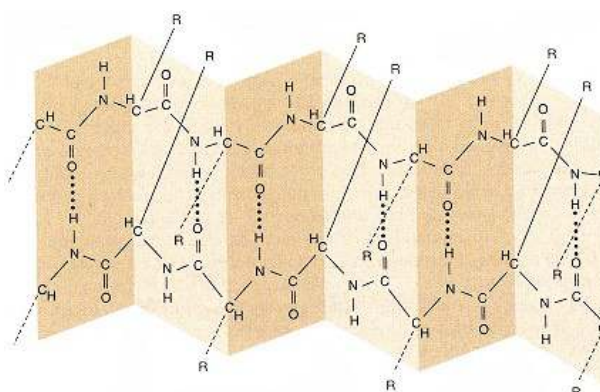

Figure 2.29

 β -Pleated sheet structure between two polypeptide chains.

Additional polypeptide chains may be added above and below to generate a more extended structure.

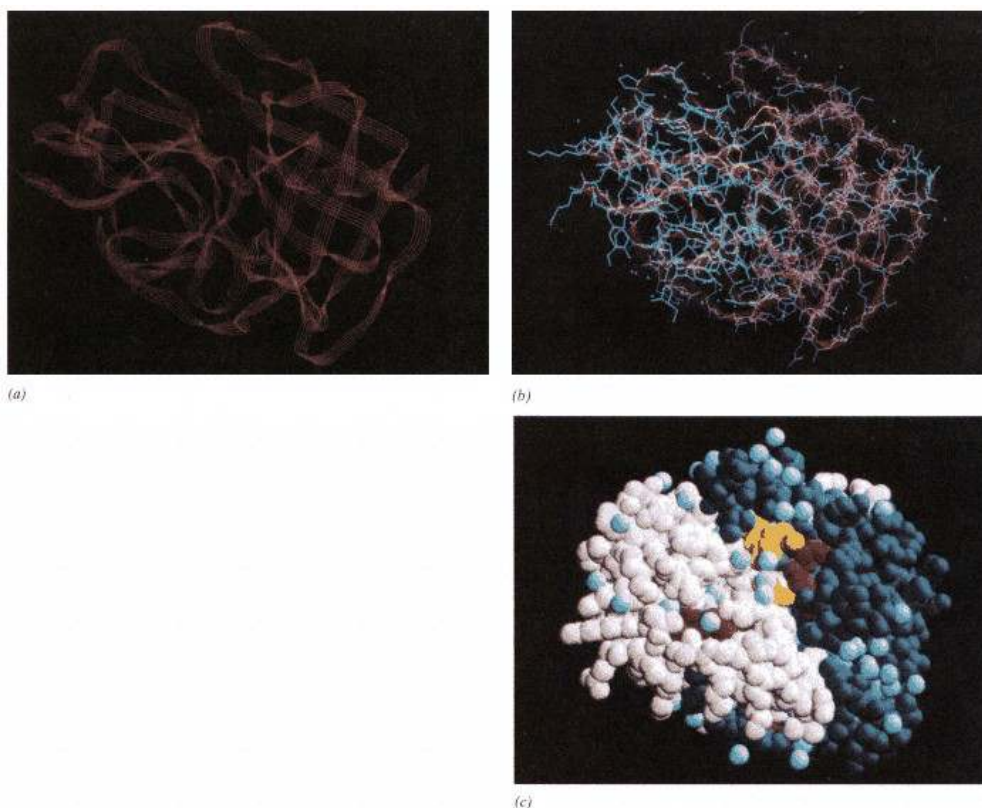

Figure 2.30

Tertiary structure of trypsin.

- (a) Ribbon structure outlines the conformation of the polypeptide chain.
 (b) Structure shows side chains including active site residues (in yellow) with outline of polypeptide chain (ribbon) superimposed.
 (c) Space-filling structure in which each atom is depicted as the size of its van der Waals radius. Hydrogen atoms are not shown. Different domains are shown in dark blue and white. The active site residues are in yellow and intrachain disulfide bonds of cystine in red. Light blue spheres represent water molecules associated with the protein. This structure shows the density of packing within the interior of the protein.

are widely separated in the primary structure, the folded tertiary structure brings them together in space to form the catalytic site. In Figure 2.30c a space-filling model shows C, N, and O atoms represented by balls of radius proportional to their van der Waals radius.

The tertiary structure of trypsin conforms to the general rules of folded proteins (see Section 2.3). Hydrophobic side chains are generally in the interior of the structure, away from the water interface. Ionized side chains occur on the outside of a protein structure, where they are stabilized by water of solvation. Within the protein structure (not shown) are buried water molecules, noncovalently associated, which exhibit specific arrangements. A large number of water molecules form a solvation shell around the outside of the protein.

A long polypeptide strand often folds into multiple compact semi-independent folded regions or **domains**, each domain having a characteristic compact geometry with a hydrophobic core and polar outside. They typically contain 100–150 contiguous amino acids. The domains of a **multidomain protein** may be connected by a segment of the polypeptide chain lacking regular secondary structure. Alternatively, the dense spherical folded regions are separated by a cleft or less dense region of tertiary structure (Figure 2.31). There are two folded domains in the trypsin molecule with a cleft between the domains

that includes the substrate-binding catalytic site of the protein. An active site within an interdomain interface is an attribute of many enzymes. Different domains within a protein can move with respect to each other. Hexokinase (Figure 2.32), which catalyzes phosphorylation of a glucose molecule by adenosine triphosphate (ATP), has the glucose-binding site in a region between two domains. When the glucose binds in the active site, the surrounding domains move to enclose the substrate to trap it for phosphorylation (Figure 2.32). In enzymes with more than one substrate or allosteric effector site (see Chapter 4), the different sites may be located within different domains. In multifunctional proteins, each domain performs a different task.

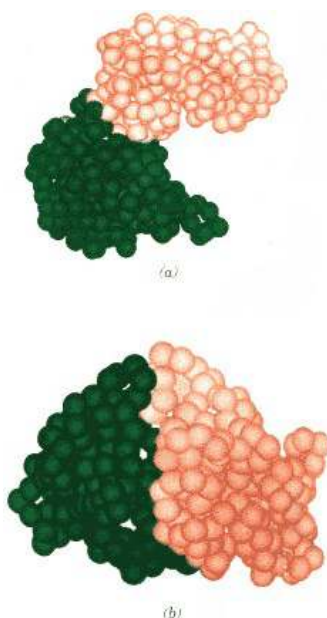

Figure 2.31

Globular domains within proteins.

(a) Phosphoglycerate kinase has two domains with a relatively narrow neck in between.

(b) Elastase has two tightly associated domains separated by a narrow cleft. Each sphere in the space-filling drawing represents the α -carbon position for an amino acid within the protein structure. Reprinted with permission from Richardson, J. S. *Adv. Protein Chem.* 34:168, 1981.

Homologous Three-Dimensional Domain Structures Are Often Formed from Common Arrangements of Secondary Structures

A protein can adopt a range of conformations for a particular amino acid sequence. Although each native structure is unique, a comparison of the tertiary structures of different proteins solved by X-ray crystallography shows similar arrangements of secondary structure motifs that form the tertiary structures of domains. Thus proteins unrelated by function, sequence, or evolution show similar patterns of arrangement of their secondary structures or supersecondary

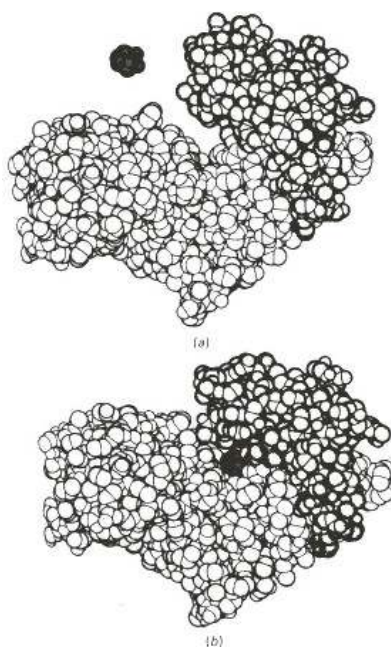

Figure 2.32

Drawings of (a) unliganded form of hexokinase and free glucose and (b) the conformation of hexokinase with glucose bound. In this space-filling drawing each circle represents the van der Waals radius of an atom in the structure. Glucose is black, and each domain is differently shaded.

Reprinted with permission from Bennett, W. S., and Huber, R. *CRC Rev. Biochem.* 15:291, 1984. Copyright © CRC Press, Inc., Boca Raton, FL.



Figure 2.33

An example of an all α -folded domain.

In this drawing and those that follow (Figures 2.34–2.36), only the outline of the polypeptide chain is shown. α -Structure strands are shown by arrows with the direction of the arrow showing the N C terminal direction of the chain; lightning bolts represent disulfide bonds, and circles represent metal ion cofactors (when present).
Redrawn with permission from Richardson, J. S. *Adv. Protein Chem.* 34:168, 1981.

structures. A classification system for supersecondary patterns places common folding patterns for secondary structures into structural families. The key supersecondary structures are formed because of the thermodynamic stability of their folding patterns.

A common all- α structure is found in the enzyme lysozyme (Figure 2.33). Other examples of all- α structure are in myoglobin and the subunits of hemoglobin, whose structures are discussed in Chapter 3. In this supersecondary folding pattern, seven or eight sections of α -helices are joined by smaller segments of polypeptide chains that allow the helices to fold back upon themselves to form a characteristic globular shape. Another common supersecondary structure is the **α,β -domain structure** shown by triose phosphate isomerase (Figure 2.34) in which the strands (designated by arrows) are wound into a **β -barrel**. Each β -strand in the interior of the β -barrel is interconnected by α -helical regions of the polypeptide chain on the outside of the molecule. A similar supersecondary structure is found in pyruvate kinase (Figure 2.34). A different type of α,β -domain supersecondary structure is seen in lactate dehydrogenase and phosphoglycerate kinase (Figure 2.35). In these the interior polypeptide sections participate in a **twisted-sheet β -structure**. The β -structure segments are joined by α -helix regions positioned on the outside of the molecule to give a characteristic α,β -domain folding pattern. An **all- β -domain** supersecondary structure is present in Cu,Zn superoxide dismutase, in which the antiparallel β -sheet forms a **Greek key β -barrel** (Figure 2.36). A similar pattern occurs in each of the domains of the immunoglobulins, discussed in Chapter 3. Concanavalin A (Figure 2.36) shows an all- β -domain structure in which the antiparallel β -strands form a β -barrel pattern called a "jellyroll." Protein structures used to define these classes have been observed by X-ray crystallographic analysis (Section 2.9), primarily of globular proteins that are water soluble. Proteins that are not water soluble may contain different supersecondary patterns (see Section 2.6).

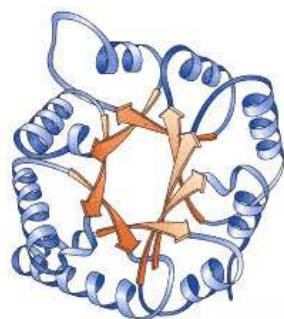

Triose Phosphate Isomerase

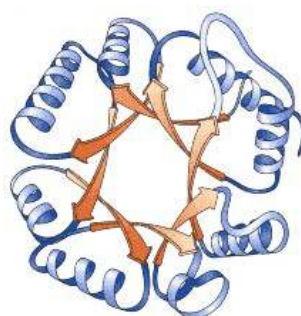

Pyruvate Kinase domain 1

Figure 2.34

Examples of α,β -folded domains in which β -structural strands form a β -barrel in the center of the domain (see legend to Figure 2.33).

Redrawn with permission from Richardson, J. S. *Adv. Protein Chem.* 34: 168, 1981.

A Quaternary Structure Occurs When Several Polypeptide Chains Form a Specific Noncovalent Association

Quaternary structure refers to the arrangement of polypeptide chains in a multichain protein. The subunits in a quaternary structure must be in noncovalent association, α -Chymotrypsin contains three polypeptide chains covalently joined together by interchain disulfide bonds into a single covalent unit and therefore does not have a quaternary structure. Myoglobin consists of a single polypeptide chain and has no quaternary structure. However, hemoglobin A

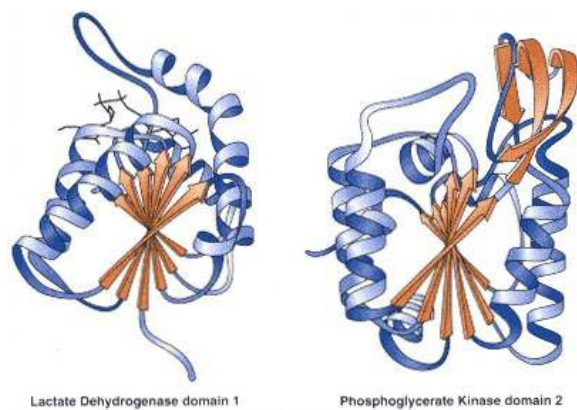

Figure 2.35
Examples of α,β -folded
domains in which β -structure strands are in the form of
a classical twisted β -sheet (see legend to Figure 2.33).
 Redrawn with permission from Richardson, J. S. *Adv. Protein Chem.*
 34:168, 1981.

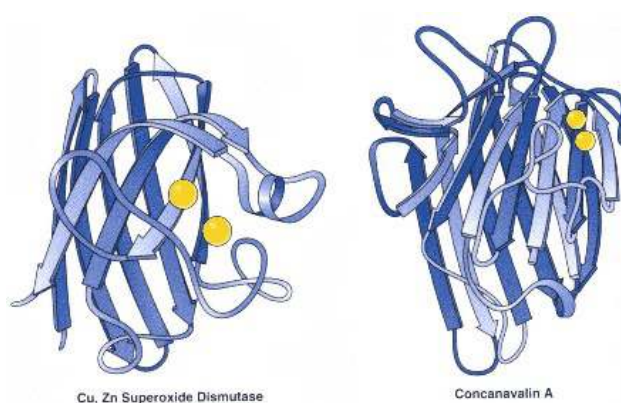

Figure 2.36
Examples of all β -folded domains (see legend to Figure 2.33).
 Redrawn with permission from Richardson, J. S. *Adv.*
Protein Chem. 34:168, 1981.

contains four polypeptide chains ($\alpha_2\beta_2$) held together noncovalently in a specific conformation as required for its function (see Chapter 3). Thus hemoglobin has a quaternary structure. Aspartate transcarbamylase (see Chapter 13) has a quaternary structure comprised of 12 polypeptide subunits. The poliovirus protein coat contains 60 polypeptide subunits, and the tobacco mosaic virus protein has 2120 polypeptide subunits held together noncovalently in a specific structural arrangement.

2.6— Other Types of Proteins

The characteristics of protein structure, discussed above, are based on observations on globular, water-soluble proteins. Other proteins, such as the fibrous proteins, are nonglobular and have a low water solubility; lipoproteins and

glycoproteins have a heterogeneous composition and may or may not be water soluble.

Fibrous Proteins Include Collagen, Elastin, α -Keratin, and Tropomyosin

Globular proteins have a spheroidal shape, variable molecular weights, relatively high water solubility, and a variety of functional roles as catalysts, transporters, and control proteins for the regulation of metabolic pathways and gene expression. In contrast, fibrous proteins characteristically contain larger amounts of regular secondary structure, a long cylindrical (rod-like) shape, a low solubility in water, and a structural rather than a dynamic role in the cell or organism. Examples of fibrous proteins are collagen, α -keratin, and tropomyosin.

Distribution of Collagen in Humans

Collagen is present in all tissues and organs where it provides the framework that gives the tissues their form and structural strength. Its importance is shown by its high concentration in all organs; the percentage of collagen by weight for some representative human tissues and organs is 4% of the liver, 10% of lung, 12–24% of the aorta, 50% of cartilage, 64% of the cornea, 23% of whole cortical bone, and 74% of skin (see Clin. Corr. 2.4).

Amino Acid Composition of Collagen

The amino acid composition of collagen is quite different from that of a typical globular protein. The amino acid composition of type I skin collagen and of globular proteins ribonuclease and hemoglobin are given in Table 2.10. Skin collagen is comparatively rich in glycine (33% of its amino acids), proline (13%), the derived amino acid 4-hydroxyproline (9%), and another derived amino acid 5-hydroxylysine (0.6%) (Figure 2.37). Hydroxyproline is unique to collagens being formed enzymatically from prolines within a collagen polypeptide chain. The enzyme-catalyzed hydroxylation of proline requires the presence of ascorbic acid (vitamin C); thus in vitamin C deficiency (scurvy) there is poor synthesis of new collagen. Most hydroxyprolines in a collagen have the hydroxyl group in the 4-position (γ -carbon) of the proline structure, although a small amount of 3-hydroxyproline is also formed (Table 2.10). Collagens are glycoproteins with carbohydrate covalently joined to the derived amino acid, 5-hydroxylysine, by an *O*-glycosidic bond through the δ -carbon hydroxyl group. Formation of 5-hydroxylysine from lysines and addition of the carbohydrate to the 5-hydroxylysine occur after polypeptide chain formation but prior to the folding of the collagen chains into their unique supercoiled structure.

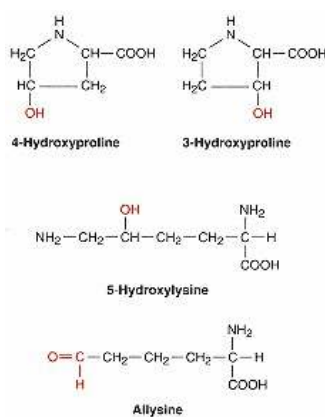

Figure 2.37
Derived amino acids found in collagen.
Carbohydrate is attached to 5-OH
in 5-hydroxylysine by a type III
glycosidic linkage (see Figure 2.45).

Amino Acid Sequence of Collagen

The molecular unit of mature collagen or tropocollagen contains three polypeptide chains. Various distinct collagen chains exist that make up the different

CLINICAL CORRELATION 2.4

Symptoms of Diseases of Abnormal Collagen Synthesis

Collagen is present in virtually all tissues and is the most abundant protein in the body. Certain organs depend heavily on normal collagen structure to function physiologically. Abnormal collagen synthesis or structure causes dysfunction of cardiovascular organs (aortic and arterial aneurysms and heart valve malfunction), bone (fragility and easy fracturing), skin (poor healing and unusual distensibility), joints (hypermobility and arthritis), and eyes (dislocation of the lens). Examples of diseases caused by abnormal collagen synthesis include Ehlers–Danlos syndrome, osteogenesis imperfecta, and scurvy. These diseases may result from abnormal collagen genes, abnormal posttranslational modification of collagen, or deficiency of cofactors needed by the enzymes that carry out posttranslational modification of collagen.

Byers, P. H. Disorders of collagen biosynthesis and structure. In: C. R. Scriver, A. L. Beaudet, W. S. Sly, and D. Valle (eds.), *The Metabolic and Molecular Bases of Inherited Disease*, 7th ed. McGraw-Hill, 1995, Chap. 134.

TABLE 2.10 Comparison of the Amino Acid Content of Human Skin Collagen (Type I) and Mature Elastin with That of Two Typical Globular Proteins^a

<i>Amino Acid</i>	<i>Collagen (Human Skin)</i>	<i>Elastin (Mammalian)</i>	<i>Ribonuclease (Bovine)</i>	<i>Hemoglobin (Human)</i>
COMMON AMINO ACIDS		PERCENT OF TOTAL		
Ala	11	22	8	9
Arg	5	0.9	5	3
Asn			8	3
Asp	5	1	15	10
Cys	0	0	0	1
Glu	7	2	12	6
Gln			6	1
Gly	33	31	2	4
His	0.5	0.1	4	9
Ile	1	2	3	0
Leu	2	6	2	14
Lys	3	0.8	11	10
Met	0.6	0.2	4	1
Phe	1	3	4	7
Pro	13	11	4	5
Ser	4	1	11	4
Thr	2	1	9	5
Trp	2	1	9	2
Tyr	0.3	2	8	3
Val	2	12	8	10
DERIVED AMINO ACIDS				
Cystine	0	0	7	0
3-Hydroxyproline	0.1		0	0
4-Hydroxyproline	9	1		0
5-Hydroxylysine	0.6	0	0	0
Desmosine and isodesmosine	0	1	0	0

^a Boxed numbers emphasize important differences in amino acid composition between the fibrous proteins (collagen and elastin) and typical globular proteins.

collagen types, each with their own genes. In some types, the three polypeptide chains have an identical amino acid sequence. In others such as type I (Table 2.11), two of the chains are identical while the amino acid sequence of the third chain is slightly different. In type I collagen, the identical chains are designated $\alpha 1(I)$ chains and the third nonidentical chain, $\alpha 2(I)$. In type V collagen all three chains are different, designated $\alpha 1(V)$, $\alpha 2(V)$, and $\alpha 3(V)$. Different types of collagen differ in their physical properties due to differences in the amino acid sequence among chains, even though there are large regions of homologous sequence among the different chain types. Collagen has covalently attached carbohydrate and the collagen types differ in their carbohydrate component. Table 2.11 describes some characteristics of collagen types I–VI; additional collagen types (designated up through type XVI) have been reported.

The amino acid sequence of the chains of collagens is unusual. In long segments of all the collagen types glycine occurs as every third residue and proline or hydroxyproline also occurs three residues apart in these same regions. Accordingly, the amino acid sequences Gly-Pro-Y and Gly-X-Hyp (where X and Y are any of the amino acids) are repeated in tandem several hundred times. In type I collagen, the triplet sequences are reiterated over 200 times, encompassing over 600 amino acids within a chain of approximately 1000 amino acids.

TABLE 2.11 Classification of Collagen Types

Type	Chain Designations	Tissue Found	Characteristics
I	$[\alpha 1(I)]_2\alpha 2(I)$	Bone, skin, tendon, scar tissue, heart valve, intestinal, and uterine wall	Low carbohydrate; <10 hydroxylysines per chain; two types of polypeptide chains
II	$[\alpha 1(II)]_3$	Cartilage, vitreous	10% carbohydrate; >20 hydroxylysines per chain
III	$[\alpha 1(III)]_3$	Blood vessels, newborn skin, scar tissue, intestinal, and uterine wall	Low carbohydrate; high hydroxyproline and Gly; contains Cys
IV	$[\alpha 1(IV)]_3$ $[\alpha 2(IV)]_3$	Basement membrane, lens capsule	High 3-hydroxyproline; >40 hydroxylysines per chain; low Ala and Arg; contains Cys; high carbohydrate (15%)
V	$[\alpha 1(V)]_2\alpha 2(V)$ $[\alpha 1(V)]_3$ $\alpha 1(V)\alpha 2(V)$ $\alpha 3(V)$	Cell surfaces or exocytoskeleton; widely distributed in low amounts	High carbohydrate, relatively high glycine, and hydroxylysine
VI	–	Aortic intima, placenta, kidney, and skin in low amounts	Relatively large globular domains in telopeptide region; high Cys and Tyr; molecular weight relatively low (~160,000); equimolar amounts of hydroxylysine and hydroxyproline

Structure of Collagen

Polypeptides that contain only proline can be synthesized in the laboratory. These polyproline chains assume a regular secondary structure in aqueous solution in which the chain is in a tightly twisted extended helix with three residues per turn of the helix ($n = 3$). This helix with all *trans*-peptide bonds is designated the **polyproline type II** helix (see Figure 2.11 for differences between *cis*- and *trans*-peptide bonds). The polyproline helix has the same characteristics as the helix found in collagen chains in regions of the primary structure that contain a proline or hydroxyproline at approximately every third position. Since the helix structure in collagen is the same as that of polyproline, the thermodynamic forces leading to formation of the collagen helix structure are due to the properties of proline. In proline, the ϕ angle contributed to the polypeptide chain is part of the five-member cyclic side chain. The five-member ring constrains the $C_\alpha-N$ bond to an angle compatible with the polyproline helix structure.

In polyproline type II helix, the plane of each peptide bond is perpendicular to the axis of the helix. In this geometry the peptide carbonyl groups are pointed toward neighboring chains and are correctly oriented to form strong interchain hydrogen bonds with other chains of the collagen molecule. This is in contrast to the α -helix, in which the plane containing the atoms of the peptide bond is

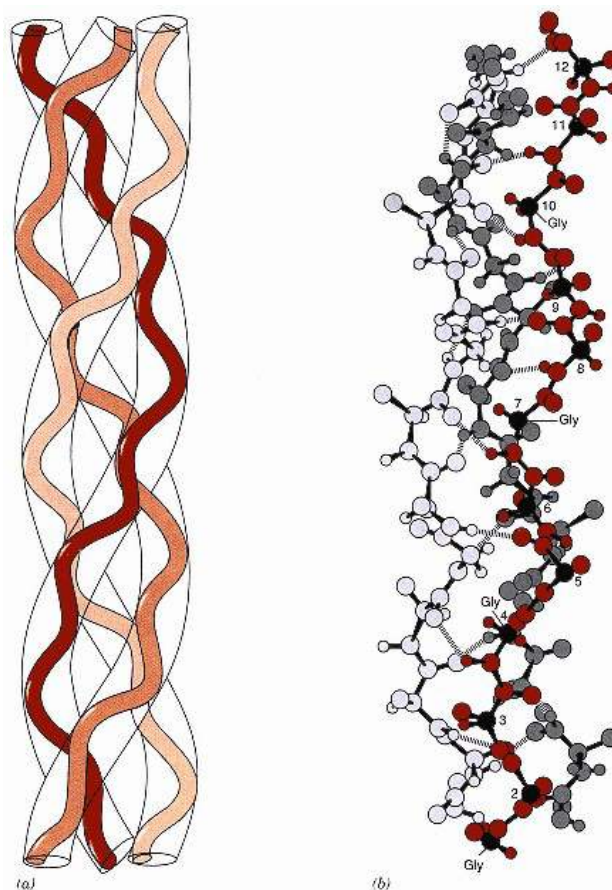

Figure 2.38

Diagram of collagen demonstrating necessity for glycine in every third residue to allow the different chains to be in close proximity in the structure.

(a) Ribbon model for supercoiled structure of collagen with each individual chain in a polyproline type II helix.

(b) More detailed model of supercoiled conformation.

All α -carbon atoms are numbered and proposed hydrogen bonds are shown by dashed lines.

Redrawn with permission from Dickerson, R. E., and Geis,

I. *The Structure and Actions of Proteins*,
Menlo Park, CA: Benjamin, 1969, pp. 41, 42.

parallel to the α -helix axis and the peptide bonds form only intrachain hydrogen bonds with peptide bonds in the same polypeptide chain. The three chains of a collagen molecule, where each of the chains is in a polyproline type II helix conformation, are wound about each other in a defined way to form a **superhelical structure** (Figure 2.38). The three-chain superhelix has a characteristic rise (d) and pitch (p) as does the single-chain helix. The collagen superhelix forms because glycines have a side chain of low steric bulk ($R = H$). As the polyproline type II helix has three residues per turn ($n = 3$) and glycine is at every third position, the glycines in each of the polypeptide chains

are aligned along one side of the helix, forming an **apolar edge** of the chain. The glycine edges from the three polypeptide chains associate noncovalently in a close arrangement, held together by hydrophobic interactions, to form the superhelix structure of collagen. A larger side chain than that of glycine would impede the adjacent chains from coming together in the superhelix structure (Figure 2.38).

In collagen molecules the superhelix conformation may propagate for long stretches of the sequence, which is especially true for type I collagen where only the COOH-terminal and NH₂-terminal segments (known as the **telopeptides**) are not in a superhelical conformation. The type I collagen molecule has a length of 3000 Å and a width of only 15 Å, a very long cylindrical structure. In other collagen types, the superhelical regions may be broken periodically by regions of the chain that fold into globular domains.

Formation of Covalent Cross-links in Collagen

An enzyme present in extracellular space acts on the secreted collagen molecules (see p. 747) to convert some of the ε-amino groups of lysine side chains to δ-aldehydes (Figure 2.39). The resulting amino acid, containing an aldehydic R group, is the derived amino acid **allysine**. The newly formed aldehyde side chain spontaneously undergoes nucleophilic addition reactions with nonmodified lysine ε-amino groups and with the δ-carbon atoms of other allysine aldehydic groups to form linking covalent bonds (Figure 2.39). These covalent linkages can be between chains within the superhelical structure or between adjacent superhelical collagen molecules in a collagen fibril.

Elastin Is a Fibrous Protein with Allysine-Generated Cross-links

Elastin gives tissues and organs the capacity to stretch without tearing. It is classified as a fibrous protein because of its structural function and relative insolubility. It is abundant in ligaments, lungs, walls of arteries, and skin. Elastin does not contain repeating sequences of Gly-Pro-Y or Gly-X-Hyp and does not fold into either a polyproline helix or a superhelix. It appears to lack a regular secondary structure, but rather contains an unordered coiled structure in which amino acid residues within the folded structure are highly mobile. The highly mobile, kinetically free, though extensively cross-linked structure gives the

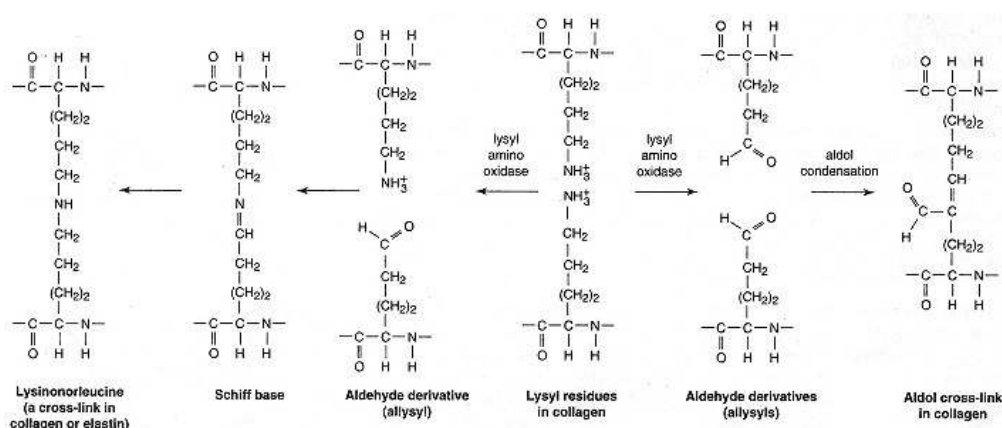

Figure 2.39
Covalent cross-links formed in collagen through allysine intermediates.
Formation of allysines is catalyzed by lysyl amino oxidase.

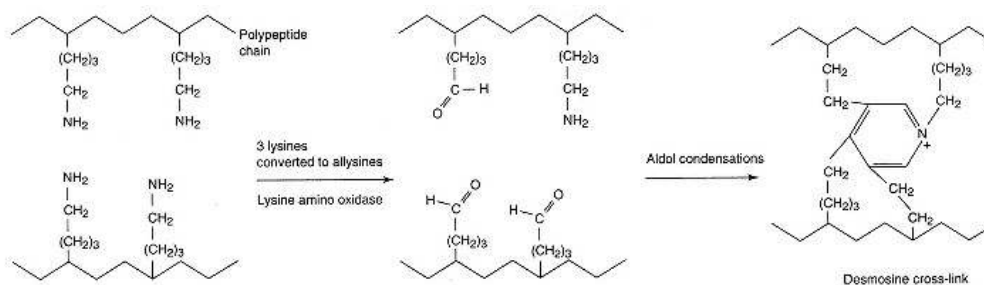

Figure 2.40

Formation of desmosine covalent cross-link in elastin from lysine and allysines.

Polypeptide chain drawn schematically with intersections of lines representing the placement of α -carbons.

protein a rubber-like elasticity. As in collagen, allysines form cross-links in **elastin**. An extracellular **lysine amino oxidase** converts lysine side chains of elastin to allysines. The amino oxidase is specific for lysines in the sequence -Lys-Ala-Ala-Lys- and -Lys-Ala-Ala-Ala-Lys-. Three allysines and an unmodified lysine in these sequences, from different regions in the polypeptide chains, react to form the heterocyclic structure of **desmosine** or **isodesmosine**. The desmosines covalently cross-link the polypeptide chains in elastin fibers (Figure 2.40).

α -Keratin and Tropomyosin

α -Keratin and tropomyosin are fibrous proteins in which each chain has an α -helical conformation. α -Keratin is found in the epidermal layer of skin, in nails, and in hair. Tropomyosin is a component of the thin filament in muscle tissue. Analysis of the α -helical sequences in both these proteins shows the tandem repetition of seven amino acid segments, in which the first and fourth amino acids have hydrophobic side chains and the fifth and seventh polar side chains. The reiteration of hydrophobic and polar side chains in seven amino acid segments is symbolically represented by the formulation (a-b-c-d-e-f-g)_n, where residues a and d are hydrophobic amino acids, and residues e and g are polar or ionized side chain groups. Since a seven amino acid segment represents two complete turns of an α -helix ($n = 3.6$), the apolar residues at a and d align to form an apolar edge along one side of the α -helix (Figure 2.41). This apolar edge in α -keratin interacts with polypeptide apolar edges of other α -keratin chains to form a superhelical structure containing two or three polypeptide chains. Each strand also contains a polar edge, due to residues e and g, that interacts with the water solvent on the outside of the superhelix and also stabilizes the superhelical structure. Similarly, two tropomyosin polypeptide strands in α -helical conformation wind around each other to form a tropomyosin superhelical structure.

Thus collagen, α -keratin, and tropomyosin molecules are multistrand structures in which polypeptide chains with a highly regular secondary structure (polyproline type II helix in collagen, α -helix in α -keratin and tropomyosin) are wound around each other to form a rod-shaped supercoiled conformation. In turn, the supercoiled molecules are aligned into multimolecular fibrils stabilized by covalent cross-links. The amino acid sequences of the chains are repetitive, generating edges on the cylindrical surfaces of each of the chains that stabilize a hydrophobic interaction between the chains required for generation of the supercoiled conformation.

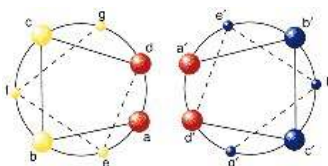

Figure 2.41

Interaction of an apolar edge of two chains in α -helical conformation as in α -keratin and tropomyosin.

Interaction of apolar a-d and d-a residues of two α -helices aligned parallel in an NH_2 -terminal (top) to COOH -terminal direction is presented. Redrawn from McLachlan, A. D., and Stewart, M. J. *Mol. Biol.* 98:293, 1975.

Lipoproteins Are Complexes of Lipids with Proteins

Lipoproteins are multicomponent complexes of proteins and lipids that form distinct molecular aggregates with an approximate stoichiometry between protein and lipid components within the complex. Each type of lipoprotein has a characteristic molecular mass, size, chemical composition, density, and physiological role. The protein and lipid in the complex are held together by noncovalent forces.

Plasma lipoproteins are extensively characterized and changes in their relative amounts are predictive of atherosclerosis, a major human disease (see Clin. Corr. 2.5). They have a wide variety of roles in blood including transport of lipids from tissue to tissue and participating in lipid metabolism (see Chapter 9). Four classes of plasma lipoproteins exist in normal fasting humans (Table 2.12); in the postabsorptive period a fifth type, **chylomicrons**, is also present. Lipoprotein classes are identified by their density, as determined by ultracentrifugation and by electrophoresis (Figure 2.42). The protein components of a lipoprotein particle are the **apolipoproteins**. Each type of lipoprotein has a

TABLE 2.12 Hydrated Density Classes of Plasma Lipoproteins

Lipoprotein Fraction	Density (g mL^{-1})	Flotation Rate, S_f (Svedberg units)	Molecular Weight (daltons)	Particle Diameter (\AA)
HDL	1.063–1.210		HDL ₂ , 4×10^5	70–130
			HDL ₃ , 2×10^5	50–100
LDL (or LDL ₂)	1.019–1.063	0–12	2×10^6	200–280
IDL (or LDL ₁)	1.006–1.019	12–20	4.5×10^6	250
VLDL	0.95–1.006	20–400	5×10^6 – 10^7	250–750
Chylomicrons	<0.95	>400	10^9 – 10^{10}	10^3 – 10^4

Source: Data from Soutar, A. K., and Myant, N. B. In: R. E. Offord (Ed.), *Chemistry of Macromolecules*, IIB. Baltimore, MD: University Park Press, 1979.

CLINICAL CORRELATION 2.5

Hyperlipidemias

Hyperlipidemias are disorders of the rates of synthesis or clearance of lipoproteins from the bloodstream. Usually they are detected by measuring plasma triacylglycerol and cholesterol and are classified on the basis of which class of lipoproteins is elevated.

Type I hyperlipidemia is due to accumulation of chylomicrons. Two genetic forms are known: lipoprotein lipase deficiency and ApoCII deficiency. ApoCII is required by lipoprotein lipase for full activity. Patients with type I hyperlipidemia have exceedingly high plasma triacylglycerol levels (over 1000 mg dL^{-1}) and suffer from eruptive xanthomas (triacylglycerol deposits in the skin) and pancreatitis.

Type II hyperlipidemia is characterized by elevated LDL levels. Most cases are due to genetic defects in the synthesis, processing, or function of the LDL receptor. Heterozygotes have elevated LDL levels; hence the trait is dominantly expressed. Homozygous patients have very high LDL levels and may suffer myocardial infarctions before age 20.

Type III hyperlipidemia is due to abnormalities of ApoE, which interfere with the uptake of chylomicron and VLDL remnants. Hypothyroidism can produce a very similar hyperlipidemia. These patients have an increased risk of atherosclerosis.

Type IV hyperlipidemia is the commonest abnormality. The VLDL levels are increased, often due to obesity, alcohol abuse, or diabetes. Familial forms are also known but the molecular defect is unknown.

Type V hyperlipidemia is, like type I, associated with high chylomicron triacylglycerol levels, pancreatitis, and eruptive xanthomas.

Hypercholesterolemia also occurs in certain types of liver disease in which biliary excretion of cholesterol is reduced. An abnormal lipoprotein called lipoprotein X accumulates. This disorder is not associated with increased cardiovascular disease from atherosclerosis.

Havel, R. J., and Kane, J. P. Introduction: structure and metabolism of plasma lipoproteins. In: C. R. Scriver, A. L. Beaudet, W. S. Sly, and D. Valle (Eds.), *The Metabolic and Molecular Basis of Inherited Disease*, 7th ed. New York: McGraw-Hill, 1995, Chap. 56; and Goldstein, J. L., Hobbs, H. H., and Brown, M. S. Familial hypercholesterolemia. In: C. R. Scriver, A. L. Beaudet, W. S. Sly, and D. Valle (Eds.), *The Metabolic and Molecular Bases of Inherited Disease*, 7th ed., New York: McGraw Hill, 1995, Chap. 62.

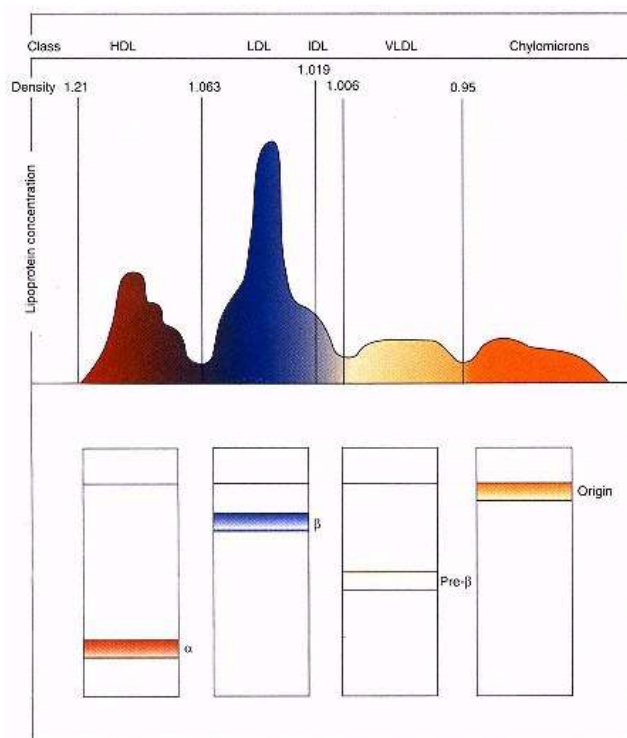

Figure 2.42

Correspondence of plasma lipoprotein density classes with electrophoretic mobility in a plasma electrophoresis.

In the upper diagram an ultracentrifugation Schlieren pattern is shown. At the bottom, electrophoresis on a paper support shows the mobilities of major plasma lipoprotein classes with respect to α - and β -globulin bands.

Reprinted with permission from Soutar, A. K., and Myant, N. B. In: R. E. Offord (Ed.), *Chemistry of Macromolecules*, IIB. Baltimore, MD: University Park Press, 1979.

characteristic apolipoprotein composition, the different apolipoproteins often being present in a set ratio. The most prominent apolipoprotein in **high density lipoproteins (HDLs)** is apolipoprotein A-I (ApoA-I) (Table 2.13). In **low den-**

TABLE 2.13 Apolipoproteins of Human Plasma Lipoproteins (Values in Percentage of Total Protein Present)^a

<i>Apolipoprotein</i>	<i>HDL₂</i>	<i>HDL₃</i>	<i>LDL</i>	<i>IDL</i>	<i>VLDL</i>	<i>Chylomicrons</i>
ApoA-I	85	70–75	Trace	0	0–3	0–3
ApoA-II	5	20	Trace	0	0–0.5	0–1.5
ApoD	0	1–2			0	1
ApoB	0–2	0	95–100	50–60	40–50	20–22
ApoC-I	1–2	1–2	0–5	<1	5	5–10
ApoC-II	1	1	0.5	2.5	10	15
ApoC-III	2–3	2–3	0–5	17	20–25	40
ApoE	Trace	0–5	0	15–20	5–10	5
ApoF	Trace	Trace				
ApoG	Trace	Trace				

Source: Data from Soutar, A. K., and Myant, N. B. In: R. E. Offord (Ed.), *Chemistry of Macromolecules*, IIB. Baltimore, MD: University Park Press, 1979; Kostner, G. M. *Adv. Lipid Res.* **20**:1, 1983.

^a Values show variability from different laboratories.

sity lipoproteins (LDLs) the prominent apolipoprotein is ApoB, which is also present in the intermediate density lipoproteins (IDLs) and very low density lipoproteins (VLDLs). The ApoC family is also present in high amounts in IDLs and VLDLs. Each apolipoprotein class (A, B, etc.) is distinct (see Clin. Corr. 2.6). Proteins within a class do not cross-react with antibodies to another class. The molecular weights of the apolipoproteins of the plasma lipoproteins vary from 6 kDa (ApoC-I) to 550 kDa for ApoB-100. This latter is one of the longest single-chain polypeptides known (4536 amino acids).

A model for a VLDL particle is shown in Figure 2.43. On the inside are neutral lipids such as cholesterol esters and triacylglycerols. Surrounding this inner core of neutral lipids, in a shell ~ 20 Å thick, reside the proteins and the

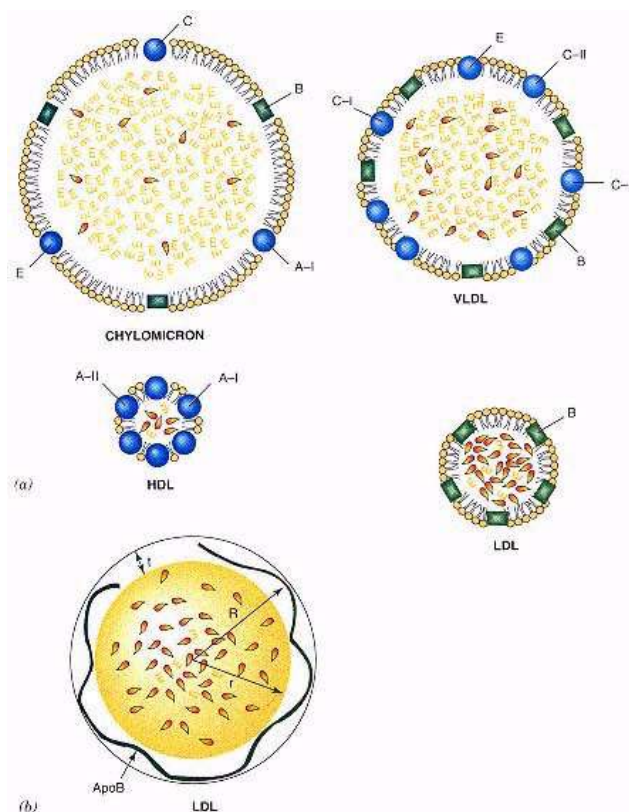

Figure 2.43

Generalized structure of plasma lipoproteins.

(a) Spherical particle model consisting of a core of triacylglycerols (yellow E's) and cholesterol esters (orange drops) with a shell ~ 20 Å thick of apolipoproteins (lettered), phospholipids, and unesterified cholesterol. Apolipoproteins are embedded with their hydrophobic edges oriented toward the core and their hydrophilic edges toward the outside.

From Segrest, J. P., et al. *Adv. Protein Chem.* 45:303, 1994.

(b) LDL particle showing ApoB-100 imbedded in outer shell of particle. From Schumaker, V. N., et al., *Protein Chem.* 45:205, 1994.

CLINICAL CORRELATION 2.6**Hypolipoproteinemias**

Abetalipoproteinemia is a genetic disease that is characterized by absence of chylomicrons, VLDLs, and LDLs due to an inability to synthesize apolipoprotein B-100. Patients show accumulation of lipid droplets in small intestinal cells, malabsorption of fat, acanthocytosis (spiny shaped red cells), and neurological disease (retinitis pigmentosa, ataxia, and retardation).

Tangier disease, an α -lipoprotein deficiency, is a rare autosomal recessive disease in which the HDL level is 1–5% of its normal value. Clinical features are due to the accumulation of cholesterol in the lymphoreticular system, which may lead to hepatomegaly and splenomegaly. In this disease the plasma cholesterol and phospholipids are greatly reduced.

Deficiency of the enzyme lecithin:cholesterol acyltransferase is a rare disease that results in the production of lipoprotein X (see Clin. Corr. 2.5). Also characteristic of this disease is the decrease in the α -lipoprotein and pre- β -lipoprotein bands, with the increase in the β -lipoprotein (lipoprotein X) in electrophoresis.

Kane, J. P., and Havel, R. J. Disorders of the biogenesis and secretion of lipoproteins containing the β apolipoproteins. In: C. R. Scriver, A. L. Beaudet, W. S. Sly, and D. Valle (Eds.), *The Metabolic and Molecular Basis of Inherited Disease*, 7th ed. New York: McGraw-Hill, 1995, Chap. 57; and Assmann, G., von Eckardstein, A., and Brewer, H. B. Jr. Familial high density lipoprotein deficiency: Tangier disease. In: C. R. Scriver, A. L. Beaudet, W. S. Sly, and D. Valle (Eds.), *The Metabolic and Molecular Bases of Inherited Disease*, 7th ed. New York: McGraw-Hill, 1995, Chap. 64.

charged amphoteric lipids such as unesterified cholesterol and the phosphatidylcholines (see Chapter 10). Amphoteric lipids and proteins in the outer shell place their hydrophobic apolar regions toward the inside of the particle and their charged groups toward the outside where they interact with each other and with water.

This spherical structural model with a hydrophobic inner core of neutral lipids and amphoteric lipids and proteins in the outer shell applies to all plasma lipoproteins, irrespective of their density class and particle size. The smaller lipoprotein particles, such as HDLs, have a smaller diameter. As the diameter of a spherical particle decreases, the molecules in the outer shell make up a greater percentage of the total molecules in the particle. The smaller HDL particles would therefore be theoretically predicted to have a higher percentage of surface proteins and amphoteric lipids than the larger VLDL particles. Thus the HDL particle is 45% protein and 55% lipid, while the larger VLDL particle is only 10% protein with 90% lipid (Table 2.14).

The apolipoproteins, with the exception of ApoB, have a high α -helical content when in association with lipid. The helical regions have amphipathic properties. Every third or fourth amino acid in the helix is charged and forms a polar edge along the helix that associates with the polar heads of phospholipids and the aqueous solvent on the outside. The opposite side of the helix has hydrophobic side chains that associate with the nonpolar neutral lipid core of the phospholipid particle. The α -helical structure of part of ApoC-I is shown

TABLE 2.14 Chemical Composition of the Different Plasma Lipoprotein Classes

Lipoprotein Class	Total Protein (%)	Total Lipid (%)	Percent Composition of Lipid Fraction			
			Phospholipids	Esterified Cholesterol	Unesterified Cholesterol	Triacylglycerols
HDL ₂ ^a	40–45	55	35	12	4	5
HDL ₃ ^a	50–55	50	20–25	12	3–4	3
LDL	20–25	75–80	15–20	35–40	7–10	7–10
IDL	15–20	80–85	22	22	8	30
VLDL	5–10	90–95	15–20	10–15	5–10	50–65
Chylomicrons	1.5–2.5	97–99	7–9	3–5	1–3	84–89

Source: Data from Soutar, A. K., and Myant, N. B. In R. E. Offord (Ed.), *Chemistry of Macromolecules*, IIB. Baltimore, MD: University Park Press, 1979.

^a Subclasses of HDL.

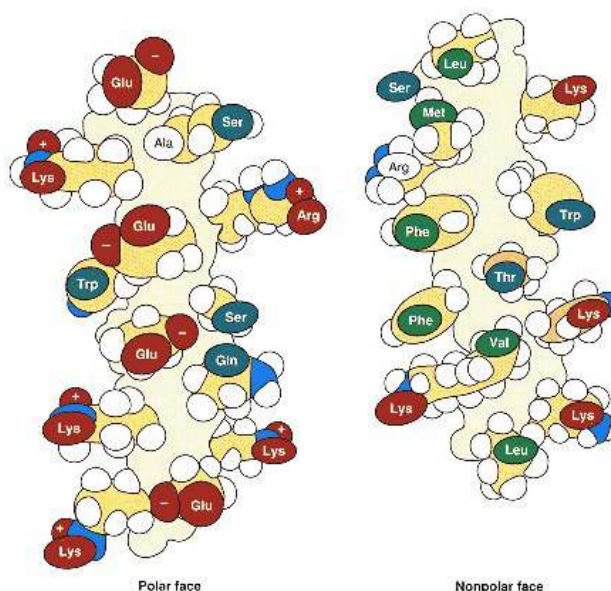

Figure 2.44

Illustration showing side chains of a helical segment of apolipoprotein C-1 between residues 32 and 53.

The polar face shows ionizable acid residues in the center and basic residues at the edge. On the other side of the helix, the hydrophobic residues form a nonpolar longitudinal face. Redrawn with permission from Sparrow, J. T., and Gotto, A. M., Jr. *CRC Crit. Rev. Biochem.* 13:87, 1983.

Copyright © CRC Press, Inc., Boca Raton, FL.

in Figure 2.44. ApoB appears to have both α -helical and β -structural regions embedded in the phospholipid outer core. The long 4536 amino acid polypeptide chain of ApoB-100 surrounds the circumference of the LDL particle like a belt weaving in and out of the monolayer phospholipid outer shell (Figure 2.43). One ApoB molecule associates per LDL particle.

Glycoproteins Contain Covalently Bound Carbohydrate

Glycoproteins participate in many normal and disease-related functions of clinical relevance. Many plasma membrane proteins are glycoproteins. Some may be antigens, which determine the blood antigen system (A, B, O) and the histocompatibility and transplantation determinants of an individual. Immunoglobulin antigenic sites and viral and hormone receptor sites in plasma membranes are often glycoproteins. The carbohydrate portions of glycoproteins in membranes provide a surface code for identification by other cells and for contact inhibition in the regulation of cell growth. Changes in membrane glycoproteins can be correlated with tumorigenesis and malignant transformation in cancer. Most plasma proteins, except albumin, are glycoproteins including blood-clotting proteins, immunoglobulins, and many of the complement proteins. Some protein hormones, such as follicle-stimulating hormone (FSH) and thyroid-stimulating hormone (TSH), are glycoproteins. The structural proteins collagen, laminin, and fibronectin contain carbohydrate, as do proteins of mu-

cous secretions that perform a role in lubrication and protection of epithelial tissue.

The percentage of carbohydrate in glycoproteins is variable. IgG antibody molecules contain low amounts of carbohydrate (4%), whereas glycophorin of human red blood cell membranes is 60% carbohydrate. Human gastric glycoprotein is 82% carbohydrate. The carbohydrate can be distributed evenly along the polypeptide chain or concentrated in defined regions. For plasma membrane proteins, typically only the portion located on the outside of the cell has carbohydrate covalently attached. The carbohydrate attached at one or at multiple points along a polypeptide chain usually contains less than 15 sugar residues and in some cases only one sugar residue. Glycoproteins with the same function from different animal species often have homologous amino acid sequences but variable carbohydrate structures. Heterogeneity in carbohydrate content can occur in the same protein within a single organism. For example, pancreatic ribonuclease A and B forms have an identical primary structure but differ in their carbohydrate composition.

Functional glycoproteins are also found in different stages of completion. Addition of complex carbohydrate units occurs in a series of enzyme-catalyzed reactions as the polypeptide chain is transported through the endoplasmic reticulum and Golgi network (see Chapter 17). Immature glycoproteins are sometimes expressed with intermediate stages of carbohydrate additions.

Types of Carbohydrate–Protein Covalent Linkages

Different types of covalent linkages join the sugar moieties and protein in a glycoprotein. The two most common are the *N*-glycosidic linkage (type I linkage) between an asparagine amide group and a sugar, and the *O*-glycosidic linkage (type II linkage) between a serine or threonine hydroxyl group and a sugar (Figure 2.45). In type I linkage the bond to asparagine is within the sequence Asn-X-Thr(Ser). Another linkage found in mammalian glycoproteins is an *O*-glycosidic bond to a 5-hydroxylysine residue (type III linkage) found in collagens and in the serum complement protein C1q. Less common linkages include attachment to the hydroxyl group of 4-hydroxyproline (type IV linkage), to a cysteine thiol side chain (type V linkage), and to a NH_2 -terminal α -amino group of a polypeptide chain (type VI linkage). High concentrations of type VI linkages are spontaneously formed with hemoglobin and blood glucose in uncontrolled diabetics. Assay of the concentration of glycosylated hemoglobin is used to follow changes in blood glucose concentration (see Clin. Corr. 2.7).

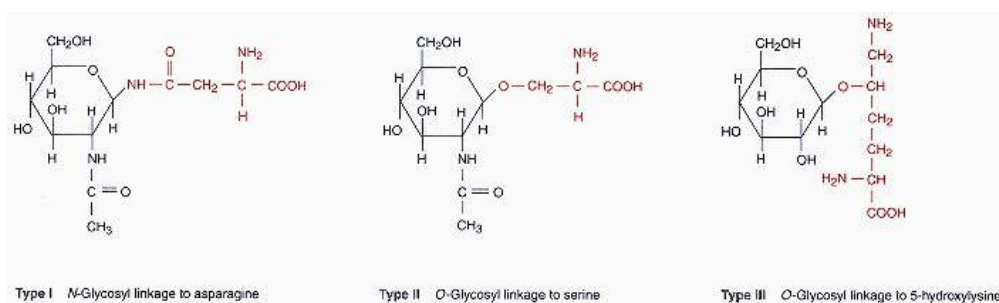

Figure 2.45

Examples of glycosidic linkages to amino acids in proteins.

Type I is an *N*-glycosidic linkage through an amide nitrogen of Asn; type II is an *O*-glycosidic linkage through the OH of Ser or Thr; and type III is an *O*-glycosidic linkage to the 5-OH of 5-hydroxylysine.

CLINICAL CORRELATION 2.7**Glycosylated Hemoglobin, HbA_{1c}**

A glycosylated hemoglobin, designated HbA_{1c}, is formed spontaneously in red blood cells by combination of the NH₂-terminal amino groups of the hemoglobin β -chain and glucose. The aldehyde group of the glucose first forms a Schiff base with the NH₂-terminal amino group,

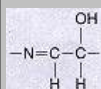

which then rearranges to a more stable amino ketone linkage,

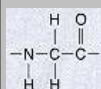

by a spontaneous (nonenzymatic) reaction known as the Amadori rearrangement. The concentration of HbA_{1c} is dependent on the concentration of glucose in the blood and the duration of hyperglycemia. In prolonged hyperglycemia the concentration may rise to 12% or more of the total hemoglobin. Patients with diabetes mellitus have high concentrations of blood glucose and therefore high amounts of HbA_{1c}. The changes in the concentration of HbA_{1c} in diabetic patients can be used to follow the effectiveness of treatment for the diabetes.

Bunn, H. F. Evaluation of glycosylated hemoglobin in diabetic patients. *Diabetes* 30:613, 1980; and Brown, S.B., and Bowes, M. A. Glycosylated haemoglobins and their role in management of diabetes mellitus. *Biochem. Educ.* 13:2, 1985.

2.7—**Folding of Proteins from Randomized to Unique Structures:
Protein Stability*****The Protein Folding Problem:
A Possible Pathway***

The ability of a primary protein structure to fold spontaneously to its native secondary or tertiary conformation, without any information other than the amino acid sequence and the noncovalent forces that act on the sequence, has been demonstrated. RNase will spontaneously refold to its native conformation after being denatured with loss of native structure but without the hydrolysis of peptide bonds. Such observations led to the hypothesis that a polypeptide sequence contains the properties sufficient to promote spontaneous protein folding to its unique active conformation under the correct solvent conditions and in the presence of prosthetic groups that may be a part of its structure. As described below chaperone proteins may facilitate the rate of protein folding. Quaternary structures also assemble spontaneously, after the tertiary structure of the individual polypeptide subunits are formed.

It may appear surprising that a protein folds into a single unique conformation given all the possible *a priori* rotational conformations available around single bonds in the primary structure. For example, the α -chain of hemoglobin contains 141 amino acids in which there are at least four single bonds per amino acid residue around which free rotation can occur. If each bond about which free rotation occurs has two or more stable rotamer conformations accessible to it, then there are a minimum of 4^{141} or 5×10^{86} possible conformations for the α -chain amino acid sequence.

The **conformation of a protein** is that conformation of the lowest Gibbs free energy accessible to the amino acid sequence within a physiological time frame. Thus folding is under thermodynamic and kinetic control. Although an exact knowledge of *de novo* folding of a polypeptide is at present an unattainable goal, certain processes appear reasonable. There is evidence that folding is initiated by short-range interactions forming secondary structures in small regions of the polypeptide. Short-range interactions are noncovalent interactions that occur between a side chain and its nearest neighbors. Particular side chains have a propensity to promote the formation of α -helices, β -structure, and sharp turns or bends (β -turns) in the polypeptide. The interaction of a side chain with its nearest neighbors in the polypeptide determines the secondary structure

into which that section of the polypeptide strand folds. Sections of polypeptide, called **initiation sites**, thus spontaneously fold into small regions of secondary structure. The partially folded structures then condense with each other to form a **molten-globular** state. This is a condensed intermediate on the folding pathway that contains much of the secondary structure elements of the native structure, but a large number of incorrect tertiary structure interactions. Segments of secondary structure in the molten-globular state are highly mobile relative to one another, and the molten-globular structure is in rapid equilibrium with the fully unfolded denatured state. The correct medium- and long-range interactions between different initiation sites are found by rearrangements within the molten-globule and the low free energy, native tertiary structure for the polypeptide chain is formed. With formation of the native tertiary structure, the correct disulfide bonds (cysteine) are formed. The rate-determining step for folding and unfolding of the native conformation lies between the molten-globular state and the native structure.

Chaperone Proteins May Assist the Protein Folding Process

Cells contain proteins that facilitate the folding process. These include *cis-trans*-prolyl isomerases, protein disulfide isomerases, and chaperone proteins. ***cis-trans*-Prolyl isomerases** increase the rate of folding by catalyzing interconversion of *cis*- and *trans*-peptide bonds of proline residues within the polypeptide chain. This allows the correct proline peptide bond conformation to form for each proline as required by the folded native structure. **Protein disulfide isomerases** catalyze the breakage and formation of disulfide cystine linkages so incorrect linkages are not stabilized and the correct arrangement of cystine linkages for the folded conformation is rapidly achieved.

Chaperone proteins were discovered as **heat shock proteins (hsps)**, a family of proteins whose synthesis is increased at elevated temperatures. The chaperones do not change the final outcome of the folding process but act to prevent protein aggregation prior to the completion of folding and to prevent formation of metastable dead-end or nonproductive intermediates during folding. They increase the rate of the folding process by limiting the number of unproductive folding pathways available to a polypeptide. Chaperones of the hsp 70-kDa family bind to polypeptide chains as they are synthesized on the ribosomes, shielding the hydrophobic surfaces that would normally be exposed to solvent. This protects the protein from aggregation until the full chain is synthesized and folding can occur. Some proteins, however, cannot complete their folding process while in the presence of hsp70 chaperones and are delivered to the hsp60 family (GroEL in *Escherichia coli*) of chaperone proteins, also called **chaperonins**. The chaperonins form long cylindrical multisubunit quaternary structures that bind unfolded proteins in their molten-globular state within their central hydrophobic cavity. Chaperonins have an ATPase activity, hydrolyzing ATP as they facilitate folding. The folding process in *E. coli* is presented in Figure 2.46. Chaperone proteins are also required for refolding of proteins after they cross cellular membranes. A system of chaperones exists to facilitate protein transport into mitochondria and into and through the endoplasmic reticulum. Proteins cross the lipid bilayer of the mitochondrial and endoplasmic reticulum membranes in an unfolded conformation, and local chaperones are required to facilitate their folding.

Noncovalent Forces Lead to Protein Folding and Contribute to a Protein's Stability

Noncovalent forces cause a polypeptide to fold into a unique conformation and then stabilize the native structure against denaturation. Noncovalent forces are weak bonding forces with strengths of 1–7 kcal mol⁻¹ (4–29 kJ mol⁻¹). This may be compared to the strength of covalent bonds that have a bonding strength

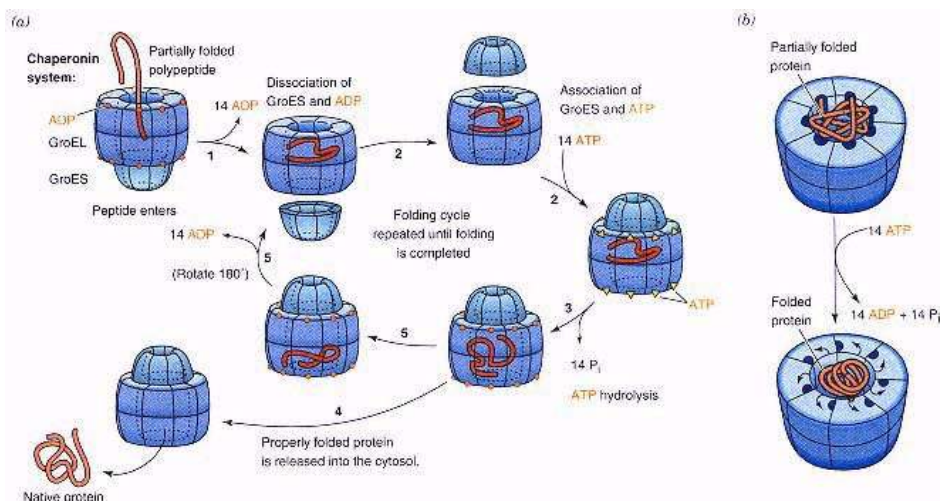

Figure 2.46

Chaperonin directed protein folding in *E. coli*.

(a) A proposed reaction cycle of the *E. coli* chaperonins

GroEL and GroES in protein folding.

(1) GroEL is a complex of 14 subunits, each with ADP attached. An associated ring of 8 GroES subunits binds an unfolded polypeptide in its central cavity and ADP and GroES are released.

(2) Each GroEL

subunit binds an ATP, weakening the interaction between unfolded polypeptide and GroEL. GroES is rebound on the opposite face of GroEL.

(3) The 14 ATP are simultaneously hydrolyzed, releasing the bound polypeptide inside GroEL. The polypeptide, which is probably in its molten-globular state, folds in a protected microenvironment, preventing aggregation with other partially folded polypeptides.

(4) The polypeptide is released from GroEL after folding into its native conformation.

(5) If the polypeptide fails to attain its native fold, it remains bound to GroEL and reenters the reaction cycle at step 2. In the diagram GroEL turns over by 180°. GroES binds but does not hydrolyze ATP and facilitates the binding of ATP to GroEL. It coordinates simultaneous hydrolysis of ATP and prevents escape of a partially folded polypeptide from the GroEL cavity.

(b) A model for the ATP-dependent release of an unfolded polypeptide from its multiple attachment sites in GroEL. ATP binding and hydrolysis mask the hydrophobic sites of GroEL (darker areas) that bind to the unfolded polypeptide, thus permitting it to fold in an isolated environment.

Adapted from Hartl, R.-U., Hlodan, R., and Langer, T. *Trends Biochem. Sci.* 19:23, 1994. Figure reproduced with permission from Voet, D., and Voet, J. *Biochemistry*, 2nd ed., New York: John Wiley, 1995.

of at least 50 kcal mol⁻¹ (Table 2.15). Even though individually weak, the large number of individually weak noncovalent contacts within a protein add up to a large energy factor that promotes protein folding.

Hydrophobic Interaction Forces

The most important noncovalent forces that cause a randomized polypeptide conformation to lose rotational freedom and fold into its native structure are **hydrophobic interaction forces**. The strength of a hydrophobic interaction is not due to an intrinsic attraction between nonpolar groups, but rather to the properties of the water solvent in which the nonpolar groups are dissolved. A nonpolar molecule or a region of a protein molecule dissolved in water induces a solvation shell of water in which water molecules are highly ordered. When two nonpolar side chains come together on folding of a polypeptide, the surface area exposed to solvent is reduced and some of the highly ordered water

TABLE 2.15 Bond Strength of Typical Bonds Found in Protein Structures

Bond Type	Bond Strength (kcal mol^{-1})
Covalent bonds	>50
Noncovalent bonds	0.6–7
Hydrophobic bond (i.e., two benzyl side chain groups of Phe)	2–3
Hydrogen bond	1–7
Ionic bond (low dielectric environment)	1–6
van der Waals	<1
Average energy of kinetic motion (37°C)	0.6

molecules in the solvation shell are released to bulk solvent. Accordingly, the entropy of the system (i.e., net disorder of the water molecules in the system) is increased. The increase in entropy is thermodynamically favorable and is the driving force causing nonpolar moieties to come together in aqueous solvent. A favorable free energy change of -2 kcal mol^{-1} for association of two phenylalanine side chain groups in water is due to this favorable water solvent entropy gain (Figure 2.47).

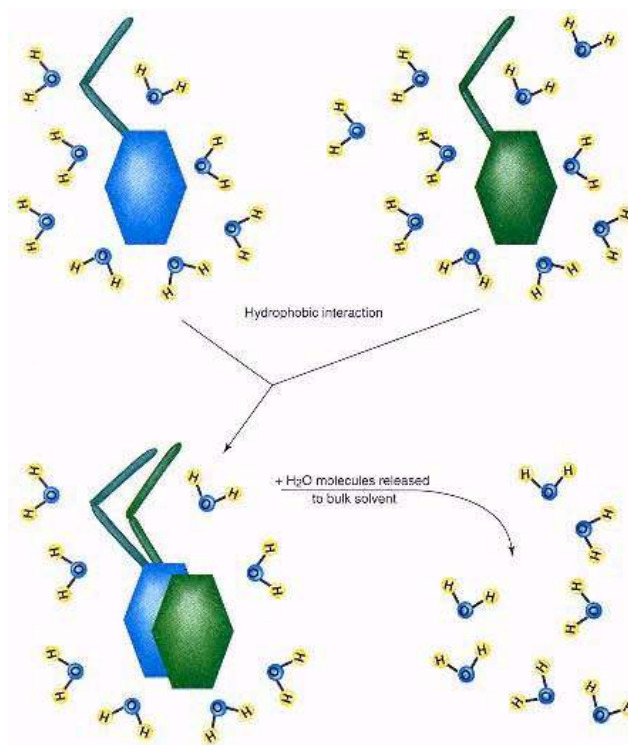

Figure 2.47

Formation of hydrophobic interaction between two phenylalanine side chain groups.

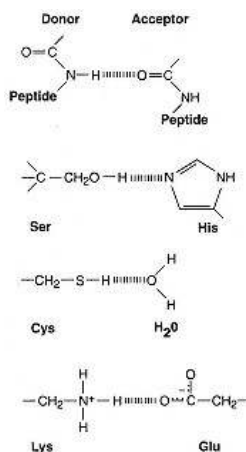

Figure 2.48
Some common hydrogen
bonds found in proteins.

In transition from a random into a regular secondary conformation such as an α -helix or β -structure, approximately one-third of the ordered water of solvation about the unfolded polypeptide is lost to bulk solvent. This approximates $0.5\text{--}0.9\text{ kcal mol}^{-1}$ for each peptide residue. An additional one-third of the original solvation shell is lost when a protein that has folded into a secondary structure folds into a tertiary structure. The tertiary folding brings different segments of folded polypeptide chains into close proximity with the release of water of solvation between the polypeptide chains.

Hydrogen Bonds

Another noncovalent force in proteins is hydrogen bonding. **Hydrogen bonds** are formed when a hydrogen atom covalently bonded to an electronegative atom is shared with a second electronegative atom. The atom to which the hydrogen atom is covalently bonded is designated the hydrogen-**donor atom**. The atom with which the hydrogen atom is shared is the hydrogen-**acceptor atom**. Typical hydrogen bonds found in proteins are shown in Figure 2.48. α -Helical and β -structure conformations are extensively hydrogen bonded.

The strength of a hydrogen bond is dependent on the distance between the donor and acceptor atoms. High bonding energies occur when the distance is between 2.7 and 3.1 Å. Of lesser importance, but not negligible, to bonding strength is the dependence of hydrogen-bond strength on geometry. Bonds of higher energy are geometrically collinear, with donor, hydrogen, and acceptor atoms lying in a straight line. The dielectric constant of the medium around the hydrogen bond may also be reflected in the bonding strength. Typical hydrogen-bond strengths in proteins are $1\text{--}7\text{ kcal mol}^{-1}$. Although hydrogen bonds contribute to thermodynamic stability of a protein's conformation, their formation may not be as major a driving force for folding as we might at first believe. This is because peptide bonds and other hydrogen-bonding groups in proteins form hydrogen bonds to the water solvent in the denatured state, and these bonds must be broken before the protein folds. The energy required to break the hydrogen bonds to water must be subtracted from the energy gained from formation of new hydrogen bonds between atoms in the folded protein in calculating the net contribution of hydrogen-bonding forces to the folding.

Electrostatic Interactions

Electrostatic interactions (also referred to as **ionic** or **salt linkages**) between charged groups are important in the stabilization of protein structure and in binding of charged ligands and substrates to proteins. Electrostatic forces are repulsive or attractive depending on whether the interacting charges are of the same or opposite sign. The strength of an electrostatic force (E_{el}) is directly dependent on the charge (Z) of each ion and is inversely dependent on the dielectric constant (D) of the solvent and the distance between the charges (r_{ab}) (Figure 2.49).

$$E_{el} \approx \frac{Z_A \cdot Z_B \cdot e^2}{D \cdot r_{ab}}$$

Figure 2.49
Strength of
electrostatic
interactions.

Water has a high dielectric constant ($D = 80$), and interactions in water are relatively weak in comparison to the strength of charge interactions in the interior of a protein where the dielectric constant is low. However, most charged groups of proteins remain on the surface of the protein where they do not interact with other charged groups from the protein because of the high dielectric constant of the water solvent, but are stabilized by hydrogen bonding and polar interactions to the water. These water interactions generate the dominant forces that lead to placement of most charged groups of a protein on the outside of the folded structures.

Van der Waals–London Dispersion Forces

Van der Waals and **London dispersion forces** are the weakest of the noncovalent forces. They have an attractive term (A) inversely dependent on the 6th

power of the distance between two interacting atoms (r_{ab}), and a repulsive term (B) inversely dependent on the 12th power of r_{ab} (Figure 2.50). The A term contributes at its optimum distance an attractive force of less than 1 kcal mol⁻¹ per atomic interaction due to the induction of complementary partial charges or dipoles in the electron density of adjacent atoms when the electron orbitals of the two atoms approach to a close distance. As the atoms come even closer, however, the repulsive component (term B) of the van der Waals force predominates as the electron orbitals of the adjacent atoms begin to overlap. The repulsive force is commonly called **steric hindrance**.

$$E_{VDW} = -\frac{A}{r_{ab}} + \frac{B}{r_{ab}^{12}}$$

Figure 2.50
Strength
of van
der Waals
interactions.

The distance of maximum favorable interaction between two atoms is the **van der Waals contact distance**, which is the sum of the van der Waals radii for the two atoms (Figure 2.51). The van der Waals radii for atoms found in proteins are given in Table 2.16.

The van der Waals repulsive forces between atoms attached to a peptide bond are weakest at the specific ϕ and ψ angles compatible with the α -helix and β -strand structures. Thus van der Waals forces are critical for secondary structure formation in proteins. In folding into a tertiary structure, the number of weak van der Waals interactions that occur are in the thousands. Thus the total contribution of van der Waals–London dispersion forces to the stability of a folded structure is substantial, even though a single interaction between any two atoms is less than 1 kcal mol⁻¹.

A special type of interaction (π -electron– π -electron) occurs when two aromatic rings approach each other with electrons of their aromatic rings favorably interacting (Figure 2.52). This interaction can result in attractive forces of up to 6 kcal mol⁻¹. A number of π - π aromatic interactions occur in a typical folded protein, contributing to the stability of the folded structure.

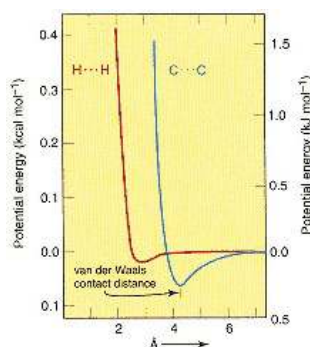

Figure 2.51
Van der Waals–London dispersion interaction energies between two hydrogen atoms and two (tetrahedral) carbon atoms.

Negative energies are favorable and positive energies unfavorable.
Redrawn from Fersht, A. *Enzyme Structure and Mechanism*. San Francisco: Freeman, 1977, p. 228.

Denaturation of Proteins Leads to Loss of Native Structure

Denaturation occurs when a protein loses its native secondary, tertiary, and/or quaternary structure. The primary structure is not necessarily broken by denaturation. The **denatured state** is always correlated with the loss of a protein's function. Loss of a protein's function is not necessarily synonymous with denaturation, however, because small conformational changes can lead

TABLE 2.16 Covalent Bond Radii and van der Waals Radii for Selected Atoms

Atom	Covalent Radius (Å)	van der Waals Radius (Å) ^a
Carbon (tetrahedral)	0.77	2.0
Carbon (aromatic)	0.69 along=bond	1.70
	0.73 along–bond	
Carbon (amide)	0.72 to amide N	1.50
	0.67 to oxygen	
	0.75 to chain C	
Hydrogen	0.33	1.0
Oxygen (–O–)	0.66	1.35
Oxygen (=O)	0.57	1.35
Nitrogen (amide)	0.60 to amide C	1.45
	0.70 to hydrogen bond H	
	0.70 to chain C	
Sulfur, diagonal	1.04	1.70

Source: Fasman, G. D. (Ed.), *CRC Handbook of Biochemistry and Molecular Biology*, 3rd ed., Sect. D, Vol. II, Boca Raton, FL: CRC Press, 1976, p. 221.

^a The van der Waals contact distance is the sum of the two van der Waals radii for the two atoms in proximity.

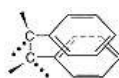

Figure 2.52
-Electron–-electron
interactions between
two aromatic rings.

to loss of function. A change in conformation of a single side chain in the active site of an enzyme or a change in protonation of a side chain can result in loss of activity, but does not lead to a complete loss of the native protein structure.

Even though conformational differences between denatured and native structures may be substantial, the free energy difference between such structures can in some cases be as low as the free energy of three or four noncovalent bonds. Thus the loss of a single hydrogen bond or electrostatic or hydrophobic interaction can lead to destabilization of a folded structure. A change in stability of a noncovalent bond can, in turn, be caused by a change in pH, ionic strength, or temperature. Binding of prosthetic groups, cofactors, and substrates also affects stability of the native conformation.

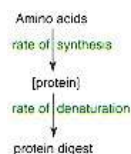

Figure 2.53
Steady-state concentration of a protein is due to its rates of synthesis and denaturation.

The statement that the breaking of a single noncovalent bond in a protein can cause denaturation apparently conflicts with the observation that the amino acid sequence can often be extensively varied without loss of a protein's structure. The key to the resolution of this apparent conflict is the word "essential." Many noncovalent interactions are not essential to the structural stability of the native conformation of a protein. However, substitution or modification of an essential amino acid that provides a critical noncovalent interaction dramatically affects the stability of a native protein structure.

The concentration of a protein in a cell is controlled by its rate of synthesis and degradation (Figure 2.53). Understanding the processes that control protein degradation is therefore as equally important as an understanding of the processes that regulate protein synthesis. Under many circumstances the denaturation of a protein is the rate-controlling step in its degradation. Cellular enzymes and organelles that digest proteins "recognize" denatured protein conformations and eliminate them rapidly. In experimental situations, protein denaturation occurs on addition of urea or detergents (sodium dodecyl sulfate or guanidine hydrochloride) that weaken hydrophobic bonding in proteins. These reagents stabilize the denatured state and shift the equilibrium toward the denatured form of the protein. Addition of strong base, acid, or organic solvent, or heating to temperatures above 60°C are also common ways to denature a protein.

2.8— Dynamic Aspects of Protein Structure

While high-resolution X-ray diffraction experiments yield atomic coordinates for each atom in a protein structure, experimental evidence from NMR, fluorescence spectroscopy, and the temperature dependence of the X-ray diffraction reveals that the atoms in a folded protein molecule have a fluid-like dynamic motion and do not exist in a single static position. Rather than an exact location, the atomic coordinates obtained by X-ray diffraction represent the time-averaged position for each atom. The time frame for position averaging is the length of time for data collection, which may be several days. Thus the active conformation may differ from the average conformation. An X-ray structure also shows small "defects" in packing of the folded structure, indicating the existence of "holes" in the structure that will allow the protein space for flexibility. The concept that each atom in a protein is in constant motion such as molecules within a fluid, although constrained by its covalent bonds and the secondary and tertiary structure, is an important aspect of protein structure.

Theoretical **molecular dynamics** calculations describe the changes in coordinates of atoms in a folded protein structure, with corresponding changes in position of regions of the structure due to summation of the movements of atoms in that region. The dynamic motion computation is based on the solving of Newton's equations of motion simultaneously for all the atoms of the protein and the solvent that interacts with the protein. The energy functions used in the equation include representations of covalent and noncovalent bonding energies due to electrostatic forces, hydrogen bonding, and van der Waals

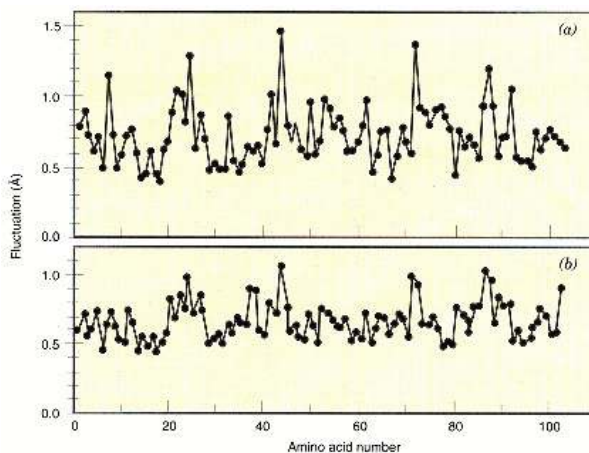

Figure 2.54
Fluctuation of structure of cytochrome c.

- (a) Calculated fluctuation on a picosecond time scale of α -carbons within each amino acid residue in the folded structure of cytochrome-c and
 (b) experimentally observed fluctuation of each α -carbon of the amino acid residues determined from the temperature dependency of the X-ray diffraction pattern for the protein. Cytochrome-c has 103 amino acid residues. The x-axis plots the amino acid residues in cytochrome-c from 1 to 103, and the y-axis the fluctuation distances in angstroms.

Redrawn from Karplus, M., and McCammon, J. A. *Annu. Rev. Biochem.* 53:263, 1983.

forces. Individual atoms are randomly assigned a velocity from a theoretical distribution and Newton's equations are used to "relax" the system at a given "temperature." The calculation is a computationally intensive activity, even when limited to less than several hundred picoseconds ($1 \text{ ps} = 10^{-12} \text{ s}$) of protein dynamic time, and frequently requires supercomputers. These calculations indicate that the average atom within a typical protein is oscillating over a distance of 0.7 \AA on the picosecond scale. Some atoms or groups of atoms move smaller or larger distances than this calculated average (Figure 2.54).

Net movement of any segment of a polypeptide over time represents the sum of forces due to rapid atomic oscillations and the local jiggling and elastic movements of covalently attached groups of atoms. These movements within the closely packed interior of a protein molecule are frequently large enough to allow the planar aromatic rings of buried tyrosines to flip. Furthermore, the small amplitude fluctuations provide the "lubricant" for large motions in proteins such as domain motions and quaternary structure changes, like those observed in hemoglobin on O_2 binding (see Chapter 3). The dynamic behavior of proteins is implicated in conformational changes induced by substrate, inhibitor, or drug binding to enzymes and receptors, generation of allosteric effects in hemoglobins, electron transfer in cytochromes, and in the formation of supramolecular assemblies such as viruses. The movements may also have a functional role in the protein's mechanism of action.

2.9—

Methods for Characterization, Purification, and Study of Protein Structure and Organization

Separation of Proteins on Basis of Charge

In **electrophoresis**, the protein dissolved in a solution buffered at a particular pH is placed in an electric field. Depending on the relationship of the buffer pH to the pI of the protein, the molecule moves toward the cathode (–) or the anode (+) or remains stationary ($\text{pH} = pI$). Procedures for electrophoresis use supports such as polymer gels (e.g., polyacrylamide), starch, or paper. The inert supports are saturated with buffer solution, a sample of protein is placed

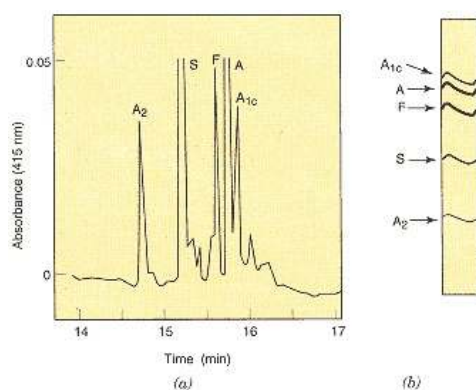

Figure 2.55
Isoelectric focusing of hemoglobins from patient heterozygous for HbS and β -thalassemia.

Figure shows separation by isoelectric focusing of HbA_{1c} (HbA glycosylated on NH₂ end, see Clin. Corr. 2.7), normal adult HbA, fetal HbF, sickle cell HbS (see Clin. Corr. 2.3), and the minor adult HbA₂.
 (a) Isoelectric focusing carried out by capillary electrophoresis with ampholyte pH range between 6.7 and 7.7 and detection of bands at 415 nm.
 (b) Isoelectric focusing carried out on gel with Pharmacia PhastSystem; ampholyte pH range is between 6.7 and 7.7.
 From Molteni, S., Frischknecht, H., and Thormann, W. *Electrophoresis* 15:22, 1994 (Figure 4, parts A and B).

on the support, an electric field is applied across the support, and the charged proteins migrate in the support toward the oppositely charged pole.

An electrophoresis technique with extremely high resolution is **isoelectric focusing**, in which mixtures of polyamino–polycarboxylic acid ampholytes with a defined range of *pI* values are used to establish a pH gradient across the applied electric field. A charged protein migrates through the pH gradient in the electric field until it reaches a pH region in the gradient equal to its *pI* value. At this point the protein becomes stationary and may be visualized (Figure 2.55). Proteins that differ by as little as 0.0025 in *pI* values are separated on the appropriate pH gradient.

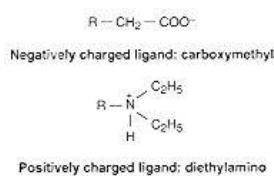

Figure 2.56
 Two examples of charged ligands used in ion-exchange chromatography.

Ion-exchange column chromatography is used for preparative separation of proteins by charge. Ion-exchange resins consist of insoluble materials (agarose, polyacrylamide, cellulose, and glass) that contain negatively or positively charged groups (Figure 2.56). Negatively charged resins bind cations strongly and are **cation-exchange resins**. Positively charged resins bind anions strongly and are **anion-exchange resins**. The degree of retardation of a protein (or an amino acid) by a resin depends on the magnitude of the charge on the protein at the particular pH of the experiment. Molecules of the same charge as the resin are eluted first in a single band, followed by proteins with an opposite charge to that of the resin, in an order based on the protein's charge density (Figure 2.57). When it is difficult to remove a molecule from the resin because of the strength of the attractive interaction between the bound molecule and resin, systematic changes in pH or in ionic strength are used to weaken the interaction. For example, an increasing pH gradient through a cation-exchange resin reduces the difference between the solution pH and the *pI* of the bound protein. This decrease between pH and *pI* reduces the magnitude of the net charge on the protein and decreases the strength of the charge interaction between the protein and the resin. An increasing gradient of ionic strength also decreases the strength of charge interactions and elutes tightly bound electrolytes from the resin.

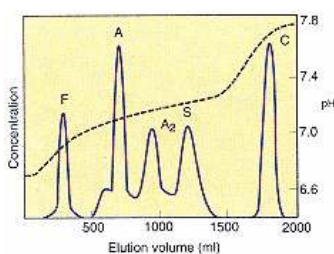

Figure 2.57
Example of ion-exchange chromatography.
 Elution diagram of an artificial mixture of hemoglobins F, A, A₂, S, and C on carboxymethyl–Sephadex C-50.
 From Dozy, A. M., and Juisman, T. H. J. *J. Chromatog.* 40:62, 1969.

Capillary Electrophoresis

Electrophoresis within a fused silica capillary tube has a high separation efficiency, utilizes very small samples, and requires only several minutes for an assay. A long capillary tube is filled with the electrophoretic medium, the sample is injected in a narrow band near the anode end of the tube, and the molecules of the sample are separated by their mobility toward the negatively charged pole. The fused silica wall of the capillary has a negatively charged surface to

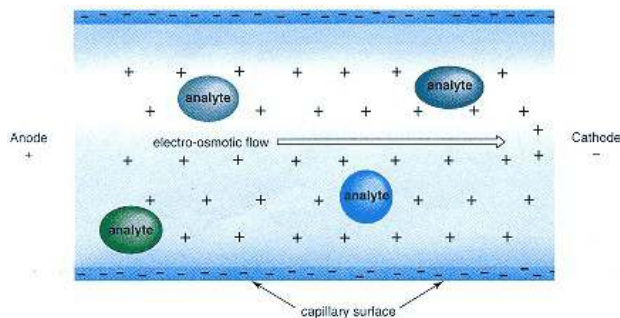

Figure 2.58

Generation of electro-osmotic flow toward cathode in capillary electrophoresis.

which an immobile cationic layer is fixed. An adjacent diffuse layer of cations moves toward the cathode in the applied electric field and causes a flow of solvent toward the cathode. This electro-osmotic flow creates a "current" that carries analyte molecules toward the cathode, irrespective of the analyte's charge (Figure 2.58). Molecules with a high positive charge to mass ratio "swim" with the current and have the highest mobility, followed by neutral molecules. Anionic molecules will be repelled by the cathode and will "swim" against the electro-osmotic flow. However, the electro-osmotic current toward the cathode overcomes any negative migration, and anions also migrate toward the cathode but at a slower rate than the cationic or neutral molecules.

In addition to zone electrophoresis, in which the separations are run in the presence of a single buffer, capillary electrophoresis may be performed in the presence of ampholytes to separate proteins by isoelectric focusing, in the presence of a porous gel to separate proteins by molecular weight, or in the presence of a micellar component to separate by hydrophobicity. Detectors that utilize UV light, fluorescence, Raman spectroscopy, electrochemical detection, or mass spectroscopy make the capillary method sensitive and versatile.

Separation of Proteins Based on Molecular Mass or Size

Ultracentrifugation:

Definition of Svedberg Coefficient

A protein subjected to centrifugal force moves in the direction of the force at a velocity dependent on its mass. The rate of movement is measured with an appropriate optical detection system, and from the rate the sedimentation coefficient is calculated in **Svedberg units** (units of 10^{-13} s). In the equation (Figure 2.59), v is the measured velocity of protein movement, ω the angular velocity of the centrifuge rotor, and r the distance from the center of the tube in which the protein is placed to the center of rotation. Sedimentation coefficients between 1 and 200 Svedberg units (S) have been found for proteins (Table 2.17). Equations have been derived to relate the sedimentation coefficient to the molecular mass of a protein. One of the more simple equations is shown in Figure 2.60, in which R is the gas constant, T the temperature, s the sedimentation coefficient, D the diffusion coefficient of the protein, \bar{v} are difficult, usually only the sedimentation coefficient for a molecule is reported. A protein's sedimentation coefficient is a qualitative measurement of molecular mass.

$$s = \frac{v}{\omega^2 r}$$

Figure 2.59
Equation for calculation of the Svedberg coefficient.

$$\text{Molecular weight} = \frac{RTs}{D(1 - \bar{v}\rho)}$$

Figure 2.60
An equation relating the Svedberg coefficient to molecular weight.

TABLE 2.17 Svedberg Coefficients for Some Plasma Proteins of Different Molecular Weights

Protein	$s_{20}^0 \times 10^{-13}$ ($\text{cm s}^{-1} \text{ dyn}^{-1}$) ^a	Molecular Weight
Lysozyme	2.19	15,000–16,000
Albumin	4.6	69,000
Immunoglobulin G	6.6–7.2	153,000
Fibrinogen	7.63	341,000
Clq (factor of complement)	11.1	410,000
α_2 -Macroglobulin	19.6	820,000
Immunoglobulin M	18–20	1,000,000
Factor VIII of blood coagulation	23.7	1,120,000

Source: Fasman, G.D. (Ed.), *CRC Handbook of Biochemistry and Molecular Biology*, 3rd ed., Sect. A, Vol. II. Boca Raton, FL: CRC Press, 1976, p. 242.

^a $s_{20}^0 \times 10^{-13}$ is sedimentation coefficient in Svedberg units, referred to water at 20°C, and extrapolated to zero concentration of protein.

Molecular Exclusion Chromatography

A porous gel in the form of small insoluble beads is commonly used to separate proteins by size in column chromatography. Small protein molecules penetrate the pores of the gel and have a larger solvent volume through which to travel in the column than large proteins, which are sterically excluded from the pores. Accordingly, a protein mixture is separated by size. The larger proteins are eluted first, followed by the smaller proteins, which are retarded by their accessibility to a larger solvent volume (Figure 2.61). As with ultracentrifugation, an assumption is made as to the geometry of an unknown protein in the determination of molecular mass. Elongated nonspheroidal proteins give anomalous molecular masses when analyzed using a standard curve determined with proteins of spheroidal geometry.

Polyacrylamide Gel Electrophoresis in the Presence of a Detergent

If a charged detergent is added to a protein electrophoresis assay and electrophoresis occurs through a sieving support, the separation of proteins is based on protein size and not charge. A common detergent is **sodium dodecyl sulfate (SDS)** and a common sieving support is **cross-linked polyacrylamide**. The dodecyl sulfates are amphiphilic C12 alkyl sulfate molecules, which stabilize a denatured protein by forming a charged micellar SDS solvation shell around its polypeptide chain. The inherent charge of the polypeptide chain is obliterated by the negatively charged micelle of SDS molecules, and each protein–SDS solubilized aggregate has an identical charge per unit volume. Negatively charged micelle particles move through the polyacrylamide gel toward the anode. Polyacrylamide acts as a molecular sieve and the protein–micelle complexes are separated by size; proteins of larger mass are retarded. A single band in an SDS polyacrylamide electrophoresis experiment is often used to demonstrate the purity of a protein. The conformation of the native structure is not a factor in the calculation of molecular mass, which is determined by comparison to known standards that are similarly denatured. The detergent dissociates quaternary structure into its constituent subunits. Only the molecular masses of the covalent polypeptide subunits within a protein are determined by this method.

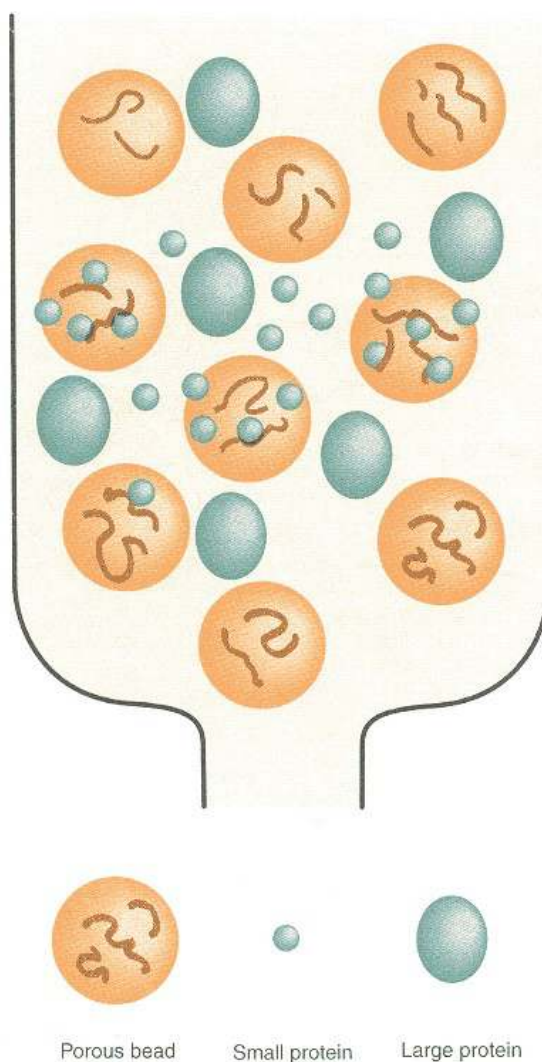

Figure 2.61
Molecular exclusion chromatography.
A small protein can enter the porous gel particles and will be retarded on the column with respect to a larger protein that cannot enter the porous gel particles.

HPLC Chromatographic Techniques Separate Amino Acids, Peptides, and Proteins

In high-performance liquid chromatography (HPLC), a liquid solvent containing a mixture of components to be identified is passed through a column densely

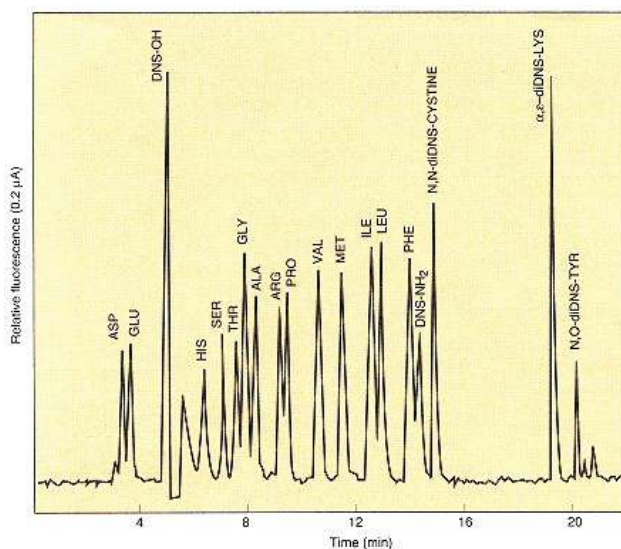

Figure 2.62

Separation of amino acids utilizing reverse-phase HPLC.

The x-axis is time of elution from column. Amino acids are derivatized by reaction with dansyl chloride (DNS) so that they emit a fluorescence that is used to assay them as they are eluted from the column.

Reprinted with permission from Hunkapiller, M. W., Strickler, J. E., and Wilson, K. J. *Science* 226:304, 1984.

Copyright © 1984 by American Association for the Advancement of Science.

packed with a small-diameter insoluble bead-like resin. In column chromatography, the smaller and more tightly packed the resin beads, the greater the resolution of the separation technique. In HPLC, the resin is so tightly packed that in order to overcome the resistance the liquid must be pumped through the column at high pressure. Therefore HPLC uses precise high-pressure pumps with metal plumbing and columns rather than glass and plastics as used in gravity chromatography. Resin beads are coated with charged chemical groups to separate compounds by ion exchange or with hydrophobic groups to retard hydrophobic nonpolar molecules. In hydrophobic chromatography, tightly associated nonpolar compounds are eluted from the hydrophobic beads in aqueous solvents containing various percentages of an organic reagent. The higher the percentage of organic solvent in the eluent, the faster the nonpolar component is eluted from the hydrophobic resin. This latter type of chromatography over nonpolar resin beads is called **reverse-phase HPLC** (Figure 2.62). The HPLC separations have extremely high resolution and reproducibility.

Affinity Chromatography

Proteins have a high affinity for their substrates, prosthetic groups, membrane receptors, specific noncovalent inhibitors, and antibodies made against them. These high-affinity compounds can be covalently attached to an insoluble resin and the modified resin used to purify its conjugate protein in column chromatography. In a mixture of proteins eluted through the resin, the one of interest is selectively retarded.

General Approach to Protein Purification

A protein must be purified prior to a meaningful characterization of its chemical composition, structure, and function. As living cells contain thousands of genetically distinct proteins, the purification of a single protein from the other cellular constituents may be difficult. The first task in the purification of a protein is

the development of a simple assay for the protein. Whether it utilizes the rate of a substrate transformation to a product, an antibody–antigen reaction, or a physiological response in an animal assay system, a protein assay must give a quantitative measurement of activity per unit of protein concentration. This quantity is known as the sample's **specific activity**. The purpose of a purification procedure is to increase a sample's specific activity to the value expected for the pure protein. A typical protocol for purification of a soluble cellular protein involves the disruption of the cellular membrane, followed by a differential centrifugation in a density gradient to isolate the protein from subcellular particles and high molecular weight aggregates. Further purification may utilize selective precipitation by addition of inorganic salts (salting out) or addition of miscible organic solvent to the solution containing the protein. Final purification will include a combination of techniques that separate based on molecular charge, molecular size, and affinity.

CLINICAL CORRELATION 2.8

Use of Amino Acid Analysis in Diagnosis of Disease

There are a number of clinical disorders in which a high concentration of amino acids is found in plasma and urine. An abnormally high concentration of an amino acid in urine is called an aminoaciduria. In phenylketonuria patients lack sufficient amounts of the enzyme phenylalanine hydroxylase, which catalyzes the transformation of phenylalanine to tyrosine. As a result, large concentrations of phenylalanine, phenylpyruvate, and phenyllactate accumulate in the plasma and urine. Phenylketonuria occurs clinically in the first few weeks after birth, and if the infant is not placed on a special diet, severe mental retardation will occur (see Clin. Corr. 11.5). Cystinuria is a genetically transmitted defect in the membrane transport system for cystine and the basic amino acids (lysine, arginine, and the derived amino acid ornithine) in epithelial cells. Large amounts of these amino acids are excreted in urine. Other symptoms of this disease may arise from the formation of renal stones composed of cystine precipitated within the kidney (see Clin. Corr. 11.9). Hartnup disease is a genetically transmitted defect in epithelial cell transport of neutral amino acids (mono-amino monocarboxylic acids), and high concentrations of these amino acids are found in the urine. The physical symptoms of the disease are primarily caused by a deficiency of tryptophan. These symptoms may include a pellagra-like rash (nicotinamide is partly derived from tryptophan) and cerebellar ataxia (irregular and jerky muscular movements) due to the toxic effects of indole derived from the bacterial degradation of unabsorbed tryptophan present in large amounts in the gut. Fanconi's syndrome is a generalized aminoaciduria associated with hypophosphatemia and a high excretion of glucose. Abnormal reabsorption of amino acids, phosphate, and glucose by the tubular cells is the underlying defect.

Determination of Amino Acid Composition of a Protein

Determination of the amino acid composition is an essential component in the study of a protein's structure and physiological properties. Analysis of the amino acid composition of physiological fluids (i.e., blood and urine) is utilized in diagnosis of disease (see Clin. Corr. 2.8). A protein is hydrolyzed to its constituent amino acids by heating the protein at 110°C in 6 N HCl for 18–36 h, in a sealed tube under vacuum to prevent degradation of oxidation-sensitive amino acid side chains by oxygen in air. Tryptophan is destroyed in this method and alternative procedures are used for its analysis. Asparagine and glutamine side chain amides are hydrolyzed to unsubstituted carboxylic acid side chains and free ammonia; thus they are counted within the glutamic acid and aspartic acid content in the analysis.

Common procedures for amino acid identification use cation-exchange chromatography or reverse-phase HPLC to separate the amino acids, which are then reacted with ninhydrin, fluorescamine, dansyl chloride, or similar chromophoric or fluorophoric reagents to quantitate the separated amino acids (Figure 2.62). With some types of derivatization, amino acids are identified at concentrations as low as 0.5×10^{-12} mol (pmol).

Techniques to Determine Amino Acid Sequence of a Protein

The ability to clone genes for proteins has led to the determination of the amino acid sequence of a protein as derived from the DNA or RNA sequences (see Chapter 18). This is a much faster method for obtaining an amino acid sequence. Sequencing of a protein, however, is required for the determination of modifications to the protein structure that occur after its biosynthesis, to identify a part of the protein sequence in order that its gene can be cloned, and to identify a protein as the product of a particular gene (see Chapter 17). Determination of the primary structure of a protein requires a purified protein. Many proteins contain several polypeptide chains and it is necessary to determine the number of chains in the protein. Individual chains are purified by the same techniques used in purification of the whole protein. If disulfide bonds covalently join the chains, these bonds have to be broken (Figure 2.63).

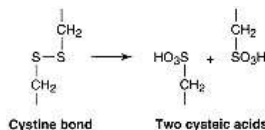

Figure 2.63
Breaking of disulfide bonds
by oxidation to cysteic acids.

Polypeptide chains are most commonly sequenced by the **Edman reaction** (Figure 2.64) in which the polypeptide chain is reacted with phenylisothiocyanate, which forms a covalent bond to the NH_2 -terminal amino acid. In this derivative, acidic conditions catalyze an intramolecular cyclization that results in cleavage of the NH_2 -terminal amino acid from the polypeptide chain as a phenylthiohydantoin derivative. This NH_2 -terminal amino acid derivative may be separated chromatographically and identified against standards. The polypeptide chain minus the NH_2 -terminal amino acid is then isolated, and the

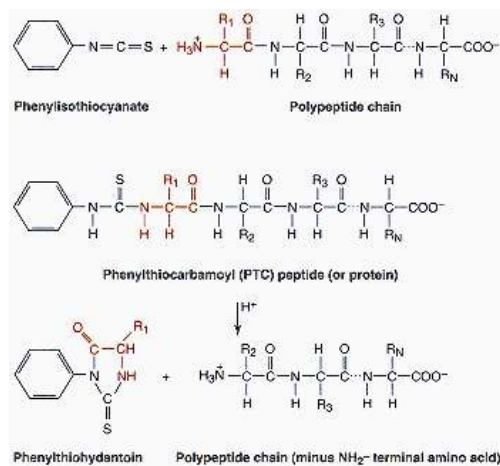

Figure 2.64
Edman reaction.

Edman reaction is repeated to identify the next NH₂-terminal amino acid. This series of reactions can theoretically be repeated until the sequence of the entire polypeptide chain is determined but under favorable conditions can only be carried out for 30 or 40 amino acids into the polypeptide chain. At this point in the analysis, impurities generated from incomplete reactions in the reaction series make further **Edman cycles** unfeasible. Since most polypeptide chains in proteins contain many more than 30 or 40 amino acids, they have to be hydrolyzed into smaller fragments and sequenced in sections.

Enzymatic and chemical methods are used to break polypeptide chains into smaller polypeptide fragments for sequencing. The enzyme **trypsin** preferentially catalyzes hydrolysis of the peptide bond on the COOH-terminal side of the basic amino acid residues of lysine and arginine within polypeptide chains. **Chymotrypsin** hydrolyzes peptide bonds on the COOH-terminal side of residues with large apolar side chains. Other proteolytic enzymes cleave polypeptide chains on the COOH-terminal side of glutamic and aspartic acid (Figure 2.65). **Cyanogen bromide** specifically cleaves peptide bonds on the COOH-terminal side of methionine residues within polypeptide chains (Figure

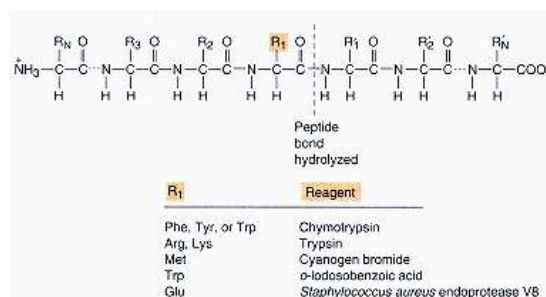

Figure 2.65
Specificity of some polypeptide cleaving reagents.

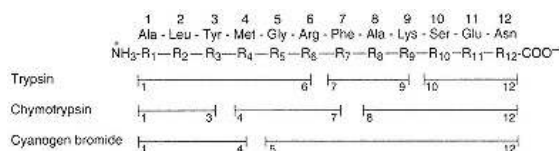

Figure 2.66
Ordering of peptide fragments from overlapping sequences produced by specific proteolysis of a peptide.

2.65). To establish the amino acid sequence of a large polypeptide, it is subjected to **partial hydrolysis** by one of the specific cleaving reagents, the polypeptide segments are separated, and the amino acid sequence of each of the small segments is determined by the Edman reaction. To place the sequenced peptides correctly into the complete sequence of the original polypeptide, a sample of the original polypeptide is subjected to a second partial hydrolysis by a different hydrolytic reagent from that used initially. This generates overlapping sequences to the first set of sequences, leading to the complete sequence (Figure 2.66).

X-Ray Diffraction Techniques Are Used to Determine the Three-Dimensional Structure of Proteins

X-ray diffraction enables determination of the three-dimensional structure of proteins at near atomic resolution. The approach requires formation of a protein crystal, which contains solvent and is thus a concentrated solution, for use as the target. Our present understanding of the detailed components of protein structure derived from experiments performed in this crystalline state correlate well with other physical measurements of protein structure in solution such as those made using NMR spectroscopy (see p. 81).

Generation of the protein crystal can be the most time-consuming aspect of the process. A significant factor in both experimental and computational handling of protein crystals, in contrast with most small molecule crystals, stems from the content of the protein crystalline material. Proteins exhibit molecular dimensions an order of magnitude greater than small molecules, and the packing of large protein molecules into the crystal lattice generates a crystal with large "holes" or solvent channels. A protein crystal typically contains 40–60% solvent and may be considered a concentrated solution rather than the hard crystalline solid associated with most small molecules. This attribute proves both beneficial and detrimental. The presence of solvent and unoccupied volume in the crystal allows the infusion of inhibitors and substrates into the protein molecules in the "crystalline state" but also permits a **dynamic flexibility** within regions of the protein structure. The flexibility may be seen as "disorder" in the X-ray diffraction experiment. Disorder is used to describe the situation in which the observed electron density can be fitted by more than a single local conformation. Two explanations for the disorder exist and must be distinguished. The first involves the presence of two or more static molecular conformations, which are present in a stoichiometric relationship. The second involves the actual dynamic range of motion exhibited by atoms or groups of atoms in localized regions of the molecule. An experimental distinction between the two explanations can be made by lowering the environmental temperature of the crystal to a point where dynamic disorder is "frozen out"; in contrast, the static disorder is not temperature dependent and persists. Analysis of dynamic disorder by its temperature dependency using X-ray diffraction determinations is an important method for studying protein dynamics (see Section 2.8). Crystallization techniques have advanced so that crystals are now obtainable from less abundant proteins. Interesting structures are reported for proteins in which specific amino

acid residues have been substituted, of antibody–antigen complexes, and of viral products such as the protease required for the infection of the human immunodeficiency virus (HIV) that causes acquired immunodeficiency syndrome (AIDS). Many structures have been solved by X-ray diffraction and the details are stored in a database called the **Protein Data Bank**, which is readily accessible.

Diffraction of X-ray radiation by a crystal occurs with incident radiation of a characteristic wavelength (e.g., copper, $K_{\alpha} = 1.54 \text{ \AA}$). The X-ray beam is diffracted by the electrons surrounding the atomic nuclei in the crystal, with an intensity proportional to the number of electrons around the nucleus. Thus the technique establishes the **electron distribution** of the molecule and infers the nuclear distribution. The actual positions of atomic nuclei can be determined directly by diffraction with **neutron beam radiation**, an interesting but very expensive technique as it requires a source of neutrons (nuclear reactor or particle accelerator). With the highest resolution now available for X-ray diffraction determinations of protein structures, the electron diffraction from C, N, O, and S atoms can be observed. The diffraction from hydrogen atoms is not observed due to the low density of electrons—that is, a single electron—around a hydrogen nucleus. Detectors of the diffracted beam, typically photographic film or electronic area detectors, permit the recording of the amplitude (intensity) of radiation diffracted in a defined orientation. However, the data do not give information about phases of the radiation, which are essential to the solution of a protein's structure. Determination of the **phase angles** historically required the placement of heavy atoms (such as iodine, mercury, or lead) in the protein structure. Modern procedures, however, can often solve the phase problem without use of a heavy atom.

It is convenient to consider an analogy between X-ray crystallography and light microscopy to understand the processes involved in carrying out the three-dimensional structure determination. In light microscopy, incident radiation is reflected by an object under study and the reflected beam is reconcondensed by the objective lens to form an image of the object. The analogy is appropriate to incident X rays with the notable exception that no known material exists that can serve as an objective lens for X-ray radiation. To replace the objective lens, amplitude and phase angle measurements of the diffracted radiation are mathematically reconstructed by **Fourier synthesis** to yield a three-dimensional **electron-density map** of the diffracted object. Initially a few hundred reflections are obtained to construct a low-resolution electron-density map. For example, in one of the first protein crystallographic structures, 400 reflections were utilized to obtain a 6- \AA map of myoglobin. At this level of resolution it is possible to locate clearly the molecule within the unit cell of the crystal and study the overall packing of the subunits in a protein with a quaternary structure. A trace of the polypeptide chain of an individual protein molecule is made with difficulty. Utilizing the low-resolution structure as a base, further reflections may be used to obtain higher-resolution maps. For myoglobin, where 400 reflections were utilized to obtain the 6- \AA map, 10,000 reflections were needed for a 2- \AA map, and 17,000 reflections for an extremely high-resolution 1.4- \AA map. Many of these steps are now partially automated using computer graphics. A two-dimensional slice through a three-dimensional electron-density map of trypsinogen is shown in Figure 2.67. The known primary structure of the protein is fitted to the electron-density pattern by refinement. **Refinement** is the computer-intensive process of aligning a protein's amino acid sequence to the electron-density map until the best fit is obtained.

Whereas X-ray diffraction has provided extensive knowledge on protein structure, such a structure provides incomplete evidence for a protein's mechanism of action. The X-ray determined structure is an average structure of a molecule in which atoms are normally undergoing rapid fluctuations in solution (see Section 2.8). Thus the average crystalline structure determined by X-ray

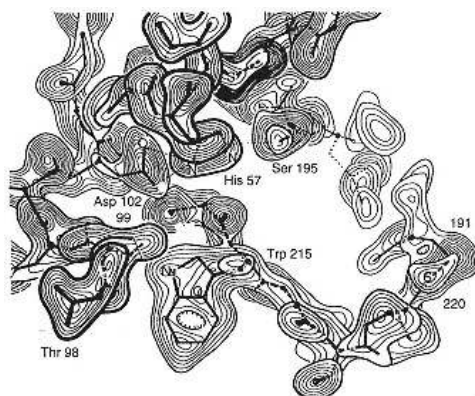

Figure 2.67
Electron-density map at 1.9-Å resolution of active site region of proenzyme form of trypsin.
 Active site amino acid residues are fitted onto density map.
 Reprinted with permission from Kossiakoff, A. A., Chambers, J. L., Kay, L. M., and Stroud, R. M. *Biochemistry* 16:654, 1977.
 Copyright © 1977 by American Chemical Society.

diffraction may not be the active structure of a particular protein in solution. A second important consideration is that it currently takes at least a day to collect data in order to determine a structure. On this time scale, the structures of reactive enzyme–substrate complexes, intermediates, and reaction transition states of an enzyme can not be observed. Rather, these structures must be inferred from the static pictures of an inactive form of the protein or from complexes with inactive analogs of the substrates of the protein (Figure 2.68). Newer methods for X-ray diffraction using synchrotron radiation to generate a X-ray beam at least 10,000 times brighter than that of standard X-ray generators will enable collection of diffraction data to solve a protein structure on a millisecond time scale. Application of the later X-ray techniques will enable scientists to determine short-lived structures and solve mechanistic and dynamic structural questions not addressable by current technology.

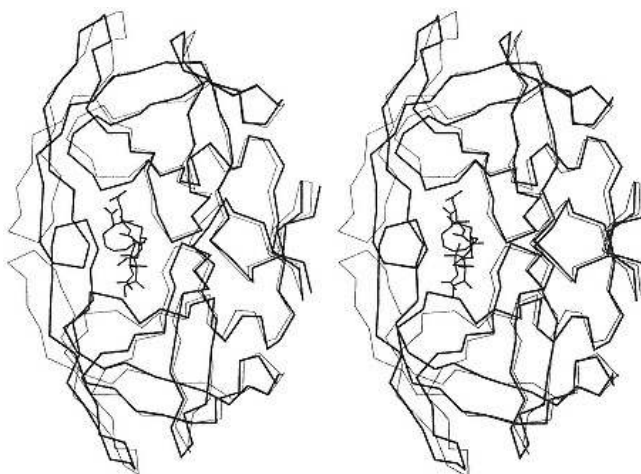

Figure 2.68
Stereo tracing of superimposed α -carbon backbone structure of HIV protease with inhibitor bound (thick lines) and the native structure of HIV protease without inhibitor bound (thin lines).

Redrawn with permission from Miller, M., Schneider, J., Sathyanarayana, B. K., Toth, M. V., Marshall, G. R., Clawson, L., Selk, L., Kent, S. B. H., and Wlodawer, A. *Science* 246: 1149, 1989.

Various Spectroscopic Methods Are Employed in Evaluating Protein Structure and Function

Ultraviolet Light Spectroscopy

The side chains of tyrosine, phenylalanine, and tryptophan, as well as peptide bonds in proteins, absorb **ultraviolet (UV) light**. The efficiency of light energy absorption for each **chromophore** is related to its **molar extinction coefficient** (ϵ). A typical protein spectrum is shown in Figure 2.69. The absorbance between 260 and 300 nm is primarily due to phenylalanine, tyrosine, and tryptophan side chain groups (Figure 2.70). When the tyrosine side chain is ionized at high pH (the tyrosine R group has a $pK_a \approx 10$), the absorbance for tyrosine is shifted to a higher wavelength (red shifted) and its molar absorptivity is increased (Figure 2.70). Peptide bonds absorb in the far-UV (180–230 nm). A peptide bond in α -helix conformation interacts with the electrons of other peptide bonds above and below it in the spiral conformation to create an **exciton system** in which electrons are delocalized. The result is a shift of the absorption maximum from that of an isolated peptide bond to either a lower or higher wavelength (Figure 2.71). Thus UV spectroscopy can be used to study changes in a protein's secondary and tertiary structure. As a protein is denatured (helix unfolded), differences are observed in the absorption characteristics of the peptide bonds due to the disruption of the exciton system. In addition, the absorption maximum for an aromatic chromophore appears at a lower wavelength in an aqueous environment than in a nonpolar environment.

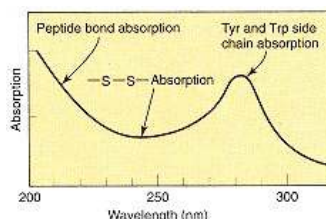

Figure 2.69
Ultraviolet absorption spectrum
of the globular protein chymotrypsin.

The **molar absorptivity** of a chromophoric substrate often changes on binding to a protein. This change in the binding molecule's extinction coefficient can be used to measure its binding constant. Changes in chromophore extinction coefficients during the enzyme catalysis of a chemical reaction are used to obtain the kinetic parameters for the reaction.

Fluorescence Spectroscopy

The energy of an excited electron produced by light absorption is lost by various mechanisms and most commonly as thermal energy in a collision process. In some chromophores the excitation energy is dissipated by fluorescence. The **fluorescent emission** is always at a longer wavelength of light (lower energy) than the absorption wavelength of the fluorophore. Higher vibrational energy

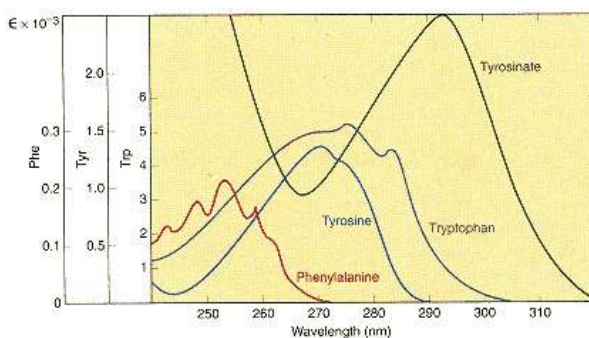

Figure 2.70
Ultraviolet absorption for the aromatic chromophores in Phe, Tyr, Trp, and tyrosinate.
Note differences in extinction coefficients on left axis for the different chromophores.
Redrawn from d'Albis *, A., and Gratzel, W. B. In: A. T. Bull, J. R. Lagmado, J.O. Thomas, and K.F. Tipton (Eds.), *Companion to Biochemistry*. London: Longmans, 1974, p. 170.

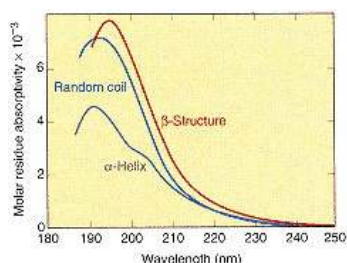

Figure 2.71
Ultraviolet absorption of the peptide bonds of a polypeptide chain in α -helix, random coil, and antiparallel β -structure conformations.
Redrawn from d'Albis, A., and Gratzel, W.B. In: A.T. Bull, J.R. Lagmado, J.O. Thomas, and K.F. Tipton (Eds.), *Companion to Biochemistry*. London: Longmans, 1970, p. 175.

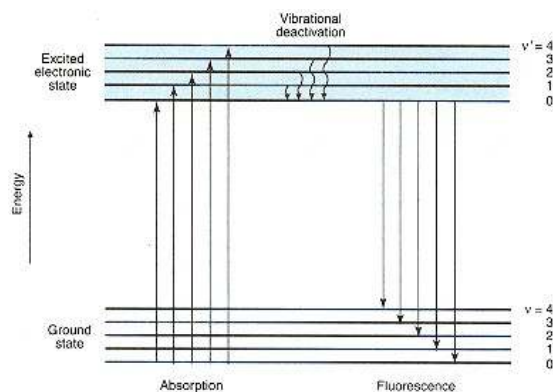

Figure 2.72

Absorption and fluorescence electronic transitions.

Excitation is from zero vibrational level in ground state to various higher vibrational levels in the excited state. Fluorescence is from zero vibrational level in excited electronic state to various vibrational levels in the ground state.

Redrawn from d'Albis*, A., and Gratzler, W. B.

In: A. T. Bull, J. R. Lagmado, J. O. Thomas,

and K. F. Tipton (Eds.), *Companion to*

Biochemistry. London: Longmans, 1970, p. 166.

levels, formed in the excited electron state during the excitation event, are lost prior to the fluorescent event (Figure 2.72). If a chromophoric molecule is present that absorbs light energy emitted by the **fluorophore**, the emitted fluorescence is not observed. Rather, the fluorescence energy is transferred to the absorbing molecule. The **acceptor molecule**, in turn, either emits its own characteristic fluorescence or loses its excitation energy by an alternative process. If the acceptor molecule loses its excitation energy by a nonfluorescent process, it is acting as a **quencher** of the **donor molecule's** fluorescence. The efficiency of the **excitation transfer** is dependent on the distance and orientation between donor and acceptor molecules.

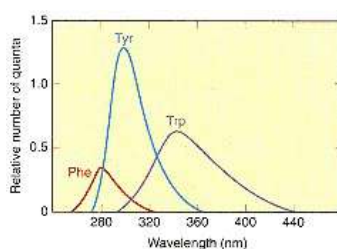

Figure 2.73

Characteristic fluorescence of aromatic groups in proteins.

Redrawn from d'Albis, A., and Gratzler, W. B.

In: A. T. Bull, J. R. Lagmado, J. O. Thomas,

and K. F. Tipton (Eds.), *Companion to Biochemistry*.

London: Longmans, 1970, p. 478.

Fluorescence emission spectra for phenylalanine, tyrosine, and tryptophan side chains are shown in Figure 2.73. The emission wavelengths for phenylalanine overlap with the absorption wavelengths for tyrosine. In turn, the emission wavelengths for tyrosine overlap with the absorption wavelengths for tryptophan. Because of these overlaps in emission and absorption wavelengths, primarily only tryptophan fluorescence is observed in proteins that contain all of these amino acids. **Excitation energy transfers** occur over distances up to 80 \AA , which are typical diameter distances in folded globular proteins. On protein denaturation, the distances between donor and acceptor groups become greater and decrease the efficiency of energy transfer to tryptophan. Accordingly, an increase in fluorescence due to tyrosines and/or phenylalanines is observed on denaturation of a protein. Since excitation transfer processes in proteins are distance and orientation dependent, the fluorescence yield is dependent on the conformation of the protein. The greatest sensitivity of this analysis occurs in its ability to detect changes due to solvent or binding interactions rather than establish absolute structure.

Optical Rotatory Dispersion and Circular Dichroism Spectroscopy

Optical rotation is caused by differences in the refractive index and **circular dichroism** (CD) is caused by differences in the light absorption between the clockwise and counterclockwise component vectors of a beam of polarized light as it travels through a solution containing an optically active molecule

such as an L-amino acid. In proteins the aromatic amino acids and the polypeptide chain generate an optical rotation and CD spectrum (Figure 2.74). Because of the differences between α -helical, β -structure, and random polypeptide spectra, circular dichroism has been a sensitive assay for the amount and type of secondary structure in a protein. Newer developments in vibrational circular dichroism examine the CD in regions of the spectrum more sensitive to protein backbone conformation.

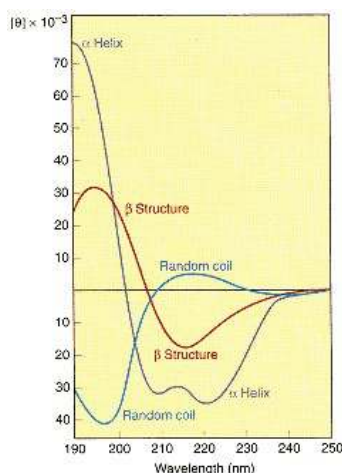

Figure 2.74
Circular dichroism spectra for polypeptide chains in α -helix, β -structure, and random coil conformations.

Redrawn from d'Albis *, A., and Gratzler, W. B.
In: A. T. Bull, J. R. Lagrado, J. O. Thomas, and K. F. Tipton (Eds.),
Companion to Biochemistry.
London: Longmans, 1970, p. 190.

Nuclear Magnetic Resonance

With **two-dimensional (2-D) NMR** and powerful NMR spectrometers it is possible to obtain the solution conformation of small proteins of approximately 150 amino acids or less. Multidimensional NMR and triple resonance can extend the NMR to solve protein structures with up to 250 amino acids.

Conventional NMR techniques involve use of radiofrequency (rf) radiation to study the environment of atomic nuclei that are magnetic. The requirement for magnetic nuclei is absolute and is based on an unpaired spin state in the nucleus. Thus the naturally abundant carbon (^{12}C), nitrogen (^{14}N), and oxygen (^{16}O) do not absorb, while ^{13}C , ^{15}N , and ^{17}O do absorb. The absorption bands in an NMR spectrum are characterized by (1) a position or chemical shift value, reported as the frequency difference between that observed for a specific absorption band and that for a standard reference material; (2) the intensity of the peak or integrated area, which is proportional to the total number of absorbing nuclei; (3) the half-height peak width, which reflects the degree of motion in solution of the absorbing species; and (4) the coupling constant, which measures the extent of direct interaction or influence of neighboring nuclei on the absorbing nuclei. These four measurements enable the determination of the identity and number of nearest-neighbor groups that can affect the response of absorbing species through bonded interactions. They give no information on through-space (nonbonded) interaction due to the three-dimensional structure of the protein. To determine through-space interactions and protein tertiary structure requires the use of **nuclear Overhauser effects (NOEs)** and the application of the two-dimensional technique.

The major difference in two-dimensional versus one-dimensional (1-D) NMR is the addition of a second time delay rf pulse. The technique first requires the identification in the spectrum of a proton absorbance from a particular position in the protein structure. A maximum distance of approximately 5 Å is the limit for which these through-space interactions can be observed. Upon the generation of distance information for interresidue pairs through the protein structure, three-dimensional protein conformations consistent with the spectra are generated. In this calculation, a distance matrix is constructed containing ranges of distances (minimum and maximum) for as many interresidue interactions as may be measured. Possible structures are generated from the data consistent with the constraints imposed by the NMR spectra. Computational refinements of the initially calculated structures can be made to optimize covalent bond distances and bond angles. The method generates a family of structures, the variability showing either the imprecision of the technique or the dynamic "disorder" of the folded structure (Figure 2.75). Such computations based on NMR experiments have yielded structures for proteins that do not significantly differ from the time-averaged structure observed with X-ray diffraction methods.

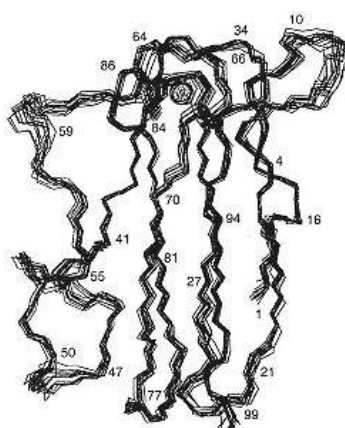

Figure 2.75
NMR structure of the protein
plastocyanin from the French bean.

The structure shows superposition of eight structures of the polypeptide backbone for the protein, calculated from the constraints of the NMR spectrum.

From Moore, J. M.,
Lepre, C. A., Gippert, G. P., Chazin, W. J.,
Case, D. A., and Wright, P. E. *J. Mol. Biol.* 221:533, 1991. Figure generously
supplied by P. E. Wright.

Other enhancements to NMR, which are applicable to the determination of protein structure, include the ability to synthesize proteins containing isotopically enriched (e.g., containing ^{13}C or ^{15}N) amino acids, and development of paramagnetic shift reagents to study localized environments on paramagnetic resonances, such as the lanthanide ion reporting groups.

Bibliography

Physical and Structural Properties of Proteins

- Bowie, J. U., Luethy, R., and Eisenberg, D. A method to identify protein sequences that fold into a known three-dimensional structure. *Science* 253:164, 1991.
- Bryson, J. W., Betz, S. F., Lu, H. S., Suich, D. H., Zhou, H. X., O'Neil, K. T., and DeGrado, W. F. Protein design: a hierarchic approach. *Science* 270:935, 1995.
- Chothia, C. Principles that determine the structure of proteins. *Annu. Rev. Biochem.* 53:537, 1984.
- Doolittle, R. F. The multiplicity of domains in proteins. *Annu. Rev. Biochem.* 64:287, 1995.
- Eisenberg, D., and McLachlan, A. D. Solvation energy in protein folding and binding. *Nature* 319:199, 1986.
- Fasman, G. D. Protein conformational prediction. *Trends Biochem. Sci.* 14:295, 1989.
- Finkelstein, A. V., Gutun, A. M., and Badretdinov, A. Ya. Why are the same protein folds used to perform different functions? *FEBS Lett.* 325:23, 1993.
- Flöckner, H., Braxenthaler, M., Lackner, P., Jaritz, M., Ortner, M., and Sippl, M. J. Progress in fold recognition. *Proteins* 23:376, 1995.
- Mosimann, S., Meleshko, R., and James, M. N. G. A critical assessment of comparative molecular modeling of tertiary structures of proteins. *Proteins* 23:301, 1995.
- Orengo, C. A., Jones, D. T., and Thornton, J. M. Protein superfamilies and domain superfolds. *Nature* 372:631, 1994.
- Richardson, J. S. The anatomy and taxonomy of protein structure. *Adv. Protein Chem.* 34:168, 1981.
- Rose, G. D., and Wolfenden, R. Hydrogen bonding, hydrophobicity, packing, and protein folding. *Annu. Rev. Biophys. Biomol. Struct.* 22:381, 1993.

Protein Folding

- Anfinsen, C. B., and Scheraga, H. Experimental and theoretical aspects of protein folding. *Adv. Protein Chem.* 29:205, 1975.
- Baldwin, R. L. How does protein folding get started? *Trends Biochem. Sci.* 14:291, 1989.
- Bychkova, V. E., and Ptitsyn, O. B. The molten globule state is involved in genetic disease? *FEBS Lett.* 359:6, 1995.
- Chen, S., Roseman, A. M., Hunter, A. S., Wood, S. P., Burston, S. G., Ranson, N. A., Clarke, A. R., and Saibil, H. R. Location of a folding protein and shape changes in GroEL–GroES complexes imaged by cryo-electron microscopy. *Nature* 371:261, 1994.
- Dobson, C. M., Evans, P. A., and Radford, S. E. Understanding how proteins fold: the lysozyme story so far. *Trends Biochem. Sci.* 19:31, 1994.
- Hendrick, J. P., and Hartl, F. U. The role of molecular chaperones in protein folding. *FASEB J.* 9:1559, 1995.
- Jaenicke, R. Protein folding: local structures, domains, subunits and assemblies. *Biochemistry* 30:3147, 1991.
- Lins, L., and Brasseur, R. The hydrophobic effect in protein folding. *FASEB J.* 9:535, 1995.
- Ptitsyn, O. B. How the molten globule became. *Trends Biochem. Sci.* 20:376, 1995.
- Shakhnovich, E., Abkevich, V., and Ptitsyn, O. Conserved residues and the mechanism of protein folding. *Nature* 379:96, 1996.
- Sosnick, T. R., Mayne, L., Hiller, R., and Englander, S. W. The barriers in protein folding. *Nature Struct. Biol.* 1:149, 1994.
- Wolynes, P. G., Onuchic, J. N., and Thirumalai, D. Navigating the folding routes. *Science* 267:1619, 1995.

Techniques for the Study of Proteins

- Bax, A., and Grzesiek, S. Methodological advances in protein NMR. *Acc. Chem. Res.* 26:131, 1993.
- Clauser, K. R., Hall, S. C., Smith, D. M., Webb, J. W., Andrews, L. E., Tran, H. M., Epstein, L. B., and Burlingame, A. L. Rapid mass spectrometric peptide sequencing and mass matching for characterization of human melanoma proteins isolated by two dimensional PAGE. *Proc. Natl. Acad. Sci. U.S.A.* 92:4801, 1995.
- Farrow, N. A., Muhandiram, D. R., Singer, A. U., Pascal, S. M., Kay, C. M., Gish, G., Shoelson, S. E., Pawson, T., and Forman-Kay, L. E. Back-bone dynamics of a free and phosphopeptide-complexed Src homology 2 domain studied by ^{15}N NMR relaxation. *Biochemistry* 33:5984, 1994.
- Nikolov, C. B., Chen, H., Halay, E. D., Usheva, A. A., Hisatake, K., Lee, D. K., Roeder, R. G., and Burley, S. K. Crystal structure of a TFIIB-TBP-TATA-element ternary complex. *Nature* 377:119, 1995.
- Reif, O. W., Lausch, R., and Fritag, R. High-performance capillary electrophoresis of human serum and plasma proteins. *Adv. Chromatogr.* 34:1, 1994.
- Shively, J. E., Paxton, R. J., and Lee, T. D. Highlights of protein structural analysis. *Trends Biochem. Sci.* 14:246, 1989.

Dynamics in Folded Proteins

- Daggett, V., and Levitt, M. Realistic simulations of native-protein dynamics in solution and beyond. *Annu. Rev. Biophys. Biomol. Struct.* 22:353, 1993.
- Joseph, D., Petsko, G. A., and Karplus, M. Anatomy of a conformational change: hinged lid motion of the triosephosphate isomerase loop. *Science* 249:1425, 1990.
- Karplus, M., and McCammon, J. A. Dynamics of proteins: elements and function. *Annu. Rev. Biochem.* 53:263, 1983.
- Karplus, M., and McCammon, J. A. The dynamics of proteins. *Sci. Am.* 254:42, 1986.
- Smith, P. E., van Schaik, R. C., Szyperski, T., Würthrick, K., and van Gunsteren, W. F. Internal mobility of the basic pancreatic trypsin inhibitor in solution: a comparison of NMR spin relaxation measurements and molecular dynamics simulations. *J. Mol. Biol.* 246:356, 1995.

Glycoproteins

- Brockhausen, I. Clinical aspects of glycoprotein biosynthesis. *Crit. Rev. Clin. Lab. Sci.* 30:65, 1993.
- Lis, H., and Sharon, N. Protein glycosylation. Structural and functional aspects. *Eur. J. Biochem.* 218:1, 1993.
- Paulson, J. C. Glycoproteins: what are the sugar chains for? *Trends Biochem. Sci.* 14:272, 1989.

Lipoproteins

- Gotto, A. M. Jr. Plasma lipoproteins. In: A. Neuberger and L. L. M. van Deenen (Eds.), *New Comprehensive Biochemistry*. Amsterdam: Elsevier, 1987.
- Myers, G. L., Cooper, G. R., and Sampson, E. J. Traditional lipoprotein profile: clinical utility, performance requirement, and standardization. *Atherosclerosis* 108:S157, 1994.
- Schumaker, V. N., Phillips, M. L., and Chatterton, J. E. Apolipoprotein B and low-density lipoprotein structure: implications for biosynthesis of triglyceride-rich lipoproteins. *Adv. Protein Chem.* 45:205, 1994.
- Schuster, B., Prassl, R., Nigon, F., Chapman, M. J., and Laggner, P. Core lipid structure is a major determinant of the oxidative resistance of low density lipoprotein. *Proc. Natl. Acad. Sci. U.S.A.* 92:2509, 1995.

Segrest, J. P., Garber, D. W., Brouillette, C. G., Harvey, S. C., and Ananthara-maiah, G. M. The amphipathic α helix: a multifunctional structural motif in plasma apolipoproteins. *Adv. Protein Chem.* 45:303, 1994.

Collagen

Brodsky, B., and Shah, N. K. The triple-helix motif in proteins. *FASEB J.* 9:1537, 1995.

Kuivaniemi, H., Tromp, G., and Prockop, D. J. Mutations in collagen genes: causes of rare and some common diseases in humans. *FASEB J.* 5:2052, 1991.

Prockop, D. J., and Kivirikko, K. I. Collagens: molecular biology, diseases, and potentials for therapy. *Annu. Rev. Biochem.* 64:403, 1995.

Questions

J. Baggott and C. N. Angstadt

Refer to the following structure for Questions 1 and 2.

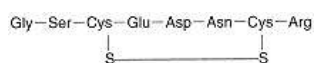

1. The peptide shown above:

- has arginine in position 1 of the sequence.
- contains a derived amino acid.
- is basic.
- consists entirely of amino acids with charged or nonpolar side chains.
- contains more amino acids with side chains that are charged than ones with electrically neutral side chains at pH 7.0.

2. The charge on the peptide shown above is about:

- 2 at pH > 13.5.
- 1 at pH ~ 11.5.
- +1 at pH ~ 6.5.
- +2 at pH ~ 5.5.
- 0 at pH ~ 4.5.

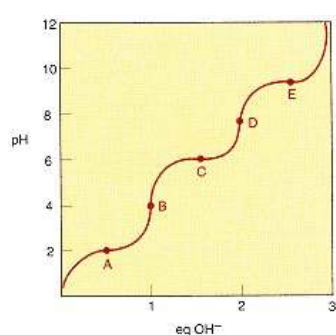

3. The figure above shows the titration curve of one of the common amino acids. From this curve we can conclude:

- the amino acid contains two carboxyl groups.
- at point B the amino acid is zwitterionic.
- the amino acid contains an aromatic hydroxyl group.
- point D corresponds to the pK_a of an ionizable group.
- at point E the amino acid has a net negative charge.

4. Which of the following can be used for a quantitative determination of amino acids in general?

- acetic anhydride
- iodoacetate
- ninhydrin
- Pauly's reagent
- the Sakaguchi reaction

5. Which of the following is a conservative substitution?

- Val for Ile
- His for Pro
- Asp for Ala
- Lys for Leu
- Ser for Ala

6. Which of the following has quaternary structure?

- α -chymotrypsin
- hemoglobin
- insulin
- myoglobin
- trypsin

Refer to the drawing for Questions 7 and 8.

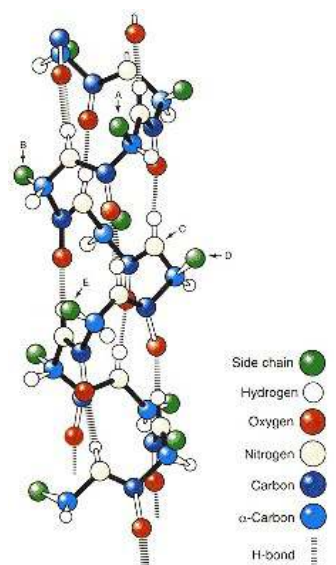

7. When group E contains a negatively charged carboxyl function, the structure is destabilized by:

- alanine at position A.
- arginine at position B.
- serine at position B.
- proline at position D.
- aspartate at position D.

8. The properties of atom C are essential to which stabilizing force in the structure?

- A. hydrogen bonding
- B. steric effects
- C. ionic attraction
- D. disulfide bridge
- E. none of the above

Refer to the following for Questions 9–11.

- A. disulfide bond formation
- B. hydrogen bonding
- C. hydrophobic interaction
- D. electrostatic interactions
- E. van der Waals forces

9. Which interaction is NOT formed when protein subunits combine to form a quaternary structure?

10. Driven by the entropy of water.

11. Repulsive forces between atoms attached to a peptide bond are weakest when the ϕ and φ angles are compatible with the α -helix and β -structures.

12. In collagen:

- A. intrachain hydrogen bonding stabilizes the native structure.
- B. three chains with polyproline type II helical conformation can wind about one another to form a superhelix because of the structure of glycine.
- C. the ϕ angles contributed by proline are free to rotate, but the φ angles are constrained by the ring.
- D. regions of superhelicity comprise the entire structure except for the N and C termini.
- E. cross-links between triple helices form after an intracellular enzyme converts some of the lysine to allysine.

13. Chaperone proteins:

- A. all require ATP to exert their effect.
- B. cleave incorrect disulfide bonds, allowing correct ones to subsequently form.
- C. guide the folding of polypeptide chains into patterns that would be thermodynamically unstable without the presence of chaperones.
- D. are involved in transport of proteins across mitochondrial and endoplasmic reticulum membranes.
- E. act primarily on fully synthesized polypeptide chains, unfolding incorrect structures so they can refold correctly.

14. Proteins may be separated according to size by:

- A. isoelectric focusing.
- B. polyacrylamide gel electrophoresis.
- C. ion-exchange chromatography.
- D. molecular exclusion chromatography.
- E. reverse-phase HPLC.

Refer to the following for Questions 15–18.

- A. primary structure
- B. secondary structure
- C. tertiary structure
- D. quaternary structure
- E. random conformation

15. All ϕ angles are equal and all φ angles are equal.

16. May bring distant segments of a single polypeptide chain into close juxtaposition.

17. Unaffected by binding of a charged detergent, such as SDS.

18. Exemplified by the β -structure (pleated sheet).

19. Changes in protein conformation can be detected rapidly by:

- A. ultraviolet absorbance spectroscopy.
- B. fluorescence emission spectroscopy.
- C. optical rotatory dispersion.
- D. circular dichroism.
- E. all of the above.

Answers

1. B Cystine, formed by joining two cysteine residues through a disulfide bridge, is a derived amino acid (p. 30). A: The convention is to write the N terminal to the left. Numbering begins at the N terminal, so glycine is in position 1 (p. 29). C: The peptide contains two acidic amino acids, glutamate and aspartate, and only one basic amino acid, arginine, so it is acidic (p. 31). D and E: Cysteine is nonpolar and uncharged, and glutamate, aspartate, and arginine are charged at physiological pH; serine and asparagine are polar but are not charged (p. 26).

2. E At pH 4.5 the peptide is in the following ionic state: the N-terminal amino group is +1, the side chain carboxyls of glutamate and aspartate each average about -0.5 (since this pH is about at their pK values), the side chain of arginine is +1, and its terminal carboxyl group is -1 . The sum is zero (pp. 30–33).

3. E The axes of this titration curve are reversed from the presentation in the text. The abscissa shows that three ionizable groups are present. The pK values, where the groups are 50% titrated, are at points A (pH ~ 2), C (pH ~ 6.5), and E (pH ~ 9.5). Histidine is the only common amino acid with these pK values. At point B, its net charge is $-1 + 1 + 1 = +1$. At point E, the net charge is $-1 + 0 + 0.5 = -0.5$ (pp. 31–34).

4. C A: Acetic anhydride acetylates tyrosyl residues. B: Iodoacetate reacts with the $-SH$ of cysteine. D: Pauly's reagent reacts only with histidine and tyrosine. E: The Sakaguchi reaction is for arginine. (See Table 2.7.)

5. A B: His and Pro both have rings in their side chains, but the rings are very different. C–E: In each of these pairs the first amino acid is charged or polar, and the second has an aliphatic R group (p. 26).

6. B Quaternary structure consists of a specific noncovalent association of subunits having their own tertiary structures (p. 44). Myoglobin is a single polypeptide chain (p. 48). Insulin, trypsin (p. 40), and α -chymotrypsin (p. 46) are multichain proteins covalently joined by cystine bonds, and, each chain having arisen from a single polypeptide chain by proteolytic cleavage.

7. D Like charges in the third or fourth position in either direction from the designated position destabilize the helix due to charge repulsion. Thus aspartate at position D is harmless, whereas glutamate at position A or B would destabilize. Alanine has a small side chain. Proline destabilizes the α -helix conformation and is usually not found in either α -helix or β -structure (p. 44).
8. A Atom C is an amide nitrogen. The attached hydrogen atom participates in hydrogen bonding (pp. 43–44). Hydrogen bonds contribute to the stability of the structure (p. 43).
9. A Quaternary structure is stabilized exclusively by noncovalent interactions. Disulfide bonds are covalent (p. 48).
10. C Hydrophobic groups in contact with water result in formation of a relatively highly ordered solvation shell of water around the group. If the hydrophobic groups come together, eliminating the bound water, the water becomes more random, a favorable process (pp. 64–66).
11. E Van der Waals repulsive forces (as opposed to the attractive element of van der Waals forces) are weakest at these angles (p. 66).
12. B The close contacts in the interior of the triple helix are possible only when the R group of the amino acid at that position is very small, that is, hydrogen. A: The hydrogen bonding in collagen is interchain. C: The ϕ angle is part of the proline ring and is not free to rotate. D: Although the statement is true of type I collagen, the superhelical regions in other collagen types may be broken by regions of globular domains (p. 52). E: The conversion and cross-linking are extracellular.
13. D A: The hsp60 family of chaperones is ATP-linked, but the hsp70 family is not. B: Disulfide isomerases catalyze this reaction. C: The final product is thermodynamically stable; chaperones merely prevent unfavorable intermediate interactions. E: Hsp70 chaperones react with nascent polypeptide chains as they are synthesized by the ribosome. The protein may then be delivered to a hsp60 chaperone for facilitation of final folding (pp. 62–63).
14. D A–C separate molecules on the basis of charge (p. 72). E: Reverse-phase HPLC effects separations on the basis of polarity (p. 73).
15. B This statement is a definition of secondary structure (p. 43).
16. C This is a consequence of folding into a compact structure (p. 44).
17. A SDS binding produces an extended conformation of a polypeptide chain due to charge repulsion, but no peptide bonds are broken (p. 72).
18. B β -Structure is an important type of secondary structure (p. 44).
19. E A: Peptide bond absorption (180–230 nm) in the α -helical conformation differs from that in other conformations (p. 79). B: Excitation transfers become less efficient as donor and acceptor groups become further apart, as in denaturation. C and D: These effects of optically active chromophors upon polarized light are sensitive to environment; in addition, the peptide bond itself becomes part of an optically active system when it forms an asymmetric structure like the α -helix (p. 80).

Chapter 3— Proteins II: Structure—Function Relationships in Protein Families

Richard M. Schultz and Michael N. Liebman

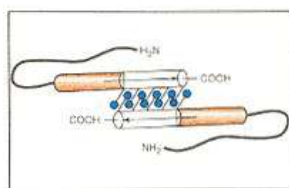

3.1 Overview	88
3.2 Antibody Molecules: The Immunoglobulin Superfamily	88
Antibody (Immunoglobulin) Molecules Consist of Four Polypeptide Chains	89
Constant and Variable Regions of Primary Structure	89
Immunoglobulins in a Single Class Contain Common Homologous Regions	91
Repeating Amino Acid Sequences and Homologous Three-Dimensional Domains Occur within an Antibody	92
There Are Two Antigen-Binding Sites per Antibody Molecule	94
The Genetics of the Immunoglobulin Molecule Have Been Determined	96
The Immunoglobulin Fold Is a Tertiary Structure Found in a Large Family of Proteins with Different Functional Roles	97
3.3 Proteins with a Common Catalytic Mechanism: Serine Proteases	97
Proteolytic Enzymes Are Classified Based on their Catalytic Mechanism	98
Serine Proteases Exhibit Remarkable Specificity for Site of Peptide Bond Hydrolysis	99
Serine Proteases Are Synthesized in a Zymogen Form	101
There Are Specific Protein Inhibitors of Serine Proteases	103
Serine Proteases Have Similar Structure–Function Relationships	103
Amino Acid Sequence Homology Occurs in the Serine Protease Family	105
Tertiary Structures of Serine Proteases Are Similar	106
3.4 DNA-Binding Proteins	108
Three Major Structural Motifs of DNA-Binding Proteins	108
DNA-Binding Proteins Utilize a Variety of Strategies for Interaction with DNA	111
3.5 Hemoglobin and Myoglobin	114
Human Hemoglobin Occurs in Several Forms	114
Myoglobin: A Single Polypeptide Chain with One O ₂ -Binding Site	115
A Heme Prosthetic Group Is at the Site of O ₂ Binding	115
X-Ray Crystallography Has Assisted in Defining the Structure of Hemoglobin and Myoglobin	116
Primary, Secondary, and Tertiary Structures of Myoglobin and the Individual Hemoglobin Chains	116
A Simple Equilibrium Defines O ₂ Binding to Myoglobin	117
Binding of O ₂ to Hemoglobin Involves Cooperativity between the Hemoglobin Subunits	119
The Molecular Mechanism of Cooperativity in O ₂ Binding	119
The Bohr Effect Involves Dissociation of a Proton on Binding of Oxygen	123
Bibliography	124
Questions and Answers	125
Clinical Correlations	
3.1 The Complement Proteins	91
3.2 Functions of Different Antibody Classes	92
3.3 Immunization	92
3.4 Fibrin Formation in a Myocardial Infarct and the Action of Recombinant Tissue Plasminogen Activator (rt-PA)	98
3.5 Involvement of Serine Proteases in Tumor Cell Metastasis	99

3.1—

Overview

In Chapter 2 we discussed the fundamentals of protein architecture, including structural organization and physical properties of the amino acid constituents, hierarchical organization of primary, secondary, supersecondary, tertiary, and quaternary structure, and energetic forces that hold these molecules together and provide the flexibility observed in their dynamic motion. Computational and experimental tools were introduced that enable the analysis of high-resolution structural features and their conformational response to perturbations, which may be a simple alteration of the solution environment or aspects of their interactions with other molecules that define their biological function. The concept that structure and function are interrelated was introduced through examples of conservation of primary structure with function, and the reoccurrence of elements of secondary, supersecondary, tertiary, and quaternary structural patterns in molecules that may not share similar functional or evolutionary origin.

In this chapter we examine the specific relationships between structure and function in four **protein families**: immunoglobulins, serine proteases, DNA-binding proteins, and hemoglobins. We pursue this study through the examination of the variability in amino acid sequence, structural organization, and biological function. The significance of the structure–function relationship can best be appreciated through observation of the range of such variations within specific protein families.

The **immunoglobulin family** provides examples of multidomain architecture that supports recognition and binding to foreign molecules and leads to their sequestration. Diversity among family members is the source of specific molecular recognition and individual binding capabilities.

The **serine proteases** provide examples of a family of enzymes that appear to have diverged to perform unique physiological functions, frequently highly organized within enzyme cascade processes. Their inherent similarities in catalytic mechanism and three-dimensional structure are a common link.

DNA-binding proteins are multifamilies of proteins that bind to regulatory sites in DNA and regulate gene expression, an amazing feat as the mammalian genome contains approximately 100,000 unique genes. These proteins contain unusual supersecondary structure motifs that allow them to selectively bind regulatory sites of specific genes.

The **hemoglobin** family offers examples of a highly fine-tuned system that can accommodate small substitutions or mutations, many of which have been studied as to their clinical implications. This family reveals the potential diversity of amino acid sequence substitutions that can be tolerated and allow the protein to function in an acceptable physiological manner.

3.2—

Antibody Molecules:

The Immunoglobulin Superfamily

Antibody molecules are produced in response to invasion by foreign compounds that can be proteins, carbohydrates, and nucleic acid polymers. An antibody molecule noncovalently associates with the foreign substance, initiating a process by which the foreign substance can be eliminated from the organism.

Molecules that induce antibody production are **antigens** and may contain multiple antigenic determinants, small regions of the antigen molecule that elicit the production of a specific antibody to which the antigen binds. In proteins, an antigenic determinant may comprise only six or seven amino acids.

A **hapten** is a small molecule that cannot alone elicit production of specific antibodies but when covalently attached to a larger molecule it acts as an antigenic determinant and induces antibody synthesis. Whereas hapten molecules need attachment to a larger molecule to elicit antibody synthesis, when

detached from their carrier, they will retain the ability to bind strongly to antibody.

It is estimated that each human can potentially produce about 1×10^8 different antibody structures. All antibodies, however, have a similar structure. The determination of the structure has been accomplished from studies of immunoglobulin primary structures and X-ray diffraction that show the three-dimensional structure of the antibody molecule alone and in complex with antigen.

Structural studies of proteins require pure homogeneous preparations. Such samples of antibodies are extremely difficult to isolate from blood because of the wide diversity of antibody molecules present. Homogeneous antibodies can be obtained, however, by the monoclonal hybridoma technique in which mouse myeloma cells are fused with mouse antibody-producing B lymphocytes to construct immortalized hybridoma cells that express a single antibody.

Antibody (Immunoglobulin) Molecules Consist of Four Polypeptide Chains

Antibody molecules are glycoproteins with four polypeptide chains, two identical copies of each of two nonidentical polypeptide chains. Two light chains (L) of identical sequence combine with two heavy chains (H) of identical sequence to form the structure $(LH)_2$. In the most common immunoglobulin type, IgG, the H chains have approximately 440 amino acids (50 kDa). The smaller L polypeptide chains contain about 220 amino acids (25 kDa). The four chains are covalently interconnected by disulfide bonds (Figures 3.1 and 3.2). Each H chain is associated with an L chain such that the NH_2 -terminal ends of both chains are near each other. Since the L chain is half the size of the H chain, only the NH_2 -terminal half of the H chain is associated with the L chain.

In the other classes of immunoglobulins (Table 3.1) the H chains are slightly longer than those of the IgG class. A variable amount of carbohydrate (2–12%, depending on immunoglobulin class) is attached to the H chain.

Constant and Variable Regions of Primary Structure

Comparison of amino acid sequences of antibody molecules elicited by different antigens shows regions of sequence homology and other regions of sequence variability. In particular, sequences of the NH_2 -terminal half of L chains and the

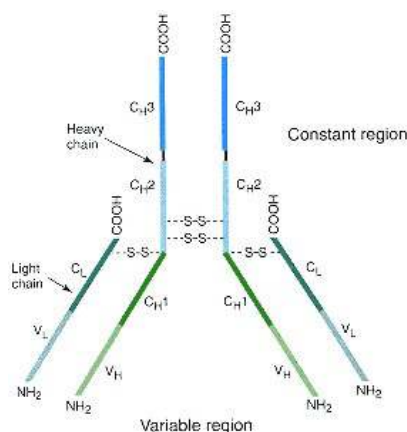

Figure 3.1

Linear representation of four-chain IgG antibody molecule.

Two H chains and two L chains are co-oriented in their COOH-terminal to NH_2 -terminal directions, as shown.

Interchain disulfide bonds link heavy (H) chains, and light (L) chains to the H chains. Domains of the constant (C) region of the H chain are

C_{H1} , C_{H2} , and C_{H3} . The constant region of the L chain is designated C_L , and variable (V) regions are

V_H and V_L of H and L chains, respectively.

Based on figure by Burton, D. R. In: F. Calabi and M. S. Neuberger (Eds.), *Molecular Genetics of Immunoglobulin*. Amsterdam: Elsevier, 1987, pp. 1–50.

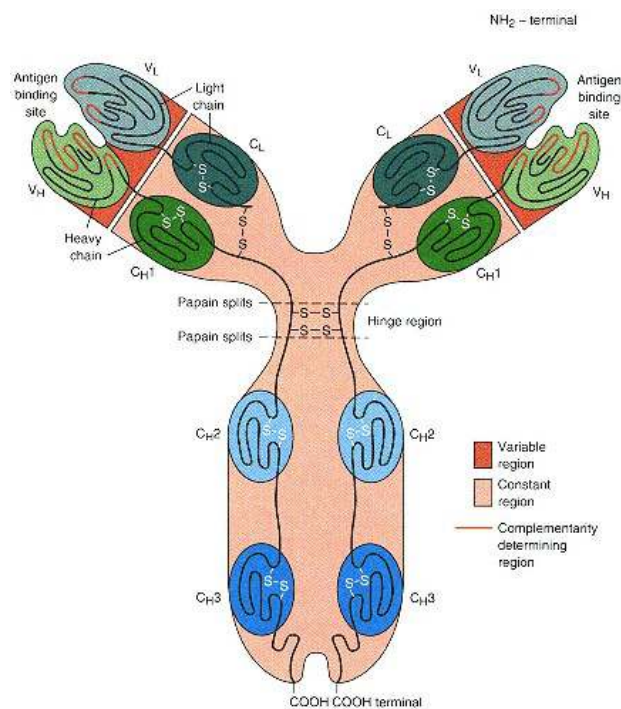

Figure 3.2
Diagrammatic structure for IgG.

Light chains (L) are divided into domains V_L (variable amino acid sequence) and C_L (constant amino acid sequence). Heavy chains (H) are divided into domains V_H (variable amino acid sequence) and C_{H1} , C_{H2} , and C_{H3} . Antigen-binding sites are V_H-V_L . "Hinge" polypeptides interconnect domains.

Positions of inter- and intrachain cystine bonds are shown.

From Cantor, C. R. and Schimmel, P. R. *Biophysical Chemistry*, Part I. San Francisco: Freeman, 1980. Re-printed with permission of Mr. Irving Geis, New York.

NH_2 -terminal quarter of H chains are highly variable between different antibody molecules. These NH_2 -terminal segments are the **variable (V) regions** and designated V_H and V_L domains of H and L chains, respectively. Within these V domains certain segments are "hypervariable." Three **hypervariable regions** of between 5 and 7 residues in the V_L domain and three or four hypervariable regions of between 6 and 17 residues in the V_H domain are commonly found. The hypervariable sequences are also termed the **complementarity-determining regions (CDRs)** as they form the antigen-binding site complementary to the topology of the antigen structure.

In contrast, the COOH-terminal three-quarters of H chains and the COOH-terminal half of L chains are homologous in sequence with other H or L chains

TABLE 3.1 Immunoglobulin Classes

Classes of Immunoglobulin	Approximate Molecular Mass	H Chain Isotype	Carbohydrate by Weight (%)	Concentration in Serum (mg 100 mL ⁻¹)
IgG	150,000	γ , 53,000	2-3	600-1800
IgA	170,000-720,000 ^a	α , 64,000	7-12	90-420
IgD	160,000	δ , 58,000		0.3-40
IgE	190,000	ϵ , 75,000	10-12	0.01-0.10
IgM	950,000 ^a	μ , 70,000	10-12	50-190

^a Forms polymer structures of basic structural unit.

of the same class. These **constant (C) regions** with a homologous primary structure are designated C_{H1} and C_{L1} in the H and L chains, respectively.

The C_{H1} regions determine the antibody class, provide for binding of complement proteins (see Clin. Corr. 3.1), and are the site necessary for antibodies to cross the placental membrane. The V regions determine the antigen specificity of the antibody molecule.

Immunoglobulins in a Single Class Contain Common Homologous Regions

Differences in sequence of the C_{H1} regions between immunoglobulin classes are responsible for the characteristics of each class. In some cases, the C_{H1} sequence promotes the polymerization of antibody molecules of the basic molecular structure $(LH)_2$. Thus antibodies of the IgA class are often covalently linked dimeric structures $[(LH)_2]_2$. Similarly, IgM molecules are pentamers $[(LH)_2]_5$. The different H chains, designated τ , α , δ , ϵ and μ , occur in IgG, IgA, IgM, IgD, and IgE classes, respectively (Table 3.1; see Clin. Corr. 3.2). Two types of L chain sequences are synthesized, designated lambda (λ) and kappa (κ) chains, either of which are found combined with the five classes of H chains.

IgG is the major immunoglobulin in plasma. Biosynthesis of a specific IgG in significant concentrations takes about 10 days after exposure to a new antigen (see Clin. Corr. 3.3). In the absence of an initially high concentration of IgG to a specific antigen, antibodies of the IgM class, which are synthesized at faster

CLINICAL CORRELATION 3.1

The Complement Proteins

At least 11 distinct complement proteins exist in plasma. They are activated by IgG or IgM antibody binding to antigens on the outer cell membrane of invading bacterial cells, protozoa, or tumor cells. After the immunoglobulin-binding event, the 11 complement proteins are sequentially activated and associate with the cell membrane to cause a lysis of the membrane and death of the target cell.

Many complement proteins are precursors of proteolytic enzymes that are present in a nonactive form prior to activation. Upon their activation, they will, in turn, activate a succeeding protein of the pathway by the hydrolysis of a specific peptide bond in the second protein, leading to a cascade phenomenon. Activation of enzymes by specific proteolysis (i.e., hydrolysis of a specific peptide bond) is an important general method for activating extracellular enzymes. For example, the enzymes that catalyze blood clot formation, induce fibrinolysis of blood clots, and digest dietary proteins in the gut are all activated by a specific proteolysis catalyzed by a second enzyme (see pp. 964, 1071).

Upon association to a cellular antigen the exposure of a complement-binding site in the antibody's Fc region occurs and causes the binding of the C1 complement proteins, which are a protein complex composed of three individual proteins: C1q, C1r, and C1s. C1r and C1s undergo a conformational change and become active enzymes on the cell surface. The activated C1 complex (C1a) hydrolyzes a peptide bond in complement proteins C2 and C4, which then also associate on the cell surface. The now active C2–C4 complex has a proteolytic activity that hydrolyzes a peptide bond in complement protein C3. Activated C3 protein binds to the cell surface and the activated C2–C4–C3 complex activates protein C5. Activated protein C5 will associate with complement proteins C6, C7, C8, and six molecules of complement protein C9. This multiprotein complex binds to the cell surface and initiates membrane lysis.

The mechanism is a cascade in which amplification of the trigger event occurs. In summary, activated C1 can activate a number of molecules of C4–C2–C3, and each activated C4–C2–C3 complex can, in turn, activate many molecules of C5 to C9. The reactions of the classical complement pathway are summarized below, where "a" and "b" designate the proteolytically modified proteins and a line above a protein indicates an enzyme activity.

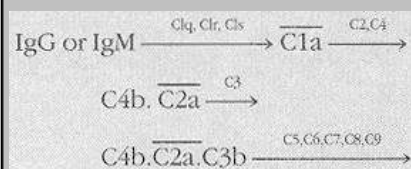

There is an "alternative pathway" for C3 complement activation, initiated by aggregates of IgA or by bacterial polysaccharide in the absence of immunoglobulin binding to cell membrane antigens. This pathway involves the proteins properdin, C3 proactivator convertase, and C3 proactivator.

A major role of the complement systems is to generate opsonins—an old term for proteins that stimulate phagocytosis by neutrophils and macrophages. The major opsonin is C3b; macrophages have specific receptors for this protein. Patients with inherited deficiency of C3 are subject to repeated bacterial infections.

Colten, H. R., and Rosen, F. S. Complement deficiencies. *Annu. Rev. Immunol.* 10:809, 1992; and Morgan, B. P. Physiology and pathophysiology of complement: progress and trends. *Crit. Rev. Clin. Lab. Sci.* 32:265, 1995.

CLINICAL CORRELATION 3.2**Functions of Different Antibody Classes**

The IgA class of immunoglobulins is found primarily in the mucosal secretions (bronchial, nasal, and intestinal mucous secretions, tears, milk, and colostrum). These immunoglobulins are the initial defense against invading viral and bacterial pathogens prior to their entry into plasma or other internal space.

The IgM class is found primarily in plasma. They are the first antibodies elicited in significant quantity on the introduction of a foreign antigen into a host's plasma. IgM antibodies promote phagocytosis of microorganisms by macrophage and polymorphonuclear leukocytes and are also potent activators of complement (see Clin. Corr. 3.1). IgM antibodies occur in many external secretions but at levels lower than those of IgA.

The IgG class occurs in high concentration in plasma. Their response to foreign antigens takes a longer period of time than that of IgM. At maximum concentration they are present in significantly higher concentration than IgM. Like IgM, IgG antibodies promote phagocytosis in plasma and activate complement.

The normal biological functions of the IgD and IgE classes of immunoglobulins are not known; however, the IgE antibodies play an important role in allergic responses such as anaphylactic shock, hay fever, and asthma.

Immunoglobulin deficiency usually causes increased susceptibility to infection. X-linked agammaglobulinemia and common variable immunodeficiency are two examples. The commonest disorder is selective IgA deficiency, which results in recurrent infections of sinuses and the respiratory tract.

Rosen, F. S., Cooper, M. D., and Wedgewood, R. J. P. The primary immunodeficiencies. *N. Engl. J. Med.* 311:235 (Part I); 300 (Part II), 1984.

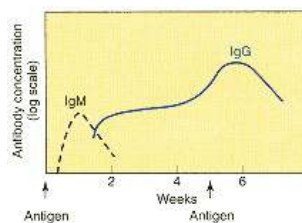

Figure 3.3
Time course of specific antibody IgM and IgG response to added antigen.

Based on a figure in Stryer, L. *Biochemistry*. San Francisco: Freeman, 1988, p. 890.

rates, will associate with the antigen and serve as the first line of defense until large quantities of IgG are produced (Figure 3.3; see Clin. Corr. 3.3).

Repeating Amino Acid Sequences and Homologous Three-Dimensional Domains Occur within an Antibody

Within each of the polypeptide chains of an antibody molecule is a repeating pattern of amino acid sequences. For the IgG class, the repetitive pattern is observed between segments of approximately 110 amino acids within both L and H chains. This homology is far from exact, but clearly a number of amino acids match identically following alignment of 110 amino acid segments. Other amino acids are matched in the sequence by having similar nonpolar or polar side chains. As the H chains are about 440 amino acids in length, the repetition of the homologous sequence occurs four times along an immunoglobulin H chain. Based on this sequence pattern, the chain is divided into one V_H region and three C_H regions (designated C_{H1} , C_{H2} , and C_{H3}) (see Figures 3.1 and 3.2). The L chain of about 220 amino acids is divided into one V_L region and one

CLINICAL CORRELATION 3.3**Immunization**

An immunizing vaccine can consist of killed bacterial cells, inactivated viruses, killed parasites, a nonvirulent form of live bacterium related to a virulent bacterium, a denatured bacterial toxin or recombinant protein. The introduction of a vaccine into a human can lead to protection against virulent forms of microorganisms or toxic agents that contain the same antigen. Antigens in nonvirulent material not only cause the differentiation of lymphoid cells so that they produce antibody toward the foreign antigen but also cause differentiation of some lymphoid cells into memory cells. Memory cells do not secrete antibody but place antibodies to the antigen onto their outer surface, where they act as future sensors for the antigen. These memory cells are like a longstanding radar for the potentially virulent antigen. On reintroduction of the antigen at a later time, the binding of the antigen to the cell surface antibody in the memory cells stimulates the memory cell to divide into antibody-producing cells as well as new memory cells. This reduces the time for antibody production that is required on introduction of an antigen and increases the concentration of antigen-specific antibody produced. It is the basis for the protection provided by immunization.

Recently introduced vaccines for adults include pneumococcal vaccine (to prevent pneumonia due to *Diplococcus pneumoniae*), hepatitis B vaccine, and influenza vaccine. The latter changes each year to account for antigenic variation in the influenza virus.

Flexner, C. New approaches to vaccination. *Adv. Pharmacol.* 21:51, 1990; and Sparling, P. F., Elkins, C., Wyrick, P. B., and Cohen, M. S. Vaccines for bacterial sexually transmitted infections: a realistic goal? *Proc. Natl. Acad. Sci. U.S.A.* 91:2456, 1994.

C_L region. Each of these sequence repeats contains an intrachain disulfide bond linking two cysteines (Figure 3.2).

Each of the 110 amino acid segments form separate structural domains of similar tertiary structure as shown by X-ray diffraction studies. Each 110 segment of the H and L chains folds into a supersecondary structure with a unique but similar arrangement of antiparallel β -strands, which generates a motif known as an **immunoglobulin fold** (Figure 3.4). This motif consists of 7 to 9 polypeptide strands that form two antiparallel β -sheets that are aligned face-to-face. Globular domains result from the strong interaction between two immunoglobulin folds on two separate chains (Figure 3.5). The associations are between domains V_L-V_H and C_L-C_H1 in the H and L chains. In the C-terminal half of the H chains, the two chains associate to generate domains $C_{H2}-C_{H2}$ and $C_{H3}-C_{H3}$ (Figure 3.2). A "hinge" polypeptide sequence interconnects the two C_L-C_H1 domains with the $C_{H2}-C_{H2}$ domain in the antibody structure. Thus the antibody structure

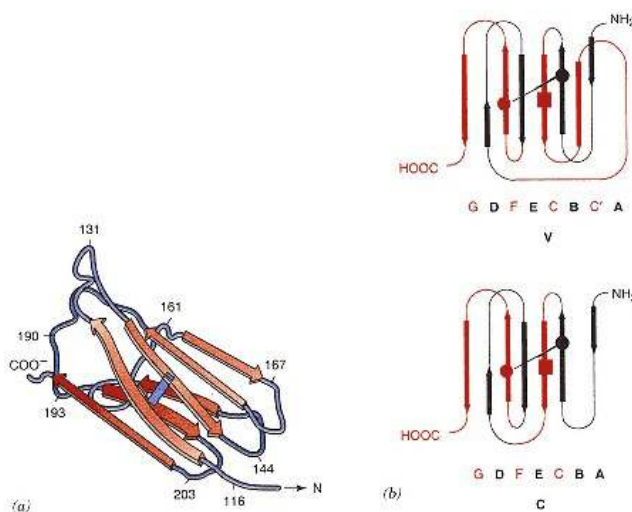

Figure 3.4
Immunoglobulin fold.

(a) Schematic diagram of folding of a C_L domain, showing pleated sheet structure. Arrows show strands of β -sheet and bar (blue) shows position of cystine bond. Light arrows are for β -strands in plane above and dark arrows are β -strands in plane below.

(b) Diagrammatic outline of arrangement of β -strands in immunoglobulin fold motif. Examples are for IgG variable and constant regions. Thick arrows indicate β -strands and thin lines loops that interconnect the β -strands. Circles indicate cysteines that form intradomain disulfide bond. Squares show positions of tryptophan residues that are an invariant component of the core of the immunoglobulin fold. Boldface black letters indicate strands that form one plane of the sheet, while other letters form the parallel plane behind the first plane.

(a) From Edmundson, A. B., Ely, K. R., Abola, E. E., Schiffer, M., and Pavagiotopoulos, N. *Biochemistry* 14:3953, 1975.

Copyright © 1975 by American Chemical Society.

Reprinted with permission.

(b) Based on a figure by Calabi, F. In: F. Calabi and M. S. Neuberger (Eds.), *Molecular Genetics of Immunoglobulin*. Amsterdam: Elsevier, 1987, pp. 203–239.

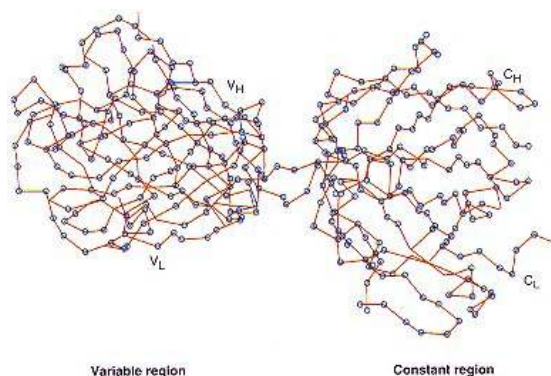

Figure 3.5

α -Carbon (\odot) structure of Fab fragment of IgG KOL showing V_L-V_H and C_L-C_H1 domains interconnected by the hinge polypeptides.

From Huber, R., Deisenhofer, J., Coleman, P. M., Matsushima, M., and Palm, W. In *The Immune System*, 27th Mosbach Colloquium. Berlin: Springer-Verlag, 1976, p. 26.

exhibits six domains, each domain due to the association of two immunoglobulin folds (Figures 3.2 and 3.6). The NH_2 -terminal V_L - V_H domains contain a shallow crevice in the center of a hydrophobic core that binds the antigen. Hypervariable sequences in the V domain crevices form loops that come close together and are the complementarity binding site for the antigen (see Figures 3.6 and 3.7). The sequences of the hypervariable loops give a unique three-dimensional conformation for each antibody that makes it specific to its antigenic determinant. Small changes in conformation of the CDRs occur on antigen binding to V_L - V_H domains, indicating that antigen binding induces an optimum complementary fit to the variable CDR site. Antigen binding may also induce conformational changes between V_L - V_H domains and the other domains that activate effector sites, such as for complement binding to the C_{H2} - C_{H2} domain. The strength of association between antibody and antigen is due to noncovalent forces (see Chapter 2). Complementarity of the structures of the antigenic determinant and antigen-binding site results in extremely high equilibrium affinity constants, between 10^5 and 10^{10} M^{-1} (strength of 7–14 kcal mol^{-1}) for this noncovalent association.

There Are Two Antigen-Binding Sites Per Antibody Molecule

The NH_2 -terminal variable (V) domains of each pair of L and H chains (V_L - V_H) comprise an antigen-binding site; thus there are two antigen-binding sites per antibody molecule. The existence of an antigen-binding site in each LH pair is demonstrated by treating antibody molecules with the proteolytic enzyme papain, which hydrolyzes a peptide bond in the hinge peptide of each H chain (see Figures 3.2 and 3.8). The antibody molecule is cleaved into three products. Two are identical and consist of the NH_2 -terminal half of the H chain (V_H - C_{H1}) associated with the full L chain (Figure 3.8). Each of these fragments binds antigen with a similar affinity to that of the intact antibody molecule and is designated an **Fab** (antigen binding) **fragment**. The other product from the papain hydrolysis is the COOH -terminal half of the H chains (C_{H2} - C_{H3}) joined together in a single covalent fragment by cystine bonds. This is the **Fc** (crystallizable) **fragment**, which exhibits no binding affinity for the antigen. The L chain can be dissociated from its H chain segment within the Fab fragment by oxidation of disulfide bonds, which eliminates antigen binding. Accordingly, each antigen-binding site must be formed from components of both the L chain (V_L) and the H chain (V_H) domains acting together.

In summary, the major features of antibody structure and antibody-antigen interactions include the following: (1) The polypeptide chains fold into multiple

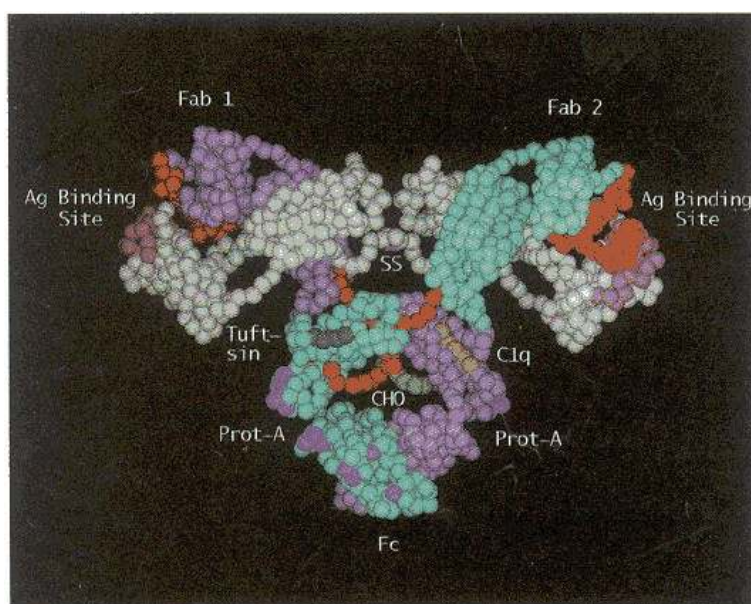

Figure 3.6

Model of an IgG antibody molecule.

Only the α -carbons of the structure appear. The two L chains are represented by light gray spheres and the H chains by lavender spheres. Carbohydrates attached to the two C_{H2} domains are green and orange. The CDR regions

of the V_H - V_L domains are dark red in the H chains and pink in the L chains. The interchain disulfide bond between the L and H chains is a magenta ball-and-stick representation (partially hidden). The heptapeptide hinge between C_{H1} and C_{H2} domains, connecting the Fab and Fc units, are dark red. The center of the C1q complement site in the C_{H2} domains is yellow-green the protein

A docking sites at the junction of C_{H2} and C_{H3} are magenta, and the tuftsin binding site in C_{H2} is gray. Tuftsin is a natural tetrapeptide that induces phagocytosis by macrophages and may be transported bound to an immunoglobulin. Protein A is a bacterial protein with a high affinity to immunoglobulins.

Photograph generously supplied by Dr. Allen B. Edmundson, from Guddat, L. W., Shan, L., Fan Z-C., et al. *FASEB J.* 9:101, 1995.

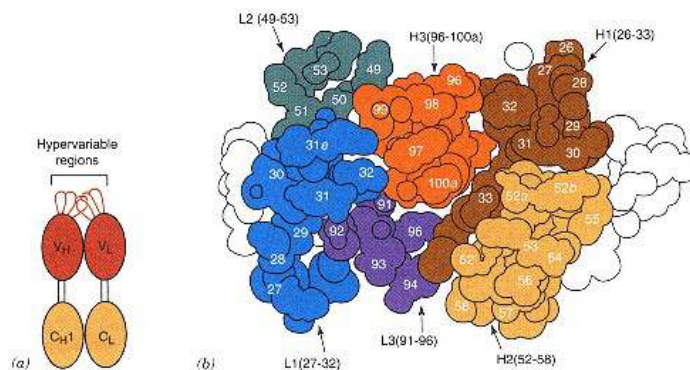

Figure 3.7
Hypervariable loops in immunoglobulin.

(a) Schematic diagram showing hypervariable loops (CDRs) in V_L - V_H domain that form the antigen-binding site.

(b) A cut through an antigen-binding site showing contributions of different CDRs using CPK space-filling models of the atoms.

(a) From Branden, C. and

Tooze, J. *Introduction to Protein Structure*. New York Garland Publishing, 1991, p. 187.

(b) From Branden, C., and Tooze, J. *Introduction to Protein Structure*. New York Garland Publishing, 1991, p. 189, and attributed to Chothia, C. and Lesk, A. *J. Mol. Biol.* 196:914, 1987.

domains, each domain having an immunoglobulin fold supersecondary structure motif. (2) Two immunoglobulin folds on separate chains associate to form the six domains of the basic immunoglobulin structure. The V_L and V_H associate to form the two NH_2 -terminal domains that bind to antigen. (3) The antigen-binding site of the V_L - V_H domains is generated by hypervariable loops (CDRs), which form a continuous surface with a complementary topology to the antigenic determinant. (4) The strong interactions between antigen and antibody CDRs are noncovalent and include van der Waals, hydrogen bonding, and hydrophobic interactions. Ionic salt bridges participate in antigen-antibody associations to a much lesser extent. (5) Small conformational changes occur in the V_L - V_H domain upon association of antigen, indicating an "induced-fit" mechanism in association of antigen to antibody. (6) The binding of antigen to the V_L - V_H domains induces conformational changes between binding and distant domains of the antibody. These allosteric movements alter the binding affinity of effector sites in the constant domains such as that for binding of complement protein C1q to the C_{H2} - C_{H2} domain (see Clin. Corr. 3.1).

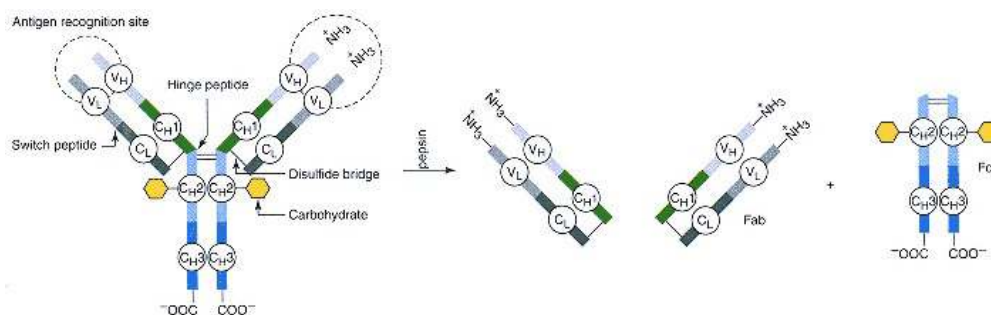

Figure 3.8

Hydrolysis of IgG into two Fab and one Fc fragments by papain, a proteolytic enzyme.

The Genetics of the Immunoglobulin Molecule Have Been Determined

Genes that code for amino acid sequences of human IgG L chains are located on different chromosomes than those for IgG H. The V and C regions of the L and H chains are specified by distinct genes. There are four unique genes that code for the C domains of the H chain in the IgG antibody class. Each gene codes for a complete constant region, thus coding for all the amino acids of the H chain except for the V_H region sequence. These four genes are known as gamma (γ) genes—that is, γ₁, γ₂, γ₃, and γ₄—that give rise to **IgG isotypes** IgG₁, IgG₂, IgG₃, and IgG₄. Figure 3.9 presents the amino acid sequences of three γ-gene proteins. There is a 95% homology in amino acid sequence among the genes.

It is likely that a primordial gene coded for a single segment of approximately 110 amino acids, and **gene duplication** events resulted in the three repeating units within the same gene. Mutations modified the individual sequences so that an exact correspondence in sequence no longer exists. Each

```

Constant Region C1:
Cγ1: AlaSerThrLysGlyProSerValPheProLeuAlaProSerSerLysSerThrSerGlyGlyThrAlaAlaLeuGly
Cγ2                                     C   R           E   S
Cγ4

Cγ1 CysLeuValLysAspTyrPheProGluProValThrValSerTrpAsnSerGlyAlaLeuThrSerGlyValHisThr
Cγ2
Cγ4

Cγ1 PheProAlaValLeuGlnSerSerGlyLeuTyrSerLeuSerSerValValThrValProSerSerSerLeuGly
Cγ2                                     N   F
Cγ4

Cγ1 ThrGlnThrTyrIleCysAsnValAsnHisLysProSerAsnThrLysValAspLysLysVal
Cγ2           T           D           T
Cγ4   K           R

Hinge Region H:
Cγ1 GluProLysSerCysAspLysThrHisThrCysProProCysPro
Cγ2   R   C   V   E   C   P   P   -   -   -
Cγ4   S   Y   G   P   P           S   -   -   -

Constant Region C2:
Cγ1 AlaPro   GluLeuLeuGlyGlyProSerValPheLeuPheProProLysProLysAspThrLeuMetIleSerArg
Cγ2   -   P   V   A
Cγ4   E   F   G

Cγ1 ThrProGluValThrCysValValValAspValSerHisGluAspProGluValLysPheAsnTrpTyrValAspGly
Cγ2
Cγ4                                     Q           Q

Cγ1 ValGluValHisAsnAlaLysThrLysProArgGluGluGlnTyrAsnSerThrThrArgValValSerValLeuThr
Cγ2                                     F           F
Cγ4                                     Y           Y

Cγ1 ValLeuHisGlnAspTrpLeuAsnGlyLysGluTyrLysCysLysValSerAsnLysAlaLeuProAlaProIleGlu
Cγ2   V           G           S   S
Cγ4

Cγ1 LysThrIleSerLysAlaLys
Cγ2           T
Cγ4

Constant Region C3:
Cγ1 GlyGlnProArgGluProGlnValTyrThrLeuProProSerArgAspGluLeuThrLysAsnGlnValSerLeuThr
Cγ2                                     E   M
Cγ4                                     Q

Cγ1 CysLeuValLysGlyPheTyrProSerAspIleAlaValGluTrpGluSerAsnGlyGlnProGluAsnAsnTyrLys
Cγ2
Cγ4

Cγ1 ThrThrProProValLeuAspSerAspGlySerPhePheLeuTyrSerLysLeuThrValAspLysSerArgTrpGln
Cγ2           M           R
Cγ4

Cγ1 GlnGlyAsnValPheSerCysSerValMetHisGluAlaLeuHisAsnHisTyrThrGlnLysSerLeuSerLeuSer
Cγ2
Cγ4   E

Cγ1 ProGlyLysStop
Cγ2
Cγ4   L

```

Figure 3.9
Amino acid sequence of the heavy chain constant regions of the IgG heavy chain γ₁, γ₂, and γ₄ genes.

Domains of constant domain C_{H1}, hinge region H, constant domain C_{H2}, and constant domain C_{H3} are presented. Sequence for γ₁ is fully given and differences in γ₂ and γ₄ from γ₁ sequence are shown using single-letter amino acid abbreviations. Dashed line (–) indicates absence of an amino acid in position correlated with γ₁, in order to better align sequences to show maximum homology. Sequence of γ₁ chain from Ellison, J. W., Berson, B. J., and Hood, L. E. *Nucleic Acid Res.* 10:4071, 1982; and sequences of the γ₂ and γ₄ genes from Ellison, J. and Hood, L. *Proc. Natl. Acad. Sci. U.S.A.* 79:1984, 1982.

immunoglobulin domain has a similar domain length and immunoglobulin folding pattern stabilized by a cystine linkage. Later in evolution gene duplications led to the multiple genes (γ_1 , γ_2 , γ_3 , and γ_4) that code for the constant regions of the IgG class H chains.

The Immunoglobulin Fold Is a Tertiary Structure Found in a Large Family of Proteins with Different Functional Roles

The immunoglobulin fold motif is present in many nonimmunological proteins, which exhibit widely different functions. Based on their structural homology they are grouped into a **protein superfamily** (Figure 3.10). For example, the Class 1 major histocompatibility complex proteins are in this superfamily, they have immunoglobulin fold motif structures consisting of two stacked antiparallel β -sheets enclosing an internal space filled mainly by hydrophobic amino acids. Two cysteines in the structure form a disulfide bond linking the facing β -sheets. Transcription factors NF- κ B and p53 also contain an immunoglobulin fold motif. It can be speculated that gene duplication during evolution led to distribution of the structural motif in the functionally diverse protein superfamily.

3.3—

Proteins with a Common Catalytic Mechanism: Serine Proteases

Serine proteases are a family of enzymes that utilize a single uniquely activated serine residue in their substrate-binding site to catalytically hydrolyze peptide bonds. This serine can be characterized by the irreversible reaction of its side chain hydroxyl group with diisopropylfluorophosphate (DFP) (Figure 3.11). Of

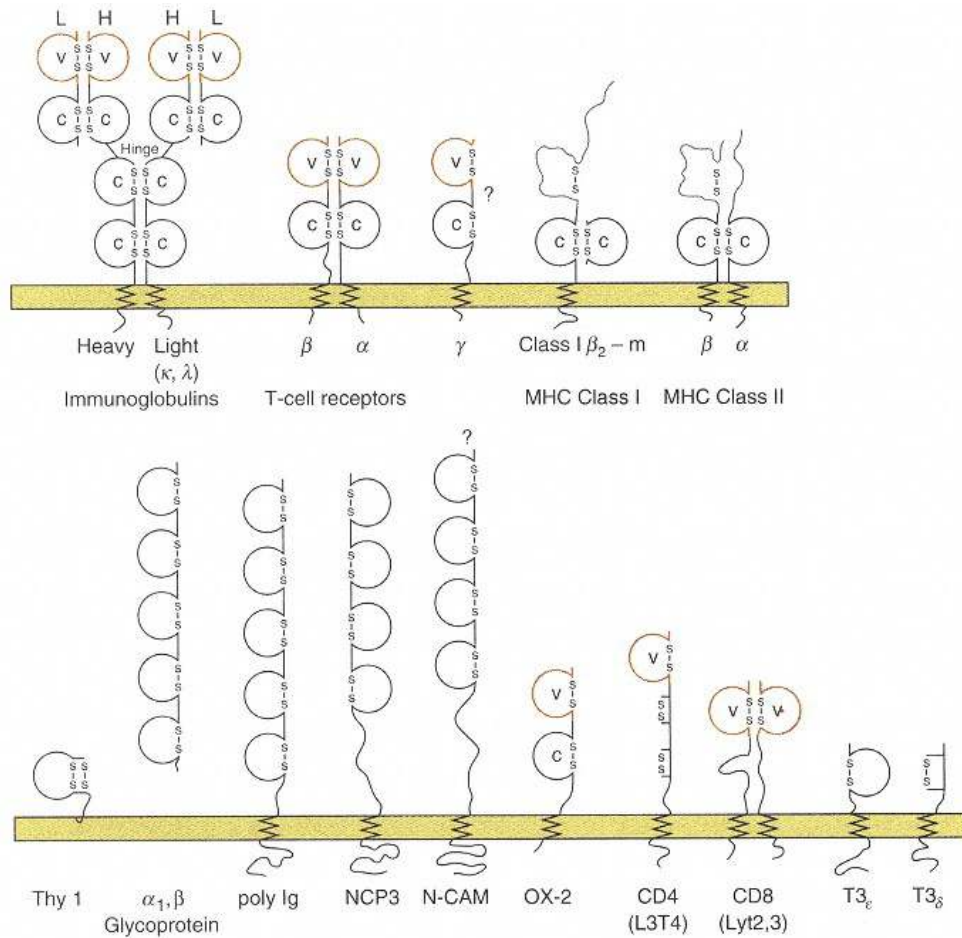

Figure 3.10

Diagrammatic representation of immunoglobulin domain structures from different proteins of immunoglobulin gene superfamily.

Proteins presented include heavy and light chains of immunoglobulins, T-cell receptors, major histocompatibility complex (MHC) Class I and Class II proteins, T-cell accessory proteins involved in Class I (CD8) and Class II (CD4) MHC recognition and possible ion channel formation, a receptor responsible for transporting certain classes of immunoglobulin across mucosal membranes (poly-Ig), β_2 -micro-globulin, which associates with class I molecules, a human plasma protein with unknown function (OX-2-glycoprotein), two molecules of unknown function with a tissue distribution that includes lymphocytes and neurons (Thy-1, OX-2), and two brain-specific molecules, neuronal cell adhesion molecule (N-CAM) and neurocytoplasmic protein 3 (NCP3). Reprinted with permission from Hunkapiller, T., and Hood, L. *Nature* 323:15, 1986.

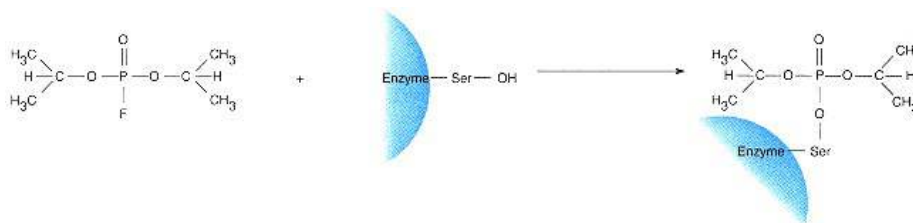

Figure 3.11

Reaction of diisopropylfluorophosphate (DFP) with the active-site serine in a serine protease.

all the serines in the protein, DFP reacts only with the catalytically active serine to form a phosphate ester.

Proteolytic Enzymes Are Classified Based on Their Catalytic Mechanism

Proteolytic enzymes are classified according to their catalytic mechanism. Besides serine proteases, other classes utilize cysteine (**cysteine proteases**), aspartate (**aspartate proteases**), or metal ions (**metallo proteases**) to perform their catalytic function. Proteases that hydrolyze peptide bonds within a polypeptide chain are classified as **endopeptidases** and those that cleave the peptide bond of either the COOH- or NH₂-terminal amino acid are classified as **exopeptidases**.

Serine proteases often activate other serine proteases from their inactive precursor form, termed a **zymogen**, by the catalytic cleavage of a specific peptide bond in their structure. Serine proteases participate in carefully controlled physiological processes such as blood coagulation (see Clin. Corr. 3.4),

CLINICAL CORRELATION 3.4

Fibrin Formation in a Myocardial Infarct and the Action of Recombinant Tissue Plasminogen Activator (rt-PA)

Coagulation is an enzyme cascade process in which inactive serine protease enzymes (zymogens) are catalytically activated by other serine proteases in a stepwise manner (the coagulation pathway is described in Chapter 22). These multiple activation events generate catalytic products with a dramatic amplification of the initial signal of the pathway. The end product of the coagulation pathway is a cross-linked fibrin clot. The zymogen of the serine protease components of coagulation include factor II (prothrombin), factor VII (proconvertin), factor IX (Christmas factor), factor X (Stuart factor), factor XI (plasma thromboplastin antecedent) and factor XII (Hageman factor). The roman numeral designation was assigned in the order of their discovery and not from their order of action within the pathway. Upon activation of their zymogen forms, the activated enzymes are noted with the suffix "a." Thus prothrombin is denoted as factor II, and the activated enzyme, thrombin, is factor IIa.

The main function of coagulation is to maintain the integrity of the closed circulatory system after blood vessel injury. The process, however, can be dangerously activated in a myocardial infarction and decrease blood flow to heart muscle. About 1.5 million individuals suffer heart attacks each year, resulting in 600,000 deaths. A fibrinolysis pathway also exists in blood to degrade fibrin clots. This pathway also utilizes zymogen factors that are activated to serine proteases. The end reaction is the activation of plasmin, a serine protease. Plasmin acts directly on fibrin to catalyze the degradation of the fibrin clot. Tissue plasminogen activator (t-PA) is one of the plasminogen activators that activates plasminogen to form plasmin. Recombinant t-PA (rt-PA) is produced by gene cloning technology (see Chapter 18). Clinical studies show that the administration of rt-PA shortly after a myocardial infarct significantly enhances recovery. Other plasminogen activators such as urokinase and streptokinase are also effective.

The GUSTO investigators (authors). An international randomized trial comparing four thrombolytic strategies for acute myocardial infarction. *N. Engl. Med.* 329:673, 1993; International Study Group (authors). In hospital mortality and clinical course of 20,891 patients with suspected acute myocardial infarction randomized between alteplase and streptokinase with or without heparin. *Lancet* 336:71, 1990; and Gillis, J. C., Wagstaff, A. J., and Goa, K. L. Alteplase. A reappraisal of its pharmacological properties and therapeutic use in acute myocardial infarction. *Drugs* 50:102, 1995.

TABLE 3.2 Some Serine Proteases and Their Biochemical and Physiological Roles

<i>Protease</i>	<i>Action</i>	<i>Possible Disease Due to Deficiency or Malfunction</i>
Plasma kallikrein Factor XIIa Factor XIa Factor IXa Factor VIIa Factor Xa Factor IIa (thrombin) Activated protein C	Coagulation (see Clin. Corr. 3.4)	Cerebral infarction (stroke), coronary infarction, thrombosis, bleeding disorders
Factor C1r Factor C1s Factor D Factor B C3 convertase	Complement (see Clin. Corr. 3.1)	Inflammation, rheumatoid arthritis, autoimmune disease
Trypsin Chymotrypsin Elastase (pancreatic) Enteropeptidase	Digestion	Pancreatitis
Urokinase plasminogen activator Tissue plasminogen activator Plasmin	Fibrinolysis, cell migration, embryogenesis, menstruation	Clotting disorders, tumor metastasis (see Clin. Corr. 3.5)
Tissue kallikreins	Hormone activation	
Acrosin	Fertilization	Infertility
α -Subunit of nerve growth factor γ -Subunit of nerve growth factor	Growth factor activation	
Granulocyte elastase Cathepsin G Mast cell chymases Mast cell tryptases	Extracellular protein and peptide degradation, mast cell function	Inflammation, allergic response

fibrinolysis, complement activation (see Clin. Corr. 3.1), fertilization, and hormone production (Table 3.2). The protein activations catalyzed by serine proteases are examples of "limited proteolysis" because only one or two specific peptide bonds of the hundreds in a protein substrate are hydrolyzed. Under denaturing conditions, however, these same enzymes hydrolyze multiple peptide bonds and lead to digestion of peptides, proteins, and even self-digestion (autolysis). Several diseases, such as emphysema, arthritis, thrombosis, cancer metastasis (see Clin. Corr. 3.5), and some forms of hemophilia, are thought to result from the lack of regulation of serine protease activities.

Serine Proteases Exhibit Remarkable Specificity for Site of Peptide Bond Hydrolysis

Many serine proteases exhibit preference for hydrolysis of peptide bonds adjacent to a particular class of amino acid. The serine protease trypsin cleaves following basic amino acids such as arginine and lysine, and chymotrypsin cleaves peptide bonds following large hydrophobic amino acid residues such

CLINICAL CORRELATION 3.5

Involvement of Serine Proteases in Tumor Cell Metastasis

The serine protease urokinase is believed to be required for the metastasis of cancer cells. Metastasis is the process by which a cancer cell leaves a primary tumor and migrates through the blood or lymph system to a new tissue or organ, where a secondary tumor grows. Increased synthesis of urokinase has been correlated with an increased ability to metastasize in many cancers. Urokinase activates plasminogen to form plasmin. Plasminogen is ubiquitously located in extracellular space and its activation to plasmin can cause the catalytic degradation of the proteins in the extracellular matrix through which the metastasizing tumor cells migrate. Plasmin can also activate procollagenase to collagenase, promoting the degradation of collagen in the basement membrane surrounding the capillaries and lymph system. This promotion of proteolytic degradative activity by the urokinase secreted by tumor cells allows the tumor cells to invade the target tissue and form secondary tumor sites.

Dano, K., Andreasen, P. A., Grondahl-Hansen, J., Kristensen, P., Nielsen, L. S., and Skriver, L. Plasminogen activators, tissue degradation and cancer. *Adv. Cancer Res.* 44:139, 1985; Yu, H., and Schultz, R. M. Relationship between secreted urokinase plasminogen activator activity and metastatic potential in murine B16 cells transfected with human urokinase sense and antisense genes. *Cancer Res.* 50:7623, 1990; and Fazioli, F., and Blasi, F. Urokinase-type plasminogen activator and its receptor: new targets for anti-metastatic therapy? *Trends Pharmacol. Sci.* 15:25, 1994.

as tryptophan, phenylalanine, tyrosine, and leucine. Elastase cleaves peptide bonds following small hydrophobic residues such as alanine. A serine protease may be called trypsin-like if it prefers to cleave peptide bonds of lysine and arginine, chymotrypsin-like if it prefers aromatic amino acids, and elastase-like if it prefers amino acids with small side chain groups like alanine. The specificity for a certain type of amino acid only indicates its relative preference. Trypsin can also cleave peptide bonds following hydrophobic amino acids, but at a much slower rate than for the basic amino acids. Thus specificity for hydrolysis of the peptide bond of a particular type of amino acid may not be absolute, but may be more accurately described as a range of most likely targets. Each of the identical amino acid hydrolysis sites within a protein substrate is not equally susceptible. Trypsin hydrolyzes each of the multiple arginine peptide bonds in a particular protein at a different catalytic rate, and some may require a conformational change to make them accessible.

Detailed studies of the specificity of serine proteases for a particular peptide bond have been performed with synthetic substrates with fewer than 10 amino acids (Table 3.3). Because these substrates are significantly smaller than the

TABLE 3.3 Reactivity of α -Chymotrypsin and Elastase Toward Substrates of Various Structures

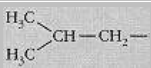
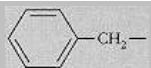
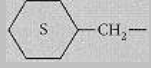
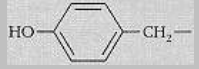
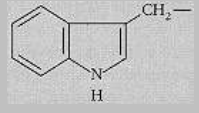
Structure	Variation in Side Chain Group (Chymotrypsin)	Relative Reactivity ^a
Glycyl	H-	1
Leucyl		1.6×10^4
Methionyl	CH ₃ -S-CH ₂ -CH ₂ -	2.4×10^4
Phenylalaninyl		4.3×10^6
Hexahydrophenylalaninyl		8.2×10^6
Tyrosyl		3.7×10^7
Tryptophanyl		4.3×10^7
Variation in chain length (elastase hydrolysis of Ala N-terminal amide) ^b		
	Ac-Ala-NH ₂	
	Ac-Pro-Ala-NH ₂	1
	Ac-Ala-Pro-Ala-NH ₂	1.4×10^1
	Ac-Pro-Ala-Pro-Ala-NH ₂	4.2×10^3
	Ac-Ala-Pro-Ala-Pro-Ala-	4.4×10^5
	NH ₂	2.7×10^5

^a Calculated from values of k_{cat}/K_m found for *N*-acetyl amino acid methyl esters in chymotrypsin substrates.

^b Calculated from values of k_{cat}/K_m in Thompson, R. C., and Blout, E. R. *Biochemistry* 12:57, 1973.

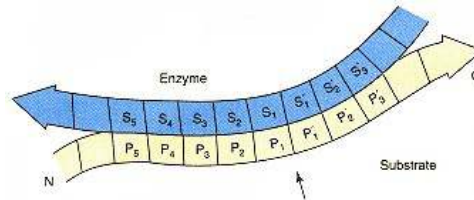

Figure 3.12

Schematic diagram of binding of a polypeptide substrate to binding site in a proteolytic enzyme.

P_5, P_4, \dots, P_1' are amino acid residues in the substrate that are binding to subsites S_5, S_4, \dots, S_1' in the enzyme with peptide hydrolysis occurring between P_1-P_1' (arrow).

NH_2 -terminal direction of substrate polypeptide chain is indicated by N, and COOH-terminal direction by C. Redrawn from Polgar, L. In: A. Neuberger and K. Brocklehurst (Eds.), *Hydrolytic Enzymes*. Amsterdam: Elsevier, 1987, p. 174.

natural ones, they interact only with the catalytic site (primary binding site S_1 , see below) and are said to be **active-site directed**. Studies with small substrates and inhibitors indicate that the site of hydrolysis is flanked by approximately four amino acid residues in both directions that bind to the enzyme and impact on the reactivity of the bond hydrolyzed. The two amino acids in the substrate that contribute the hydrolyzable bond are designated S_1-S_1' (Figure 3.13).

Serine Proteases Are Synthesized in a Zymogen Form

Serine proteases are synthesized in an inactive **zymogen** form, which requires limited proteolysis to produce the active enzyme. Those for coagulation are synthesized in liver cells and are secreted into the blood for subsequent activation by other serine proteases following vascular injury. Zymogen forms are usually designated by the suffix *-ogen* after the enzyme name; the zymogen form of trypsin is termed trypsin *ogen* and for chymotrypsin is termed chymotrypsin *ogen*. In some cases the zymogen form is referred to as a **proenzyme**; the zymogen form of thrombin is prothrombin.

Several plasma serine proteases secrete zymogen forms that contain **multiple nonsimilar domains**. Protein C, involved in a fibrinolysis pathway in blood, has four distinct domains (Figure 3.14). The NH_2 -terminal domain con-

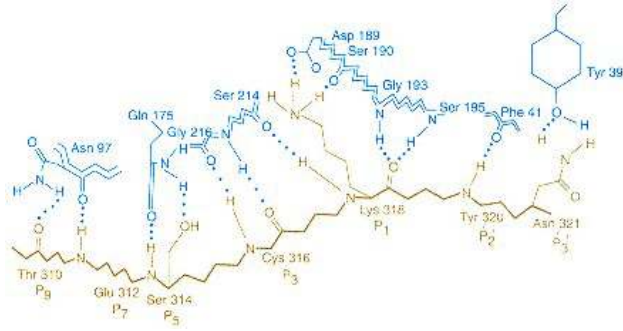

Figure 3.13
Schematic drawing of binding of pancreatic trypsin inhibitor to trypsinogen based on X-ray diffraction data.

Binding-site region of trypsinogen in the complex assumes a conformation like that of active trypsin with inhibitor, which is believed to bind in a similar manner to a substrate in the active enzyme-binding site. One cannot obtain X-ray structures of a natural enzyme-substrate complex because substrate is used up at a rate faster than the time of the X-ray diffraction experiment (see p. 76). Note that inhibitor has an extended conformation so that amino acids $P_9, P_7, P_5, P_3, P_1, \dots, P_5$ interact with binding subsites S_5, \dots, S_3 . Potentially hydrolyzable bond in inhibitor is between P_1-P_1'
 Reprinted with permission from Bolognesi, M., Gatti, B., Menegatti, E., Guarneri, M., Papa-mokos, E., and Huber, *R. J. Mol. Biol.* 162:839, 1983.

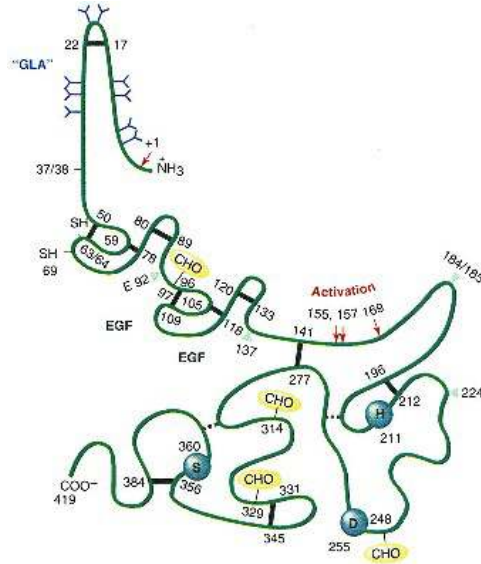

Figure 3.14
Schematic of domain structure for protein C showing multi-domain structure.
 "GLA" refers to the γ -carboxyglutamic residues (indicated by tree structures) in the NH_2 -terminal domain, disulfide bridges are indicated by thick bars, EGF indicates positions of epidermal growth factor-like domains, and CHO indicates positions where sugar residues are joined to the polypeptide chain. Proteolytic cleavage sites leading to catalytic activation are shown by arrows. Amino acid sequence is numbered from NH_2 -terminal end, and catalytic sites of serine, histidine, and aspartate are shown by circled one-letter abbreviations S, H, and D, respectively.
 Redrawn from a figure in Long, G. L. *J. Cell. Biochem.* 33:185, 1987.

tains the derived amino acid, γ -carboxyglutamic acid (Figure 3.15), which is enzymatically formed by carboxylation of glutamic acid residues in a vitamin K-dependent reaction. The γ -carboxyglutamic acids chelate calcium ions and form part of a binding site to membranes. The COOH-terminal segment contains the catalytic domains. Activation of these zymogens requires specific proteolysis outside the catalytic domains (Figure 3.14) and is controlled by the binding through the nine γ -carboxyglutamic acid residues at the NH_2 -terminal end to a membrane.

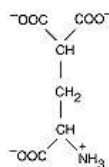

Figure 3.15
Structure
of
the derived
amino acid
 γ -carboxy-
glutamic
acid (abbrev-
iation Gla), found
in NH_2 -terminal
domain of many
clotting proteins.

There Are Specific Protein Inhibitors of Serine Proteases

Evolutionary selection of this enzyme family for participation in physiological processes requires a parallel evolution of control factors. Specific proteins inhibit the activities of serine proteases after their physiological role has ended (Table 3.4). Thus coagulation is limited to the site of vascular injury and complementation activation leads to lysis only of cells exhibiting foreign antigens. Inability to control these protease systems, which may be caused by a deficiency of a specific inhibitor, can lead to undesirable consequences, such as thrombi formation in myocardial infarction and stroke or uncontrolled reactions of complement in autoimmune disease. Natural inhibitors of serine proteases, termed **serpins** for *serine protease inhibitors*, have evolved. This family of inhibitors occurs in animals that have the proteases, but surprisingly these inhibitors are also found in plants that lack proteases.

Serine Proteases Have Similar Structure–Function Relationships

The complex relationships between structure and physiological function in the serine proteases require analysis of a number of observations. (1) Only one serine residue is catalytically active and participates in peptide bond hydrolysis. Bovine trypsin contains 34 serine residues with only one catalytically active or able to react with the inhibitor DFP (see Figure 3.11). (2) X-ray diffraction and amino acid sequence homology studies demonstrate that there are two residues, a histidine and an aspartate, that are always associated with the activated serine

TABLE 3.4 Some Human Proteins that Inhibit Serine Proteases

<i>Inhibitor</i>	<i>Action</i>
α_1 -Proteinase inhibitor	Inhibits tissue proteases including neutrophil elastase; deficiency leads to pulmonary emphysema
α_1 -Antichymotrypsin	Inhibits proteases of chymotrypsin-like specificity from neutrophils, basophils, and mast cells including cathepsin G and chymase
Inter- α -trypsin inhibitor	Inhibits broad range of serine protease activities in plasma
α_2 -Antiplasmin	Inhibits plasmin
Antithrombin III	Inhibits thrombin and other coagulation proteases
C_1 Inhibitor	Inhibits complement reaction
α_2 -Macroglobulin	General protease inhibitor
Protease nexin I	Inhibits thrombin, urokinase, and plasmin
Protease nexin II	Inhibits growth factor-associated serine proteases, identical to NH_2 -terminal domain of amyloid protein secreted in Alzheimer's disease
Plasminogen activator inhibitor I	Inhibits plasminogen activators
Plasminogen activator inhibitor II	Inhibits urokinase plasminogen activator

in the catalytic site. Based on their positions in chymotrypsinogen, these three invariant active site residues of serine proteases are named Ser 195, His 57, and Asp 102. This numbering, based on their sequence number in chymotrypsinogen, is used to identify these residues irrespective of their exact position in the primary structure of any serine protease. (3) Eukaryotic serine proteases exhibit a high sequence and structural similarity with each other. (4) Genes that code for serine proteases are organized similarly (Figure 3.16). In eukaryotic genes, exons are segments of the genomic DNA that are combined into the final messenger RNA that carries the information for the protein. The exons are separated by introns, which are spliced out of RNA and not present in the final messenger RNA (see p. 703). The **exon–intron patterns** of serine proteases show that each of the catalytically essential amino acid residues (Ser 195, His 57, and Asp 102) are on different exons. The catalytically essential histidine and serine are all almost adjacent to their exon boundary. The similarity in exon–intron organization exists for the serine protease family of enzymes among eukaryotic species. The cross-species homology in serine protease gene structure further supports the concept that the serine proteases evolved from a common primordial gene. (5) The catalytic unit of serine proteases exhibits two structural domains, of approximately equal size. The catalytic site is within the interface (crevice) between the two domains. (6) Serine proteases that function through direct interaction with membranes typically have an additional domain to provide this specific function. (7) Natural protein substrates and inhibitors of serine proteases bind through an extended specificity site. (8) Specificity for natural protein inhibitors is marked by extremely tight binding. The binding constant for trypsin to pancreatic trypsin inhibitor is on the order of 10^{13} M^{-1} , reflecting a binding free energy of approximately 18 kcal mol^{-1} . (9) Natural protein inhibitors are usually poor substrates with strong inhibition by the inhibitor requiring hydrolysis of a peptide bond in the inhibitor by the

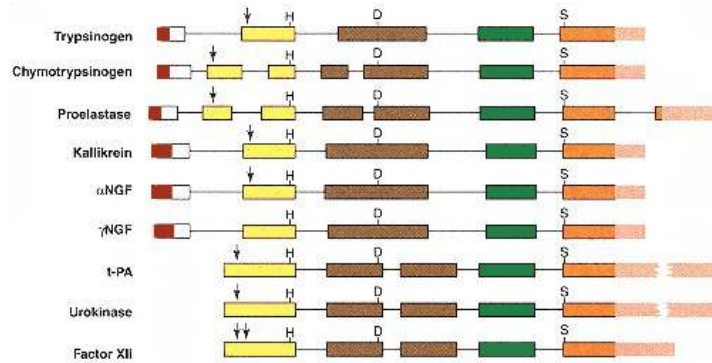

Figure 3.16

Organization of exons and introns in genes that code for serine proteases.

t-PA is tissue plasminogen activator and NGF is nerve growth factor. Exons are shown by boxes and introns by connecting lines. Position of the nucleotide codons for active-site serine, histidine, and aspartate are denoted by S, H, and D, respectively. Red boxes, on left, show regions that code for NH_2 -terminal part of polypeptide chain (signal peptide) cleaved before protein is secreted. Light-colored boxes, on right, represent part of gene sequence transcribed into messenger RNA (mRNA), but not translated into protein. Arrows show codons for residues at which proteolytic activation of zymogen forms occurs. Based on a figure in Irwin, D. M., Roberts, K. A., and MacGillivray, R. T. *J. Mol. Biol.* 20:31, 1988.

protease. (10) Serine proteases in eukaryotes are synthesized in zymogen forms to permit their production and transport in an inactive state to their sites of action. (11) Zymogen activation frequently involves hydrolysis by another serine protease. (12) Several serine proteases undergo **autolysis** or self-hydrolysis. Sometimes the self-reaction leads to specific peptide bond cleavage and activation of the catalytic activity. At other times autolysis leads to inactivation of the protease.

Amino Acid Sequence Homology occurs in the Serine Protease Family

Much of our early knowledge of the serine protease family came from trypsin and chymotrypsin purified from bovine materials obtained from a slaughter-house. This has yielded a useful but nonintuitive nomenclature, which uses a sequence alignment against the amino acid sequence of chymotrypsin, to name and number residues of other serine proteases. As mentioned previously, the catalytically essential residues are Ser 195, His 57, and Asp 102. Insertions and deletions of the amino acids in another serine protease are compared to the numbering of residues in chymotrypsin. Alignment is made by algorithms that maximize sequence homology, with exact alignment of the essential serine, histidine, and aspartate residues. These three residues are invariant in all serine proteases and the sequences surrounding them are invariant among the serine proteases of the chymotrypsin family (Table 3.5).

Members of the chymotrypsin family also occur in prokaryotes. Thus bacterial serine proteases from *Streptomyces griseus* and *Myxobacteria* 450 have a structural and functional homology with chymotrypsin. A separate class of serine protease enzymes has been isolated, however, from bacteria that has no structural homology to the mammalian chymotrypsin family. The serine protease subtilisin, isolated from *Bacillus subtilis*, hydrolyzes peptide bonds and contains an activated serine with a histidine and aspartate in its active site but the active

TABLE 3.5 Invariant Sequences Found Around the Catalytically Essential Serine (S) and Histidine (H)

Enzyme	Sequence (Identical Residues to Chymotrypsin Are in Bold)																									
	Residues Around Catalytically Essential Histidine																									
Chymotrypsin A	F	H	F	C	G	G	S	L	I	N	E	N	W	V	V	T	A	A	H	C	G	V	T	T	S	D
Trypsin	Y	H	F	C	G	G	S	L	I	N	S	Q	W	V	V	S	A	A	H	C	Y	K	S	G	I	Q
Pancreatic elastase	A	H	T	C	G	G	T	L	I	R	Q	N	W	V	M	T	A	A	H	C	V	D	R	E	L	T
Thrombin	E	L	L	C	G	A	S	L	I	S	D	R	W	V	L	T	A	A	H	C	L	L	Y	P	P	W
Factor X	E	G	F	C	G	G	T	I	L	N	E	F	Y	V	L	T	A	A	H	C	L	H	Q	A	K	R
Plasmin	M	H	F	C	G	G	T	L	I	S	P	E	W	V	L	T	A	A	H	C	L	E	K	S	P	R
Plasma kallikrein	S	F	Q	C	G	G	V	L	V	N	P	K	W	V	L	T	A	A	H	C	K	N	D	N	Y	E
<i>Streptomyces</i> trypsin	-	-	-	C	G	G	A	L	Y	A	Q	D	I	V	L	T	A	A	H	C	V	S	G	S	G	N
Subtilisin	V	G	G	A	S	F	V	A	G	E	A	Y	N	T	D	G	N	G	H	G	T	H	V	A	G	T
Residues Around Catalytically Essential Serine																										
Chymotrypsin A	C	A	G	-	-	-	A	S	G	V	-	-	S	S	C	M	G	D	S	G	G	P	L	V		
Trypsin	C	A	G	Y	-	-	L	E	G	G	K	-	D	S	C	Q	G	D	S	G	G	P	V	V		
Pancreatic elastase	C	A	G	-	-	-	G	N	G	V	R	-	S	G	C	Q	G	D	S	G	G	P	L	H		
Thrombin	C	A	G	Y	K	P	G	E	G	K	R	G	D	A	C	E	G	D	S	G	G	P	F	V		
Factor X	C	A	G	Y	-	-	D	T	Q	P	E	-	D	A	C	Q	G	D	S	G	G	P	H	V		
Plasmin	C	A	G	H	-	-	L	A	G	G	T	-	D	S	C	Q	G	D	S	G	G	P	L	V		
Pl. kallikrein	C	A	G	Y	-	-	L	P	G	G	K	-	D	T	C	M	G	D	S	G	G	P	L	I		
<i>Streptomyces</i> trypsin	C	A	G	Y	-	P	D	T	G	G	V	-	D	T	C	Q	G	D	S	G	G	P	M	F		
Subtilisin	A	G	V	Y	S	T	Y	P	T	N	T	Y	A	T	L	N	G	T	S	M	A	S	P	H		

Source: From Barrett, A. J. In: A. J. Barrett and G. Salvesen (Eds.), *Proteinase Inhibitors*. Amsterdam: Elsevier, 1986, p. 7.

site arises from structural regions of the protein that bear no sequence or structural homology with the chymotrypsin serine proteases. This serine protease is an example of **convergent evolution** of an enzyme catalytic mechanism. Apparently a gene completely different from those that code for chymotrypsin-like serine proteases evolved the same catalytic mechanism utilizing an active-site serine. The primary and tertiary structure, however, is different from that of the trypsin- and chymotrypsin-like structure.

Tertiary Structures of Serine Proteases Are Similar

Ser 195 in chymotrypsin reacts with diisopropylfluorophosphate (DFP), with a 1:1 enzyme : DFP stoichiometry, that inhibits the enzyme. The three-dimensional structure of chymotrypsin reveals that the Ser 195 is situated within an internal pocket, with access to the solvent interface. His 57 and Asp 102 are oriented so that they participate with the Ser 195 in the catalytic mechanism of the enzyme (see Chapter 4).

Structure determinations by X-ray crystallography have been carried out on many members of this class of proteins (Table 3.6). Structural data are available for catalytically active enzyme forms, zymogens, the same enzyme in multiple species, enzyme–inhibitor complexes, and a particular enzyme at different temperatures and in different solvents. The most complete analysis has been that of trypsin. Its X-ray diffraction analysis has yielded a three-dimensional structure at better than 1.7-Å resolution, which can resolve atoms at a separation of 1.3 Å such as the C=O separation of the carbonyl group (1.2 Å). This resolution, however, is not uniform over the entire trypsin structure. Different regions of the molecule have a variable tendency to be localized in space during the time course of the X-ray diffraction experiment, and for some atoms in the structure their exact position cannot be as precisely defined as for others. The structural disorder is especially apparent in surface residues not in contact with neighboring molecules. Rapid methods for X-ray data acquisition (see Chapter 2) further support this observation of dynamic fluctuation. Trypsin is globular in its overall shape and consists of two domains of approximately equal size (Figure 3.17), which do not penetrate one another. The secondary structure of trypsin has little α -helix, except in the COOH-terminal region of the molecule. The structure is predominantly β -structure, with each of the

TABLE 3.6 Serine Protease Structures Determined by X-Ray Crystallography

<i>Enzyme</i>	<i>Species Source</i>	<i>Inhibitors Present</i>	<i>Resolution (Å)</i>
Chymotrypsin ^a	Bovine	Yes ^b	1.67 ^c
Chymotrypsinogen	Bovine	No	2.5
Elastase	Porcine	Yes	2.5
Kallikrein	Porcine	Yes	2.05
Proteinase A	<i>S. griseus</i>	No	1.5
Proteinase B	<i>S. griseus</i>	Yes	1.8
Proteinase II	Rat	No	1.9
Trypsin ^a	Bovine	Yes ^b	1.4 ^c
Trypsinogen ^a	Bovine	Yes ^b	1.65 ^c

^a Structure of this enzyme molecule independently determined by two or more investigators.

^b Structure obtained with no inhibitor present (native structure) and with inhibitors. Inhibitors used include low molecular weight inhibitors (i.e., benzamidine, DFP, and tosyl) and protein inhibitors (i.e., bovine pancreatic trypsin inhibitor).

^c Highest resolution for this molecule of the multiple determinations.

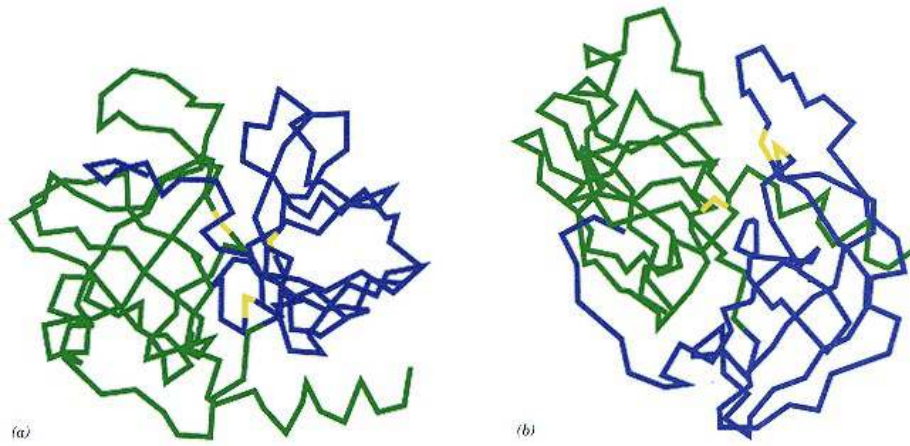

Figure 3.17
Two views of the structure of trypsin showing tertiary structure of two domains.
Active-site serine, histidine, and aspartate are indicated in yellow.

domains in a "deformed" β -barrel. Loop regions protrude from the barrel ends, being almost symmetrically presented by each of the two folded domains. These loop structures combine to form a surface region of the enzyme that extends outward, above the catalytic site. These loops have a structural and functional similarity to the CDRs of immunoglobulins.

Alignment of three-dimensional structures can be performed on serine proteases using a mathematical function that compares structural equivalence and allows for insertion and deletion of amino acids in a particular sequence. The data of Table 3.7 contrast the extent of structural superimposability with the homology of sequences brought into coincidence by the structural superposition. This table shows the total number of amino acids and the number that are statistically identical in each structure, by X-ray diffraction, in their topological position, even if they are chemically different amino acids. Topologically equivalent amino acids have the same relationship in three-dimensional space to the point where they cannot be distinguished from one another by X-ray diffraction. The last column presents the number of amino acids that are chemically identical. In these structural alignments the regions of greatest difference appear to be localized to the CDR-like loop regions, which extend from the β -barrel domains to form the surface region out from the catalytic site. The effect of

TABLE 3.7 Structural Superposition of Selected Serine Proteases and the Resultant Amino Acid Sequence Comparison

Comparison	Number of Amino Acids in Sequence		Number of Structurally Equivalent Residues	Number of Chemically Identical Residues
	Protease 1	Protease 2		
Trypsin-elastase	223	240	188	81
Trypsin-chymotrypsin	223	241	185	93
Trypsin-mast cell protease	223	224	188	69
Trypsin-prekallikrein	223	232	194	84
Trypsin- <i>S. griseus</i> protease	223	180	121	25

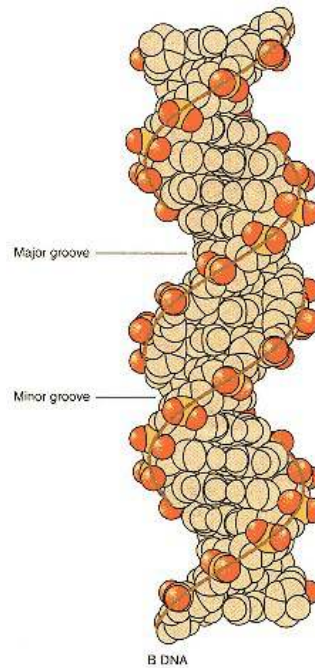

Figure 3.18
Space-filling model of DNA in
B conformation showing major and
minor grooves.

Reprinted with permission from
 Rich, A. J. *Biomol. Struct. Dyn.*
 1:1, 1983.

altering the amino acids in these loops is to alter the **macromolecular binding specificity** of the protease. It is the structure of the loop in factor Xa, for example, that allows it to specifically bind to prothrombin. Serpins interact with different proteases based on their affinity for the loop structures. Bacterial proteases related to the eukaryotic serine protease family contain the same two domains as do the eukaryotic family but lack most of the loop structures. This agrees with the lack of a requirement of bacterial proteases for complex interactions that the eukaryotic protease must carry out and the observation that bacterial proteases are not produced in a zymogen form.

Thus the serine protease family constitutes a structurally related series of proteins that use a catalytically active serine. During evolution, the basic two-domain structure and the catalytically essential residues have been maintained, but the region of the secondary interactions (loop regions) have changed to give the different proteins of the family their different specificities toward substrates, activators, and inhibitors, characteristic of their important physiological functions.

3.4— DNA-Binding Proteins

Regulatory sites exist in DNA that bind proteins that control gene expression. These sites contain a nucleotide sequence that binds regulatory proteins known as transcription factors. The specific DNA sequence, or **transcription factor binding element**, is usually less than 10 nucleotides long. Noncovalent interactions between the protein and DNA allow the protein to recognize the nucleotide sequence and bind to a specific regulatory site. This is a highly selective feat as the human genome has up to 100,000 genes, each with its own regulatory sequences. While there are huge gaps in our knowledge of how proteins regulate gene expression, some common structural motifs of DNA-binding proteins are apparent.

Three Major Structural Motifs of DNA-Binding Proteins

Along the helical spiral of a DNA molecule in its most common form (B form) are two grooves, the major and minor grooves (Figure 3.18) (see Chapter 14) to which the proteins must associate. A structural motif found in many DNA-binding proteins is the **helix–turn–helix (HTH)**. An HTH places one of its α -helices, designated the **recognition helix**, across the major groove where side chain residues of the helix form specific noncovalent interactions with the base sequence of the target DNA. The interaction appears to induce distortions in conformation of the B-DNA binding site that better accommodate the interactions with protein. Nonspecific interactions are made between the protein and sugar–phosphate backbone of DNA. HTH proteins bind as dimers; thus there are two helix–turn–helix motifs per active regulatory protein. X-ray structures show the two helix–turn–helix motifs protruding from the structure of each monomer domain binding at two adjacent turns of the major groove in the DNA, making a strong protein–DNA interaction (Figures 3.19–3.21).

The **zinc-finger** motif is another structure found in some DNA-binding proteins. Zinc-finger proteins contain repeating motifs of a Zn^{2+} atom bonded to two cysteine and two histidine side chains (Figure 3.22). In some cases the histidines may be substituted by cysteines. The primary structure for the motif contains two close cysteines separated by about 12 amino acids from a second pair of Zn^{2+} liganding amino acids (histidine or cysteine). The three-dimensional structure of one zinc finger has been deduced by 1H -NMR (Figure 3.23). The motif contains an α -helix segment that can bind within the major groove at its target site in DNA and makes specific interactions with the nucleotide base sequence.

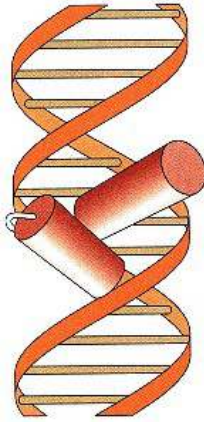

Figure 3.19
Binding of a helix–turn–helix motif into the major groove of B-DNA.
 The recognition helix lies across the major groove.
 Redrawn from Schleif, R. *Science* 241: 241, 1988.

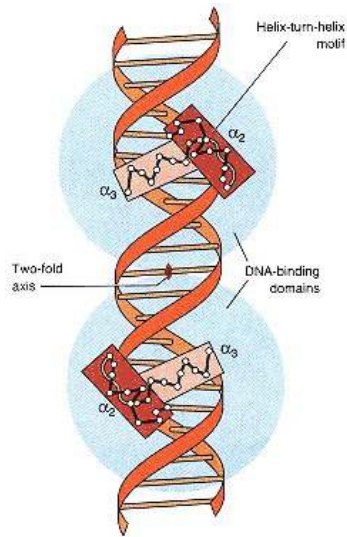

Figure 3.20
Association of a DNA-binding protein (dimer) with two helix–turn–helix motifs into adjacent major grooves of B-DNA.
 Redrawn from Brennan, R. G., and Matthews, B. W. *Trends Biochem. Sci.* 14:287, 1989 (Fig. 1b).

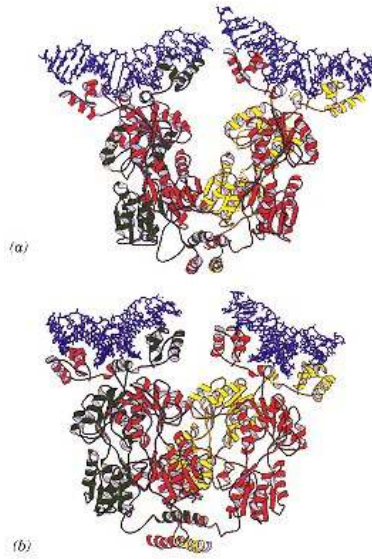

Figure 3.21
X-ray crystallographic structure of helix–turn–helix motif *lac* repressor protein in association with target DNA.
 (a) Repressor is a tetramer protein with individual monomers colored green and violet (left), red and yellow (right). The DNA targets are colored blue (top). Recognition helices from dimer of tetramer are shown to interact in adjacent major grooves of target DNAs. Each dimer in tetramer interacts with a discrete (separated) target consensus sequence present in DNA.
 (b) A different view of the same tetramer.
 Reprinted with permission from Lewis, M., Chang, G., Horton, N. C., Kercher, M. A., Pace, H. C., Schumacher, M. A., Brennan, R. G., and Lu, P. *Science* 271:1247, 1996.
 Copyright 1996 American Association for the Advancement of Science.

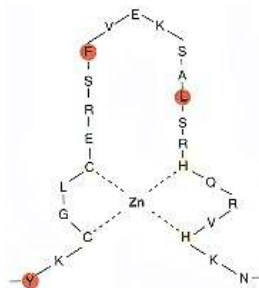

Figure 3.22
Primary sequence of a zinc-finger motif found in DNA-binding protein Xfin from *Xenopus*.
 Invariant and highly conserved amino acids in structure are circled in dark red.
 Redrawn from Lee, M. S., Gippert, G. P., Soman, K. V., Case, D. A., and Wright, P. E. *Science* 245:635, 1989.

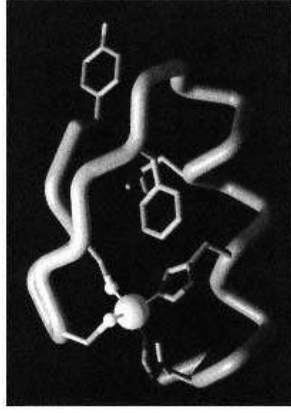

Figure 3.23
Three-dimensional structure obtained by $^1\text{H-NMR}$ of zinc-finger motif from *Xenopus* protein Xfin (sequence shown in Figure 3.22).

Superposition of 37 possible structures derived from calculations based on the $^1\text{H-NMR}$. NH_2 terminal is at upper left and COOH terminal is at bottom right. Zinc is sphere at the bottom with Cys residues to the left and His residues to the right.

Photograph provided by Michael Pique, and Peter E. Wright, Department of Molecular Biology, Research Institute of Scripps Clinic, La Jolla, California.

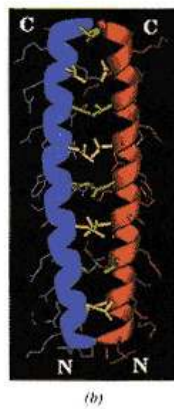
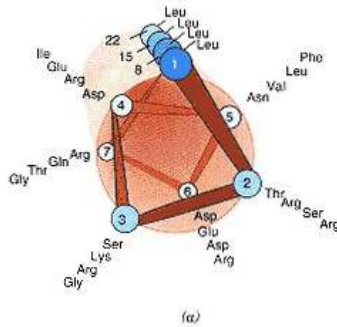

Figure 3.24
Leucine zipper motif of DNA-binding proteins.

(a) Helical wheel analysis of the leucine-zipper motif in DNA enhancer-binding protein. The amino acid sequence in the wheel analysis is displayed end-to-end down the axis of a schematic α -helix structure.

The leucines (Leu) are observed in alignment along one edge of the helix (residues 1, 8, 15, and 22 in the sequence).

(b) The X-ray structure, in side view, in which the helices are presented in ribbon form and side chains in stick form. Contacting leucine residues in yellow and green.

(a) Redrawn from Landschulz, W. H., Johnson, P. F., and McKnight, S. L. *Science* 240:1759, 1988.

(b) Figure reproduced with permission from D. Voet and J. Voet, *Biochemistry, 2nd ed.* New York: Wiley, 1995 and based on an X-ray structure by Peter Kim, MIT, and Tom Alber, University of Utah School of Medicine.

A third structural motif found in some of the DNA-binding proteins is the **leucine zipper**. Leucine zippers are formed from a region of α -helix that contain at least four leucines, each leucine separated by six amino acids from one another (i.e., $\text{Leu-X}_6\text{-Leu-X}_6\text{-Leu-X}_6\text{-Leu}$, where X is any common amino acid). With 3.6 residues per turn of the α -helix, the leucines align on one edge of the helix, with a leucine at every second turn of the helix (Figure 3.24). The leucine-rich helix forms a hydrophobic interaction with a second leucine helix on another polypeptide chain subunit, to "zipper" the two subunits together to form a dimer (Figure 3.25). The leucine-zipper motif does not directly interact with the DNA, as do the zinc-finger or helix-turn-helix motifs. Mutations in the zipper motif show that if the dimer is not formed by association of the monomers through the zipper, the protein will not bind to DNA strongly. However, just adjacent to the α -helix of the zipper motif in the primary structures

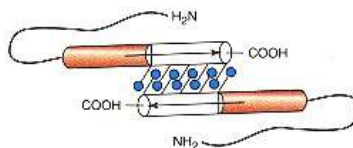

Figure 3.25
Schematic diagram of two proteins with leucine zippers in antiparallel association.

DNA-binding domains containing a high content of basic amino acids (arginines and lysines) are shown in pink. Redrawn from Landschulz, W. H., Johnson, P. F., and McKnight, S. L. *Science* 240:1759, 1988.

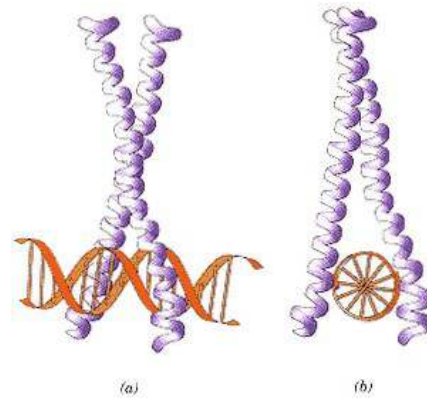

Figure 3.26

Structure of the bZIP GCN4–DNA complex.

(a) bZIP protein is a dimer (polypeptide chains colored blue) with each monomer joined by a leucine-zipper motif. NH_2 termini diverge to allow the basic region of the sequence to interact in the major groove of DNA target site (DNA colored red).

(b) Same interaction viewed down the DNA axis.

From Ellenberger, T. E., Brandl, C. J., Struhl, K., and Harrison, S. C. *Cell* 71:1223, 1992.

there is a sequence containing a high concentration of basic amino acids, arginine and lysine. This evolutionary conserved basic region interacts with the DNA. The positive charges of the arginine and lysine side chains are drawn to the negatively charged DNA phosphate groups.

The yeast transcription factor GCN4 is one eukaryotic DNA-binding protein that contains the leucine-zipper (bZIP) motif. It is a dimer of two continuous α -helical subunits joined by a leucine-zipper interface. The α -helices cross at this interface and then diverge with their two N-terminal ends separated to pass directly through different sides of the same major groove of the DNA target site (Figure 3.26). Amazingly, there are no bends or kinks in the linear helical structure of each subunit of the dimer. As discussed above, the DNA contact regions contain many positively charged amino acid residues that interact with negatively charged phosphate groups in the DNA.

Many regulatory proteins with the leucine-zipper motif have been shown to be oncogene products (Myc, Jun, and Fos). Fos forms a heterodimer with Jun through a leucine-zipper interaction, and the Fos/Jun dimers bind to gene regulatory sites. If these regulatory proteins are mutated or produced in an unregulated manner, the cell can be transformed to a cancer cell.

DNA-Binding Proteins Utilize a Variety of Strategies for Interaction with DNA

The helix–loop–helix motif was the first motif to be identified for interaction with DNA. X-ray structural studies of protein–DNA complexes show a great variety of other mechanisms for protein–DNA association. The TATA box-binding protein (TBP) associates with the TATA sequence of gene promoters. Association of TBP with the TATA sequence forms the foundation for a large protein complex that initiates gene transcription by RNA polymerase. The X-ray structure of the C-terminal domain of the TBP bound to a TATA sequence shows that TBP contains two domains, each composed of a curved antiparallel β -sheet with a concave surface. The two-domain structure forms the shape of a "saddle" that sits over the DNA double helix. The concave surface of the "saddle" distorts the B-DNA structure and partially unwinds the DNA helix. This distortion, in turn, produces a wide open, though shallow, minor groove that interacts extensively with the under portion of the TBP saddle (Figure 3.27a). One critical protein that forms a part of the initiation complex for RNA transcription is TFIIB. An X-ray structure shows TFIIB associates with one of the "stirrups" of the TBP "saddle" in the TATA sequence complex (Figure 3.27b).

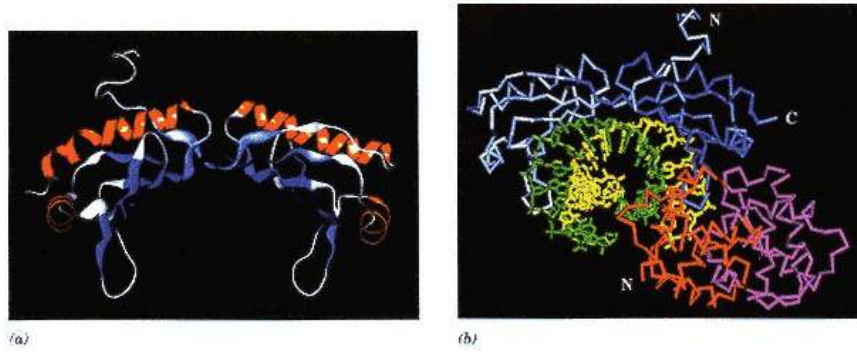

Figure 3.27

Structures of TBP–DNA binary and TBP–TFIIB–DNA ternary complexes.

- (a) Computer model generated from X-ray structure of TBP interaction with DNA; α -strands are shown in red and blue, respectively, with the remainder in white,
 (b) TBP–TFIIB–DNA complex. Proteins are depicted as α -carbon traces while the DNA is shown as an atomic stick model. TFIIB first repeat is colored red and the second repeat magenta. One domain of TBP is light blue while the second is dark blue. DNA-coding strand is colored green and noncoding strand is in yellow. N and C termini of TBP and TFIIB are labeled when visible.

Courtesy of S. K. Burley.

Reprinted with permission from (a) Nikolov, D. B., Hu, S.-H., Lin, J., Gasch, A., Hoffmann, A., Horikoshi, M., Chua, N.-H., Roeder, R. G., and Burley, S. K. *Nature* 360:40, 1992; and (b) Nikolov, D. B., Chen, H., Halay, E. D., Usheva, A. A., Hisatake, K., Lee, D. K., Roeder, R. G., and Burley, S. K. *Nature* 377:119, 1995.
 Copyright 1992 and 1995 Macmillan Magazines Limited.

The p53 protein is a transcription factor that, on sensing damaged DNA, upregulates the expression of genes that inhibit cell division, giving the cell time to repair the damaged DNA. Alternatively, it can instruct the cell to undergo apoptosis (programmed cell death) if the DNA damage is too extensive for repair. This transcription factor is a key tumor suppressor protein and mutant forms of p53 are found in the majority of human cancers. The DNA-binding domain of p53 consists of two sheets of antiparallel β -strands like an immunoglobulin fold. This central fold provides the scaffolding for the **loop–sheet–helix motif** and for the two large loops (15 and 32 residues) that interact with the DNA. The α -helix (designated H2) of the loop–sheet–helix motif fits into a major groove with loop 1 (L1), while loop 3 (L3) interacts strongly with the adjacent minor groove (Figure 3.28a). Figure 3.28b shows the side chains of the amino acids commonly found mutated in human cancers. Many mutations are in residues that interact directly with the DNA, such as Arg 248, which is a part of loop 3. Other common mutations are in residues within the domain core required for protein stability, p53 binds as a tetramer to DNA (Figure 3.28c).

NF- κ B transcription factors are ubiquitous transcription factors of the Rel family. They regulate a variety of genes, especially genes with roles in cellular defense mechanisms against infection and in differentiation. The NF- κ B p50 protein has two domains interconnected by a 10 amino acid linker region (Figure 3.29a). Each domain contains a β -barrel core with antiparallel strands that have structural homology to the immunoglobulin fold motif. The C-terminal domains provide the dimer interface, in which one surface of each immunoglobulin fold pack together to form the subunit interface. Both N-terminal and C-terminal domains, as well as the loop that connects them, bind to the DNA surface, contributing 10 loops (5 from each subunit in the dimer) that fill the entire major groove in the target DNA (Figure 3.29). N-terminal domains also have an α -helical segment that forms a strong interaction in the minor groove near the center of the target element. In contrast to many other DNA-binding proteins, the NF- κ B p50 dimer does not make contact with two separated sites

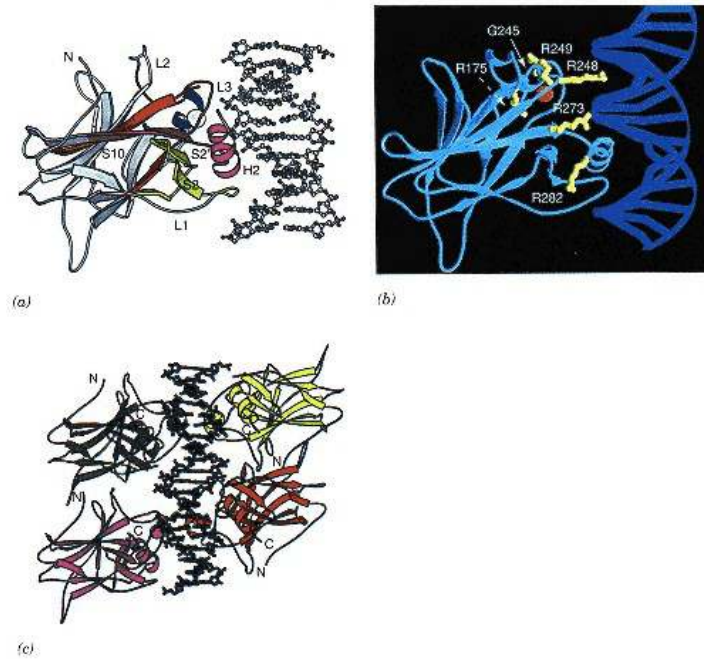

Figure 3.28

Structure of p53-DNA complex.

- (a) Structure of p53 core domain complexed with DNA. α -Strands (S), α -helices (H), loops (L), and zinc atom (sphere) are lettered and numbered. Helix (H2), loop 1 (L1), and loop 3 (L3) associate in major and minor grooves of target DNA.
 - (b) Frequently mutated amino acid side chains commonly found in human cancers are colored yellow. Zinc atom is colored red.
 - (c) Structure of tetramer p53 in association with DNA. Each monomer of tetramer binds to a discrete consensus binding site in the target DNA. Four core domains of the tetramer are colored green, purple, yellow, and red-brown, and DNA is colored blue.
- Reprinted with permission from Cho, Y., Gorina, S., Jeffrey, P. D., and Pavletich, N. P. *Science* 265:346, 1994.
Copyright 1994 American Association for the Advancement of Science.

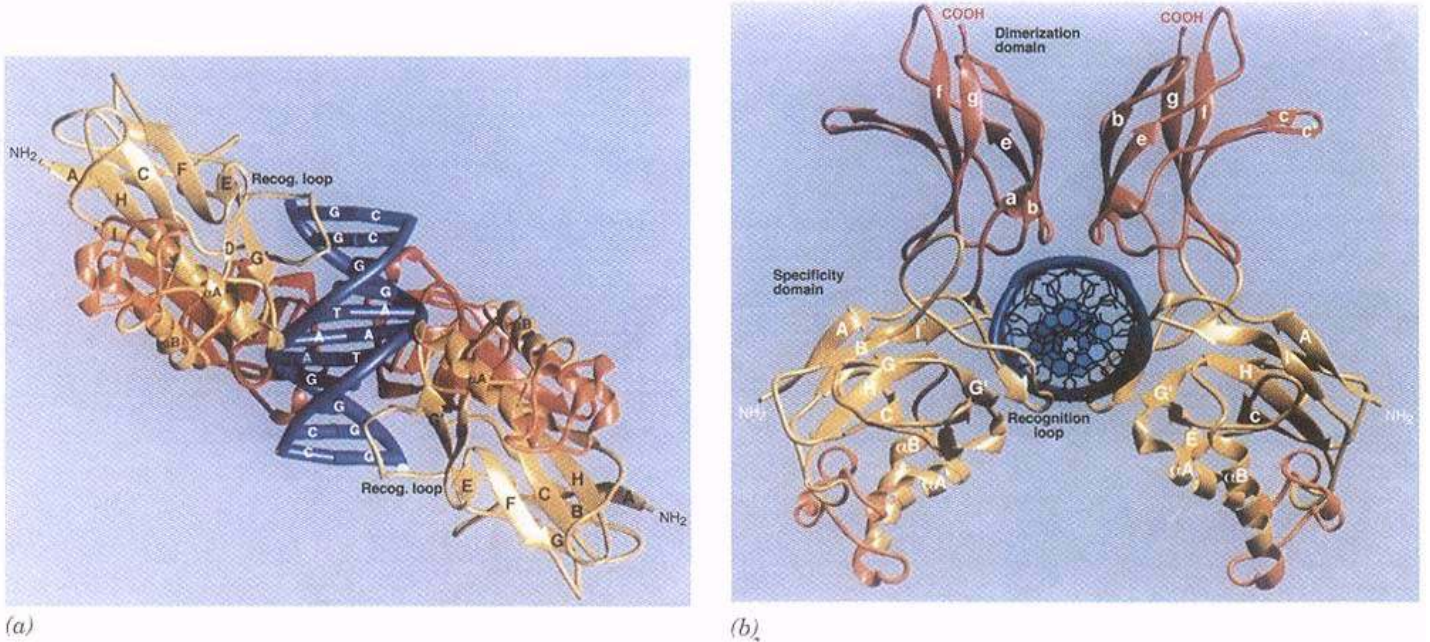

Figure 3.29

Structure of the NF- κ B p50 homodimer to DNA.

- Only residues 43 through 352 of both subunits are shown in structures. NF- κ B p50 protein binds as a dimer. In each monomer, the N-terminal domain is colored yellow and the C-terminal domain is colored red-brown. Orange insert in N-terminal domain is a region unique to p50 and not present in other structures of Rel family of transcription factors.
- (a) View along DNA axis.
 - (b) Alternative view of same complex.
- Reprinted with permission from Müller, C. W., Rey, F. A., Sodeoka, M., Verdine, G. L., and Harrison, S. C. *Nature* 373:311, 1995.
Copyright 1995 Macmillan Magazines Limited.

on the DNA target. Rather, the contacts from one monomer combine with those of the second monomer to form a continuous interaction through the single binding site in the DNA.

3.5—

Hemoglobin and Myoglobin

Hemoglobins are globular proteins, present in high concentrations in red blood cells, that bind oxygen in the lungs and transport the oxygen in blood to tissues and cells around the capillary beds of the vascular system. Hemoglobins also transport carbon dioxide and protons from the tissues to the lungs. Hemoglobins carry and release nitric oxide (NO), a potent vasodilator and inhibitor of platelet aggregation (see p. 995). In this section the structural and molecular aspects of hemoglobin and myoglobin are described. The physiological roles of these proteins are discussed in Chapter 25.

Human Hemoglobin Occurs in Several Forms

A hemoglobin molecule consists of four polypeptide chains, two each of two different amino acid sequences. The major form of human adult hemoglobin, **HbA₁**, consists of two α chains and two β chains ($\alpha_2\beta_2$). The α polypeptide has 141 and the β polypeptide has 146 amino acids. Other forms of hemoglobin predominate in the blood of the human fetus and early embryo (Figure 3.30). The fetal form (**HbF**) contains the same α chains found in HbA₁, but a second type of chain (γ chain) occurs in the tetramer molecule and differs in amino acid sequence from that of the β chain of adult HbA₁ (Table 3.8). Additional forms appear in the first months after conception (embryonic) in which the α chains are substituted by *zeta* (ζ) chains of different amino acid sequence and the ϵ chains serve as the β chains. A minor form of adult hemoglobin, HbA₂, comprises about 2% of normal adult hemoglobin and contains two α chains and two chains designated delta (δ) (Table 3.8).

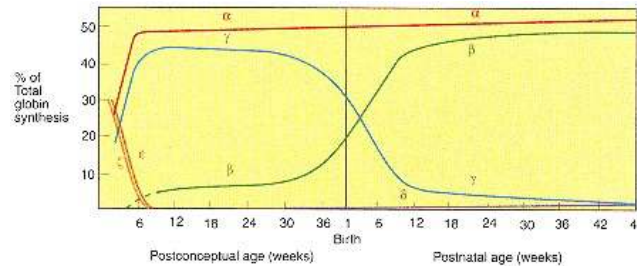

Figure 3.30

Changes in globin chain production during development.

Based on a figure in Nienhuis, A. W. and Maniatis, T. In: G. Stamatoyannopoulos, A. W. Nienhuis, P. Leder, and P. W. Majerus (Eds), *The Molecular Basis of Blood Diseases*. Philadelphia: Saunders, 1987, p. 68, in which reference of Weatherall, D. J., and Clegg, J. B., *The Thalassemia Syndromes*, 3rd ed. Oxford: Blackwell Scientific Publications, 1981, is acknowledged.

TABLE 3.8 Chains of Human Hemoglobin

Developmental Stage	Symbol	Chain Designations
Adult	HbA ₁	$\alpha_2\beta_2$
Adult	HbA ₂	$\alpha_2\delta_2$
Fetus	HbF	$\alpha_2\gamma_2$
Embryo	Hb Gower-1	$\zeta_2\epsilon_2$
Embryo	Hb Portland	$\zeta_2\gamma_2$

Myoglobin:**A Single Polypeptide Chain with One O₂-Binding Site**

Myoglobin (Mb) is an O₂-carrying protein that binds and releases O₂ with changes in the oxygen concentration in the sarcoplasm of skeletal muscle cells. In contrast to hemoglobin, which has four polypeptide chains and four O₂-binding sites, myoglobin contains only a single polypeptide chain and one O₂-binding site. Myoglobin is a model for what occurs when a single protomer molecule acts alone without the interactions exhibited among the four O₂-binding sites in the more complex tetramer molecule of hemoglobin.

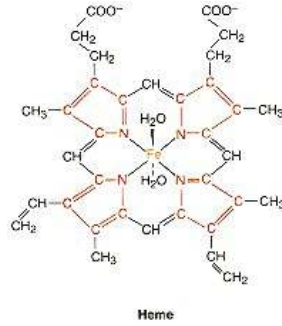

Figure 3.31
Structure of heme.

A Heme Prosthetic Group Is at the Site of O₂ Binding

The four polypeptides of globin subunits in hemoglobin and the one of myoglobin each contain a heme prosthetic group. A **prosthetic group** is a nonpolypeptide moiety that forms a functional part of a protein. Without its prosthetic group, a protein is designated an **apoprotein**. With its prosthetic group it is a **holoprotein**.

Heme contains protoporphyrin IX (see Chapter 24) with an iron atom in its center (Figure 3.31). The iron atom is in the ferrous (2+ charge) oxidation state in functional hemoglobin and myoglobin. The ferrous atom in the heme can form five or six ligand bonds, depending on whether or not O₂ is bound to the molecule. Four bonds are to the pyrrole nitrogen atoms of the porphyrin. Since all pyrrole rings of porphyrin lie in a common plane, the four ligand bonds from the porphyrin to the iron atom will have a tendency to lie in the plane of the porphyrin ring. The fifth and the potentially sixth ligand bonds to the ferrous atom are directed along an axis perpendicular to the plane of the porphyrin ring (Figure 3.32). The fifth coordinate bond of the ferrous atom is to a nitrogen of a histidine imidazole. This is designated the **proximal histidine** in hemoglobin and myoglobin structures (Figures 3.32 and 3.33). O₂ forms a sixth coordinate bond to the ferrous atom when bound to hemoglobin. In this bonded position the O₂ is placed between the ferrous atom to which it is liganded and a second histidine imidazole, designated the **distal histidine**. In deoxyhemoglobin, the sixth coordination position of the ferrous atom is unoccupied.

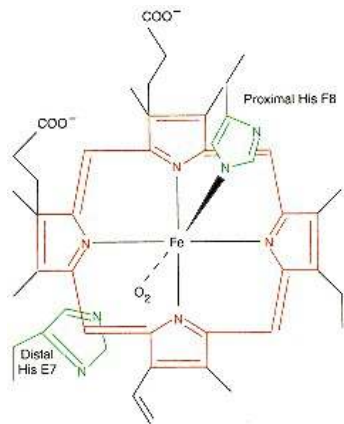

Figure 3.32
Ligand bonds to ferrous atom in oxyhemoglobin.

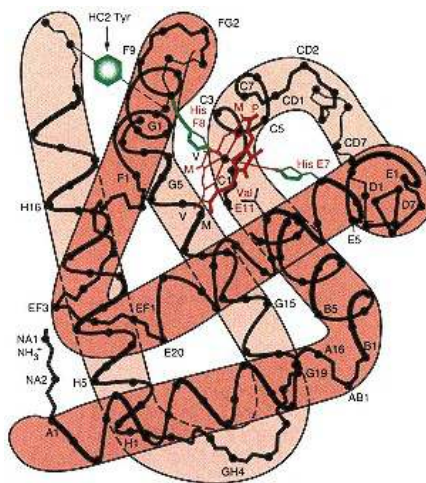

Figure 3.33
Secondary and tertiary structure characteristics of chains of hemoglobin.
Proximal His F8, distal His E7, and Val E11 side chains are shown. Other amino acids of polypeptide chain are represented by -carbon positions only; the letters M, V, and P refer to the methyl, vinyl, and propionate side chains of the heme.
Reprinted with permission from Perutz, M. *Br. Med. Bull.* 32: 195, 1976.

The porphyrin part of the heme is positioned within a hydrophobic pocket of each globin subunit. In the heme pocket X-ray diffraction studies show that approximately 80 interactions are provided by approximately 18 residues to the heme. Most of these noncovalent interactions are between apolar side chains of amino acids and the apolar regions of the porphyrin. As discussed in Chapter 2, the driving force for these interactions is the expulsion of water of solvation on association of the hydrophobic heme with the apolar amino acid side chains in the heme pocket. In myoglobin additional noncovalent interactions are made between the negatively charged propionate groups of the heme and positively charged arginine and histidine side chains of the protein. However, in hemoglobin chains a difference in the amino acid sequence in this region of the heme-binding site leads to stabilization of the porphyrin propionates by interaction with an uncharged histidine imidazole and with water molecules of solvent toward the outer surface of the molecule.

X-Ray Crystallography Has Assisted in Defining the Structure of Hemoglobin and Myoglobin

The structure of deoxy and oxy forms of hemoglobin and myoglobin have been resolved by X-ray crystallography. In fact, sperm whale myoglobin was the first globular protein whose full three-dimensional structure was determined by this technique. This was followed by the X-ray structure of the more complex horse hemoglobin molecule. These structures show that each globin polypeptide in the hemoglobins and the single subunit of myoglobin are composed of multiple α -helical regions connected by turns of the polypeptide chain that allow the protein to fold into a spheroidal shape (Figure 3.33). The mechanism of cooperative associations of O_2 , discussed below, is based on the X-ray structures of oxyhemoglobin, deoxyhemoglobin, and a variety of hemoglobin derivatives.

Primary, Secondary, and Tertiary Structures of Myoglobin and the Individual Hemoglobin Chains

The amino acid sequences of the polypeptide chain of myoglobin of 23 different animal species have been determined. All myoglobins contain 153 amino acids in their polypeptide chains, of which 83 are invariant. Only 15 of these invariant residues in the myoglobin sequence are identical to the invariant residues of the sequenced mammalian globins of hemoglobin. However, the changes are, in the great majority of cases, conservative and preserve the general physical properties of the residues (Table 3.9). Since myoglobin is active as a monomer, many of its surface positions interact with water and prevent another molecule of myoglobin from associating. In contrast, surface residues of the individual subunits in hemoglobin are designed to provide hydrogen bonds and nonpolar contacts with other subunits in the hemoglobin quaternary structure. Proximal and distal histidines are preserved in the sequences of all the polypeptide chains. Other invariant residues are in the hydrophobic heme pocket and form essential nonpolar contacts with the heme that stabilize the heme–protein complex.

While there is surprising variability in amino acid sequences among the different polypeptide chains, to a first approximation the secondary and tertiary structures of each of the subunits of hemoglobin and myoglobin are almost identical (Figure 3.34). Significant differences in physiological properties between α , β , γ , and δ chains of hemoglobins and the polypeptide chain of myoglobin are due to rather small specific changes in their structures. The similarity in tertiary structure, resulting from widely varied amino acid sequences, shows that the same tertiary structure for a protein can be arrived at by many different sequences.

TABLE 3.9 Amino Acid Sequences of Human Hemoglobin Chains and of Sperm Whale Myoglobin*

Table with 6 columns (NA, 1-6) and 15 rows (MYOGLOBIN, HEMOGLOBIN alpha, HEMOGLOBIN beta, HEMOGLOBIN gamma, HEMOGLOBIN delta, HEMOGLOBIN epsilon). Each cell contains an amino acid code (e.g., Val, Leu, Ser, Ala, etc.).

*Source: Based on diagram in Dickerson, R. E., and Geis, I. The Structure and Function of Proteins. New York: Harper & Row, 1969, p. 52. *Residues that are identical are enclosed in box. A, B, C, ... designate different helices of tertiary structure (see text).

Approximately 70% of the residues participate in the alpha-helical secondary structures generating seven helical segments in the alpha chain and eight in the beta chain. These latter eight helical regions are commonly lettered A-H, starting from the first (A) helix at the NH2-terminal end. The interhelical regions are designated as AB, BC, CD, . . . , GH, respectively. The nonhelical region between the NH2-terminal end and the A helix is designated the NA region; and the region between the COOH-terminal end and the H helix is designated the HC region (Figure 3.33). This naming system allows discussion of particular residues that have similar functional and structural roles in hemoglobin and myoglobin.

A Simple Equilibrium Defines O2 Binding to Myoglobin

The association of oxygen to myoglobin is characterized by a simple equilibrium constant (Eqs. 3.1 and 3.2) In Eq. 3.2 [MbO2] is the solution concentration of oxy myoglobin, [Mb] is that of deoxy myoglobin, and [O2] is the concentration

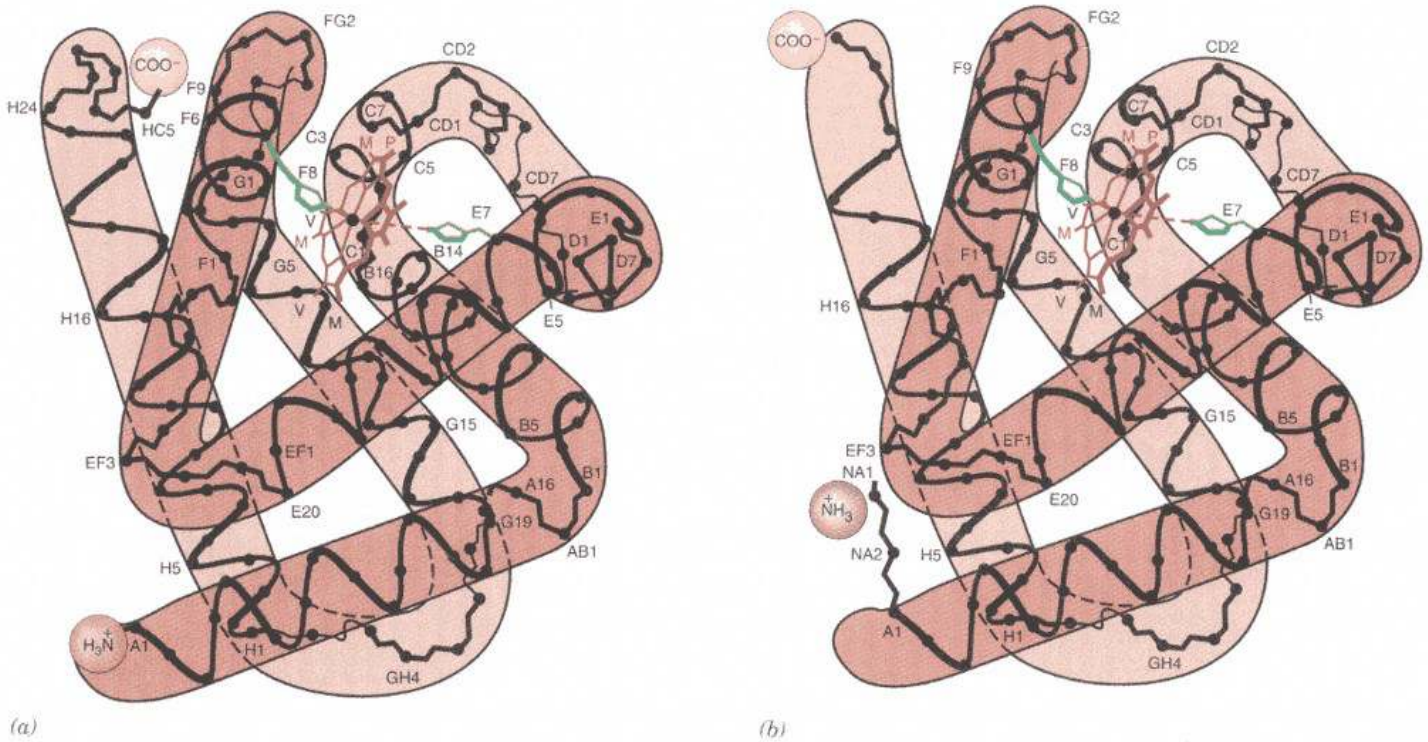

Figure 3.34
Comparison of conformation of
(a) myoglobin and
(b) β chain of HbA₁.

Overall structures are very similar, except at NH₂-terminal and COOH-terminal ends.
 Reprinted with permission from Fersht,
 A. *Enzyme Structure and Mechanism*. San Francisco: Freeman, 1977, pp. 12, 13.

of oxygen, in moles per liter. The equilibrium constant, K_{eq} , will also have the units of moles per liter. As for any true equilibrium constant, the value of K_{eq} is dependent on pH, ionic strength, and temperature.



$$K_{eq} = \frac{[\text{Mb}][\text{O}_2]}{[\text{MbO}_2]} \quad (3.2)$$

Since oxygen is a gas, it is more convenient to express its concentration as the pressure of oxygen in torr (1 torr is equal to the pressure of 1 mmHg at 0°C and standard gravity). In Eq. 3.3 this conversion of units has been made: P_{50} , the equilibrium constant, and $p\text{O}_2$, the concentration of oxygen, being expressed in torr.

$$P_{50} = \frac{[\text{Mb}] \cdot p\text{O}_2}{[\text{MbO}_2]} \quad (3.3)$$

An oxygen-saturation curve characterizes the properties of an oxygen-binding protein. In this plot the fraction of oxygen-binding sites in solution that contain oxygen (Y , Eq. 3.4) is plotted on the ordinate *versus* $p\text{O}_2$ (oxygen concentration) on the abscissa. The Y value is simply defined for myoglobin by Eq. 3.5. Substitution into Eq. 3.5 of the value of $[\text{MbO}_2]$ obtained from Eq. 3.3, and then dividing through by $[\text{Mb}]$, results in Eq. 3.6, which shows the dependence of Y on the value of the equilibrium constant P_{50} and the oxygen concentration. It is seen from Eqs. 3.3 and 3.6 that the value of P_{50} is equal to the oxygen concentration, $p\text{O}_2$, when $Y = 0.5$ (50% of the available sites occupied)—hence the designation of the equilibrium constant by the subscript 50.

$$Y = \frac{\text{number of binding sites occupied}}{\text{total number of binding sites in solution}} \quad (3.4)$$

$$Y = \frac{[\text{MbO}_2]}{[\text{Mb}] + [\text{MbO}_2]} \quad (3.5)$$

$$Y = \frac{p\text{O}_2}{P_{50} + p\text{O}_2} \quad (3.6)$$

A plot of Eq. 3.6 of Y versus $p\text{O}_2$ generates an oxygen-saturation curve for myoglobin in the form of a rectangular hyperbola (Figure 3.35).

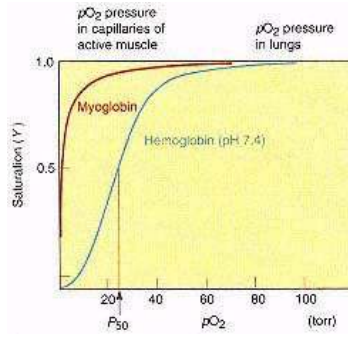

Figure 3.35
Oxygen-binding curves for myoglobin and hemoglobin.

A simple algebraic manipulation of Eq. 3.6 leads to Eq. 3.7. Taking the logarithm of both sides of Eq. 3.7 results in Eq. 3.8, the Hill equation. A plot of $\log \left[\frac{Y}{1-Y} \right]$ versus $\log p\text{O}_2$, according to Eq. 3.8, yields a straight line with a slope equal to 1 for myoglobin (Figure 3.36). This is the Hill plot, and the slope (n_H) is the Hill coefficient (see Eq. 3.9).

$$\frac{Y}{1-Y} = \frac{p\text{O}_2}{P_{50}} \quad (3.7)$$

$$\log \frac{Y}{1-Y} = \log p\text{O}_2 - \log P_{50} \quad (3.8)$$

Binding of O_2 to Hemoglobin Involves Cooperativity between the Hemoglobin Subunits

Whereas myoglobin has a single O_2 -binding site per molecule, hemoglobins, with four monomeric subunits, have four heme-binding sites for O_2 . Binding of the four O_2 molecules in hemoglobin is found to be **positively cooperative**, so that the binding of the first O_2 to deoxyhemoglobin facilitates the binding of O_2 to the other subunits in the molecule. Conversely, dissociation of the first O_2 from fully oxygenated hemoglobin, $\text{Hb}(\text{O}_2)_4$, will make the dissociation of O_2 from the other subunits of the tetramer easier.

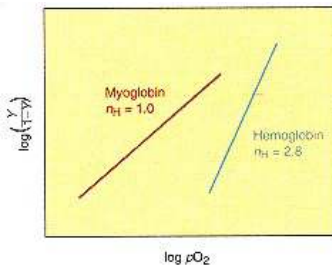

Figure 3.36
Hill plots for myoglobin and hemoglobin HbA₁.

Because of cooperativity in oxygen association and dissociation, the oxygen saturation curve for hemoglobin differs from that for myoglobin. A plot of Y versus $p\text{O}_2$ for hemoglobin is a sigmoidal line, indicating cooperativity in oxygen association (Figure 3.35). A plot of the Hill equation (Eq. 3.9) gives a value of the slope (n_H) equal to 2.8 (Figure 3.36).

$$\log \frac{Y}{1-Y} = n_H \log p\text{O}_2 - \text{constant} \quad (3.9)$$

The meaning of the Hill coefficient to cooperative O_2 association can be evaluated quantitatively as presented in Table 3.10. A parameter known as the cooperativity index, R_x , is calculated, which shows the ratio of $p\text{O}_2$ required to change Y from a value of $Y = 0.1$ (10% of sites filled) to a value of $Y = 0.9$ (90% of sites filled) for designated Hill coefficient values found experimentally. For myoglobin, $n_H = 1$, and an 81-fold change in oxygen concentration is required to change from $Y = 0.1$ to $Y = 0.9$. For hemoglobin, where positive cooperativity is observed, $n_H = 2.8$ and only a 4.8-fold change in oxygen concentration is required to change the fractional saturation from 0.1 to 0.9.

The Molecular Mechanism of Cooperativity in O_2 Binding

X-ray diffraction data on deoxyhemoglobin show that the ferrous atoms actually sit out of the plane of their porphyrins by about 0.4–0.6 Å. This is thought to occur because of two factors. The electronic configuration of the five-coordinated ferrous atom in deoxyhemoglobin has a slightly larger radius than the distance from the center of the porphyrin to each of the pyrrole nitrogen atoms.

TABLE 3.10 Relationship Between Hill Coefficient (n_H) and Cooperativity Index (R_x)

n_H	R_x	Observation
0.5	6560	} Negative substrate cooperativity
0.6	1520	
0.7	533	
0.8	243	
0.9	132	
1.0	81.0	Noncooperativity
1.5	18.7	} Positive substrate cooperativity
2.0	9.0	
2.8	4.8	
3.5	3.5	
6.0	2.1	
10.0	1.6	
20.0	1.3	

Source: Based on Table 7.1 in Cornish-Bowden, A. *Principles of Enzyme Kinetics*. London: Butterworths Scientific Publishers, 1976.

Accordingly, the iron can be placed in the center of the porphyrin only with some distortion of the porphyrin conformation. Probably a more important consideration is that if the iron atom sits in the plane of the porphyrin, the proximal His F8 imidazole will interact unfavorably with atoms of the porphyrin. The strength of this unfavorable steric interaction is due, in part, to conformational constraints on the His F8 and the porphyrin in the deoxyhemoglobin conformation that forces the approach of the His F8 toward the porphyrin to a particular path (Figure 3.37). These constraints become less significant in the oxy conformation of hemoglobin.

The conformation with the iron atom out of the plane of the porphyrin is unstrained and energetically favored for the five-coordinate ferrous atom. When O₂ binds the sixth coordinate position of the iron, however, this conformation becomes strained. A more energetically favorable conformation for the O₂ liganded iron is one in which the iron atom is within the plane of the porphyrin structure.

On binding of O₂ to a ferrous atom the favorable free energy of bond formation overcomes the repulsive interaction between His F8 and porphyrin, and the ferrous atom moves into the plane of the porphyrin ring. This is the most thermodynamically stable position for the now six-bonded iron atom; one axial ligand is on either side of the plane of the porphyrin ring, and the steric repulsion of one of the axial ligands with the porphyrin is balanced by the repulsion of the second axial ligand on the opposite side when the ferrous atom is in the center. If the iron atom is displaced from the center, the steric interactions of the two axial ligands with the porphyrin in the deoxy conformation are unbalanced, and the stability of the unbalanced structure will be lower than that of the equidistant conformation. Also, the radius of the iron atom with six ligands is reduced so that it can just fit into the center of the porphyrin without distortion of the porphyrin conformation.

Since steric repulsion between porphyrin and His F8 in the deoxy conformation must be overcome on O₂ association, binding of the first O₂ is characterized by a relatively low affinity constant. However, when O₂ association occurs to the first heme in deoxyhemoglobin, the change in position of the iron atom from above the plane of the porphyrin into the center of the porphyrin triggers

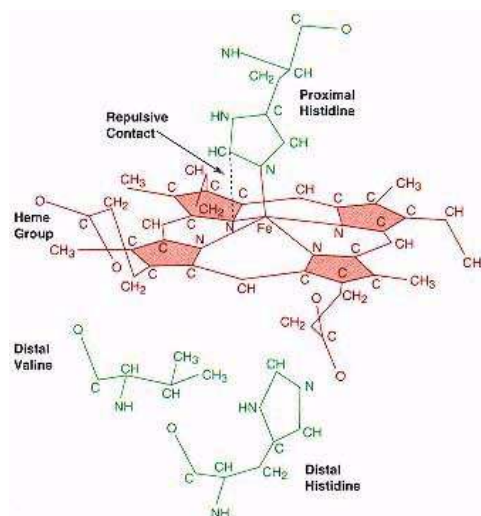

Figure 3.37
Steric hindrance between proximal histidine
and porphyrin in deoxyhemoglobin.

From Perutz, M. *Sci Am.*, 239:92, 1978

Copyright © 1978 by Scientific American, Inc. All rights reserved.

a conformational change in the whole molecule. The change in conformation results in a greater affinity of O₂ to the other heme sites after the first O₂ has bound.

The conformation of deoxyhemoglobin is stabilized by noncovalent interactions of the quaternary structure at the interface between α and β subunits in which the FG corner of one subunit noncovalently binds to the C helix of the adjacent subunit (Figure 3.38). In addition, ionic interactions stabilize the deoxy

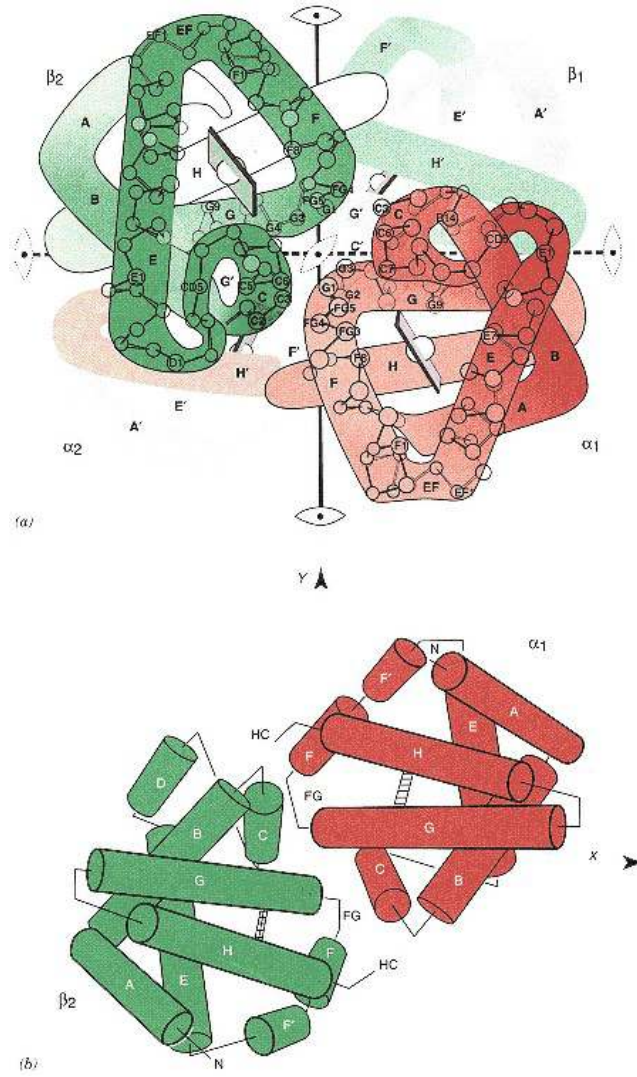

Figure 3.38
Quaternary structure of hemoglobin.

(a) $\alpha_1\beta_2$ interface contacts between FG corners and C helix are shown.

(b) Cylinder

representation of α_1 and β_2 subunits in hemoglobin molecule showing α_1 and β_2 interface contacts between FG corner and C helix, viewed from opposite side of x - y plane from (a).

(a) Reprinted with permission from Dickerson, R. E., and Geis, I. *The Structure and Action of Proteins*. Menlo Park, CA: Benjamin, Inc., 1969, p. 56.

(b) Reprinted with permission from Baldwin, J., and Chothia, C. *J. Mol. Biol.* 129:175, 1979. Copyright © 1979 by Academic Press, Inc. (London) Ltd.

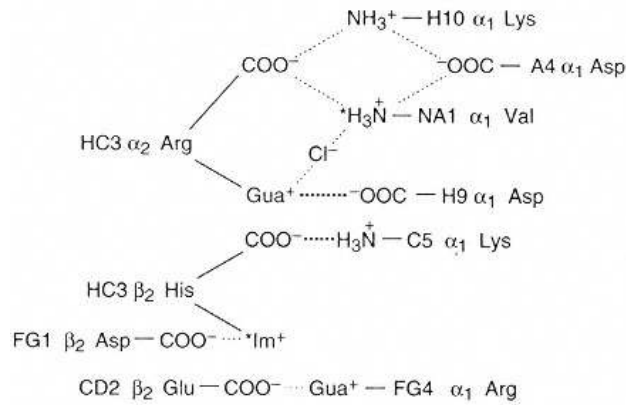

Figure 3.39

Salt bridges between subunits in deoxyhemoglobin.

Im^+ is imidazolium; Gua^+ is guanidinium; starred residues account for approximately 60% of alkaline Bohr effect. Redrawn from Perutz, M. *Br. Med. Bull.* 32:195, 1976.

conformation of the protein (Figure 3.39). These interactions of the deoxy conformation are now destabilized on the binding of O_2 to one of the heme subunits of a deoxyhemoglobin molecule. The binding of O_2 pulls the Fe^{2+} atom into the porphyrin plane and moves the His F8 toward the porphyrin and with it the F helix of which the His F8 is a part. Movement of the F helix, in turn, moves the FG corner of its subunit, destabilizing the FG noncovalent interaction with the C helix of the adjacent subunit at an $\alpha_1\beta_2$ or $\alpha_2\beta_1$ subunit interface (Figures 3.38 and 3.40).

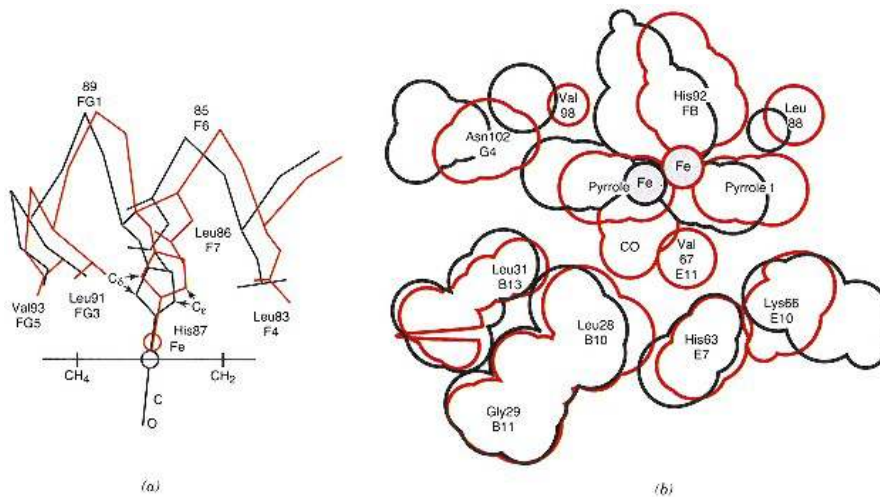

Figure 3.40

Stick and space-filling diagrams drawn by computer graphics showing movements of residues in heme environment on transition from deoxyhemoglobin to oxyhemoglobin.

(a) Black line outlines position of polypeptide chain and His F8 in carbon monoxide hemoglobin, a model for oxyhemoglobin. Red line outlines the same for deoxyhemoglobin. Position of iron atom shown by circle. Movements are for an α subunit.

(b) Similar movements in a β subunit using space-filling diagram shown. Residue labels centered in density for the deoxyconformation.

Redrawn with permission from Baldwin, J., and Chothia, C. *J. Mol. Biol.* 129:175, 1979. Copyright © 1979 by Academic Press, Inc. (London) Ltd.

The FG to C intersubunit contacts act as a "switch," because they exist in two different arrangements with different modes of contact between the FG corner of one subunit and the C helix of the adjacent subunit. The switch in noncovalent interactions between the two positions involves a relative movement of FG and C in adjacent subunits of about 6 Å. In the second position of the "switch," the tertiary conformation of the subunits participating in the FG to C intersubunit contact is less constrained and the adjacent subunit changes to a new tertiary conformation (oxy conformation) even without O₂ bound. This oxy conformation allows the His F8 residues to approach their porphyrins on O₂ association with a less significant steric repulsion than in the deoxy conformation (Figure 3.40). Thus an O₂ molecule binds to the empty hemes in the less constrained oxy conformation more easily than to a subunit conformation held by the quaternary interactions in the deoxy conformation.

In addition, Val E11 in the deoxy conformation of β subunits is at the entrance to the O₂-binding site, where it sterically impedes O₂ association to heme (see Figure 3.33). In the oxy conformation the heme in β subunits moves approximately 1.5 Å further into the heme-binding site, changing the geometric relationship of the O₂-binding site to the Val E11 side chain, so that the Val E11 no longer sterically interferes with O₂ binding. This is an important additional factor that increases affinity of O₂ for the oxy conformation of the β chain over that for the deoxy conformation.

The deoxy conformation of hemoglobin is referred to as the "tense" or **T conformational state**. The oxyhemoglobin conformational form is referred to as the "relaxed" or **R conformational state**. The allosteric mechanism shows how initial binding of the oxygen to one of the heme subunits of the tetrameric molecule pushes the molecular conformation from the T to R conformational state. The affinity constant of O₂ is greater for the R state hemes than the T state by a factor of 150–300, depending on the solution conditions.

The Bohr Effect Involves Dissociation of a Proton on Binding of Oxygen

The equilibrium expression for oxygen association to hemoglobin includes a term that indicates participation of H⁺ in the equilibrium.

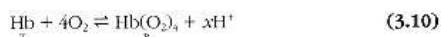

Equation 3.10 shows that the R form is more acidic, and the H⁺ dissociate when hemoglobin is changed to the R form. The equivalents of H⁺ that dissociate per mole of hemoglobin depends on the pH of the solution and the concentration of other factors that can bind to hemoglobin, such as Cl⁻ and bisphosphoglycerate (see Chapter 25). At pH 7.4, the value of *x* may vary from 1.8 to 2.8, depending on the solution conditions. This production of H⁺ at an alkaline pH (pH > 6), when deoxyhemoglobin is transformed to oxyhemoglobin, is known as the alkaline **Bohr effect**.

The H⁺ are derived from the partial dissociation of acid residues with *pK_a* of histidine at blood pH results in conversion of some of its acid form to its conjugate base (imidazole) form, with dissociation of H⁺ that forms a part of the Bohr effect. Breakage of

this ion pair with release of protons accounts for 50% of the H⁺ released on conversion to the R conformation. Other acid groups in the protein contribute the additional H⁺ due to analogous decreases in their pK'_a values on changing from the T to R conformation.

The equilibrium involving hydrogen ions produced by the Bohr effect has important physiological consequences. Cells metabolizing at high rates, with high requirements for molecular oxygen, produce carbonic acid and lactic acid, which act to increase the hydrogen ion concentration in the cell's environment. As the increase in hydrogen ion concentration forces the equilibrium of Eq. 3.10 to the left, from the higher O₂ affinity conformation (R) to the lower affinity conformation (T), an increased amount of oxygen is dissociated from the hemoglobin molecule.

Bibliography

Immunoglobulins

- Alzari, P. M., Lascombe, M.-B., and Poljak, R. J. Structure of antibodies. *Annu. Rev. Immunol.* 6:555, 1988.
- Chothia, C., Lesk, A. M., Tramontano, A., Levitt, M., Smith-Gill, S. J., Air, G., Sheriff, S., Padlan, E. A., Davies, D., Tulip, W. R., Colman, P. M., Spinelli, S., Alzari, P. M., and Poljak, R. J. Conformations of immunoglobulin hyper-variable regions. *Nature* 342:877, 1989.
- Davies, D. R., Padlan, E. A., and Sheriff, S. Antibody–antigen complexes. *Acc. Chem. Res.* 26:421, 1993.
- Guddat, L. W., Shan, L., Fan, Z.-C., Andersen, K. N., Rosauer, R., Linthicum, D. S., and Edmundson, A. B. Intramolecular signaling upon complexation. *FASEB J.* 9:101, 1995.
- Hunkapiller, T., and Hood, L. Diversity of the immunoglobulin gene super-family. *Adv. Immunol.* 44:1, 1989.
- Padlan, E. A. Anatomy of the antibody molecule. *Mol. Immunol.* 31:169, 1994.
- Rini, J. M., Schultze-Gahmen, U., Wilson, I. A. Structural evidence for induced fit as a mechanism for antibody–antigen recognition. *Science* 255:959, 1992.
- Stanfield, R. L., Takimoto-Kaminmura, M., Rini, J. M., Profy, A. T., and Wilson, I. A. Major antigen-induced domain rearrangements in an antibody. *Structure* 1:83, 1993.

Serine Proteases

- Birk, Y. Proteinase inhibitors. In: A. Neuberger and K. Brocklehurst (Eds.), *Hydrolytic Enzymes*. Amsterdam: Elsevier, 1987, p. 257.
- Dufton, M. J. Could domain movements be involved in the mechanism of trypsin-like serine proteases? *FEBS Lett.* 271:9, 1990.
- Greer, J. Comparative modeling methods: application to the family of the mammalian serine proteases. *Proteins* 7:317, 1990.
- Liebman, M. N. Structural organization in the serine proteases. *Enzyme* 36:115, 1986.
- Neurath, H. Proteolytic processing and physiological regulation. *Trends Bio-chem. Sci.* 14:268, 1989.
- Perona, J. J., and Craik, C. S. Structural basis of substrate specificity in the serine proteases. *Protein Sci.* 4:337, 1995.
- Polgar, L. Structure and function of serine proteases. In: A. Neuberger and K. Brocklehurst (Eds.), *Hydrolytic Enzymes*, series in *New Comprehensive Biochemistry*, Vol. 16. Amsterdam: Elsevier, 1987, p. 159.
- Zwaal, R. F. A., and Hemker, H. C. (Eds.). *Blood Coagulation*, series in *New Comprehensive Biochemistry*, Vol. 13. Amsterdam: Elsevier, 1986.

DNA-Binding Proteins

- Berger, J. M., Gamblin, S. J., Harrison, S. C., and Wang, J. C. Structure and mechanism of DNA topoisomerase II. *Nature* 379:225, 1996.
- Cho, Y., Gorina, S., Jeffrey, P. D., Pavletich, N. P. Crystal structure of a p53 tumor suppressor–DNA complex: understanding tumorigenic mutations. *Science* 265:346, 1994.
- Ellenberger, T. E., Brandl, C. J., Struhl, K., and Harrison, S. C. The GCN4 basic region leucine zipper binds DNA as a dimer of uninterrupted α helices: crystal structure of the protein–DNA complex. *Cell* 71:1223, 1992.
- Ghosh, G., Van Duyne, G., Ghosh, S., and Sigler, P. B. Structure of NF- κ B p50 homodimer bound to a κ B site. *Nature* 373:303, 1995.
- Landschulz, W. H., Johnson, P. F., and McKnight, S. L. The leucine zipper: a hypothetical structure common to a new class of DNA binding proteins. *Science* 240:1759, 1988.
- Lee, M. S., Gippert, G. P., Soman, K. V., Case, D. A., and Wright, P. E. Three-dimensional solution structure of a single zinc finger DNA-binding domain. *Science* 245:635, 1989.
- Lewis, M., Chang, G., Horton, N. C., Kercher, M. A., Pace, H. C., Schumacher, M. A., Brennan, R. G., and Lu, P. Crystal structure of the lactose operon repressor and its complexes with DNA and inducer. *Science* 271:1247, 1996.
- Müller, C. W., Rey, F. A., Sodeoka, M., Verdine, G. L., and Harrison, S. C. Structure of the NF- κ B p50 homodimer bound to DNA. *Nature* 373:311, 1995.
- Nikolov, D. B., Chen, H., Halay, E. D., Usheva, A. A., Hisatake, K., Lee, D. K., Roeder, R. G., and Burley, S. K. Crystal structure of a TFIIB-TBP-TATA-element ternary complex. *Nature* 377:119, 1995.
- Pavletich, N. P., and Pabo, C. O. Zinc finger–DNA recognition: crystal structure of a Zif-268–DNA complex at 2.1 Å. *Science* 252:809, 1991.
- Pellegrini, L., Tan, S., and Richmond, T. J. Structure of serum response factor core bound to DNA. *Nature* 376:490, 1995.

Hemoglobin

- Baldwin, J., and Chothia, C. Haemoglobin: the structural changes related to ligand binding and its allosteric mechanism. *J. Mol. Biol.* 129:175, 1979.
- Busch, M. R., Mace, J. E., Ho, N. T., and Ho, C. Roles of the β -146 histidyl residue in the molecular basis of the Bohr effect of hemoglobin: a protein nuclear magnetic resonance study. *Biochemistry* 30:1865, 1991.
- Dickerson, R. E., and Geis, I. *Hemoglobin: Structure, Function, Evolution and Pathology*. Menlo Park, CA: Benjamin-Cummings, 1983.
- Ho, C. Proton nuclear magnetic resonance studies on hemoglobin: cooperative interactions and partially ligated intermediates. *Adv. Protein Chem.* 43:154, 1992.
- Jayaraman, V., Rodgers, K. R., Mukerji, I., and Spiro, T. G. Hemoglobin allostery: resonance Raman spectroscopy of kinetic intermediates. *Science* 269:1843, 1995.
- Jia, L., Bonaventura, C., Bonaventura, J., and Stamler, J. S. S-Nitrosohaemo-globin: a dynamic activity of blood involved in vascular control. *Nature* 380:221, 1996.
- Mathews, A. J., Rohlf, R. J., Olson, J. S., Tame, J., Renaud, J. P., and Nagai, K. The effects of E7 and E11 mutations on the kinetics of ligand binding to R state human hemoglobin. *J. Biol. Chem.* 264:16573, 1989.

Perutz, M. Hemoglobin structure and respiratory transport. *Sci. Am.* 239:92, 1978.

Perutz, M. F., Fermi, G., and Shih, T.-B. Structure of deoxy cowtown [His HC3(146)beta to Leu]: origin of the alkaline Bohr effect. *Proc. Natl. Acad. Sci. U.S.A.* 81:4781, 1984.

Srinivasan, R., and Rose, G. D. The T-to-R transformation in hemoglobin: a reevaluation. *Proc. Natl. Acad. Sci. U.S.A.* 91:11113, 1994.

Questions

J. Baggott and C. N. Angstadt

1. Haptens:

- A. can function as antigens.
- B. strongly bind to antibodies specific for them.
- C. may be macromolecules.
- D. never act as antigenic determinants.
- E. can directly elicit the production of specific antibodies.

2. IgG:

- A. is found primarily in mucosal secretions.
- B. is one of the less common immunoglobulin types.
- C. has the highest molecular weight of all the immunoglobulins.
- D. contains carbohydrate covalently attached to the H chain.
- E. plays an important role in allergic responses.

3. In the three-dimensional structure of immunoglobulins:

- A. β -sheets align edge to edge.
- B. in each chain (H and L) the C and V regions fold onto one another, forming C–V associations.
- C. C_L – V_L associations form the complementary sites for binding antigens.
- D. free–SH groups are preserved to function in tight binding of antigens.
- E. hinge domains connect globular domains

4. Study of the papain hydrolysis products of an antibody indicates:

- A. antibodies are bivalent.
- B. the products have decreased affinity for antigens.
- C. each antibody molecule is hydrolyzed into many small peptides.
- D. the hypervariable sequences are in the hinge region of the intact molecule.
- E. none of the above is true.

5. In immunoglobulins all of the following are true EXCEPT:

- A. there are four polypeptide chains.
- B. there are two copies of each type of chain.
- C. all chains are linked by disulfide bonds.
- D. carbohydrate is covalently bound to the protein.
- E. immunoglobulin class is determined by the C_L regions.

6. Serine proteases:

- A. hydrolyze peptide bonds involving the carboxyl groups of serine residues.
- B. are characterized by having several active sites per molecule, each containing a serine residue.
- C. are inactivated by reacting with one molecule of diisopropyl-fluorophosphate per molecule of protein.
- D. are exopeptidases.
- E. are synthesized in an active form in eukaryotes.

7. The active sites of all serine proteases contain which of the following amino acid residues?

- A. asparagine
- B. γ -carboxyglutamate
- C. histidine
- D. lysine or arginine
- E. threonine

8. All of the following are characteristic of serine proteases as a class EXCEPT:

- A. only one serine residue is catalytically active.
- B. natural protein substrates and inhibitors bind very tightly to the protease.
- C. the genes that code for them are analogously organized.
- D. catalytic units exhibit two structural domains of dramatically different size.
- E. in eukaryotes, the serine proteases are produced initially as zymogens.

9. All of the following serine proteases exhibit sequence homology EXCEPT:

- A. chymotrypsin.
- B. elastase.
- C. *Streptomyces griseus* protease.
- D. subtilisin.
- E. trypsin.

Refer to the following for Questions 10–13.

- A. helix–turn–helix
- B. leucine zipper
- C. zinc finger
- D. all of the above
- E. none of the above

10. Not a DNA-binding motif.

11. Contains a single α -helix.

12. Two domains form a β -pleated sheet, which fits over the DNA double helix.

13. Found in proteins which bind to DNA.

14. The α -chain appears in all normal human hemoglobins EXCEPT:

- A. HbA₁.
- B. HbA₂.
- C. HbF.
- D. Hb Gower-1.

15. Hemoglobin and myoglobin both have all of the following characteristics EXCEPT:

- A. consist of subunits designed to provide hydrogen bonds to and nonpolar interaction with other subunits.
- B. highly α -helical.
- C. bind one molecule of heme per globin chain.
- D. bind heme in a hydrophobic pocket.
- E. can bind one O₂ per heme.

16. Hemoglobin, but not myoglobin, when it binds oxygen, exhibits:
- a hyperbolic saturation curve.
 - a Hill coefficient of 1.
 - positive cooperativity.
 - a cooperativity index of 81.
17. All of the following are believed to contribute to the stability of the deoxy or T conformation of hemoglobin EXCEPT:
- the larger ionic radius of the six-coordinated ferrous ion as compared to the five-coordinated ion.
 - steric interaction of His F8 with the porphyrin ring.
 - interactions between the FG corner of one subunit and the C helix of the adjacent subunit.
 - a valyl residue that tends to block O₂ from approaching the hemes of the β -chains.
18. In the Bohr effect:
- oxygen is released with increasing difficulty as the pH decreases.
 - the R form of hemoglobin is more acidic than the T form.
 - histidine 146 (β) interacts with a nearby Cl⁻.
 - cells with higher voluntary oxygen demand are deprived to ensure adequate oxygen for other tissues.
 - bisphosphoglycerate decreases the oxygen affinity of hemoglobin.

Answers

- B Haptens are small molecules and cannot alone elicit antibody production; thus they are not antigens. They can act as antigenic determinants if covalently bound to a larger molecule, and free haptens may bind strongly to the antibodies thereby produced (p. 88).
- D All immunoglobulins are glycoproteins. A: IgA is associated with mucosal secretions. B: IgG is the most common immunoglobulin type. C: IgM has the highest molecular weight (Table 3.1, p. 90) E: IgE plays an important role in allergic responses (Clin. Corr. 3.2, p. 92).
- E See Figures 3.4–3.7, p. 93. A: The β -sheets align face-to-face. D: Antigen binding is noncovalent.
- A In these hydrolysis experiments, three fragments are produced: two identical Fab fragments, each of which binds antigen with an affinity similar to that of the whole antibody molecule, and one Fc fragment, which does not bind antigens (p. 92).
- E There are two copies of each of two types of polypeptide chain (p. 89).
- C This is the distinguishing characteristic of the serine proteases, and of the serine hydrolases in general. A: They have various specificities (p. 99). B: There is only one active site per molecule (p. 103). D: They are all endopeptidases (p. 98). E: In eukaryotes they are synthesized as inactive precursors, zymogens, or proenzymes (p. 105).
- C (p. 103). A: Aspartate, not asparagine, is involved. B: γ -Carboxyglutamate is essential to some of the serine proteases, but it is not at the active site. D: These are the substrate specificities of the trypsin-like proteases.
- D The domains are of about equal size (p. 105).
- D The bacterial protease subtilisin may be an example of converging evolution (p. 106). See also Table 3.7, p. 107.
- B The leucine zipper binds two subunits in a head-to-head manner but does not itself interact with DNA (p. 110).
- C See p. 108 and Figure 3.23.
- E This describes the TATA box-binding protein (p. 112).
- D
- D Hb Gower-1 has the structure $\zeta_2\varepsilon_2$ (p. 114, Table 3.8).
- A Hemoglobin has four chains and four oxygen-binding sites, whereas myoglobin has one chain and one oxygen-binding site. Each oxygen-binding site is a heme (p. 115).
- C Hemoglobin's Hill coefficient of 2.8 indicates positive cooperativity (p. 119). A: See p. 118, Figure 3.35. B: Myoglobin has a Hill coefficient of 1. D: A cooperativity index of 81 indicates noncooperativity; hemoglobin's lower value of 4.8 reflects cooperative oxygen binding (p. 119).
- A Six-coordinated ferrous ion has a smaller ionic radius than the five-coordinated species and just fits into the center of the porphyrin ring without distortion (p. 120).
- B His 146 (β) is a major contributor to the Bohr effect. Thus its pK'_a will be lower (it will be a stronger acid) in oxyhemoglobin (p. 123). E: This is true but is unrelated to the Bohr effect.

**Chapter 4—
Enzymes:
Classification, Kinetics, and Control**

J. Lyndal York



4.1 General Concepts	128
4.2 Classification of Enzymes	129
Class 1: Oxidoreductases	129
Class 2: Transferases	131
Class 3: Hydrolases	132
Class 4: Lyases	132
Class 5: Isomerases	133
Class 6: Ligases	133
4.3 Kinetics	133
Kinetics Studies the Rate of Change of Reactants to Products	133
The Rate Equation	134
Characterization of Reactions Based on Order	134
Reversibility of Reactions	135
Enzymes Show Saturation Kinetics	136
Terminology	136
Interaction of Enzyme and Substrate	136
Formulation of the Michaelis–Menten Equation	137
Significance of K_m	138
Linear Form of the Michaelis–Menten Equation	138
Derivation of the Michaelis–Menten Equation	139
An Enzyme Catalyzes Both Forward and Reverse Directions of a Reversible Reaction	140
Multisubstrate Reactions Follow Either a Ping–Pong or Sequential Mechanism	140
4.4 Coenzymes: Structure and Function	142
Adenosine Triphosphate May Be a Second Substrate or a Modulator of Activity	142
NAD and NADP Are Coenzyme Forms of Niacin	142
FMN and FAD Are Coenzyme Forms of Riboflavin	143
Metal Cofactors Have Various Functions	144
Role of the Metal As a Structural Element	145
Role of Metals in Oxidation and Reduction	146
4.5 Inhibition of Enzymes	147
Competitive Inhibition May Be Reversed by Increased Substrate	148
Noncompetitive Inhibitors Do Not Prevent Substrate from Binding	148
Irreversible Inhibition Involves Covalent Modification of an Enzyme Site	149
Many Drugs Are Enzyme Inhibitors	149
Sulfa Drugs	149
Methotrexate	150
Nonclassical Antimetabolites	150
Other Antimetabolites	151
4.6 Allosteric Control of Enzyme Activity	151
Allosteric Effectors Bind at Sites Different from Substrate-Binding Sites	151
Allosteric Enzymes Exhibit Sigmoidal Kinetics	152
Cooperativity Explains Interaction between Ligand Sites in an Oligomeric Protein	154
Regulatory Subunits Modulate the Activity of Catalytic Subunits	155
4.7 Enzyme Specificity: The Active Site	155
Complementarity of Substrate and Enzyme Explains Substrate Specificity	156
Asymmetry of the Binding Site	158
4.8 Mechanism of Catalysis	159
Enzymes Decrease Activation Energy	160
Acid–Base Catalysis	160
Substrate Strain	160
Covalent Catalysis	163
Transition State Stabilization	163
Entropy Effect	163
Abzymes Are Artificially Synthesized Antibodies with Catalytic Activity	164

Environmental Parameters Influence Catalytic Activity	165
Temperature	166
pH	166
4.9 Clinical Applications of Enzymes	166
Coupled Assays Utilize the Optical Properties of NAD, NADP, or FAD	168
Clinical Analyzers Use Immobilized Enzymes As Reagents	170
Enzyme-Linked Immunoassays Employ Enzymes As Indicators	170
Measurement of Isozymes Is Used Diagnostically	172
Some Enzymes Are Used As Therapeutic Agents	172
Enzymes Linked to Insoluble Matrices Are Used As Chemical Reactors	174
4.10 Regulation of Enzyme Activity	174
Bibliography	175
Questions and Answers	176
Clinical Correlations	
4.1 A Case of Gout Demonstrates Two Phases in the Mechanism of Enzyme Action	138
4.2 The Physiological Effect of Changes in Enzyme K_m Values	139
4.3 Mutation of a Coenzyme-Binding Site Results in Clinical Disease	142
4.4 A Case of Gout Demonstrates the Difference Between an Allosteric and Substrate-Binding Site	152
4.5 Thermal Lability of Glucose-6-Phosphate Dehydrogenase Results in Hemolytic Anemia	166
4.6 Alcohol Dehydrogenase Isoenzymes with Different pH Optima	167
4.7 Identification and Treatment of an Enzyme Deficiency	169
4.8 Ambiguity in the Assay of Mutated Enzymes	169

4.1—

General Concepts

Enzymes are specialized proteins that function in the acceleration of chemical reactions. Many reactions required for normal activity of cells would not proceed fast enough at the pH and temperature of the body without these specialized proteins. The term defining the speed of a chemical reaction, whether catalyzed or uncatalyzed, is **rate** or **velocity**. Rate (velocity) is the change in amount (moles, grams) of starting materials or products per unit time. Enzymes increase the rate by acting as catalysts. A **catalyst** increases the rate of a chemical reaction but is not itself changed in the process. An enzyme may become temporarily covalently bound to a molecule being transformed during intermediate stages of the reaction but at the end of the reaction the enzyme will again be in its original form as the product is released.

Two important characteristics of enzyme catalysts are that the enzyme is not changed as a result of catalysis and the enzyme does not change the equilibrium constant of the reaction but simply increases the rate at which the reaction approaches equilibrium. As will be discussed later, it accomplishes the rate increase by lowering the barrier to reaction; that is, it lowers the energy of activation. Therefore a catalyst increases the rate but does not change the thermodynamic properties of the system with which it is interacting.

Several terms need to be defined before we enter into a discussion of the mechanism of enzyme action. An **apoenzyme** is the protein part of an enzyme without any cofactors or prosthetic groups that may be required for the enzyme to be functional. The apoenzyme is catalytically inactive. Not all enzymes require cofactors or prosthetic groups. **Cofactors** are small organic or inorganic molecules that an apoenzyme requires for its activity. For example, in lysine oxidase copper is loosely bound but is required for the enzyme to be active. A **prosthetic** group is similar to a cofactor but is tightly bound to an apoenzyme. For example, in the cytochromes, the heme prosthetic group is very tightly bound and requires strong acids to disassociate it from the apocytochrome. Addition of a cofactor or prosthetic group to the apoprotein yields the **holoenzyme**, that is, the active enzyme. The molecule acted upon by the enzyme to form product is the **substrate**. Since most reactions are reversible, the products of the forward reaction become substrates for the reverse reaction.

Enzymes have a great deal of specificity. For example, glucose oxidase will oxidize glucose but not galactose. The specificity resides in a particular region on the enzyme surface, the **substrate-binding site**, a particular arrangement of amino acid side chains in the polypeptide that is specially formulated to

bind a specific substrate. Some enzymes have broad specificity; glucose, mannose, and fructose are phosphorylated by hexokinase, whereas glucokinase is specific for glucose. The substrate-binding site may contain the **active site**. In some cases, however, the active site may not be within the substrate-binding site but may be contiguous to it in the primary sequence. In other instances the active-site residues lie in distant regions of the primary sequence but are brought adjacent to the substrate-binding site by folding in the tertiary structure. The **active site** contains the machinery, in the form of particular amino acid side chains, involved in catalyzing the reaction.

Some enzymes have variants called **isoenzymes** (isozymes) that catalyze the same chemical reaction. Isoenzymes are electrophoretically distinguishable because of mutations in one or more amino acids in noncritical areas of the protein.

Some enzymes have a region of the molecule, the **allosteric site**, that is not at the active site or substrate-binding site but is a unique site where small molecules bind and effect a change in the substrate-binding site or the activity occurring in the active site. The binding of a specific small molecule at the allosteric site causes a change in the conformation of the enzyme. This can cause the active site to become either more active or less active by increasing or decreasing the affinity of the binding site for substrate. Such interactions regulate the enzyme's activity and are discussed in detail on page 151.

4.2— Classification of Enzymes

The International Union of Biochemistry and Molecular Biology (IUBMB) has established a system whereby all enzymes are classified into six major classes, each subdivided into subclasses that are further subdivided. In naming an enzyme, the substrates are stated first, followed by the reaction type to which the ending -ase is affixed. For example, alcohol dehydrogenase is alcohol:NAD⁺ oxidoreductase because it catalyzes an oxidation–reduction reaction and the electron donor is an alcohol and the acceptor is NAD⁺. Many common names persist but are not very informative. For example, "aldolase" does not tell much about the substrates, although it does identify the reaction type. We will use trivial names recognized by the IUBMB and that are in common usage. Table 4.1 summarizes the six major classes and subclasses of enzymes.

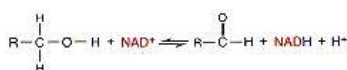

Figure 4.1
Oxidation of ethanol by alcohol dehydrogenase.

Class 1— Oxidoreductases

These enzymes catalyze **oxidation–reduction reactions**. For example, alcohol:NAD⁺ oxidoreductase (alcohol **dehydrogenase**) catalyzes the oxidation of an alcohol to an aldehyde. It removes two electrons and two hydrogen atoms from the alcohol to yield an aldehyde, and, in the process, the two electrons originally in the carbon–hydrogen bond of the alcohol are transferred to the NAD⁺, which is reduced (Figure 4.1). NAD⁺, whose structure is presented in Figure 4.19, is a cofactor that mediates many biological oxidation–reduction reactions. The redox site in NAD⁺ is shown in Figure 4.20. In addition to the alcohol and aldehyde functional groups, dehydrogenases also act on the following functional groups as electron donors: –CH₂–CH₂–, –CH₂–NH₂, and –CH=NH, as well as the cofactors NADH and NADPH.

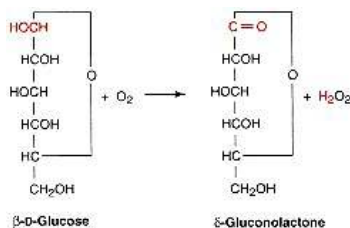

Figure 4.2
Oxidation of glucose by glucose oxidase.

There are other subclasses of the oxidoreductases. **Oxidases** transfer two electrons from the donor to oxygen, resulting usually in hydrogen peroxide (H₂O₂) formation. For example, **glucose oxidase** catalyzes the reaction shown in Figure 4.2. **Cytochrome oxidase** produces H₂O rather than H₂O₂. **Oxygenases** catalyze the incorporation of oxygen into a substrate. With dioxygenases both atoms of O₂ are incorporated in a single product, whereas with the monooxygenases a single oxygen atom is incorporated as a hydroxyl group

TABLE 4.1 Summary of the Enzyme Classes and Major Subclasses

1. Oxidoreductases Dehydrogenases Oxidases Reductases Peroxidases Catalase Oxygenases Hydroxylases	2. Transferases Transaldolase and transketolase Acyl, methyl, glucosyl, and phosphoryltransferase Kinases Phosphomutases
3. Hydrolases Esterases Glycosidases Peptidases Phosphatases Thiolases Phospholipases Amidases Deaminases Ribonucleases	4. Lyases Decarboxylases Aldolases Hydratases Dehydratases Synthases Lyases
5. Isomerases Racemases Epimerases Isomerases Mutases (not all)	6. Ligases Synthetases Carboxylases

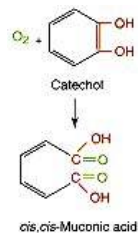

Figure 4.3
Oxygenation
of catechol by
an oxygenase.

and the other oxygen atom is reduced to water by electrons from the substrate or from a second substrate that is not oxygenated. **Catechol oxygenase** catalyzes the dioxygenase reaction (Figure 4.3); steroid hydroxylase illustrates a monooxygenase (mixed function oxygenase) reaction (Figure 4.4). **Peroxidases** utilize H_2O_2 rather than oxygen as the oxidant. NADH peroxidase catalyzes the reaction

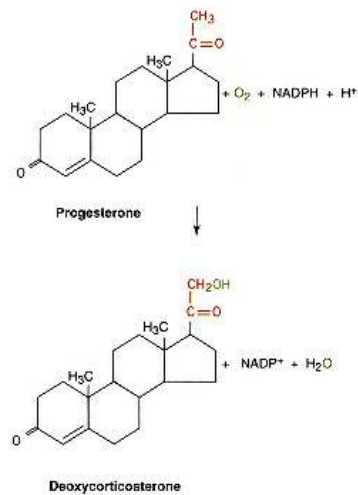
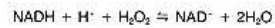
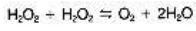

Figure 4.4
Hydroxylation of progesterone by a monooxygenase.

Catalase is unique in that H_2O_2 serves as both donor and acceptor. Catalase functions in the cell to detoxify H_2O_2 :



**Class 2—
Transferases**

These enzymes transfer functional groups between donors and acceptors. The amino, acyl, phosphate, one-carbon, and glycosyl groups are the major moieties that are transferred. **Aminotransferases (transaminases)** transfer an amino group from one amino acid to an α -keto acid acceptor, resulting in the formation of a new amino acid and a new keto acid (Figure 4.5). **Kinases** are the phosphorylating enzymes that catalyze the transfer of the γ phosphoryl group from ATP or another nucleoside triphosphate to alcohol or amino group acceptors. For example, glucokinase catalyzes the phosphorylation of glucose (Figure 4.6).

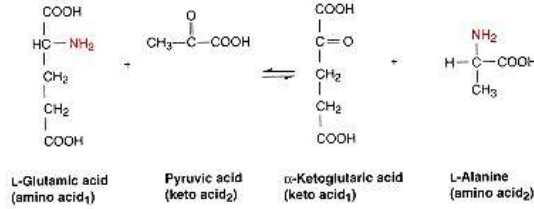

Figure 4.5
Examples of a reaction catalyzed by an aminotransferase.

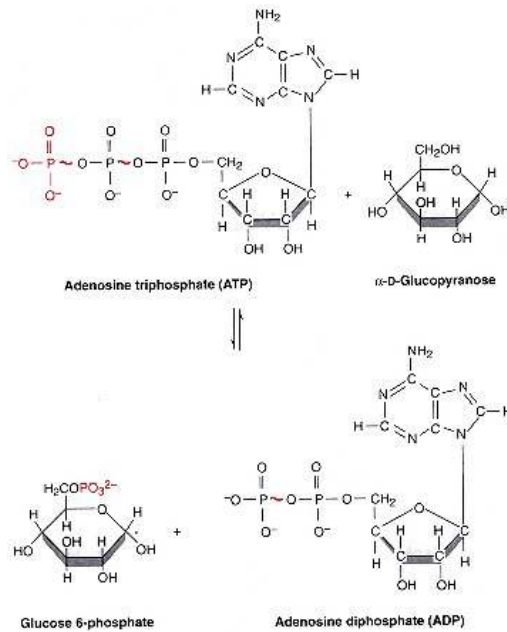

Figure 4.6
Phosphorylation of glucose by a kinase.

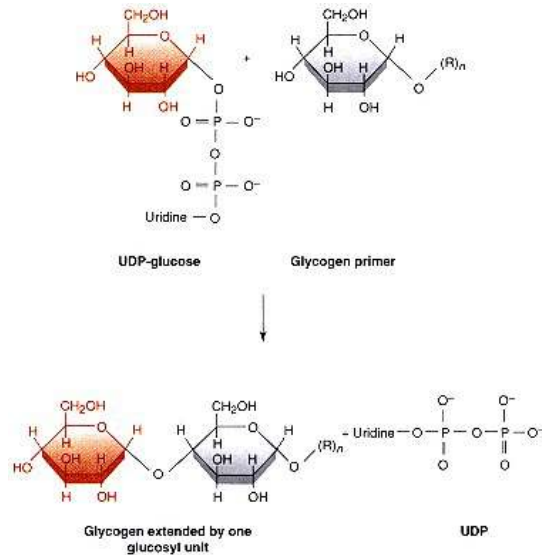

Figure 4.7

A transferase reaction—synthesis of glycogen.

Glycogen synthesis depends on glucosyltransferases, which transfer an activated glucosyl residue to a glycogen primer. The phosphoester bond in uridine diphosphoglucose is labile, which allows the glucose to be transferred to the growing end of the glycogen primer as indicated in Figure 4.7.

Although a polymer is synthesized, the reaction is not of the ligase type reaction; see Class 6.

Class 3—

Hydrolases

This group of enzymes can be considered as a special class of the transferases in which the donor group is transferred to water. The generalized reaction involves the hydrolytic cleavage of C–O, C–N, O–P, and C–S bonds. The cleavage of a peptide bond is a good example of this reaction:

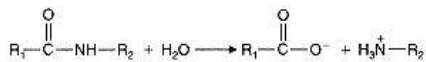

Proteolytic enzymes are a special class of hydrolases called **peptidases**.

Class 4—

Lyases

Lyases add or remove the elements of water, ammonia, or carbon dioxide. **Decarboxylases** remove the element of CO_2 from α - or β -keto acids or amino acids:

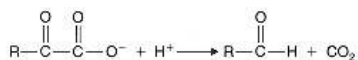

Dehydratases remove H_2O in a dehydration reaction. Fumarase converts fumarate to malate (Figure 4.8).

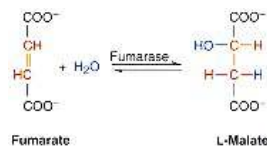

Figure 4.8

The fumarase reaction.

Class 5— Isomerases

This very heterogeneous group of enzymes catalyze isomerizations of several types. These include cis–trans and aldose–ketose interconversions. Isomerases that catalyze inversion at asymmetric carbon atoms are either **epimerases** or **racemases** (Figure 4.9). **Mutases** involve intramolecular transfer of a group such as a phosphoryl. The transfer may be direct but can involve a phosphorylated enzyme as an intermediate. Phosphoglycerate mutase catalyzes conversion of 2-phosphoglycerate to 3-phosphoglycerate (Figure 4.10).

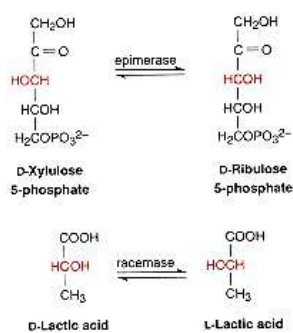

Figure 4.9
Examples of reactions catalyzed by an epimerase and a racemase.

Class 6— Ligases

Since to ligate means to bind, these enzymes are involved in synthetic reactions where two molecules are joined at the expense of a "high-energy phosphate bond" of ATP. The term **synthetase** is reserved for this particular group of enzymes. The formation of aminoacyl tRNAs, acyl coenzyme A, and glutamine and the addition of CO₂ to pyruvate are reactions catalyzed by ligases. Pyruvate carboxylase is a good example of a ligase enzyme (Figure 4.11). The substrates bicarbonate and pyruvate are ligated to form a four-carbon (C4) α -keto acid.

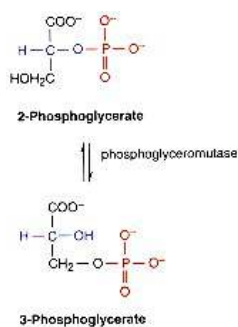

Figure 4.10
Interconversion of the 2- and 3-phosphoglycerates.

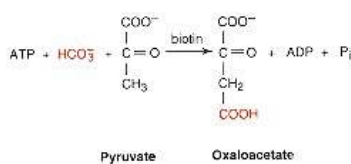

Figure 4.11
Pyruvate carboxylase reaction.

4.3— Kinetics

Kinetics Studies the Rate of Change of Reactants to Products

Since enzymes affect the rate of chemical reactions, it is important to understand basic chemical kinetics and how kinetic principles apply to enzyme-catalyzed reactions. **Kinetics** is a study of the rate of change of reactants to products. **Velocity** is expressed in terms of change in the *concentration* of substrate or product per unit time, whereas **rate** refers to changes in *total quantity* (moles or grams) per unit time. Biochemists tend to use these terms interchangeably.

The velocity of a reaction A → P is determined from a progress curve or velocity profile of a reaction. The progress curve can be determined by following the disappearance of reactants or the appearance of product at several different times. In Figure 4.12, product appearance is plotted against time. The slope of tangents to the progress curve yields the instantaneous velocity at that point in time. The initial velocity is an important parameter in the assay of enzyme concentration. Note that the velocity changes constantly as the reaction proceeds to equilibrium, where it becomes zero. Mathematically, the velocity is expressed as

$$\text{Velocity} = v = \frac{-d[A]}{dt} = \frac{d[P]}{dt} \quad (4.1)$$

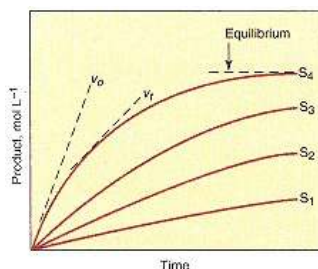

Figure 4.12
Progress curves for an enzyme-catalyzed reaction. The initial velocity (v_0) of the reaction is determined from the slope of the progress curve at the beginning of the reaction. The initial velocity increases with increasing substrate concentration (S_1 – S_4) but reaches a limiting value characteristic of each enzyme. The velocity at any time, t , is denoted as v_t .

and represents the change in concentration of reactants or products per unit time.

The Rate Equation

Determination of the velocity of a reaction reveals nothing about the stoichiometry of the reactants and products or about the reaction mechanism. An equation is needed that relates the experimentally determined initial velocity to the concentration of reactants. This is the velocity or rate equation. In the reaction $A \rightarrow P$, the velocity equation is

$$\frac{-d[A]}{dt} = v = k[A]^n \quad (4.2)$$

Thus the observed initial velocity depends on the starting concentration of A to the n th power multiplied by a proportionality constant (k). The latter is known as the **rate constant**. The exponent n is usually an integer from 1 to 3 that is required to satisfy the mathematical identity of the velocity expression.

Characterization of Reactions Based on Order

Another term useful in describing a reaction is the **order of reaction**. Empirically the order is determined as the sum of the exponents on each concentration term in the rate expression. In the case under discussion the reaction is **first order**, since the velocity depends on the concentration of A to the first power, $v = k[A]^1$. In the reaction $A + B \rightarrow C$, if the order with respect to A and B is 1, that is, $v = k[A]^1[B]^1$, overall the reaction is second order. Note that the order of reaction is independent of the stoichiometry of the reaction; that is, if the reaction were third order, the rate expression could be either $v = k[A][B]^2$ or $v = [A]^2[B]$, depending on the order in A and B. Since the velocity of the reaction is constantly changing as the reactant concentration changes, first-order reaction conditions would not be ideal for assaying an enzyme-catalyzed reaction because one would have two variables, the changing substrate concentration and the unknown enzyme concentration.

If the differential first-order rate expression Eq. 4.2 is integrated, one obtains

$$k_1 \cdot t = 2.3 \log \left(\frac{[A]}{[A] - [P]} \right) \quad (4.3)$$

where $[A]$ is the initial reactant concentration and $[P]$ is the concentration of product formed at time t . The first-order rate constant k_1 has the units of reciprocal time. If the data shown in Figure 4.12 were replotted as $\log [P]$ versus time for any one of the substrate concentrations, a straight line would be obtained whose slope is equal to $k_1/2.303$. The rate constant k_1 should not be confused with the rate or velocity of the reaction.

Many biological processes proceed under first-order conditions. The clearance of many drugs from the blood by peripheral tissues is a first-order process. A specialized form of the rate equation can be used in these cases. If we define $t_{1/2}$ as the time required for the concentration of the reactants or the blood level of a drug to be reduced by one-half the initial value, then Eq. 4.3 reduces to

$$k_1 \cdot t_{1/2} = 2.3 \log \left(\frac{1}{1 - \frac{1}{2}} \right) = 2.3 \log 2 = 0.69 \quad (4.4)$$

or

$$t_{1/2} = \frac{0.69}{k_1} \quad (4.5)$$

Note that $t_{1/2}$ is not one-half the time required for the reaction to be completed. The term $t_{1/2}$ is referred to as the half-life of the reaction.

Many **second-order** reactions that involve water or any one of the reactants in large excess can be treated as pseudo-first-order reactions. In the hydrolysis of an ester,

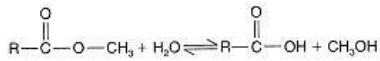

the second-order rate expression is

$$\text{velocity} = v = k_2[\text{ester}][\text{H}_2\text{O}] \quad (4.6)$$

but since water is in abundance (55.5 M) compared to the ester (10^{-3} – 10^{-2} M), the system obeys the first-order rate law Eq. 4.2, and the reaction appears to proceed as if it were a first-order reaction. Reactions in the cell that involve hydration, dehydration, or hydrolysis are pseudo-first-order.

The rate expression for the **zero-order** reaction is $v = k_0$. Note that there is no concentration term for reactants; therefore the addition of more reactant does not augment the rate. The disappearance of reactant or the appearance of product proceeds at a constant velocity irrespective of reactant concentration. The units of the rate constant are concentration per unit time. Zero-order reaction conditions only occur in catalyzed reactions where the concentration of reactants is large enough to saturate all the catalytic sites. Under these conditions the catalyst is operating at maximum velocity, and all catalytic sites are filled; therefore addition of more reactant cannot increase the rate.

Reversibility of Reactions

Although most chemical reactions are reversible, some directionality is imposed on particular steps in a metabolic pathway by rapid removal of end product by subsequent reactions in the pathway. Many ligase reactions involving the nucleoside triphosphates result in release of pyrophosphate (PP_i). These reactions are rendered irreversible by the hydrolysis of the pyrophosphate to 2 moles of inorganic phosphate, P_i. Schematically,

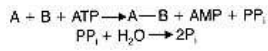

Conversion of the "high-energy" pyrophosphate to inorganic phosphate imposes irreversibility on the system by virtue of the thermodynamic stability of the products.

For reactions that are reversible, the equilibrium constant for

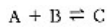

is

$$K_{\text{eq}} = \frac{[\text{C}]}{[\text{A}][\text{B}]} \quad (4.7)$$

and can also be expressed in terms of rate constants of the forward and reverse reactions:

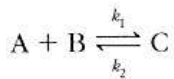

where

$$\frac{k_1}{k_2} = K_{\text{eq}} \quad (4.8)$$

Equation 4.8 shows the relationship between thermodynamic and kinetic quantities. The term K_{eq} is a thermodynamic expression of the state of the system, while k_1 and k_2 are kinetic expressions that are related to the speed at which that state is reached.

Enzymes Show Saturation Kinetics

Terminology

Enzyme activity is usually expressed as micromoles ($\mu\text{ mol}$) of substrate converted to product per minute under specified assay conditions. One standard unit of enzyme activity (U) is that activity that catalyzes transformation of $1\ \mu\text{ mol min}^{-1}$. **Specific activity** of an enzyme preparation is defined as the number of enzyme units per milligram of protein ($\mu\text{ mol min}^{-1}\text{ mg of protein}^{-1}$ or U/mg of protein). This expression, however, does not indicate whether the sample tested contains only the enzyme protein; during enzyme purification the value will increase as contaminating protein is removed. The **catalytic constant**, or **turnover number**, of an enzyme is equal to the units of activity per mole of enzyme ($\mu\text{ mol/min/mol of enzyme}$). Where the enzyme has more than one catalytic center, the catalytic constant is often given on the basis of the particle weight of the subunit rather than the molecular weight of the entire protein. The Commission on Enzyme Nomenclature of the International Union of Biochemistry and Molecular Biology recommends that enzyme activity be expressed in units of moles per second, instead of micromoles per minute, to conform with the rate constants used in chemical kinetics. A new unit, the **Katal** (abbreviated kat), is proposed where 1 kat denotes conversion of 1 mol substrate per second. Activity can be expressed, however, as millikatals (mkat), microkatal ($\mu\text{ kat}$), and so forth. The specific activity and catalytic constant can also be expressed in katal.

The catalytic constant or turnover number allows direct comparison of relative catalytic ability between enzymes. For example, the constants for catalase and α -amylase are 5×10^6 and 1.9×10^4 , respectively, indicating that catalase is about 2500 times more active than amylase.

Maximum velocity, V_{max} , is the velocity obtained under conditions of substrate saturation of the enzyme under specified conditions of pH, temperature, and ionic strength. V_{max} is a constant for a given enzyme.

Interaction of Enzyme and Substrate

The initial velocity of an enzyme-catalyzed reaction is dependent on the concentration of substrate (S) (Figure 4.12). As concentration of substrate increases (S_1 – S_4), initial velocity increases until the enzyme is completely saturated with substrate. If initial velocities obtained at given substrate concentrations are plotted (Figure 4.13), a rectangular hyperbola is obtained like that obtained for binding of oxygen to myoglobin as a function of increasing oxygen pressure. In general, a rectangular hyperbola is obtained for any process that involves interaction or binding of reactants or other substances at a specific but limited number of sites. The velocity of the reaction reaches a maximum at the point at which all the available sites are saturated. The curve in Figure 4.13 is referred

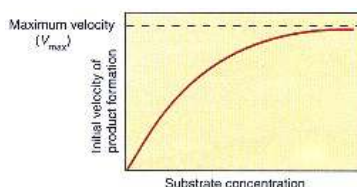

Figure 4.13

Plot of velocity versus substrate for an enzyme-catalyzed reaction.

Initial velocities are plotted against the substrate concentration at which they were determined. The curve is a rectangular hyperbola, which asymptotically approaches the maximum velocity possible with a given amount of enzyme.

to as the substrate saturation curve of an enzyme-catalyzed reaction and reflects the fact that an enzyme has a specific binding site for the substrate. Enzyme (E) and substrate must interact in some way if the substrate is to be converted to products. Initially there is formation of a complex between the enzyme and substrate:



The rate constant for formation of the ES complex is defined as k_1 , and the rate constant for disassociation of the ES complex is defined as k_2 . So far, we have described only an equilibrium binding of enzyme and substrate. The chemical event in which bonds are made or broken occurs in the ES complex. The conversion of substrate to products (P) then occurs from the ES complex with a rate constant k_3 . Therefore, Eq. 4.9 is transformed to

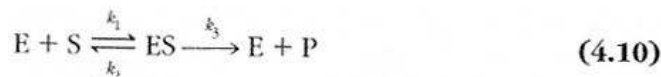

Equation 4.10 is a general statement of the mechanism of enzyme action. The equilibrium between E and S can be expressed as an affinity constant, K_a , only if the rate of the chemical phase of the reaction, k_3 , is small compared to k_2 ; then $K_a = k_1/k_2$. Earlier we used K_{eq} to describe chemical reactions. In enzymology the association or affinity constant K_a is preferred.

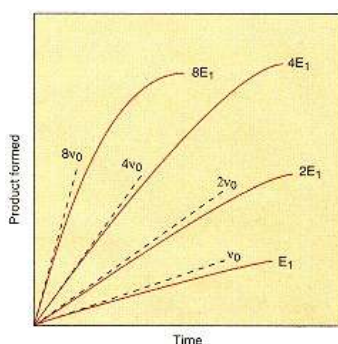

Figure 4.14

Progress curves at variable concentrations of enzyme and saturating levels of substrate.

The initial velocity (v_0) doubles as the enzyme concentration doubles. Since the substrate concentrations are the same, the final equilibrium concentrations of product will be identical in each case; however, equilibrium will be reached at a slower rate in those assays containing small amounts of enzyme.

The **initial velocity**, v_0 , of an enzyme-catalyzed reaction is dependent on amount of substrate present and on enzyme concentration. Figure 4.14 shows progress curves for increasing concentrations of enzyme, where there is enough substrate initially to saturate the enzyme at all levels. The initial velocity doubles as the concentration of enzyme doubles. At the lower concentrations of enzyme, equilibrium is reached more slowly than at higher concentrations, but the final equilibrium position is the same.

From this discussion, we can conclude that the velocity of an enzyme reaction is dependent on both substrate and enzyme concentrations.

Formulation of the Michaelis–Menten Equation

In the discussion of chemical kinetics, rate equations were developed so that velocity of the reaction could be expressed in terms of substrate concentration. This approach also holds for enzyme-catalyzed reactions, where the goal is to develop a relationship that will allow the velocity of a reaction to be correlated with the amount of enzyme. First, a rate equation must be developed that relates the velocity of the reaction to the substrate concentration.

Development of this rate equation, known as the **Michaelis–Menten equation**, requires three basic assumptions. The first is that the ES complex is in a **steady state**; that is, during the initial phases of the reaction, the concentration of the ES complex remains constant, even though many molecules of substrate are converted to products via the ES complex. The second assumption is that under saturating conditions all of the enzyme is converted to ES complex, and none is free. This occurs when the substrate concentration is high. The third assumption is that if all the enzyme is in the ES complex, then the rate of formation of products will be maximal; that is,

$$V_{max} = k_3[ES] \quad (4.11)$$

If we then write the steady-state expression for formation and breakdown of the ES complex as

$$K_m = \frac{k_2 + k_3}{k_1} \quad (4.12)$$

the rate expression obtained by suitable algebraic manipulation becomes

$$\text{Velocity} = v = \frac{V_{\max} \cdot [S]}{K_m + [S]} \quad (4.13)$$

The complete derivation of this equation is at the end of this section. The two constants in this rate equation, V_{\max} and K_m , are unique to each enzyme under specific conditions of pH and temperature. For enzymes in which $k_3 \ll k_2$, K_m becomes the reciprocal of the enzyme–substrate binding constant, and V_{\max} reflects the catalytic phase of the enzyme mechanism as suggested by Eq. 4.11. Thus, in this model, activity of the enzyme can be separated into two phases: binding of substrate followed by chemical modification of the substrate. This biphasic nature of the enzyme mechanism is reinforced in the clinical example discussed in Clin. Corr. 4.1.

CLINICAL CORRELATION 4.1

A Case of Gout Demonstrates Two Phases in the Mechanism of Enzyme Action

The two phases of the Michaelis–Menten model of enzyme action, binding followed by modification of substrate, are illustrated by studies on a family with gout. The patient excreted three times the normal amount of uric acid per day and had markedly increased levels of 5-phosphoribosyl- α -pyrophosphate (PRPP) in his red blood cells. PRPP is an intermediate in the biosynthesis of AMP and GMP, which are converted to ATP and GTP. Uric acid arises directly from degradation of AMP and GMP. Assays *in vitro* revealed that the patient's red cell PRPP synthetase activity was increased threefold. The pH optimum and the K_m of the enzyme for ATP and ribose 5-phosphate were normal, but V_{\max} was increased threefold! This increase was not due to an increase in the amount of enzyme; immunologic testing with a specific antibody to the enzyme revealed similar quantities of the enzyme protein as in normal red cells. This finding demonstrates that the binding of substrate as reflected by K_m and the subsequent chemical event in catalysis, which is reflected in V_{\max} , are separate phases of the overall catalytic process. This situation holds only for those enzyme mechanisms in which $k_3 \gg k_2$.

Becker, M. A., Kostel, P. J., Meyer, L. J., and Seegmiller, J. E. Human phosphoribosylpyrophosphate synthetase: increased enzyme specific activity in a family with gout and excessive purine synthesis. *Proc. Natl. Acad. Sci. U.S.A.* 70:2749, 1973.

Significance of K_m

The concept of K_m may appear to have no physiological or clinical relevance. The truth is quite the contrary. As discussed in Section 4.9, all valid enzyme assays performed in the clinical laboratory are based on knowledge of K_m values for each substrate. In terms of the physiological control of glucose and phosphate metabolism, two **hexokinases** have evolved, one with a high K_m and one with a low K_m for glucose. Together, they contribute to maintaining steady-state levels of blood glucose and phosphate, as discussed on page 284.

In general, K_m values are near the concentrations of substrate found in cells. Perhaps enzymes have evolved substrate-binding sites with affinities comparable to *in vivo* levels of their substrates. Occasionally, mutation of an enzyme-binding site occurs, or an isoenzyme with an altered K_m is expressed. Either of these events can result in an abnormal physiology. An interesting example (Clin. Corr. 4.2) is the expression of only the atypical form of **aldehyde dehydrogenase** in people of Asiatic origin.

Note that if one allows the initial velocity, v_0 , to be equal to $1/2 V_{\max}$ in Eq. 4.13, K_m will be equal to $[S]$:

$$\begin{aligned} \frac{1}{2} V_{\max} &= \frac{V_{\max} \cdot [S]}{K_m + [S]} \\ K_m + [S] &= \frac{2 V_{\max} \cdot [S]}{V_{\max}} \\ K_m &= [S] \end{aligned}$$

Thus, from a substrate saturation curve, the numerical value of K_m can be derived by graphical analysis (Figure 4.15). Here the K_m is equal to the substrate concentration that gives one-half the maximum velocity.

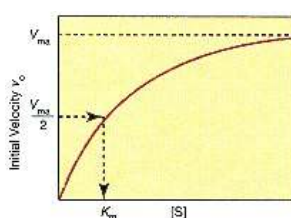

Figure 4.15
Graphic estimation of K_m for
the v_0 versus $[S]$ plot.

K_m is the substrate concentration at which the enzyme has half-maximal activity.

Linear Form of the Michaelis–Menten Equation

In practice the determination of K_m from the substrate saturation curve is not very accurate, because V_{\max} is approached asymptotically. If one takes the reciprocal of Eq. 4.13 and separates the variables into a format consistent with the equation of a straight line ($y = mx + b$), then

$$\frac{1}{v_0} = \frac{K_m}{V_{\max}} \times \frac{1}{[S]} + \frac{1}{V_{\max}}$$

A plot of the reciprocal of the initial velocity versus the reciprocal of the initial substrate concentration yields a line whose slope is K_m / V_{\max} and whose y -intercept is $1/V_{\max}$. Such a plot is shown in Figure 4.16. It is often easier to obtain the K_m from the intercept on the x -axis, which is $-1/K_m$.

This linear form of the Michaelis–Menten equation is often referred to as the **lineweaver–Burk** or **double-reciprocal plot**. Its advantage is that

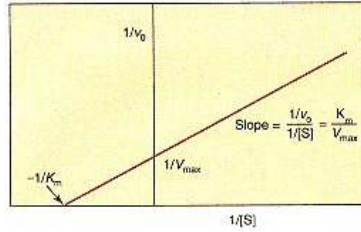

Figure 4.16

Determination of K_m and V_{max} from the Lineweaver–Burk double-reciprocal plot.

Plots of the reciprocal of the initial velocity versus the reciprocal of the substrate concentration used to determine the initial velocity yield a line whose x-intercept is $-1/K_m$.

CLINICAL CORRELATION 4.2

The Physiological Effect of Changes in Enzyme K_m Values

The unusual sensitivity of Asians to alcoholic beverages has a biochemical basis. In some Japanese and Chinese, much less ethanol is required to produce vasodilation that results in facial flushing and rapid heart rate than is required to achieve the same effect in Europeans. The physiological effects are due to acetaldehyde generated by liver alcohol dehydrogenase.

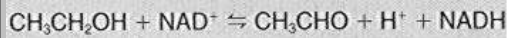

Acetaldehyde is normally removed by a mitochondrial aldehyde dehydrogenase that converts it to acetate. In some Asians, the normal form of the mitochondrial aldehyde dehydrogenase, with a low K_m for acetaldehyde, is missing. These individuals have only the cytosolic high K_m (lower affinity) form of the enzyme, which leads to a high steady-state level of acetaldehyde in the blood after alcohol consumption. This accounts for the increased sensitivity to alcohol.

Crabb, D. W., Edenberg, H. J., Bosron, W. F., and Li, T.-K. Genotypes for aldehyde dehydrogenase deficiency and alcohol sensitivity: The ALDH2 allele is dominant. *J. Clin. Invest.* 83:314, 1989.

statistically significant values of K_m and V_{max} can be obtained directly with six to eight data points.

Derivation of the Michaelis–Menten Equation

The generalized statement of the mechanism of enzyme action is

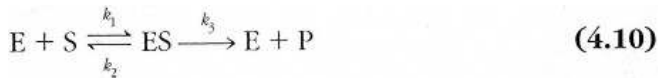

If we assume that the rate of formation of the ES complex is balanced by its rate of breakdown (the steady-state assumption), then we can write

$$\begin{aligned} v_{\text{formation}} &= k_1[\text{S}][\text{E}] \\ v_{\text{breakdown}} &= k_2[\text{ES}] + k_3[\text{ES}] = [\text{ES}](k_2 + k_3) \end{aligned}$$

If we set the rate of formation equal to the rate of breakdown, then

$$k_1[\text{S}][\text{E}] = [\text{ES}](k_2 + k_3)$$

After dividing both sides of the equation by k_1 , we have

$$[\text{S}][\text{E}] = [\text{ES}] \left[\frac{k_2 + k_3}{k_1} \right] \quad (4.14)$$

If we now define the ratio of the rate constants $(k_2 + k_3)/k_1$ as K_m , the Michaelis constant, and substitute it into Eq. 4.14, then

$$[\text{S}][\text{E}] = [\text{ES}]K_m \quad (4.15)$$

Since $[\text{E}]$ is equal to the free enzyme, we must express its concentration in terms of the total enzyme added to the system minus any enzyme in the $[\text{ES}]$ complex; that is,

$$[\text{E}] = ([\text{E}]_0 - [\text{ES}])$$

Upon substitution of the equivalent expression for $[\text{E}]$ into Eq. 4.15 we have

$$[\text{S}]([\text{E}]_0 - [\text{ES}]) = [\text{ES}]K_m$$

Dividing through by $[\text{S}]$ yields

$$[\text{E}]_0 - [\text{ES}] = \frac{[\text{ES}]K_m}{[\text{S}]}$$

and dividing through by $[\text{ES}]$ yields

$$\frac{[\text{E}]_0}{[\text{ES}]} - 1 = \frac{K_m}{[\text{S}]} \quad \text{or} \quad \frac{[\text{E}]_0}{[\text{ES}]} = \frac{K_m}{[\text{S}]} + 1 = \frac{K_m + [\text{S}]}{[\text{S}]} \quad (4.16)$$

We now need to obtain an alternative expression for $[E]/[ES]$, since $[ES]$ cannot be measured easily, if at all. When the enzyme is saturated with substrate all the enzyme will be in the ES complex, and none will be free, $[E] = [ES]$, and the velocity observed will be the maximum possible; therefore, $V_{\max} = k_3[E]$. When $[E]$ is not equal to $[ES]$, $v = k_3[ES]$. From these two expressions we can obtain the ratio of $[E]/[ES]$; that is,

$$\frac{[E]}{[ES]} = \frac{V_{\max}/k_3}{v/k_3} = \frac{V_{\max}}{v} \quad (4.17)$$

Substituting this value of $[E]/[ES]$ into Eq. 4.16 yields a form of the Michaelis–Menten equation:

$$\frac{V_{\max}}{v} = \frac{K_m + [S]}{[S]}$$

or

$$v = \frac{V_{\max}[S]}{K_m + [S]}$$

An Enzyme Catalyzes Both Forward and Reverse Directions of a Reversible Reaction

As indicated previously, enzymes do not alter the equilibrium constant of a reaction; consequently, in the reaction

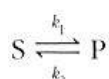

the direction of flow of material, either in the forward or the reverse direction, will depend on the concentration of S relative to P and the equilibrium constant of the reaction. Since enzymes catalyze the forward and reverse reactions, a problem may arise if product has an affinity for the enzyme that is similar to that of substrate. In this case the product can easily rebind to the active site of the enzyme and will compete with the substrate for that site. In such cases the product inhibits the reaction as concentration of product increases. The Lineweaver–Burk plot will not be linear in those cases where the enzyme is susceptible to **product inhibition**. If the subsequent enzyme in a metabolic pathway removes the product rapidly, then product inhibition should not occur.

Product inhibition in a metabolic pathway provides a limited means of controlling or modulating flux of substrates through the pathway. As the end product of a pathway increases, each intermediate will also increase by mass action. If one or more enzymes are particularly sensitive to product inhibition, output of end product of the pathway will be suppressed. Reversibility of a pathway or a particular enzyme-catalyzed reaction is dependent on the rate of product removal. If the end product is quickly removed, then the pathway may be physiologically unidirectional.

Multisubstrate Reactions Follow Either a Ping–Pong or Sequential Mechanism

Most enzymes utilize more than one substrate, or act upon one substrate plus a coenzyme and generate one or more products. In any case, a K_m must be determined for each substrate and coenzyme involved in the reaction when establishing an enzyme assay.

Mechanistically, enzyme reactions are divided into two major categories, ping–pong or sequential. There are many variations on these major mechanisms. The **ping–pong mechanism** can be represented as follows:

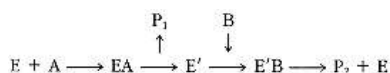

where substrate A reacts with E to produce product P_1 , which is released before the second substrate B binds to the modified enzyme E'. Substrate B is then converted to product P_2 and the enzyme is regenerated. A good example of this mechanism is the transaminase-catalyzed reaction (see p. 448) in which the α -amino group of amino acid₁ is transferred to the enzyme and the newly formed α -keto acid₁ is released, as the first product, followed by the binding of the acceptor α -keto acid₂ and release of amino acid₂. This reaction is outlined in Figure 4.17.

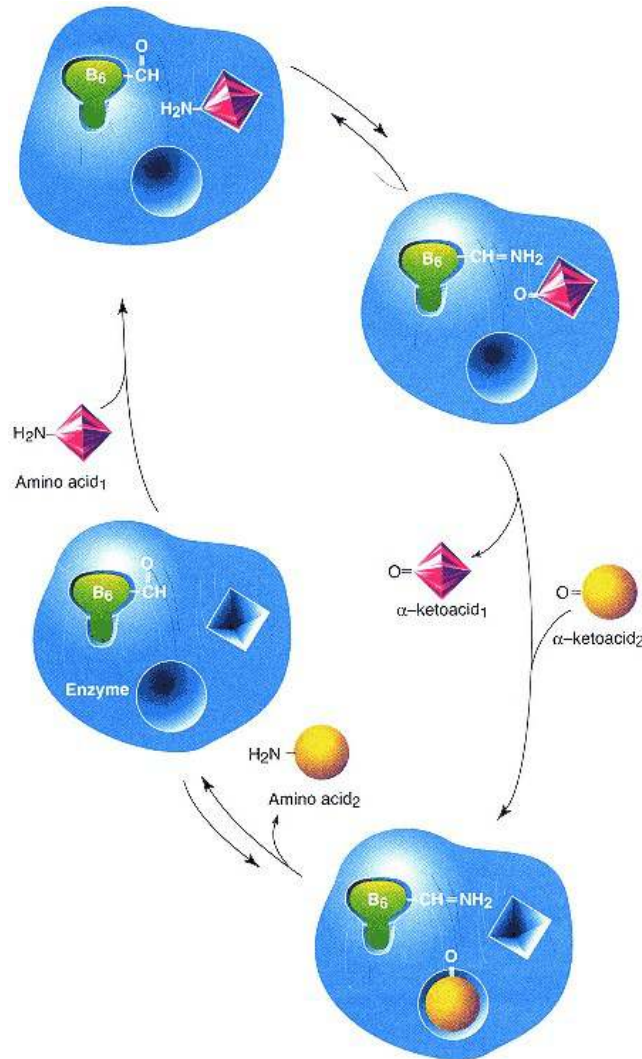

Figure 4.17

Schematic representation of the trans-aminase reaction mechanism: an example of a ping-pong mechanism.

Enzyme-bound pyridoxal phosphate (vitamin B_6 coenzyme) accepts the α -amino group from the first amino acid (AA_1), which is then released from the enzyme as an α -keto acid. The acceptor α -keto acid (AA_2) is then bound to the enzyme, and the bound amino group is transferred to it, forming a new amino acid, which is then released from the enzyme. The terms "oxy" and "keto" are used interchangeably.

CLINICAL CORRELATION 4.3

Mutation of a Coenzyme-Binding Site Results in Clinical Disease

Cystathioninuria is a genetic disease in which γ -cystathionase is either deficient or inactive. Cystathionase catalyzes the reaction:

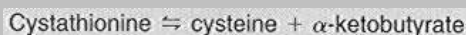

Deficiency of the enzyme leads to accumulation of cystathionine in the plasma. Since cystathionase is a pyridoxal phosphate-dependent enzyme, vitamin B₆ was administered to patients whose fibroblasts contained material that cross-reacted with antibody against cystathionase. Many responded to B₆ therapy with a fall in plasma levels of cystathionine. These patients produce the apoenzyme that reacted with the antibody. In one patient the enzyme activity was undetectable in fibroblast homogenates but increased to 31% of normal with the addition of 1 mM of pyridoxal phosphate to the assay mixture. It is thought that the K_m for pyridoxal phosphate binding to the enzyme was increased because of a mutation in the binding site. Activity is partially restored by increasing the concentration of coenzyme. Apparently these patients require a higher steady-state concentration of coenzyme to maintain γ -cystathionase activity.

Pascal, T. A., Gaull, G. E., Beratis, N. G., Gillam, B. M., Tallan, H. H., and Hirschhorn, K. Vitamin B₆-responsive and unresponsive cystathioninuria: two variant molecular forms. *Science* 190:1209, 1975.

In the **sequential mechanism**, if two substrates A and B can bind in any order, it is a random mechanism; if binding of A is required before B can be bound, then it is an ordered mechanism. In either case the reaction is bimolecular; that is, both A and B must be bound before reaction occurs. Examples of these mechanisms are found among the dehydrogenases in which the second substrate is a coenzyme (NAD⁺, FAD, etc.; see p. 143). Release of products may or may not be ordered in either mechanism.

4.4—

Coenzymes:

Structure and Function

Coenzymes are small organic molecules, often derivatives of vitamins, that function with the enzyme in the catalytic process. Often the coenzyme has an affinity for the enzyme that is similar to that of the substrate; consequently, the coenzyme can be considered to be a second substrate. In some cases, the coenzyme is covalently bound to the apoenzyme and functions at or near the active site in catalysis. In other enzymes the role of the coenzyme falls between these two extremes.

Several coenzymes are derived from the B vitamins. Vitamin B₆, pyridoxine, requires little modification to form the active coenzyme, pyridoxal phosphate (see p. 1121). Clinical Correlation 4.3 points out the importance of the coenzyme-binding site and how alterations in this site cause metabolic dysfunction.

In contrast to vitamin B₆, niacin requires major alteration in mammalian cells to form a coenzyme, as outlined in Section 12.9.

The structures and functions of the coenzymes of only two B vitamins, niacin and riboflavin, and of ATP are discussed in this chapter. The structures and functions of coenzyme A (CoA) (see p. 514), thiamine (see p. 1119), biotin, and vitamin B₁₂ are included in those chapters dealing with enzymes dependent on the given coenzyme for activity.

Adenosine Triphosphate May Be a Second Substrate or a Modulator of Activity

Adenosine triphosphate (ATP) often functions as a second substrate but can also serve as a cofactor in modulation of the activity of specific enzymes. This compound is central in biochemistry (Figure 4.18) and it is synthesized *de novo* in all mammalian cells. The nitrogenous heterocyclic ring is adenine. The combination of the base, adenine, plus ribose is known as adenosine; hence ATP is adenosine that has at the 5'-hydroxyl a triphosphate. The biochemically functional end is the reactive triphosphate. The terminal phosphate–oxygen bond has a high free energy of hydrolysis, which means that the phosphate can be transferred from ATP to other acceptor groups. For example, as a cosubstrate ATP is utilized by the kinases for the transfer of the terminal phosphate to various acceptors. A typical example is the reaction catalyzed by **glucokinase**:



ADP is adenosine diphosphate.

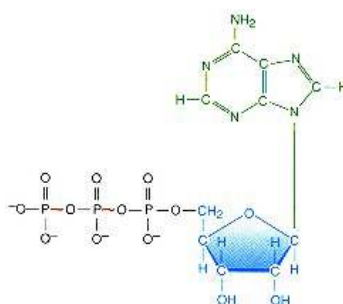

Figure 4.18
Adenosine triphosphate (ATP).

ATP also serves as a modulator of the activity of some enzymes. These enzymes have binding sites for ATP, occupancy of which changes the affinity or reactivity of the enzyme toward its substrates. In these cases, ATP acts as an **allosteric effector** (see p. 151).

NAD and NADP are Coenzyme Forms of Niacin

Niacin is pyridine-3-carboxylic acid. It is converted to two coenzymes involved in oxidoreductase reactions. They are **NAD (nicotinamide adenine dinucleo-**

ide) and **NADP (nicotinamide adenine dinucleotide phosphate)**. The abbreviations NAD and NADP are convenient to use when referring to the coenzymes regardless of their state of oxidation or reduction. NAD^+ and NADP^+ represent the oxidized forms, and NADH and NADPH represent the reduced forms. Some dehydrogenases are specific for NADP and others for NAD; some function with either coenzyme. This arrangement allows for specificity and control over dehydrogenases that reside in the same subcellular compartment.

NAD^+ consists of adenosine and *N*-ribose-nicotinamide linked by a pyrophosphate linkage between the 5'-OH groups of the two ribosyl moieties (Figure 4.19). NADP differs structurally from NAD in having an additional phosphate esterified to the 2'-OH group of the adenosine moiety. Both coenzymes function as intermediates in transfer of two electrons between an electron donor and an acceptor. The donor and acceptor need not be involved in the same metabolic pathway. Thus the reduced form of these nucleotides acts as a common "pool" of electrons that arise from many oxidative reactions and can be used for various reductive reactions.

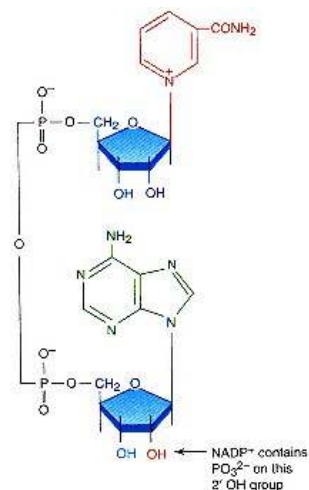

Figure 4.19
Nicotinamide adenine dinucleotide (NAD^+).

The adenine, ribose, and pyrophosphate components of NAD are involved in binding of NAD to the enzyme. Enzymes requiring NADP do not have a conserved aspartate residue present in the NAD-binding site. If the aspartate were present, a charge-charge interaction between the negatively charged aspartate and the 2'-phosphate of NADP would prevent binding. Since there is no negatively charged phosphate on the 2'-OH in NAD, there is discrimination between NAD and NADP binding. The nicotinamide reversibly accepts and donates two electrons at a time. It is the active center of the coenzyme. In oxidation of deuterated ethanol by alcohol dehydrogenase, NAD^+ accepts two electrons and the deuterium from the ethanol. The other hydrogen is released as a H^+ (Figure 4.20).

The binding of NAD^+ to the enzyme surface confers a chemically recognizable "top side" and "bottom side" to the planar nicotinamide. The former is known as the **A** face and the latter as the **B** face. In the case of alcohol dehydrogenase, the proton or deuterium ion that serves as a tracer is added to the **A** face. Other dehydrogenases utilize the **B** face. This particular effect demonstrates how enzymes can induce **stereospecificity** in chemical reactions by virtue of the asymmetric binding of coenzymes and substrates.

FMN and FAD Are Coenzyme Forms of Riboflavin

The two coenzyme forms of riboflavin are **FMN (flavin mononucleotide)** and **FAD (flavin adenine dinucleotide)**. The vitamin riboflavin consists of the heterocyclic ring, isoalloxazine (flavin) connected through N-10 to the alcohol ribitol (Figure 4.21). FMN has a phosphate esterified to the 5'-OH group of ribitol. FAD is structurally analogous to NAD in having adenosine linked by a pyrophosphate linkage to a heterocyclic ring, in this case riboflavin (Figure 4.22). Both FAD and FMN function in oxidoreduction reactions by accepting and donating $2e^-$ in the isoalloxazine ring. A typical example of FAD participation in an enzyme reaction is the oxidation of succinate to fumarate by succinate

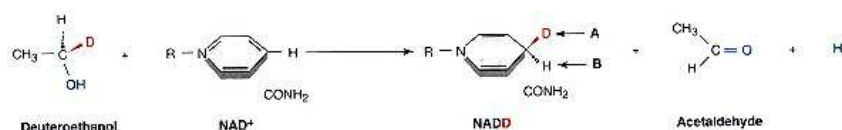

Figure 4.20
Stereo specific transfer of deuterium from deuterated ethanol to NAD^+ .

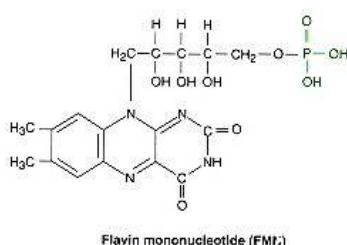
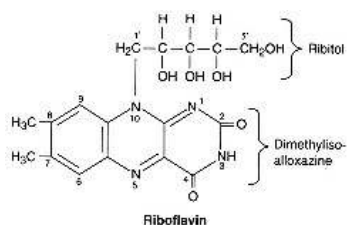

Figure 4.21
Riboflavin and flavin mononucleotide.

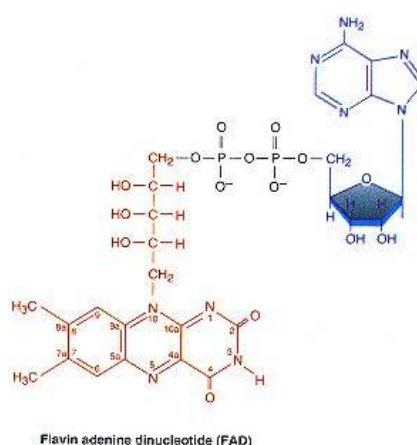
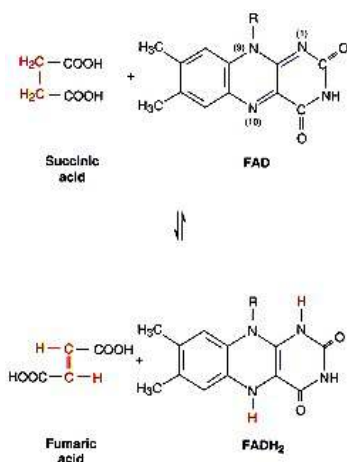

Figure 4.22
Flavin adenine dinucleotide (FAD).

dehydrogenase (see p. 236) (Figure 4.23). In some cases, these coenzymes are $1e^-$ acceptors, which lead to flavin semiquinone formation (a free radical).

Flavin coenzymes tend to be bound much tighter to their apoenzymes than the niacin coenzymes and often function as prosthetic groups rather than as cofactors.



Metal Cofactors Have Various Functions

Metals are not coenzymes in the same sense as FAD, FMN, NAD^+ , and $NADP^+$ but are required as cofactors in approximately two-thirds of all enzymes. Metals participate in enzyme reactions by acting as Lewis acids and by various modes of chelate formation. **Chelates** are organometallic coordination complexes. A good example of a chelate is the complex between iron and protoporphyrin IX to form a heme (see p. 115). Metals that act as Lewis acid catalysts are found among the transition metals like Zn, Fe, Mn, and Cu, which have empty d electron orbitals that act as electron sinks. The alkaline earth metals such as K and Na do not possess this ability. A good example of a metal functioning as a Lewis acid is found in **carbonic anhydrase**, a zinc enzyme that catalyzes the reaction

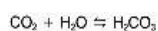

The first step (Figure 4.24) can be visualized as the *in situ* generation of a proton and a hydroxyl group from water binding to the zinc (Lewis acid function of zinc). The proton and hydroxyl group are then added to the carbon dioxide and carbonic acid is released. Actually, the reactions presented in sequence may occur in a concerted fashion, that is, all at one time.

Metals can also promote catalysis either by binding substrate and promoting electrophilic catalysis at the site of bond cleavage or by stabilizing intermediates in the reaction pathway. In the case of **carboxypeptidase** and **thermolysin**, **zinc proteases** with identical active sites, the zinc functions to generate a hydroxyl group from water, and then to stabilize the transition state resulting from attack of the hydroxyl on the peptide bond. Figure 4.25 depicts the generation of the active-site hydroxyl by zinc. As shown, Glu 270 functions as

a base in plucking the proton from water. Stabilization of the tetrahedral transition state by zinc is shown in Figure 4.26. The positive zinc provides a counterion to stabilize the negative oxygens on the tetrahedral carbon.

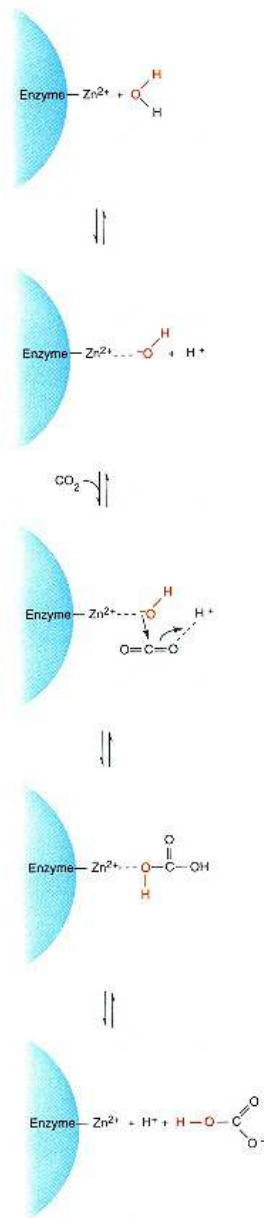

Figure 4.24
Zinc functions as a
Lewis acid in carbonic anhydrase.

Role of the Metal As a Structural Element

The function of a metal as a Lewis acid in carbonic anhydrase and carboxypeptidase requires chelate formation. Various modes of chelation occur between metal, enzyme, and substrate that are structural in nature, but in which no acid catalysis occurs.

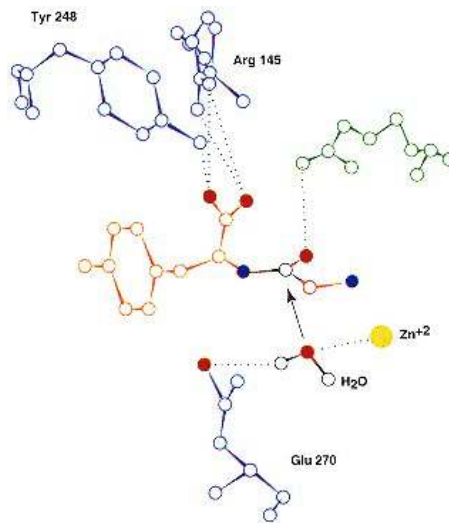

Figure 4.25
Zinc in the mechanism of reaction of carboxypeptidase A.
Enzyme-bound zinc generates a hydroxyl nucleophile from bound water, which attacks the carbonyl of the peptide bond as indicated by the arrows. Glu 270 assists by pulling the proton from the zinc-bound water.
Redrawn from Lipscomb, W. N. *Robert A. Welch Found. Conf. Chem. Res.* 15:140,1971.

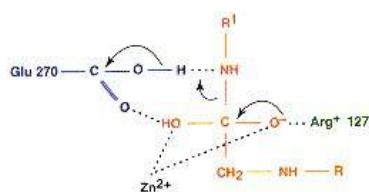

Figure 4.26
Stabilization of the transition state of the tetrahedral intermediate by zinc.
Positive charge on the zinc stabilizes the negative charge that develops on the oxygens of the tetrahedral carbon in the transition state. The tetrahedral intermediate then collapses as indicated by the arrows, resulting in breakage of the peptide bond.

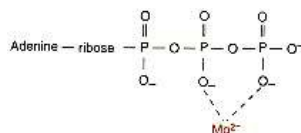

Figure 4.27
Mg²⁺-ATP.

In several kinases, creatine kinase being the best example, the true substrate is not ATP but Mg²⁺-ATP (Figure 4.27). In this case, Mg²⁺ does not interact directly with the enzyme. It may serve to neutralize the negative charge density on ATP and facilitate binding to the enzyme. Ternary complexes of this conformation are known as "substrate-bridged" complexes and can be schematically represented as Enz-S-M. A hypothetical scheme for the binding of Mg²⁺-ATP and glucose in the active site of hexokinase is presented in Figure 4.28. All kinases except muscle pyruvate kinase and phosphoenolpyruvate carboxykinase are substrate-bridged complexes. In pyruvate kinase, Mg²⁺ chelates ATP to the enzyme as shown in Figure 4.29. Absence of the metal cofactor results in failure of ATP to bind to the enzyme. Enzymes of this class are "metal-bridged" ternary complexes, Enz-S-M. All **metalloenzymes** are of this type and contain a tightly bound transition metal such as Zn²⁺ or Fe²⁺. Several enzymes that catalyze enolization and elimination reactions are metal-bridged complexes.

In addition to the role of binding enzyme and substrate, metals may also bind directly to the enzyme to stabilize it in the active conformation or perhaps to induce the formation of a binding site or active site. Not only do the strongly chelated metals like Mn²⁺ play a role in this regard, but the weakly bound alkali metals (Na⁺ or K⁺) are also important. In **pyruvate kinase**, K⁺ induces an initial conformational change, which is necessary, but not sufficient, for ternary complex formation. Upon substrate binding, K⁺ induces a second conformational change to the catalytically active ternary complex as indicated in Figure 4.29. Thus Na⁺ and K⁺ stabilize the active conformation of the enzyme but are passive in catalysis.

Role of Metals in Oxidation and Reduction

Iron-sulfur proteins, often referred to as nonheme iron proteins, are a unique class of metalloenzymes in which the active center consists of one or more clusters of sulfur-bridged iron chelates. The structures are presented on page 252. In some cases the sulfur comes only from cysteine and in others from both cysteine and free ionic sulfur. The free sulfur is released as hydrogen

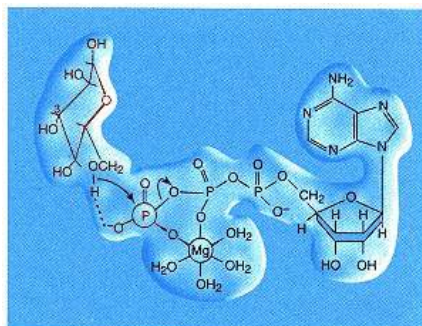

Figure 4.28
Role of Mg²⁺ as a substrate-bridged complex in the active site of the kinases.

In hexokinase the terminal phosphate of ATP is transferred to glucose, yielding glucose 6-phosphate. Mg²⁺ coordinates with the ATP to form the true substrate and in addition may stabilize the terminal P-O bond of ATP to facilitate transfer of the phosphate to glucose. There are specific binding sites (light blue) on the enzyme (darker blue) for glucose (upper left) in red as well as the adenine and ribose moieties of ATP (black).

sulfide upon acidification. These nonheme iron enzymes have reasonably low reducing potentials (E'_0) and function in electron-transfer reactions (see p. 251).

Cytochromes are heme iron proteins that function as cosubstrates for their respective reductases (see p. 252). Iron in hemes of cytochromes undergoes reversible $1e^-$ transfers. Heme is bound to the apoprotein by coordination of an amino acid side chain to iron of heme. Thus the metal serves not only a structural role but also participates in the chemical event.

Metals, specifically copper and iron, also have a role in activation of molecular oxygen. Copper is an active participant in several oxidases and hydroxylases. For example, **dopamine β -hydroxylase** catalyzes the introduction of one oxygen atom from O_2 into dopamine to form norepinephrine (Figure 4.30). The active enzyme contains one atom of cuprous ion that reacts with oxygen to form an activated oxygen–copper complex. The copper–hydroperoxide complex shown in Figure 4.30 is thought to be converted to a copper(II)– O^- species that serves as the "active oxygen" in the hydroxylation of DOPA. In other metalloenzymes other species of "active oxygen" are generated and used for hydroxylation.

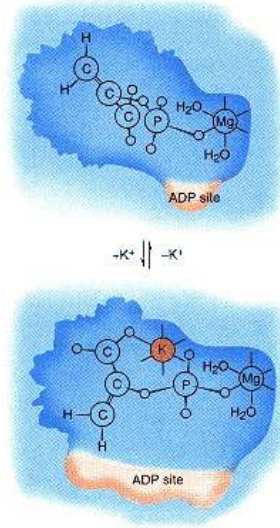

Figure 4.29

Model of the role of K^+ in the active site of pyruvate kinase.

Pyruvate kinase

catalyzes the reaction:

phosphoenolpyruvate + ADP

ATP + pyruvate. Initial binding of K^+ induces conformational changes in the kinase, which result in increased affinity for phosphoenolpyruvate. In addition, K^+ orients the phosphoenolpyruvate in the correct position for transfer of its phosphate to ADP, the second substrate.

Mg^{2+} coordinates the substrate to the enzyme active site.

Modified with

permission from Mildvan, A. *S. Annu. Rev. Biochem.* 43:365, 1974.

Copyright © 1974 by Annual Reviews, Inc.

4.5—

Inhibition of Enzymes

Mention was made of product inhibition of enzyme activity and how an entire pathway can be controlled or modulated by this mechanism (see p. 140). In addition to inhibition by the immediate product, products of other enzymes can also inhibit or activate a particular enzyme. Much of current drug therapy is based on inhibition of specific enzymes by a substrate analog.

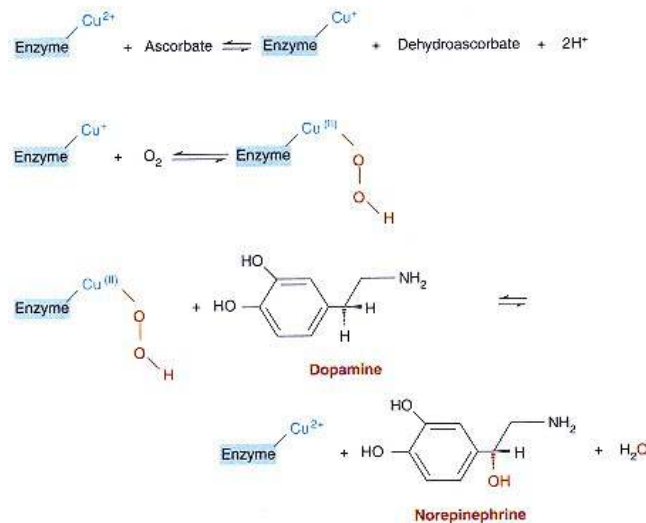

Figure 4.30

Role of copper in activation of molecular oxygen by dopamine hydroxylase.

The normal cupric form of the enzyme is not reactive with oxygen but on reduction by the cosubstrate, ascorbate, generates a reactive enzyme–copper bound oxygen radical that then reacts with dopamine to form norepinephrine and an inactive cupric enzyme.

There are three major classes of inhibitors: competitive, noncompetitive, and uncompetitive.

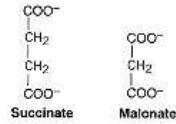

Figure 4.31
Substrate and inhibitor of succinate dehydrogenase.

Competitive Inhibition May Be Reversed by Increased Substrate

Competitive inhibitors are inhibitors whose action can be reversed by increasing amounts of substrate. Competitive inhibitors are structurally similar to the substrate and bind at the substrate-binding site, thus competing with the substrate for the enzyme. Once bound, the enzyme cannot convert the inhibitor to products. Increasing substrate concentrations will displace the reversibly bound inhibitor by the law of mass action. For example, in the **succinate dehydrogenase** reaction, malonate is structurally similar to succinate and is a competitive inhibitor (Figure 4.31).

Since substrate and inhibitor compete for the same binding site, the K_m for the substrate shows an apparent increase in the presence of inhibitor. This can be seen in a double-reciprocal plot as a shift in the x -intercept ($-1/K_m$) and in the slope of the line (K_m/V_{max}). If we first establish the velocity at several levels of substrate and then repeat the experiment with a given but constant amount of inhibitor at various substrate levels, two different straight lines will be obtained (Figure 4.32). V_{max} does not change; hence the intercept on the y -axis remains the same. In the presence of inhibitor, the x -intercept is no longer the negative reciprocal of the true K_m , but of an apparent value, $K_{m,app}$ where

$$K_{m,app} = K_m \cdot \left(1 + \frac{[I]}{K_i} \right)$$

Thus the inhibitor constant, K_i , can be determined from the concentration of inhibitor used and the K_m , which was obtained from the x -intercept of the line obtained in the absence of inhibitor.

Noncompetitive Inhibitors Do Not Prevent Substrate from Binding

A **noncompetitive inhibitor** binds at a site other than the substrate-binding site. Inhibition is not reversed by increasing concentration of substrate. Both binary (EI) and ternary (EIS) complexes form, which are catalytically inactive

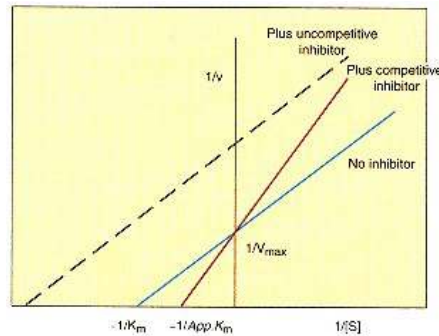

Figure 4.32
Double-reciprocal plots for competitive and uncompetitive inhibition.
A competitive inhibitor binds at the substrate-binding site and effectively increases the K_m for the substrate. An uncompetitive inhibitor causes an equivalent shift in both V_{max} and K_m , resulting in a line parallel to that given by the uninhibited enzyme.

and are therefore dead-end complexes. A noncompetitive inhibitor behaves as though it were removing active enzyme from the solution, resulting in a decrease in V_{\max} . This is seen graphically in the double-reciprocal plot (Figure 4.33), where K_m does not change but V_{\max} does change. Inhibition can often be reversed by exhaustive dialysis of the inhibited enzyme provided that the inhibitor has not reacted covalently with the enzyme as discussed under irreversible inhibitors.

An **uncompetitive inhibitor** binds only with the ES form of the enzyme in the case of a one-substrate enzyme. The result is an apparent equivalent change in K_m and V_{\max} , which is reflected in the double-reciprocal plot as a line parallel to that of the uninhibited enzyme (Figure 4.32). In the case of multisubstrate enzymes the interpretation is complex and will not be considered further.

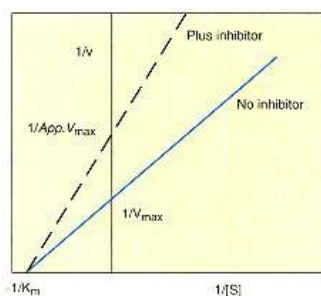

Figure 4.33
Double-reciprocal plot for an enzyme subject to reversible noncompetitive inhibition.
 A noncompetitive inhibitor binds at a site other than the substrate-binding site; therefore the effective K_m does not change, but the apparent V_{\max} decreases.

Irreversible Inhibition Involves Covalent Modification of an Enzyme Site

When covalent modification occurs at the binding site or the active site, inhibition will not be reversed by dialysis unless the linkage is chemically labile like that of an ester or thioester. The active-site thiol group in glyceraldehyde-3-phosphate dehydrogenase reacts with ***p*-chloromercuribenzoate** to form a mercuribenzoate adduct of the enzyme (Figure 4.34). Such adducts are not reversed by dialysis or by addition of substrate. Double-reciprocal plots show the characteristic pattern for noncompetitive inhibition (Figure 4.33).

Many Drugs Are Enzyme Inhibitors

Most modern drug therapy is based on the concepts of enzyme inhibition that were described in the previous section. Drugs are designed to inhibit a specific enzyme in a metabolic pathway. This application is most easily appreciated with antiviral, antibacterial, and antitumor drugs that are administered to the patient under conditions of limited toxicity. Such toxicity is often unavoidable because, with the exception of cell wall biosynthesis in bacteria, there are few critical metabolic pathways that are unique to tumors, viruses, or bacteria. Hence drugs that kill these organisms will often kill host cells. The one characteristic that can be taken advantage of is the comparatively short generation time of the undesirable organisms. They are much more sensitive to antimetabolites and in particular those that inhibit enzymes involved in replication. Antimetabolites are compounds with some structural difference from the natural substrate. In subsequent chapters, numerous examples of **antimetabolites** will be described. Here we will present a few examples that illustrate the concept.

Sulfa Drugs

Modern chemotherapy had its beginning in compounds of the general formula $R-SO_2-NHR$. Sulfanilamide, the simplest member of the class, is an antibacterial agent because of its competition with ***p*-aminobenzoic acid (PABA)**, which

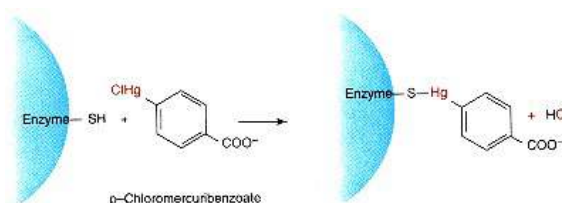

Figure 4.34
 Enzyme inhibition by a covalent modification of an active center cysteine.

is required for bacterial growth. Structures of these compounds are shown in Figure 4.35.

Bacteria cannot absorb folic acid, a required vitamin for the host, but must synthesize it. Since sulfanilamide is a structural analog of *p*-aminobenzoate, the bacterial dihydropteroate synthetase is tricked into making an intermediate, containing sulfanilamide, that cannot be converted to folate. Figure 4.36*b* shows the fully reduced or coenzyme form of folate. Thus the bacterium is starved of the required folate and cannot grow or divide. Since humans require folate from dietary sources, the sulfanilamide is not harmful at the doses that kill bacteria.

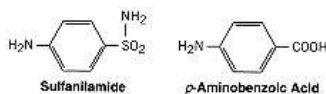

Figure 4.35
Structure of *p*-aminobenzoic acid and sulfanilamide, a competitive inhibitor.

Methotrexate

Biosynthesis of purines and pyrimidines, heterocyclic bases required for synthesis of RNA and DNA, requires folic acid, which serves as a coenzyme in transfer of one-carbon units from various amino acid donors (see p. 460). Methotrexate (Figure 4.36*a*), a structural analog of folate, has been used with great success in childhood leukemia. Its mechanism of action is based on competition with dihydrofolate for dihydrofolate reductase. It binds 1000-fold more strongly than the natural substrate and is a powerful competitive inhibitor of the enzyme. The synthesis of thymidine monophosphate stops in the presence of methotrexate because of failure of the one-carbon transfer reaction. Since cell division depends on thymidine monophosphate as well as the other nucleotides, the leukemia cell cannot multiply. One problem is that rapidly dividing human cells such as those in bone marrow and intestinal mucosa are sensitive to the drug for the same reasons. Also, prolonged usage leads to amplification of the gene for dihydrofolate reductase, with increased levels of the enzyme and preferential growth of methotrexate-resistant cells.

Neoclassical Antimetabolites

A nonclassical antimetabolite is a substrate for an enzyme that upon action of the enzyme generates a highly reactive species. This species forms a covalent adduct with an amino acid at the active site, leading to irreversible inactivation of the enzyme. These inhibitors are referred to as suicide substrates and are very specific. Another group of inhibitors contains a reactive functional group. For example, the compound shown in Figure 4.37 is an irreversible inhibitor of **dihydrofolate reductase** because it is specifically bound at the active site and the reactive benzylsulfonyl fluoride is positioned to react with a serine hydroxyl group in the substrate-binding site. Covalent binding of this substrate analog to the enzyme prevents binding of the normal substrate and inhibits the enzyme.

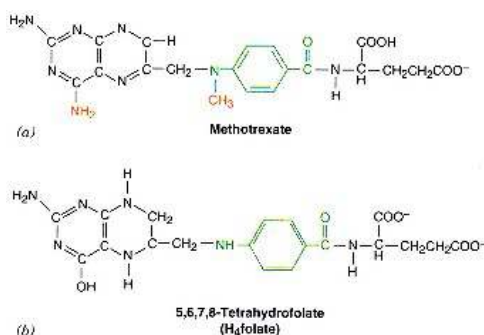

Figure 4.36
Methotrexate
(4-amino- N^{10} -methyl folic acid) and tetrahydrofolic acid.
Contribution from *p*-aminobenzoate is shown in green.

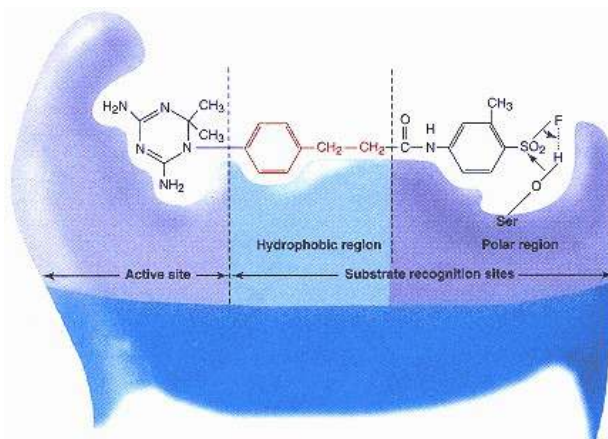

Figure 4.37

Site-directed inactivation of tetrahydrofolate reductase.

The irreversible inhibitor, a substituted dihydrotriazine, structurally resembles dihydrofolate and binds specifically to the dihydrofolate site on dihydrofolate reductase. The triazine portion of the inhibitor resembles the pterin moiety and therefore binds to the active site. The ethylbenzene group (in red) binds to the hydrophobic site normally occupied by the p-aminobenzoyl group. The reactive end of the inhibitor contains a reactive sulfonyl fluoride that forms a covalent linkage with a serine hydroxyl on the enzyme surface. Thus this inhibitor irreversibly inhibits the enzyme by blocking access of dihydrofolate to the active site.

Other Antimetabolites

Two other analogs of the purines and pyrimidines will be mentioned to emphasize the structural similarity of chemotherapeutic agents to normal substrates.

Fluorouracil (Figure 4.38) is a thymine analog in which the ring-bound methyl is substituted by fluorine. The deoxynucleotide of this compound is an irreversible inhibitor of thymidylate synthetase. **6-Mercaptopurine** (Figure 4.38) is an analog of hypoxanthine, adenine, and guanine, which is converted to the 6-mercaptopurine nucleotide in cells. This nucleotide is a broad spectrum antimetabolite because of its competition in reactions involving adenine and guanine nucleotides. The antimetabolites discussed relate to purine and pyrimidine metabolism but the general concepts can be applied to any enzyme or metabolic pathway.

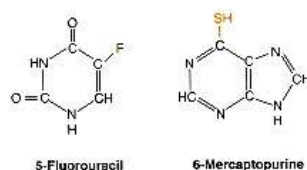

Figure 4.38

Structures of two antimetabolites.

4.6—**Allosteric Control of Enzyme Activity**

Allosteric Effectors Bind at Sites Different from Substrate-Binding Sites

Although the substrate-binding and active site of an enzyme are well-defined structures, the activity of many enzymes can be modulated by ligands acting in ways other than as competitive or noncompetitive inhibitors. A **ligand** is any molecule that is bound to a macromolecule; the term is not limited to small organic molecules, such as ATP, but includes low molecular weight proteins. Ligands can be activators, inhibitors, or even the substrates of enzymes. Those ligands that change enzymatic activity, but are unchanged as a result of enzyme action, are referred to as effectors, modifiers, or modulators. Most of the enzymes subject to modulation by ligands are rate-determining enzymes in metabolic pathways. To appreciate the mechanisms by which metabolic pathways are controlled, the principles governing the allosteric and cooperative behavior of individual enzymes must be understood.

Enzymes that respond to modulators have additional site(s) known as **allosteric site(s)**. Allosteric is derived from the Greek root *allo*, meaning "the other." An allosteric site is a unique region of the enzyme quite different from the substrate-binding site. The existence of allosteric sites is illustrated in Clin. Corr. 4.4. The ligands that bind at the allosteric site are called allosteric effectors

or modulators. Binding of an allosteric effector causes a conformational change of the enzyme so that the affinity for the substrate or other ligands also changes. Positive (+) allosteric effectors increase the enzyme affinity for substrate or other ligand. The reverse is true for negative (—) allosteric effectors. The allosteric site at which the positive effector binds is referred to as an activator site; the negative effector binds at an inhibitory site.

CLINICAL CORRELATION 4.4

A Case of Gout Demonstrates the Difference Between an Allosteric and Substrate-Binding Site

The realization that allosteric inhibitory sites are separate from allosteric activator sites as well as from the substrate-binding and the catalytic sites is illustrated by a study of a gouty patient whose red blood cell PRPP level was increased (see Clin. Corr. 4.1). It was found that the patient's PRPP synthetase had normal K_m and V_{max} values, and sensitivity to activation by phosphate. The increased PRPP levels and hyperuricemia arose because the end products of the pathway (ATP, GTP) were not able to inhibit the synthetase through the allosteric inhibitory site (I). It was suggested that a mutation in the inhibitory site or in the coupling mechanism between the inhibitory and catalytic site led to failure of the feedback control mechanism.

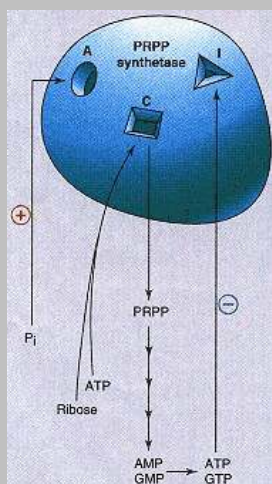

Sperling, O., Perksy-Brosh, S., Boen, P., and DeVries, A. Human erythrocyte phosphoribosyl-pyrophosphate synthetase mutationally altered in regulatory properties. *Biochem. Med.* 7: 389, 1973.

Allosteric enzymes are divided into two classes based on the effect of the allosteric effector on the K_m and V_{max} . In the **K class** the effector alters the K_m but not V_{max} , whereas in the **V class** the effector alters V_{max} but not K_m . K class enzymes give double-reciprocal plots like those of competitive inhibitors (Figure 4.32) and V class enzymes give double-reciprocal plots like those of noncompetitive inhibitors (Figure 4.33). The terms competitive and noncompetitive are inappropriate for allosteric enzyme systems because the mechanism of the effect of an allosteric inhibitor on a V or K enzyme is different from that of a simple competitive or noncompetitive inhibitor. For example, in the K class, the negative effector binding at an allosteric site affects the affinity of the substrate-binding site for the substrate, whereas in simple competitive inhibition the inhibitor competes directly with substrate for the site. In V class enzymes, positive and negative allosteric modifiers increase or decrease the rate of breakdown of the ES complex to products. The catalytic rate constant, k_3 , is affected and not the substrate-binding constant. There are a few enzymes in which both K_m and V_{max} are affected.

In theory, a monomeric enzyme can undergo an allosteric transition in response to a modulating ligand. In practice, only two monomeric allosteric enzymes are known, ribonucleoside diphosphate reductase and pyruvate-UDP-*N*-acetylglucosamine transferase. Most allosteric enzymes are **oligomeric**; that is, they consist of several subunits. Identical subunits are designated as **protomers**, and each protomer may consist of one or more polypeptide chains. As a consequence of the oligomeric nature of allosteric enzymes, binding of ligand to one protomer can affect the binding of ligands on the other protomers in the oligomer. Such ligand effects are referred to as **homotropic** interactions. Transmission of the homotropic effects between protomers is one aspect of cooperativity, considered later. Substrate influencing substrate, activator influencing activator, or inhibitor influencing inhibitor binding are homotropic interactions. Homotropic interactions are almost always positive.

A **heterotropic** interaction is the effect of one ligand on the binding of a different ligand. For example, the effect of a negative effector on the binding of substrate or on binding of an allosteric activator are heterotropic interactions. Heterotropic interactions can be positive or negative and can occur in monomeric allosteric enzymes. Heterotropic and homotropic effects in oligomeric enzymes are mediated by cooperativity between subunits.

Based on the foregoing descriptions of allosteric enzymes, two models are pictured in Figure 4.39. In (a) a monomeric enzyme is shown, and in panel (b) an oligomeric enzyme consisting of two protomers is visualized. In both models heterotropic interactions can occur between the activator and substrate sites. In model (b), homotropic interactions can occur between the activator sites or between the substrate sites.

Allosteric Enzymes Exhibit Sigmoidal Kinetics

As a consequence of interaction between substrate site, activator site, and inhibitor site, a characteristic sigmoid or S-shaped curve is obtained in $[S]$ versus v_0 plots of allosteric enzymes, as shown in Figure 4.40 (curve A). Negative allosteric effectors move the curve toward higher substrate concentrations and enhance the sigmoidicity of the curve. If we use $1/2v_{max}$ as a guideline, Figure 4.40 shows that a higher concentration of substrate would be required to achieve $1/2v_{max}$ in the presence of a negative effector (curve C) than required in the absence

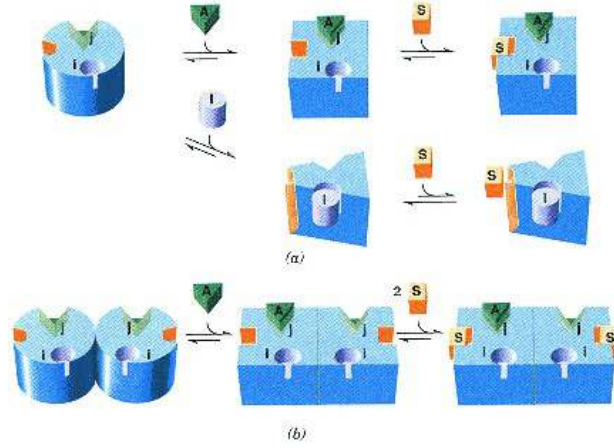

Figure 4.39

Models of allosteric enzyme systems.

(a) Model of a monomeric enzyme. Binding of a positive allosteric effector, A (green), to the activator site, j, induces a new conformation to the enzyme, one that has a greater affinity for the substrate. Binding of a negative allosteric effector (purple) to the inhibitor site, i, results in an enzyme conformation having a decreased affinity for substrate (orange).

(b) A model of a polymeric allosteric enzyme.

Binding of the positive allosteric effector, A, at the j site causes an allosteric change in the conformation of the protomer to which the effector binds. This change in the conformation is transmitted to the second protomer through cooperative protomer–protomer interactions. The affinity for the substrate is increased in both protomers. A negative effector decreases the affinity for substrate of both protomers.

of negative effector (curve A). In the presence of a positive modulator (curve B), $1/2v_{max}$ can be reached at a lower substrate concentration than is required in the absence of the positive modulator (curve A). Positive modulators shift the v_0 versus [S] plots toward the hyperbolic plots observed in Michaelis–Menten kinetics.

The rates of allosteric-controlled enzymes can be finely controlled by small fluctuations in the level of substrate; often the *in vivo* concentration of substrate corresponds with the sharply rising segment of the sigmoid v_0 versus [S] plot; thus large changes in enzyme activity are effected by small changes in substrate concentration (see Figure 4.40). It is also possible to "turn an enzyme off" with small amounts of a negative allosteric effector by having the apparent K_m shifted to values well above the *in vivo* level of substrate. Note that at a given *in vivo* concentration of substrate the initial velocity, v_0 , is decreased in the presence of a negative effector (compare curves A and C).

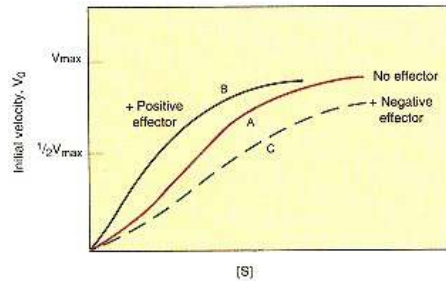

Figure 4.40

Kinetic profile of a K class allosteric enzyme.

The enzyme shows sigmoid v_0 versus [S] plots. Negative effectors shift the curve to the right, resulting in an increase in K_m . Positive effectors shift the curve to the left and effectively lower the apparent K_m . The V_{max} is not changed.

Cooperativity Explains Interaction between Ligand Sites in an Oligomeric Protein

Since allosteric enzymes are usually oligomeric with sigmoid $[S]$ versus v_0 plots, the concept of cooperativity was proposed to explain the interaction between ligand sites in oligomeric enzymes. **Cooperativity** is the influence that the binding of a ligand to one protomer has on the binding of ligand to another protomer in an oligomeric protein. It should be emphasized that kinetic mechanisms other than cooperativity can also produce sigmoid v_0 versus $[S]$ plots; consequently, sigmoidicity is not diagnostic of cooperativity in a v_0 versus $[S]$ plot. The relationship between allosterism and cooperativity has frequently been confused. Conformational change occurring in a given protomer in response to ligand binding at an allosteric site is an allosteric effect. Cooperativity generally involves a change in conformation of an effector-bound protomer that in turn transforms an adjacent protomer into a new conformation with an altered affinity for the effector ligand or for a second ligand. The conformation change may be induced by an allosteric effector or it may be induced by substrate, as it is in the case of hemoglobin where the oxygen-binding site on each protomer corresponds to the substrate site on an enzyme rather than to an allosteric site. Therefore the oxygen-induced conformational change in the hemoglobin protomers is technically not an allosteric effect, although some authors describe it as such. It is a homotropic cooperative interaction. Those who consider the oxygen-induced changes in hemoglobin to be "allosteric" are using the term in a much broader sense than the original definition allows; however, "allosteric" is now used by many to describe any ligand-induced change in the tertiary structure of a protomer.

An allosteric effect can occur in the absence of any cooperativity. For example, in **alcohol dehydrogenase**, conformational changes occur independently in each of the protomers upon the addition of positive allosteric effectors. The active site of each protomer is completely independent of the other and there is no cooperativity between protomers; that is, induced conformational changes in one protomer are not transmitted to adjacent protomers.

To describe experimentally observed ligand saturation curves mathematically, several models of cooperativity have been proposed. The two most prominent are the concerted model and the sequential induced-fit model. Although the **concerted model** is rather restrictive, most of the nomenclature associated with allosterism and cooperativity arose from it. The model proposes that the enzyme exists in only two states, the T (tense or taut) and the R (relaxed) (Figure 4.41*a*). The T and R states are in equilibrium. Activators and substrates favor the R state and shift the preexisting equilibrium toward the R state by the law of mass action. Inhibitors favor the T state. A conformational change in one protomer causes a corresponding change in all protomers. No hybrid states occur. Although this model accounts for the kinetic behavior of many enzymes, it cannot account for negative cooperativity.

The **sequential induced-fit model** proposes that ligand binding induces a conformational change in a protomer. A corresponding conformational change is then partially induced in an adjacent protomer contiguous with the protomer containing the bound ligand. The effect of ligand binding is sequentially transmitted through the oligomer, producing increased or decreased affinity for the ligand by contiguous protomers (Figure 4.41*b*). In this model numerous hybrid states occur, giving rise to cooperativity and sigmoid $[S]$ versus v_0 plots. Both positive and negative cooperativity can be accommodated by the model. A positive modulator induces a conformation in the protomer, which has an increased affinity for the substrate. A negative modulator induces a different conformation in the protomer, one that has a decreased affinity for substrate. Both effects are cooperatively transmitted to adjacent protomers. For the V class enzymes the effect is on the catalytic event (k_3) rather than on K_m .

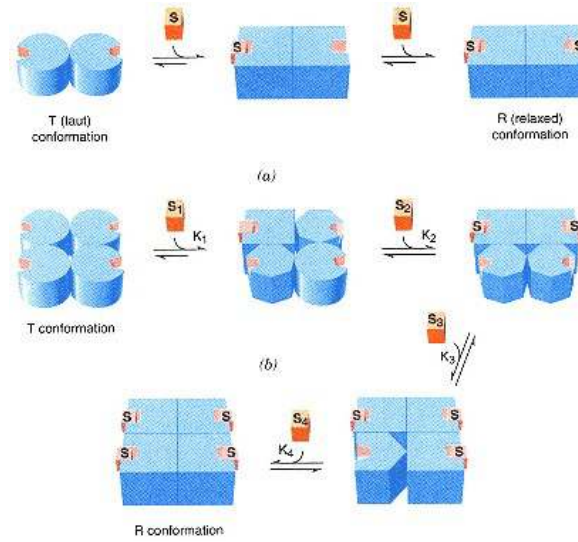

Figure 4.41

Models of cooperativity.

(a) The concerted model. The enzyme exists in only two states, the T (tense or taut) and R (relaxed) conformations. Substrates and activators have a greater affinity for the R state and inhibitors for the T state. Ligands shift the equilibrium between the T and R states.

(b) The sequential induced-fit model. Binding of a ligand to any one subunit induces a conformational change in that subunit. This conformational change is transmitted partially to adjoining subunits through subunit–subunit interaction. Thus the effect of the first ligand bound is transmitted cooperatively and sequentially to the other subunits (protomers) in the oligomer, resulting in a sequential increase or decrease in ligand affinity of the other protomers. The cooperativity may be either positive or negative, depending on the ligand.

Regulatory Subunits Modulate the Activity of Catalytic Subunits

In the foregoing an allosteric site was considered to reside on the same protomer as the catalytic site and all protomers were considered to be identical. In several very important enzymes a distinct regulatory protomer exists. These **regulatory subunits** have no catalytic function, but their binding with the catalytic protomer modulates the activity of the catalytic subunit through an induced conformational change. One strategy for regulation by regulatory subunits is outlined in Figure 4.42 for the **protein kinase A (PKA)** complex. Each regulatory subunit (R) has a segment of its primary sequence that is a pseudosubstrate for the catalytic subunit (C). In the absence of cAMP, the R subunit binds to the C subunit at its active site through the pseudosubstrate sequence, which inhibits the protein kinase activity. When cellular cAMP levels rise, cAMP binds to a site on the R subunits, causing a conformational change. This removes the pseudosubstrate sequence from the active site of the C subunit. The C subunits are released and can accept other protein substrates containing the pseudosubstrate sequence.

Calmodulin, a 17-kDa Ca^{2+} -binding protein, is a regulatory subunit for enzymes using Ca^{2+} as a modulator of their activity. Binding of calcium to calmodulin induces a conformational change in calmodulin allowing it to bind to the Ca^{2+} -dependent enzyme. This binding induces a conformational change in the enzyme, restoring enzymatic activity.

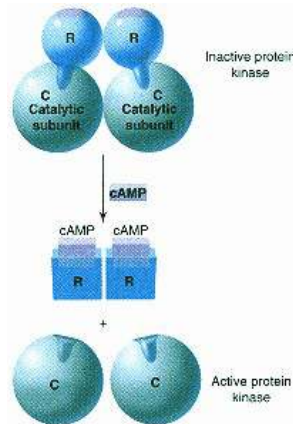

Figure 4.42

Model of allosteric enzyme with separate catalytic (C) and regulatory (R) subunits.

The regulatory subunit of protein kinase A contains a pseudosubstrate region in its primary sequence that binds to the substrate site of the catalytic subunit. In the presence of cAMP the conformation of the R subunit changes so that the pseudosubstrate region can no longer bind, resulting in release of active C subunits.

4.7—

**Enzyme Specificity:
The Active Site**

Enzymes are the most specific catalysts known, as regards the substrate and the type of reaction undergone by substrate. Specificity resides in the **substrate-binding site** on the enzyme surface. The tertiary structure of the enzyme is folded in such a way as to create a region that has the correct molecular dimensions, the appropriate topology, and the optimal alignment of counter-

ionic groups and hydrophobic regions to accommodate a specific substrate. The tolerances in the active site are so small that usually only one isomer of a diastereomeric pair will bind. For example, D-amino acid oxidase will bind only D-amino acids but not L-amino acids. Some enzymes show absolute specificity for substrate. Others have broader specificity and will accept several different analogs of a specific substrate. For example, hexokinase catalyzes the phosphorylation of glucose, mannose, fructose, glucosamine, and 2-deoxyglucose, but at different rates. Glucokinase, on the other hand, is specific for glucose.

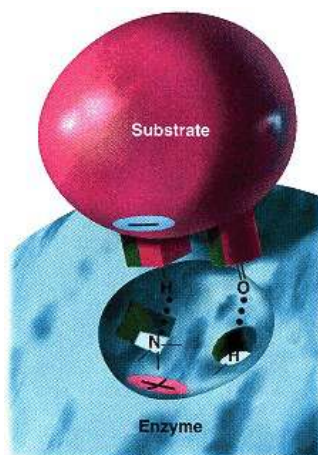

Figure 4.43

Lock-and-key model of the enzyme-binding site.

The enzyme contains a negative impression of the molecular features of the substrate, thus allowing specificity of the enzyme for a particular substrate. Specific ion pair formation can contribute to recognition of the substrate.

The specificity of the reaction rests in the active site and the amino acids that participate in the bond-making and bond-breaking phase of catalysis (see Section 4.8).

Complementarity of Substrate and Enzyme Explains Substrate Specificity

Various models have been proposed to explain the substrate specificity of enzymes. The first proposal was the **"lock-and-key" model** (Figure 4.43), in which a negative impression of the substrate is considered to exist on the enzyme surface. Substrate fits in this binding site just as a key fits into the proper lock or a hand into the proper sized glove. Hydrogen and ionic bonding and hydrophobic interactions contribute in binding substrate to the binding site. This model gives a rigid picture of the enzyme and cannot account for the effects of allosteric ligands.

A more flexible model of the binding site is provided by the **induced fit model** in which the binding and active sites are not fully preformed. The essential elements of the binding site are present to the extent that the correct substrate can position itself properly. Interaction of substrate with enzyme induces a conformational change in the enzyme, resulting in the formation of a stronger binding site and the repositioning of the appropriate amino acids to form the active site. There is excellent X-ray evidence for this model with carboxypeptidase A. A schematic of the induced-fit model is shown in Figure 4.44a. Figure 4.45 shows a significant movement of the lower lobe of **hexokinase** on binding glucose. The hexokinase essentially closes around the glucose to bring the active-site residues into proximity with the glucose.

Induced fit combined with **substrate strain** accounts for more experimental observations concerning enzyme action than other models. In this model (Figure 4.44b), substrate is "strained" toward product formation by an induced conformational transition of the enzyme.

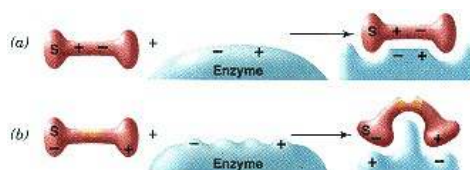

Figure 4.44

Models for induced fit and substrate strain.

(a) Approach of substrate to the enzyme induces the formation of the active site.

(b) Substrate strain, induced by substrate binding to the enzyme, contorts normal bond angles and "activates" the substrate.

Reprinted with permission from Koshland,
D. *Annu. Rev. Biochem.* 37:374, 1968.
Copyright © 1968 by Annual Reviews, Inc.

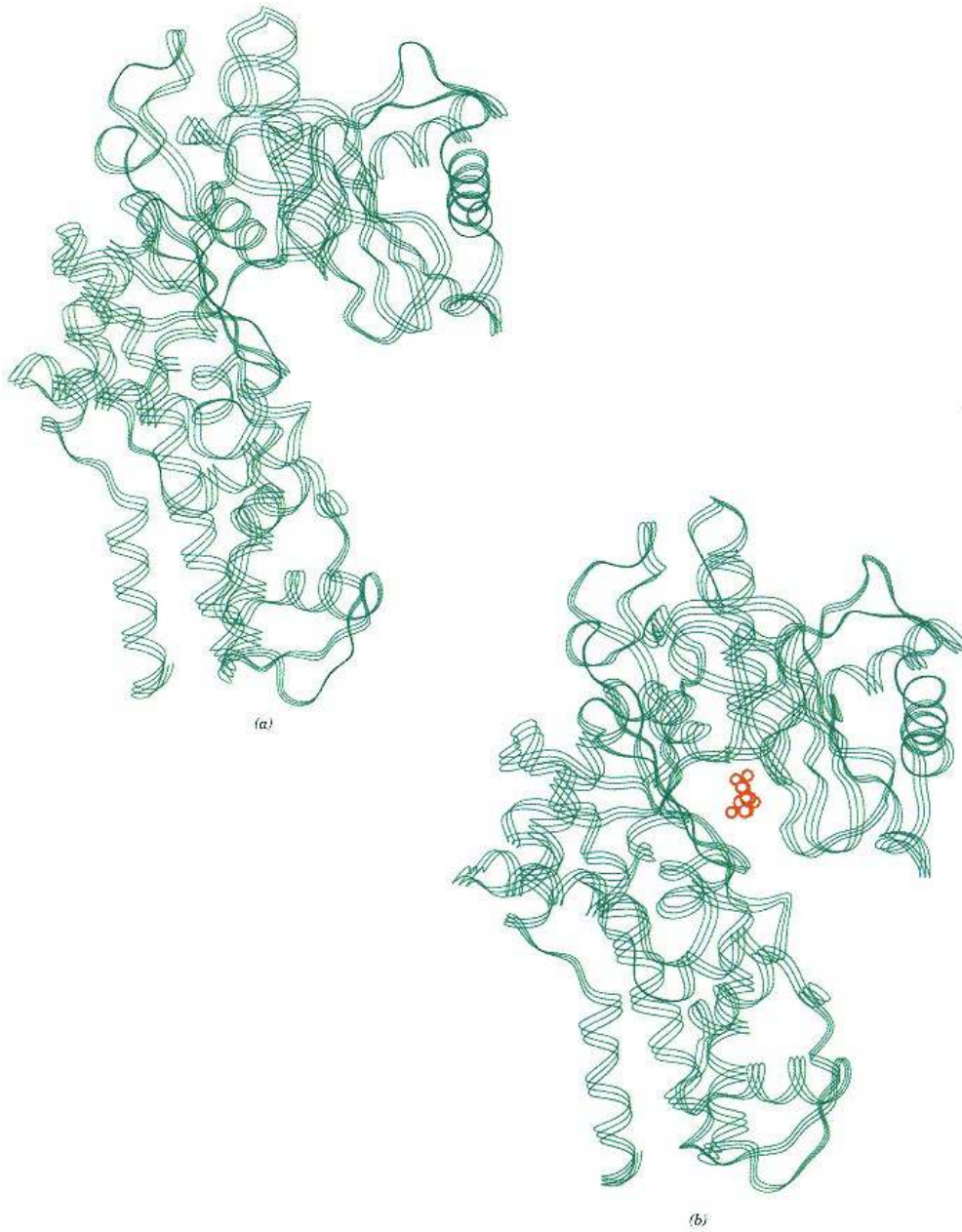

Figure 4.45

Glucose induced conformational change of hexokinase.

(a) Hexokinase minus glucose.

(b) Hexokinase with glucose. The three-cord ribbon traces the peptide backbone of hexokinase.

Drawn from PDB files 1HKG and 2YHX; Bennett, W. S. Jr., and Steitz, T. A. *J. Mol. Biol.* 140: 211, 1980.

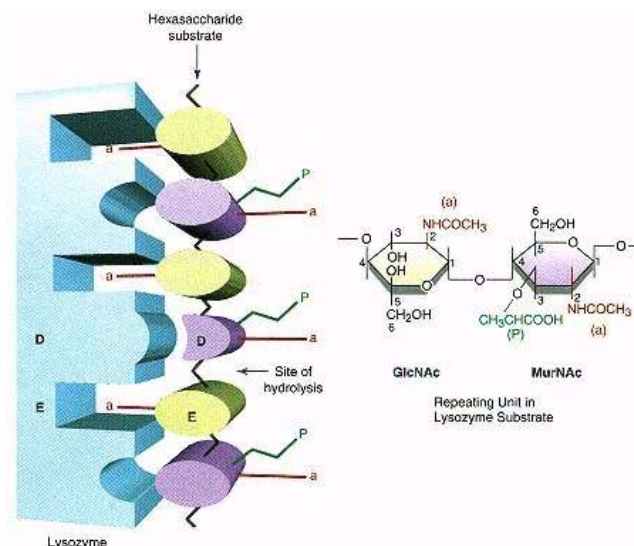

Figure 4.46

Hexasaccharide binding at active site of lysozyme. In the model substrate pictured, the ovals represent individual pyranose rings of the repeating units of the lysozyme substrate shown to the right. Ring D is strained by the enzyme to the half-chair conformation and hydrolysis occurs between the D and E rings. Six subsites on the enzyme bind substrate. Alternate sites are specific for acet-amido groups (a) but are unable to accept the lactyl (P) side chains, which occur on the N-acetylmuramic acid residues. Thus the substrate can bind to the enzyme in only one orientation.

Redrawn based on model proposed by Imoto, T., et al. In P. Boyer (Ed.), *The Enzymes*, 3rd ed., Vol. 7. New York: Academic Press, 1972, p. 713.

substrate strain is that of **lysozyme** (Figure 4.46) in which the conformation of the sugar residue "D" at which bond breaking occurs is strained from the stable chair to the unstable half-chair conformation upon binding. These conformations of glucose are shown in Figure 4.47. The concept of substrate strain explains the role of the enzyme in increasing the rate of reaction (see Section 4.8).

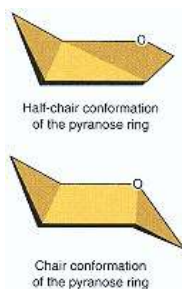
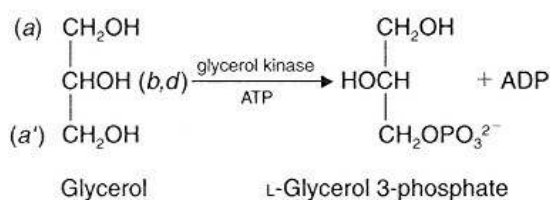

Figure 4.47
Two possible conformations of glucose.

Asymmetry of the Binding Site

Not only are enzymes able to distinguish between isomers of the substrate, but they are able to distinguish between two equivalent atoms in a symmetrical molecule. For example, glycerol kinase distinguishes between configurations of H and OH on C-2 in the symmetrical substrate glycerol, so that only the asymmetric product L-glycerol 3-phosphate is formed. These **prochiral substrates** have two identical substituents and two additional but dissimilar groups on the same carbon ($C_{\text{arr}bd}$).



Prochiral substrates possess no optical activity but can be converted to chiral compounds, that is, ones that possess an asymmetric center. The explanation for this enigma is provided if the enzyme binds the two dissimilar groups at specific sites and only one of the two similar substituents is able to bind at the active site (Figure 4.48). Thus the enzyme is able to recognize only one specific orientation of the symmetrical molecule. Asymmetry is produced in the product by modification of one side of the bound substrate. A minimum of three different binding sites on the enzyme surface is required to distinguish between identical groups on a prochiral substrate.

4.8—

Mechanism of Catalysis

All chemical reactions have a potential energy barrier that must be overcome before reactants can be converted to products. In the gas phase the reactant molecules can be given enough kinetic energy by heating them so that collisions result in product formation. The same is true with solutions. However, a well-controlled body temperature of 37°C does not allow temperature to be increased to accelerate the reaction, and 37°C is not warm enough to provide the reaction rates required for fast-moving species of animals. Enzymes employ other means of overcoming the barrier to reaction.

Diagrams for catalyzed and noncatalyzed reactions are shown in Figure 4.49. The energy barrier represented by the uncatalyzed curve in Figure 4.49 is a measure of the **activation energy**, E_a , required for the reaction to occur. The reaction coordinate is simply the pathway in terms of bond stretching between reactants and products. At the apex of the energy barrier is the activated complex known as the **transition state**, T_s , that represents the reactants in their activated state. In this state reactants are in an intermediate stage along the reaction pathway and cannot be identified as starting material or products. For example, in the hydrolysis of ethyl acetate:

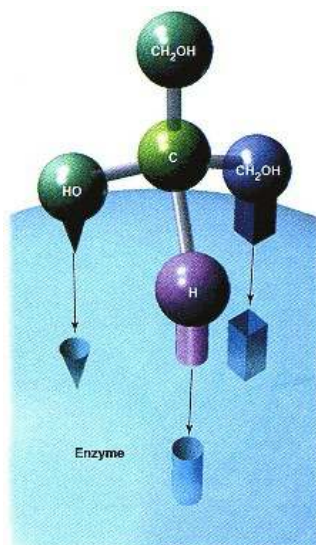
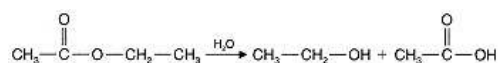
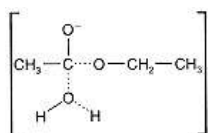

Figure 4.48
Three-point attachment of a symmetrical substrate to an asymmetric substrate-binding site.

Glycerol kinase by virtue of dissimilar binding sites for the -H and -OH group of glycerol binds only the -hydroxymethyl group to the active site. One stereoisomer results from the kinase reaction, L-glycerol 3-phosphate.



the T_s might look like



The transition state complex can break down to products or go back to reactants. The T_s is not an intermediate and cannot be isolated! In the case of the enzyme-catalyzed reaction (Figure 4.49) the energy of the reactants and products is no different than in the uncatalyzed reaction. Enzymes do not change the thermodynamics of the system but they do change the pathway for reaching the final state.

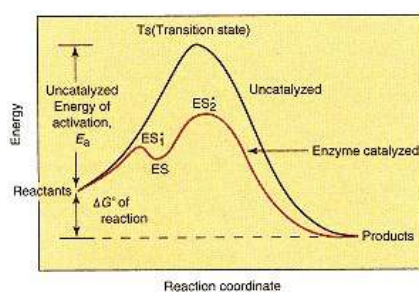

Figure 4.49
Energy diagrams for catalyzed versus noncatalyzed reactions.

The overall energy difference between reactants and products is the same in catalyzed and noncatalyzed reactions. The enzyme-catalyzed reaction proceeds at a faster rate because the energy of activation is lowered.

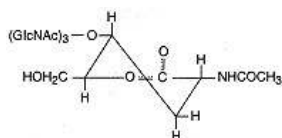

Figure 4.50

A transition state analog (tetra-*N*-acetylchitotetrose-*d*-lactone) of ring D of the substrate for lysozyme.

As noted on the energy diagram, there may be several plateaus or valleys on the energy contour for an enzyme reaction. At these points metastable intermediates exist. An important point is that each valley may be reached with the heat input available in 37°C. The enzyme allows the energy barrier to be scaled in increments. The Michaelis–Menten ES complex is not the transition state but may be found in one of the valleys because in the ES complex substrates are properly oriented and may be "strained." The bonds to be broken lie further along the reaction coordinate.

If our concepts of the transition state are correct, one would expect that compounds designed to resemble closely the transition state would bind more tightly to the enzyme than the natural substrate. This has proved to be the case. In such substrate analogs one finds affinities 10^2 – 10^5 times greater than those for substrate. These compounds are called **transition state analogs** and are potent enzyme inhibitors. Previously, lysozyme was discussed in terms of substrate strain, and mention was made of the conversion of sugar ring D from a chair to a strained half-chair conformation. Synthesis of a transition state analog in the form of the δ -lactone of tetra-*N*-acetylchitotetrose (Figure 4.50), which has a distorted half-chair conformation, followed by binding studies, showed that this transition state analog was bound 6000 times tighter than the normal substrate.

Enzymes Decrease Activation Energy

Enzymes can enhance the rates of reaction by a factor of 10^9 – 10^{12} times that of the noncatalyzed reaction. Most of this rate enhancement can be accounted for by four processes: acid–base catalysis, substrate strain (transition state stabilization), covalent catalysis, and entropy effects.

Acid–Base Catalysis

Specific acids and bases are H^+ and OH^- , respectively. Free protons and hydroxide ions are not encountered in most enzyme reactions and then only in some metal-dependent enzymes (see p. 144). A **general acid** or base is a compound that is weakly ionizable. In the physiological pH range, the protonated form of histidine is the most important general acid and its conjugate base is an important general base (Figure 4.51). Other acids are the thiol $-SH$ of cysteine, tyrosine $-OH$, and the ϵ -amino group of lysine. Other bases are carboxylic acid anions and the conjugate bases of the general acids.

Ribonuclease (RNase) exemplifies the role of acid and base catalysis at the enzyme active site. RNase cleaves an RNA chain at the 3'-phosphodiester linkage of pyrimidine nucleotides with an obligatory formation of a cyclic 2, 3-phosphoribose on a pyrimidine nucleotide as intermediate. In the mechanism outlined in Figure 4.52, His 119 acts as a general acid to protonate the phosphodiester bridge, whereas His 12 acts as a base in generating an alkoxide on the ribose-3-hydroxyl. The latter then attacks the phosphate group, forming a cyclic phosphate and breakage of the RNA chain at this locus. The cyclic phosphate is then cleaved in phase 2 by a reversal of the reactions in phase 1, but with water replacing the leaving group. The active-site histidines revert to their original protonated state.

Substrate Strain

Previous discussion of this topic related to induced fit of enzymes to substrate. Binding of substrate to a preformed site on the enzyme can induce strain in the substrate. Irrespective of the mechanism of strain induction, the energy level of the substrate is raised, and the bond lengths and angles of the substrate more closely resemble those found in the transition state.

A combination of substrate strain and acid–base catalysis is observed in the action of lysozyme (Figure 4.53). X-ray evidence shows that ring D of the

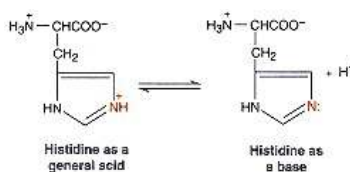

Figure 4.51

Acid and base forms of histidine.

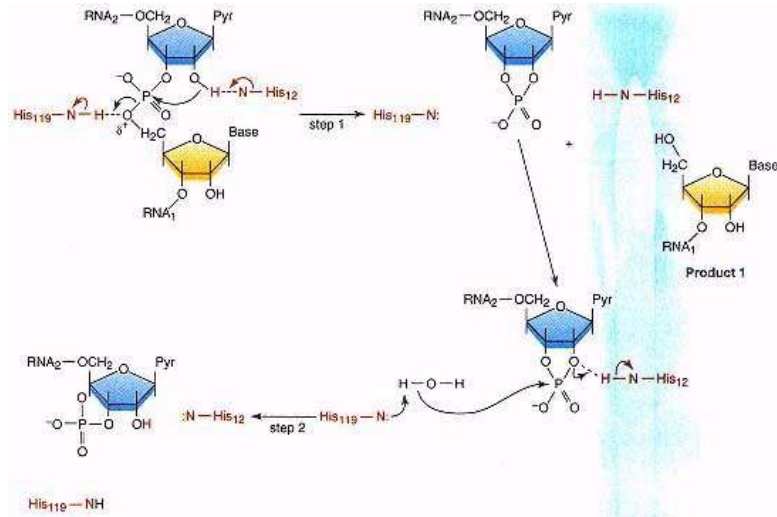

Figure 4.52

Role of acid and base catalysis in the active site of ribonuclease.

RNase cleaves the phosphodiester bond in a pyrimidine locus in RNA. Histidine residues 12 and 119, respectively, at the ribonuclease active site function as acid and base catalysts in enhancing the formation of an intermediate 2,3-cyclic phosphate and release of a shorter fragment of RNA (product 1). These same histidines then play a reverse role in the hydrolysis of the cyclic phosphate and release of the other fragment of RNA (product 2) that ends in a pyrimidine nucleoside 3-phosphate. As a result of the formation of product 2, the active site of the enzyme is regenerated.

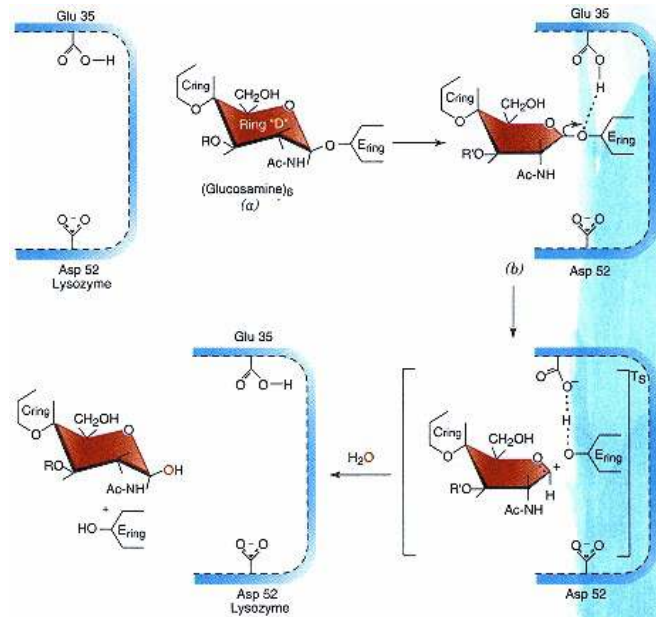

Figure 4.53

Mechanism for lysozyme action: substrate strain.

Binding of the stable chair

(a) conformation of the substrate to the enzyme generates the strained half-chair conformation

(b) in the ES complex. In the transition state, acid-catalyzed hydrolysis of the glycosidic linkage by an active-site glutamic acid residue generates a carbonium ion on the D ring, which relieves the strain generated in the initial ES complex and results in collapse of the transition state to products.

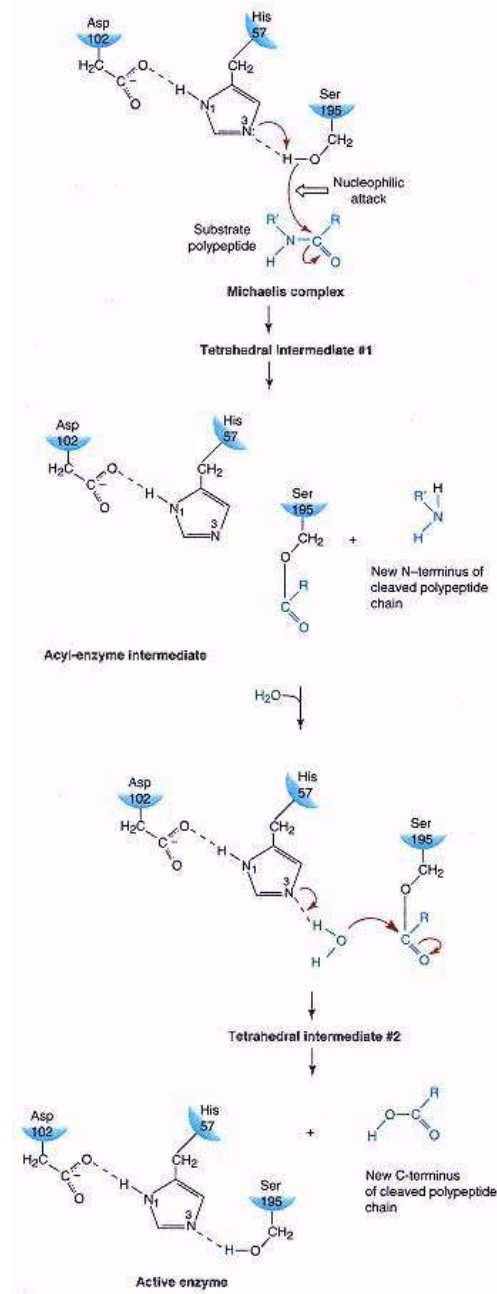

Figure 4.54

Covalent catalysis in active site of chymotrypsin.

Through acid-catalyzed nucleophilic attack, as shown by red arrows, the stable amide linkage of the peptide substrate is converted into an unstable acylated enzyme through serine-195 of the enzyme. The latter is hydrolyzed in the rate-determining step. The new amino-terminal peptide, shown in blue, is released concomitant with formation of the acylated enzyme.

hexasaccharide substrate is strained to the half-chair conformation upon binding to lysozyme. General acid catalysis by active-site glutamic acid promotes the unstable half-chair into the transition state. The oxycarbonium ion formed in the transition state is stabilized by the negatively charged aspartate. Breakage of the glycosidic linkage between rings D and E relieves the strained transition state by allowing ring D to return to the stable chair conformation.

Covalent Catalysis

In **covalent catalysis**, the attack of a nucleophilic (negatively charged) or electrophilic (positively charged) group in the enzyme active site upon the substrate results in covalent binding of the substrate to the enzyme as an intermediate in the reaction sequence. Enzyme-bound coenzymes often form covalent bonds with the substrate. For example, in the **transaminases**, the amino acid substrate forms a Schiff base with enzyme-bound pyridoxal phosphate (see p. 449). In all cases of covalent catalysis, the enzyme- or coenzyme-bound substrate is more labile than the original substrate. The enzyme–substrate adduct represents one of the valleys on the energy profile.

Serine proteases, such as trypsin, chymotrypsin, and thrombin, are good representatives of the covalent catalytic mechanism (see p. 97). Acylated enzyme has been isolated in the case of chymotrypsin. Covalent catalysis is assisted by acid–base catalysis in these particular enzymes (Figure 4.54). In chymotrypsin the attacking nucleophile is Ser 195, which is not dissociated at pH 7.4 and a mechanism for ionizing this very basic group is required. It is now thought that in the anhydrous milieu of the active site, Ser 195 and His 57 have similar pK values and that the negative charge on Asp 102 stabilizes the transfer of the proton from the OH of Ser 195 to N3 of His 57 (Figure 4.54). The resulting serine alkoxide attacks the carbonyl carbon of the peptide bond, releasing the amino-terminal end of the protein and forming an **acylated enzyme** intermediate (through Ser 195). The acylated enzyme is then cleaved by reversal of the reaction sequence, but with water as the nucleophile rather than Ser 195. Chemical evidence indicates the formation of two tetrahedral intermediates, one preceding the formation of the acylated enzyme and one following the attack of water on the acyl-enzyme (Figure 4.55).

Transition State Stabilization

The previously mentioned effects promote the substrate to enter the transition state. Since the active site binds the transition state with a much greater affinity than the substrate, that small fraction of substrate molecules existing in a transition state geometry will be converted to products quickly. Thus, by mass action, all the substrate can be rapidly converted to products. Any factor that increases the population of substrate molecules resembling the transition state will contribute to catalysis.

Entropy Effect

Entropy is a thermodynamic term, S , which defines the extent of disorder in a system. At equilibrium, entropy is maximal. For example, in solution two reactants A and B exist in many different orientations. The chances of A and B coming together with the correct geometric orientation and with enough energy to react is small at 37°C and in dilute solution. However, if an enzyme with two high-affinity binding sites for A and B is introduced into the dilute solution of these reactants, as suggested in Figure 4.56, A and B will be bound to the enzyme in the correct orientation for the reaction to occur. They will be bound with the correct stoichiometry, and the effective concentration of the reactants will be increased on the enzyme surface, all of which will contribute to an increased rate of reaction.

When correctly positioned and bound on the enzyme surface, the substrates may be "strained" toward the transition state. At this point the substrates have

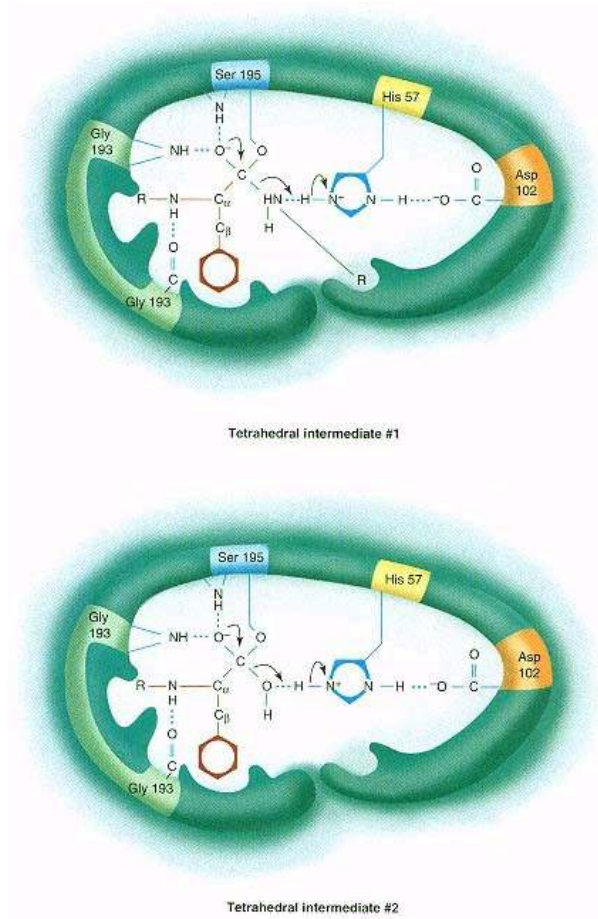

Figure 4.55
Tetrahedral intermediates.

- (a) Model of tetrahedral intermediate #1 that precedes formation of the acyl-enzyme intermediate.
 (b) Model of tetrahedral intermediate #2 resulting from the attack of water on acyl-enzyme intermediate.

been "set up" for acid–base and/or covalent catalysis. Proper orientation and the nearness of the substrate with respect to the catalytic groups, which has been dubbed the "proximity effect," contribute 10^3 – 10^5 -fold to the rate enhancement observed with enzymes. It is estimated that the decrease in entropy contributes a factor of 10^3 to the rate enhancement.

Abzymes Are Artificially Synthesized Antibodies with Catalytic Activity

If the principles discussed above for enzyme catalysis are correct, then one should be able to design an artificial enzyme. This feat has been accomplished by the use of several different approaches, but only the synthesis of antibodies that have catalytic activity will be considered in this discussion. These antibodies are called **abzymes**. Design of abzymes is based on two principles. The first principle is the ability of the immune system to recognize any arrangement

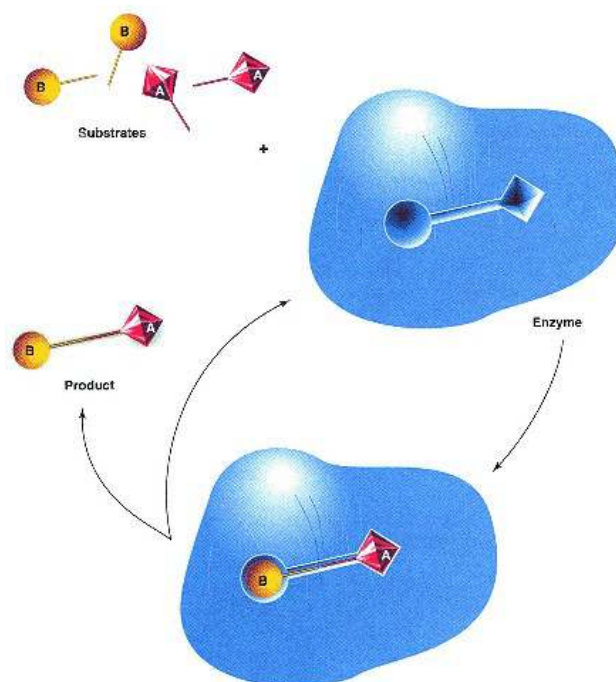

Figure 4.56

Role of the enzyme in enhancing reaction rate by decreasing entropy.

Substrates in dilute solution are concentrated and oriented on the enzyme surface so as to enhance the rate of the reaction.

of atoms in the foreign antigen and to make a binding site on the resulting immunoglobulin that is exquisitely suited to binding that antigen. The second principle is that strong binding of transition state-like substrates reduces the energy barrier along the reaction pathway (see discussion on p. 160).

In abzymes a transition state analog serves as the hapten. For a lipase abzyme, a racemic phosphonate (Figure 4.57) serves as a hapten. Two enantiomeric fatty acid ester substrates are shown in Figure 4.57*b,c*. See page 159 for the transition state structure expected for ester hydrolysis. Among many antibodies produced by rabbits on challenge with the protein-bound transition state analog (Figure 4.57*a*), one hydrolyzed only the (*R*) isomer (Figure 4.57*b*) and another only the (*S*) isomer. These abzymes enhanced the rate of hydrolysis of substrates (*a*) and (*b*) 10^3 – 10^5 -fold above the background rate in a stereospecific manner. Acceleration of 10^6 -fold, which is close to the enzymatic rate, has been achieved in another esterase-like system.

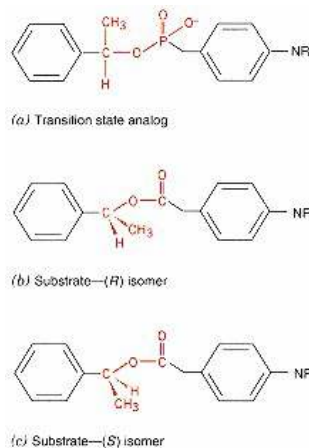

Figure 4.57

Hapten and substrate for a catalytic antibody (abzyme).

Phosphonate (*a*) is the transition state analog used as the hapten to generate antibodies with lipase-like catalytic activity. Specific abzymes can be generated for either the (*R*) isomer

(*b*) or the (*S*) isomer

(*c*)

of methyl benzyl esters.

Environmental Parameters Influence Catalytic Activity

A number of external parameters, including pH, temperature, and salt concentration, affect enzyme activity. These effects are probably not important *in vivo* under normal conditions but are very important in setting up enzyme assays *in vitro* to measure enzyme activity in samples of a patient's plasma or tissue.

Temperature

Plots of velocity versus temperature for most enzymes reveal a bell-shaped curve with an optimum between 40°C and 45°C for mammalian enzymes, as indicated in Figure 4.58. Above this temperature, heat denaturation of the enzyme occurs. Between 0°C and 40°C, most enzymes show a twofold increase in activity for every 10° C rise. Under conditions of hypothermia, most enzyme reactions are depressed, which accounts for the decreased oxygen demand of living organisms at low temperature. Mutation of an enzyme to a thermolabile form can have serious consequences (see Clin. Corr. 4.5).

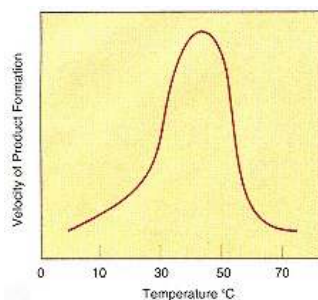

Figure 4.58
Temperature dependence of a typical mammalian enzyme.

To the left of the optimum, the rate is low because the environmental temperature is too low to provide enough kinetic energy to overcome the energy of activation. To the right of the optimum, the enzyme is inactivated by heat denaturation.

pH

Nearly all enzymes show a bell-shaped pH–velocity profile, but the maximum (**pH optimum**) varies greatly with different enzymes. Alkaline and acid phosphatases with very different pH optima are both found in humans, as shown in Figure 4.59. The bell-shaped curve and its position on the x-axis are dependent on the particular ionized state of the substrate that will be optimally bound to the enzyme. This in turn is related to the ionization of specific amino acid residues that constitute the substrate-binding site. In addition, amino acid residues involved in catalyzing the reaction must be in the correct charge state to be functional. For example, if aspartic acid is involved in catalyzing the reaction, the pH optimum may be in the region of 4.5 at which the α -carboxyl of aspartate ionizes; whereas if the ϵ -amino of lysine is the catalytic group, the pH optimum may be around 9.5, the pK_a of the ϵ -amino group. Studies of the pH dependence of enzymes are useful for suggesting which amino acid(s) may be operative in catalysis.

Clinical Correlation 4.6 points out the effect of a mutation leading to a change in the pH optimum of a physiologically important enzyme. Such a mutated enzyme may function on the shoulder of the pH-rate profile, but not be optimally active, even under normal physiological conditions. When an abnormal condition such as alkalosis (observed in vomiting) or acidosis (observed in pneumonia and often in surgery) occurs, the enzyme activity may disappear because the pH is inappropriate. Thus under normal conditions, the enzyme may be active enough to meet normal requirements, but under stress conditions the enzyme may be less active.

CLINICAL CORRELATION 4.5

Thermal Lability of Glucose-6-Phosphate Dehydrogenase Results in Hemolytic Anemia

In red cells, glucose-6-phosphate (G6PD) is an important enzyme in the red cell for the maintenance of the membrane integrity. A deficiency or inactivity of this enzyme leads to a hemolytic anemia. In other cases, a variant enzyme is present that normally has sufficient activity to maintain the membrane but fails under conditions of oxidative stress. A mutation of this enzyme leads to a protein with normal kinetic constants but a decreased thermal stability. This condition is especially critical to the red cell, since it is devoid of protein-synthesizing capacity and cannot renew enzymes as they denature. The end result is a greatly decreased lifetime for those red cells that have an unstable G6PD. These red cells are also susceptible to drug-induced hemolysis. See Clin. Corr. 8.1.

Lazzatio, L., and Meta, A., Glucose-6-phosphate dehydrogenase deficiency. In: C. R. Scriver, A. L. Beaudet, W. S. Sly, and D. Valle (Eds.), *The Metabolic and Molecular Bases of Inherited Disease*, 7th ed. New York: McGraw-Hill, 1995, p. 3369.

4.9—

Clinical Applications of Enzymes

The principles of enzymology outlined in previous sections are applied in the clinical laboratory in measurement of plasma or tissue enzyme activities and concentrations of substrates in patients. The rationale for measuring plasma enzyme activities is based on the premise that changes in activities reflect changes that have occurred in a specific tissue or organ. Plasma enzymes are of two types: (1) one type is present in the highest concentration, is specific to plasma, and has a functional role in plasma; and (2) the second is normally present at very low levels and plays no functional role in the plasma. The former includes the enzymes associated with blood coagulation (e.g., thrombin), fibrin dissolution (plasmin), and processing of chylomicrons (lipoprotein lipase).

In disease of tissues and organs, the nonplasma-specific enzymes are most important. Normally, the plasma levels of these enzymes are low to absent. A disease process may cause changes in cell membrane permeability or increased cell death, resulting in release of intracellular enzymes into the plasma. When permeability changes, those enzymes of lower molecular weight will appear in the plasma first and the greater the concentration gradient between intra- and extracellular levels, the more rapidly the enzyme diffuses out. Cytosolic enzymes will appear in the plasma before mitochondrial enzymes, and the

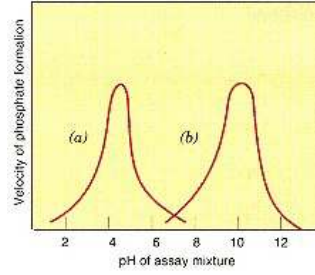

Figure 4.59
The pH dependence of
(a) acid and
(b) alkaline phosphatase reactions.

In each case the optimum represents the ideal ionic state for binding of enzyme and substrate and the correct ionic state for the amino acids involved in the catalytic event.

greater the quantity of tissue damaged, the larger the increase in plasma level. The nonplasma-specific enzymes will be cleared from the plasma at varying rates, which depend on the stability of the enzyme and its uptake by the reticuloendothelial system.

CLINICAL CORRELATION 4.6

Alcohol Dehydrogenase Isoenzymes with Different pH Optima

In addition to the change in aldehyde dehydrogenase isoenzyme composition in some Asians (see Clin. Corr. 4.2), different alcohol dehydrogenase isoenzymes are also observed. Alcohol dehydrogenase (ADH) is encoded by three genes, which produce three different polypeptides: α , β , and γ . Three alleles are found for the β -gene that differ in a single nucleotide base, which causes substitutions for arginine. The substitutions are shown below:

	<i>Residue 47</i>	<i>Residue 369</i>
β_1	Arg	Arg
β_2	His	Arg
β_3	Arg	Cys

The liver β_3 form has ADH activity with a pH optimum near 7, compared with 10 for β_1 , and 8.5 for β_2 . The rate-determining step in alcohol dehydrogenase is the release of NADH. NADH is held on the enzyme by ionic bonds between the phosphates of the coenzyme and the arginines at positions 47 and 369. In the β_1 isozyme this ionic interaction is not broken until the pH is quite alkaline and the guanidinium group of arginine starts to dissociate H^+ . Substitution of amino acids with lower pK values, as in β_2 and β_3 , weakens the interaction and lowers the pH optimum. Since the release of NADH is facilitated, the V_{max} values for β_2 and β_3 are also higher than for β_1 .

Burnell, J. C., Carr, L. G., Dwulet, F. E., Edenberg, H. J., Li, T-K., and Bosron, W. F. The human β_3 alcohol dehydrogenase subunit differs from β_1 by a cys- for arg-369 substitution which decreased NAD(H) binding. *Biochem. Biophys. Res. Commun.* 146:1227, 1987.

In the diagnosis of specific organ involvement in a disease process it would be ideal if enzymes unique to each organ could be identified. This is unlikely because the metabolic processes of various organs are very similar. Alcohol dehydrogenase of the liver and acid phosphatase of the prostate are useful for specific identification of disease in these organs. Other than these two examples, there are few enzymes that are tissue or organ specific. However, the ratio of various enzymes does vary from tissue to tissue. This fact, combined with a study of the kinetics of appearance and disappearance of particular enzymes in plasma, allows a diagnosis of specific organ involvement to be made. Figure 4.60 illustrates the time dependence of the plasma activities of enzymes released

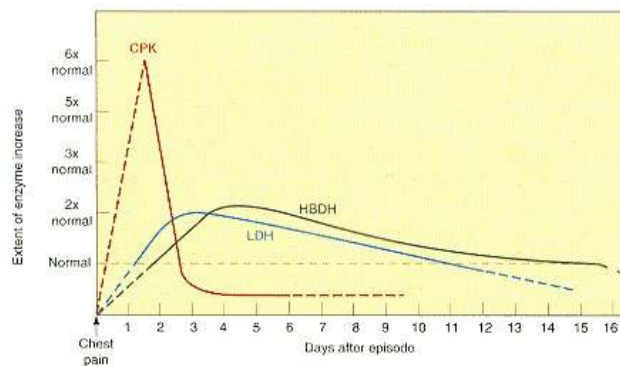

Figure 4.60
Kinetics of release of cardiac enzymes into serum following a myocardial infarction.

CPK, creatine kinase; LDH, lactic dehydrogenase; HBDH, α -hydroxybutyric dehydrogenase. Such kinetic profiles allow one to determine where the patient is with respect to the infarct and recovery. Note: CPK rises sharply but briefly; HBDH rises slowly but persists.

Reprinted with permission from Coodley, E. L. *Diagnostic Enzymes*. Philadelphia: Lea & Febiger, 1970, p. 61.

from the myocardium following a heart attack. Such profiles allow one to establish when the attack occurred and whether treatment is effective. Clinical Correlation 4.7 demonstrates how diagnosis of a specific enzyme defect led to a rational clinical treatment that restored the patient to health.

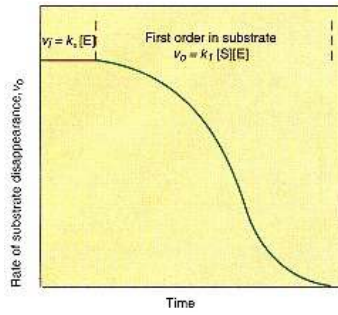

Figure 4.61
Relation of substrate concentration to order of the reaction.

When the enzyme is completely saturated, the kinetics are zero order with respect to substrate and are first order in the enzyme; that is, the rate depends only on enzyme concentration. When the substrate level falls below saturating levels, the kinetics are first order in both substrate and enzyme and are therefore second order; that is, the observed rate is dependent on both enzyme and substrate.

Studies of the kinetics of appearance and disappearance of plasma enzymes require a valid enzyme assay. A good assay is based on temperature and pH control, as well as saturating levels of all substrates, cosubstrates, and cofactors. To accomplish the latter, the K_m must be known for those particular conditions of pH, ionic strength, and so on, that are to be used in the assay. Recall that K_m is the substrate concentration at half-maximal velocity ($1/2 V_{max}$). To assure that the system is saturated, substrate concentration is generally increased five- to tenfold over the K_m . With saturation of the enzyme with substrate, the reaction is zero order. This fact is emphasized in Figure 4.61. Under zero-order conditions changes in velocity are proportional to enzyme concentration alone. Under first-order conditions, the velocity is dependent on both the substrate and enzyme concentrations. Clinical Correlation 4.8 demonstrates the importance of determining if the assay conditions accurately reflect the amount of enzyme actually present. Clinical laboratory assay conditions are optimized for the properties of the normal enzyme and may not correctly measure levels of mutated enzyme. pH dependence and/or the K_m for substrate and cofactors may drastically change in a mutated enzyme. Under optimal conditions a valid enzyme assay reflects a linear dependence of velocity and amount of enzyme. This can be tested by determining if the velocity of the reaction doubles when the plasma sample size is doubled, while keeping the total volume of the assay constant (Figure 4.62).

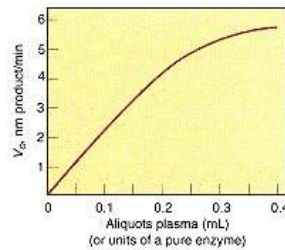

Figure 4.62
Assessing the validity of an enzyme assay.

The line shows what is to be expected for any reaction where the concentration of substrate is held constant and the aliquots of enzyme are increased. In this example linearity between initial velocity observed and amount of enzyme, whether pure or in a plasma sample, is only observed up to 0.2 mL of plasma or 0.2 units of pure enzyme. If more than 0.2 mL is used, the actual amount of enzyme in the sample would be underestimated.

Coupled Assays Utilize the Optical Properties of NAD, NADP, or FAD

Enzymes that employ the coenzymes NAD^+ , $NADP^+$, and FAD are easily measured because of the optical properties of NADH, NADPH, and FAD. The absorption spectra of NADH and FAD in the ultraviolet and visible light regions are shown in Figure 4.63. Oxidized FAD absorbs strongly at 450 nm, while NADH has maximal absorption at 340 nm. The concentrations of both FAD and NADH are related to their absorption of light at the respective absorption maximum by the **Beer-Lambert relation**

$$A = \epsilon \cdot c \cdot l$$

where l is the pathlength of the spectrophotometer cell in centimeters (usually 1 cm), ϵ is absorbance of a molar solution of the substance being measured at

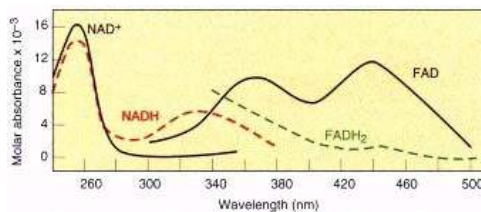

Figure 4.63
Absorption spectra of niacin and flavin coenzymes. The reduced form of NAD (NADH) absorbs strongly at 340 nm. The oxidized form of flavin coenzymes absorbs strongly at 450 nm. Thus one can follow the rate of reduction of NAD^+ by observing the increase in the absorbance at 340 nm and the formation of $FADH_2$ by following the decrease in absorbance at 450 nm.

CLINICAL CORRELATION 4.7**Identification and Treatment of an Enzyme Deficiency**

Enzyme deficiencies usually lead to increased accumulation of specific intermediary metabolites in plasma and hence in urine. Recognition of the intermediates that accumulate in biological fluids is useful in pinpointing possible enzyme defects. After the enzyme deficiency is established, metabolites that normally occur in the pathway but are distal to the block may be supplied exogenously in order to overcome the metabolic effects of the enzyme deficiency.

In hereditary orotic aciduria there is a double enzyme deficiency in the pyrimidine biosynthetic pathway leading to accumulation of orotic acid. Both orotate phosphoribosyltransferase and orotidine 5'-phosphate decarboxylase are deficient, causing decreased *in vivo* levels of CTP and TTP. The two activities are deficient because they reside in separate domains of a bifunctional polypeptide of 480 amino acids. dCTP and dTTP, which arise from CTP and TTP, are required for cell division. In these enzyme deficiency diseases the patients are pale, weak, and fail to thrive. Administration of the missing pyrimidines as uridine or cytidine promotes growth and general well-being and also decreases orotic acid excretion. The latter occurs because the TTP and CTP formed from the supplied uridine and cytidine repress carbamoyl-phosphate synthetase, the committed step, by feedback inhibition, resulting in a decrease in orotate production.

Webster, D. R., Becroft, D. M. O., and Suttie, D. P. Hereditary orotic aciduria and other diseases of pyrimidine metabolism. In C. R. Scriver, A. L. Beaudet, W. S. Sly, and D. Valle (Eds.), *The Metabolic and Molecular Bases of Inherited Disease*, 7th ed. McGraw-Hill, 1995, p. 1799.

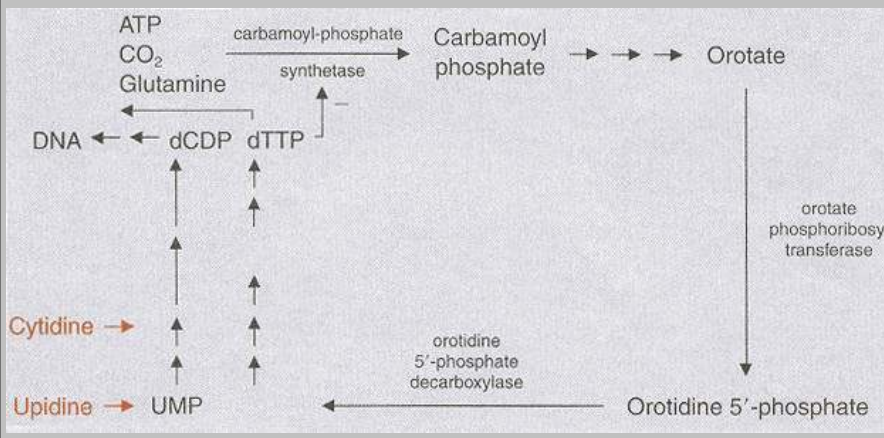
**CLINICAL CORRELATION 4.8****Ambiguity in the Assay of Mutated Enzymes**

Structural gene mutations leading to production of enzymes with increases or decreases in K_m are frequently observed. A case in point is a patient with hyperuricemia and gout, whose red blood cell hypoxanthine-guanine-phosphoribosyltransferase

(HGPRT) showed little activity in assays *in vitro*. This enzyme is involved in the salvage of purine bases and catalyzes the reaction

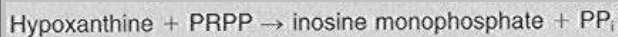

where PRPP is phosphoribosylpyrophosphate.

The absence of HGPRT activity results in a severe neurological disorder known as Lesch-Nyhan syndrome (see p. 499), yet this patient did not have the clinical signs of this disorder. Immunological testing with a specific antibody to the enzyme revealed as much cross-reacting material in the patient's red blood cells as in normal controls. The enzyme was therefore being synthesized but was inactive in the assay *in vitro*. Increasing the substrate concentration in the assay restored full activity in the patient's red cell hemolysate. This anomaly is explained as a mutation in the substrate-binding site of HGPRT, leading to an increased K_m . Neither the substrate concentration in the assay nor in the red blood cells was high enough to bind to the enzyme. This case reinforces the point that an accurate enzyme determination is dependent on zero-order kinetics, that is, the enzyme being saturated with substrate.

Sorenson, L., and Benke, P. J. Biochemical evidence for a distinct type of primary gout. *Nature* 213:1122, 1967.

a specific wavelength of light, A is absorbance, and c is concentration. Absorbance is the log of transmittance (I_0/I). The term ε is a constant that varies from substance to substance; its value can be found in a handbook of biochemistry. In an optically clear solution, the concentration c can be calculated after determination of the absorbance A and substituting into the Beer–Lambert equation.

Many enzymes do not employ NAD^+ or FAD but do generate products that can be utilized by a NAD^+ - or FAD -linked enzyme. For example, glucokinase catalyzes the reaction

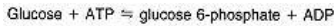

ADP and glucose 6-phosphate (G6P) are difficult to measure directly; however, glucose-6-phosphate dehydrogenase catalyzes the reaction

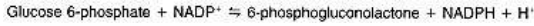

Thus by adding an excess of G6P dehydrogenase and NADP^+ to the assay mixture, the velocity of production of G6P by glucokinase is proportional to the rate of reduction of NADP^+ , which can be measured directly in the spectrophotometer.

Clinical Analyzers Use Immobilized Enzymes As Reagents

Enzymes are used as chemical reagents in desk-top clinical analyzers in offices or for screening purposes in shopping centers and malls. For example, screening tests for cholesterol and triacylglycerols can be completed in a few minutes using $10 \mu\text{L}$ of plasma. The active components in the assay system are cholesterol oxidase for the cholesterol determination and lipase for the triacylglycerols. The enzymes are immobilized in a bilayer along with the necessary buffer salts, cofactors or cosubstrates, and indicator reagents. The ingredients are arranged in a multilayered vehicle the size and thickness of a 35-mm slide. The plasma sample provides the substrate and water necessary to activate the system. In the case of cholesterol oxidase, hydrogen peroxide is a product that subsequently oxidizes a colorless dye to a colored product that is measured by reflectance spectroscopy. Peroxidase is included in the reagents to catalyze the latter reaction.

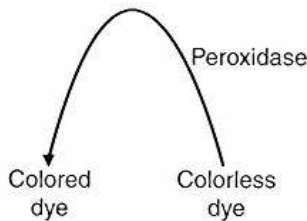
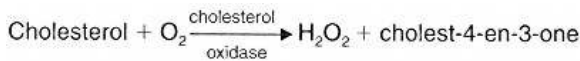

Each slide packet is constructed to measure a specific substance or enzyme and is stored in the cold for use as needed. In many cases the slide packet contains several enzymes in a coupled assay system that eventually generates a reduced nucleotide or a colored dye that can be measured spectroscopically. This technology has been made possible, in part, by the fact that the enzymes involved are stabilized when bound to immobilized matrices and are stored in the dry state or in the presence of a stabilizing solvent such as glycerol.

Enzyme-Linked Immunoassays Employ Enzymes As Indicators

Modern clinical chemistry has benefited from the marriage of enzyme chemistry and immunology. Antibodies specific to a protein antigen are coupled to an indicator enzyme such as horseradish peroxidase to generate a very specific

and sensitive assay. After binding of the peroxidase-coupled antibody to the antigen, the peroxidase is used to generate a colored product that is measurable and whose concentration is related to the amount of antigen in a sample. Because of the catalytic nature of the enzyme the system greatly amplifies the signal. This assay has been given the acronym **ELISA** for enzyme-linked immunoadsorbent assay.

Application of these principles is demonstrated by an assay for **human immunodeficiency virus (HIV)** coat protein antigens. This virus can lead to development of **acquired immunodeficiency syndrome (AIDS)**. Antibodies are prepared in a rabbit against HIV coat proteins. In addition, a reporter antibody is prepared in a goat against rabbit IgG directed against the HIV protein. To this goat anti-rabbit IgG is linked the enzyme, horseradish peroxidase. The test for the virus is performed by incubating patient serum in a polystyrene dish that binds the proteins in the serum sample. Any free protein-binding sites remaining on the dish after incubation with patient serum are then covered by incubating with a nonspecific protein like bovine serum albumin. Next, the rabbit IgG antibody against the HIV protein is incubated in the dish during which time the IgG attaches to any HIV coat proteins that are attached to the polystyrene dish. All unbound rabbit IgG is washed out with buffer. The goat anti-rabbit IgG–peroxidase is now placed in the dish where it binds to any rabbit IgG attached to the dish via the HIV viral coat protein. Unattached antibody–peroxidase is washed out. Peroxidase substrates are added and the amount of color developed in a given time period is a measurement of the amount of HIV coat protein present in a given volume of patient plasma when compared against a standard curve. This procedure is schematically diagrammed in Figure 4.64. This assay amplifies the signal because of the catalytic nature of the reporter group, the enzyme peroxidase. Such amplified enzyme assays allow the measurement of remarkably small amounts of antigens.

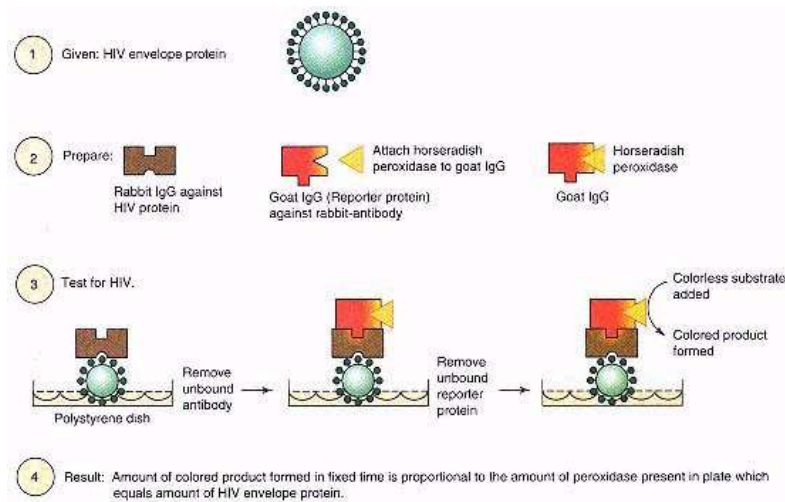

Figure 4.64
Schematic of ELISA (enzyme-linked immunoadsorbent assay) for detecting the human immunodeficiency virus (HIV) envelope proteins.

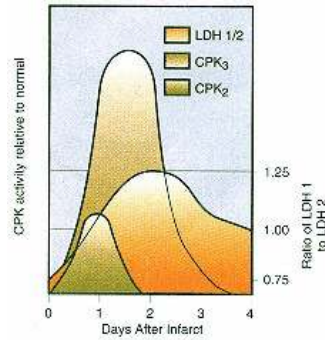

Figure 4.65
Characteristic changes in serum CPK
and LDH isozymes following a
myocardial infarction.

CPK₂ (MB) isozyme increases to a maximum within 1 day of the infarction. CPK₃ lags behind CPK₂ by about 1 day. Total LDH level increases more slowly. The increase of LDH₁ and LDH₂ within 12–24 h coupled with an increase in CPK₂ is diagnostic of myocardial infarction.

Measurement of Isozymes Is Used Diagnostically

Isozymes (or isoenzymes) are enzymes that catalyze the same reaction but migrate differently on electrophoresis. Their physical properties may also differ, but not necessarily. The most common mechanism for the formation of isozymes involves the arrangement of subunits arising from two different genetic loci in different combinations to form the active polymeric enzyme. Isozymes that have wide clinical application are lactate dehydrogenase, creatine kinase, and alkaline phosphatase. **Creatine kinase (CPK)** (see p. 955) occurs as a dimer with two types of subunits, M (muscle type) and B (brain type). In brain both subunits are electrophoretically the same and are designated B. In skeletal muscle the subunits are both of the M type. The isozyme containing both M and B type subunits (MB) is found only in the myocardium. Other tissues contain variable amounts of the MM and BB isozymes. The isozymes are numbered beginning with the species migrating the fastest to the anode on electrophores—thus, CPK₁ (BB), CPK₂ (MB), and CPK₃ (MM).

Lactate dehydrogenase is a tetrameric enzyme containing only two distinct subunits: those designated H for heart (myocardium) and M for muscle. These two subunits are combined in five different ways. The lactate dehydrogenase isozymes, subunit compositions, and major locations are as follows:

Type	Composition	Location
LDH ₁	HHHH	Myocardium and RBC
LDH ₂	HHHM	Myocardium and RBC
LDH ₃	HHMM	Brain and kidney
LDH ₄	HMMM	
LDH ₅	MMMM	Liver and skeletal muscle

To illustrate how kinetic analyses of plasma enzyme activities are useful in medicine, activities of some CPK and LDH isozymes are plotted in Figure 4.65 as a function of time after infarction. After damage to heart tissue the cellular breakup releases CPK₂ into the blood within the first 6–18 h after an infarct, but LDH release lags behind the appearance of CPK₂ by 1 to 2 days. Normally, the activity of the LDH₂ isozyme is higher than that of LDH₁, however, in the case of infarction the activity of LDH₁ becomes greater than LDH₂, at about the time CPK₂ levels are back to baseline (48–60 h). Figure 4.66 shows the fluctuations of all five LDH isozymes after an infarct. The increased ratio of LDH₂ and LDH₁ can be seen in the 24-h tracing. The LDH isozyme "switch" coupled with increased CPK₂ is diagnostic of myocardial infarct (MI) in virtually 100% of the cases. Increased activity of LDH₅ is an indicator of liver congestion. Thus secondary complications of heart failure can be monitored.

The electrophoresis method for determining cardiac enzymes is too slow and insensitive to be of value in the emergency room situation. ELISAs assays based on monoclonal antibodies to CPK₂ are both quick (30 min) and sensitive enough to detect CPK₂ in the serum within an hour or so of a heart attack.

Some Enzymes Are Used As Therapeutic Agents

In a few cases enzymes have been used as drugs in the therapy of specific medical problems. **Streptokinase**, an enzyme mixture prepared from a streptococcus, is useful in clearing blood clots that occur in myocardial infarcts and in the lower extremities. It activates the fibrinolytic proenzyme plasminogen that is normally present in plasma. The activated enzyme is plasmin. **Plasmin** is a serine protease that cleaves the insoluble fibrin in blood clots into several soluble components (see p. 975). Another serine protease, human **tissue plasminogen activator, t-PA**, is being commercially produced by bioengineered

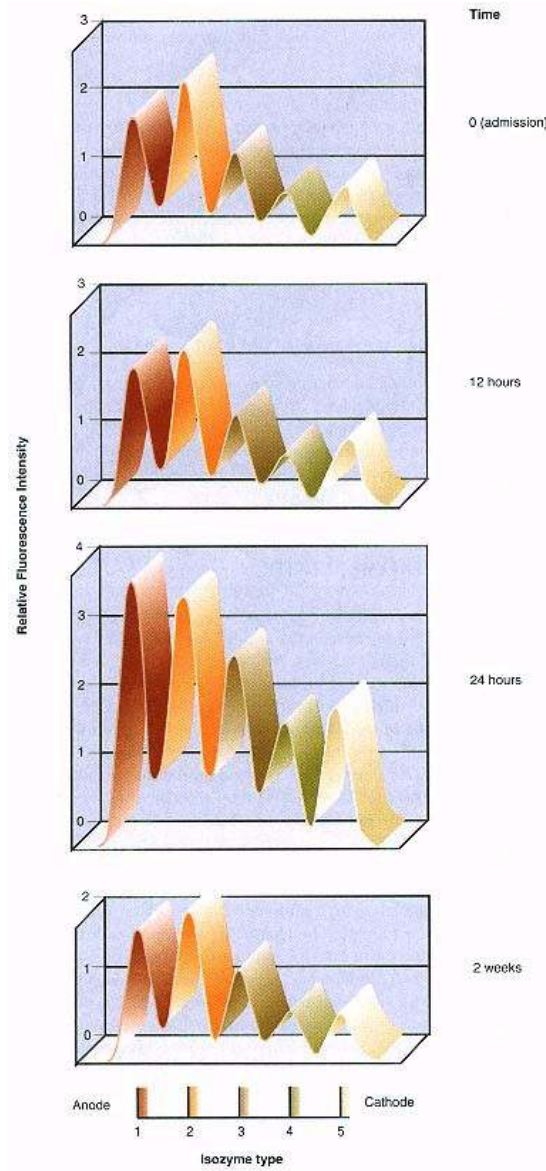

Figure 4.66
Tracings of densitometer scans of LDH isozymes at time intervals following a myocardial infarction.

Total LDH increases and LDH_1 becomes greater than LDH_2 between 12 and 24h. Increase in LDH_5 is diagnostic of a secondary congestive liver involvement. Note the Y axis scales are not identical. After electrophoresis on agarose gels, the LDH activity is assayed by measuring the fluorescence of the NADH formed in LDH-catalyzed reaction.

Courtesy of Dr. A. T. Gajda, Clinical Laboratories, The University of Arkansas for Medical Science.

Escherichia coli (*E. coli*) for use in dissolving blood clots in patients suffering myocardial infarction (see p. 98). t-PA also functions by activating the patient's plasminogen.

Asparaginase therapy is used for some types of adult leukemia. Tumor cells have a requirement for asparagine and must scavenge it from the host's plasma. Intravenous (i.v.) administration of asparaginase lowers the host's plasma level of asparagine, which results in depressing the viability of the tumor.

Most enzymes have a short half-life in blood; consequently, unreasonably large amounts of enzyme are required to maintain therapeutic levels. Work is in progress to enhance enzyme stability by coupling enzymes to solid matrices and implanting these materials in areas that are well perfused. In the future, enzyme replacement in individuals that are genetically deficient in a particular enzyme may be feasible.

Enzymes Linked to Insoluble Matrices Are Used As Chemical Reactors

Specific enzymes linked to insoluble matrices are used in the pharmaceutical industry as highly specific chemical reactors. For example, immobilized β -galactosidase is used to decrease the lactose content of milk for lactose-intolerant people. In production of prednisolone, immobilized steroid 11- β -hydroxylase and a δ -1,2-dehydrogenase convert a cheap precursor to prednisolone in a rapid, stereospecific, and economical manner.

4.10— Regulation of Enzyme Activity

Our discussion up to this point has centered on the chemical and physical characteristics of individual enzymes, but we must be concerned with the physiological integration of many enzymes into a metabolic pathway and the interrelationship of the products of one pathway with the metabolic activity of other pathways. Control of a pathway occurs through modulation of the activity of one or more key enzymes in the pathway. One of the key enzymes is the **rate-limiting** enzyme, which is the enzyme with the lowest V_{\max} . It usually occurs early in the pathway. Another is that catalyzing the **committed step** of the pathway, the first irreversible reaction that is unique to a metabolic pathway. The rate-limiting enzyme is not necessarily the enzyme associated with the committed step. Specific examples of these regulatory enzymes will be pointed out in the sections on metabolism.

The activity of the enzyme associated with the committed step or with the rate-limiting step can be regulated in a number of ways. First, the absolute amount of the enzyme can be regulated by change in *de novo* synthesis of the enzyme. Second, the activity of the enzyme can be modulated by activators, by inhibitors, and by covalent modification through mechanisms previously discussed. Finally, the activity of a pathway can be regulated by physically partitioning the pathway from its initial substrate and by controlling access of the substrate to the enzymes of the pathway. This is referred to as **compartmentation**.

Anabolic and catabolic pathways are usually segregated into different organelles in order to maximize the cellular economy. There would be no point to oxidation of fatty acids occurring at the same time and in the same compartment as biosynthesis of fatty acids. If such occurred, a futile cycle would exist. By maintaining fatty acid biosynthesis in the cytoplasm and oxidation in the mitochondria, control can be exerted by regulating transport of common intermediates across the mitochondrial membrane. Table 1.6 (p. 15) contains a compilation of some of the metabolic pathways and their intracellular distribution.

As indicated earlier, the velocity of any reaction is dependent on the amount of enzyme present. Many rate-controlling enzymes are present in very low concentrations. More enzyme may be synthesized or existing rates of synthesis repressed through hormonally instituted activation of the mechanisms controlling gene expression. In some instances substrate can repress the synthesis of enzyme. For example, glucose represses the *de novo* synthesis of pyruvate carboxykinase, which is the rate-limiting enzyme in the conversion of pyruvate to glucose. If there is plenty of glucose available there is no point in synthesizing glucose. This effect of glucose may be mediated via insulin and is not direct feedback inhibition.

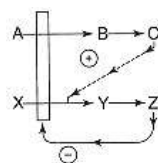

Figure 4.67
Model of
feedback inhibition
and cross-regulation.
 Open bar indicates inhibition and broken line indicates activation. Product Z cross-regulates production of C by its inhibitory effect on the enzyme responsible for the conversion of A to B in the A → B pathway. C in turn cross-regulates the production of Z. The product Z inhibits its own formation by feedback inhibition of the conversion of X to Y.

Many rate-controlling enzymes have relatively short half-lives; for example, that of pyruvate carboxykinase is 5 h. Teleologically this is reasonable because it provides a mechanism for effecting much larger fluctuations in the activity of a pathway than would be possible by inhibition or activation of existing levels of enzyme.

Short-term regulation occurs through modification of the activity of existing enzyme. For example, when the cellular concentration of deoxyribonucleotides builds up such that the cell has sufficient amounts for synthesis of DNA, the key enzyme of the synthetic pathway is inhibited by the end products, resulting in shutdown of the pathway. This is referred to as **feedback inhibition**. The inhibition may take the form of competitive inhibition or allosteric inhibition. In any case, the apparent K_m may be raised above the *in vivo* levels of substrate, and the reaction ceases or decreases in velocity.

In addition to feedback within the pathway, feedback on other pathways also occurs. This is referred to as **cross-regulation**. In cross-regulation a product of one pathway serves as an inhibitor or activator of an enzyme occurring early in another pathway as depicted in Figure 4.67. A good example, considered in detail in Chapter 12, is the cross-regulation of the production of the four deoxyribonucleotides for DNA synthesis.

An example of reversible covalent modification is glycogen phosphorylase, in which the interconvertible active and inactive forms are phosphorylated and dephosphorylated proteins, respectively. Protein kinases and protein phosphatases are also regulated by phosphorylation and dephosphorylation. Other examples of reversible covalent modification include acetylation–deacetylation, adenylation–deadenylation, uridylylation–deuridylylation, and methylation–demethylation. The phosphorylation–dephosphorylation scheme is most common.

Bibliography

- Blackburn, G. M., Kang, A. S., Kingsbury, G. A., and Burton, D. R. Review of abzymes. *Biochem. J.* 262:381, 1989.
- Boyer, P. D. (Ed.). *The Enzymes*, 3rd ed. (28 vols.). New York: Academic Press, 1970–1987.
- Dixon, M., and Webb, E. C. *Enzymes*, 3rd ed. New York: Academic Press, 1979.
- Fersht, A. *Enzyme Structure and Mechanism*, 2nd ed. New York: Freeman, 1985.
- Kyte, J. *Mechanism in Protein Chemistry*. New York: Garland Publishing, 1995.
- Keffler, J. H. Myocardial Markers of Injury. *Am. J. Clin. Path.* 105:305, 1996.
- Knowles, J. R., and Alberty, W. J. Evolution of enzyme function and the development of catalytic efficiency. *Biochemistry* 15:5631, 1976.
- Kraut, J. How do enzymes work? *Science* 242:533, 1988.
- Lerner, R. A., Benkovic, S. J., and Schultz, P. G. At the crossroads of chemistry and immunology: catalytic antibodies. *Science* 252:659, 1991.
- Lolis, E., and Petsko, G. A. Transition-state analogues in protein crystallography: probes of the structural source of enzyme catalysis. *Annu. Rev. Biochem.* 59:597, 1990.
- Meister, A. (Ed.). *Advances in Enzymology*. New York: Wiley-Interscience, issued annually.
- Neurath, H. Evolution of proteolytic enzymes. *Science* 234:350, 1984.
- Page, M. I. and Williams, A. (Eds.). *Enzyme Mechanisms*. London: Royal Society of Chemistry, 1987.
- Richardson, C. C. (Ed.). *Annual Reviews of Biochemistry*. Palo Alto, CA: Annual Reviews, issued annually.
- Segel, I. H. *Enzyme Kinetics*. New York: Wiley, 1975.
- Walsh, C. *Enzyme Reaction Mechanisms*. New York: Freeman, 1979.
- Weber, G. (Ed.). *Advances in Enzyme Regulation*, Elmsford, NY: Pergamon, issued annually.

Questions

J. Baggott and C. N. Angstadt

1. In all enzymes the active site:

- A. contains the substrate-binding site.
- B. is contiguous with the substrate-binding site in the primary sequence.
- C. lies in a region of the primary sequence distant from the substrate-binding site.
- D. contains a metal ion as a prosthetic group.
- E. contains the amino acid side chains involved in catalyzing the reaction.

2. Which of the following types of oxidoreductase enzymes usually form hydrogen peroxide (H_2O_2) as one of their products?

- A. dehydrogenases
- B. oxidases
- C. oxygenases
- D. peroxidases
- E. none of the above

3. The following reaction is catalyzed by:

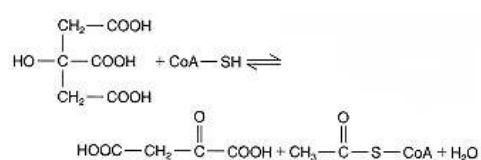

- A. an oxidoreductase.
- B. a transferase.
- C. a hydrolase.
- D. a lyase.
- E. a ligase.

4. In the enzyme-catalyzed reaction

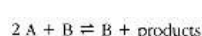

where B is the enzyme, when the concentration of A is very high the reaction order is:

- A. zero order.
- B. first order.
- C. second order.
- D. third order.
- E. a fractional order between first and second.

5. Although enzymic catalysis is reversible, a given reaction may appear irreversible:

- A. if the products are thermodynamically far more stable than the reactants.
- B. under equilibrium conditions.
- C. if a product accumulates.
- D. at high enzyme concentrations.
- E. at high temperatures.

6. K_m of an enzyme is always:

- A. one-half of the V_{max} .
- B. a dissociation constant.
- C. the normal physiological substrate concentration.
- D. the substrate concentration that gives half-maximal velocity.
- E. numerically identical for all isozymes that catalyze a given reaction.

7. Cofactors containing the adenosyl group include all of the following EXCEPT:

- A. ATP.
- B. NAD.
- C. NADP.
- D. FAD.
- E. FMN.

8. Which of the following inhibitor types can be expected to change the K_m of an enzyme but not its V_{max} ?

- A. competitive
- B. noncompetitive
- C. uncompetitive
- D. irreversible
- E. V class allosteric

9. Metal cations may do all of the following EXCEPT:

- A. donate electron pairs to functional groups found in the primary structure of the enzyme protein.
- B. serve as Lewis acids in enzymes.
- C. participate in oxidation–reduction processes.
- D. stabilize the active conformation of an enzyme.
- E. form chelates with the substrate, with the chelate being the true substrate.

10. Drugs that act as enzyme inhibitors:

- A. may function as competitive inhibitors.
- B. are clinically useful only when directed against an enzyme unique to a cell that is to be killed.
- C. unlike antibiotics, are free of the danger of drug resistance.
- D. must be harmless to the patient.
- E. generally mimic the three-dimensional structure of the enzyme's active site.

11. Enzymes may be specific with respect to all of the following EXCEPT:

- A. chemical identity of the substrate.
- B. the atomic mass of the elements in the reactive group (e.g., ^{12}C but not ^{14}C).
- C. optical activity of product formed from a symmetrical substrate.
- D. type of reaction catalyzed.
- E. which of a pair of optical isomers will react.

12. All of the following can be chemically isolated EXCEPT:

- A. enzymes.
- B. enzyme–substrate complexes.
- C. enzyme–inhibitor complexes.
- D. enzyme–substrate covalent intermediates.
- E. transition states.

13. Which of the following necessarily results in formation of an enzyme–substrate intermediate?

- A. substrate strain
- B. acid–base catalysis
- C. entropy effects
- D. allosteric regulation
- E. covalent catalysis

14. An enzyme with histidyl residues that participate in both general acid and general base catalysis would be most likely to have a pH–activity profile resembling which curve on the following drawing?

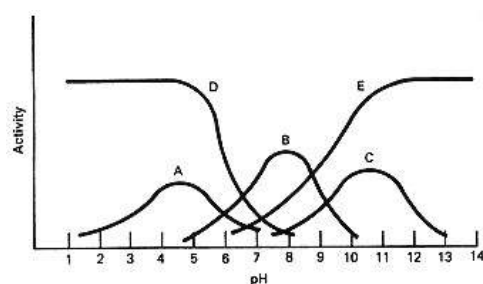

- A. Curve A
- B. Curve B
- C. Curve C
- D. Curve D
- E. Curve E

15. In the reaction sequence below the best point for controlling production of Compound 6 is reaction:

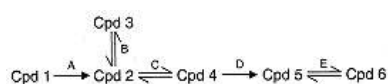

- A. A.
- B. B.
- C. C.
- D. D.
- E. E.

16. If the plasma activity of an intracellular enzyme is abnormally high, all of the following may be a valid explanation EXCEPT:

- A. the rate of removal of the enzyme from plasma may be depressed.
- B. tissue damage may have occurred.
- C. the enzyme may have been activated.
- D. determination of the isozyme distribution may yield useful information.
- E. the rate of synthesis of the enzyme may have increased.

17. Types of physiological regulation of enzyme activity include all of the following EXCEPT:

- A. covalent modification.
- B. changes in rate of synthesis of the enzyme.
- C. allosteric activation.
- D. suicide inhibition.
- E. competitive inhibition.

Answers

1. E The active site contains all the machinery, including the amino acid side chains, involved in catalyzing the reaction. A–D are all possible, but none is necessarily true (p. 129).
2. B Most oxidases produce H_2O_2 ; as a product of the transfer of two electrons from the donor to oxygen. Typical oxidases are flavoenzymes; the cytochrome oxidase complex is a striking exception (p. 129).
3. D This is an unusually complicated lyase reaction, since secondary reactions are involved. It is a lyase because it removes a group (the acetyl group) with formation of a double bond (the C=O bond of the C4 product, oxalacetate). The common name of this enzyme is citrate synthase (p. 132).
4. A At very high concentration of substrate the enzyme is saturated, and the rate of the reaction is independent of reactant (A) concentration. One could argue that the reaction rate depends on enzyme concentration, but in this situation, where enzyme is regenerated, the system would follow a zero-order rate law (p. 136).
5. A Stable products do not react in the reverse direction at an appreciable rate (p. 135). At equilibrium the forward and reverse reactions proceed at identical rates. Product accumulation would tend to reverse the reaction. Enzymes merely catalyze reactions and do not affect the equilibrium of the reaction (p. 128). Temperature affects the rates of reactions, and may also affect the position of the equilibrium, but does not interconvert reversible and irreversible reactions (p. 135).
6. D This is the experimental definition of K_m . The value can be interpreted as a dissociation constant under certain conditions (p. 139), and often it makes sense that K_m be within the physiological range of substrate concentrations (p. 138).
7. E The A in ATP, NAD, NADP, and FAD refers to an adenylate moiety. It is curious that all these different cofactors incorporate the same group, a group that plays no role in the catalytic process. Presumably its role is in cofactor binding (p. 143).
8. A In the presence of a competitive inhibitor the same V_{max} can be reached, but only if the substrate concentration is increased sufficiently. Effectors of K class allosteric enzymes act like competitive inhibitors, changing K_m but not V_{max} ; the opposite is true of V class enzymes (pp. 145 and 152).
9. A Metal cations are electron deficient and may accept electron pairs, serving as Lewis acids, but they do not donate electrons to other functional groups. On the contrary, they sometimes accept electron pairs from groups in amino acid side chains. In doing so they may become chelated (p. 143). Sometimes they are chelated by the substrate, with the chelate being the true substrate (p. 144).
10. A Drugs may serve as competitive inhibitors, such as sulfanilamide (p. 149), or as irreversible inhibitors, such as fluorouracil (p. 151). Pathways unique to pathogenic bacteria, viruses, and so on are rare, so drugs are often developed that are merely less harmful to the host than the target cell because of differences in cell permeability, metabolic rate, and so on (p. 149). Drug resistance can arise through gene amplification in the patient; this can occur with methotrexate (p. 150). Methotrexate is also an example of a drug that is toxic to the patient and must be used with care. Enzyme inhibitors do

not mimic the structure of the active site; rather, they often complement it (p. 156), so that they bind in place of the substrate (p. 148).

11. B Enzymes are specific for the substrate and the type of reaction (p. 154). The asymmetry of the binding site generally permits only one of a pair of optical isomers to react, and only one optical isomer is generated when a symmetric substrate yields an asymmetric product (p. 155). Enzymes do not distinguish among different nuclides of an element, although the rate of reaction of a heavier nuclide might be less than that of a lighter one.

12. E The transition state is not an intermediate and cannot be isolated (p. 159). Rather, it can be thought of as a state in which old bonds are partly broken and new bonds partly formed. All the other species (A–D) can be isolated under suitable experimental conditions.

13. E All enzyme-catalyzed reactions involve an enzyme–substrate complex. There is always at least one transition state involved, but only in covalent catalysis is a covalent bond between enzyme and a portion of the substrate involved (p. 163).

14. B A group must be in the correct ionization state to act catalytically. For a histidyl group to serve as a general acid and a general base (as it does in chymotrypsin), the pH must be compatible with both ionization states of histidine. Since the pK of the histidyl side chain is about 6.8, the maximum activity is likely to be near that pH. Chymotrypsin's pH optimum is in the 7–9 range (pp. 160 and 166).

15. D Control of reaction A would control production of Cpd 3 and Cpd 6. Reaction B is not on the direct route. Reaction C is freely reversible, so it does not need to be controlled. Reaction D is irreversible; if it were not controlled, Cpd 5 might build up to toxic levels (p. 174).

16. E Intracellular enzymes may appear in abnormal amounts when tissues are damaged. Different tissues have characteristic distributions of isozymes. Since appearance of intracellular enzymes in plasma arises from leakage, typically from damaged or destroyed cells, changes in their rates of synthesis within the cell would not be expected to affect plasma concentration (p. 166).

17 D Covalent modification includes zymogen activation and phospho–dephospho protein conversions (p. 175). Enzyme levels may be controlled (p. 174). Allosteric activation is common. End products of a reaction or reaction sequence may inhibit their own formation by competitive inhibition (p. 140). Suicide inhibitors are sometimes used as drugs (p. 150).

Chapter 5— Biological Membranes: Structure and Membrane Transport

Thomas M. Devlin

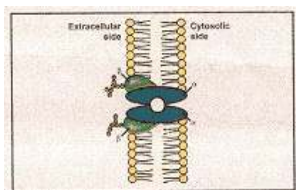

5.1 Overview	180
5.2 Chemical Composition of Membranes	180
Lipids Are a Major Component of Membranes	180
Glycerophospholipids Are the Most Abundant Lipids of Membranes	181
Sphingolipids Are Also Present in Membranes	184
Most Membranes Contain Cholesterol	186
Lipid Composition Varies in Different Membranes	186
Membrane Proteins Are Classified Based on Their Ease of Removal	186
Carbohydrates of Membranes Are Present As Glycoproteins or Glycolipids	187
5.3 Micelles and Liposomes	187
Lipids Form Vesicular Structures	187
Liposomes Have a Membrane Structure Similar to Biological Membranes	188
5.4 Structure of Biological Membranes	189
Fluid Mosaic Model of Biological Membranes	189
Integral Membrane Proteins Are Immersed in Lipid Bilayer	190
Peripheral Membrane Proteins Have Various Modes of Attachment	191
Human Erythrocytes Are Ideal for Studying Membrane Structure	192
Lipids Are Distributed in an Asymmetric Manner in Membranes	192
Proteins and Lipids Diffuse in Membranes	193
5.5 Movement of Molecules through Membranes	196
Some Molecules Can Diffuse through Membranes	196
Movement of Molecules across Membranes Can Be Facilitated	197
Membrane Channels	197
Transporters	198
Group Translocation	198
Membrane Transport Systems Have Common Characteristics	198
There Are Four Common Steps in the Transport of Solute Molecules	199
Energetics of Membrane Transport Systems	200
5.6 Channels and Pores	201
Channels and Pores in Membranes Function Differently	201
Opening and Closing of Channels Are Controlled	201
Sodium Channel	201
Nicotinic–Acetylcholine Channel (nAChR)	202
Examples of Pores Are Gap Junctions and Nuclear Pores	203
5.7 Passive Mediated Transport Systems	204
Glucose Transport Is Facilitated	204
Cl ⁻ and HCO ₃ ⁻ Are Transported by an Antiport Mechanism	204
Mitochondria Contain a Number of Transport Systems	205
5.8 Active Mediated Transport Systems	206
Translocation of Na ⁺ and K ⁺ Is a Primary Active Transport System	206
All Plasma Membranes Contain a Na ⁺ ,K ⁺ -Activated ATPase	206
Erythrocyte Ghosts Are Used to Study Na ⁺ ,K ⁺ Translocation	207
Ca ²⁺ Translocation Is Another Example of a Primary Active Transport System	208
Na ⁺ -Dependent Transport of Glucose and Amino Acids Are Secondary Active Transport Systems	209
Group Translocation Involves Chemical Modification of the Substrate Transported	210
Summary of Transport Systems	210
5.9 Ionophores	211
Bibliography	213
Questions and Answers	214
Clinical Correlations	
5.1 Liposomes As Carriers of Drugs and Enzymes	189
5.2 Abnormalities of Cell Membrane Fluidity in Disease States	195
5.3 Cystic Fibrosis and the Cl ⁻ Channel	202
5.4 Diseases Due to Loss of Membrane Transport Systems	212

5.1— Overview

Biological membranes from either eukaryotic or prokaryotic cells have the same classes of chemical components, a similarity in structural organization, and many properties in common. There are major differences in specific lipid, protein, and carbohydrate components but not in physicochemical interaction of these molecules. Membranes have a trilaminar appearance when viewed by electron microscopy (Figure 5.1), with two dark bands on each side of a light band. The overall width of most mammalian membranes is 7–10 nm but some have significantly smaller widths. Intracellular membranes are usually thinner than plasma membranes. Many do not appear symmetrical, with an inner dense layer often thicker than an outer dense layer; there is a chemical asymmetry of membranes. With development of sophisticated techniques for preparation of tissue samples and staining, including negative staining and freeze fracturing, surfaces of membranes have been viewed; at the molecular level surfaces are not smooth but dotted with protruding globular-shaped masses.

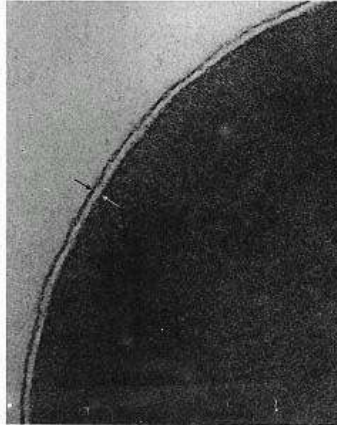

Figure 5.1
Electron micrograph of the erythrocyte plasma membrane showing the trilaminar appearance.

A clear space separates the two electron-dense lines. Electron microscopy has demonstrated that the inner dense line is frequently thicker than the outer line. Magnification about $\times 150,000$.

Courtesy of Dr J. D. Robertson, Duke University, Durham, North Carolina.

Membranes are very dynamic structures with a movement that permits cells as well as subcellular structures to adjust their shapes and to change position. Chemical components of membranes, that is, lipids and protein, are ideally suited for their dynamic role. Membranes are an organized sea of lipid in a fluid state, a nonaqueous compartment of cells, in which various components are able to move and interact.

Cellular membranes control the composition of space that they enclose by excluding a variety of molecules and by selective transport systems allowing movement of specific molecules from one side to the other. These transporters are proteins. By controlling translocation of substrates, cofactors, ions, and so on, membranes modulate the concentration of substances in cellular compartments, thereby exerting an influence on metabolic pathways. Hormones, and growth and metabolic regulators bind to specific protein receptors on plasma membranes (Chapter 20) and the information to be imparted to the cell is transmitted by the membrane component to the appropriate metabolic pathway by a series of intracellular intermediates, termed second messengers. Plasma membranes of eukaryotic cells also have a role in cell-cell recognition, maintenance of the shape of cells, and cell locomotion.

The discussion that follows is directed to the chemistry and transport functions of membranes primarily of mammalian cells but the observations and activities described are applicable to all biological membranes.

5.2— Chemical Composition of Membranes

Lipids and proteins are the two major components of all membranes. The amount of each varies greatly between different membranes (Figure 5.2). Protein ranges from about 20% in the myelin sheath to over 70% in the inner membrane of the mitochondria. Intracellular membranes have a high percentage of protein because of the large number of enzymic activities of these membranes. Membranes also contain a small amount of various polysaccharides in the form of glycoprotein and glycolipid; there is no free carbohydrate in membranes.

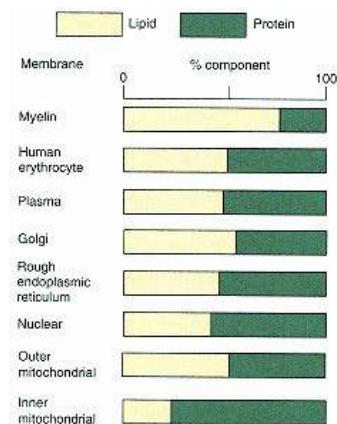

Figure 5.2
Representative values for the percentage of lipid and protein in various cellular membranes.

Values are for rat liver, except for the myelin and human erythrocyte plasma membrane. Values for liver from other species, including human, indicate a similar pattern.

Lipids Are a Major Component of Membranes

The three major lipid components of eukaryotic cell membranes are glycerophospholipids, sphingolipids, and cholesterol. Glycerophospholipids and sphingomyelin, a sphingolipid containing phosphate, are classified as **phospholipids**. Bacteria and blue-green algae contain glycerolipids where a carbohydrate is attached directly to the glycerol. Individual cellular membranes also contain small quantities of other lipids, such as triacylglycerol and diol derivatives (see the Appendix).

Glycerophospholipids Are the Most Abundant Lipids of Membranes

Glycerophospholipids (phosphoglycerides) have a glycerol molecule as the basic component to which phosphoric acid is esterified at the α carbon (Figure 5.3) and two long-chain fatty acids are esterified at the remaining carbon atoms (Figure 5.4). Glycerol does not contain an asymmetric carbon, but the α -carbon atoms are not stereochemically identical. Esterification of a phosphate to an α carbon makes the molecule asymmetric. The naturally occurring glycerophospholipids are designated by the stereospecific numbering system (*sn*) (Figure 5.3) discussed on p. 397.

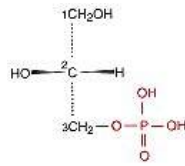

Figure 5.3
Stereochemical configuration of L-glycerol 3-phosphate (*sn*-glycerol 3-phosphate).

The H and OH attached to C-2 are above and C-1 and C-3 are below the plane of the page.

1,2-Diacylglycerol 3-phosphate, **phosphatidic acid**, is the parent compound of a series of glycerophospholipids, where different hydroxyl-containing compounds are esterified to the phosphate. The major compounds attached by a phosphodiester bridge to glycerol are choline, ethanolamine, serine, glycerol, and inositol. These structures are presented in Figure 5.5. **Phosphatidylethanolamine** (ethanolamine glycerophospholipids or the trivial name cephalin) and **phosphatidylcholine** (choline glycerophospholipid or lecithin) are the most common glycerophospholipids in membranes (Figure 5.6). **Phosphatidylglycerol phosphoglyceride** (Figure 5.7) (diphosphatidylglycerol or cardiolipin) contains two phosphatidic acids linked by a glycerol and is found nearly exclusively in mitochondrial inner membranes and bacterial membranes.

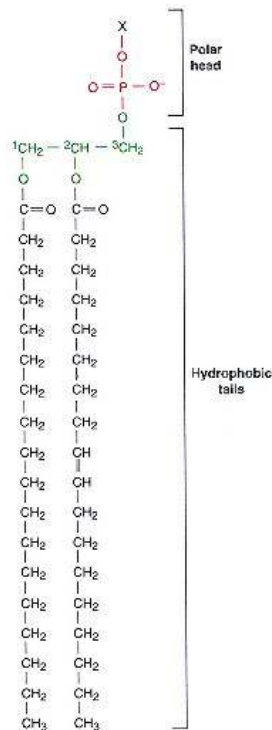

Figure 5.4
Structure of glycerophospholipid.

Long-chain fatty acids are esterified at C-1 and C-2 of the L-glycerol 3-phosphate.

X can be a H (phosphatidic acid) or one of several alcohols presented in Figure 5.5.

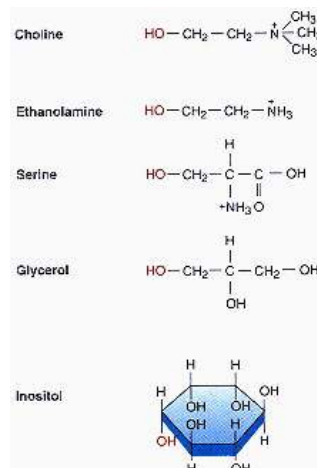

Figure 5.5
Structures of the major alcohols esterified to phosphatidic acid to form the glycerophospholipid.

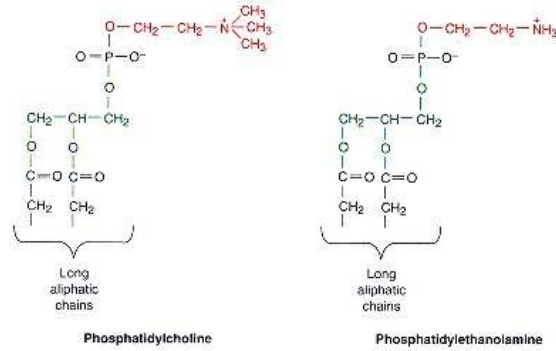

Figure 5.6
Structures of the two most common glycerophospholipids—
phosphatidylcholine and phosphatidylethanolamine.

Inositol, a hexahydroxy alcohol, is esterified to phosphate in phosphatidylinositol (Figure 5.8). 4-Phospho- and **4,5-bisphosphoinositol glycerophospholipids** (Figure 5.8) are present in plasma membranes; the latter is the source of **inositol triphosphate** and diacylglycerol that are involved in hormone action (see p. 865).

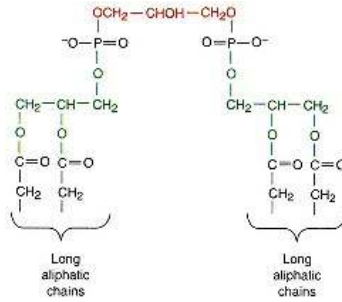

Figure 5.7
Phosphatidylglycerol phosphoglyceride
(cardiolipin).

Glycerophospholipids contain two fatty acyl groups esterified to carbon atoms 1 and 2 of glycerol; some of the major fatty acids found in glycerophospholipids are presented in Table 5.1. A saturated fatty acid is usually found on C-1 of the glycerol and an unsaturated fatty acid on C-2. Designation of different glycerophospholipids does not specify which fatty acids are present. Phosphatidylcholine usually contains palmitic or stearic in the *sn*-1 position and a C18 unsaturated fatty acid, oleic, linoleic, or linolenic, on the *sn*-2 carbon. Phosphatidylethanolamine contains palmitic or oleic on *sn*-1 but a long-chain polyunsaturated fatty acid, such as arachidonic, on the *sn*-2 position.

A saturated fatty acid is a straight chain, as is a fatty acid with an unsaturation in the *trans* position. A *cis* double bond, however, creates a kink in the hydrocar-

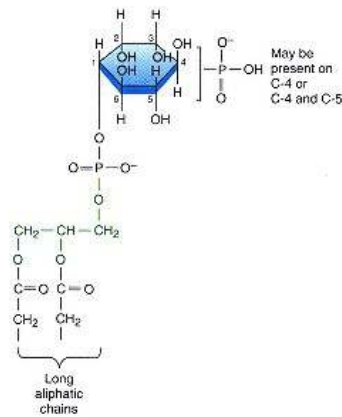

Figure 5.8
Phosphatidylinositol.
Phosphate groups are also found on C-4 or C-4 and C-5 of the inositol. The additional phosphate groups increase the charge on the polar head of this glycerophospholipid.

TABLE 5.1 Major Fatty Acids in Glycerophospholipids

Common Name	Systematic Name	Structural Formula
Myristic acid	<i>n</i> -Tetradecanoic	$\text{CH}_3-(\text{CH}_2)_{12}-\text{COOH}$
Palmitic acid	<i>n</i> -Hexadecanoic	$\text{CH}_3-(\text{CH}_2)_{14}-\text{COOH}$
Palmitoleic acid	<i>cis</i> -9-Hexadecenoic	$\text{CH}_3-(\text{CH}_2)_5-\text{CH}=\text{CH}-(\text{CH}_2)_7-\text{COOH}$
Stearic acid	<i>n</i> -Octadecanoic	$\text{CH}_3-(\text{CH}_2)_{16}-\text{COOH}$
Oleic acid	<i>cis</i> -9-Octadecenoic acid	$\text{CH}_3-(\text{CH}_2)_7-\text{CH}=\text{CH}-(\text{CH}_2)_7-\text{COOH}$
Linoleic acid	<i>cis,cis</i> -9,12-Octadecadienoic	$\text{CH}_3-(\text{CH}_2)_3-(\text{CH}_2-\text{CH}=\text{CH})_2-(\text{CH}_2)_7-\text{COOH}$
Linolenic acid	<i>cis,cis,cis</i> -9,12,15-Octadecatrienoic	$\text{CH}_3-(\text{CH}_2-\text{CH}=\text{CH})_3-(\text{CH}_2)_7-\text{COOH}$
Arachidonic acid	<i>cis,cis,cis,cis</i> -5,8,11,14-Icosatetraenoic	$\text{CH}_3-(\text{CH}_2)_3-(\text{CH}_2-\text{CH}=\text{CH})_4-(\text{CH}_2)_3-\text{COOH}$

bon chain (Figure 5.9). A straight chain diagram, as shown in Figures 5.4 and 5.9, does not adequately represent the chemical configuration of a long-chain fatty acid. Actually, there is a high degree of coiling of the hydrocarbon chain in a glycerophospholipid that is disrupted by a double bond. The presence of unsaturated fatty acids has a marked effect on the physicochemical state of the membrane (see p. 195).

Glycerol ether phospholipids contain a long aliphatic chain in ether linkage to the glycerol at the *sn*-1 position (Figure 5.10). Ether phospholipids contain an alkyl group (alkyl acylglycerophospholipid) or an α , β -unsaturated ether, termed a **plasmalogen**. The latter groups are more prevalent in membranes. Plasmalogens containing ethanolamine (ethanolamine plasmalogen) and choline (choline plasmalogen) esterified to the phosphate are abundant in nervous tissue and heart but not in liver. In human hearts more than 50% of the ethanolamine glycerophospholipids are plasmalogens.

Glycerophospholipids are **amphipathic**, containing both a polar end, or head group, due to the charged phosphate and substitutions on the phosphate, and a nonpolar tail due to hydrophobic hydrocarbon chains of the fatty acyl

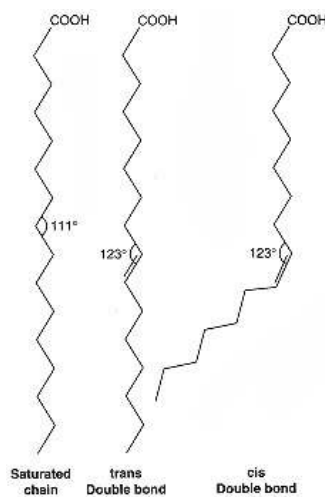

Figure 5.9
Conformation of fatty acyl groups
in phospholipids.

The saturated and unsaturated fatty acids with trans double bonds are straight chains in their minimum energy conformation, whereas a chain with a cis double bond has a bend. The trans double bond is rare in naturally occurring fatty acids.

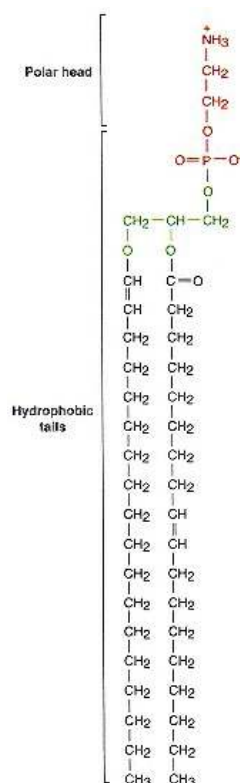

Figure 5.10
Ethanolamine plasmalogen.
Note the ether linkage of the
aliphatic chain on C-1 of glycerol.

TABLE 5.2 Predominant Charge on Glycerophospholipids and Sphingomyelin at pH 7.0

Lipid	Phosphate Group	Base	Net Charge
Phosphatidylcholine	-1	+1	0
Phosphatidylethanolamine	-1	+1	0
Phosphatidylserine	-1	+1, -1	-1
Phosphatidylglycerol	-1	0	-1
Diphosphatidylglycerol (cardiolipin)	-2	0	-2
Phosphatidylinositol	-1	0	-1
Sphingomyelin	-1	+1	0

groups. The polar groups are charged at pH 7.0 with a negative charge due to ionization of the phosphate group ($pK_a \approx 2$) and charges from groups esterified to phosphate (Table 5.2). Choline and ethanolamine glycerophospholipids are zwitterions at pH 7.0, with both a negative charge from phosphate and a positive charge on nitrogen. Phosphatidylserine has two negative charges, one on phosphate and one on the carboxyl group of serine, and a positive charge on the α -amino group of serine, with a net charge of -1 at pH 7.0. In contrast, glycerophospholipids containing inositol and glycerol have only a single negative charge on phosphate; 4-phospho- and 4,5-bisphosphoinositol derivatives are very polar compounds with additional negative charges on the phosphate groups.

Every tissue and cellular membrane has a distinctive composition of glycerophospholipids and a definite pattern in fatty acid composition. There is a greater variability in the fatty acyl groups of different tissues in a single species than in the fatty acyl groups of the same tissue in a variety of species. In addition, the fatty acid content of the glycerophospholipids can vary, depending on the physiological or pathophysiological state of the tissue.

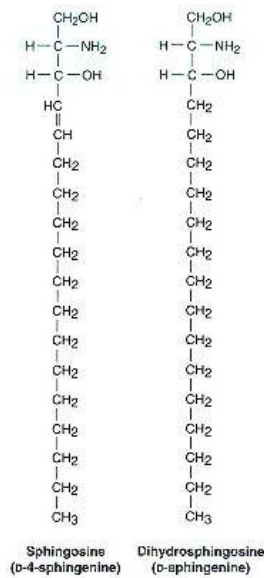

Figure 5.11 Structures of sphingosine and dihydrosphingosine.

Sphingolipids Are Also Present in Membranes

The amino alcohols **sphingosine** (D-4-sphingenine) and **dihydrosphingosine** (Figure 5.11) are the basis for another series of membrane lipids, the **sphingolipids**. A **ceramide** is sphingosine with a saturated or unsaturated long-chain fatty acyl group in amide linkage on the amino group (Figure 5.12). With two nonpolar tails a ceramide is similar in structure to diacylglycerol. Various substitutions are found on the hydroxyl group at position 1. The sphingomyelin series has phosphorylcholine esterified to the 1-OH (Figure 5.13) and is the most abundant sphingolipid in mammalian tissues. The similarity of this structure to choline glycerophospholipids is apparent, and they have many properties in common; note that the sphingomyelins are amphipathic compounds with a charged head group. Sphingomyelins and glycerophospholipids are classified as phospholipids. The sphingomyelin of myelin contains predominantly the longer chain fatty acids, with carbon lengths of 24; as with glycerophospholipids, there is a specific fatty acid composition of the sphingomyelin, depending on the tissue.

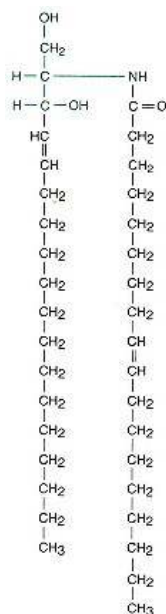

Figure 5.12 Structure of a ceramide.

Glycosphingolipids do not contain phosphate and have a sugar attached by a β -glycosidic linkage to the 1-OH group of the sphingosine in a ceramide. One subgroup is the **cerebrosides**, which contain either a glucose (**glucocerebrosides**) or galactose (**galactocerebrosides**) attached to a ceramide (Figure 5.14). Cerebrosides are neutral compounds. Galactocerebrosides are found predominantly in brain and nervous tissue, whereas the small quantities of cerebrosides in nonneural tissues usually contain glucose. **Phrenosin**, a specific galac-

tocerebroside, contains a 2-OH C₂₄ fatty acid. Galactocerebroside may contain a sulfate group esterified on the 3 position of the sugar. They are called **sulfatides** (Figure 5.15). Cerebroside and sulfatides usually contain fatty acids with 22–26 carbon atoms.

In place of monosaccharides, neutral glycosphingolipids often have 2 (dihexosides), 3 (trihexosides), or 4 (tetrahexosides) sugar residues attached to the 1-OH group of sphingosine. Diglucose, digalactose, *N*-acetylglucosamine, and *N*-acetyldigalactosamine are the usual sugars.

The most complex group of glycosphingolipids, the **gangliosides**, contain oligosaccharide head groups with one or more residues of sialic acid; these are amphipathic compounds with a negative charge at pH 7.0. The gangliosides represent 5–8% of the total lipids in brain, and some 20 different types have been identified differing in the number and relative position of the hexose and sialic acid residues. This is the basis of their classification; a detailed description of the nomenclature and structures of gangliosides is presented on p. 426.

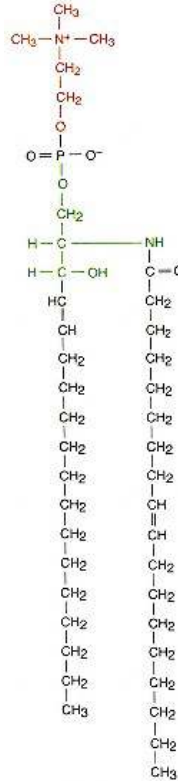

Figure 5.13
Structure of a choline containing sphingomyelin.

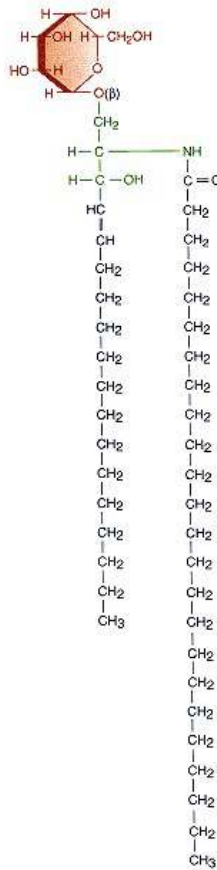

Figure 5.14
Structure of a galactocerebroside containing a C₂₄ fatty acid.

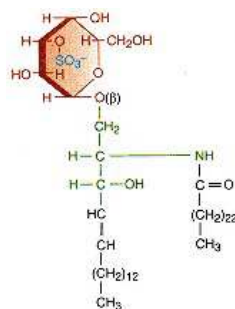

Figure 5.15
Structure of a sulfatide.

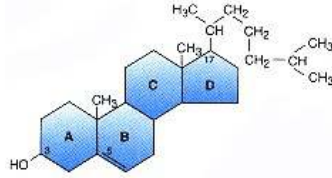

Figure 5.16
Structure of cholesterol.

Most Membranes Contain Cholesterol

Cholesterol is the third major lipid in membranes. With four fused rings and an eight-member branched hydrocarbon chain attached to the D ring at position 17, cholesterol is a compact, rigid, hydrophobic molecule (Figure 5.16). It also has a polar hydroxyl group at C-3.

Lipid Composition Varies in Different Membranes

There are quantitative differences between the classes of lipids and individual lipids in various cell membranes (Figure 5.17). The lipid composition is very similar in the same intracellular membrane of a specific tissue in different species. The plasma membrane exhibits the greatest variation in percentage composition because the amount of cholesterol is affected by the nutritional state of the animal. Plasma membranes have the highest concentration of neutral lipids and sphingolipids; myelin membranes of axons of neural tissue are rich in sphingolipids, with a high proportion of glycosphingolipids. Intracellular membranes primarily contain glycerophospholipids with little sphingolipids or cholesterol. The membrane lipid composition of mitochondria, nuclei, and rough endoplasmic reticulum are similar, with Golgi membrane being somewhere between other intracellular membranes and the plasma membrane. As indicated previously, cardiolipin is found nearly exclusively in the inner mitochondrial membrane. Choline containing lipids, phosphatidylcholine, and sphingomyelin, are predominant, with ethanolamine glycerophospholipid second. The constancy of composition of various membranes indicates the relationship between lipids and the specific functions of individual membranes.

Membrane Proteins Are Classified Based on Their Ease of Removal

Membrane proteins are classified on the basis of ease of removal from isolated membrane fractions. **Peripheral (or extrinsic) proteins** are released from a

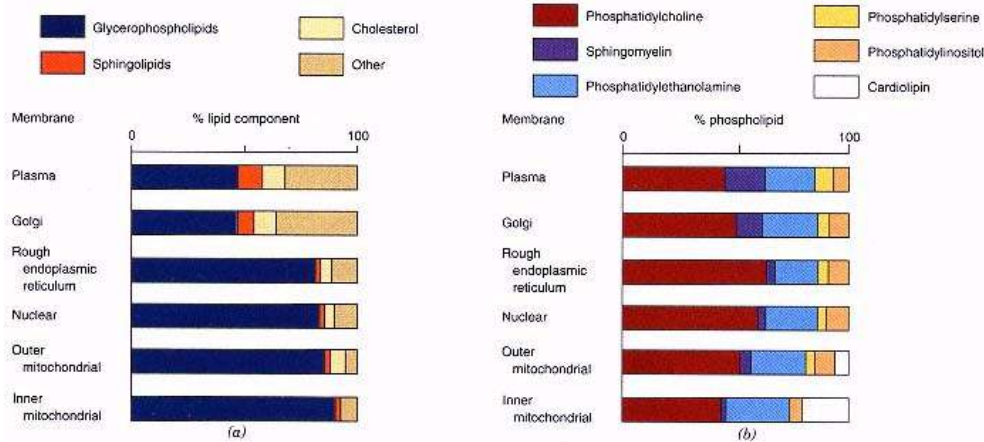

Figure 5.17
Lipid composition of cellular membranes isolated from rat liver.
(a) Amount of major lipid components as percentage of total lipid. The area labeled "Other" includes mono-, di-, and triacylglycerol, fatty acids, and cholesterol esters.
(b) Phospholipid composition as a percentage of total phospholipid.
Values from R. Harrison and G. G. Lunt, *Biological Membranes*. New York Wiley, 1975.

membrane by treatment with salt solutions of different ionic strength or extremes of pH, and named to imply a physical location on the surface of the membrane. Peripheral proteins, many of which are enzymes, are usually soluble in water and free of lipids. **Integral (or intrinsic) proteins** require rather drastic treatment, such as use of detergents or organic solvents, to be separated from a membrane. They usually contain tightly bound lipid, which if removed leads to denaturation of the protein and loss of biological function. Integral proteins have sequences of hydrophobic amino acids, which create hydrophobic domains in the tertiary structure. These hydrophobic regions interact with the hydrophobic hydrocarbons of the lipids stabilizing the protein–lipid complex. Removal of integral proteins leads to disruption of the membrane, whereas peripheral proteins can be removed with little or no change in the integrity of the membrane.

Proteolipids are hydrophobic **lipoproteins** soluble in chloroform and methanol but insoluble in water. They are present in many membranes but particularly in myelin, where they represent about 50% of the protein component. An example is lipophilin, a major lipoprotein of brain myelin that contains over 65% hydrophobic amino acids and covalently bound fatty acids.

Another class of integral membrane proteins is the **glycoproteins**; plasma membranes of cells contain a number of different glycoproteins, each with its own unique carbohydrate content.

The complexity, variety, and interaction of membrane proteins with lipids are just being resolved. Many of the proteins are enzymes located within or on the cellular membranes. Membrane proteins have a role in transmembrane movement of molecules and as receptors for the binding of hormones and growth factors. In many cells, such as neurons and erythrocytes, membrane proteins have a structural role to maintain the shape of the cell. Thus individual membrane proteins can have a *catalytic, transport, receptor, structural, or recognition role*. It is not surprising to find a high protein content in a membrane being correlated with the complexity and variety of functions of a membrane.

Carbohydrates of Membranes Are Present As Glycoproteins or Glycolipids

Carbohydrates present in membranes are **oligosaccharides** covalently attached to proteins to form glycoproteins and to a lesser amount to lipids to form glycolipids. The sugars found in glycoproteins and glycolipids include glucose, galactose, mannose, fucose, *N*-acetylgalactosamine, *N*-acetylglucosamine, and sialic acid (see Figure 5.18 and the Appendix for structures). Structures of glycoproteins and glycolipids are presented on pages 348 and 422, respectively. The carbohydrate is on the exterior side of the plasma membrane or the luminal side of the endoplasmic reticulum. Roles for membrane carbohydrates include cell–cell recognition, adhesion, and receptor action.

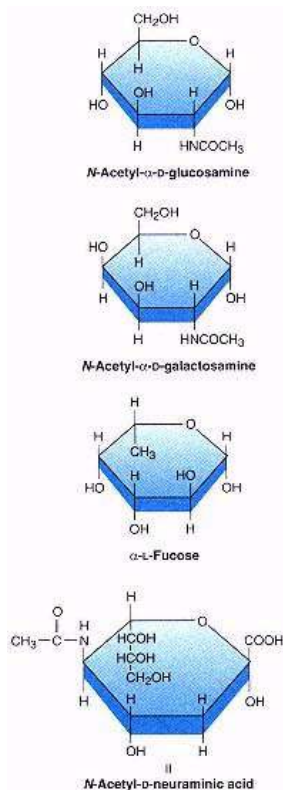

Figure 5.18
Structures of some
membrane carbohydrates.

5.3—

Micelles and Liposomes

Lipids Form Vesicular Structures

The basic structural characteristic of membranes is derived from the physicochemical properties of the major lipid components, the glycerophospholipids and sphingolipids. These amphipathic compounds, with a hydrophilic head and a hydrophobic tail (Figure 5.19a), will at appropriate concentrations interact in an aqueous system to form spheres, termed **micelles** (Figure 5.19b). The hydrophobic tails interact to exclude water and charged polar head groups will be on the outside of the sphere. The specific concentration of lipid required for micelle formation is referred to as the **critical micelle concentration**. Micelles with a single lipid or a mixture of lipids can be made. Formation of

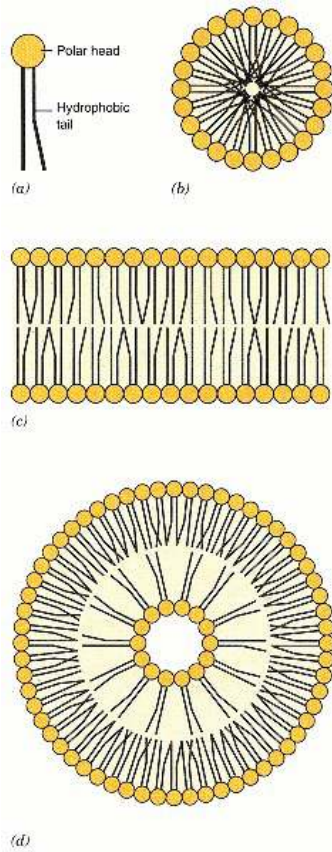

Figure 5.19
Representations of the interactions
of phospholipids in an aqueous medium.
 (a) Representation of an amphipathic lipid.
 (b) Cross-sectional view of the structure of a micelle.
 (c) Cross-sectional view of the structure of lipid bilayer.
 (d) Cross section of a liposome. Each structure has an inherent stability due to the hydrocarbon chains and the attraction of the polar head groups to water.

micelles depends also on the temperature of the system and, if a mixture of lipids are used, on the ratio of concentrations of the different lipids in the mixture (see p. 1079). The micelle structure is very stable because of hydrophobic interaction of hydrocarbon chains and attraction of polar groups to water. Micelles are important in the digestion of lipids (see p. 1081).

Liposomes Have a Membrane Structure Similar to Biological Membranes

Depending on conditions, amphipathic lipids such as glycerophospholipids will form a bimolecular leaf structure with two layers of lipid. The polar head groups will be at the interface between the aqueous medium and the lipid, and the hydrophobic tails will interact to form an environment that excludes water (Figure 5.19c). This bilayer conformation is the basic lipid structure of all biological membranes.

Lipid bilayers are extremely stable structures held together by noncovalent interactions of the hydrocarbon chains and ionic interactions of charged head groups with water. Hydrophobic interactions of the hydrocarbon chains lead to the smallest possible area for water to be in contact with the chains, and water is essentially excluded from the interior of the bilayer. If disrupted, bilayers will self-seal because hydrophobic groups will seek to establish a structure in which there is minimal contact of the hydrocarbon chains with water, a condition that is most favorable thermodynamically. A lipid bilayer will close in on itself, forming a spherical vesicle separating the external environment from an internal compartment. Such vesicles are termed **liposomes**. Because individual lipid–lipid interactions have low energies of activation, lipids in a bilayer have a circumscribed mobility, breaking and forming interactions with surrounding molecules but not readily escaping from the lipid bilayer (Figure 5.19d). Self-assembly of amphipathic lipids into bilayers is an important characteristic and is involved in formation of cell membranes.

Individual phospholipid molecules exchange places with neighboring molecules in a bilayer, leading to rapid lateral diffusion in the plane of the membrane (Figure 5.20). There is rotation around the carbon–carbon bonds in fatty acyl chains; in fact, there is a greater degree of rotation nearer the methyl end,

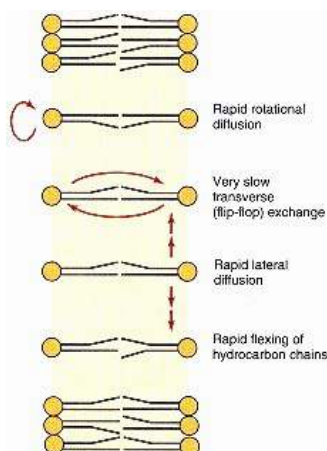

Figure 5.20
 Mobility of lipid components in membranes.

leading to greater motion at the center than the peripheral region of the lipid bilayer. Individual lipid molecules, however, do not migrate readily from one monolayer to the other, a transverse movement, termed flip-flop, because of the thermodynamic constraints on movement of a charged head group through the lipophilic core. Thus lipid bilayers have an inherent stability and a fluidity in which individual molecules move rapidly in their own monolayer but do not readily exchange with an adjoining monolayer. In artificial bilayer membranes composed of different lipids, the components will be distributed randomly.

Artificial membrane systems have been studied extensively in order to understand the properties of biological membranes. A variety of techniques are available to prepare liposomes, using synthetic phospholipids and lipids extracted from natural membranes. Depending on the procedure, unilamellar and multilamellar (vesicles within vesicles) vesicles of various sizes (20 nm to 1 μm diameter) can be prepared. Figure 5.19d contains a representation of a liposome structure. The interior of the vesicle is an aqueous environment, and it is possible to prepare liposomes with different substances entrapped. Both the external and internal environments of liposomes can be manipulated and properties—including ability to exclude molecules, interaction with various substances, and stability under different conditions—of these synthetic membranes have been studied. Na^+ , K^+ , Cl^- , and most polar molecules do not readily diffuse across lipid bilayers of liposomes, whereas the bilayer presents no barrier to water. Lipid-soluble nonpolar substances such as triacylglycerol and undissociated organic acids readily diffuse into the membrane remaining in the hydrophobic environment of the hydrocarbon chains. Proteins have been incorporated into liposomes to mimic a natural membrane. Membrane-bound enzymes and proteins involved in translocating ions have been isolated from various tissues and incorporated into the membrane of liposomes for evaluation of the protein's function. With liposomes it is easier to manipulate the various parameters of membrane systems and thus study various activities free of interfering reactions present in cell membranes. Liposomes are used in delivery of drugs in humans (see Clin. Corr. 5.1).

CLINICAL CORRELATION 5.1

Liposomes As Carriers of Drugs and Enzymes

A major obstacle in the use of many drugs is lack of tissue specificity in the action of the drug. Administration of drugs orally or intravenously leads to a drug acting on many tissues and not exclusively on a target organ, resulting in toxic side effects. An example is the commonly observed suppression of bone marrow cells by anticancer drugs. Some drugs are metabolized rapidly and their period of effectiveness is relatively short.

Liposomes have been prepared with drugs, enzymes, and DNA encapsulated inside and used as carriers for these substances to target organs. Liposomes prepared from purified phospholipids and cholesterol are nontoxic and biodegradable. Alteration of surface charge enhances drug incorporation and release. Attempts have been made to prepare liposomes for interaction at a specific target organ. Antibiotic, antineoplastic, antimalarial, antiviral, antifungal, and anti-inflammatory agents have been found to be effective when administered in liposomes. Some drugs have a longer period of effectiveness when administered encapsulated in liposomes. It may be possible to prepare liposomes with a high degree of tissue specificity so that drugs and perhaps even enzyme replacement can be carried out with this technique.

Ranade, V. V. Drug delivery systems. 1. Site-specific drug delivery using liposomes as carriers. *J. Clin. Pharmacol.* 29:685, 1989; Caplen, N. J., Gao, X., Hayes, P., et al. Gene therapy for cystic fibrosis in humans by liposome-mediated DNA transfer: the production of resources and the regulatory process. *Gene Ther.* 1:139, 1994; and Gregoriadis, G. Engineering liposomes for drug delivery: progress and problems. *Trends Biotechnol.* 13:527, 1995.

5.4—

Structure of Biological Membranes

Fluid Mosaic Model of Biological Membranes

Based on evidence from physicochemical, biochemical, and electron microscopic investigations, knowledge of membrane structure has evolved. All biological membranes have a **bimolecular leaf** arrangement of lipids, as in liposomes. The amphipathic lipids and cholesterol are oriented so that hydrophobic portions of the molecules interact, minimizing their contact with water or other polar groups, and polar head groups of lipids are at the interface with the aqueous environment. J. D. Davson and J. Danielli in 1935 proposed this model for a membrane; their proposal was later refined by J. D. Robertson. A major question with the earlier models was how to explain the interaction of membrane proteins with the lipid bilayer. In the early 1970s, S. J. Singer and G. L. Nicolson proposed the mosaic model for membranes in which some proteins (intrinsic) are actually immersed in the lipid bilayer while others (extrinsic) are loosely attached to the surface of the membrane. It was suggested that some proteins spanned the lipid bilayer being in contact with the aqueous environment on both sides. Figure 5.21 is a current representation of a biological membrane and is referred to as the **fluid mosaic model** to indicate the movement of both lipids and proteins in the membrane. The characteristics of the lipid bilayer explain many of the observed cellular membrane properties, including fluidity, flexibility that permits changes of shape and form, ability to self-seal, and impermeability. The model continues to undergo modification and refinement;

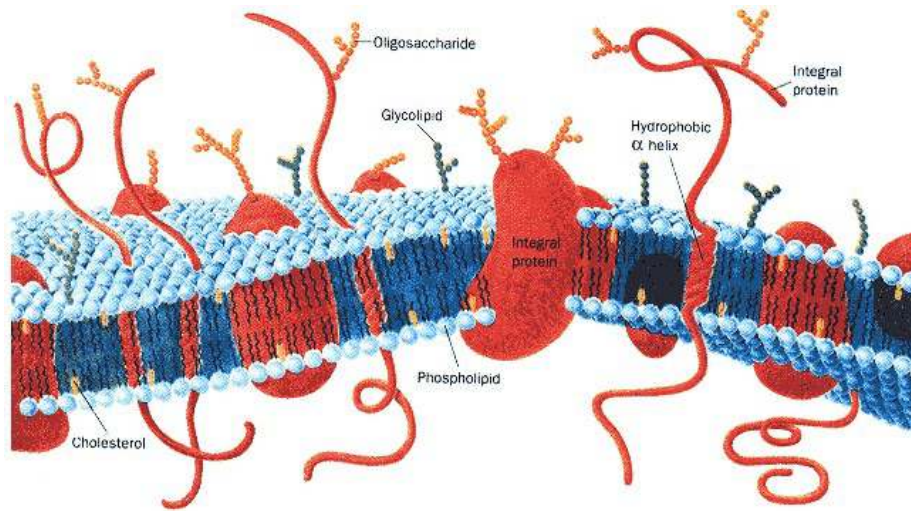

Figure 5.21
Fluid mosaic model of biological membranes.

Figure reproduced with permission from D. Voet and J. Voet, *Biochemistry*, 2nd ed. New York: Wiley, 1995.

as an example, under some conditions membrane lipids can assume structural variations other than the bimolecular leaf arrangement.

Integral Membrane Proteins Are Immersed in Lipid Bilayer

The development of techniques for isolation of integral membrane proteins, for determination of their primary structure, and for identification of specific functional domains in the protein has led to an understanding of the structural relationship between the hydrophobic lipid bilayer and membrane proteins. Figure 5.22 illustrates the various ways of attachment of proteins to a biological membrane. Some integral membrane proteins (see p. 187) span the membrane, whereas others may only be immersed partially in the lipid. Based on measurements of the hydrophobicity of the amino acid residues and partial proteolytic digestion of proteins, sequences of amino acids embedded in the membrane have been determined. Some proteins contain an α -helical structure consisting primarily of hydrophobic amino acids (such as leucine, isoleucine, valine, and phenylalanine), which is the transmembrane sequence. This is illustrated in Figure 5.22*a*. An example is **glycophorin** present in the plasma membrane of human erythrocytes; amino acid residues 73–91, of the 131 total amino acids, are the transmembrane sequence and are predominantly hydrophobic. Glycophorin has three domains: a sequence exterior to the cell containing the amino terminal end, the transmembrane sequence, and a sequence extending into the cell with the carboxyl-terminal end. In other transmembrane proteins the amino acid chain loops back and forth across the membrane (Figure 5.22*b*). In some cases there are 12 loops snaking across the lipid bilayer. Often these multiple α helices spanning the membrane are organized to form a tubular structure. The **anion channel** of human erythrocytes, which has 926 amino acids and is responsible for the exchange of Cl^- and HCO_3^- across the membrane, is an example (see p. 204). Secondary and tertiary structures of proteins are critical

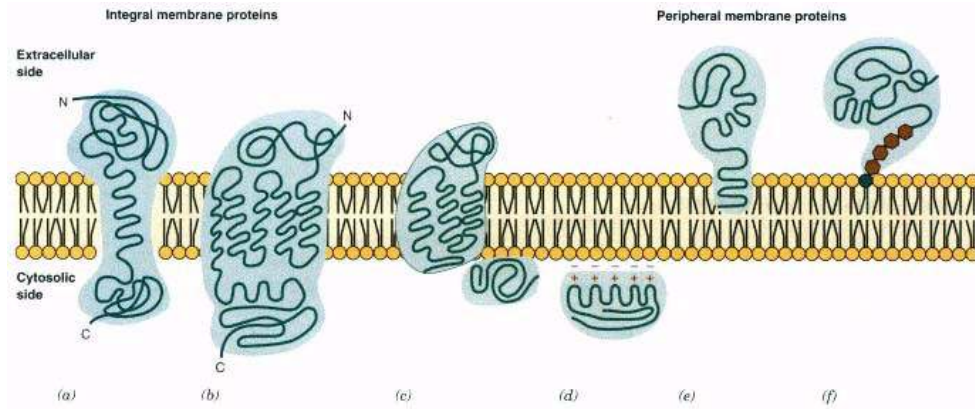

Figure 5.22
Interactions of membrane proteins with the lipid bilayer.

Diagram illustrates the multiple types of binding of proteins in or to the lipid bilayer:

- (a) a single transmembrane segment;
- (b) multiple transmembrane segments;
- (c) bound to an integral protein;
- (d) bound electrostatically to the lipid bilayer;
- (e) attached by a short terminal hydrophobic sequence of amino acids; and
- (f) attached by covalently bound lipid.

in the topography of the protein in the membrane. Some proteins in membranes form a quaternary structure with multiple subunits.

Integral membrane proteins have specific domains, for ligand binding, catalytic activity, and attachment of carbohydrate or lipid. The anion channel of the erythrocyte has two major domains: a hydrophilic amino-terminal domain on the cytosolic side of the membrane with binding sites for ankyrin, a protein that anchors the cytoskeleton and other cytosolic proteins, and a domain with 509 amino acids that traverses the membrane and mediates the exchange of Cl^- and HCO_3^- . Glycophorin contains 60% carbohydrate, all of which is attached to the protein domain on the extracellular side of the membrane. With such well-defined domains, integral membrane proteins have a defined orientation in the membrane rather than a random one. Specific structural orientation demonstrates another important aspect of membrane structure; biological membranes are asymmetric, with each surface having specific characteristics. The orientation of proteins is fixed during the synthesis of the membrane or replacement of the protein; the bulkiness of the proteins, as well as thermodynamic restrictions, prevents transverse (flip-flop) movement.

Many enzymes that are integral membrane proteins require the presence of the membrane lipid for activity. As an example, D- β -hydroxybutyrate dehydrogenase, located in the inner mitochondrial membrane, requires phosphatidylcholine for activity. Cholesterol has been implicated in the activity of various membrane ion pumps, including Na^+ , K^+ - and Ca^{2+} -ATPases (see p. 206), and acetylcholine receptors. Some of these modulating effects of lipids may be a reflection of a change in ordering and fluidity of the membrane but the lipid may also have a direct influence on the activity.

Peripheral Membrane Proteins Have Various Modes of Attachment

Peripheral membrane proteins are loosely attached to membranes and if removed do not disrupt lipid bilayers. Some apparently bind to integral membrane proteins, such as **ankyrin** binding to the anion channel protein in erythro-

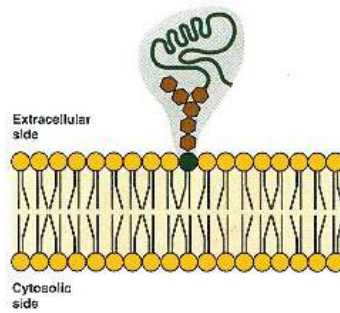

Figure 5.23
Attachment of a protein to a membrane by a glycosyl phosphatidylinositol anchor.

cytes (Figure 5.22c). Negatively charged phospholipids of membranes interact with positively charged regions of proteins allowing electrostatic binding (Figure 5.22d). Some peripheral proteins have sequences of hydrophobic amino acids at one end of the peptide chain that serve as an anchor in the membrane lipid (Figure 5.22e); cytochrome b_5 is attached to the endoplasmic reticulum by such an anchor.

Phosphatidylinositol has a role in anchoring proteins to membranes (Figures 5.22f and 5.23). A **glycan**, consisting of ethanolamine, phosphate, mannose, mannose, and glycosamine is covalently bound to the carboxyl terminal of the protein. This glycan has been conserved throughout evolution because it is found in different species attached to carboxyl-terminal amino acid residues of various membrane-bound proteins. Additional carbohydrate can be attached to the last mannose. The glycosamine of the glycan is covalently bonded to phosphatidylinositol. The fatty acids of this glycerophospholipid are inserted into the lipid membrane, thus anchoring the protein. These molecules are now referred to as **glycosyl phosphatidylinositol (GPI) anchors**. Various proteins are attached in this manner including enzymes, antigens, and cell adhesion proteins; a partial list is presented in Table 5.3. Fatty acyl groups of phosphatidylinositol are apparently specific for different proteins. To date, proteins found to be attached by a GPI anchor are on the external surface of plasma membranes. The significance of this form of anchoring has yet to be determined but it may be important for localization of the protein on a membrane, control of function of the protein, and controlled release of the protein from the membrane. A specific phosphatidylinositol-specific phospholipase C catalyzes the hydrolysis of the phosphate-inositol bond leading to release of the protein.

Myristic and palmitic acids can also be covalently linked to proteins and serve to anchor proteins by insertion of the acyl chain into the lipid bilayer (Figure 5.22f). Myristic acid (C_{14}) is attached by an amide linkage to an amino-terminal glycine, and palmitic acid (C_{16}) is most often attached by a thioester linkage to cysteine or by a hydroxyester bond to serine or threonine.

Even though membrane models suggest that proteins are randomly distributed throughout and on the membrane, there is a high degree of functional organization with definite restrictions on the localization of some proteins. As an example, proteins participating in electron transport in the inner membrane of mitochondria function in consort and are organized into functional units both laterally and transversely. The location of specific proteins on the surface of plasma membranes is also controlled. Cells lining the lumen of kidney nephrons have specific plasma membrane enzymes on the luminal surface but not on the contraluminal surface of cells; enzymes restricted to a particular region of the membrane are located to meet specific functions of these cells. Thus there is a high degree of molecular organization of biological membranes that is not apparent from diagrammatic models.

Human Erythrocytes Are Ideal for Studying Membrane Structure

The structure of the plasma membrane of the human erythrocyte has been investigated extensively because of the ease with which the membrane can be purified from other cellular components. Figure 5.24 is a representation of the interaction of some of the many proteins in this membrane.

TABLE 5.3 Proteins with a Glycosyl Phosphatidylinositol Anchor

Alkaline phosphatase
5 -Nucleotidase
Acetylcholinesterase
Trehalase
Renal dipeptidase
Lipoprotein lipase
Carcinoembryonic antigen
Neural cell adhesion molecule
Scrapie prion protein
Oligodendrocyte-myelin protein

Source: M. G. Low, Glycosyl-phosphatidylinositol: a versatile anchor for cell surface proteins. *FASEB J.* 3:1600, 1989.

Lipids Are Distributed in an Asymmetric Manner in Membranes

There is an **asymmetric distribution of lipid** components across biological membranes in contrast to the random distribution of lipids between the outer and inner lipid monolayers of liposomes. Each layer of the bilayer has a different composition with respect to individual glycerophospholipids and sphingolipids. An example is the asymmetric distribution of lipids in the human erythrocyte

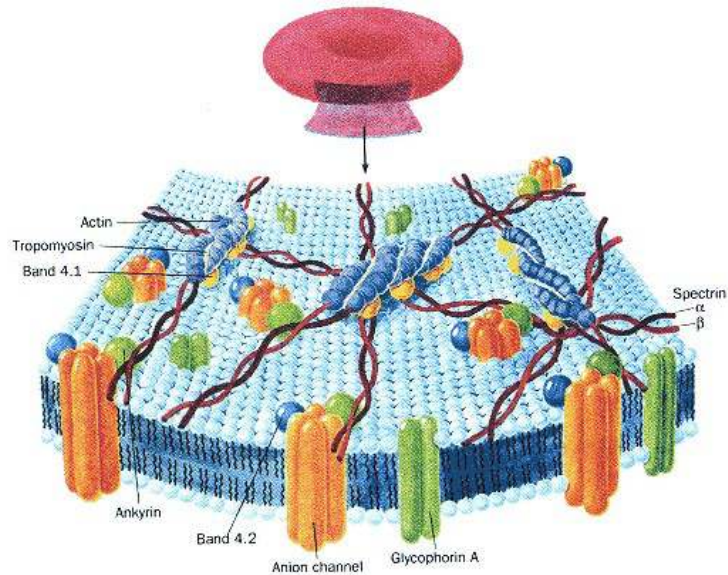

Figure 5.24
Schematic diagram of the erythrocyte membrane.

Diagram indicates the relationship of four membrane-associated proteins with the lipid bilayer. Glycophorin is a glycoprotein that contains 131 amino acids but whose function is unknown. Band 3, so designated because of its mobility in electrophoresis, contains over 900 amino acids and is involved in interacting with ankyrin and possibly in the facilitated diffusion of Cl^- and HCO_3^- (see Section 5.1). Ankyrin and spectrin are part of the cytoskeleton and are peripheral membrane proteins. Ankyrin binds to band 3 and spectrin is anchored to the membrane by ankyrin.

Figure reproduced with permission from D. Voet and J.

Voet, Biochemistry, 2nd ed., New York: Wiley, 1995.

membrane (Figure 5.25). Sphingomyelin is predominantly in the outer layer, whereas phosphatidylethanolamine is predominantly in the inner lipid layer. In contrast, cholesterol is equally distributed on both sides of the plasma membrane.

Asymmetry of lipids may be maintained by specific membrane proteins that promote the transverse movement of specific lipids from one side to the other. Metabolic energy may be involved in this process. Uncatalyzed transverse movement from one side to the other (i.e., flip-flop movement) of the glycerophospholipids and sphingolipids is slow. The asymmetry of lipids in erythrocyte membranes is an example of how slow is the transverse movement of membrane lipids. Mature erythrocytes have a lifetime of about 120 days, during which there is no new membrane synthesis or even significant repair. Even so, there appears to be little mixing of phospholipids between molecular layers. Individual lipids can exchange with lipids in the cell matrix, as well as with lipids of other membranes. Specific mechanisms to maintain both the composition and asymmetry of lipids in membranes apparently exist.

Proteins and Lipids Diffuse in Membranes

Interactions among different lipids and between lipids and proteins are very complex and dynamic. There is a **fluidity** in the lipid portion of

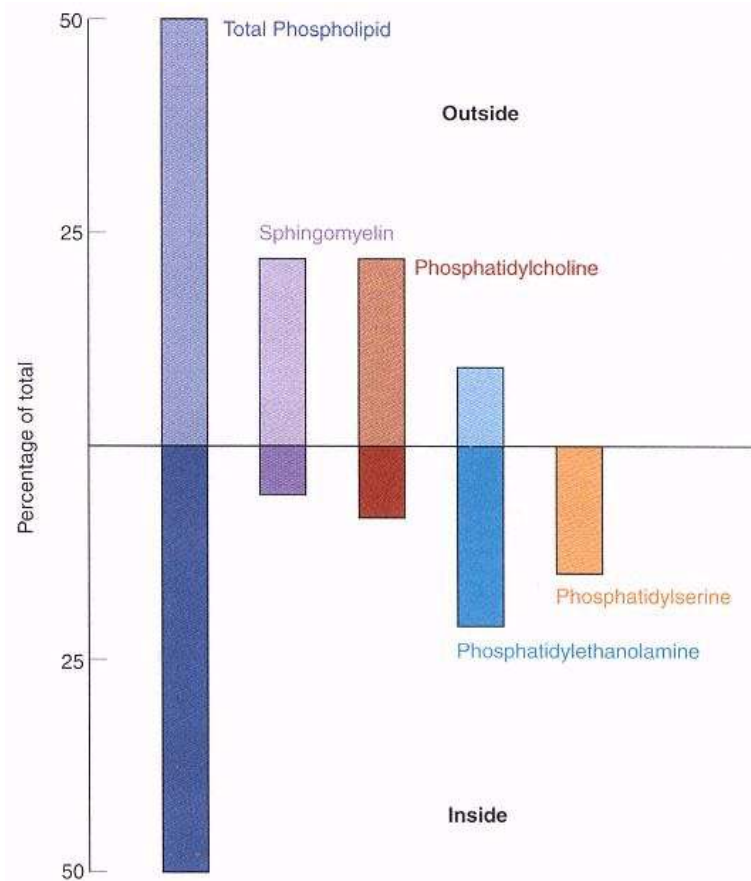

Figure 5.25

Distribution of phospholipids between inner and outer layers of the human erythrocyte membrane.

Values are percentage of each phospholipid in the membrane.
 Redrawn from A. J. Verkeij, R. F. A. Zwaal, B. Roelofsen, P. Comfurius, D. Kastelijn, and L. L. M. Van Deenan.
The asymmetric distribution of phospholipids in the human red cell membrane. Biochim. Biophys. Acta 323:178, 1973.

membranes in which both the lipids and proteins move. The degree of fluidity is dependent on the temperature and composition of the membrane. At low temperatures, lipids are in a gel-crystalline state, with lipids restricted in their mobility. As temperature is increased, there is a phase transition into a liquid-crystalline state, with an increase in fluidity (Figure 5.26). With liposomes prepared from a single pure phospholipid, the **phase transition temperature, T_m** , is rather precise; but with liposomes prepared from a mixture of lipids, T_m becomes less precise because individual clusters of lipids may be in either the gel-crystalline or liquid-crystalline state. T_m is not precise for biological membranes because of their heterogeneous chemical composition. Interactions between lipids and proteins lead to variations in the gel-liquid state throughout the membrane and differences in fluidity in different areas of the membrane.

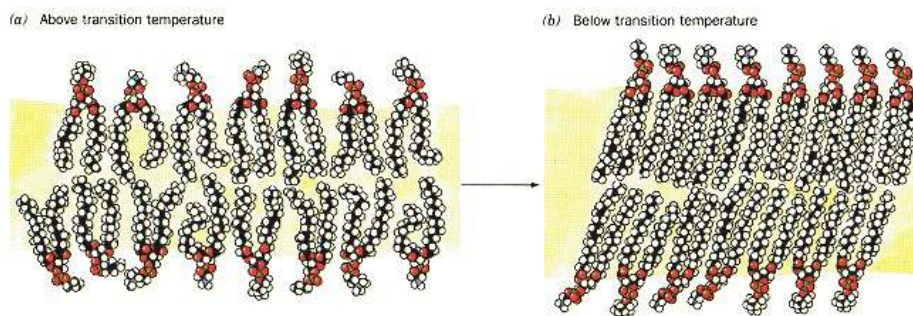

Figure 5.26

Structure of lipid bilayer above and below transition temperature.

Figure reproduced with permission from
 D. Voet and J. Voet, *Biochemistry*, 2nd ed. New York: Wiley, 1995. (After Robertson, R. N., *The Lively Membranes*, Cambridge, MA: Cambridge University Press, 1983.)

The specific composition of individual biological membranes leads to differences in fluidity. Glycerophospholipids containing short-chain fatty acids will increase the fluidity as does an increase in unsaturation of the fatty acyl groups. Cis double bonds in unsaturated fatty acids of phospholipids lead to kinks in the hydrocarbon chain, preventing the tight packing of the chains and creating pockets in the hydrophobic areas. It is assumed that these spaces, which will also be mobile due to the mobility of the hydrocarbon chains, are filled with water molecules and small ions. **Cholesterol** with its flat stiff ring structure reduces the coiling of the fatty acid chain and decreases fluidity. Consideration has been given to the potential clinical significance of high blood cholesterol on the fluidity of cell membranes (see Clin. Corr. 5.2). Ca^{2+} ion decreases the fluidity of membranes because of its interaction with the negatively charged phospholipids, reducing repulsion between polar groups and increasing packing of lipid molecules. This ion causes aggregation of lipids into clusters, reducing membrane fluidity.

Fluidity at different levels within the membrane also varies. The hydrocarbon chains of the lipids have a motion, which produces a fluidity in the hydrophobic core. The central area of a bilayer is occupied by ends of the hydrocarbon chains and is more fluid than areas closer to the two surfaces, where there are more constraints due to stiffer portions of the hydrocarbon chains. Cholesterol makes membranes more rigid toward the periphery because it does not reach into the central core of membranes.

Individual lipids and proteins move rapidly in a lateral motion along the surface of membranes. Electrostatic interactions of polar head groups, hydrophobic interactions of cholesterol with selected phospholipids or glycolipids, and protein–lipid interactions, however, lead to constraints on movement. There are lipid domains in which lipids move together as a unit.

Movement of integral membrane proteins in the lipid environment has been demonstrated by fusion of human and rat cells. When antigenic membrane proteins on cells of each species were labeled with different antibody markers, the markers indicated the localization of the proteins on the membrane. Immediately following fusion of the cells, proteins on the membranes of the human and rat cells were segregated in different hemispheres of the new cell, but within 40 minutes the two groups of proteins were evenly distributed over the membrane of the new cell. Movement of protein is slower than that of lipids and may be restricted by other membrane proteins, matrix proteins, or cellular structural elements such as microtubules or microfilaments to which they may be attached.

CLINICAL CORRELATION 5.2

Abnormalities of Cell Membrane Fluidity in Disease States

Membrane fluidity can control the activity of membrane-bound enzymes, membrane functions such as phagocytosis, and cell growth. A major factor in controlling the fluidity of the plasma membrane in higher organisms and mammals is the presence of cholesterol. With increasing cholesterol content the lipid bilayers become less fluid on their outer surface but more fluid in the hydrophobic core. Erythrocyte membranes of individuals with spur cell anemia have an increased cholesterol content. This condition occurs in severe liver disease such as cirrhosis of the liver in alcoholics. Erythrocytes have a spiny shape and are destroyed prematurely in the spleen. The cholesterol content is increased 25–65%, and the fluidity of the membrane is decreased. The erythrocyte membrane requires a high degree of fluidity for its function and any decrease would have serious effects on the cell's ability to pass through the capillaries. The increased plasma membrane cholesterol in other cells leads to an increase in intracellular membrane cholesterol, which also affects their fluidity. The intoxicating effect of ethanol on the nervous system is probably due to modification of membrane fluidity and alteration of membrane receptors and ion channels. Individuals with abetalipoproteinemia have an increase in sphingomyelin content and a decrease in phosphatidylcholine, thus causing a decrease in fluidity. The ramifications of these changes in fluidity are not completely understood, but it is presumed that, as techniques for the measurement and evaluation of cellular membrane fluidity improve, some of the pathological manifestations in disease states will be explained on the basis of changes in membrane structure and function.

Cooper, R. A. Abnormalities of cell membrane fluidity in the pathogenesis of disease. *N. Engl. J. Med.* 297:371, 1977.

Evidence is accumulating that the fluidity of cellular membranes can change in response to changes in diet or physiological state. Fatty acid and cholesterol content of membranes is modified by a variety of factors. In addition, pharmacological agents may have a direct effect on membrane fluidity. Anesthetics that induce sleep and muscular relaxation may have their action because of their effect on membrane fluidity of specific cells. A number of structurally unrelated compounds induce anesthesia, but their common feature is lipid solubility. Anesthetics increase membrane fluidity *in vitro*.

Thus cellular membranes are in a constantly changing state, with not only movement of proteins and lipids laterally on the membrane but with molecules moving into and out of the membrane. The membrane creates a number of microenvironments, from the hydrophobic portion of the core of the membrane to the interface with the surrounding environments. It is difficult to express in words or pictures the very fluid and dynamic state, in that neither captures the time-dependent changes that occur in the structure of biological membranes. Figure 5.27 attempts to illustrate the structural and movement aspects of cellular membranes.

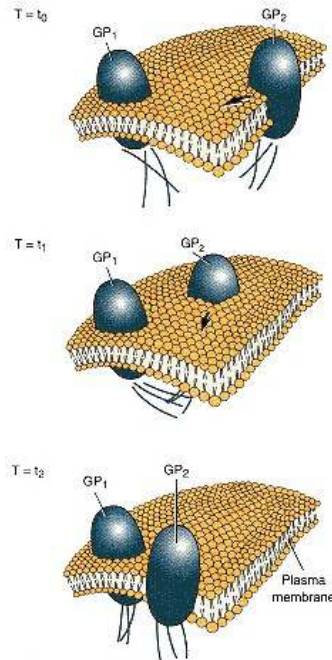

Figure 5.27
Modified version of the fluid mosaic model of biological membranes to indicate the mobility of membrane proteins.

t_0 , t_1 , and t_2 represent successive points in time. Some integral proteins (GP_2) are free to diffuse laterally in the plane of the membrane directed by the cytoskeletal components, whereas others (GP_1) may be restricted in their mobility.

5.5—

Movement of Molecules through Membranes

The lipid nature of biological membranes severely restricts the type of molecules that diffuse readily from one side to another. Inorganic ions or charged organic molecules do not diffuse at a significant rate because of their attraction to water molecules and exclusion of charged species by the hydrophobic environment of lipid membranes. The diffusion rate of carbohydrates, amino acids, and inorganic ions, however, is not zero but may be too slow to accommodate a cell's requirements for the substance. Where there is a need to move a substance across a cell membrane, specific mechanisms are available for its translocation.

The basic mechanisms by which molecules cross cellular membranes is presented in the following sections with examples of the processes for illustrative purposes. Specific systems are described in the context of individual metabolic processes in later chapters.

Some Molecules Can Diffuse through Membranes

Diffusion of a substance through a membrane involves three major steps: (1) solute must leave the aqueous environment on one side and enter the membrane; (2) solute must traverse the membrane; and (3) solute must leave the membrane to enter a new environment on the opposite side (Figure 5.28). Each step involves an equilibrium of solute between two states. Thermodynamic and kinetic constraints control the concentration equilibrium of a substance on two sides of a membrane and the rate at which it can attain equilibrium. Diffusion of gases such as O_2 , N_2 , CO_2 , and NO occur rapidly and depend entirely on the concentration gradient. **Water** diffuses readily through biological membranes; its movement occurs via gaps in the hydrophobic environment created by random movement of fatty acyl chains of lipids. Water and other small molecules move into these **transitory spaces** and equilibrate across the membrane from one gap to another. For diffusion of a solute with strong interaction with water molecules, the shell of water surrounding the solute must be stripped away before it enters the lipid milieu and then regained on leaving the membrane. Distribution of hydrophobic substances between the aqueous phase and lipid membrane will depend on the degree of lipid solubility of the substance; very lipid-soluble materials will dissolve in the membrane.

The **rate of diffusion** of a lipophilic substance is directly proportional to its lipid solubility and diffusion coefficient in lipids; the latter is a function of the size and shape of the substance. Uncharged lipophilic molecules, for exam-

ple, fatty acids and steroids, diffuse relatively rapidly but water-soluble substances, for example, sugars and inorganic ions, diffuse very slowly.

Direction of movement of solutes by diffusion is always from a higher to a lower concentration and the rate is described by **Fick's first law of diffusion**:

$$J = -D \left(\frac{\delta c}{\delta x} \right)$$

where J is the net amount of substance moved per time, D is the diffusion coefficient, and $\delta c/\delta x$ is the chemical gradient of substance. As the concentration of solute on one side of the membrane is increased, there will be an increasing *initial rate* of diffusion as illustrated in Figure 5.29. A *net movement* of molecules from one side to another will continue until the concentration in each is at chemical equilibrium. A continued exchange of solute molecules from one side to another occurs after equilibrium is attained but no net accumulation on one side can occur because this would recreate a concentration gradient if it occurred.

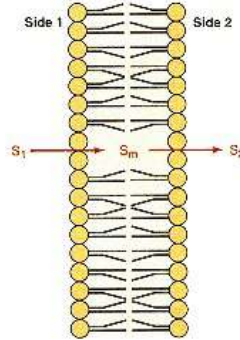

Figure 5.28
Diffusion of a solute molecule through a membrane.
 S₁ and S₂ are solutes on each side of the membrane, and S_m is a solute in the membrane.

Movement of Molecules across Membranes Can be Facilitated

Mechanisms for membrane translocation of various substances including sugars, amino acids, metabolic intermediates, inorganic ions, and even H⁺ have been determined. The plasma membrane of both prokaryotic and eukaryotic cells, as well as membranes of subcellular organelles, contain **transport systems** that have an important role in the uptake of nutrients, maintenance of ion concentrations, and control of metabolism. These systems involve intrinsic membrane proteins and are classified on the basis of their mechanism of translocation of substrate across the membrane and the energetics of the system. A classification of transport systems is presented in Table 5.4. Each will be discussed in more detail in subsequent sections but for now it is important to distinguish the three main types.

Membrane Channels

Membranes of most cells contain specific **channels**, in some cases referred to as **pores**, which permit the rapid movement of specific molecules or ions from one side of a membrane to the other. The tertiary and quaternary structures of these intrinsic membrane proteins create an aqueous hole in the membrane that permits diffusion of substances in both directions through the membrane. Like diffusion, the substances will move only in the direction of lower concentration, that is, down a concentration gradient. In contrast to transporters, the channel proteins do not bind the molecules or ions to be transported. The

TABLE 5.4 Classification of Membrane Translocation Systems

Type	Class	Example	
Channel	1. Voltage regulated	Na ⁺ channel	
	2. Chemically regulated	Acetylcholine receptor	
	3. cAMP regulated	Cl ⁻ channel	
	4. Other	Pressure sensitive	
Transporter	1. Passive mediated	Glucose transporter	
	2. Active mediated	a. Primary-redox coupled	Respiratory chain linked
		Primary-ATPases	Na ⁺ , K ⁺ -ATPase
	b. Secondary	Na ⁺ -dependent glycose transport	
Group translocation		Amino acid translocation	

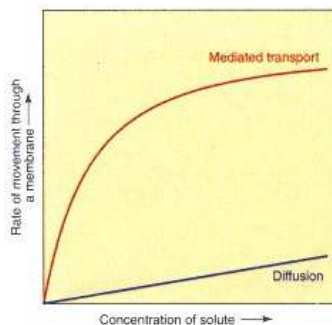

Figure 5.29
Kinetics of movement of a solute molecule through a membrane.
 The initial rate of diffusion is directly proportional to the concentration of the solute. In mediated transport, the rate will reach a V_{max} when the carrier is saturated.

channels have some degree of specificity, however, based on the size and charge of the substance. Flow through the channel can be regulated by opening and shutting the passageway, like a gate to a garden.

Transporters

Transporters actually translocate the molecule or ion across the membrane by binding and physically moving the substance. The activity can be evaluated in the same kinetic terms as an enzyme-catalyzed reaction except no chemical reaction occurs. Transporters have specificity for the substance to be transported, frequently referred to as the substrate, have defined reaction kinetics, and can be inhibited by both competitive and noncompetitive inhibitors. Some transporters only move substrates down their concentration gradient (referred to as passive transport), while others can move the substrate against its concentration gradient (active transport) requiring the expenditure of some form of energy. With both channels and transporters the molecule is unchanged following translocation across the membrane.

A major difference between membrane channels and transporters is the rate of substrate translocation; for a channel, rates in the range of 10^7 ions s^{-1} are usual, whereas with a transporter the rate is in the range of 10^2 – 10^3 molecules s^{-1} . The activity of all translocation systems can be modulated, permitting cells and tissues to control the movement of substances across membranes. Drugs for specific channels and transporters have been developed to control these processes.

Group Translocation

Group translocation involves not only movement of the substance across the membrane but also chemical modification of the substance during the process. One mechanism of uptake of sugars by bacteria involves transport and then phosphorylation of the sugar before release into the cytosol of the cell. In some mammalian cells uptake of amino acids involves a group translocation mechanism.

Membrane Transport Systems Have Common Characteristics

Membranes of all cells contain highly specific transporters for the movement of inorganic anions and cations (e.g., Na^+ , K^+ , Ca^{2+} , HPO_4^{2-} , Cl^- , and HCO_3^-), and uncharged and charged organic compounds (e.g., amino acids and sugars). Different cellular membranes have different transport systems; as an example, the mitochondrial membrane has a specific mechanism to translocate ADP and ATP that is not present in other cellular membranes. Transport systems involve integral membrane proteins with a high degree of specificity for the substances transported. These proteins or protein complexes have been designated by a variety of names, including **transporter**, **translocase**, **translocator**, **permease**, and **pump**, or termed **transporter system**, **translocation mechanism**, and **mediated transport system**. The designations above are used interchangeably, but for convenience we will use transporter or translocase when referring to the proteins involved in translocation.

Membrane transporters have a number of characteristics in common. Each facilitates the movement of a molecule or molecules through the lipid bilayer at a rate that is significantly faster than can be accounted for by simple diffusion. If S_1 is the solute on side 1 and S_2 on side 2, then the transporter promotes establishment of an equilibrium as follows:



where the brackets represent the concentration of solute. If the transporter (T) is included in the equilibrium the reaction is

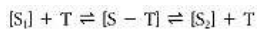

TABLE 5.5 Characteristics of Membrane Transporters

<i>Passive Mediated</i>	<i>Active Mediated</i>
1. Saturation kinetics	1. Saturation kinetics
2. Specificity for solute transported	2. Specificity for solute transported
3. Can be inhibited	3. Can be inhibited
4. Solute moves down concentration gradient	4. Solute can move against concentration gradient
5. No expenditure of energy	5. Requires coupled input of energy

If no energy is put into the system, the concentration on both sides of the membrane will be equal at equilibrium; but if there is an expenditure of energy, a concentration gradient can be established. Note the similarity of the role of a transporter to that of an enzyme; in both cases the protein increases the rate but does not determine the final equilibrium.

Table 5.5 lists major characteristics of membrane transport systems. As presented in Figure 5.29, they demonstrate **saturation kinetics**; as the concentration of the substance to be translocated increases, the initial rate of transport increases but reaches a maximum when the substance saturates the protein transporter. Simple diffusion does not have saturation kinetics. Constants such as V_{\max} and K_m can be calculated for transporters. As with enzymes, transporters can catalyze movement of a solute in both directions across the membrane depending on the ΔG for the reaction.

Most transporters have a high degree of structural and stereo specificity for the substance transported. An example is mediated transport of D-glucose in erythrocytes, where the K_m for D-galactose is 10 times larger and for L-glucose 1000 times larger than for D-glucose. The transporter has essentially no activity with D-fructose or disaccharides. Competitive and noncompetitive inhibitors have been found for many transporters. Structural analogs of the substrate inhibit competitively and reagents that react with specific groups on proteins are noncompetitive inhibitors.

There Are Four Common Steps in the Transport of Solute Molecules

We need to expand the equation above and consider four aspects of mediated transport (Figure 5.30). These are (1) *recognition by transporter of appropriate solute from a variety of solutes in the aqueous environment*, (2) *translocation of solute across membrane*, (3) *release of solute by transporter*, and (4) *recovery of transporter to its original condition to accept another solute molecule*.

The first step, **recognition** of a specific substrate by the transporter, is explained on the same basis as that described for recognition of a substrate by an enzyme. The presence of very specific binding sites on the protein permits the transporter to recognize the correct structure of the solute to be translocated.

The second step, **translocation**, is not completely understood. A reasonable mechanism (Figure 5.31) is one in which the protein transporter creates a channel between the environments on each side of the membrane with access through the channel being controlled by a gating mechanism in order to control which solutes can move into the channel. Transporters have receptor sites to which the solute attaches. After binding of solute and transporter, a conformational change of the protein moves the solute molecule a short distance, perhaps only 2 or 3 Å, but into the environment of the opposite side of the membrane. In this manner, it is not necessary for the transporter to move the molecule the entire distance across the membrane. Earlier suggestions for the translocation step included the possibility of a diffusible or rotating carrier, but both are improbable considering that transporters are large integral membrane proteins that do not diffuse transversely.



Figure 5.30
Reactions involved in mediated transport across a biological membrane.
 S_1 and S_2 are the solutes on sides 1 and 2 of the membrane, respectively; T_1 and T_2 are the binding sites on the transporter on sides 1 and 2, respectively.

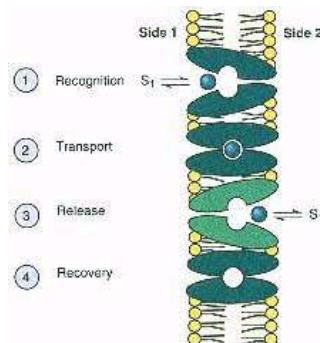

Figure 5.31
Model for a mediated transport system in a biological membrane.
 Model is based on the concept of specific sites for binding of substrate and a conformational change in the transporter to move the bound solute a short distance but into the environment of the other side of the membrane. Once moved, the solute is released from the transporter.

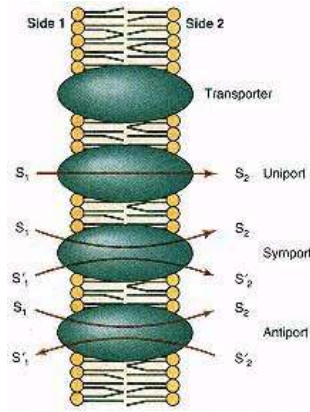

Figure 5.32
Uniport, symport, and antiport mechanisms
for translocation of substances.
 S and S₁ represent different molecules.

Release, step 3, of the solute can occur readily if the concentration of solute is lower in the new compartment than on the initial side of binding. Without a change in the affinity (K_{eq}), there would be a shift in the equilibrium and release of a portion of the solute. For those transporters that move a solute against a concentration gradient, release of the solute at the higher concentration requires a decrease in the affinity for the solute by the transporter. A change in the conformation of the transporter decreases the affinity. In group translocation (p. 210) the solute is chemically altered while attached to the transporter and the modified molecule has a lower affinity for the transporter.

Finally, in **recovery**, step 4, the transporter must return to its original state. If a conformational change has occurred, the transporter reverts to the original conformation.

The discussion above has centered on the movement of a single solute molecule by the transporter. There are systems that move two molecules simultaneously in one direction (**symport mechanisms**), two molecules in opposite directions (**antiport mechanism**), as well as a single molecule in one direction (**uniport mechanism**) (Figure 5.32). When a charged substance, such as K^+ , is translocated and no ion of the opposite charge is moved, a charge separation occurs across the membrane. This mechanism is termed electrogenic and leads to development of a membrane potential. If an oppositely charged ion is moved to balance the charge, the mechanism is called neutral or electrically silent.

Energetics of Membrane Transport Systems

The change in **free energy** when an uncharged molecule moves from a concentration of C_1 to a concentration of C_2 on the other side of a membrane is given by Eq. 5.1:

$$\Delta G' = 2.3RT \log \left(\frac{C_2}{C_1} \right) \quad (5.1)$$

When ΔG is negative—that is, there is release of free energy—movement of solute will occur without the need for a driving force. When ΔG is positive, as would be the case if C_2 is larger than C_1 , then there needs to be an input of energy to drive the transport. For a charged molecule (e.g., Na^+) both the electrical potential and concentrations of solute are involved in calculating the change in free energy as indicated in Eq. 5.2:

$$\Delta G' = 2.3RT \log \left(\frac{C_2}{C_1} \right) + Z\mathcal{F}\Psi \quad (5.2)$$

where Z is the charge of the species moving, \mathcal{F} is the Faraday constant ($23.062 \text{ kcal V}^{-1} \text{ mol}^{-1}$), and Ψ is the difference in electrical potential in volts across the membrane. The electrical component is the membrane potential and ΔG is the electrochemical potential.

A **passive transport** system is one in which ΔG is negative and the movement of solute occurs spontaneously. When ΔG is positive, coupled input of energy from some source is required for movement of the solute and the process is called active transport. **Active transport** is driven by either hydrolysis of ATP to ADP or utilization of an electrochemical gradient of Na^+ or H^+ across the membrane. In the first the chemical energy released on hydrolysis of a pyrophosphate bond drives the reaction, whereas in the latter an electrochemical gradient is dissipated to transport the solute.

Transport systems that can maintain very large concentration gradients are present in various membranes. An example is the plasma membrane transport system that maintains the Na^+ and K^+ gradients. One of the most striking examples of an active transport system is that present in the parietal cells of gastric glands, which are responsible for secretion of HCl into the lumen of the stomach (see p. 1069). The pH of plasma is about 7.4 ($4 \times 10^{-8} \text{ M H}^+$), and

the luminal pH of the stomach can reach 0.8 (0.15 M H^+). The cells transport H^+ against a concentration gradient of $1 \times 10^{6.6}$. Assuming there is no electrical component, the energy for H^+ secretion under these conditions can be calculated from Eq. 5.1 and is $9.1 \text{ kcal mol}^{-1}$ of HCl .

5.6—

Channels and Pores

Channels and Pores in Membranes Function Differently

Membrane channels are differentiated from membrane pores on the basis of their degree of specificity for molecules crossing the membrane. **Channels** are selective for specific inorganic cations and anions, whereas pores are not selective, permitting inorganic and organic molecules to pass through the membrane. The Na^+ channel of plasma membranes of eukaryotic cells, for example, permits movement of Na^+ at a rate more than ten times greater than that for K^+ . This difference between channels and pores is due to differences in size of the aqueous area created in the protein structure as well as amino acid residues lining the channel area. Channels and pores are intrinsic membrane proteins and amino acid sequences in the proteins of many channels suggest existence of structurally related superfamilies of proteins in which similar amino acid sequences occur. A common motif is a structure formed by amphipathic α -helices of associated protein subunits or from domains within a single polypeptide chain creating a central aqueous space as pictured in Figure 5.33. Exceptions to the α -helical structure are the porins (see below) of Gram-negative bacteria, which have α, β -sheet structure lining the central pore. The opening and closing of membrane channels involve a conformational change in the channel protein.

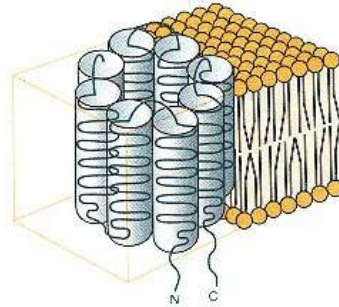

Figure 5.33
Arrangement of protein subunits
or domains to form a membrane channel.

Opening and Closing of Channels Are Controlled

As indicated in Table 5.4, the opening and closing of some channels can be controlled by changes in the **transmembrane potential**. These are referred to as **voltage-gated channels**. In the case of the Na^+ channel, depolarization of the membrane leads to an opening of the channel. Voltage-gated channels for Na^+ , K^+ , and Ca^{2+} are present in the plasma membrane of most cells. Clinical Correlation 22.8 (p. 956) describes changes in voltage-gated channels in myotonic muscle disorders. Mitochondria have a voltage-dependent channel for anions. Binding of a specific agent, termed an **agonist**, can also control the opening of a channel. A channel opens in the **nicotinic-acetylcholine receptor** on binding of acetylcholine allowing the flow of Na^+ into the cell. This mechanism is important to neuronal electrical signal transmission (see p. 928). In addition, some channels are controlled by cAMP (see p. 862); Clin. Corr. 5.3 describes the modification of the Cl^- channel in cystic fibrosis. These forms of control for opening channels are very fast, permitting bursts of ion flow through the membrane at rates of over 10^7 ions s^{-1} , which is near the diffusion rate of these ions in water. This rate is necessary because these channels are involved in nerve conduction and muscle contraction. A number of pharmacological agents that modulate these channels are used therapeutically.

Sodium Channel

Voltage-sensitive **sodium channels** mediate rapid increase in intracellular Na^+ following depolarization of the plasma membrane in nerve and muscle cells. The channel consists of a single large glycopolypeptide and several smaller glycoproteins. The genes for some of the Na^+ channels have been cloned and the amino acid sequences have been determined. There are four repeat homology units, each with six transmembrane α -helices. A model for this trans-

CLINICAL CORRELATION 5.3

Cystic Fibrosis and the Cl⁻ Channel

Cystic fibrosis (CF), an autosomal recessive disease, is the commonest, fatal, inherited disease of caucasians, occurring with a frequency of 1 in 2000 live births. It is a multi-organ disease, with a principal manifestation being pulmonary obstruction; thick mucous secretions obstruct the small airways allowing recurrent bacterial infections. Exocrine pancreatic dysfunction occurs early and leads to steatorrhea (fatty stool) in CF patients; see page 1059 for a discussion of the role of the pancreas in fat digestion and absorption. CF patients have reduced Cl⁻ permeability, which impairs fluid and electrolyte secretion, leading to luminal dehydration. Diagnosis of CF is confirmed by a significant increase of Cl⁻ in sweat of affected in comparison to normal individuals.

The gene responsible for CF was identified in 1989 and over 400 mutations leading to CF have been found. The most common mutation (about 70%) leads to a deletion of a single phenylalanine at position 508 on the protein, but missense, nonsense, frameshift, and splice-junction mutations (see p. 628) have also been reported. The CF gene product is the cystic fibrosis transmembrane conductance regulator (CFTR), which is a cAMP-dependent Cl⁻ channel. CFTR is composed of 1480 amino acids with structural homology to a family of transport proteins termed the transport ATPases. The gene has been cloned (see p. 765) and a major effort is under way to treat the disease by gene therapy, using both viral and nonviral vectors including liposomes (see Clin. Corr. 5.1).

Alton, E. W., and Geddes, D. M. Gene therapy for cystic fibrosis; a clinical perspective. *Gene Ther.* 2:88, 1995; Frizzell, R. A. Functions of the cystic fibrosis transmembrane conductance regulator protein. *Am. J. Respir. Crit. Care Med.* 151:54, 1995; and Wagner, J. A., Chao, A. C., and Gardner, P. Molecular strategies for therapy of cystic fibrosis. *Annu. Rev. Pharmacol. Toxicol.* 35:257, 1995.

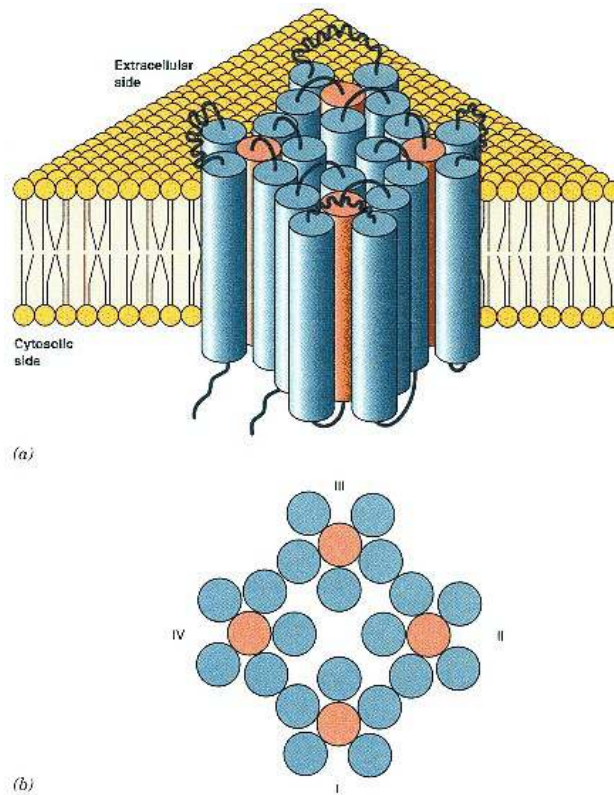

Figure 5.34

Possible model of the Na⁺ channel.

- (a) The single peptide consists of four repeating units with each unit folding into six transmembrane helices.
 (b) Proposed arrangement of the transmembrane sequences as viewed down on the membrane.
 Redrawn from M. Noda et al., *Nature* 320:188, 1986.

porter is presented in Figure 5.34a and a possible arrangement of the helices in the membrane as viewed down on a membrane is presented in Figure 5.34b. One transmembrane segment, labeled S4, has a positively charged amino acid at every third position and may serve as a voltage sensor. A mechanical shift of this region due to a change in the membrane potential may lead to a conformational change in the protein, resulting in the opening of the channel. The channel size created by the protein, however, cannot totally explain the specificity for Na⁺.

Nicotinic–Acetylcholine Channel (nAChR)

The **nicotinic–acetylcholine channel**, also referred to as the **acetylcholine receptor**, is an example of a chemically regulated channel, where the binding of acetylcholine (Figure 5.35) opens the channel. The dual name is used to differentiate this receptor from other acetylcholine receptors, which function in a different manner. **Acetylcholine**, a neurotransmitter, is released at the

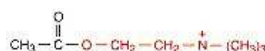

Figure 5.35

Structure of acetylcholine.

neuromuscular junction by a neuron when electrically excited. The acetylcholine diffuses to the skeletal muscle membrane where it interacts with the acetylcholine receptor, opening the channel and allowing selective cations to move across the membrane (see p. 928). The change in transmembrane potential leads to a series of events culminating in muscle contraction. The nicotinic–acetylcholine receptor consists of five polypeptide subunits, with two α subunits and one each of β , γ , and δ ; each α subunit is phosphorylated and glycosylated and two others contain covalently bound lipid. The channel opens when two acetylcholine molecules bind to subunits and cause a change in protein conformation; reclosure of the channel occurs within a millisecond due to hydrolysis of acetylcholine to acetate and choline and release of bound ligand. A desensitized state of the receptor has been reported that does not open when acetylcholine binds. In the open conformation, cations and small nonelectrolytes can flow through the channel but not anions; negatively charged amino acid residues in the channel are sufficient to repel negatively charged ions from passing.

The nicotinic–acetylcholine receptor is inhibited by a number of deadly neurotoxins including *d*-**tubocurarine**, the active ingredient of curare, and several toxins from snakes including **α -bungarotoxin**, **crabutoxin**, and **co-bratoin**, the latter from the cobra. **Succinylcholine**, a muscle relaxant, activates the channel leading to depolarization of the membrane; succinyl choline is used in surgical procedures because its activity is reversible due to the rapid hydrolysis of the compound after cessation of administration.

Examples of Pores Are Gap Junctions and Nuclear Pores

Plasma membrane gap junctions and **nuclear membrane pores** are relatively large aqueous openings in the membrane created by specific proteins. **Gap junctions** are clusters of membrane channels lined by proteins spanning two plasma membranes that create aqueous connections between two cells. They permit the exchange between cells of ions and metabolites but not large molecular weight compounds such as proteins. The diameter of the opening ranges from 12 to 20 Å. Oligomers of the gap junction polypeptide (32 kDa), referred to as **connexin**, form the channel. Twelve subunits, six from each cell, form a hexameric structure in each membrane as shown in Figure 5.36. The channels are normally open but increases in cytosolic Ca^{2+} , a change in metabolism, a drop in transmembrane potential, or acidification of the cytosol cause closure. When the channel is open subunits appear to be slightly tilted.

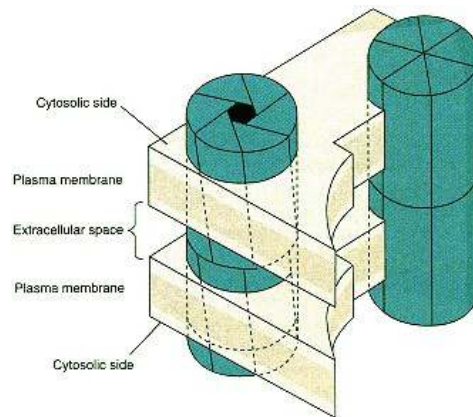

Figure 5.36
Model for a channel in the gap junction.

but when closed they appear to be more nearly parallel to a perpendicular to the membrane, suggesting that subunits slide over each other. The detailed mechanism of opening and closing, however, is unknown.

Like gap junctions **nuclear pores** cover two membranes, creating aqueous channels in the nuclear envelope. Pores are about 90 Å in diameter and permit the movement of large macromolecules. They are presumably lined with protein. The plasma membranes of Gram-negative bacteria also contain protein pores, termed **porins**. Over 40 different porins have been isolated and they range in size from 28 to 48 kDa. In contrast to most mammalian channels, these transmembrane segments are β -sheets not α -helices and exist in the membrane as trimers. Porins are water-filled transmembrane channels and range in diameter from 6 to 23 Å with some degree of selectivity for inorganic ions; some, however, permit the uptake of sugars.

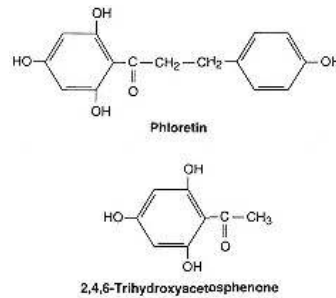

Figure 5.37
Inhibitors of passive mediated transport of D-glucose in erythrocytes.

5.7— Passive Mediated Transport Systems

Passive mediated transport, also referred to as **facilitated diffusion**, leads to translocation of solutes through cell membranes without expenditure of metabolic energy (see Table 5.5, p. 199). As with nonmediated diffusion the direction of flow is always from a higher to a lower concentration. The distinguishing differences between measurements of simple diffusion and passive mediated transport are the demonstration of saturation kinetics, a structural specificity for the class of molecule moving across the membrane, and specific inhibition of solute movement.

Glucose Transport Is Facilitated

A family of passive mediated transporters for D-glucose, frequently referred to as **glucose permeases**, has been identified in the plasma membrane of mammalian cells. Six members have been described and are termed GLUT-1, GLUT-2, and so on. All have 12 hydrophobic segments considered to be the transmembrane regions. The physiological direction of movement is into the cell because the extracellular level of glucose is about 5 mM and most cells metabolize glucose rapidly, thus maintaining low intracellular concentrations. The transporter catalyzes a uniport mechanism and is most active with D-glucose. D-Galactose, D-mannose, D-arabinose, and several other D-sugars as well as glycerol are translocated by the same transporter. L-Isomers are not transported. It has been proposed that the β -D-glucopyranose is transported with carrier interaction at the hydrogen atoms on at least C-1, C-3, and C-6 of the sugar. The affinity of erythrocyte translocase for D-glucose is highest with a K_m of ~6.2 mM, whereas for other sugars K_m values are much higher. The transporter has a very low affinity for D-fructose, precluding a role in cellular uptake of fructose; a separate carrier for fructose has been proposed. With isolated erythrocytes, glucose will move either into or out of the erythrocyte, depending on the direction of the experimentally established concentration gradient, demonstrating the reversibility of the system. Several sugar analogs as well as phloretin and 2,4,6-trihydroxyacetophenone (Figure 5.37) are competitive inhibitors. Some physiological aspects of the glucose translocase are presented on p. 881.

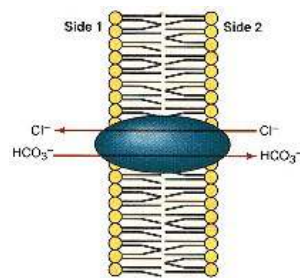

Figure 5.38
Passive anion antiport mechanism for movement of Cl^- and HCO_3^- across the erythrocyte plasma membrane.

Cl^- and HCO_3^- Are Transported by an Antiport Mechanism

An anion transporter in erythrocytes involves the antiport movement of Cl^- and HCO_3^- (Figure 5.38). The transporter is referred to as the **Cl^- – HCO_3^- exchanger, anion exchange protein, or band 3**, the latter because of its position in SDS polyacrylamide gel electrophoresis of erythrocyte membrane proteins. The direction of ion flow is reversible and depends on the concentra-

tion gradients of the ions across the membrane. The transporter has an important role in adjusting the erythrocyte HCO_3^- concentration in arterial and venous blood (see p. 1035).

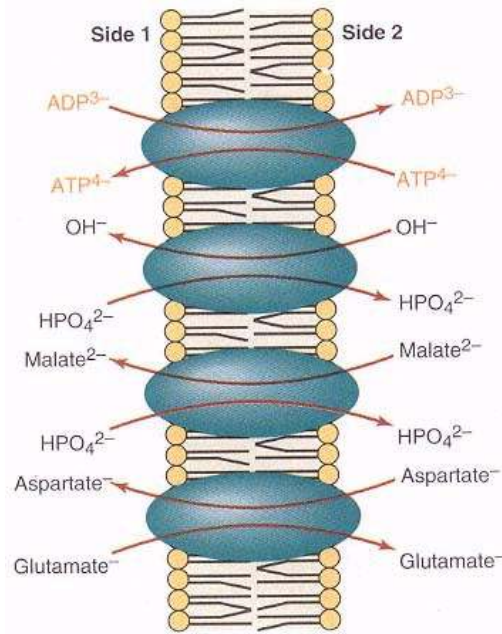

Figure 5.39
Representative anion transport systems in liver mitochondria.
Note that each is an antiport mechanism.
Several other transport systems are known and are discussed in Chapter 6.

Mitochondria Contain a Number of Transport Systems

The inner mitochondrial membrane contains several antiport systems for the exchange of anions between the cytosol and mitochondrial matrix. These include (1) a transporter for exchange of ADP and ATP, (2) a transporter for exchange of phosphate and OH^- , (3) a dicarboxylate carrier that catalyzes an exchange of malate for phosphate, and (4) a translocator for exchange of aspartate and glutamate (Figure 5.39). The relationship of these translocases and energy coupling are discussed on page 243. In the absence of an input of energy these transporters will catalyze a passive exchange of metabolites down their concentration gradient to achieve a thermodynamic equilibrium of all intermediates. As an antiport mechanism, a concentration gradient of one compound can drive the movement of the other solute. In several cases, the transporter catalyzes the antiport movement of an equal number of charges on the substrate; in such movement the mitochondrial membrane potential influences the equilibrium and the anions can be moved against their concentration gradients. ADP–ATP and the phosphate transporters, as well as an uncoupling protein that translocates H^+ , have significant amino acid homology and are presumably derived from a common ancestor. It has been suggested that each subunit has six transmembrane α -helices. The **uncoupling protein**, found in mitochondria of brown adipose tissue, has been proposed to be involved in generation of heat.

The **ATP–ADP translocase** is very specific for ATP and ADP and deoxyribose derivatives, dATP and dADP, but does not transport AMP or other nucleotides. It is a dimer containing two subunits of 33 kDa each and represents about 12% of the total protein in heart mitochondria. It is very hydrophobic and can exist in two conformations. Atractyloside and bongkrelic acid (Figure 5.40) are

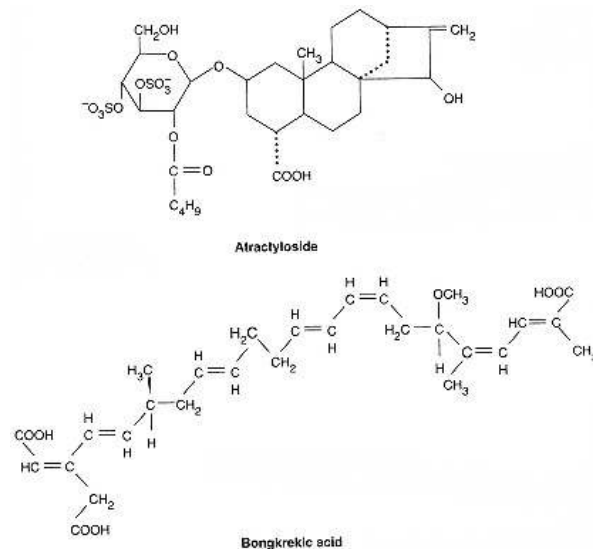

Figure 5.40
Structure of two inhibitors of the ATP–ADP transport system of liver mitochondria.

specific inhibitors, each apparently reacting with a different conformation of the protein. The mitochondrial membrane potential can drive the movement of the nucleotides by this translocator, but in the absence of the membrane potential it functions as a passive mediated transporter.

It is sometimes difficult to differentiate passive mediated transport from simple diffusion, but inhibition of the process is good evidence of a carrier.

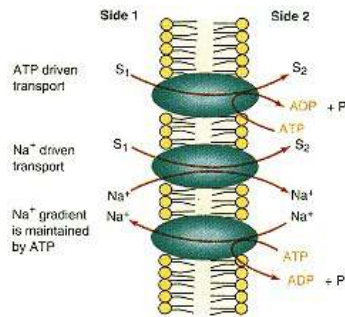

Figure 5.41
Involvement of metabolic energy (ATP) in active mediated transport systems.
The chemical energy released on the hydrolysis of ATP to ADP and inorganic phosphate is used to drive the active transport of various substances, including Na^+ . The transmembrane concentration gradient of Na^+ is also used for the active transport of substances.

5.8—

Active Mediated Transport Systems

Active mediated transporters have the same three characteristics as passive transporters, that is, saturation kinetics, substrate specificity, and inhibitability (see Table 5.5, p. 199). They also require the utilization of energy to translocate solutes and if the energy source is removed or inhibited, the transport system will not function. These active transporters can be classified as either **primary active transporters**, if they utilize ATP directly, or **secondary active transporters** if a transmembrane chemical gradient of Na^+ or H^+ is utilized (Figure 5.41). The transporters that utilize ATP are also referred to as an **ATPase** because during the translocation ATP is hydrolyzed to ADP and phosphate. They are classified as either **P, V, or F type transporters or ATPases**. P type translocases are phosphorylated and dephosphorylated during the transport activity; the Na^+ , K^+ -translocase is an example of a P type. V, for vacuole, type are present in membranes of lysosomes, endosomes, Golgi vesicles, and secretory vesicles and are responsible for acidification of the interior of these vesicles. F type translocases, present in mitochondria and chloroplasts, are involved in ATP synthesis (see p. 263). A special case of active transport is the translocation of protons across the inner mitochondrial membrane during electron transport; this mechanism is discussed in detail on page 262 and will not be reviewed here. Active mediated transporters, which use the transmembrane Na^+ or H^+ gradient, require maintenance of the gradient; for Na^+ this is achieved by expenditure of ATP (Figure 5.41). Inhibition of ATP synthesis leads to a dissipation of the Na^+ gradient, which in turn causes a cessation of transport activity.

Translocation of Na^+ and K^+ Is a Primary Active Transport System

All mammalian cells contain a Na^+ , K^+ antiporter, type P, which utilizes ATP to drive the movement of the ions. Knowledge of this transporter has developed along two paths: (1) from studies of a membrane enzyme, the **Na^+ , K^+ -ATPase**, that catalyzes ATP hydrolysis and has a requirement for Na^+ and K^+ ions, and (2) from measurements of Na^+ and K^+ movements across intact plasma membranes by a protein referred to as the **Na^+ , K^+ pump**. The two activities are catalyzed by the same protein.

All Plasma Membranes Contain a Na^+ , K^+ -Activated ATPase

All mammalian plasma membranes catalyze the reaction

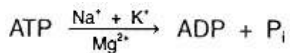

The enzyme, officially termed the **Na^+ , K^+ -exchanging ATPase**, has a requirement for both Na^+ and K^+ ions, as well as Mg^{2+} , which is a cofactor for ATP-requiring reactions. The level of the ATPase in plasma membranes correlates with the Na^+ , K^+ transport activity. Excitable tissues, such as muscle and nerve, and cells actively involved in the movement of Na^+ ion, such as those in the salivary gland and kidney cortex, have high activities of both Na^+ , K^+ -ATPase and Na^+ , K^+ transport system. The protein responsible for the Na^+ , K^+ -ATPase activity is an oligomer containing two α subunits of about 110 kDa each and

two β subunits of about 55 kDa each. The smallest subunits are glycoproteins, and the complex has the characteristics of an integral membrane protein. Figure 5.42 is a schematic diagram of the Na^+, K^+ -exchanging ATPase. The ATPase activity has a requirement for phospholipids indicating its close relationship to the membrane. During transport the larger subunit is *cyclically phosphorylated* and *dephosphorylated* on a specific aspartic acid residue forming a β -aspartyl phosphate. Phosphorylation of the protein requires Na^+ and Mg^{2+} but not K^+ , whereas dephosphorylation of the protein requires K^+ but not Na^+ or Mg^{2+} . The isolated enzyme has an absolute requirement for Na^+ , but K^+ can be replaced with NH_4^+ or Rb^+ . Two distinguishable conformations of the protein complex have been observed and thus it is classified as an $\text{E}_1\text{-E}_2$ type transporter. A possible sequence of reactions for the enzyme is presented in Figure 5.43.

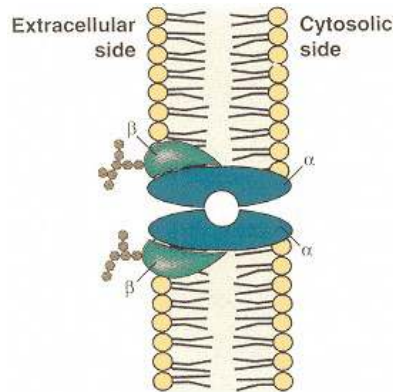

Figure 5.42
Schematic drawing of the Na^+, K^+ -transporting ATPase of plasma membranes.

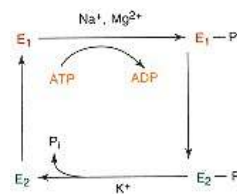

Figure 5.43
Proposed sequence of reactions and intermediates in hydrolysis of ATP by the Na^+, K^+ -ATPase.

E_1 and E_2 are different conformations of the enzyme. Phosphorylation of the enzyme requires Na^+ and Mg^{2+} and dephosphorylation involves K^+ .

Of significance to its physiological role as a transporter, the enzyme is inhibited by a series of **cardiotonic steroids**. These pharmacological agents, which include **digitalis**, increase the force of contraction of heart muscle by altering the excitability of the tissue, which is a function of the Na^+/K^+ concentrations across the membrane. **Ouabain** (Figure 5.44) is one of the most active Na^+, K^+ -ATPase inhibitors of the series; its site of binding is on the smaller subunit of the enzyme complex and at some distance from the ATP-binding site on the larger monomer. An inhibitor in human serum of the transporter competes with ouabain binding and may be involved in the control of Na^+, K^+ transport.

Erythrocyte Ghosts Are Used to Study Na^+, K^+ Translocation

Studies of the Na^+, K^+ transporter activity have been facilitated by use of erythrocyte preparations free of hemoglobin, referred to as **erythrocyte ghosts**. By carefully adjusting the tonicity of the medium, erythrocytes will swell with breaks in the phospholipid bilayer, permitting leaking from cells of cytosolic material, including hemoglobin. The cytosol can be replaced with a defined medium by readjusting the tonicity so that the membrane reseals, trapping isolation medium inside. In this manner intracellular ionic and substrate composition and even protein content can be altered. With erythrocyte ghosts intra- and extracellular Na^+ and K^+ can be manipulated as well as ATP or inhibitor content. Movement of Na^+ and K^+ is an antiport vectorial process, with Na^+ moving out and K^+ moving into the cell. This transporter is responsible for maintaining the high K^+ and low Na^+ concentrations in a mammalian cell (see p. 14). ATP-binding site on the protein is on the inner surface of the membrane in that hydrolysis occurs only if ATP, Na^+ , and Mg^{2+} are inside the cell. K^+ ion is required externally for internal dephosphorylation of protein. Ouabain inhibits translocation of Na^+ and K^+ but only if present externally. There are between 100 and 200 transporter molecules per erythrocyte, but the number is significantly larger for other tissues.

ATP hydrolysis by the translocase occurs only if Na^+ and K^+ are translocated, demonstrating that the enzyme is not involved in dissipation of energy in a useless activity. For each ATP hydrolyzed, three ions of Na^+ are moved out of the cell but only two ions of K^+ in, which leads to an increase in external positive charges. This electrogenic movement of Na^+ and K^+ is part of the mechanism for the maintenance of the transmembrane potential in tissues. Even though the energetics of the system dictate that it functions in only one direction, the translocator can be reversed *in vitro* by adjusting the Na^+ and K^+ levels; a small net synthesis of ATP has been observed when transport is forced to run in the reverse direction.

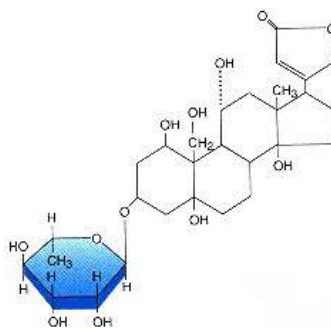

Figure 5.44
Structure of ouabain, a cardiotonic steroid, which is a potent inhibitor of the Na^+, K^+ -ATPase and of active Na^+ and K^+ transport.

A hypothetical model for movement of Na^+ and K^+ is presented in Figure 5.45. The protein goes through conformational changes during which the Na^+ and K^+ are moved short distances. During the transition a change in the affinity

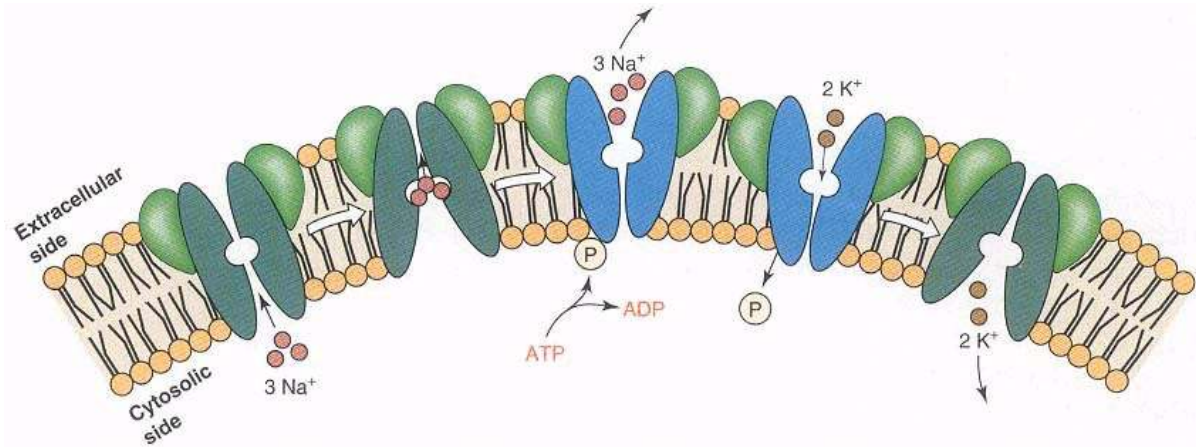

Figure 5.45
Hypothetical model for the translocation of Na^+ and K^+ across the plasma membrane by the Na^+, K^+ -ATPase.

- (1) Transporter in conformation 1 picks up Na^+ .
- (2) Transporter in conformation 2 translocates and releases Na^+ .
- (3) Transporter in conformation 2 picks up K^+ .
- (4) Transporter in conformation 1 translocates and releases K^+ .

of the binding protein for the cations can occur such that there is a decrease in affinity constants, resulting in the release of the cation into a milieu where the concentration is higher than that from which it was transported.

As an indication of the importance of this enzyme, it has been estimated that Na^+, K^+ -ATPase uses about 60–70% of the ATP synthesized by cells in nerve and muscle, and may utilize about 35% of ATP generated in a resting individual.

Ca²⁺ Translocation Is Another Example of a Primary Active Transport System

Ca^{2+} is an important **intracellular messenger** regulating cellular processes as varied as muscle contraction and carbohydrate metabolism. The signal initiated by some hormones, the primary messenger to direct cells to alter their function, is transmitted by changes in cytosolic Ca^{2+} ; for this reason Ca^{2+} is referred to as a **second messenger**. Cytosolic Ca^{2+} is in the range of $0.10 \mu\text{M}$, over 10,000 times lower than extracellular Ca^{2+} . Intracellular Ca^{2+} concentrations can be increased rapidly by (1) transient opening of Ca^{2+} channels in the plasma membrane, permitting flow of Ca^{2+} down the large concentration gradient, or (2) by release from stores of Ca^{2+} in endoplasmic or sarcoplasmic reticulum. In order to reestablish low cytosolic levels, Ca^{2+} is actively transported out of cells across the plasma membrane or into the endoplasmic or sarcoplasmic reticulum. With both membrane systems, a **Ca^{2+} transporter** of the $\text{E}_1\text{-E}_2$ type is involved in which ATP is hydrolyzed during translocation. The transporter catalyzes a Ca^{2+} -stimulated ATPase activity.

Ca^{2+} -ATPase of sarcoplasmic reticulum of muscle, which is involved in the contraction–relaxation cycles of muscle, represents 80% of the integral membrane protein of the sarcoplasmic reticulum and occupies one-third of the surface area (see p. 954); it has many properties similar to Na^+, K^+ -ATPase. The protein has ten membrane-spanning helices and is phosphorylated on an aspartyl residue during the Ca^{2+} translocation reaction. Two Ca^{2+} ions are translocated for each ATP hydrolyzed and it can move Ca^{2+} against a very large concentration gradient.

The Ca^{2+} transporter of plasma membranes has properties similar to the enzyme of sarcoplasmic reticulum. In eukaryotic cells, the transporter is regulated by cytosolic Ca^{2+} levels through a calcium-binding protein termed **calmodulin**. As cellular Ca^{2+} levels rise, Ca^{2+} is bound to calmodulin, which has a dissociation constant of $\sim 1 \mu\text{M}$. The Ca^{2+} -calmodulin complex binds to the

Ca^{2+} transporter, leading to an increased rate in Ca^{2+} transport. The rate is increased by lowering the K_m for Ca^{2+} of the transporter from about 20 to 0.5 μM . Increased activity reduces cytosolic Ca^{2+} to its normal resting level ($\sim 0.10 \mu\text{M}$) at which concentration the Ca^{2+} -calmodulin complex dissociates and the rate of the Ca^{2+} transporter returns to a lower value. Thus the Ca^{2+} -calmodulin complex exerts fine control on the Ca^{2+} transporter. Calmodulin is one of several Ca^{2+} -binding proteins, including **parvalbumin** and **troponin C**, all of which have very similar structures. The Ca^{2+} -calmodulin complex is also involved in control of other cellular processes, which are affected by Ca^{2+} . The protein (17 kDa) has the shape of a dumbbell with two globular ends connected by a seven-turn α -helix; there are four Ca^{2+} -binding sites, two high affinity on one lobe and two low affinity on the other. It is believed that the binding of Ca^{2+} to the lower affinity binding sites causes a conformational change in the protein, revealing a hydrophobic area that can interact with a protein that it controls. Each Ca^{2+} -binding site consists of a helix-loop-helix structural motif (Figure 5.46) and Ca^{2+} is bound in the loop connecting the helices. A similar structure is found in other Ca^{2+} -binding proteins. The motif is referred to as the **EF hand**, based on studies with parvalbumin where the Ca^{2+} is bound between helices E and F of the protein.

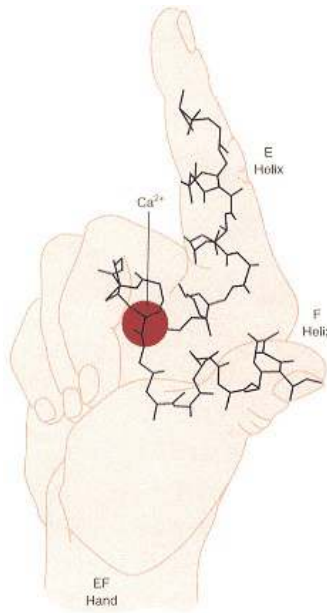

Figure 5.46
Binding site for Ca^{2+} in calmodulin.

Calmodulin contains four Ca^{2+} -binding sites, each with a helix-loop-helix motif. The Ca^{2+} ion is bound in the loop that connects two helices. This motif occurs in various Ca^{2+} -binding proteins and is referred to as the EF hand.

Na^+ -Dependent Transport of Glucose and Amino Acids Are Secondary Active Transport Systems

The mechanisms described above for the active transport of cations involve the direct hydrolysis of ATP as the driving force. *Cells have another energy source, the gradient of Na^+ ion across the plasma membrane, which is utilized to move sugars, amino acids, and Ca^{2+} actively.* A symport translocation system involving simultaneous movement of both a Na^+ ion and glucose in the same direction is present in plasma membranes of cells of kidney tubule and intestinal epithelium. The general mechanism is presented in Figure 5.47. The diagram represents the **transport of D-glucose** driven by the movement of Na^+ ion down its concentration gradient. During transport of the sugar no hydrolysis of ATP occurs. There is an absolute requirement for Na^+ , and in the process of translocation one Na^+ is moved with each glucose molecule. It can be considered that Na^+ is moving by passive facilitated transport down its chemical gradient and glucose carried along even against its concentration gradient. It is obligatory that the transporter translocates a glucose with the Na^+ ion. In the transport the chemical gradient of Na^+ ion is dissipated and unless the Na^+ ion gradient is continuously regenerated, transport of glucose will cease. The Na^+ gradient is maintained by the Na^+ , K^+ -exchanging ATPase described above and also represented in Figure 5.47. Thus metabolic energy in the form of ATP is indirectly involved in glucose transport because it is utilized to maintain the Na^+ ion gradient. Inhibition of ATP synthesis and a subsequent decrease in ATP will alter the Na^+ ion gradient and inhibit glucose uptake. Ouabain, the inhibitor of the Na^+ , K^+ transporter, inhibits uptake of glucose by preventing the cell from maintaining the Na^+ - K^+ gradient. Each glucose molecule requires only one-third of an ATP to be translocated because three Na^+ ions are translocated for the hydrolysis of each ATP in the Na^+ , K^+ -exchanging ATPase.

Amino acids are also translocated by the luminal epithelial cells of the intestines by Na^+ -dependent pathways similar to the Na^+ -dependent glucose transporter. At least seven different translocators have been identified for different classes of amino acids (see p. 1072 for details). The Na^+ gradient is also utilized to drive the transport of other ions, including a symport mechanism in the small intestines for the uptake of Cl^- with Na^+ and an antiport mechanism for the excretion of Ca^{2+} out of the cell.

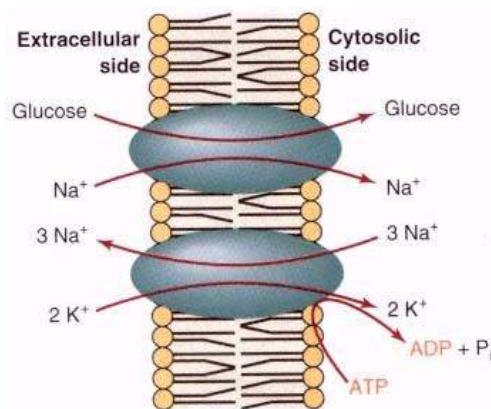

Figure 5.47
 Na^+ -dependent symport transport of glucose across the plasma membrane.

The chemical mechanism for the symport movement of molecules utilizing the Na^+ ion gradient involves a cooperative interaction of the Na^+ ion and the other molecule translocated on the protein. A conformational change of

the protein occurs following association of the two ligands, which moves them the necessary distance to bring them into contact with the cytosolic environment. Dissociation of Na^+ ion from the transporter because of the low Na^+ ion concentration inside the cell leads to a return of the protein to its original conformation, a decrease in affinity for the other ligand, and release of ligand into the cytosol.

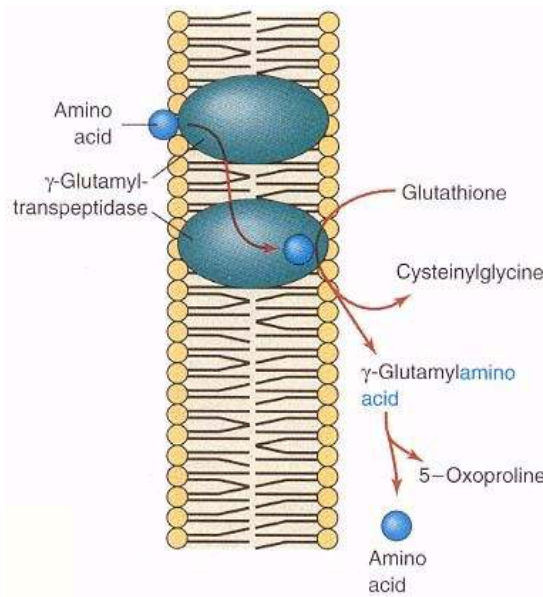

Figure 5.48

The γ -glutamyl cycle.

Represented are the key reactions involved in the group translocation of amino acids across liver cell plasma membranes. The continued uptake of amino acids requires the constant resynthesis of glutathione via a series of ATP-requiring reactions described in Chapter 11, page 485.

Group Translocation Involves Chemical Modification of the Substrate Transported

As discussed previously, a major hurdle for any active transport system is release of the transported molecule from the binding site after translocation. If affinity of the transporter for the translocated molecule does not change, there cannot be movement against a concentration gradient. In the active transport systems described above a change in affinity for the substance by the transporter occurs by a conformational change of the protein. An alternate mechanism for release of a substrate is chemical change of the molecule after translocation but before release from the transporter, leading to a new compound bound to the transporter with a lower affinity for the transporter. The process is termed **group translocation**. The **γ -glutamyl cycle** for the transport of amino acids across the plasma membrane of some tissues is an example where the substrate is altered during transport and released into the cell as a different molecule. Reactions of the transport mechanism are presented in Figure 5.48. The pathway involves the enzyme **γ -glutamyltranspeptidase**, a membrane-bound enzyme. This leads to formation of a dipeptide with the amino acid transported. The amino acid transported is the substrate to which the γ -glutamyl residue of **glutathione** (Figure 5.49; see p. 485) is transferred. The new dipeptide is not part of the chemical gradient across the membrane of the amino acid. The γ -glutamyl derivative is then hydrolyzed by a separate enzyme, not on the membrane, leaving the free amino acid and oxoproline.

All the amino acids except proline can be transported by group translocation. The energy for transport comes from the hydrolysis of a peptide bond in glutathione. For the system to continue, glutathione must be resynthesized, which requires the expenditure of three ATP molecules (see p. 485). Thus for each amino acid translocated, three ATPs are required. Recall that the expenditure of only one-third of an ATP is required for each amino acid transported in the Na^+ -dependent translocase system. Group translocation is an expensive energetic mechanism for transport of amino acids. The pathway is present in many tissues but some doubt has been raised about its physiological significance in that individuals have been identified with a genetic absence of the γ -glutamyl-transpeptidase without any apparent difficulty in amino acid transport. Cells may have several alternate methods for the transport of amino acids and are not dependent on one mechanism.

A group translocation mechanism for uptake of sugars is found in bacteria. This pathway involves phosphorylation of the sugar, using phosphoenol-pyruvate as the phosphate donor. The mechanism is referred to as the **phospho-enolpyruvate-dependent phosphotransferase system (PTS)**.

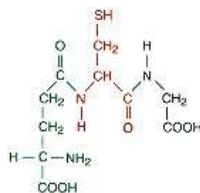

Figure 5.49

Glutathione
(γ -glutamylcysteinylglycine).

Summary of Transport Systems

The foregoing has presented the major mechanisms for movement of molecules across cellular membranes, particularly the plasma membrane. Cell organelles and membrane systems have a variety of transport systems. Mitochondria have transport mechanisms utilizing a proton gradient (see p. 243). Bacteria have transport systems analogous to those observed in mammalian cells. Table 5.6 summarizes characteristics of some major transport systems found in mammalian cells (see Clin. Corr. 5.4).

TABLE 5.6 Major Transport Systems in Mammalian Cells^a

<i>Substance Transported</i>	<i>Mechanism of Transport</i>	<i>Tissues</i>
Sugars		
Glucose	Passive	Widespread
Fructose	Active symport with Na ⁺	Small intestines and renal tubular cells
	Passive	Intestines and liver
Amino acids		
Amino acid-specific transporters	Active symport with Na ⁺	Intestines, kidney, and liver
All amino acids except proline	Active group translocation	Liver
Specific amino acids	Passive	Small intestine
Other organic molecules		
ATP-ADP	Antiport transport of nucleotides; can be active transport	Mitochondria
Ascorbic acid	Active symport with Na ⁺	Widespread
Biotin	Active symport with Na ⁺	Liver
Cholic acid, deoxycholic acid, and taurocholic acid	Active symport with Na ⁺	Intestines
Dicarboxylic acids	Active symport with Na ⁺	Kidney
Folate	Active	Widespread
Lactate and monocarboxylic acids	Active symport with H ⁺	Widespread
Neurotransmitters (e.g., γ -amino butyric acid, norepinephrine, glutamate, dopamine)	Active symport with Na ⁺	Brain
Organic anions (e.g., malate, α -ketoglutarate, glutamate)	Antiport with counterorganic anion	Mitochondria
Peptides (2 to 4 amino acids)	Active symport with H ⁺	Intestines
Urea	Passive	Erythrocytes and kidney
Inorganic ions		
H ⁺	Active	Mitochondria
H ⁺	Active; vacuolar ATPase	Widespread; lysosomes, endosomes, and Golgi complex
Na ⁺	Passive	Distal renal tubular cells
Na ⁺ , H ⁺	Active antiport	Proximal renal tubular cells and small intestines
Na ⁺ , K ⁺	Active: ATP driven	Plasma membrane of all cells
Na ⁺ , HPO ₄ ²⁻	Active cotransport	Kidney
Ca ²⁺	Active: ATP driven	Plasma membrane and endoplasmic (sarcoplasmic) reticulum
Ca ²⁺ , Na ⁺	Active antiport	Widespread
H ⁺ , K ⁺	Active antiport	Parietal cells of gastric mucosa secreting H ⁺
Cl ⁻ /HCO ₃ ⁻	Passive antiport	Erythrocytes and other cells

^a The transport systems are only indicative of the variety of transporters known; others responsible for a variety of substances have been proposed. Most systems have been studied in only a few tissues and their localization may be more extensive than indicated.

5.9— Ionophores

An interesting class of antibiotics of bacterial origin facilitates the movement of monovalent and divalent inorganic ions across biological and synthetic lipid membranes. These molecules, called **ionophores**, are not large macromolecules such as proteins but are relatively small molecular weight compounds (up to several thousand daltons). Ionophores are divided into two major groups:

CLINICAL CORRELATION 5.4

Diseases Due to Loss of Membrane Transport Systems

A number of pathological conditions are due to an alteration in the transport systems for specific cellular components. Some of these are discussed in the appropriate sections describing the metabolism of the intermediates. Individuals have been observed with a decrease in glucose uptake from the intestinal tract due to a loss of the specific sodium-coupled glucose–galactose transporter. Fructose malabsorption syndromes have been observed, which are due to an alteration in the activity of the transport system for fructose. In Hartnup's disease there is a decrease in the transport of neutral amino acids in the epithelial cells of the intestine and renal tubules.

In cystinuria, renal reabsorption of cystine and the basic amino acids lysine and arginine is abnormal, resulting in formation of cystine kidney stones. In hypophosphatemic, vitamin D resistant rickets, renal absorption of phosphate is abnormal. Little is known concerning possible changes of transport activities in tissues such as muscle, liver, and brain but it has been suggested that there may be a number of pathological states due to the loss of specific transport mechanisms.

Evans, L., Grasset, E., Heyman, M., et. al. Congenital selective malabsorption of glucose and galactose. *J. Pediatr. Gastroenterol. Nutr.* 4:878, 1985.

TABLE 5.7 Major Ionophores

Compound	Major Cations Transported	Action
Valinomycin	K^+ or Rb^+	Uniport, electrogenic
Nonactin	NH_4^+ , K^+	Uniport, electrogenic
A23187	$Ca^{2+}/2 H^+$	Antiport, electroneutral
Nigericin	K^+/H^+	Antiport, electroneutral
Monensin	Na^+/H^+	Antiport, electroneutral
Gramicidin	H^+ , Na^+ , K^+ , Rb^+	Forms channels
Alamethicin	K^+ , Rb^+	Forms channels

(1) **mobile carriers** are those ionophores that diffuse back and forth across the membrane carrying the ion from one side of the membrane to the other, and (2) ionophores that form a **channel** that transverse the membrane and through which ions can diffuse. With both types, ions are translocated by a passive mediated transport mechanism. The ionophores that diffuse back and forth across the membrane are more affected by changes in the fluidity of the membrane than those that form a channel. Some major ionophores are listed in Table 5.7.

Each ionophore has a definite ion specificity; **valinomycin**, whose structure is given in Figure 5.50, has an affinity for K^+ that is 1000 times greater than that for Na^+ and the antibiotic A23187 (Figure 5.51) translocates Ca^{2+} 10 times more actively than Mg^{2+} . Several of the diffusion type ionophores have a cyclic structure. The metal ion is coordinated to several oxygen atoms in the core of the ionophore; the periphery of the molecule consists of hydrophobic groups. The interaction of the ionophore leads to a chelation of the ion, stripping away its surrounding water shell and encompassing the ion by a hydrophobic shell. The ionophore-ion complex freely diffuses across the membrane. Since the interaction of ion and ionophore is an equilibrium reaction, a steady state develops in the concentration of ions on both sides of the membrane. The specificity of the ionophore is due in part to the size of the pore into which the ion fits and to the attraction of the ionophore for the ion in competition with water molecules.

Valinomycin transports K^+ by an electrogenic uniport mechanism and can create an electrochemical gradient across a membrane as it carries a positively charged K^+ across the membrane. **Nigericin** is an electrically neutral antiporter; its carboxyl group when dissociated binds a positive ion, such as K^+ , leading to a neutral molecule that crosses a membrane. On diffusion back through the

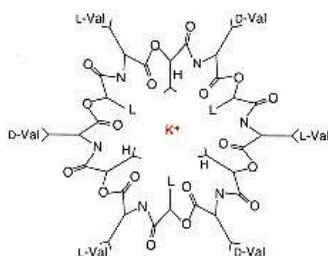

Figure 5.50
Structure of the valinomycin– K^+ complex.
Abbreviations: D-Val, D-valine; L-Val, L-valine; L, L-lactate; and H, D-hydroxyisovalerate.

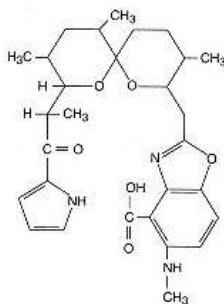

Figure 5.51
Structure of A23187, a Ca^{2+} ionophore.

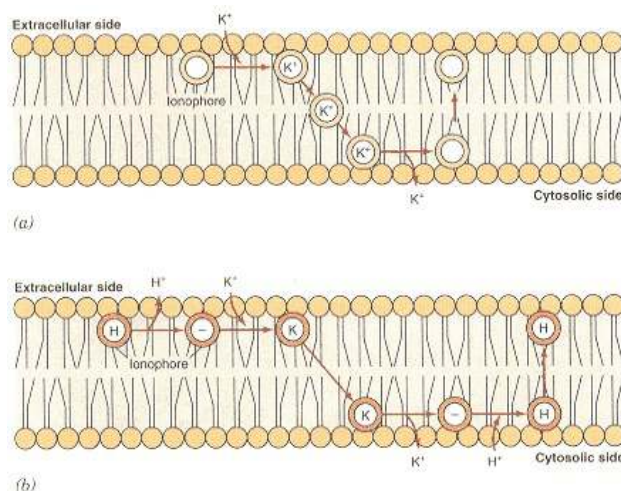

Figure 5.52

Proposed mechanism for the ionophoretic activities of valinomycin and nigericin.

(a) Transport by valinomycin.

(b) Transport by nigericin. The

valinomycin– K^+ complex is positively charged and translocation of K^+ is electrogenic, leading to the creation of a charge separation across the membrane. Nigericin translocates K^+ in exchange for a H^+ across the membrane and the mechanism is electrically neutral.

Diagram adopted from B. C. Pressman, *Annu. Rev. Biochem.* 45:501, 1976.

membrane it transports a proton; overall K^+ exchanges for H^+ . These mechanisms are presented in Figure 5.52.

Gramicidin A is an example of an ionophore that creates a pore in the membrane. This type of ionophore has a low ion selectivity because ions are diffusing through a hole in the membrane. Two molecules of gramicidin A form a channel and the dimer is in constant equilibrium with the free monomer form. By association and dissociation of the monomers in the membrane, channels can be formed and broken; the rate of interaction of two molecules of gramicidin A controls the rate of ion flux. The structure of the molecule suggests that polar peptide groups line the channel and hydrophobic groups are on the periphery of the channel interacting with the lipid membrane.

The antibiotic ionophores have been a valuable experimental tool in studies involving ion translocation in biological membranes and for the manipulation of the ionic compositions of cells. There have been reports that proteolipids, prostaglandins, and perhaps other lipids present in mammalian tissues may function as ionophores.

Bibliography

General

Bonner, F. *Current Topics in Membranes and Transport*. A series published regularly. New York: Academic Press.

Caplen, M. *Cell Biology and Membrane and Transport Processes*. San Diego: Academic Press, 1994.

Davis, L. I. The nuclear pore complex. *Annu. Rev. Biochem.* 64:865, 1995.

Dobler, M. *Ionophores and Their Structure*. New York: Wiley-Interscience, 1981.

Gennis, R. B. *Biomembranes: Molecular Structure and Function*. New York: Springer-Verlag, 1989.

Gregoriadas, G. Engineering liposomes for drug delivery: progress and problems. *Trends Biotechnol.* 13:527, 1995.

Harwood, J. L. Understanding liposomal properties to aid in their clinical usage. *Trends Biochem. Sci.* 17:203, 1992.

Hockstra, D. *Cell Lipids*. San Diego: Academic Press, 1994.

Jain, M. K. *Introduction to Biological Membranes*, 2nd ed. New York: Wiley, 1988.

Jones, M. N. *Micelles, Monolayers, and Biomembranes*. New York: Wiley-Liss, 1995.

Lipowsky, R., and Sackmann, E. *Structure and Dynamics of Membranes*. New York: Elsevier Science, 1995.

Papa, S., and Tager, J. M. *Biochemistry of Cell Membranes*. Basel: Birkhauser Verlag, 1995.

Shohet, S. B., and Lux, S. E. The erythrocyte membrane skeleton: biochemistry and pathophysiology. *Hosp. Pract.* 19:77–83 and 89–108, 1984.

Stein, W. D. *Channels, Carriers, and Pumps: An Introduction to Membrane Transport*. San Diego: Academic Press, 1990.

Watts, A. *Protein-Lipid Interactions*. New York: Elsevier, 1993.

Yeagle, P. *The Membranes of Cells*. San Diego: Academic Press, 1993.

Membrane Structure

Devaux, P. F. Static and dynamic lipid asymmetry in cell membranes. *Biochemistry* 30:1163, 1991.

Low, M., and Saliel, A. R. Structural and functional roles of glycosylphosphatidyl inositol in membranes. *Science* 239:268, 1988.

McMurchie, E. J. Dietary lipids and the regulation of membrane fluidity and function. In: *Physiological Regulation of Membrane Fluidity*. New York: Liss, 1988, p. 189.

Singer, S. J., and Nicolson, G. L. The fluid mosaic model of the structure of cell membranes. *Science* 175:720, 1972.

Stubbs, C. D. Membrane fluidity: structure and dynamics of membrane lipids. In P. N. Campbell and R. D. Marshall (Eds.), *Essays in Biochemistry*, Vol. 19. London: Academic Press, 1983, p. 1.

Yeagle, P. L. Lipid regulation of cell membrane structure and function. *FASEB J.* 3:1833, 1989.

Transport Processes

Agutter, P. S. Intracellular structure and nucleocytoplasmic transport. *Int. Rev. Cytol.* 162B:183, 1995.

Bamberg, E., and Passow, H. *The Band 3 Proteins: Anion Transporters, Binding Proteins and Senescent Antigens*. New York: Elsevier, 1992.

Carafoli, E. The Ca^{2+} pump of the plasma membrane. *J. Biol. Chem.* 267: 2115, 1992.

Catterall, W. A. Structure and function of voltage-gated ion channels. *Annu. Rev. Biochem.* 64:493, 1995.

Eisenman, G., and Dani, J. A. An introduction to molecular architecture and permeability of ion channels. *Annu. Rev. Biophys. Chem.* 16:205, 1987.

Gould, G. W., and Holman, G. D. The glucose transporter family: structure, function and tissue specific expression. *Biochem. J.* 295:329, 1993.

Hediger, M. A., Kanai, U., You, G., and Nussberger, S. Mammalian ion-coupled solute transporters. *J. Physiol. (Lond)* 482:75, 1995.

Horne, D. W. Transport of folates and antifolates in liver. *Proc. Soc. Exp. Biol. Med.* 202:385, 1993.

Kakuda, D. K., and MacLeod, C. L. Na^{+} -independent transport (uniport) of amino acids and glucose in mammalian cells. *J. Exp. Biol.* 196:93, 1994.

Kanai, Y., Smith, C. P., and Hediger, M. A. A new family of neurotransmitter transporters: the high affinity glutamate transporters. *FASEB J.* 7:1450, 1993.

Kanner, B. I. Sodium-coupled neurotransmitter: structure, function and regulation. *J. Exp. Biol.* 196:237, 1994.

Katz, A. M. Cardiac ion channels. *N. Engl. J. Med.* 328:1244, 1993.

Maeckler, M. Facilitative glucose transporters. *Eur. J. Biochem.* 219:713, 1994.

Marsh, D. Peptide models for membrane channels. *Biochem. J.* 315:345, 1996.

Martonosi, A. (Ed.). *The Enzymes of Biological Membranes: Membrane Transport*, Vol. 3, New York: Plenum Press, 1985.

McGiven, J. D., and Pastor-Anglada, M. Regulatory and molecular aspects of mammalian amino acid transport. *Biochem. J.* 299:321, 1994.

Miller, M., Park, N.K., and Hanover, J.A. Nuclear pore complex: structure, function and regulation. *Physiol. Rev.* 71:909, 1991.

Pederson, P., and Carafoli, E. Ion motive ATPases. I. Ubiquity, properties, and significance to cell function, and II. Energy coupling and work output. *Trends Biochem. Sci.* 12:146 and 186, 1987.

Poole, R. C., and Halestrap, A. P. Transport of lactate and other monocarboxylates across mammalian plasma membranes. *Am. J. Physiol.* 264:C761, 1993.

Skou, J. C., and Norby, D. G. (Eds.). *Na^{+} , K^{+} -ATPase: Structure and Kinetics*. New York: Academic Press, 1979.

Worrall, D. M., and Williams, D. C. Sodium ion-dependent transporters for neurotransmitters: a review of recent developments. *Biochem. J.* 297:425, 1994.

Questions

C. N. Angstadt and J. Baggott

1. Cell membranes typically:

- A. are about 90% phospholipid.
- B. have both integral and peripheral proteins.
- C. contain cholesteryl esters.
- D. contain free carbohydrate such as glucose.
- E. contain large amounts of triacylglycerols.

Refer to the following for Questions 2–5:

- A. cerebrosides
- B. gangliosides
- C. phosphatidylcholines
- D. phosphatidylinositols
- E. sphingomyelins

2. Sphingolipids containing phosphorus.

3. Incorporate an oligosaccharide containing sialic acid.

4. Belong to the class of neutral glycosphingolipids.

5. Contain a hexahydroxy alcohol.

6. According to the fluid mosaic model of a membrane:

- A. proteins are always completely embedded in the lipid bi-layer.
- B. transverse movement (flip-flop) of a protein in the membrane is thermodynamically favorable.
- C. the transmembrane domain has largely hydrophobic amino acids.
- D. proteins are distributed symmetrically in the membrane.
- E. peripheral proteins are attached to the membrane only by noncovalent forces.

7. Characteristics of a mediated transport system include:

- A. nonspecific binding of solute to transporter.
- B. release of the transporter from the membrane following transport.
- C. a rate of transport directly proportional to the concentration of solute.
- D. release of the solute only if the concentration on the new side is lower than that on the original side.
- E. a mechanism for translocating the solute from one side of the membrane to the other.

8. Membrane channels:

- A. have a large aqueous area in the protein structure so are not very selective.
- B. commonly contain amphipathic α -helices.
- C. are opened or closed only as a result of a change in the transmembrane potential.
- D. are the same as gap junctions.
- E. allow substrates to flow only from the outside to inside of the cell.

9. Which of the following require(s) a transporter that specifically binds a solute?

- A. active mediated transport
- B. gap junction
- C. membrane channel
- D. simple diffusion
- E. all of the above

10. Which of the following can transport a solute against its concentration gradient?
- active mediated transport
 - passive mediated transport
 - both of the above systems
 - neither of the above systems
11. The transport system that maintains the Na^+ and K^+ gradients across the plasma membrane of cells:
- involves an enzyme that is an ATPase.
 - is a symport system.
 - moves Na^+ either into or out of the cell.
 - is an electrically neutral system.
 - in the membrane, hydrolyzes ATP independently of the movement of Na^+ and K^+ .
12. A mediated transport system would be expected to:
- show a continuously increasing initial rate of transport with increasing substrate concentration.
 - exhibit structural and/or stereospecificity for the substance transported.
 - be slower than that of a simple diffusion system.
 - establish a concentration gradient across the membrane.
 - exist only in plasma membranes.

The answers to Questions 13 and 14 are based on the following figure:

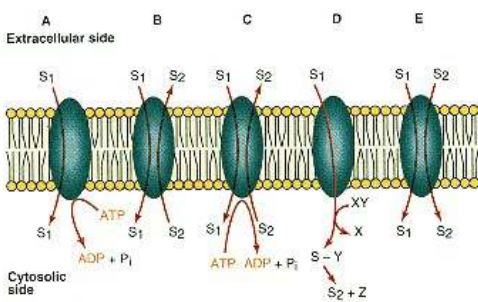

13. Represents a passive mediated antiport system.
14. Could represent the Na^+ -driven uptake of glucose.
15. The translocation of Ca^{2+} across a membrane:
- is a passive mediated transport.
 - is an example of a symport system.
 - involves the phosphorylation of a serine residue by ATP.
 - may be regulated by the binding of a Ca^{2+} -calmodulin complex to the transporter.
 - maintains $[\text{Ca}^{2+}]$ very much higher in the cell than in extracellular fluid.
16. The group translocation type of transport system:
- does not require metabolic energy.
 - involves the transport of two different solute molecules simultaneously.
 - has been demonstrated for fatty acids.
 - results in the alteration of the substrate molecule during the transport process.
 - uses ATP to maintain a concentration gradient.
17. All of the following are correct about an ionophore EXCEPT it:
- requires the input of metabolic energy for mediated transport of an ion.
 - may diffuse back and forth across a membrane.
 - may form a channel across a membrane through which an ion may diffuse.
 - may catalyze electrogenic mediated transport of an ion.
 - will have specificity for the ion it moves.

Answers

- B (Figures 5.2 and 5.17). A: This is more than the total lipid. C: Cholesterol in membranes is unesterified. D: All carbohydrate in membranes is in the form of glycoproteins and glycolipids. E: This is a minor component, if present (pp. 180 and 187).
- E A sphingomyelin is the only type of sphingolipid-containing phosphate (Figures 5.13).
- B By definition, gangliosides contain sialic acid (p. 185).
- A Cerebrosides are neutral; no phosphate; uncharged sugar. Gangliosides, by virtue of the presence of sialic acid, are acidic. Note: Sulfatides, which are acidic, are derived from cerebrosides but are not themselves classified as cerebrosides (pp. 184 and 185).
- D The alcohol is inositol, which is often phosphorylated (p. 182).
- C Hydrophobic domains will be in the interior; hydrophilic domains will be at either surface of the membrane (p. 189, Figure 5.19). A: Proteins may also be on the surface. B: Transverse motion of proteins is even less than that of lipids (p. 195). D: Both proteins and lipids are distributed asymmetrically. E: Glycans bind covalently to an amino acid as part of GPI anchors (p. 192).
- E A: Specificity of binding is an integral part of the process. B: Recovery of the transporter to its original condition is one of the characteristics of mediated transport. C: Only at low concentrations of solute; transporters show saturation kinetics. D: Active transport, movement against a gradient, is also mediated transport (p. 198).
- B A: This describes a pore; channels are quite specific. C: Voltage-gated channels, like that for Na^+ , are controlled this way but others, like the nicotinic-acetylcholine channel, are chemically regulated. D: Clusters of membrane channels

work together to form a gap junction. E: Substances may move in either direction as dictated by the concentration gradient (p. 201).

9. A Specific binding by the transporter is a characteristic of mediated systems. B–D: These do not require a transporter (p. 196).

10. A Transportation against a gradient requires the input of energy (p. 204).

11. A The Na^+, K^+ transporter is the Na^+, K^+ -ATPase. It is an antiport, vectorial (Na^+ out), electrogenic (3 Na^+ , 2 K^+) system. ATP hydrolysis is not useless (p. 206).

12. B A and B: Mediated transport systems show saturation kinetics and substrate specificity (p. 199). C: The purpose of the transporter is to aid the transport of water-soluble substances across the lipid membrane (p. 197). D: This would be true only if the system were an active one. E: Mediated systems are also present in other membranes, for example, mitochondrial membrane (p. 199).

13. B The figure is a modified composite of Figures 5.32, 5.38, 5.39, and 5.48.

14. E All systems are mediated. A: An active uniport. B: A passive antiport; for example, $\text{Cl}^- - \text{HCO}_3^-$. C: An *active* antiport; for example, Na^+, K^+ -ATPase. D: A group translocation representing a change in S_1 during transport. E: A symport system; in this case, S_1 could be glucose and S_2 could be Na^+ .

15. D This occurs with the eukaryotic plasma membrane (p. 208). A and B: Ca^{2+} translocation is an active uniport. C: Like Na^+, K^+ -ATPase, phosphorylation occurs on an aspartyl residue. E: Extracellular is about 10,000 times higher.

16. D In eukaryotic cells, amino acids are transported by group translocation in which they are converted to a γ -glutamyl amino acid during transport (Figure 5.48). A and E: It is an active system with the ATP used to resynthesize the intermediate, glutathione. B and C: The system transports a single amino acid at a time (p. 210).

17. A Ionophores transport by passive mediated mechanisms (p. 212). B and C: These are the two major types of ionophores. D: Valinomycin transports K^+ by a uniport mechanism. There are also antiport systems that are electroneutral. E: For example, valinomycin has an affinity for K^+ 1000 times greater than for Na^+ .

Chapter 6— Bioenergetics and Oxidative Metabolism

Merle S. Olson

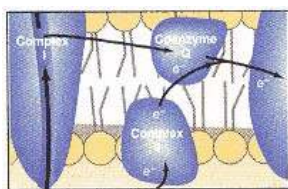

6.1 Energy-Producing and Energy-Utilizing Systems	218
ATP Links Energy-Producing and Energy-Utilizing Systems	218
6.2 Thermodynamic Relationships and Energy-Rich Components	220
Free Energy Is the Energy Available for Useful Work	220
The Caloric Value of Dietary Substances	222
Compounds Are Classified on the Basis of Energy Released on Hydrolysis of Specific Groups	222
Free-Energy Changes Can Be Determined in Coupled Enzyme Reactions	224
High-Energy Bond Energies of Various Groups can be Transferred from One Compound to Another	225
6.3 Sources and Fates of Acetyl Coenzyme A	226
Metabolic Sources and Fates of Pyruvate	227
Pyruvate Dehydrogenase Is a Multienzyme Complex	227
Pyruvate Dehydrogenase Is Strictly Regulated	228
Acetyl CoA Is Used by Several Different Pathways	231
6.4 The Tricarboxylic Acid Cycle	231
Reactions of the Tricarboxylic Acid Cycle	232
Conversion of the Acetyl Group of Acetyl CoA to CO ₂ and H ₂ O Conserves Energy	237
The Activity of the Tricarboxylic Acid Cycle Is Carefully Regulated	238
6.5 Structure and Compartmentation by Mitochondrial Membranes	238
Inner and Outer Mitochondrial Membranes Have Different Compositions and Functions	241
Mitochondrial Inner Membranes Contain Substrate Transport Systems	243
Substrate Shuttles Transport Reducing Equivalents across the Inner Mitochondrial Membrane	243
Acetyl Units Are Transported by Citrate	244
Transport of Adenine Nucleotides and Phosphate	245
Mitochondria Have a Specific Calcium Transport Mechanism	246
6.6 Electron Transfer	246
Oxidation–Reduction Reactions	247
Free-Energy Changes in Redox Reactions	248
Mitochondrial Electron Transport Is a Multicomponent System	249
NAD-Linked Dehydrogenases	249
Flavin-Linked Dehydrogenases	251
Iron–Sulfur Centers	251
Cytochromes	252
Coenzyme Q	253
The Mitochondrial Electron Transport Chain Is Located in the Inner Membrane in a Specific Sequence	255
Electron Transport Can Be Inhibited at Specific Sites	259
Electron Transport Is Reversible	259
Oxidative Phosphorylation Is Coupled to Electron Transport	260
6.7 Oxidative Phosphorylation	261
The Chemiosmotic-Coupling Mechanism Involves the Generation of a Proton Gradient and Reversal of an ATP-Dependent Proton Pump	262
Bibliography	264
Questions and Answers	264
Clinical Correlations	
6.1 Pyruvate Dehydrogenase Deficiency	233
6.2 Fumarase Deficiency	237
6.3 Mitochondrial Myopathies	247
6.4 Subacute Necrotizing Encephalomyelopathy	258
6.5 Cyanide Poisoning	259
6.6 Hypoxic Injury	261

6.1—

Energy-Producing and Energy-Utilizing Systems

Living cells are composed of a complex, intricately regulated system of energy-producing and energy-utilizing chemical reactions. Metabolic reactions involved in energy generation break down ingested or stored fuels such as carbohydrate, lipid, or protein in what are termed **catabolic** pathways. These reactions usually result in the conversion of large complex molecules to smaller molecules (ultimately CO_2 and H_2O), with production of storable or conservable energy, and often require the consumption of oxygen during this process. Such reactions are accelerated during periods of fuel deprivation or stress to an organism.

Energy-utilizing reactions perform various necessary, and in many instances tissue-specific, cellular functions, for example, nerve impulse conduction, muscle contraction, growth, and cell division. Metabolic pathways involved in the biosynthesis of large, complex molecules from smaller precursors are termed **anabolic** pathways and require the expenditure of energy. Such reactions are accelerated when energy is readily available, when precursor molecules are in abundance, or during periods of growth or regeneration of cellular material.

ATP Links Energy-Producing and Energy-Utilizing Systems

The relationship between energy-producing and energy-utilizing functions of the cell is illustrated in Figure 6.1. Energy may be derived from oxidation of metabolic fuels presented to the organism usually in the form of carbohydrate, lipid, and protein. The proportion of each fuel utilized as an energy source depends on the tissue and the dietary and hormonal state of the organism. For example, mature erythrocytes and adult brain in the fed state use only carbohydrate as a source of energy, whereas the liver of a diabetic or fasted individual metabolizes primarily lipid to meet the energy demands. Energy may be consumed during performance of various energy-linked (work) functions, some of which are indicated in Figure 6.1. Note that the liver and the pancreas are primarily involved in biosynthetic and secretory work functions, whereas the primary function of cardiac and skeletal muscle involves converting metabolic energy into mechanical energy during muscle contraction.

The essential link between energy-producing and energy-utilizing pathways is the nucleoside triphosphate, **adenosine 5'-triphosphate (ATP)** (Figure 6.2). The ATP molecule is a purine (adenine) nucleotide in which the adenine is attached in a glycosidic linkage to D-ribose. Three phosphoryl groups are esterified to the 5 position of the ribose moiety in **phosphoanhydride bonds**. The

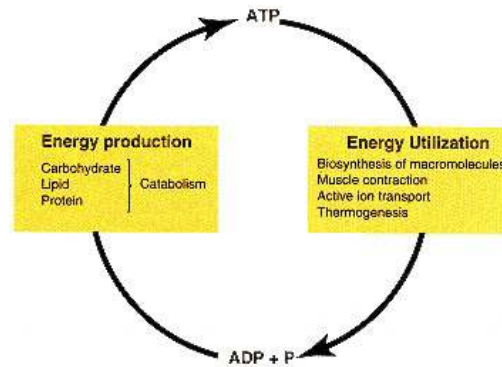

Figure 6.1
Relationship between energy production and energy utilization.

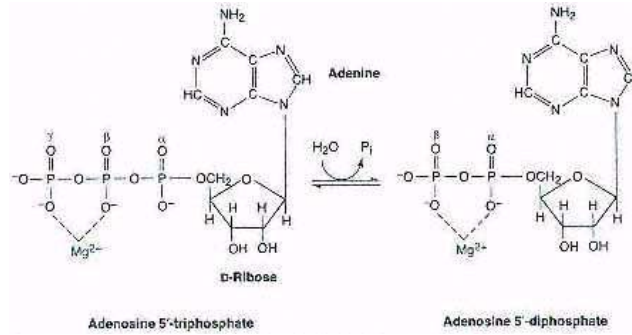

Figure 6.2

Structure of ATP and ADP complexed with Mg^{2+} .

two terminal phosphoryl groups (i.e., β and γ) are involved in the phosphoric acid anhydride bonding and are designated as energy-rich or **high-energy bonds**. Synthesizing ATP as a result of a catabolic process or consuming ATP in an energy-linked cellular function involves formation and either hydrolysis or transfer of the terminal phosphate group of ATP. The physiological form of this nucleotide is chelated with a divalent metal cation such as magnesium. Adenosine diphosphate also chelates magnesium, but the affinity of the metal cation for ADP is considerably less than for ATP. Although adenine nucleotides are mainly involved in energy generation or conservation, various nucleoside triphosphates, including ATP, are involved in transferring energy during biosynthetic processes. As indicated in Figure 6.3, the guanine nucleotide **GTP** serves as the source of energy in gluconeogenesis and protein synthesis, whereas

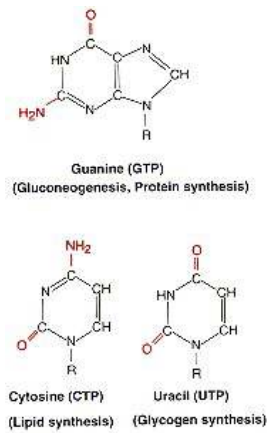

Figure 6.3

Structures of purine and pyrimidine bases involved in various biosynthetic pathways.

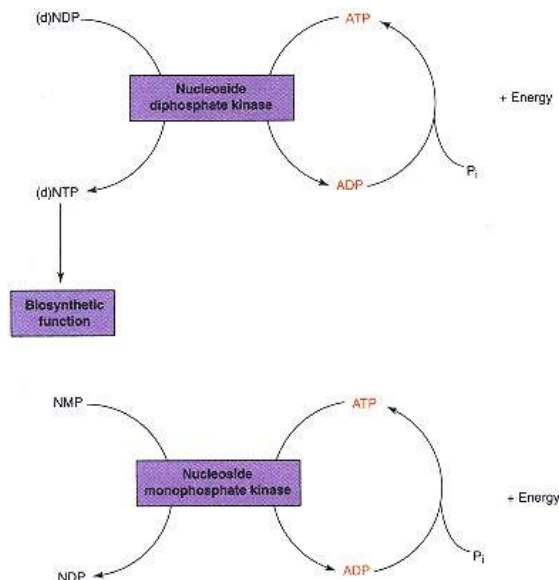

Figure 6.4

Nucleoside diphosphate kinase and nucleoside monophosphate kinase reactions. N represents any purine or pyrimidine base; (d) indicates a deoxyribonucleotide.

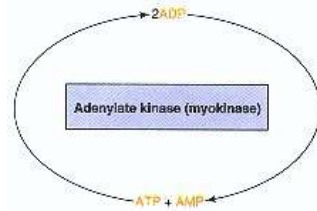

Figure 6.5
Adenylate kinase (myokinase) reaction.

UTP (uracil) and CTP (cytosine) are utilized in glycogen and lipid synthesis, respectively. The energy in the terminal phosphate bonds of ATP may be transferred to the other nucleotides, using either the **nucleoside diphosphate kinase** or the **nucleoside monophosphate kinase** reactions illustrated in Figure 6.4 (p. 219). Two nucleoside diphosphates can be converted to a nucleoside triphosphate and a nucleoside monophosphate in various nucleoside **monophosphate kinase** reactions, such as the adenylate kinase reaction (Figure 6.5). The utility of these types of enzymes is that the terminal energy-rich phosphate bonds of ATP may be transferred to the appropriate nucleotides and utilized in a variety of biosynthetic processes.

6.2—

Thermodynamic Relationships and Energy-Rich Components

Because living cells interconvert different forms of energy and may exchange energy with their surroundings, it is necessary to review the principles of **hermodynamics**, which govern reactions of this type. Knowledge of these principles will facilitate a perception of how energy-producing and energy-utilizing metabolic reactions are permitted to occur within the same cell and how an organism is able to accomplish various work functions.

The **first law of thermodynamics** states that energy can neither be created nor destroyed. This law of energy conservation stipulates that, although energy may be converted from one form to another, the total energy in a system must remain constant. For example, chemical energy available in a metabolic fuel such as glucose can be converted in the process of glycolysis to another form of chemical energy, ATP. In skeletal muscle chemical energy involved in the energy-rich phosphate bonds of ATP may be converted to mechanical energy during the process of muscle contraction. The energy involved in an osmotic electropotential gradient of protons across the mitochondrial membrane may be converted to chemical energy using the proton gradient to drive ATP synthesis.

To discuss the **second law of thermodynamics** the term **entropy** must be defined. Entropy, designated by S , is a measure or indicator of the degree of disorder or randomness in a system. Entropy can be viewed as the energy in a system that is unavailable to perform useful work. All processes, whether chemical or biological, tend to progress toward a situation of maximum entropy. Equilibrium in a system will result when the randomness or disorder (entropy) is at a maximum. However, it is nearly impossible to quantitate entropy changes in biochemical systems and such systems are rarely at equilibrium. For simplicity and because of its inherent utility in these considerations, a quantity termed **free energy** is employed.

Free Energy Is the Energy Available for Useful Work

Free energy (denoted by G) of a system is that portion of the total energy in a system that is available for useful work. It can be further defined by

$$\Delta G = \Delta H - T\Delta S$$

In this expression for a system proceeding toward equilibrium at a constant temperature and pressure, G is the change in free energy, H is the change in enthalpy or the heat content, T is the absolute temperature, and S is the change in entropy of the system. It can be deduced from this relationship that at equilibrium $G = 0$. Furthermore, any process that exhibits a negative free-energy change proceeds to equilibrium, since energy is given off, and is called an **exergonic reaction**. A process that exhibits a positive free-energy change will not occur independently; energy from some other source must be applied to this process to allow it to proceed toward equilibrium, and this type of

process is termed an **endergonic reaction**. It should be noted that the change in free energy in a biochemical process is the same regardless of the pathway or mechanism employed to attain the final state. Whereas the rate of a given reaction depends on the free energy of activation, the magnitude of the ΔG is not related to the rate of the reaction. The change in free energy for a chemical reaction is related to the equilibrium constant of that reaction. For example, an enzymatic reaction may be described as

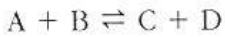

And an expression for the equilibrium constant may be written as

$$K_{eq} = \frac{[C][D]}{[A][B]}$$

The free-energy change (ΔG) at a constant temperature and pressure is defined as

$$\Delta G = \Delta G^\circ + RT \ln \left(\frac{[C][D]}{[A][B]} \right)$$

where ΔG is the free-energy change; ΔG° is the standard free-energy change, which is a constant for each individual reaction; reactants and products in the reaction are present at concentrations of 1.0 M; R is the gas constant, which is 1.987 cal mol⁻¹ K⁻¹ or 8.134 J mol⁻¹ K⁻¹, depending on whether the resultant free-energy change is expressed in calories (cal) or joules (J) per mole; and T is the absolute temperature in degrees Kelvin (K).

Because at equilibrium $\Delta G = 0$, the expression reduces to

$$\Delta G^\circ = -RT \ln K_{eq}$$

or

$$\Delta G^\circ = -2.3RT \log K_{eq}$$

Hence, if the **equilibrium constant** for a reaction can be determined, the standard free-energy change (ΔG°) for that reaction also can be calculated. The relationship between ΔG° and K_{eq} is illustrated in Table 6.1. When the equilibrium constant of a reaction is less than unity, the reaction is endergonic, and ΔG° is positive. When the equilibrium constant is greater than unity, the reaction is exergonic, and ΔG° is negative.

In energy-producing and energy-utilizing metabolic pathways in cellular systems, free-energy changes characteristic of individual enzymatic reactions in an entire pathway are additive, for example,

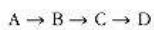

$$\Delta G_{A \rightarrow D}^\circ = \Delta G_{A \rightarrow B}^\circ + \Delta G_{B \rightarrow C}^\circ + \Delta G_{C \rightarrow D}^\circ$$

Although any given enzymatic reaction in a sequence may have a characteristic positive free-energy change, as long as the sum of all the free-energy changes is negative, the pathway will proceed.

Another way of expressing this principle is that enzymatic reactions with positive free-energy changes may be coupled to or driven by reactions with negative free-energy changes associated with them. In a metabolic pathway such as glycolysis, various individual reactions either have positive ΔG° values or ΔG° values that are close to zero. On the other hand, there are other reactions that have large and negative ΔG° values, which drive the entire pathway. The crucial consideration is that the sum of the ΔG° values for the individual reactions in a pathway must be negative in order for such a metabolic sequence to be thermodynamically feasible. Also, as for all chemical reactions, individual enzymatic reactions in a metabolic pathway or the pathway as a whole would

TABLE 6.1 Tabulation of Values of K_{eq} and ΔG°

K_{eq}	ΔG° (kcal mol ⁻¹)
10 ⁻⁴	5.46
10 ⁻³	4.09
10 ⁻²	2.73
10 ⁻¹	1.36
1	0
10	-1.36
10 ²	-2.73
10 ³	-4.09
10 ⁴	-5.46

TABLE 6.2 Free-Energy Changes and Caloric Values Associated with the Total Metabolism of Various Metabolic Fuels

Compound	Molecular Weight	ΔG° (kcal mol ⁻¹)	Caloric Value (kcal g ⁻¹)
Glucose	180	-686	3.81
Lactate	90	-326	3.62
Palmitate	256	-2380	9.30
Tripalmitin	809	-7510	9.30
Glycine	75	-234	3.12

be facilitated if the concentrations of the reactants (substrates) of the reaction exceed the concentrations of the products of the reaction.

The Caloric Value of Dietary Substances

During complete stepwise oxidation of glucose, a primary metabolic fuel in cells, a large quantity of energy is available. The free energy released during the oxidation of glucose in a functioning cell is illustrated in the following equation:

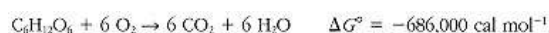

When this process occurs under aerobic conditions in most cells, it is possible to conserve less than one half of this "available" energy as 38 molecules of ATP. The

G° values for oxidation of other metabolic fuels are listed in Table 6.2. Carbohydrates and proteins (amino acids) have a caloric value of 3–4 kcal g⁻¹, while lipid (i.e., palmitate, a long-chain fatty acid, or a triacylglycerol) exhibits a caloric value nearly three times greater. The reason that more energy can be derived from lipid than from carbohydrate or protein relates to the average oxidation state of the carbon atoms in these substances. Carbon atoms in carbohydrates are considerably more oxidized (or less reduced) than those in lipids (Figure 6.6). Hence during sequential breakdown of lipid nearly three times as many **reducing equivalents** (a reducing equivalent is defined as a proton plus an electron, i.e., H⁺ + e⁻) can be extracted than from carbohydrate. Reducing equivalents may be utilized for ATP synthesis in the mitochondrial energy transduction sequence.

Carbohydrate



Oxidized

Lipid



Reduced

Figure 6.6
Oxidation states of typical carbon atoms in carbohydrates and lipids.

Compounds Are Classified on the Basis of Energy Released on Hydrolysis of Specific Groups

The two terminal phosphoryl groups of ATP contain energy-rich or high-energy bonds. What this description is intended to convey is that the free energy of hydrolysis of an energy-rich phosphoanhydride bond is much greater than would be obtained for a simple phosphate ester. High-energy is not synonymous with stability of the bonding arrangement in question, nor does it refer to the energy required to break such bonds. The concept of high-energy compounds implies that the products of the hydrolytic cleavage of the energy-rich bond are in more stable forms than the original compound. As a rule, simple phosphate esters (low-energy compounds) exhibit negative G° values of hydrolysis in the range 1–3 kcal mol⁻¹, whereas high-energy bonds have negative G° values in the range 5–15 kcal mol⁻¹. Phosphate esters such as glucose 6-phosphate and glycerol 3-phosphate are examples of low-energy compounds. Table 6.3 lists various types of energy-rich compounds with approximate values for their G° values of hydrolysis.

There are various reasons why certain compounds or bonding arrangements

TABLE 6.3 Examples of Energy-Rich Compounds

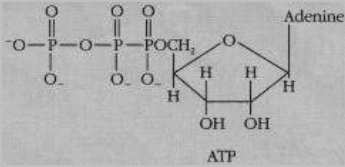
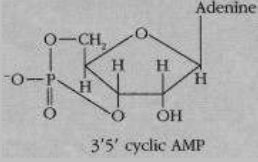
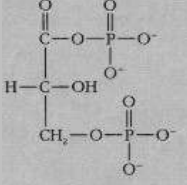
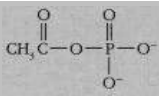
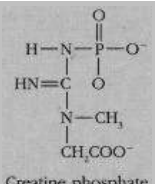
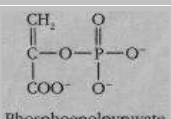
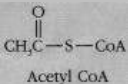
Type of Bond	ΔG° of Hydrolysis (kcal mol^{-1})	Example
Phosphoric acid anhydrides	-7.3	 <p>ATP</p>
	-11.9	 <p>3',5' cyclic AMP</p>
Phosphoric-carboxylic acid anhydrides	-10.1	 <p>1,3-Bisphosphoglycerate</p>
	-10.3	 <p>Acetyl phosphate</p>
Phosphoguanidines	-10.3	 <p>Creatine phosphate</p>
Enol phosphates	-14.8	 <p>Phosphoenolpyruvate</p>
Thiol esters	-7.7	 <p>Acetyl CoA</p>

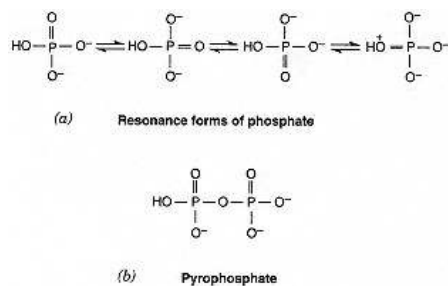

Figure 6.7
(a) Resonance forms of phosphate.
(b) Structure of pyrophosphate.

are energy rich. First, products of the hydrolysis of an energy-rich bond may exist in more **resonance forms** than the precursor molecule. The more possible resonance forms in which a molecule can exist stabilize that molecule. The resonance forms for inorganic phosphate (P_i) can be written as indicated in Figure 6.7.

Fewer resonance forms can be written for ATP or **pyrophosphate** (PP_i) (Figure 6.7) than for phosphate (P_i).

Second, many high-energy bonding arrangements have groups of similar electrostatic charges located in close proximity to each other in such compounds. Because like charges repel one another, hydrolysis of energy-rich bonds alleviates this situation and, again, lends stability to the products of hydrolysis. Third, hydrolysis of certain energy-rich bonds results in the formation of an unstable compound, which may isomerize spontaneously to form a more stable compound. Hydrolysis of phosphoenolpyruvate is an example of this type of compound (Figure 6.8). The G° for isomerization is considerable, and the final product, in this case pyruvate, is much more stable. Finally, if a product of the hydrolysis of a high-energy bond is an undissociated acid, dissociation of the proton and its subsequent buffering may contribute to the overall G° of the hydrolytic reaction. In general, any property or process that lends stability to products of hydrolysis tends to confer a high-energy character to that compound.

The high-energy character of **3',5'-cyclic adenosine monophosphate (cAMP)** has been attributed to the fact that the phosphoanhydride bonding character in this compound is strained as it bridges the 3' and 5' positions on the ribose. The energy-rich character of thiol ester compounds such as acetyl CoA or succinyl CoA results from the relatively acidic character of the thiol group. Hence **acetyl CoA** is nearly equivalent to an anhydride rather than a simple thioester.

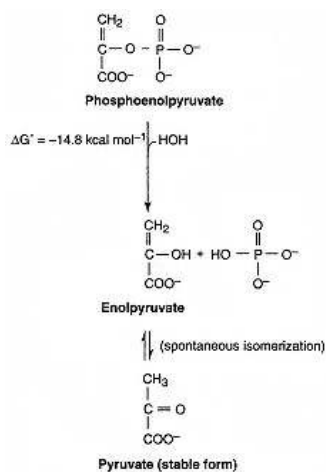
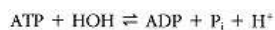

Figure 6.8
 Hydrolysis of phosphoenolpyruvate.

Free-Energy Changes Can Be Determined in Coupled Enzyme Reactions

The G° value of hydrolysis of the terminal phosphate of ATP is difficult to determine by simply utilizing the K_{eq} of the hydrolytic reaction because of the position of the equilibrium.



However, the G° of hydrolysis of ATP can be determined indirectly because of the additive nature of free-energy changes. Hence free energy of hydrolysis of ATP can be determined by adding G° of an ATP-utilizing reaction such as hexokinase to G° of a reaction that cleaves the phosphate from the pro-

duct of the **hexokinase** reaction, **glucose 6-phosphate** (G6P), as indicated below:

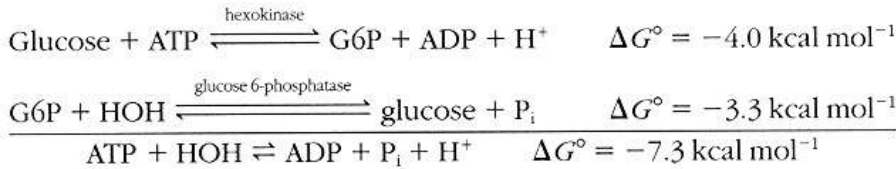

Free energies of hydrolysis for other energy-rich compounds can be determined in a similar fashion.

High-Energy Bond Energies of Various Groups Can Be Transferred from One Compound to Another

Energy-rich compounds can transfer various groups from the parent (donor) compound to an acceptor compound in a thermodynamically feasible fashion as long as an appropriate enzyme is present to facilitate the transfer. The energy-rich intermediates in the glycolytic pathway such as **1,3-bisphosphoglycerate** and phosphoenolpyruvate can transfer their high-energy phosphate moieties to ATP in the **phosphoglycerate kinase** and **pyruvate kinase** reactions, respectively (Figure 6.9a). The G° values of these two reactions are -4.5 and -7.5 kcal mol⁻¹, respectively, and hence transfer of "high-energy" phosphate is thermodynamically possible, and ATP synthesis is the result. ATP can transfer its terminal high-energy phosphoryl groups to form compounds of relatively similar high-energy character [i.e., **creatine phosphate** in the **creatine kinase** reaction (Figure 6.9b)] or compounds that are of considerably lower energy, such as glucose 6-phosphate formed in the hexokinase reaction (Figure 6.9c).

Thus phosphate or other transferable groups can be transferred from compounds that contain energy-rich bonding arrangements to compounds that have bonding characteristics of a lower energy in thermodynamically permissible enzymatic reactions. This principle is a major premise of the interaction between energy-producing and energy-utilizing metabolic pathways in living cells.

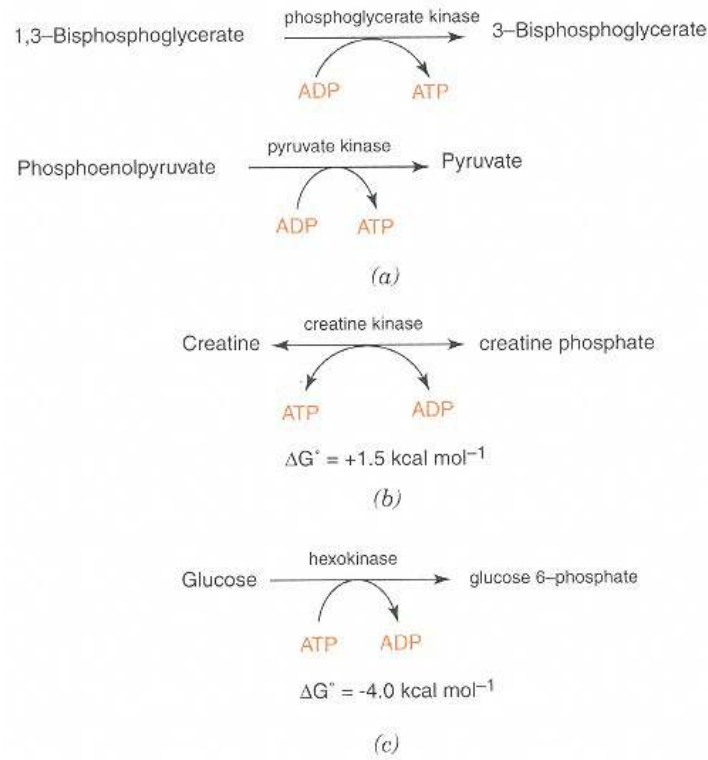

Figure 6.9
Examples of reactions involved in transfer of "high-energy" phosphate.

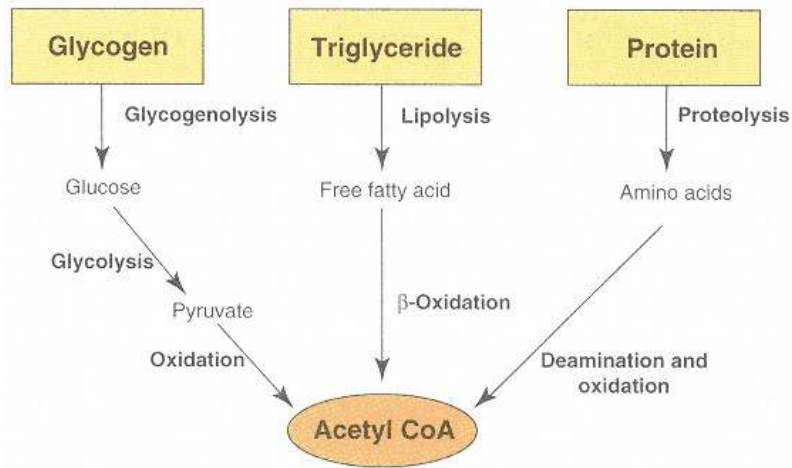

Figure 6.10
General precursors of acetyl CoA.

6.3—

Sources and Fates of Acetyl Coenzyme A

Most of the major energy-generating metabolic pathways of cells eventually result in production of the two-carbon unit **acetyl coenzyme A** (CoA). As illustrated in Figure 6.10, the catabolic breakdown of ingested or stored carbohydrate in the glycolytic pathway, of long-chain fatty acids in the **β -oxidation sequence**, or certain amino acids following **transamination** or **deamination** and subsequent oxidation provide precursors for the formation of acetyl CoA.

The structure of acetyl CoA is shown in Figure 6.11. This complex coenzyme, abbreviated either as CoA or CoASH, is composed of β -mercaptoethylamine, the vitamin **pantothenic acid**, and the adenine nucleotide, adenosine 3'-phosphate 5'-diphosphate. Coenzyme A exists as the reduced thiol (CoASH) and is involved in a variety of acyl group transfer reactions, where CoA alternately serves as the acceptor, then the donor, of the acyl group. Various metabolic pathways involve only acyl CoA derivatives, for example, β -oxidation of fatty acids and **branched-chain amino acid** degradation. Information on the

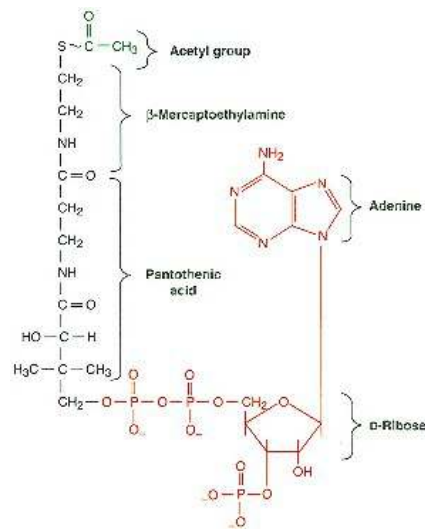
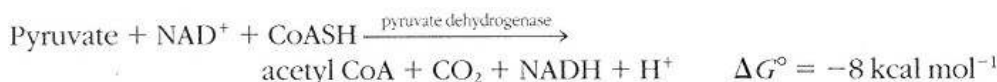

Figure 6.11
Structure of acetyl CoA.

nutritional aspects of the pantothenic acid will be described in Chapter 28. Like many other nucleotide species, CoA derivatives are not freely transported across cellular membranes. This property has necessitated the evolution of certain transport or shuttle mechanisms by which various intermediates or groups can be transferred across membranes. Such acyl transferase reactions for acetyl groups and long-chain acyl groups will be discussed in Chapter 9. Since the thiol ester linkage in acyl CoA derivatives is an energy-rich bond, these compounds can serve as effective donors of acyl groups in acyl transferase reactions. Also, to synthesize an acyl CoA derivative a high-energy bond of ATP must be expended, such as in the **acetate thiokinase** reaction,



The β -oxidation of fatty acids is a primary source of acetyl CoA in many tissues; a detailed description of the mobilization, transport, and oxidation of fatty acids is presented in Chapter 9. Note, however, that the products of the β -oxidation sequence are acetyl CoA and reducing equivalents (i.e., **NADH**). In certain tissues (e.g., cardiac muscle) and under somewhat special metabolic conditions in other tissues (e.g., in brain during prolonged starvation), acetyl CoA for energy generation may be derived from the **ketone bodies**, **acetoacetate** and **β -hydroxybutyrate**.

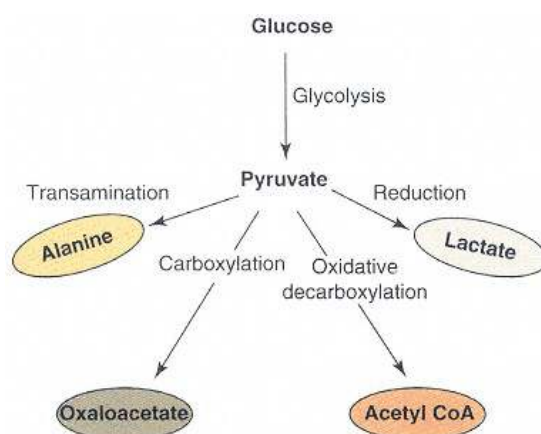

Figure 6.12
Metabolic fates of pyruvate.

Metabolic Sources and Fates of Pyruvate

During aerobic glycolysis (Chapter 7), glucose or other monosaccharides are converted to pyruvate, the end product of this cytosolic pathway. Also, degradation of amino acids such as alanine, serine, and cysteine results in the production of **pyruvate** (see p. 447). Pyruvate has a variety of metabolic fates, depending on the tissue and the metabolic state of that tissue. The major types of reactions in which pyruvate participates are indicated in Figure 6.12. The oxidative decarboxylation of pyruvate in the **pyruvate dehydrogenase** reaction is discussed next; the other reactions involving pyruvate are discussed in Chapter 7.

Pyruvate Dehydrogenase Is a Multienzyme Complex

Pyruvate is converted to acetyl CoA by the pyruvate dehydrogenase multienzyme complex.

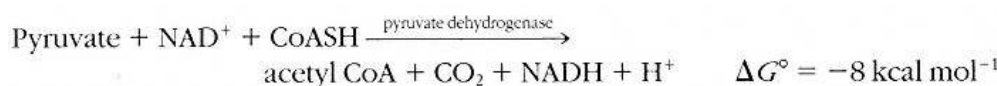

This enzyme is located exclusively in the mitochondrial matrix and is present in high concentrations in tissues such as cardiac muscle and kidney. Because of the large negative G° of the pyruvate dehydrogenase reaction, under physiological conditions the reaction is irreversible. This fact is the primary reason that a net conversion of fatty acid carbon to carbohydrate cannot occur; for example, acetyl CoA from fatty acids cannot be converted to pyruvate. Molecular weights of the multienzyme complex derived from kidney, heart, or liver range from 7 to 8.5×10^6 . The mammalian pyruvate dehydrogenase enzyme complex consists of three different types of catalytic subunits:

Number of Subunits/Complex	Type	Molecular Weight	Subunit Structure
20 or 30 ^a	Pyruvate dehydrogenase	154,000	$\alpha_2\beta_2$ Tetramer
60	Dihydrolipoyl transacetylase	52,000	Identical
6	Dihydrolipoyl dehydrogenase	110,000	α_2 Dimer

^a Depending on source.

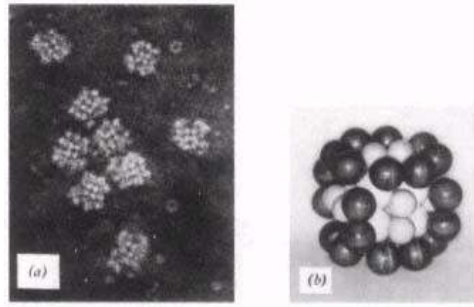

Figure 6.13
Pyruvate dehydrogenase complex from *E. coli*.
(a) Electron micrograph.
 (b) Molecular model. The enzyme complex was negatively stained with phosphotungstate ($\times 200,000$).
 Courtesy of Dr. Lester J. Reed, University of Texas, Austin.

The structure of the pyruvate dehydrogenase complex derived from *Escherichia coli* (particle weight, 4.6×10^6) is somewhat different from that of the mammalian enzyme. Electron micrographs of the bacterial enzyme complex (Figure 6.13) indicate that the transacetylase, which consists of 24 identical polypeptide chains (mol wt = 64,500), forms the cube-like core of the complex (white spheres in the model shown in Figure 6.11). Twelve pyruvate dehydrogenase dimers (black spheres; mol wt = 90,500) are distributed symmetrically on the 12 edges of the transacetylase cube. Six dihydrolipoyl dehydrogenase dimers (gray spheres; mol wt = 56,000) are distributed on the six faces of the cube. Five different coenzymes or prosthetic groups are involved in the pyruvate dehydrogenase reaction (Table 6.4 and Figure 6.14). The mechanism of the pyruvate dehydrogenase reaction occurs as illustrated in Figure 6.15.

Because of active participation of thiol groups in the catalytic mechanism, agents that either oxidize or complex with thiol groups are strong inhibitors of the enzyme complex. **Arsenite** is such an inhibitor.

Pyruvate Dehydrogenase Is Strictly Regulated

Two types of regulation of the pyruvate dehydrogenase complex have been characterized. First, two products of the pyruvate dehydrogenase reaction, acetyl

TABLE 6.4 Function of Coenzymes and Prosthetic Groups of the Pyruvate Dehydrogenase Reaction

<i>Coenzyme or Prosthetic Group</i>	<i>Location</i>	<i>Function</i>
Thiamine pyrophosphate	Bound to pyruvate dehydrogenase	Reacts with substrate, pyruvate
Lipoic acid	Covalently attached to a lysine residue on the dihydrolipoyl transacetylase	Accepts acetyl group from thiamine pyrophosphate
Coenzyme A	Free in solution	Accepts acetyl group from lipoamide group on the transacetylase
Flavin adenine dinucleotide (FAD)	Tightly bound to dihydrolipoyl dehydrogenase	Accepts reducing equivalents from reduced lipoamide group
Nicotinamide adenine dinucleotide	Free in solution	Terminal acceptor of reducing equivalents from the reduced flavoprotein

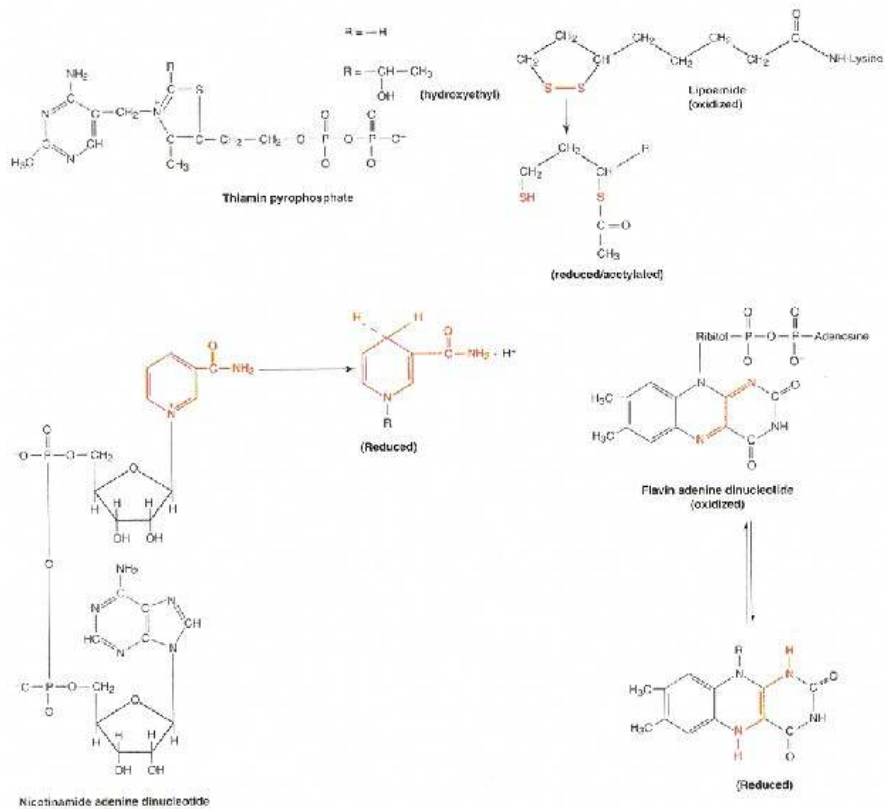

Figure 6.14
Structures of coenzymes involved in the pyruvate dehydrogenase reaction.
See Figure 6.11 for the structure of CoA.

CoA and NADH, inhibit the complex in a competitive fashion. Second, the pyruvate dehydrogenase complex exists in two forms: (1) an active, dephosphorylated complex and (2) an inactive, phosphorylated complex. Inactivation of the complex is accomplished by a Mg^{2+} -ATP-dependent **protein kinase**, which is tightly bound to the enzyme complex. Reactivation is accomplished by a **phosphoprotein phosphatase**, which dephosphorylates the complex in a Mg^{2+} - and Ca^{2+} -dependent reaction. Three separate serine residues on the α subunit of pyruvate dehydrogenase are phosphorylated by the protein kinase but the phosphorylation of only one serine is related to the activity of the complex. The differential regulation of the pyruvate dehydrogenase kinase and phosphatase is the key to the regulation of the pyruvate dehydrogenase complex. Essential features of this complex regulatory system are illustrated in Figure 6.16. Acetyl CoA and NADH, products of pyruvate dehydrogenase, inhibit the

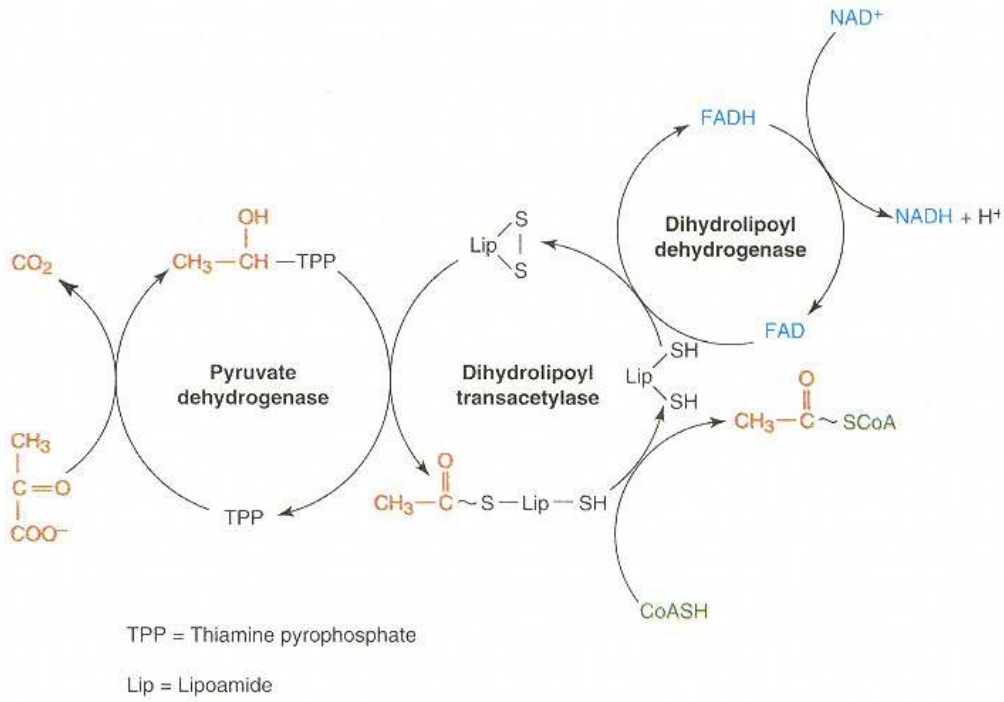

Figure 6.15
Mechanism of the pyruvate dehydrogenase reaction; the pyruvate dehydrogenase multienzyme complex.

dephospho (active) form of the enzyme, but these two compounds stimulate the protein kinase reaction, leading to an interconversion of the complex to its inactive form. In addition, free CoASH and NAD^+ inhibit the protein kinase. Hence, with any increase of the mitochondrial NADH/NAD^+ or acetyl CoA/CoASH ratio, such as during rapid β -oxidation of fatty acids, pyruvate dehydrogenase will be inactivated by the kinase reaction. In addition, pyruvate, the substrate of the enzyme, is a potent inhibitor of the protein kinase, and therefore in the presence of elevated tissue pyruvate levels the kinase will be inhibited and the complex maximally active. Finally, **insulin** administration activates

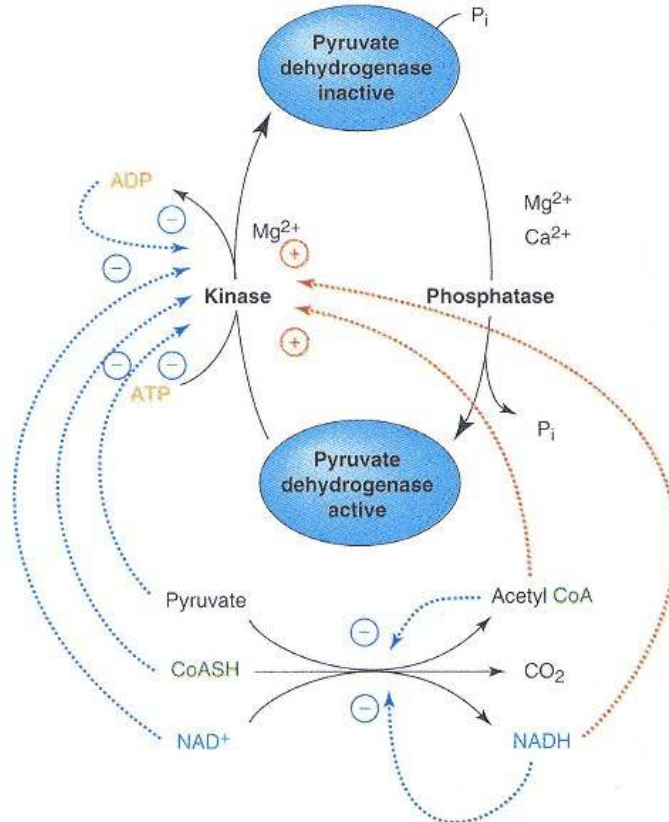

Figure 6.16
Regulation of the pyruvate dehydrogenase multienzyme complex.

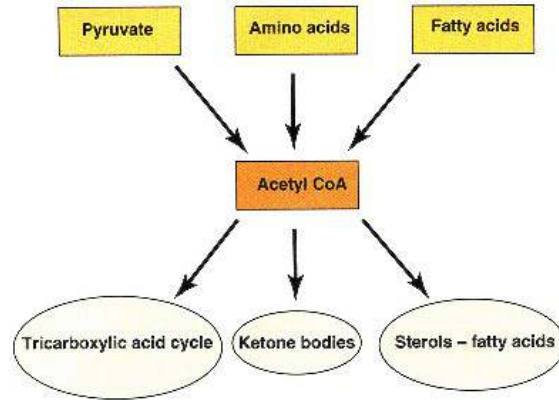

Figure 6.17
Sources and fates of acetyl CoA.

pyruvate dehydrogenase in adipose tissue, and catecholamines, such as **epinephrine**, activate pyruvate dehydrogenase in cardiac tissue. The mechanisms of these hormonal effects are not well understood, but alterations of the intracellular distribution of Ca^{2+} , such that the phosphoprotein phosphatase reaction is stimulated in the mitochondrial matrix, may be involved in these effects. These hormonal effects are not mediated directly by alterations in the tissue cAMP levels because the pyruvate dehydrogenase protein kinase and phosphatase are cAMP-independent or insensitive (see Clin. Corr. 6.1).

Acetyl CoA Is Used by Several Different Pathways

The various fates of acetyl CoA generated in the mitochondrial matrix include (1) complete oxidation of the acetyl group in the tricarboxylic acid cycle for energy generation; (2) in the liver, conversion of excess acetyl CoA into ketone bodies, acetoacetate and β -hydroxybutyrate; and (3) transfer of the acetyl units to the cytosol with subsequent biosynthesis of such molecules as sterols (see Chapter 10) and long-chain fatty acids (see Chapter 9) (Figure 6.17).

6.4— The Tricarboxylic Acid Cycle

The primary metabolic fate of acetyl CoA produced in the various energy-generating catabolic pathways of most cells is its complete oxidation in a cyclic series of reactions termed the **tricarboxylic acid (TCA) cycle**. This metabolic cycle is also commonly referred to as the **citric acid cycle** or the **Krebs cycle** after Sir Hans Krebs who postulated the essential features of this pathway in 1937. Various investigators defined many of the enzymes and di- and tricarboxylic acid intermediates but it was Krebs who pieced them together. The primary location of the enzymes of the TCA cycle is in the mitochondrion, although isozymes of some are found in the cytosol. This type of distribution is appropriate because the pyruvate dehydrogenase multienzyme complex and the fatty acid β -oxidation sequence, the two primary sources for generating acetyl CoA, are also located in the mitochondrion. A primary function of the TCA cycle is to generate reducing equivalents that are utilized to generate energy, that is, ATP, in the **electron transport-oxidative phosphorylation** sequence, another process contained exclusively in the mitochondrion (Figure 6.18). Mitochondrial energy transduction is discussed in Section 6.7.

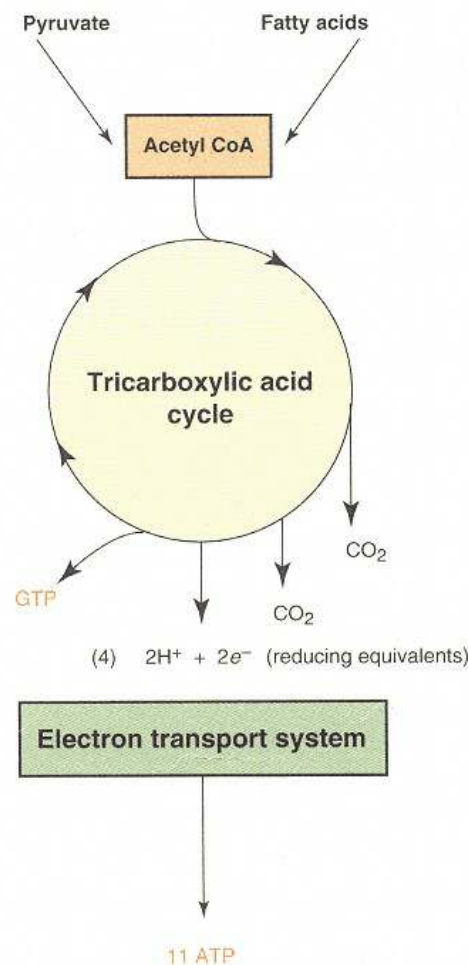

Figure 6.18
General description of mitochondrial ATP synthesis.

Figure 6.18 illustrates the essential process involved in the TCA cycle. The substrate of the cycle is the two-carbon unit acetyl CoA and the products of a complete turn of the cycle are two CO₂ plus one high-energy phosphate bond (as GTP) and four reducing equivalents (i.e., three NADH and one FADH₂).

Reactions of the Tricarboxylic Acid Cycle

The individual enzymatic reactions are presented in Figure 6.19. The initial step of the cycle is catalyzed by **citrate synthase**. This is a highly exergonic reaction and commits acetyl groups to **citrate** formation and complete oxidation in the Krebs cycle. As shown below citrate synthase involves condensation of an acetyl moiety and the α -keto function of the dicarboxylic acid **oxaloacetate**. Citrate synthase (mol wt 100,000) is in the mitochondrial matrix.

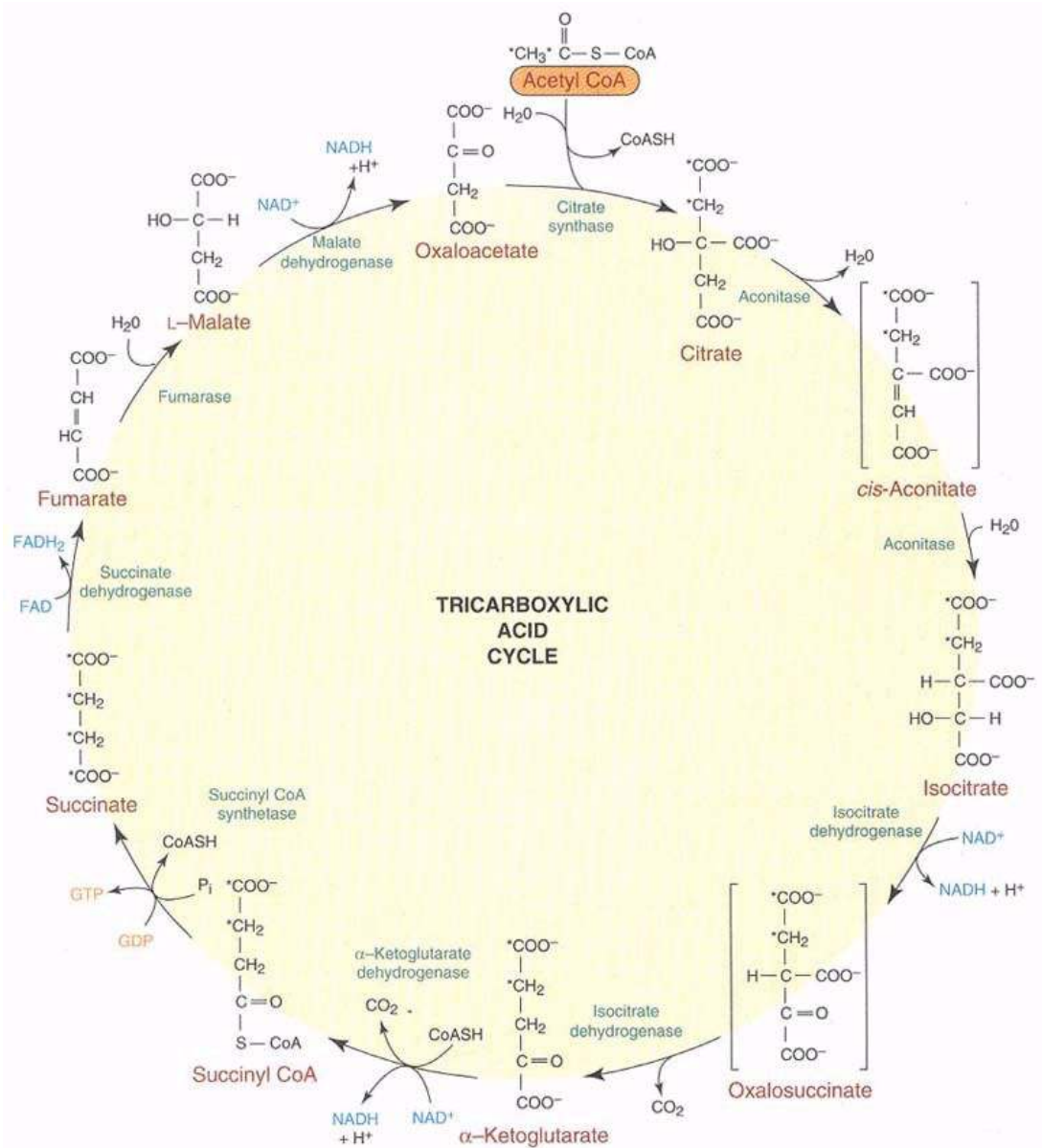
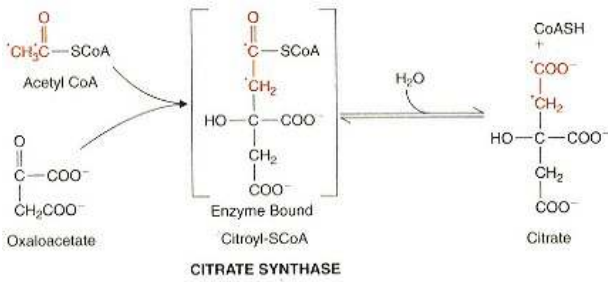

Figure 6.19
The tricarboxylic acid cycle.
 Asterisked carbons indicate the fate of the carbons of the acetyl group.



The equilibrium of this reaction is far toward citrate formation with a G° near -9 kcal mol^{-1} . The citroyl-S-CoA intermediate is not released from the enzyme during the reaction and remains bound to the catalytic site on citrate synthase. The citrate synthase reaction is considerably displaced from equilibrium under *in situ* conditions, which makes this step a primary candidate for regulatory modulation. The purified enzyme is regulated (inhibited) by ATP, NADH, succinyl CoA, and long-chain acyl CoA derivatives, but these effects have not been demonstrated in intact metabolic systems under physiological conditions.

CLINICAL CORRELATION 6.1

Pyruvate Dehydrogenase Deficiency

A variety of disorders in pyruvate metabolism have been detected in children. Some involve deficiencies of the different catalytic or regulatory subunits of the pyruvate dehydrogenase multienzyme complex. Children diagnosed with pyruvate dehydrogenase deficiency usually exhibit elevated serum levels of lactate, pyruvate, and alanine, which produce a chronic lactic acidosis. Such patients frequently exhibit severe neurological defects, and in most situations this type of enzymatic defect results in death. The diagnosis of pyruvate dehydrogenase deficiency is usually made by assaying the enzyme complex and/or its various enzymatic sub-units in cultures of skin fibroblasts taken from the patient. In certain instances patients respond to dietary management in which a ketogenic diet is administered and carbohydrates are minimized. Patients in shock have lactic acidosis because decreased delivery of O₂ to tissues inhibits pyruvate dehydrogenase and increases anaerobic metabolism. This situation has been treated with dichloroacetate, an inhibitor of pyruvate dehydrogenase kinase and therefore an activator of the enzyme complex.

Patel, M. S., and Harris, R. A. Mammalian α -keto acid dehydrogenase complexes: gene regulation and genetic defects. *FASEB J.* 9:1164, 1995.

The most probable means for regulating the citrate synthase reaction is availability of its two substrates, acetyl CoA and oxaloacetate. Note the many important fates and effects of citrate in energy and biosynthetic metabolism indicated in Figure 6.20; citrate is a regulatory effector of other metabolic pathways and a source of carbon and reducing equivalents for various synthetic purposes (see Chapters 7 and 9 for further details).

Citrate synthase reacts with **monofluoroacetyl CoA** to form **monofluoro-citrate**, a potent inhibitor of the next step in the cycle, the **aconitase** reaction. In fact, whether monofluorocitrate is synthesized *in situ* as a result of **fluoro-acetate** poisoning or administered experimentally, a nearly complete block of TCA cycle activity is observed.

Citrate is converted to isocitrate in the aconitase reaction:

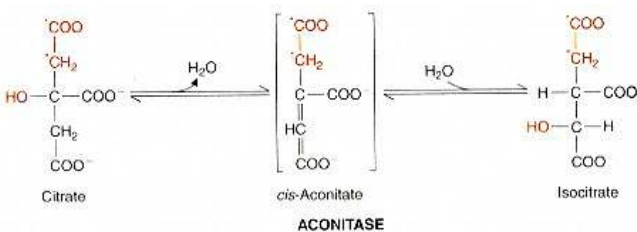

This reaction involves generation of an enzyme-bound intermediate, **cis-aconitate**. At equilibrium there exist 90% citrate, 3% *cis*-aconitate, and 7% isocitrate; hence the equilibrium of aconitase lies toward citrate formation. Although the aconitase reaction does not require cofactors, it requires ferrous (Fe²⁺) iron in its catalytic mechanism. This Fe²⁺ is involved in an **iron-sulfur center**, which is an essential component in the hydratase activity of aconitase.

Isocitrate dehydrogenase catalyzes the first dehydrogenase reaction in the TCA cycle. Isocitrate is converted to **α -ketoglutarate** in an oxidative decarboxylation reaction. In this step of the cycle the initial (of two) CO₂ is produced and the initial (of three) NADH + H⁺ are generated. Isocitrate dehydrogenase

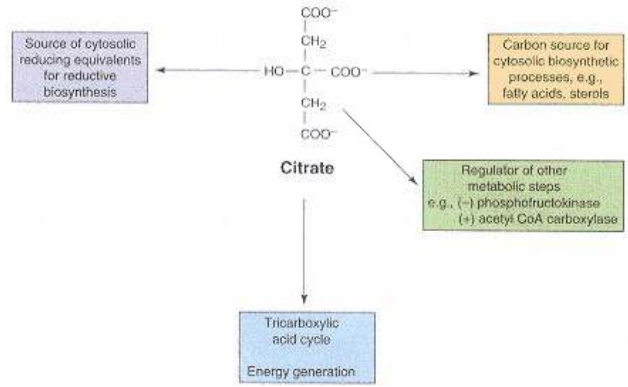
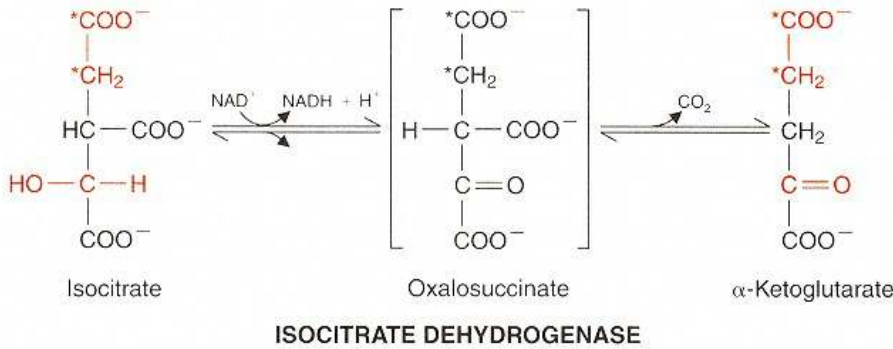

Figure 6.20
Fates and functions of citrate.

involved in mitochondria from mammalian tissues requires NAD^+ as the acceptor of reducing equivalents.



Mitochondria possess an isocitrate dehydrogenase that requires NADP^+ . The NADP^+ -linked enzyme is also found in the cytosol, where it is involved in providing reducing equivalents for cytosolic reductive processes. The equilibrium of this reaction lies strongly toward α -ketoglutarate formation with a G° of nearly -5 kcal mol^{-1} . NAD^+ -linked isocitrate dehydrogenase has a molecular weight of 380,000 and consists of eight identical subunits. The reaction requires a divalent metal cation (e.g., Mn^{2+} or Mg^{2+}) in decarboxylation of the β position of oxalosuccinate. NAD^+ -linked isocitrate dehydrogenase is stimulated by ADP and in some cases AMP and is inhibited by ATP and NADH. Hence, under high-energy conditions (i.e., high ATP/ADP + P_i and high NADH/ NAD^+ ratios), NAD^+ -linked isocitrate dehydrogenase of the TCA cycle is inhibited. During periods of low energy the activity of this enzyme is stimulated in order to accelerate energy generation by the TCA cycle.

Conversion of α -ketoglutarate to succinyl CoA is catalyzed by the α -ketoglutarate dehydrogenase multienzyme complex, which is nearly identical to the pyruvate dehydrogenase complex in terms of reactions catalyzed and some of its structural features. Again, thiamine pyrophosphate, lipoic acid, CoASH, FAD, and NAD^+ participate in the catalytic mechanism. The multienzyme complex consists of α -ketoglutarate dehydrogenase, dihydrolipoyl transsuccinylase, and dihydrolipoyl dehydrogenase as three catalytic subunits. The equilibrium of the α -ketoglutarate dehydrogenase reaction lies strongly toward succinyl CoA formation with a G° of -8 kcal mol^{-1} . In this reaction the second molecule of CO_2 and the second reducing equivalent (i.e., $\text{NADH} + \text{H}^+$) of the cycle are produced. Another product of this reaction, succinyl CoA, is an energy-rich thiol ester compound similar to acetyl CoA. Unlike the pyruvate dehydrogenase complex, α -ketoglutarate dehydrogenase

complex is not regulated by a protein kinase-mediated phosphorylation reaction. The nucleoside triphosphates—ATP and GTP—NADH, and succinyl CoA inhibit this enzyme complex while Ca^{2+} has been shown to activate α -ketoglutarate dehydrogenase in certain tissues.

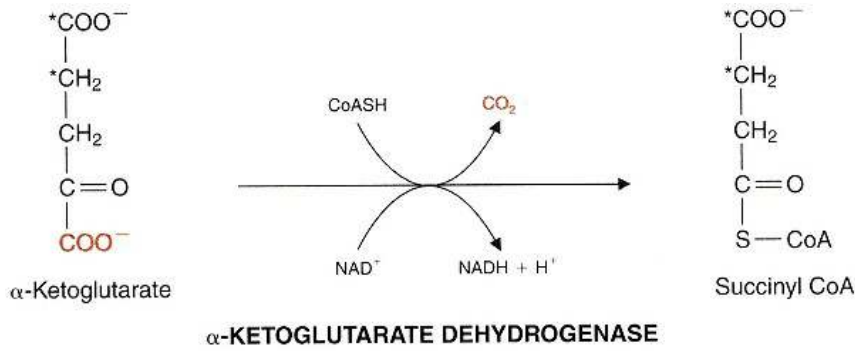

It is at the level of α -ketoglutarate that an intermediate may leave the TCA cycle to be reductively aminated in the glutamate dehydrogenase reaction. This mitochondrial enzyme converts α -ketoglutarate to glutamate in the presence of NADH or NADPH and ammonia. Using various transamination reactions the amino group incorporated into glutamate can be transferred to a variety of amino acids. These enzymes and the relevance of the incorporation or release of ammonia into or from α -keto acids are discussed in Chapter 11.

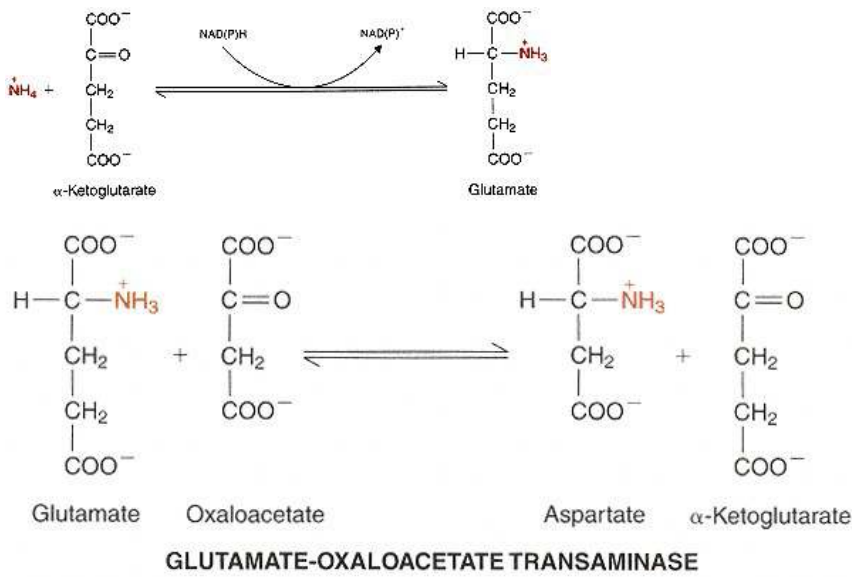

The energy-rich character of the thiol ester linkage of succinyl CoA is conserved in a substrate-level phosphorylation reaction in the next step of the TCA cycle. **Succinyl-CoA synthetase** (or succinate thiokinase) converts succinyl CoA to succinate and in mammalian tissues results in phosphorylation of GDP to GTP.

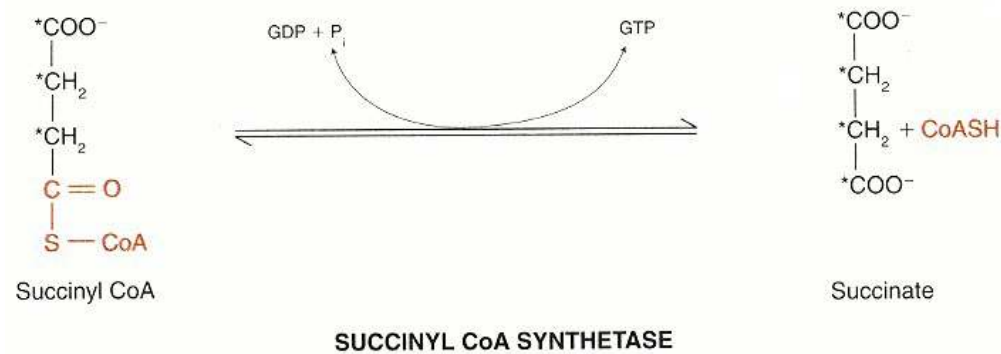

This reaction is freely reversible with $G^\circ = -0.7 \text{ kcal mol}^{-1}$ and the catalytic mechanism involves an enzyme–succinyl phosphate intermediate.

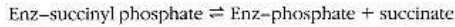
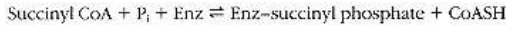

The enzyme is phosphorylated on the 3 position of a histidine residue during the succinyl-CoA synthetase reaction. Hence, in this step of the TCA cycle, a high-energy bond is conserved as GTP. Because of the presence of the nucleoside diphosphate kinase discussed earlier in this chapter, the γ -phosphate of GTP can be transferred to ADP to generate ATP.

Succinyl CoA represents a metabolic branch point in that intermediates may enter or exit the TCA cycle at this point (Figure 6.21). Succinyl CoA may be formed either from α -ketoglutarate in the cycle or from **methylmalonyl CoA** in the final steps of breakdown of odd-chain length fatty acids or the branched-chain amino acids valine and isoleucine. Metabolic fates of succinyl CoA include its conversion to succinate in the succinyl-CoA synthetase reaction of the Krebs cycle and its condensation with glycine to form **δ -aminolevulinate** by **δ -aminolevulinate synthase**, the initial reaction in **porphyrin** biosynthesis (see p. 1011).

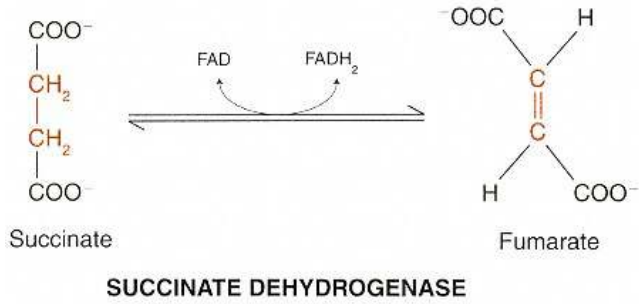

Succinate is oxidized to **fumarate** by **succinate dehydrogenase**, which is tightly bound to the inner mitochondrial membrane and is composed of two

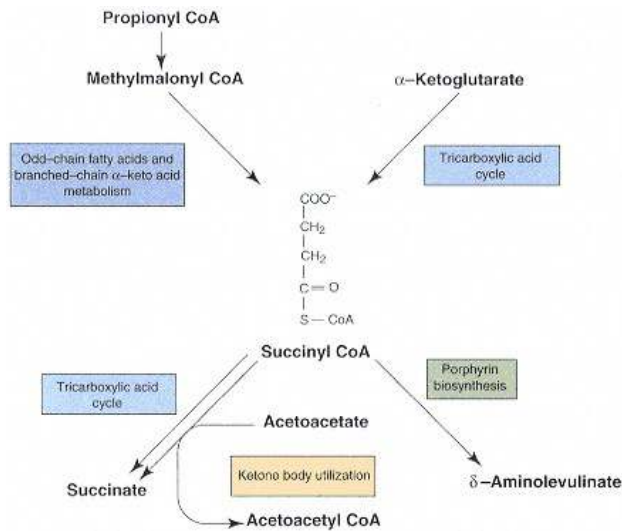

Figure 6.21
Sources and fates of succinyl CoA.

subunits with mol wt 70,000 and 30,000. The 70,000 mol wt subunit contains the substrate-binding site, covalently bound FAD (to a lysine residue), four nonheme iron atoms, and four acid-labile sulfur atoms, whereas the 30,000 mol wt subunit contains four nonheme irons and four acid-labile sulfur atoms. This enzyme is a typical example of an **iron-sulfur protein** in which nonheme iron undergoes valence changes (e.g., $\text{Fe}^{2+} \rightarrow \text{Fe}^{3+}$) during removal of electrons and protons from succinate and subsequent transfer of these reducing equivalents through covalently bound FAD to the mitochondrial electron-transfer chain at the coenzyme Q-cytochrome *b* level.

Succinate dehydrogenase is strongly inhibited by malonate and oxaloacetate and is activated by ATP, P_i and succinate. **Malonate** inhibits succinate dehydrogenase competitively with respect to succinate. This inhibitory characteristic of malonate is due to a very close structural similarity between malonate and succinate (Figure 6.22). Malonate is used experimentally as a very effective inhibitor of the TCA cycle in complex metabolic systems. In fact, the ability of malonate to inhibit the cycle was used by Krebs as evidence for the cyclic nature of this oxidative metabolic pathway.

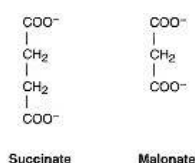
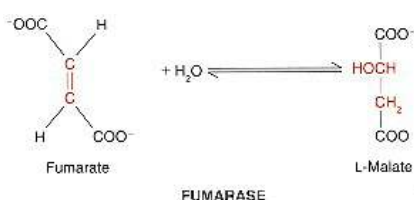

Figure 6.22
Structures of succinate, a TCA cycle intermediate; malonate, a cycle inhibitor; and maleate, a compound not involved in the cycle.

Fumarate is hydrated to form **L-malate** in the next step in the TCA cycle by the enzyme fumarase.



Fumarase is a tetramer (mol wt 200,000) and is stereospecific for the trans form of substrate (the cis form, maleate, is not a substrate; Figure 6.22). The product of the reaction is L-malate and the reaction is freely reversible under physiological conditions. See Clin. Corr. 6.2 concerning a genetic deficiency of fumarase.

The final reaction in the TCA cycle is catalyzed by malate dehydrogenase with the final (of three) reducing equivalents as $\text{NADH} + \text{H}^+$ being removed from the cycle intermediates.

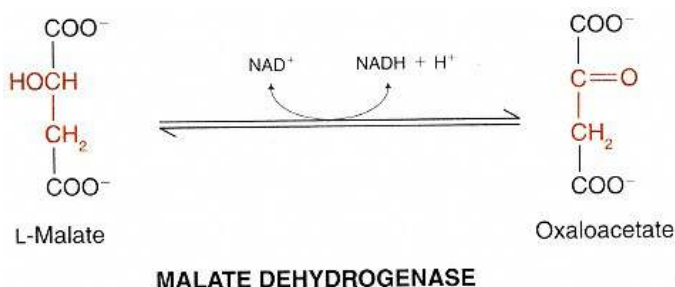

The equilibrium of the **malate dehydrogenase** reaction lies far toward L-malate formation, because $G^\circ = +7.0 \text{ kcal mol}^{-1}$. Thus the reaction is an endothermic reaction when considered in the forward direction. However, **citrate synthase** and other reactions of the cycle pull malate dehydrogenase toward **oxaloacetate** formation by removing oxaloacetate. In addition, NADH produced in various cycle NAD^+ -linked dehydrogenases is oxidized rapidly to NAD^+ by the mitochondrial respiratory chain.

CLINICAL CORRELATION 6.2

Fumarase Deficiency

Deficiencies of enzymes of the TCA cycle are rarely found. Several cases, however, are on record in which there is a severe deficiency of fumarase in both mitochondria and cytosol of tissues (e.g., blood lymphocytes). The condition is characterized by severe neurological impairment, encephalopathy, and dystonia developing soon after birth. Urine contains abnormal amounts of fumarate and one or more of succinate, α -ketoglutarate, citrate, and malate. Both enzymes are derived from a single gene and both parents had half-normal levels of enzyme activity but are clinically normal, as is appropriate for an autosomal recessive disorder. The first description of a mutation in the gene reported that glutamate at residue 319 was replaced by glutamine.

Bourgeron, T., Chretien, D., Poggi-Bach, J., et al. Mutation of the fumarase gene in two siblings with progressive encephalopathy and fumarase deficiency. *J. Clin. Invest.* 93:2514, 1994.

Conversion of the Acetyl Group of Acetyl CoA to CO_2 and H_2O Conserves Energy

In summary, the TCA cycle (Figure 6.18) serves as a terminal oxidative pathway for most metabolic fuels. Two-carbon moieties as acetyl CoA are taken into the

cycle and are oxidized completely to CO_2 and H_2O . During this process 4 reducing equivalents (3 as $\text{NADH} + \text{H}^+$ and 1 as FADH_2) are produced, which are used subsequently for energy generation. Oxidation of each $\text{NADH} + \text{H}^+$ results in formation of 3 ATP molecules in **oxidative phosphorylation**, while oxidation of FADH_2 formed in the succinate dehydrogenase reaction yields 2 molecules of ATP. Also, a high-energy bond is formed as GTP in the succinyl-CoA synthetase reaction. Hence the net yield of ATP or its equivalent (i.e., GTP) for the complete oxidation of an acetyl group in the Krebs cycle is 12.

During complete oxidation of glucose to CO_2 and H_2O , there is a net formation of (1) 2 molecules of ATP per glucose in the conversion of glucose to 2 molecules of pyruvate; (2) 6 molecules of ATP per glucose as a result of the translocation and subsequent oxidation in the mitochondrial matrix of 2 molecules of $\text{NADH} + \text{H}^+$ formed in the glyceraldehyde-3-phosphate dehydrogenase reaction of glycolysis; and (3) 30 molecules of ATP per glucose from the oxidation of the 2 molecules of pyruvate in the pyruvate dehydrogenase reaction and subsequent conversion of 2 molecules of acetyl CoA to CO_2 and H_2O in the TCA cycle. Hence the net ATP yield during the complete oxidation of glucose to $6 \text{CO}_2 + 6 \text{H}_2\text{O}$ is 38 molecules of ATP.

The Activity of the Tricarboxylic Acid Cycle Is Carefully Regulated

A variety of factors are involved in the regulation of the activity of the TCA cycle. First, the supply of acetyl units, whether derived from pyruvate (i.e., carbohydrate) or fatty acids, is a crucial factor in determining the rate of the cycle. Regulatory influences on the pyruvate dehydrogenase complex have an important effect on the cycle. Likewise, any control exerted on the processes of transport and β -oxidation of fatty acids would be an effective determinant of the cycle activity.

Second, because the primary dehydrogenase reactions of the Krebs cycle are dependent on a continuous supply of both NAD^+ and FAD, their activities are very stringently controlled by the mitochondrial respiratory chain, which is responsible for oxidizing the NADH and FADH_2 produced by substrate oxidation in the cycle. Because the activity of the respiratory chain is coupled obligatorily to the generation of ATP in the reactions of oxidative phosphorylation, the activity of the Krebs cycle is very much dependent on a respiratory control, which is strongly affected by the availability of ADP + phosphate and oxygen. Hence an inhibitory agent or metabolic condition that interrupts the supply of oxygen, the continuous supply of ADP, or the source of reducing equivalents (e.g., substrate for the cycle) would shut down cycle activity. This type of control of the cycle is generally considered to be a coarse control of the cycle. There are a variety of postulated effector-mediated regulatory interactions between various intermediates or nucleotides and the individual enzymes of the cycle, which may serve to exert a fine control on the activity of the cycle. Illustrations of these interactions are shown in Figure 6.23 and have been noted during the discussions of individual enzymes of the Krebs cycle. The physiological relevance of many of these types of individual regulatory interactions has not been established rigorously in intact metabolic systems.

6.5—

Structure and Compartmentation by Mitochondrial Membranes

Because the metabolic pathways for oxidation of pyruvate, the end product of glycolysis, and fatty acids are located in mitochondria, a major portion of the energy-generating capacity of most cells resides in the mitochondrial compartment of the cell. The number of mitochondria in various tissues (Figure 6.24a, b) reflects the physiological function of the tissue and determines its capacity

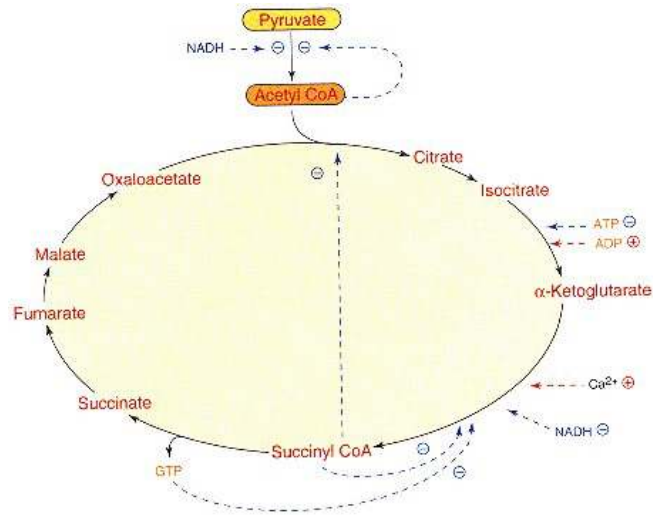

Figure 6.23
Representative examples of regulatory interactions in the TCA cycle.

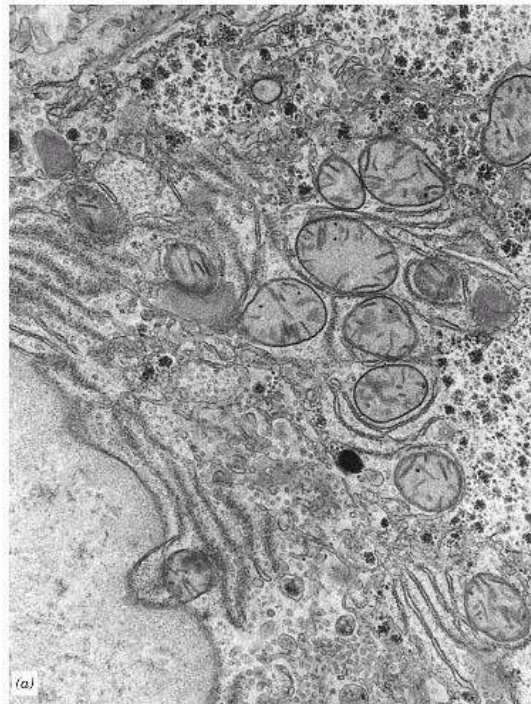

Figure 6.24
(a) Electron micrograph of mitochondria in hepatocytes from rat liver ($\times 39,600$).

Courtesy of Dr. W. B. Winborn, Department of Anatomy, The University of Texas Health Science Center at San Antonio, and the Electron Microscopy Laboratory, Department of Pathology, The University of Texas Health Science Center at San Antonio.

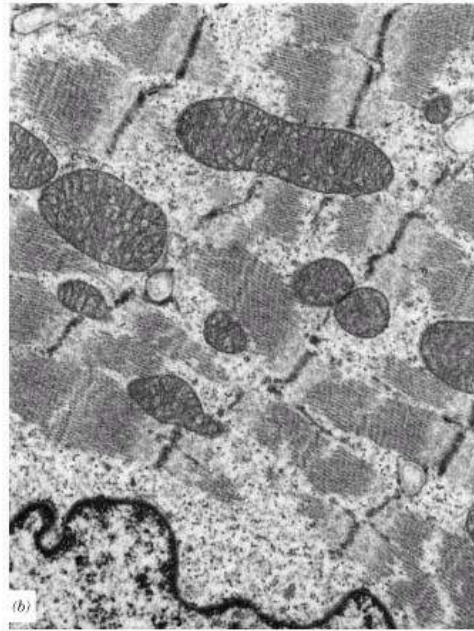

Figure 6.24
(b) Electron micrograph of mitochondria in muscle fibers from rabbit heart ($\times 39,600$).
Courtesy of Dr. W. B. Winborn, Department of Anatomy, The University of Texas Health Science Center at San Antonio, and the Electron Microscopy Laboratory, Department of Pathology, The University of Texas Health Science Center at San Antonio.

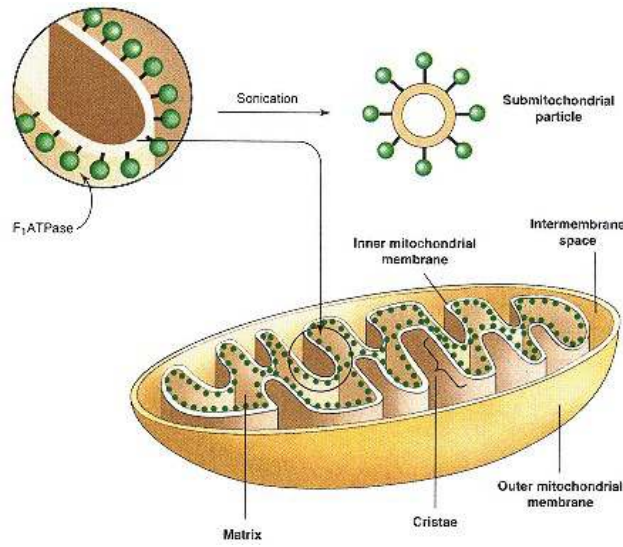

Figure 6.25
Diagram of various submitochondrial compartments.

to perform aerobic metabolic functions. For example, the erythrocyte has no mitochondria and does not possess the capacity to generate energy using oxygen as a terminal electron acceptor. On the other hand, cardiac tissue is a highly aerobic tissue, and it has been estimated that about one-half of the cytoplasmic volume of cardiac cells is composed of mitochondria. The liver is also highly dependent on aerobic metabolic processes for its various functions, and it has been estimated that mammalian hepatocytes contain between 800 and 2000 mitochondria. Mitochondria exist in a variety of different shapes, depending on the cell type from which they are derived. As can be seen in Figure 6.24 mitochondria from liver are nearly spherical in shape, whereas those found in cardiac muscle are oblong or cylindrical.

Inner and Outer Mitochondrial Membranes Have Different Compositions and Functions

Mitochondria are composed of two membranes, an outer and a highly invaginated inner membrane (Figure 6.25). The outer membrane is considered a rather simple membrane, composed of about 50% lipid and 50% protein, with relatively few enzymatic or transport functions. Table 6.5 defines some of the enzymatic components of the outer membrane.

The inner membrane is structurally and functionally much more complex than the outer membrane. Roughly 80% of the inner membrane is protein. It contains most of the enzymes involved in **electron transport** and oxidative phosphorylation, various dehydrogenases and several transport systems, which are involved in transferring substrates, metabolic intermediates and adenine nucleotides between the cytosol and the mitochondrial matrix (Table 6.5).

Some enzymatic components are loosely associated with the inner membrane, whereas others are either tightly bound or are actual structural elements of the membrane. Hence there is a wide variability in the extent to which physical (ultrasonic irradiation or freezing and thawing), chemical (organic solvent or detergent treatment), or enzymatic (protease or lipase) treatments remove, release, or inactivate the enzymes associated with the inner membrane.

TABLE 6.5 Enzymatic Composition of the Various Mitochondrial Subcompartments

<i>Outer Membrane</i>	<i>Intermembrane Space</i>	<i>Inner Membrane</i>	<i>Matrix</i>
Monoamine oxidase	Adenylate kinase	Succinate dehydrogenase	Pyruvate dehydrogenase
Kynurenine hydroxylase	Nucleoside diphosphate kinase	F ₁ -ATPase	Citrate synthase
Nucleoside diphosphate kinase		NADH dehydrogenase	Isocitrate dehydrogenase
Phospholipase A		β -Hydroxybutyrate dehydrogenase	α -Ketoglutarate dehydrogenase
Fatty acyl-CoA synthetases		Cytochromes <i>b, c, c, a, a₃</i>	Aconitase
NADH: cytochrome- <i>c</i> reductase (rotenone-insensitive)		Carnitine: acyl-CoA transferase	Fumarase
			Succinyl-CoA synthetase
		Adenine nucleotide translocase	
Choline phosphotransferase			Malate dehydrogenase
		Mono-, di-, and tricarboxylate translocase	
		Glutamate-aspartate translocase	Fatty acid β -oxidation system

Experimental procedures permit separation of inner from outer mitochondrial membranes. The outer membrane may be stripped off and isolated, using digitonin (a detergent), osmotic shock, or ultrasonic irradiation followed by density-gradient ultracentrifugation (Figure 6.26). The resulting inner membrane plus matrix fraction is referred to as a **mitoplast**. The contents of the matrix can be released from the mitoplast, by treatment with a nonionic detergent or vigorous sonication. Once the various subcompartments of the mitochondrion have been separated, analyses may be performed to determine the location of the various characteristic marker enzymes, several of which are listed in Table 6.5. Enzymatic markers have been used effectively to detect the presence of mitochondria or even a particular portion of mitochondria in membrane preparations of diverse derivation.

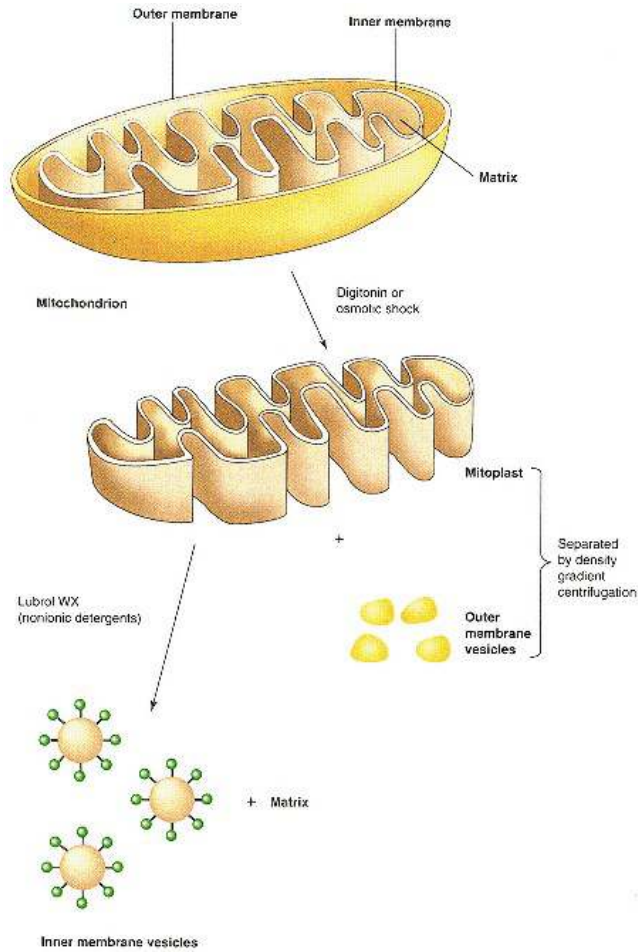

Figure 6.26
Separation of mitochondrial membranes.

Mitochondrial Inner Membranes Contain Substrate Transport Systems

Whereas the outer membrane presents little or no permeability barrier to substrate or nucleotide molecules of interest in energy metabolism, the inner membrane limits the types of substrates, intermediates, and nucleotides that can diffuse from the cytosol into the matrix compartment.

Various transport systems have been described in mitochondria (Figure 6.27), some of which have been thoroughly characterized. The primary function of these transport systems is to facilitate the selective movement of various substrates and intermediates back and forth across the inner mitochondrial membrane from the cytosol to the mitochondrial matrix. Through the action of these transporters, various substrates and other molecules can be accumulated in the mitochondrial matrix since the transporters can facilitate the movement of the substrate against a concentration gradient. The importance of a mitochondrial transporter derives from involvement of the substance transported in a variety of mitochondrial metabolic processes.

Substrate Shuttles Transport Reducing Equivalents across the Inner Mitochondrial Membrane

The various nucleotides involved in cellular oxidation-reduction reactions (e.g., NAD^+ , $NADH$, $NADP^+$, $NADPH$, FAD , and $FADH_2$) and CoA and its derivatives are not permeable to the inner mitochondrial membrane. Hence, for example, to transport reducing equivalents (e.g., protons and electrons) from cytosol to mitochondrial matrix or vice versa, "substrate shuttle mechanisms" involving the reciprocal transfer of reduced and oxidized members of various oxidation-reduction couples are used to accomplish the net transfer of reducing equivalents across the membrane. Two examples of how this transfer of reducing equivalents from the cytosol to the matrix occurs are shown in Figure 6.28. The **malate-aspartate shuttle** and the **α -glycerol phosphate shuttle** are

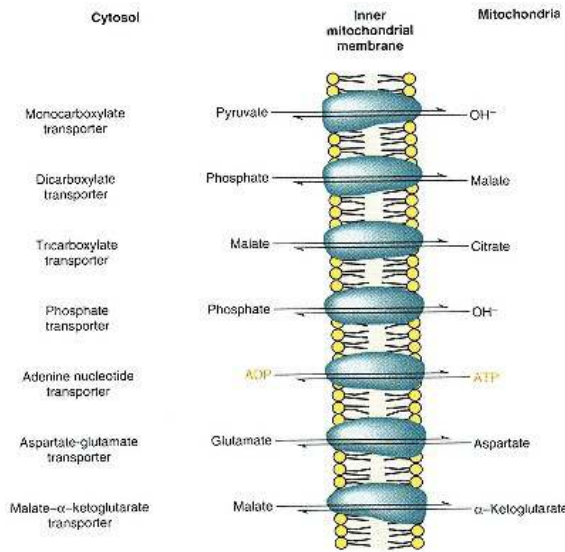

Figure 6.27
Mitochondrial metabolite transporters.

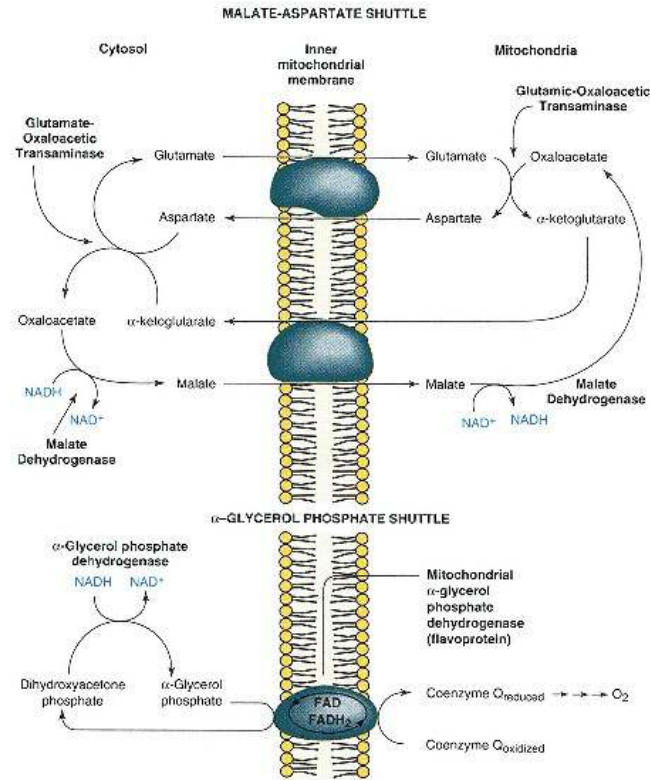

Figure 6.28
Transport shuttles for reducing equivalents.

employed in various tissues to translocate reducing equivalents from the cytosol to the mitochondrial matrix, where they are oxidized to yield energy. The operation of such substrate shuttles requires that the appropriate enzymes are localized on the correct side of the membrane and that appropriate transporters or translocases be present on/in the membrane. The operation of the malate–aspartate shuttle depends on the fact that NADH, NAD⁺, and oxaloacetate are not permeable to the inner mitochondrial membrane, on the distribution of malate dehydrogenase and aspartate aminotransferase on both sides of the inner mitochondrial membrane, and on the existence of membrane transporters that exchange intramitochondrial aspartate for cytosolic glutamate and cytosolic malate for intramitochondrial α -ketoglutarate.

Acetyl Units Are Transported by Citrate

Acetyl CoA is impermeable to the inner mitochondrial membrane but the acetyl group can be transferred from the mitochondrial compartment to the cytosol, where acetyl moieties are required for fatty acid or sterol biosynthesis (Figure 6.29).

Intramitochondrial acetyl CoA is converted to citrate by citrate synthase of the TCA cycle. Subsequently, the citrate is exported to the cytosol by a

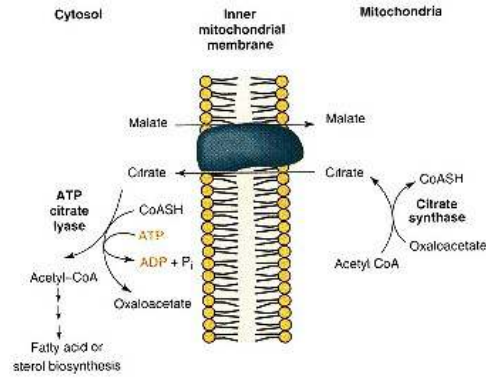

Figure 6.29

Export of intramitochondrially generated citrate to the cytosol to serve as a source of acetyl CoA for biosynthesis of fatty acids or sterols.

tricarboxylate transporter in exchange for a dicarboxylate such as malate. Cytosolic citrate is then cleaved to acetyl CoA and oxaloacetate at the expense of an ATP by ATP: citrate lyase (see p. 371). Substrate shuttle mechanisms in liver are involved in movement of appropriate substrates and intermediates in both directions across the inner mitochondrial membranes during periods of active **gluconeogenesis** (see p. 302) and **ureagenesis** (see p. 454).

Transport of Adenine Nucleotides and Phosphate

Adenine nucleotides are transported across the inner mitochondrial membrane by a very specific **adenine nucleotide translocator**. Nucleotide species such as the guanine, uridine, or cytosine nucleotides are neither exchanged across the inner membrane on the adenine nucleotide-specific translocator nor transported by a comparable carrier specific for nonadenine nucleotides. Cytosolic ADP, formed during energy-consuming reactions, is exchanged for mitochondrial ATP, generated in the process of oxidative phosphorylation (Figure 6.30). At pH 7 ADP has three negative charges and ATP has four, so that a 1:1 exchange of ADP:ATP would cause a charge imbalance across the membrane. Hence the ADP for ATP exchange across the mitochondrial membrane is an electrogenic process, requiring that the charge imbalance be compensated for by the movement of a proton or another charged species. The adenine nucleotide carrier was isolated due to its capacity to bind very tightly to atractyloside, a specific inhibitor of the carrier. It is a dimer with a subunit molecular weight of 30,000. It is unlikely that the rate of transport of adenine nucleotides across the mitochondrial membrane is ever limiting to the overall process of mitochondrial ATP synthesis. Low concentrations of long-chain fatty acyl CoA derivatives inhibit (i.e., $K_i = 1 \mu\text{M}$) the transport of ATP and ADP in isolated liver mitochondria. However, experimental results obtained under *in vivo* conditions in intact liver cells indicate that there occurs little, if any, inhibition of the adenine nucleotide transporter under metabolic conditions in which a large concentration of long-chain fatty acyl CoA accumulates.

A specific transporter transports cytosolic phosphate into the mitochondrial matrix for negatively charged hydroxyl ions in an electroneutral exchange (Figure 6.30). Also, phosphate transport may be accomplished in a proton-compensated mechanism; for example, phosphate and protons are transported in a 1:1 ratio. Phosphate transport is strongly inhibited by mersalyl and various mercurial reagents.

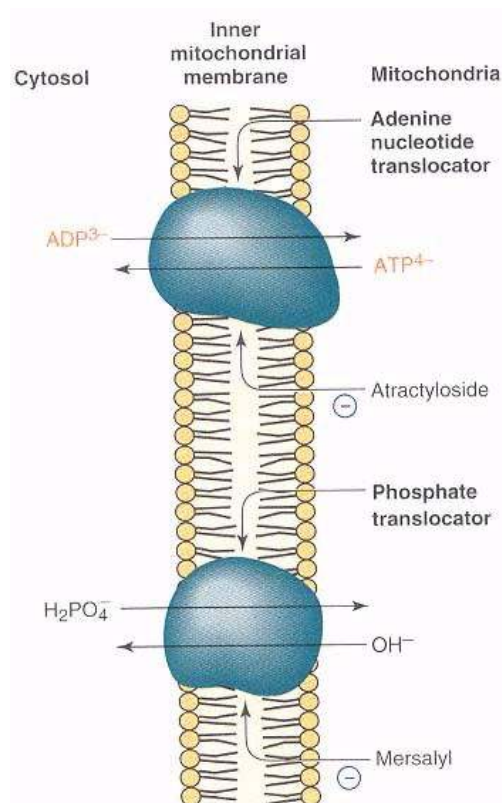

Figure 6.30

The adenine nucleotide and phosphate translocators.

Mitochondria Have a Specific Calcium Transport Mechanism

Mitochondria from most tissues possess a transport system for translocating Ca^{2+} across the mitochondrial inner membrane. It is difficult to overestimate the importance of the distribution/redistribution of cellular calcium pools in different cell functions, such as muscle contraction, neural transmission, secretion, and hormone action. Calcium exists in distinct pools in the cell. The cytosol, mitochondria, endoplasmic reticulum, nuclei, and Golgi complex have their own pools of calcium. Some of the intracellular calcium is bound to nucleotides, metabolites, or membrane ligands, while a portion of the intracellular calcium is free in solution. A gradient of Ca^{2+} exists from outside to inside a cell. Estimates of intracellular cytosolic calcium are in the range of 10^{-7} M, whereas extracellular calcium is at least four orders of magnitude greater. Total intramitochondrial calcium has been estimated to be $\sim 10^{-4}$ M but the free ionic calcium concentration in the mitochondrion is in the range of 10^{-7} M. Hence processes involved in the alternate sequestering and release of an intracellular store of calcium can greatly influence intracellular calcium pools and various cell functions. Mitochondria accumulate rather large quantities of calcium at the expense of ATP hydrolysis, respiration, or the electrochemical gradient created across the mitochondrial membrane. Mitochondrial calcium transport is inhibited by low concentrations of lanthanides (trivalent metal cations) and by ruthenium red. Mg^{2+} competes with Ca^{2+} for the carrier in certain types of mitochondria. The current view is that there is a specific carrier in the inner mitochondrial membrane, which is likely a glycoprotein (Figure 6.31). The mitochondrial calcium carrier exhibits saturation kinetics, has a high affinity for calcium, and is highly specific for calcium. Permeant counterions such as phosphate or acetate stimulate calcium transport and allow the cation to be retained in the matrix. The most probable utility of the ability of mitochondria to accumulate calcium occurs during cellular injury when extracellular calcium enters the cell. Mitochondria can sequester the calcium to minimize the change in the cytosolic calcium level. Certain hormones may affect intracellular calcium distribution (e.g., epinephrine or vasopressin) as part of the mechanism of the hormone response; it is unlikely that the mitochondrial calcium pool contributes to the hormone-sensitive pool of calcium.

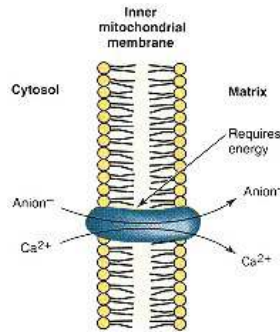

Figure 6.31
Mitochondrial calcium carrier.
 The energy requirement can be met from ATP, pH, or membrane potential.

In summary, the inner mitochondrial membrane possesses a variety of transport systems involved in the movement of nucleotides, substrates, metabolites, and metal cations into and out of the mitochondrial matrix. These transport functions are essential for the complex cellular metabolic pathways and their regulation (see Clin. Corr. 6.3).

6.6—

Electron Transfer

During the enzymatic reactions involved in glycolysis, fatty acid oxidation, and the TCA cycle, reducing equivalents are derived from the sequential breakdown of the initial metabolic fuel. In glycolysis, NADH is produced by glyceraldehyde-3-phosphate dehydrogenase and must be reoxidized in the cytosol (e.g., by lactate dehydrogenase as is the case in the red blood cell) or the reducing equivalents of NADH must be transported to the mitochondrial matrix via one of the substrate shuttles. The latter mechanism will yield the maximum energy from the metabolism of glucose. In fatty acid oxidation and the TCA cycle, reducing equivalents as both NADH and FADH_2 are produced in the mitochondrial matrix. To transduce this reducing power into utilizable energy, mitochondria have a system of electron carriers in or associated with the inner mitochondrial membrane, which in the presence of oxygen convert reducing equivalents into utilizable energy. This process is called **electron transport**. As will be seen, NADH and FADH_2 oxidation in this process results in production of

3 and 2 mol of ATP per mole of reducing equivalent transferred to oxygen, respectively.

Oxidation–Reduction Reactions

Prior to the presentation of a description of the many components and the mechanism of the electron transport sequence, it is important to discuss some basic information concerning oxidation–reduction reactions. The mitochondrial electron transport system is little more than a sequence of linked oxidation–reduction reactions, for example,

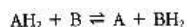

Oxidation–reduction reactions occur when there is a transfer of electrons from a suitable electron donor (the reductant) to a suitable electron acceptor (the oxidant). In some oxidation–reduction reactions only electrons are transferred from the reductant to the oxidant (i.e., electron transfer between cytochromes),

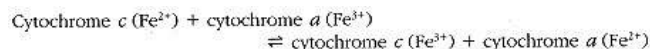

whereas in other types of reactions, both electrons and protons (hydrogen atoms) are transferred (e.g., electron transfer between NADH and FAD).

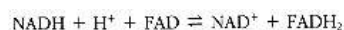

Oxidized and reduced forms of compounds or groups operating in oxidation–reduction reactions are referred to as **redox couples** or pairs. The facility with which a given electron donor (reductant) gives up its electrons to an electron acceptor (oxidant) is expressed quantitatively as the oxidation–reduction potential of the system. An **oxidation–reduction potential** is measured in volts as an **electromotive force** (emf) of a half-cell made up of both members of an oxidation–reduction couple when compared to a standard reference half-cell (usually the hydrogen electrode reaction). The potential of the standard hydrogen electrode is set by convention at 0.0 V at pH 0.0. However, when this standard potential is corrected for pH 7.0 the reference electrode potential becomes -0.42 V. The oxidation–reduction potentials for a variety of important biochemical reactions are tabulated in Table 6.6. The reductant of an oxidation–reduction pair with large negative potential will give up its electrons more readily than pairs with smaller negative or positive redox potentials. On the

CLINICAL CORRELATION 6.3

Mitochondrial Myopathies

Diseases that involve defects in various metabolic functions of muscle have been described. Clinically, patients with myopathy complain of weakness and cramping of the affected muscles; infants have difficulty feeding and crawling; severe fatigue results from minimal exertion; and there is usually evidence of muscle wasting. On the basis of electron microscopic examination and enzymatic characterization of muscle biopsy material, many myopathies have been found that have a primary lesion in mitochondrial function.

Deficiencies in mitochondrial transport functions (i.e., carnitine: palmitoyl-CoA transferase) and in components of the mitochondrial electron transport chain (NADH dehydrogenase, cytochrome *b*, cytochrome *a*, *a*₃, or the mitochondrial F₁F₀-ATPase) have been described. In many mitochondrial myopathies large paracrystalline inclusions occur within the mitochondrial matrix (see figure). It is not known whether this crystalline material is inorganic or organic in composition. In certain mitochondrial myopathies electron transport is only loosely coupled to ATP production; in other cases these processes exhibit normal tight coupling. Because some of these disorders involve defects in enzymes encoded by mitochondrial genes, they have the unique pattern of inheritance from the mother, since all mitochondria are derived from mitochondria in the ovum.

Petty, R. K. H., Harding, A. E., and Morgan-Hughes, J. A. The clinical features of mitochondrial myopathy. *Brain* 109:915, 1986; and Shoffner, J. M., and Wallace, D. C. Oxidative phosphorylation diseases and mitochondrial mutations: diagnosis and treatment. *Annu. Rev. Nutr.* 14:535,1994.

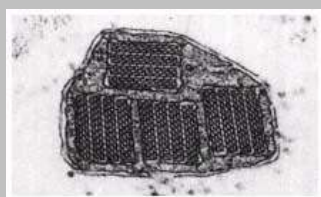

Example of paracrystalline inclusions in mitochondria from muscles of ocular myopathic patients ($\times 36,000$). Courtesy of Dr. D. N. Landon, Institute of Neurology, University of London.

TABLE 6.6 Standard Oxidation–Reduction Potentials for Various Biochemical Reactions

Oxidation–Reduction System	Standard Oxidation–Reduction Potential E_0' (V)
Acetate + 2H ⁺ + 2e ⁻ \rightleftharpoons acetaldehyde	-0.60
2H ⁺ + 2e ⁻ \rightleftharpoons H ₂	-0.42
Acetoacetate + 2H ⁺ + 2e ⁻ \rightleftharpoons β -hydroxybutyrate	-0.35
NAD ⁺ + 2H ⁺ + 2e ⁻ \rightleftharpoons NADH + H ⁺	-0.32
Acetaldehyde + 2H ⁺ + 2e ⁻ \rightleftharpoons ethanol	-0.20
Pyruvate + 2H ⁺ + 2e ⁻ \rightleftharpoons lactate	-0.19
Oxaloacetate + 2H ⁺ + 2e ⁻ \rightleftharpoons malate	-0.17
Coenzyme Q _{ox} + 2e ⁻ \rightleftharpoons coenzyme Q _{red}	+0.10
Cytochrome <i>b</i> (Fe ³⁺) + e ⁻ \rightleftharpoons cytochrome <i>b</i> (Fe ²⁺)	+0.12
Cytochrome <i>c</i> (Fe ³⁺) + e ⁻ \rightleftharpoons cytochrome <i>c</i> (Fe ²⁺)	+0.22
Cytochrome <i>a</i> (Fe ³⁺) + e ⁻ \rightleftharpoons cytochrome <i>a</i> (Fe ²⁺)	+0.29
$\frac{1}{2}$ O ₂ + 2H ⁺ + 2e ⁻ \rightleftharpoons H ₂ O	+0.82

other hand, a strong oxidant (e.g., characterized by a large positive potential) has a very high affinity for electrons.

The **Nernst equation** characterizes the relationship between the standard oxidation–reduction potential of a particular redox pair (E'_0), the observed potential (E), and the ratio of the concentrations of oxidant and reductant in the system:

$$E = E'_0 + \frac{2.3 RT}{nF} \log \left(\frac{[\text{oxidant}]}{[\text{reductant}]} \right)$$

E is the observed potential with all concentrations at 1 M. E'_0 is the standard potential at pH 7.0. R is the gas constant of $8.3 \text{ J deg}^{-1} \text{ mol}^{-1}$. T is the absolute temperature in kelvin units (K). n is the number of electrons being transferred. F is the Faraday constant of $96,500 \text{ J V}^{-1}$.

When an observed potential is equal to the standard potential, a potential is defined that is referred to as the midpoint potential. At the midpoint potential the concentration of oxidant is equal to that of reductant. Knowing standard oxidation–reduction potentials of a diverse variety of biochemical reactions allows one to predict the direction of electron flow or transfer when more than one redox pair is linked together by the appropriate enzyme that causes a reaction to occur. For example, as shown in Table 6.6 the NAD^+ – NADH pair has a standard potential of -0.32 V , and the pyruvate–lactate pair possesses a potential of -0.19 . This means that electrons will flow from the NAD^+ – NADH system to the pyruvate–lactate system as long as the enzyme (lactate dehydrogenase) is present; for example,

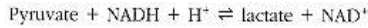

Hence in the mitochondrial electron-transfer system electrons or reducing equivalents are produced in NAD^+ - and FAD -linked dehydrogenase reactions, which have standard potentials at or close to that of NAD^+ – NADH and are passed through the electron-transfer chain, which has as its terminal acceptor the oxygen–water couple.

Free-Energy Changes in Redox Reactions

Oxidation–reduction potential differences between two redox pairs are similar to free-energy changes in chemical reactions, in that both quantities depend on the concentration of reactants and products of the reaction and the following relationship exists:

$$\Delta G^{\circ'} = -nF \Delta E'_0$$

Using this expression, the free-energy change for electron-transfer reactions can be calculated if the potential difference between two oxidation–reduction pairs is known. Hence, for the mitochondrial electron-transfer process in which electrons are transferred between the NAD^+ – NADH couple ($E'_0 = +0.82 \text{ V}$), the free-energy change for this process can be calculated:

$$\Delta G^{\circ} = -nF \Delta E'_0 = -2 \times 23,062 \times 1.14 \text{ V}$$

$$\Delta G^{\circ} = -52.6 \text{ kcal mol}^{-1}$$

where 23.062 is the Faraday constant in kcal V^{-1} and n is the number of electrons transferred; for example, in the case of $\text{NADH} \rightarrow \text{O}_2$, $n = 2$. The free energy available from the potential span between NADH and oxygen in the electron-transfer chain is capable of generating more than enough energy to synthesize three molecules of ATP per two reducing equivalents or two electrons trans-

ported to oxygen. In addition, because of the negative sign of the free energy available in the mitochondrial electron transfer, this process is exergonic and will proceed provided that the necessary enzymes are present.

Mitochondrial Electron Transport Is a Multicomponent System

Before defining the mechanistic details of the mitochondrial electron transport chain it is necessary to describe the various components that participate in the transfer of electrons in this system. The major enzymes or proteins functioning as electron-transfer components involved in the mitochondrial electron-transfer system are as follows: (1) NAD⁺-linked dehydrogenases, (2) flavin-linked dehydrogenases, (3) iron-sulfur proteins, and (4) **cytochromes**.

NAD-Linked Dehydrogenases

The initial stage in the mitochondrial electron transport sequence consists of the generation of reducing equivalents in the TCA cycle, the fatty acid β -oxidation sequence, and various other dehydrogenase reactions. The NAD-linked dehydrogenase reactions of these pathways reduce NAD⁺ to NADH while converting the reduced member of an oxidation-reduction couple to the oxidized form; for example, for the isocitrate dehydrogenase reaction,

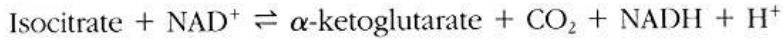

Two nicotinamide nucleotides are involved in various metabolic reactions, NAD and NADP (Figure 6.32). Nicotinamide adenine dinucleotide phosphate has a phosphate esterified to the 2 position of the ribose in the adenosine portion of

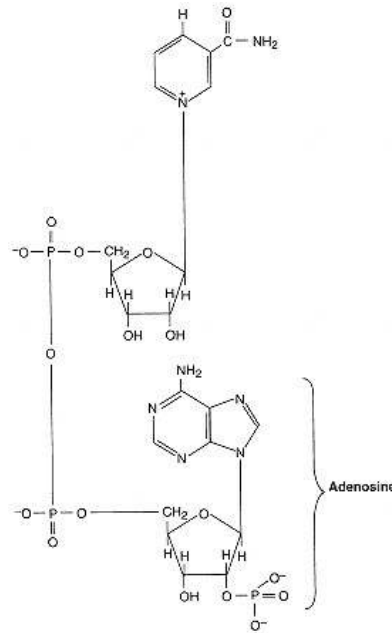
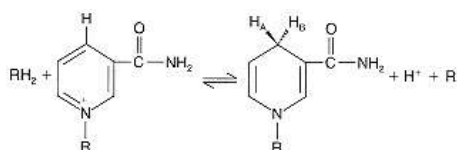

Figure 6.32
Structure of nicotinamide adenine dinucleotide phosphate: NADP.

TABLE 6.7 The Stereospecificity of NAD(P)- Linked Dehydrogenases

<i>NAD(P)-Linked Dehydrogenase</i>	<i>Specificity</i>
Alcohol dehydrogenase	A
Malate dehydrogenase	A
Lactate dehydrogenase	A
Isocitrate dehydrogenase (NADP ⁺)	A
Hydroxyacyl-CoA dehydrogenase	B
Glyceraldehyde-3-phosphate dehydrogenase	B
Glucose-6-phosphate dehydrogenase (NADP ⁺)	B

the dinucleotide. Each NAD(P)-linked dehydrogenase catalyzes a stereospecific transfer of the reducing equivalent from the substrate to the nucleotide (see p. 143).



NAD(P)-linked dehydrogenases are either A specific or B specific. Table 6.7 lists examples of the stereospecificity of NAD(P)-linked dehydrogenases. Once formed, NAD(P)H is released from the dehydrogenase and serves as the substrate for the mitochondrial electron transport system. NADPH is not a substrate for the mitochondrial respiratory chain but is used in reductive biosynthetic reactions of such processes as fatty acid and sterol synthesis. When NAD(P)⁺ is converted to NAD(P)H, there is a characteristic change in the absorbance and fluorescence properties of these nucleotides, which occurs as a result of the reduction of NAD(P)⁺. The reduced form of the nicotinamide coenzyme has an absorbance maximum at 340 nm (Figure 6.33) not present in the oxidized NAD(P)⁺ form. Furthermore, when the reduced form of the nicotinamide coenzyme is excited by light at 340 nm a fluorescence emission maximum is seen at 465 nm. These absorbance and fluorescence properties of the nicotinamide coenzymes have been employed extensively in developing assays for dehydrogenase reactions (see p. 168) and have been utilized to monitor the oxidation-reduction state of a tissue or a preparation of intact mitochondria. With an appropriate spectrophotometer (e.g., dual wavelength), capable of measuring small absorbance changes in turbid cell or mitochondrial suspensions, the relative changes in the oxidized-reduced nicotinamide coenzymes may be determined as a function of the metabolic condition of the cell or subcellular suspension (e.g., changes in substrate, oxygen concentration, or upon drug or hormone addition). This type of spectrophotometric technique and more sophisticated techniques—in which a light guide is used to direct a beam of excitation light to the surface of an intact organ or tissue, and another light guide is employed to observe the reflected fluorescence emission at a longer wavelength—have been valuable tools in understanding the very complicated relationships that exist between the mitochondrial respiratory chain and the metabolic characteristics of various tissues.

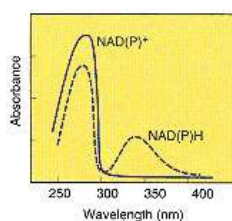
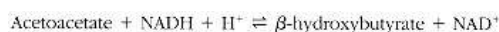

Figure 6.33
Absorbance properties of
NAD⁺ and NADH.

Another effective method for monitoring the oxidation–reduction state of the cytosolic or mitochondrial compartments is to measure the oxidized and reduced members of various redox couples in tissue extracts, in the bathing solution of a tissue, or in the effluent perfusate of an isolated, perfused organ. Because lactate dehydrogenase is exclusively a cytosolic enzyme the pyruvate/lactate ratio in the tissue or organ perfusate should accurately reflect the cytosolic NAD⁺/NADH ratio under a variety of metabolic conditions. Similarly, the **β -hydroxybutyrate dehydrogenase** is exclusively mitochondrial, and hence the ratio of acetoacetate/ β -hydroxybutyrate should reflect the oxidation–reduction state of the mitochondrial NAD⁺–NADH system. If the ratio of acetoacetate/ β -hydroxybutyrate and the equilibrium constant for β -hydroxybutyrate dehydrogenase are known, the NAD⁺/NADH ratio under any condition can be calculated:



$$K_{\text{eq}} = \frac{[\beta\text{-hydroxybutyrate}][\text{NAD}^+]}{[\text{acetoacetate}][\text{NADH}][\text{H}^+]}$$

Flavin-Linked Dehydrogenases

The second type of oxidation–reduction reaction essential in mitochondrial electron transport employs a **flavin** (e.g., derived from riboflavin) as electron acceptor as part of flavin-linked dehydrogenases. The two flavins commonly utilized in oxidation–reduction reactions are FAD (flavin adenine dinucleotide) and FMN (flavin mononucleotide) (Figure 6.34).

Five flavin-containing enzymes play an essential role in energy metabolism in mammalian mitochondria (Table 6.8). In the pyruvate and α -ketoglutarate dehydrogenase multienzyme complexes, the final reaction catalyzed involves the flavoprotein enzyme, dihydrolipoyl dehydrogenase, in which the bound FAD moiety accepts electrons from reduced lipoamide on the transacylase subunit and then transfers the reducing equivalents to NAD^+ . Also, in the TCA cycle, succinate dehydrogenase is a flavin-linked protein, which oxidizes succinate to fumarate and converts FAD to FADH_2 . The first dehydrogenation reaction in β -oxidation of fatty acids is catalyzed by the acyl-CoA dehydrogenase, another flavin-linked enzyme. Finally, oxidation of NADH in the mitochondrial respiratory chain is catalyzed by a FMN-containing enzyme, NADH dehydrogenase, and the reducing equivalents are transferred to another flavoprotein called the electron-transferring flavoprotein.

The flavins FAD and FMN either may be bound very tightly noncovalently (i.e., with dissociation constants in the range of 10^{-10} M) to their respective enzymes, as is the case for NADH dehydrogenase, or may be bound covalently to the protein (e.g., to a histidine residue), as is the case with succinate dehydrogenase. Flavoproteins are classified into two groups: (1) dehydrogenases in which the reduced flavin is reoxidized by electron carriers other than oxygen (e.g., coenzyme Q and other flavins, or *in vitro* with chemical agents such as ferricyanide, methylene blue, or phenazine methosulfate) and (2) oxidases in which the flavin may be reoxidized using molecular oxygen, O_2 , as the electron acceptor, and yielding H_2O_2 as the product. The H_2O_2 may then be broken down to water and oxygen by the enzyme **catalase**,

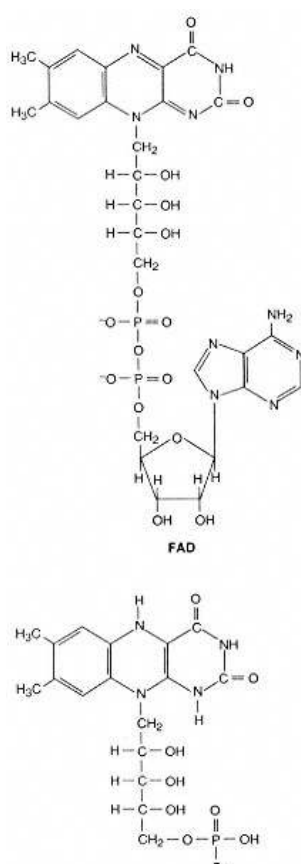
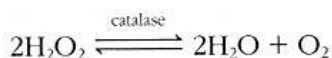

Figure 6.34
Structures of
flavin adenine dinucleotide
(FAD) and flavin
mononucleotide (FMN).

Iron-Sulfur Centers

A number of flavin-linked enzymes contain nonheme iron (i.e., an iron-sulfur center; see p. 1004) involved in the catalytic mechanism. In these enzymes iron is converted from the oxidized (Fe^{3+}) to reduced (Fe^{2+}) form during the transfer of reducing equivalents on and off the flavin moiety. Both succinate dehydroge-

TABLE 6.8 Various Flavin-Linked Dehydrogenases

Enzyme	Function	Flavin Nucleotide
Succinate dehydrogenase	Tricarboxylic acid cycle	FAD
Dihydrolipoyl dehydrogenase	Component in pyruvate and α -ketoglutarate dehydrogenase complexes	FAD
NADH dehydrogenase	Electron transport chain	FMN
Electron-transferring flavoprotein	Electron transport chain	FAD
Acyl-CoA dehydrogenase	Fatty acid β -oxidation	FAD
D-Amino acid oxidase	Amino acid oxidation	FAD
Monoamine oxidase	Oxidation of monoamines	FAD

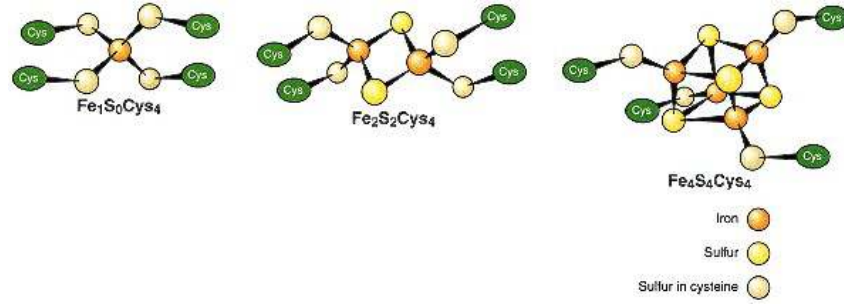

Figure 6.35

The structures of iron–sulfur centers.

White, sulfur; gray, sulfur in cysteine; and black, iron.

nase and NADH dehydrogenase contain iron–sulfur centers. The iron component of the iron–sulfur center is bound in various arrangements to cysteine residues in the protein and to acid-labile sulfur, for example, $\text{Fe}_4\text{S}_4\text{Cys}_4$, $\text{Fe}_2\text{S}_2\text{Cys}_4$, and $\text{Fe}_1\text{S}_0\text{Cys}_4$ (Figure 6.35). Iron-sulfur proteins are found in abundance in all species from the simplest microorganism to mammals. Certain flavin-linked enzymes (e.g., xanthine oxidase) contain one or two molybdenum atoms associated with their catalytic mechanism. The tightly bound molybdenum undergoes a valence change during transfer of electrons: $\text{Mo}^{6+} \rightarrow \text{Mo}^{5+}$.

Cytochromes

Organisms that require oxygen (i.e., aerobic organisms) in their energy-generating functions possess various cytochromes that are involved in electron-transfer systems. Cytochromes are a class of proteins characterized by the presence of an iron-containing heme group bound to the protein. Unlike the heme group in hemoglobin or myoglobin in which the heme iron remains in the Fe^{2+} state,

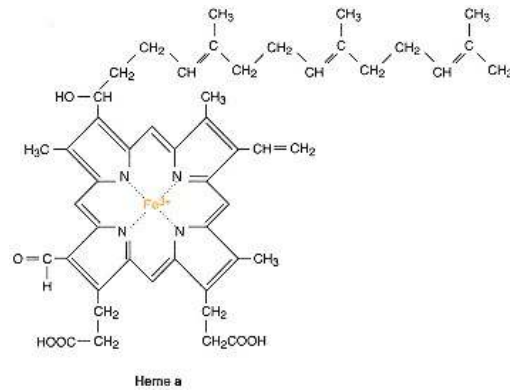

Figure 6.36

Structures of heme a and heme c.

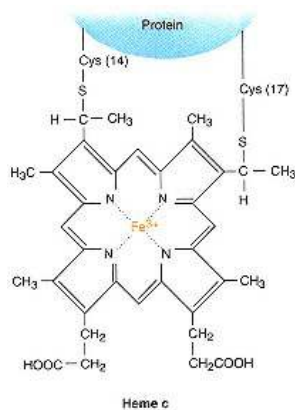

Figure 6.36
Continued.

the iron in the heme of a cytochrome is alternately oxidized (Fe^{3+}) or reduced (Fe^{2+}) as it functions in the electron transport chain.

Cytochromes of mammalian mitochondria are designated as *a*, *b*, and *c* on the basis of the α band of their absorption spectrum and the type of heme group (Figure 6.36). Cytochrome *c* is a small protein (104 amino acid residues) with mol wt = 13,000. Amino acid sequences of cytochrome *c* from a great many species have been described and show that 20 out of 104 amino acid residues are invariant. The iron of the heme group in cytochrome *c* is coordinated between the four nitrogen atoms of the tetrapyrrole structure of the porphyrin group, whereas the fifth and sixth coordination positions are occupied by the methionine residue at position 80 and the histidine residue at position 18 of the protein (Figure 6.37). Since all six coordination positions are filled in most of the cytochromes, binding of oxygen directly to the iron is prevented as is binding of respiratory inhibitors such as cyanide, azide, and carbon monoxide. The notable exception is cytochrome *a₃*, which is involved in the terminal step in mitochondrial electron transport. The heme group in cytochrome *c* is attached to the protein, not only by the fifth and sixth coordination positions of the heme iron, but also by the vinyl side chains of the protoporphyrin IX structure, from which hemes in cytochromes *a* and *c* are derived. These vinyl side chains are reduced by the addition of reduced sulfhydryls from cysteine residues at positions 14 and 17 in cytochrome *c* apoprotein. Hence the heme is covalently linked to the protein as well as being coordinated through the Fe^{2+} group in the heme. The three-dimensional structure of cytochrome *c* is shown in Figure 6.38.

Coenzyme Q

Coenzyme Q, also called **ubiquinone**, is neither a nucleotide nor a protein but a lipophilic electron carrier. Like the nicotinamide coenzymes and to a certain extent cytochrome *c*, coenzyme Q serves as a "mobile" electron transport component that operates between the various flavin-linked dehydrogenases (e.g., NADH dehydrogenase, succinate dehydrogenase, and fatty acyl-CoA dehydrogenase) and cytochrome *b* of the electron transport chain. The quinone portion of the coenzyme Q molecule is alternately oxidized and reduced by

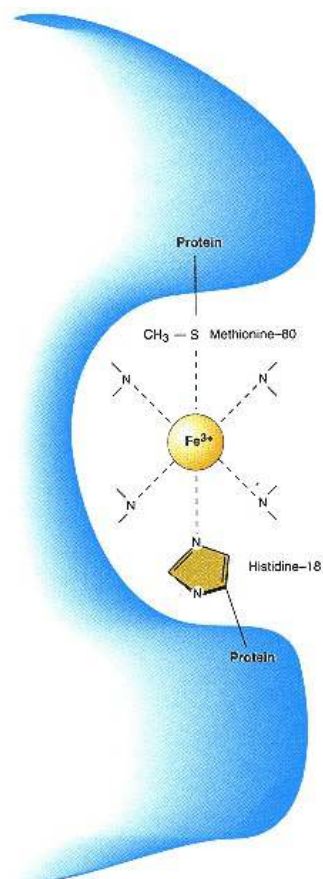

Figure 6.37
The six coordination positions of cytochrome *c*.

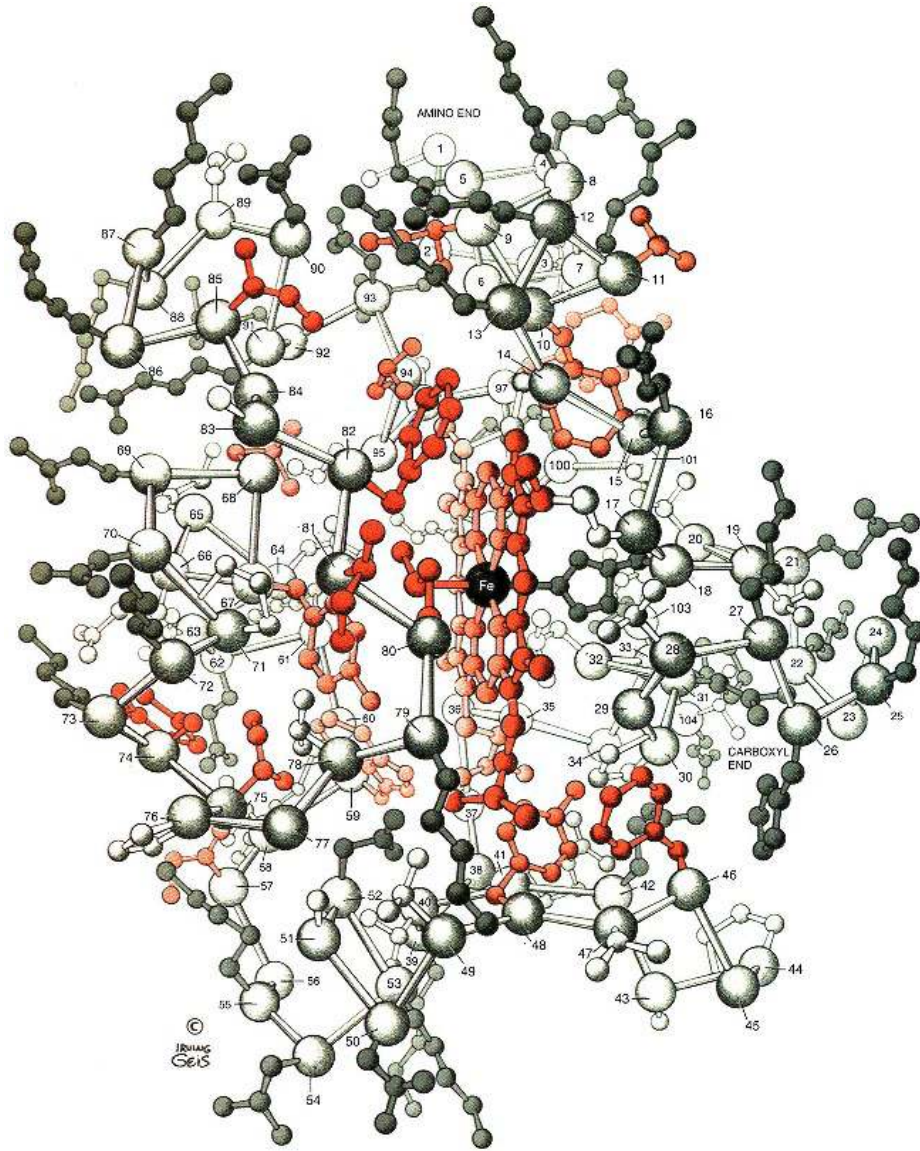

Figure 6.38
The three-dimensional structure of cytochrome c.
Copyright © 1992 Irving Geis.

the addition of two reducing equivalents, that is 2H^+ , and 2e^- (Figure 6.39). The number (n) of isoprene units in the side chain varies between 6 and 10, depending on the source of the coenzyme Q. The side chain renders the coenzyme Q lipid soluble and facilitates the accessibility of this electron carrier to the lipophilic portions of the inner mitochondrial membrane.

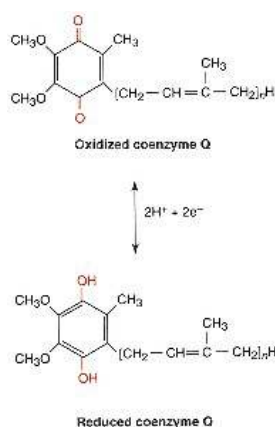

Figure 6.39
Oxidation–reduction of coenzyme Q.

The Mitochondrial Electron Transport Chain Is Located in the Inner Membrane in a Specific Sequence

The various electron-transferring proteins and other electron carriers that comprise the mitochondrial electron-transfer chain are arranged in a sequential pattern in the inner mitochondrial membrane. Reducing equivalents are extracted from substrates in the TCA cycle, the fatty acid β -oxidation sequence, and indirectly from glycolysis and passed sequentially through the electron transport chain to molecular oxygen. The arrangement of carriers is illustrated in Figure 6.40. Electrons or reducing equivalents are fed into the electron transport chain at the level of NADH or coenzyme Q from the primary NAD^+ - and FAD-linked dehydrogenase reactions and are transported to molecular oxygen through the cytochrome chain. This electron transport system is constructed so that the reduced member of one redox couple is oxidized by the oxidized member of the next component in the system:



or

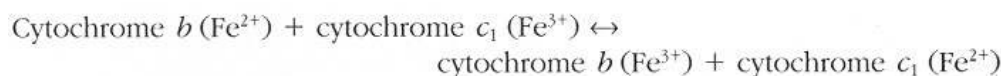

Note that electron transfer from NADH through coenzyme Q involves 2e^- , whereas the reactions between coenzyme Q and oxygen involving the various cytochromes are 1e^- transfer reactions.

The components of the respiratory chain have characteristic absorption spectra that can be determined in suspensions of isolated mitochondria or submitochondrial particles using a dual-beam spectrophotometer. The different absorption bands are shown in Figure 6.41. One of the light beams of the spectrophotometer was passed through a suspension of liver mitochondria, which was maintained under fully reduced conditions (e.g., substrate plus no oxygen), and the other beam was passed through an identical suspension in the presence of oxygen. The resulting spectrum is a difference spectrum of the reduced minus the oxidized states of the mitochondrial respiratory chain.

During transfer of electrons from the NADH-NAD^+ couple ($E_0' = +0.82$) there occurs an oxidation-reduction potential decrease of 1.14 V. This drop in potential occurs in discrete steps as reducing equivalents or electrons are passed between the different segments of the chain (Figure 6.42). There is at least a 0.3-V decrease in potential between each of the three coupling or phosphorylation sites. A potential drop of 0.3 V is more than sufficient to accommodate synthesis of a high-energy phosphate bond of ATP. For example,

$$\Delta E_0' = 0.3\text{ V}$$

$$\Delta G^\circ = -nF\Delta E_0'$$

$$\Delta G^\circ = -2 \times 23,062 \times 0.3$$

$$\Delta G^\circ = -13.8\text{ kcal mol}^{-1}$$

Various components of the electron transport chain are located asymmetrically in the mitochondrial membrane. **Cytochrome-c oxidase**, which catalyzes the

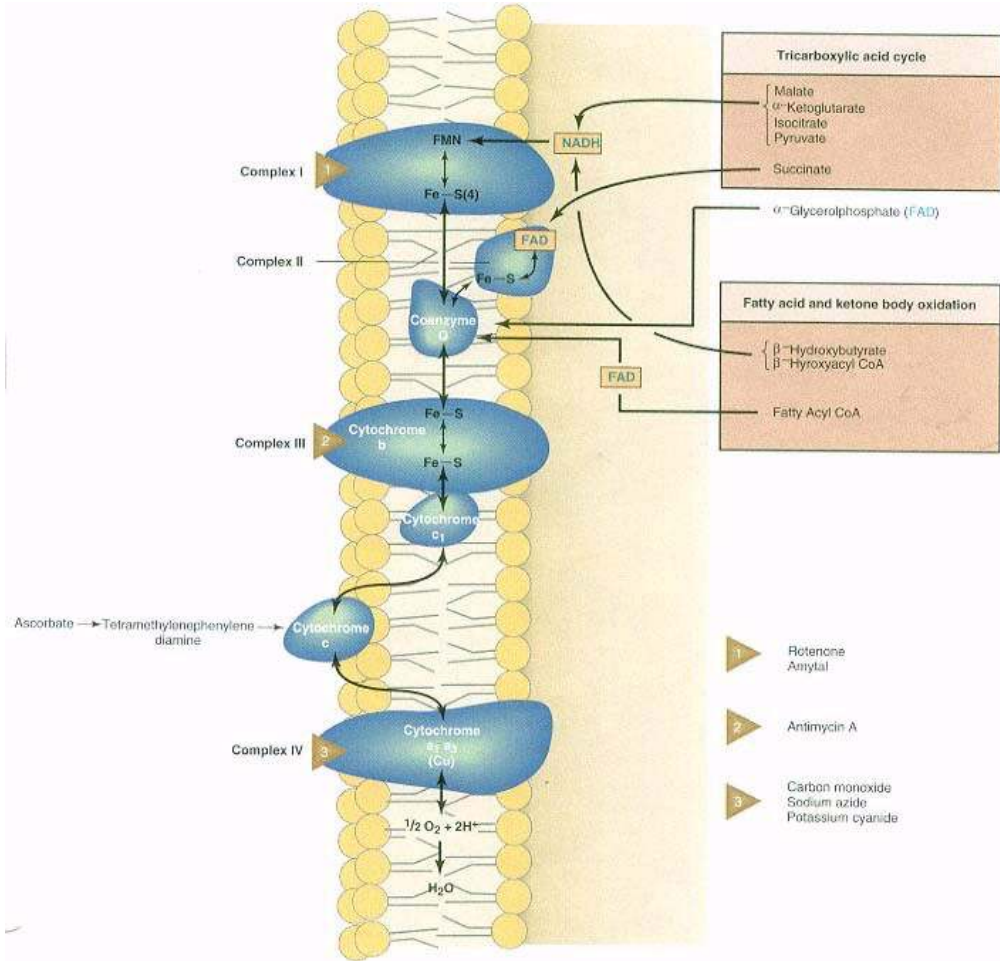

Figure 6.40
Mitochondrial electron transport chain.

terminal step in the electron-transfer chain, spans the membrane between the matrix and the intermembrane space (Figure 6.43). This protein is a dimeric complex of 13 polypeptides that contains heme a, heme a₃, and three copper atoms. Cytochrome c binds to the oxidase from the cytosolic side of the membrane, whereas oxygen binds from the matrix side of the membrane during the electron-transferring event.

Figure 6.44 depicts the organization of the entire electron transport sequence in the inner mitochondrial membrane. The initial reaction is catalyzed by the NADH dehydrogenase complex, designated **Complex I**, which accepts

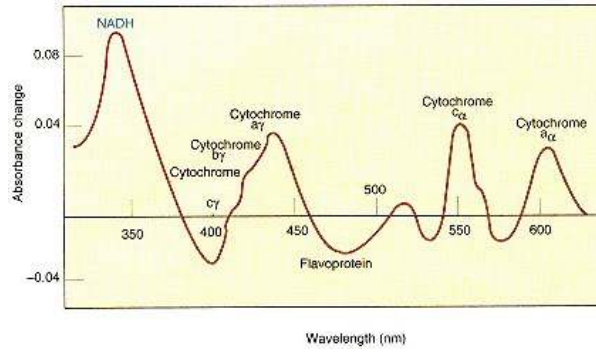

Figure 6.41
Difference spectrum of liver mitochondrial suspension (oxidized – reduced).

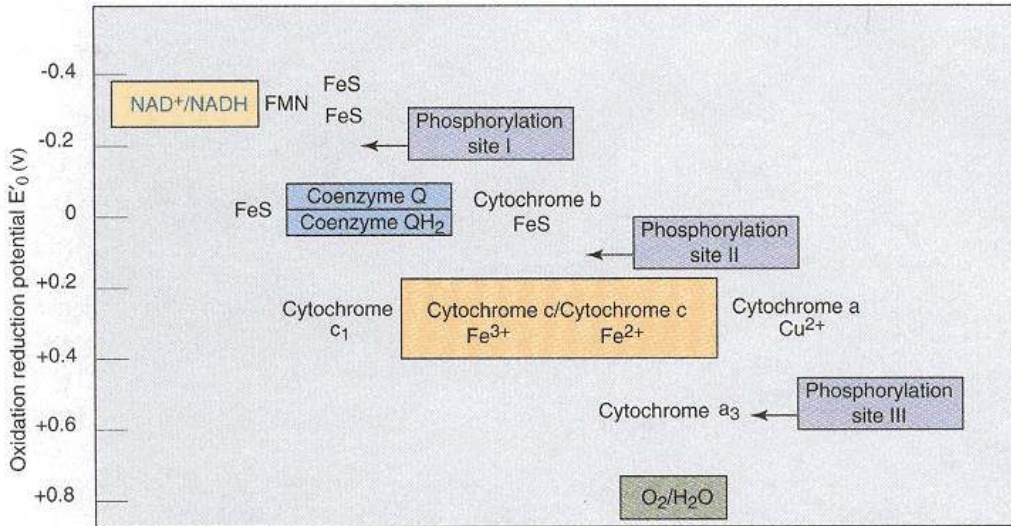

Figure 6.42
Oxidation–reduction potentials of the mitochondrial electron transport chain carriers.

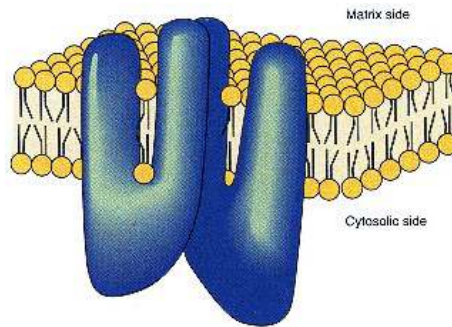

Figure 6.43
Model of cytochrome-c oxidase dimer in the mitochondrial inner membrane.

Redrawn with permission
from Frey, T. G., Costello, M. J., Karlsson, B., Haselgrove, J.C., and Leigh, J.S. *J. Mol. Biol.* 162:113, 1982.

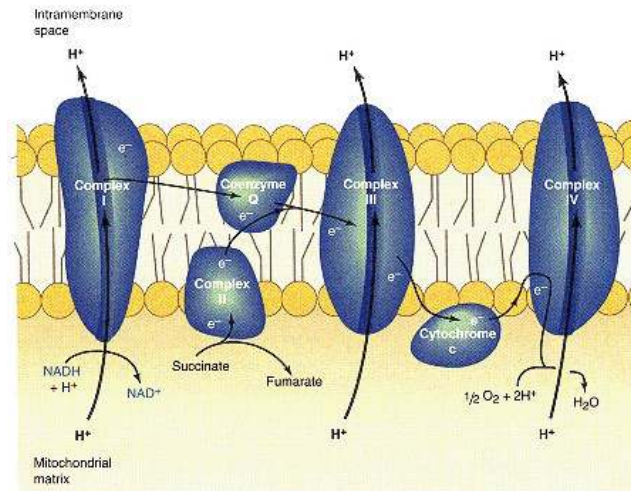

Figure 6.44
The four electron transport complexes of the mitochondrial electron transport sequence.

protons and electrons from $\text{NADH} + \text{H}^+$ and transfers them to coenzyme Q. **Complex II** consists of the succinate dehydrogenase flavoprotein component, which accepts reducing equivalents from succinate, again for passage to coenzyme Q. Being a highly lipophilic molecule, coenzyme Q is quite mobile in the mitochondrial membrane, which facilitates its ability to transfer electrons from both Complex I and Complex II to the cytochrome bc_1 complex (**Complex III**). Cytochrome c then accepts electrons from Complex III for transport to cytochrome oxidase (**Complex IV**) where molecular oxygen is the terminal electron acceptor. Protons (e.g., H^+) are ejected from the mitochondrial matrix into the intramembrane space at three points in this sequence of reactions (Figure 6.44). As described below, these protons will be translocated back into the matrix by the F_1F_0 -ATPase present in the mitochondrial inner membrane as part of the oxidative phosphorylation phase of this energy-transducing system. Clinical Correlation 6.4 describes clinical conditions in which there are genetic dysfunctions of some of the Complexes.

CLINICAL CORRELATION 6.4

Subacute Necrotizing Encephalomyelopathy

This condition is also called Leigh disease. It manifests in infants and young children as severe lactic acidosis and neurological abnormalities. It is characterized by symmetrical lesions in basal ganglia, brain stem, and spinal cord that are detectable by computerized tomography (CT) scanning. The condition is frequently fatal. Dysfunction in oxidative phosphorylation especially in Complex IV (cytochrome- c oxidase) is common. Dysfunction in Complex I (NADH dehydrogenase), Complex II (succinate dehydrogenase), F_1F_0 -ATPase, or pyruvate dehydrogenase complex can also produce the same clinical picture. It is clear that the condition is genetically heterogeneous and can arise from a variety of mutations either in nuclear genes that code for proteins of the mitochondrial matrix or inner membrane, or in mitochondrial genes. Leigh disease may occur without a family history of a similar disease or be transmitted as an autosomal recessive defect when the mutation is in a nuclear gene or by maternal inheritance when the mutation is in a mitochondrial gene.

Shoffner, J. M., and Wallace, D. C. In: C. R. Scriver, A. L. Beaudet, W. S. Sly, and D. Valle (Eds.), *The Metabolic and Molecular Bases of Inherited Disease*, 7th ed. New York: McGraw-Hill, 1995, p. 1535.

Electron Transport Can Be Inhibited at Specific Sites

The illustration of the mitochondrial respiratory chain shown in Figure 6.40 indicates that a number of compounds specifically inhibit electron transfer at different points. The fish poison **rotenone** and the barbiturate **amytal** (Figure 6.45) inhibit at the level of the flavoprotein, NADH dehydrogenase. Hence electrons or reducing equivalents derived from NAD^+ -linked dehydrogenases are not oxidized by the respiratory chain in the presence of rotenone, whereas those derived from flavin-linked dehydrogenases are freely oxidized. The antibiotic **antimycin A** (Figure 6.45) inhibits electron transfer at the level of cytochrome *b*, whereas the terminal step in the respiratory chain catalyzed by cytochrome oxidase is inhibited by cyanide, azide, or carbon monoxide (see Clin. Corr. 6.5). Cyanide and azide combine with the oxidized heme iron (Fe^{3+}) in cytochromes *a* and *a₃*, and prevent the reduction of heme iron by electrons derived from reduced cytochrome *c*. Carbon monoxide binds to the reduced iron (Fe^{2+}) of cytochrome oxidase. Hence inhibition of mitochondrial electron transport results in an impairment of normal energy-generating function and death of the organism.

CLINICAL CORRELATION 6.5

Cyanide Poisoning

Inhalation of hydrogen cyanide gas or ingestion of potassium cyanide causes a rapid and extensive inhibition of the mitochondrial electron transport chain at the cytochrome oxidase step. Cyanide is one of the most potent and rapidly acting poisons known. Cyanide binds to the Fe^{3+} in the heme of the cytochrome *a, a₃* component of the terminal step in the electron transport chain and prevents oxygen from reacting with cytochrome *a, a₃* and serving as the final electron acceptor. Mitochondrial respiration and energy production cease, and cell death occurs rapidly. Death due to cyanide poisoning occurs from tissue asphyxia, most notably of the central nervous system. If cyanide poisoning is diagnosed very rapidly, a patient who has been exposed to cyanide is given various nitrites that convert oxyhemoglobin to methemoglobin, which merely involves converting the Fe^{2+} of hemoglobin to Fe^{3+} in methemoglobin. Methemoglobin (Fe^{3+}) competes with cytochrome *a, a₃* (Fe^{3+}) for cyanide, forming a methemoglobin–cyanide complex. Administration of thiosulfate causes the cyanide to react with the enzyme rhodanese, forming the nontoxic compound thiocyanate.

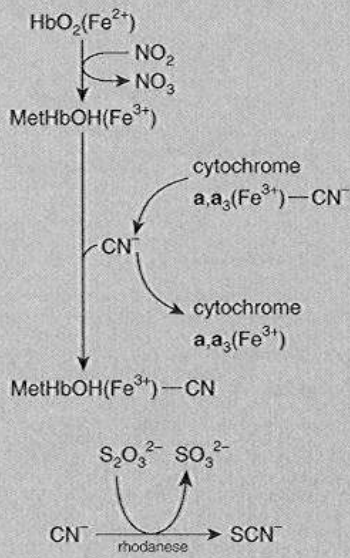

Holland, M. A., and Kozlowski, L. M. Clinical features and management of cyanide poisoning. *Clin. Pharmacol.* 5:737, 1986.

Electron Transport Is Reversible

The various events in the mitochondrial electron transport system and the closely coupled reactions of oxidative phosphorylation are reversible, provided an appropriate amount of energy is supplied to drive the system. In mitochondrial systems, reducing equivalents derived from succinate can be transferred to NADH with the concomitant hydrolysis of ATP (Figure 6.46). Electron transport across the other two phosphorylation sites can be reversed in a similar fashion.

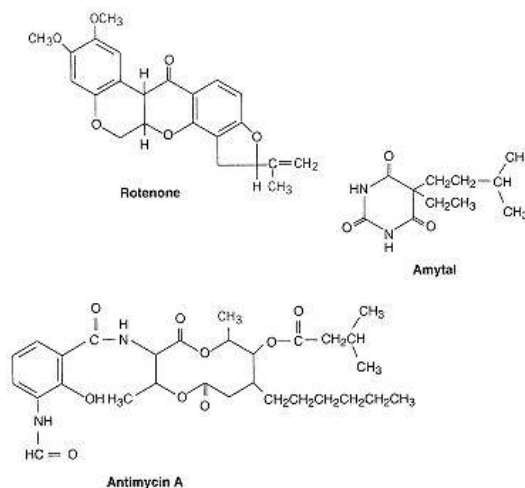

Figure 6.45
Structures of respiratory chain inhibitors.

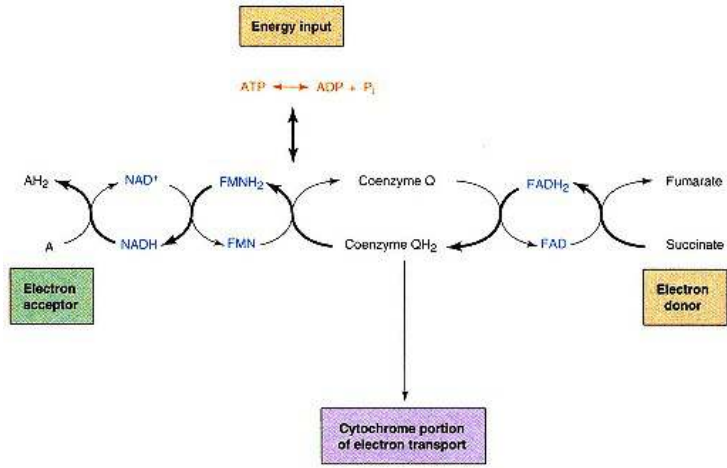

Figure 6.46
Reversal of mitochondrial electron transfer.

Oxidative Phosphorylation Is Coupled to Electron Transport

The obligatory coupling between the electron-transferring reactions and oxidative phosphorylation can best be illustrated in the experiment shown in Figure 6.47. Mitochondrial electron transport monitored by measuring the rate of oxygen consumption by a suspension of liver mitochondria can occur at a rapid rate only following the addition of an oxidizable substrate (the electron donor) and ADP (a phosphate acceptor) plus P_i. The "active" state in the presence of substrate and ADP has been designated State 3 and is a situation in which there occurs rapid electron transfer, oxygen consumption, and rapid synthesis of ATP. Following conversion of all the added ADP to ATP, the rate of electron transfer subsides back to the rate observed prior to ADP addition. Hence respiration is tightly coupled to ATP synthesis and this relationship has been termed respiratory control or phosphate acceptor control. The ratio of the active (**State 3**) rate to the resting (**State 4**) rate of respiration is referred to as the respiratory control ratio and is a measure of the "tightness" of coupling between electron transfer and oxidative phosphorylation. Damaged mitochondrial preparations and preparations to which various uncoupling compounds (see below) have been added exhibit low respiratory control ratios, indicating that the integrity of the mitochondrial membrane is required for tight coupling.

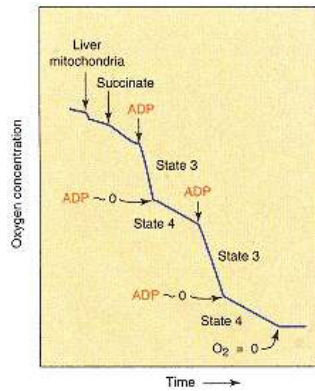
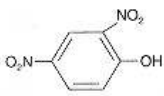
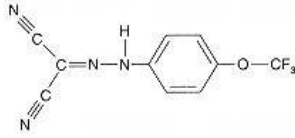

Figure 6.47
Demonstration of the coupling of electron transport to oxidative phosphorylation in a suspension of liver mitochondria.
State 3/state 4 = respiratory control ratio.

The effect of **uncouplers** and inhibitors of the electron transport–oxidative phosphorylation sequence is illustrated in Figure 6.48. Following the addition of ADP, which initiates a rapid State 3 rate of respiration, an inhibitor of the oxidative phosphorylation sequence (actually the mitochondrial F₁F₀-ATPase), **oligomycin**, is added. Oligomycin stops ATP synthesis, and because electron transport and ATP synthesis are tightly coupled, respiration or electron transport is inhibited nearly completely. Following inhibition of both oxygen consumption and ATP synthesis, addition of an uncoupler of these two processes such as **2,4-dinitrophenol** or **carbonylcyanide-*p*-trifluoromethoxy phenylhy-**

drazone (FCCP),

2,4-Dinitrophenol



Carbonylcyanide-p-trifluoromethoxy phenylhydrazone (FCCP)

causes a rapid initiation of oxygen consumption. Because respiration or electron transport is now uncoupled from ATP synthesis, electron transport may continue but without ATP synthesis.

Note that regulation of the respiration rate of a tissue by provision of a phosphate acceptor, ADP, is a normal physiological situation. For example, when a muscle is exercised, ATP is broken down to ADP and P_i , and creatine phosphate is converted to creatine as the high-energy phosphate bond is transferred to ATP by creatine phosphokinase (see p. 957). As ADP accumulates during the muscular activity, respiration or oxygen consumption is activated, and the energy generated in this fashion allows the ATP and creatine phosphate levels to be replenished (see Clin. Corr. 6.6).

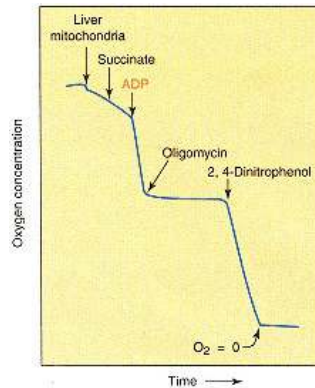

Figure 6.48
Inhibition and uncoupling of oxidative phosphorylation in liver mitochondria.

6.7—**Oxidative Phosphorylation**

One of the most vexing problems that confronted biochemists during the last four decades was the delineation of the mechanism of oxidative phosphorylation. After years of experimental consideration were expended to define the mechanism of mitochondrial energy conservation, consensus was reached on many of the details of the mechanism by which energy derived from the passage of electrons sequentially along the electron transport chain is transduced into the chemical energy involved in the phosphoanhydride bonds of ATP.

Several hypotheses for the mechanism of oxidative phosphorylation were tested including the **chemical-coupling hypothesis** developed in the early

CLINICAL CORRELATION 6.6**Hypoxic Injury**

Acute hypoxic tissue injury has been studied in a variety of human tissues. The occlusion of a major coronary artery during myocardial infarction produces a large array of biochemical and physiological sequelae. When a tissue is deprived of its oxygen supply, the mitochondrial electron transport–oxidative phosphorylation sequence is inhibited, resulting in the decline of cellular levels of ATP and creatine phosphate. As cellular ATP levels diminish, anaerobic glycolysis is activated in an attempt to maintain normal cellular functions. Glycogen levels are rapidly depleted and lactic acid levels in the cytosol increase, reducing the intracellular pH. Hypoxic cells in such an energy deficit begin to swell as they can no longer maintain their normal intracellular ionic environments. Mitochondria swell and begin to accumulate calcium, which may be deposited in the matrix compartment as calcium phosphate. The cell membranes of swollen cells become more permeable, leading to the leakage of various soluble enzymes, coenzymes, and other cell constituents from the cell. As the intracellular pH falls, damage occurs to lysosomal membranes, which release various hydrolytic proteases, lipases, glucosidases, and phosphatases into the cell. Such lysosomal enzymes begin an autolytic digestion of cellular components.

Cells that have been exposed to short periods of hypoxia can recover, without irreversible damage, upon reperfusion with an oxygen-containing medium. The exact point at which hypoxic cell damage becomes irreversible is not precisely known. This process is of great practical importance for transplantation of organs (heart, kidney, and liver), which always undergo a period of hypoxia between the time they are removed from the donor and implanted into the recipient.

Kehrer, J. P. Concepts related to the study of reactive oxygen and cardiac reperfusion injury. *Free Radic Res. Commun.* 5:305, 1986; and Granger, D. N. Role of xanthine oxidase and granulocytes in ischemia—reperfusion injury. *Am. J. Physiol.* 255:H1269, 1988.

1950s. This mechanism was based on an analogy with the mechanism of **substrate-level phosphorylation** in the glyceraldehyde-3-phosphate dehydrogenase reaction (see p. 276) of glycolysis. In this reaction glyceraldehyde 3-phosphate is oxidized and a high-energy phosphoric–carboxylic acid anhydride bond is generated in the product of the reaction, 1,3-bisphosphoglycerate. An enzyme-bound high-energy intermediate is generated in this reaction, which is utilized to form the intermediate high-energy compound 1,3-bisphosphoglycerate and ultimately to form ATP in the next reaction in the glycolytic pathway, that of phosphoglycerate kinase (see p. 276). Another example of a substrate-level phosphorylation reaction, which was defined in the 1960s, is the succinyl-CoA synthetase reaction of the TCA cycle. Here the high-energy character of succinyl CoA is converted to the phosphoric acid anhydride bond in GTP with the intermediate participation of a high-energy, phosphorylated histidine moiety on the enzyme. Because of these types of substrate-level phosphorylation reactions, it was proposed that the mechanism of mitochondrial energy transduction involved a series of high-energy intermediates generated in the mitochondrial membrane as a consequence of electron transport. No high-energy intermediates have ever been defined or isolated.

A second proposal for the mechanism of oxidative phosphorylation was the **conformational-coupling hypothesis**. This hypothesis has an analogy in the process of muscle contraction in which ATP hydrolysis is used to drive conformational changes in myosin head groups, which result in the disruption of cross-bridges to actin thin filaments. The conformational-coupling hypothesis proposed that as a consequence of electron transport in the inner mitochondrial membrane a conformational change in a membrane protein occurred. ATP could be synthesized by a mechanism that allowed the membrane protein in its high-energy conformation to revert to its low-energy or random state, with the resultant formation of ATP from ADP and P_i . Hence the high-energy state of the membrane protein is transduced into the bond energy of the γ -phosphate group of ATP. There are various experimental observations indicating that mitochondrial membrane proteins undergo conformational changes during the process of active electron transport. However, there is relatively little evidence demonstrating conclusively that such conformational changes are actually involved in the mechanism of ATP synthesis.

The Chemiosmotic-Coupling Mechanism Involves the Generation of a Proton Gradient and Reversal of an ATP-Dependent Proton Pump

The **chemiosmotic-coupling mechanism** proposed by Peter Mitchell is the mechanism for energy transduction in mitochondria, as well as other biological systems. Mitchell's original proposition compared the energy-generating systems in biological membranes to a common storage battery. Just as energy can be stored in batteries because of the separation of positive and negative charges in the different components of the battery, energy may be generated as a consequence of the separation of charges in complex membrane systems. In the chemiosmotic mechanism (Figure 6.49) an electrochemical gradient (protons) is established across the inner mitochondrial membrane during electron transport. This proton gradient is formed by pumping protons from the mitochondrial matrix side of the inner membrane to the cytosolic side of the membrane. Once a substantial electrochemical gradient is established, the subsequent dissipation of the gradient is coupled to the synthesis of ATP by the **mitochondrial F_1F_0 -ATPase**. The electron transport carriers and the F_1F_0 -ATPase are localized in such a fashion in the inner mitochondrial membrane that protons are pumped out of the matrix compartment during the electron transport phase of the process and allowed back through the membrane during the ATP synthetase aspect of the process.

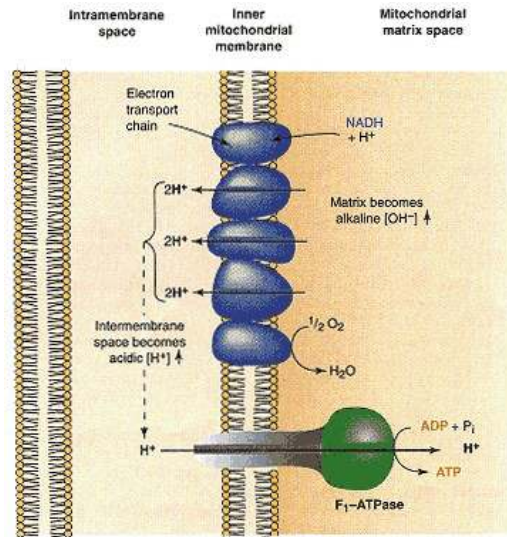

Figure 6.49

The mechanism of chemiosmotic coupling of electron transport and oxidative phosphorylation.

Uncouplers of the processes of respiration and phosphorylation are relatively lipophilic weak acids and act to dissipate the proton gradient by transporting protons through the membrane from the intermembrane space to the matrix. This short-circuits the normal flow of protons through the F_1F_0 -ATPase. F_1F_0 -ATPase can be purified and when incorporated into artificial membrane vesicles is able to synthesize ATP when an electrochemical gradient is established across the membrane. Proton-translocating ATPases are present and can be purified from a variety of mammalian tissues, bacteria, and yeast. The ATPase is a multicomponent complex with a suggested molecular weight of 480,000–500,000 (Figure 6.50). These ATPases can be incorporated into artificial membranes and can catalyze ATP synthesis. The F_1F_0 -ATPase complex consists of a water-soluble portion called F_1 and a hydrophobic portion called F_0 . The F_1 consists of five nonidentical subunits (α , β , γ , δ , and ϵ) with a subunit stoichiometry of $\alpha_3\beta_3\gamma\delta\epsilon$ and a molecular weight of 350,000–380,000. Nucleotide-binding sites of the enzyme have been localized on the α and β subunits. The γ subunit has been proposed to function as a gate to the proton-translocating activity of the complex, while the δ subunit has been suggested to be necessary for the attachment of the F_1 portion to the membrane. The ϵ subunit has been proposed to regulate the F_1 -ATPase. The F_0 portion consists of three or four nonidentical subunits that are an integral part of the membrane from which the ATPase is derived. When purified F_0 is incorporated into an artificial membrane, it renders the membrane permeable to protons. In addition, the F_0 contains a subunit called the oligomycin-sensitivity-conferring protein, which, as the name implies, causes the ATPase complex to be sensitive to the inhibitory action of oligomycin.

A number of questions relating to the details of the mechanism by which this important biochemical process occurs have not been resolved. Such questions relate to the mechanism by which protons are pumped out of the mitochondrial matrix during electron transport, the stoichiometry of protons translocated per ATP synthesized, and the mechanism by which protons are pumped back into the matrix through the F_1F_0 -ATPase.

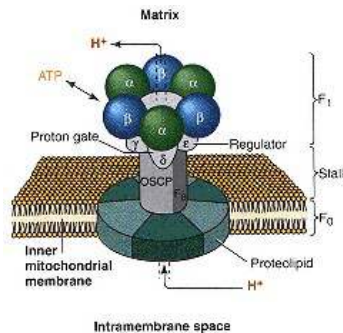

Figure 6.50

A model for the mitochondrial F_1F_0 -ATPase.

Bibliography

Energy-Producing and Energy-Utilizing Systems

Atkinson, D. E. *Cellular Energy Metabolism and Its Regulation*. New York: Academic Press, 1977.

Bock, R. M. Adenosine nucleotides and properties of pyrophosphate compounds. In: P. D. Boyer, H. Lardy, and K. Myrback (Eds.), *The enzymes*, 2nd ed., Vol. 2. New York: Academic Press, 1960, p. 3.

Hanson, R. W. The role of ATP in metabolism. *Biochem. Educ.* 17:86, 1989.

Lipmann, F. Metabolic generation and utilization of phosphate bound energy. *Adv. Enzymol.* 1:99, 1941.

Sources and Fates of Acetyl Coenzyme A

Behal, R. H., Buxton, D. B., Robertson, J. G., and Olson, M. S. Regulation of the pyruvate dehydrogenase multienzyme complex, *Annu. Rev. Nutr.* 13:497, 1993.

Denton, R. M., and Halestrap, A. Regulation of pyruvate metabolism in mammalian tissues. *Essays Biochem.* 15:37, 1979.

Patel, M. S., and Harris, R. A. Mammalian α -keto acid dehydrogenase complexes: gene regulation and genetic defects. *FASEB J.* 9:1164, 1995.

Reed, L. J., and Hackert, M. L. Structure–function relationships in dihydrolipoamide acyl transferases. *J Biol. Chem.* 265:8971, 1990.

Roche, T. E., and Patel, M. S. α -Keto acid dehydrogenase complexes: organization, regulation and biomedical ramifications. *Ann. N. Y. Acad. Sci.* 573:1, 1989.

The Tricarboxylic Acid Cycle

Hansford, R. G. Control of mitochondrial substrate oxidation. *Curr. Top. Bioenerg.* 10:217, 1980.

Krebs, H. A. The history of the tricarboxylic acid cycle. *Perspect. Biol. Med.* 14:154, 1970.

Kornberg, H. L. Tricarboxylic acid cycles. *BioEssays* 7:236, 1987.

Lowenstein, J. M. (Ed.). *Citric Acid Cycle: Control and Compartmentation*. New York: Marcel Dekker, 1969.

McCormack, J. G., and Denton, R. M. Ca^{2+} as a second messenger within mitochondria. *Trends Biochem. Sci.* 11:258, 1986.

Srere, P. M. The enzymology of the formation and breakdown of citrate. *Adv. Enzymol.* 43:57, 1975.

Williamson, J. R., and Copper, R. V. Regulation of the citric acid cycle in mammalian systems. *FEBS Lett.* 117 (Suppl.), K73, 1980.

Structure and Compartmentation of Mitochondrial Membranes

Ernster, L. (Ed.). *Bioenergetics*. Amsterdam: Elsevier, 1984.

Klingenberg, M. The ATP–ADP carrier in mitochondrial membranes. In: A. N. Martinosi (Ed.), *The Enzymes of Biological Membranes*. New York: Plenum Press, 1976, p. 383.

LaNoue, K. F., and Schoolwerth, A. C. Metabolite transport in mitochondria. *Annu. Rev. Biochem.* 48:871, 1979.

Tzagoloff, A. *Mitochondria*. New York: Plenum Press, 1982.

Yaffe, M., and Schatz, G. The future of mitochondrial research. *Trends Biochem. Sci.* 9:179, 1984.

Electron Transport

Babcock, G. T., and Wickstrom, M. Oxygen activation and the conservation of energy in cell respiration. *Nature* 356:301, 1992.

Brand, M. D., and Murphy, M. P. Control of electron flux through the respiratory chain in mitochondria and cells. *Biol. Rev. Camb. Philos. Soc.* 62:141, 1987.

Calhoun, M. W., Thomas, J. W., and Gennis, R. B. The cytochrome oxidase superfamily of redox-driven proton pumps. *Trends Biochem. Sci.* 19:325, 1994.

Hatefi, Y. The mitochondrial electron transport and oxidative phosphorylation system. *Annu. Rev. Biochem.* 54:1015, 1985.

Trumpower, B. L., and Gennis, R. B. Energy transduction by cytochrome complexes in mitochondrial and bacterial respiration. *Annu. Rev. Biochem.* 63:675, 1994.

Wikstrom, M., Krab, K., and Saraste, M. Proton-translocating cytochrome complexes. *Annu. Rev. Biochem.* 50:623, 1981.

Oxidative Phosphorylation

Boyer, P. D. A perspective of the binding change mechanism for ATP synthesis. *FASEB J.* 3:2164, 1989.

Boyer, P. D., Chance, B., Ernster, L., Mitchell, P., Racker, E., and Slater, E. Oxidative phosphorylation and photophosphorylation. *Annu. Rev. Biochem.* 49:955, 1977.

Chernyak, B. V., and Kozlov, I. A. Regulation of H^+ -ATPases in oxidative and photophosphorylation. *Trends Biochem. Sci.* 11:32, 1986.

Mitchell, P. Vectorial chemistry and the molecular mechanism of chemiosmotic coupling: power transmission by proticity. *Biochem. Soc. Trans.* 4:398, 1976.

Mitchell, P. Keilin's respiratory chain concept and its chemiosmotic consequences. *Science* 206:1148, 1979.

Pedersen, P. L., and Carafoli, E. Ion motive ATPases. I. Ubiquity, properties and significance to cell function. *Trends Biochem. Sci.* 12:145, 1987; II Energy coupling and work output. *Trends Biochem. Sci.* 12:186, 1987.

Racker, E. From Pasteur to Mitchell: a hundred years of bioenergetics. *Fed. Proc.* 39:210, 1980.

Senior, A. E. ATP synthesis by oxidative phosphorylation. *Physiol. Rev.* 68:177, 1988.

Shoffner, J. M., and Wallace, D. C. Oxidative phosphorylation diseases and mitochondrial DNA mutations. *Annu. Rev. Nutr.* 14:535, 1994.

Questions

J. Baggott and C. N. Angstadt

1. At 37°C , $-2.303RT = -1.42 \text{ kcal mol}^{-1}$. For the reaction $\text{A} \rightleftharpoons \text{B}$, if $G^\circ = -7.1 \text{ kcal mol}^{-1}$, what is the equilibrium ratio of B/A?

- A. 10,000,000/1
- B. 100,000/1
- C. 1000/1
- D. 1/1000
- E. 1/100,000

2. A bond may be "high energy" for any of the following reasons EXCEPT:

- A. products of its cleavage are more resonance stabilized than the original compound.
- B. the bond is unusually stable, requiring a large energy input to cleave it.
- C. electrostatic repulsion is relieved when the bond is cleaved.
- D. a cleavage product may be unstable, tautomerizing to a more stable form.
- E. the bond may be strained.

3. The active form of pyruvate dehydrogenase is favored by the influence of all of the following on pyruvate dehydrogenase kinase EXCEPT:

- A. low $[\text{Ca}^{2+}]$.
- B. low acetyl CoA/CoASH.
- C. high [pyruvate].
- D. low NADH/NAD⁺.

4. At which of the following enzyme-catalyzed steps of the tricarboxylic acid cycle does net incorporation of the elements of water into an intermediate of the cycle occur?
- aconitase
 - citrate synthase
 - malate dehydrogenase
 - succinate dehydrogenase
 - succinyl-CoA synthase
5. A freely reversible reaction of the tricarboxylic acid cycle is catalyzed by:
- citrate synthase.
 - isocitrate dehydrogenase.
 - α -ketoglutarate dehydrogenase.
 - pyruvate dehydrogenase.
 - succinyl-CoA synthetase.
6. All of the following tricarboxylic acid cycle intermediates may be added or removed by other metabolic pathways EXCEPT:
- citrate.
 - fumarate.
 - isocitrate.
 - α -ketoglutarate.
 - oxaloacetate.
7. Regulation of tricarboxylic acid cycle activity *in vivo* may involve the concentration of all of the following EXCEPT:
- acetyl CoA.
 - ADP.
 - ATP.
 - CoA.
 - oxygen.
8. The mitochondrial membrane contains a transporter for:
- NADH.
 - acetyl CoA.
 - GTP.
 - ATP.
 - NADPH.
9. Which line of the accompanying table correctly describes the indicated properties of BOTH the malate shuttle and the α -glycerophosphate shuttle?

Table for Question 9

<i>Property</i>	<i>Malate Shuttle</i>	<i>α-Glycerophosphate Shuttle</i>
A. Location	Inner mitochondrial membrane	Outer mitochondrial membrane
B. ATP generated per cytoplasmic NADH	3	2
C. Transporter	Malate dehydrogenase	α -Glycerophosphate dehydrogenase
D. Species transported	Malate	α Glycerophosphate
E. Matrix electron acceptor	Oxaloacetate	Cytochrome <i>b</i>

Refer to the following for Questions 10–12.

- FAD
 - FMN
 - NAD⁺
 - NADPH
 - none of the above
10. Prosthetic group of NADH dehydrogenase.
11. The usual source of reducing equivalents for anabolic processes.
12. Irradiation with light of 340-nm wavelength causes fluorescence emission at 465 nm.
13. If rotenone is added to the mitochondrial electron transport chain:
- the P/O ratio of NADH is reduced from 3:1 to 2:1.
 - the rate of NADH oxidation is diminished to two-thirds of its initial value.
 - succinate oxidation remains normal.
 - oxidative phosphorylation is uncoupled at site I.
 - electron flow is inhibited at site II.
14. If cyanide is added to tightly coupled mitochondria that are actively oxidizing succinate:
- subsequent addition of 2,4-dinitrophenol will cause ATP hydrolysis.
 - subsequent addition of 2,4-dinitrophenol will restore succinate oxidation.
 - electron flow will cease, but ATP synthesis will continue.
 - electron flow will cease, but ATP synthesis can be restored by subsequent addition of 2,4-dinitrophenol.
 - subsequent addition of 2,4-dinitrophenol and the phosphorylation inhibitor oligomycin will cause ATP hydrolysis.
15. The heme iron of which of the following is bound to the protein by only one coordination linkage?
- cytochrome *a*
 - cytochrome *a*₃
 - cytochrome *b*
 - cytochrome *c*
 - none of the above
16. In substrate level phosphorylation:
- the substrate reacts to form a product containing a high-energy bond.
 - ATP synthesis is linked to dissipation of a proton gradient.
 - high-energy intermediate compounds cannot be isolated.
 - oxidation of one molecule of substrate is linked to synthesis of more than one ATP molecule.
 - mitochondria participate, but not cytoplasm.
17. The chemiosmotic hypothesis involves all of the following EXCEPT:
- a membrane impermeable to protons.
 - electron transport by the respiratory chain pumps protons out of the mitochondrion.
 - proton flow into the mitochondria depends on the presence of ADP and P_i.
 - ATPase activity is reversible.
 - only proton transport is strictly regulated; other positively charged ions can diffuse freely across the mitochondrial membrane.

Answers

1. B $G^\circ = -2.3RT \log K$. $\log 100,000 = 5$. Substitution gives $G^\circ = -7.1$ (p. 221).
2. B A "high-energy" bond is so designated because it has a high free energy of hydrolysis. This could arise for reasons A, C, D, or E. High-energy does not refer to a high energy of formation (bond stability) (p. 222).
3. A High $[Ca^{2+}]$ favors the active dehydrogenase but by activating the phosphatase. NADH and acetyl CoA activate pyruvate dehydrogenase kinase, thus inactivating pyruvate dehydrogenase. Pyruvate inhibits the kinase, favoring the active dehydrogenase (p. 230, Figure 6.16).
4. B Water is required to hydrolyze the thioester bond of acetyl CoA. A: Aconitase removes water, then adds it back. C and D: The dehydrogenases remove two protons and two electrons E. Here the thioester undergoes phosphorolysis, not hydrolysis, the phosphate is subsequently transferred from the intermediate succinyl phosphate to GDP. (See p. 232, Figure 6.19).
5. E There are high-energy compounds on both sides of the reaction, namely, GTP and succinyl CoA (p.235). A is irreversible due to cleavage of the thioester link, a high-energy bond. In B and C, CO_2 is released. D: Pyruvate dehydrogenase is not a part of the tricarboxylic acid cycle; it is, however, irreversible.
6. C A: Citrate is transported out of the mitochondria to be used as a source of cytoplasmic acetyl CoA. B: Fumarate is produced during phenylalanine and tyrosine degradation. D can be formed from glutamate. E: Oxaloacetate is produced by pyruvate carboxylase and is used in gluconeogenesis. Clearly, most of the tricarboxylic acid cycle intermediates play multiple roles in the body.
7. D CoA is not a regulator, though admittedly there is a reciprocal relationship between CoA and acetyl CoA concentrations in the short term. A is the substrate (p. 232). B activates isocitrate dehydrogenase, and C inhibits it (p. 239, Figure 6.23). E: The cycle requires oxygen to oxidize NADH and ADP to be converted to ATP (respiratory control) (p. 231).
8. D A and B: Reducing equivalents from NADH are shuttled across the membrane, as is the acetyl group of acetyl CoA, but NADH and acetyl CoA themselves cannot cross (p. 243, Figures 6.28 and 6.29). C and D: Of the nucleotides, only ATP and ADP are transported. The translocator is inhibited by atractyloside (p. 245). E: Like NADH, NADPH does not cross the membrane.
9. B A: Both shuttles operate across the inner membrane. C: Two transporters are used by the malate shuttle, the malate α -ketoglutarate antiporter and the aspartate–glutamate antiporter. D: α -Glycerophosphate is not translocated; only reducing equivalents are. E: Oxaloacetate is a reaction product. NAD^+ is the electron acceptor (p. 244, Figure 6.28).
10. B See Figure 6.40, p. 256.
11. D NADPH is not a substrate for mitochondrial electron transport (p. 250).
12. D Fluorescence excitation of the reduced pyridine ring occurs in a wavelength range where it absorbs light, about 340 nm. Absorbance is a minimum at 300 nm (p. 250, Figure 6.33).
13. C Rotenone inhibits at the level of NADH dehydrogenase (site I), preventing all electron flow and all ATP synthesis from NADH. Flavin-linked dehydrogenases feed in electrons below site I and are unaffected by site I inhibitors (pp. 259, 256, Figure 6.40).
14. A Cyanide inhibits electron transport at site III, blocking electron flow throughout the system. In coupled mitochondria, ATP synthesis ceases too. Addition of an uncoupler permits the mitochondrial ATPase (which is normally driven in the synthetic direction) to operate, and it catalyzes the favorable ATP hydrolysis reaction unless it is inhibited by a phosphorylation inhibitor such as oligomycin (p. 260).
15. B Fe^{2+} has six coordination positions. In heme, four are filled by the porphyrin ring. In cytochromes *a*, *b*, and *c* the other two are filled by the protein. But in cytochrome *a₃*, one position must be left vacant to provide an oxygen-binding site (p. 252).
16. A A good example of substrate-level phosphorylation is seen in the glyceraldehyde-3-phosphate dehydrogenase reaction, where a phosphoric–carboxylic acid anhydride intermediate forms (p. 262). This is a cytoplasmic process, part of glycolysis. The intermediate can be isolated.
17. E If the charge separation could be dissipated by free diffusion of other ions, the energy would be lost, and no ATP could be synthesized.

Chapter 7— Carbohydrate Metabolism I: Major Metabolic Pathways and their Control

Robert A. Harris

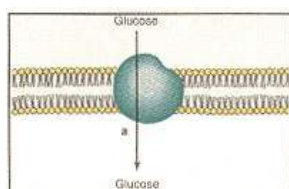

7.1 Overview	268
7.2 Glycolysis	269
Glycolysis Occurs in all Human Cells	269
Glucose is Metabolized Differently in Various Cells	270
7.3 The Glycolytic Pathway	272
Glycolysis Occurs in Three Stages	274
Stage One Primes the Glucose Molecule	274
Stage Two Is Splitting of a Phosphorylated Intermediate	275
Stage Three Involves Oxidoreduction Reactions and the Synthesis of ATP	275
A Balance of Reduction of NAD^+ and Reoxidation of NADH Is Required: Role of Lactate Dehydrogenase	278
NADH Generated during Glycolysis Can Be Reoxidized via Substrate Shuttle Systems	279
Shuttles Are Important in Other Oxidoreductive Pathways	280
Alcohol Oxidation	280
Glucuronide Formation	280
Two Shuttle Pathways Yield Different Amounts of ATP	281
Glycolysis Can Be Inhibited at Different Stages	282
7.4 Regulation of the Glycolytic Pathway	283
Hexokinase and Glucokinase Have Different Properties	284
6-Phosphofructo-1-kinase Is the Major Regulatory Site	286
Crossover Theorem Explains Regulation of 6-Phosphofructo-1-kinase by ATP and AMP	287
Intracellular pH Can Regulate 6-Phosphofructo-1-kinase	290
Intracellular Citrate Levels Regulate 6-Phosphofructo-1-kinase	292
Hormonal Control of 6-Phosphofructo-1-kinase by cAMP and Fructose 2,6-bisphosphate	292
cAMP Activates a Protein Kinase A	294
6-Phosphofructo-2-kinase and Fructose 2,6-bisphosphatase Are Domains of a Bifunctional Polypeptide Regulated by Phosphorylation–Dephosphorylation	295
Heart Contains a Different Isoenzyme of the Bifunctional Enzyme	296
Pyruvate Kinase Is a Regulated Enzyme of Glycolysis	298
7.5 Gluconeogenesis	299
Glucose Synthesis Is Required for Survival	299
The Cori and Alanine Cycles	299
Pathway of Glucose Synthesis from Lactate	301
Pyruvate Carboxylase and Phosphoenolpyruvate Carboxykinase	301
Gluconeogenesis Uses Many Glycolytic Enzymes but in the Reverse Direction	303
Glucose Is Synthesized from the Carbon Chains of Some Amino Acids	304
Glucose Can Be Synthesized from Odd-Chain Fatty Acids	306
Glucose Is Synthesized from Other Sugars	307
Fructose	307
Galactose	307
Mannose	307
Gluconeogenesis Requires Expenditure of ATP	308
Gluconeogenesis Has Several Sites of Regulation	308
Hormonal Control of Gluconeogenesis Is Critical for Homeostasis	310
Ethanol Ingestion Inhibits Gluconeogenesis	312
7.6 Glycogenolysis and Glycogenesis	312
Glycogen, a Storage Form of Glucose, Is Required As a Ready Source of Energy	312
Glycogen Phosphorylase Catalyzes the First Step in Glycogen Degradation	314

Debranching Enzyme Is Required for Complete Hydrolysis of Glycogen	317
Synthesis of Glycogen Requires Unique Enzymes	319
Glycogen Synthase	319
Special Features of Glycogen Degradation and Synthesis	321
Why Store Glucose As Glycogen?	321
Glycogenin Is Required As a Primer for Glycogen Synthesis	321
Glycogen Limits its Own Synthesis	322
Glycogen Synthesis and Degradation Are Highly Regulated Pathways	322
Regulation of Glycogen Phosphorylase	322
The Cascade That Regulates Glycogen Phosphorylase Amplifies a Small Signal into a Very Large Effect	323
Regulation of Glycogen Synthase	324
Regulation of Phosphoprotein Phosphatases	325
Effector Control of Glycogen Metabolism	326
Negative Feedback Control of Glycogen Synthesis by Glycogen	326
Phosphorylase a Functions As a "Glucose Receptor" in the Liver	326
Glucagon Stimulates Glycogen Degradation in the Liver	327
Epinephrine Stimulates Glycogen Degradation in the Liver	327
Epinephrine Stimulates Glycogen Degradation in Heart and Skeletal Muscle	328
Neural Control of Glycogen Degradation in Skeletal Muscle	328
Insulin Stimulates Glycogen Synthesis in Muscle and Liver	329
Bibliography	330
Questions and Answers	331
Clinical Correlations	
7.1 Alcohol and Barbiturates	281
7.2 Arsenic Poisoning	283
7.3 Fructose Intolerance	285
7.4 Diabetes Mellitus	287
7.5 Lactic Acidosis	291
7.6 Pickled Pigs and Malignant Hyperthermia	291
7.7 Angina Pectoris and Myocardial Infarction	292
7.8 Pyruvate Kinase Deficiency and Hemolytic Anemia	299
7.9 Hypoglycemia and Premature Infants	300
7.10 Hypoglycemia and Alcohol Intoxication	312
7.11 Glycogen Storage Diseases	317

7.1— Overview

The major pathways of carbohydrate metabolism either begin or end with glucose (Figure 7.1). This chapter describes the utilization of glucose as a source of energy, formation of glucose from noncarbohydrate precursors, storage of glucose in the form of glycogen for later use, and release of glucose from glycogen for use by cells. An understanding of the pathways and their regulation is necessary because of the important role played by glucose in the body. Glucose is the major form in which carbohydrate absorbed from the intestinal tract is presented to cells of the body. Glucose is the only fuel used to any significant extent by a few specialized cells and the major fuel used by the brain. Indeed, glucose is so important to these specialized cells and the brain that several of the major tissues of the body work together to ensure a continuous supply of this essential substrate. Glucose metabolism is defective in two very common metabolic diseases, obesity and diabetes, which contribute in development of a number of major medical problems, including atherosclerosis, hypertension, small vessel disease, kidney disease, and blindness.

The discussion begins with **glycolysis**, a pathway used by all cells of the body to extract part of the chemical energy inherent in the glucose molecule. This pathway also converts glucose to pyruvate and sets the stage for complete oxidation of glucose to CO_2 and H_2O . The *de novo* synthesis of glucose, that is, gluconeogenesis, is a function of the liver and kidneys and can conveniently be discussed following glycolysis because it makes use of some of the same enzymes used in the glycolytic pathway, although the reactions catalyzed are in the opposite direction. In contrast to glycolysis, which produces ATP, gluconeogenesis requires ATP and is therefore an energy-requiring process. The consequence is that only some of the enzyme-catalyzed steps can be common to both the glycolytic and gluconeogenic pathways. Indeed, additional enzymes including some in mitochondria become involved to make the overall process of gluconeogenesis exergonic. Regulation of the rate-limiting and key enzyme-catalyzed steps will be stressed throughout the chapter. This will be particularly

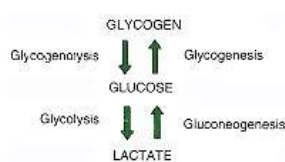

Figure 7.1
Relationship of glucose to the major pathways of carbohydrate metabolism.

true for glycogen synthesis (**glycogenesis**) and degradation (**glycogenolysis**). Many cells store glycogen for the purpose of having glucose available for later use. The liver is less selfish, storing glycogen not for its own use, but for maintenance of blood glucose levels that ensure that other tissues, especially the brain, have an adequate supply of this important substrate. Regulation of the synthesis and degradation of glycogen is a model for our understanding of how hormones work and how other metabolic pathways may be regulated. This subject contributes to our understanding of the diabetic condition, starvation, and how tissues of the body respond to stress, severe trauma, and injury. The Appendix presents the nomenclature and chemistry of the carbohydrates.

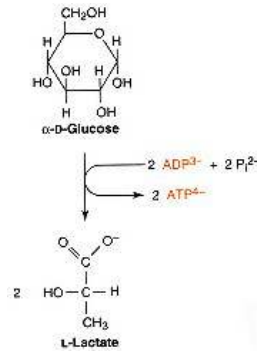
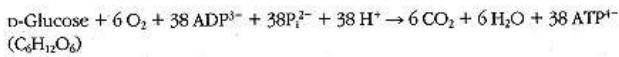

Figure 7.2
Overall balanced equation for the sum of the reactions of the glycolytic pathway.

**7.2—
Glycolysis**

Glycolysis Occurs in All Human Cells

The Embden–Meyerhof or glycolytic pathway represents an ancient process, possessed by all cells of the human body, in which anaerobic degradation of glucose to lactate occurs. This is one example of anaerobic **fermentation**, a term used to refer to pathways by which organisms extract chemical energy from high-energy fuels in the absence of molecular oxygen. For many tissues glycolysis is an emergency energy-yielding pathway, capable of yielding 2 mol of ATP from 1 mol of glucose in the absence of molecular oxygen (Figure 7.2). Thus when the oxygen supply to a tissue is shut off, ATP levels can still be maintained by glycolysis for at least a short period of time. Many examples could be given, but the capacity to use glycolysis as a source of energy is particularly important to the human being at birth. With the exception of the brain, circulation of blood decreases to most parts of the body of the neonate during delivery. The brain is not normally deprived of oxygen during delivery, but other tissues must depend on glycolysis for their supply of ATP until circulation returns to normal and oxygen becomes available again. This conserves oxygen for use by the **brain**, illustrating one of many mechanisms that have evolved to assure survival of brain tissue in times of stress. Glycolysis sets the stage for aerobic oxidation of carbohydrate. Oxygen is not necessary for glycolysis, and the presence of oxygen can indirectly suppress glycolysis, a phenomenon called the **Pasteur effect** that is considered later. Nevertheless, glycolysis can and does occur in cells with an abundant supply of molecular oxygen. Provided cells also contain mitochondria, the end product of glycolysis in the presence of oxygen is pyruvate rather than lactate. Pyruvate can then be completely oxidized to CO₂ and H₂O by enzymes housed within the mitochondria. The overall process of glycolysis plus the subsequent mitochondrial oxidation of pyruvate to CO₂ and H₂O has the following equation:



Much more ATP is produced in complete oxidation of glucose to CO₂ and H₂O than in the conversion of glucose to lactate. This has important consequences, which are considered in detail later. For glucose to be completely oxidized to CO₂ and H₂O, it must first be converted to pyruvate by glycolysis (Figure 7.3). The importance of glycolysis as a preparatory pathway is best exemplified by

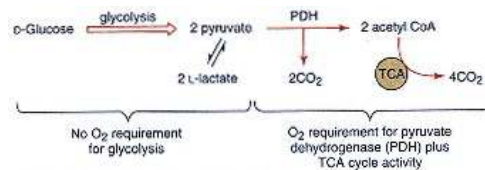

Figure 7.3
Glycolysis is a preparatory pathway for aerobic metabolism of glucose.

TCA refers to the tricarboxylic acid cycle.

the brain. This tissue has an absolute need for glucose and processes most of it via glycolysis. Pyruvate produced is then oxidized to CO_2 and H_2O in mitochondria. An adult human **brain** uses approximately 120 g of glucose each day in order to meet its need for ATP. In contrast, glycolysis with lactate as the end product is the major mechanism of ATP production in a number of other tissues. **Red blood cells** lack mitochondria and therefore are unable to convert pyruvate to CO_2 and H_2O . The **cornea, lens,** and regions of the **retina** have a limited blood supply and also lack mitochondria (because mitochondria would absorb and scatter light) and depend on glycolysis as the major mechanism for ATP production. **Kidney medulla, testis, leukocytes,** and white **muscle fibers** are almost totally dependent on glycolysis as a source of ATP, because these tissues have relatively few mitochondria. Tissues dependent primarily on glycolysis for ATP production consume about 40 g of glucose per day in a normal adult.

Major dietary sources of glucose are indicated in Chapter 26. **Starch** is the storage form of glucose in plants and contains α -1,4-glycosidic linkages along with α -1,6-glycosidic branches. **Glycogen** is the storage form of glucose in animal tissues and contains the same type of glycosidic linkages and branches. Exogenous glycogen refers to that which we eat and digest; endogenous glycogen is that synthesized or stored in our tissues. Exogenous starch or glycogen is hydrolyzed in the intestinal tract with the production of glucose, whereas stored glycogen endogenous to our tissues is converted to glucose or glucose 6-phosphate by enzymes present within the cells. Disaccharides that serve as important sources of glucose in our diet include milk sugar (lactose) and grocery store sugar (sucrose). Hydrolysis of these sugars by enzymes of the brush border of the intestinal tract is discussed on page 1075. Glucose can be used as a source of energy for cells of the intestinal tract. However, these cells do not depend on glucose to any great extent; most of their energy requirement is met by glutamine catabolism (see p. 450). Most of the glucose passes through the cells of the intestinal tract into the portal blood, then the general circulation, to be used by other tissues. Liver is the first major tissue to have an opportunity to remove glucose from the portal blood. When blood glucose is high, the liver removes glucose for the glucose-consuming processes of glycogenesis and glycolysis. When blood glucose is low, the liver supplies the blood with glucose by the glucose-producing processes of glycogenolysis and gluconeogenesis. The liver is also the first organ exposed to the blood flowing from the pancreas and therefore is exposed to the highest concentrations of the hormones released from this endocrine tissue—**glucagon** and **insulin**. These important hormonal regulators of blood glucose levels have effects on enzyme-catalyzed steps in the liver.

Glucose Is Metabolized Differently in Various Cells

After penetrating the plasma membrane by mediated transport on the **glucose transport protein GLUT-1**, glucose is metabolized mainly by glycolysis in red blood cells (Figure 7.4a). Since red blood cells lack mitochondria, the end

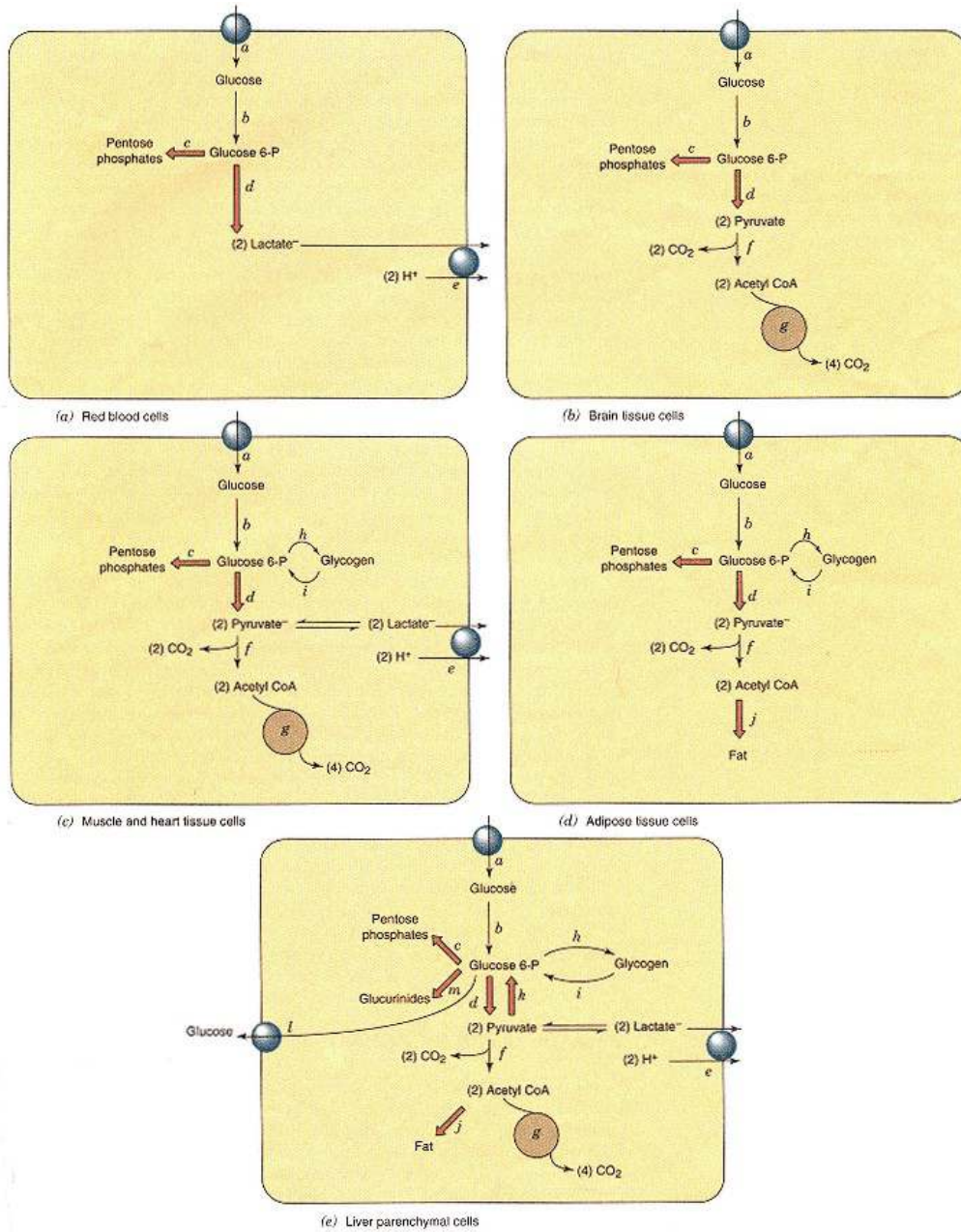

Figure 7.4
Overviews of the major ways in which glucose is metabolized within cells of selected tissues of the body.

- (a) Glucose transport into the cell by a glucose transport protein (GLUT);
- (b) glucose phosphorylation by hexokinase;
- (c) the pentose phosphate pathway;
- (d) glycolysis;
- (e) lactic acid transport out of the cell;
- (f) pyruvate decarboxylation by pyruvate dehydrogenase;
- (g) TCA cycle;
- (h) glycogenesis;
- (i) glycogenolysis;
- (j) lipogenesis;
- (k) gluconeogenesis;
- (l) hydrolysis of glucose 6-phosphate and release of glucose from the cell into the blood;
- (m) formation of glucuronides (drug and bilirubin detoxification by conjugation) by the glucuronic acid pathway.

product of glycolysis is lactic acid, which is released into the blood. Glucose used by the pentose phosphate pathway in red blood cells provides NADPH to keep **glutathione** in the reduced state, which has an important role in the destruction of organic peroxides and H_2O_2 (Figure 7.5). Peroxides cause irreversible damage to membranes, DNA, and numerous other cellular components and must be removed to prevent cell death.

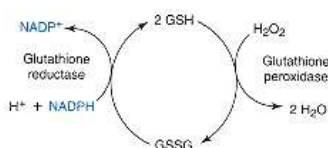

Figure 7.5

Destruction of H_2O_2 is dependent on reduction of oxidized glutathione by NADPH generated by the pentose phosphate pathway.

The brain takes up glucose by mediated transport in an insulin-independent manner by glucose transport protein **GLUT-3** (Figure 7.4b). Glycolysis in the brain yields pyruvate, which is oxidized to CO_2 and H_2O . The pentose phosphate pathway is active in these cells, generating part of the NADPH needed for reductive synthesis and the maintenance of glutathione in the reduced state.

Muscle and heart cells readily utilize glucose (Figure 7.4c). Insulin stimulates transport of glucose into these cells by way of glucose transport protein **GLUT-4**. Once in these cells, glucose can be utilized by glycolysis to give pyruvate, which is used by the pyruvate dehydrogenase complex and the TCA cycle to provide ATP. Muscle and heart, in contrast to the tissues just considered, are capable of synthesizing significant quantities of glycogen, an important process in these cells. Adipose tissue also transports glucose by the GLUT-4 protein, again in an insulin-dependent mechanism (Figure 7.4d). Pyruvate, as in other cells, is generated by glycolysis and is oxidized by the pyruvate dehydrogenase complex to give acetyl CoA, which is used primarily for *de novo* fatty acid synthesis. Generation of NADPH by the pentose phosphate pathway is important in adipose tissue because NADPH is necessary for the reductive steps of **fatty acid synthesis**. Adipose tissue has the capacity for glycogenesis and glycogenolysis, but these processes are much more limited in this tissue than in muscle and heart.

Liver has the greatest number of ways to utilize glucose (Figure 7.4e). Uptake of glucose by the liver occurs independent of insulin by means of a low-affinity, high-capacity glucose transport protein, **GLUT-2**. Glucose is used rather extensively by the pentose phosphate pathway for the production of NADPH, which is needed for reductive synthesis, maintenance of reduced glutathione, and numerous reactions catalyzed by endoplasmic reticulum enzyme systems. A quantitatively less important but nevertheless vital function of the pentose phosphate pathway is the provision of ribose phosphate, required for the synthesis of nucleotides such as ATP and those in DNA and RNA. Glucose is also used for glycogen synthesis, making glycogen storage an important feature of the liver. Glucose can also be used in the **glucuronic acid pathway**, which is important in **drug and bilirubin detoxification** (see Chapter 23). The liver is also capable of glycolysis, the pyruvate produced being used as a source of acetyl CoA for complete oxidation by the TCA cycle and for the synthesis of fat by the process of *de novo* **fatty acid synthesis**. In contrast to the other tissues, the liver is unique in that it has the capacity to convert three-carbon precursors, such as lactate, pyruvate, glycerol, and alanine, into glucose by the process of **gluconeogenesis**, to meet the need for glucose of other cells.

7.3—

The Glycolytic Pathway

Glucose is combustible and will burn in a test tube to yield heat and light but, of course, no ATP. Cells use some 30 steps to take glucose to CO_2 and H_2O , a seemingly inefficient process, since it can be done in a single step in a test tube. However, side reactions and some of the actual steps used by the cell to "burn" glucose to CO_2 and H_2O lead to the conservation of a significant amount of energy in the form of ATP. In other words, ATP is produced by the controlled "burning" of glucose in the cell, glycolysis representing only the first few steps, shown in Figure 7.6, in the overall process.

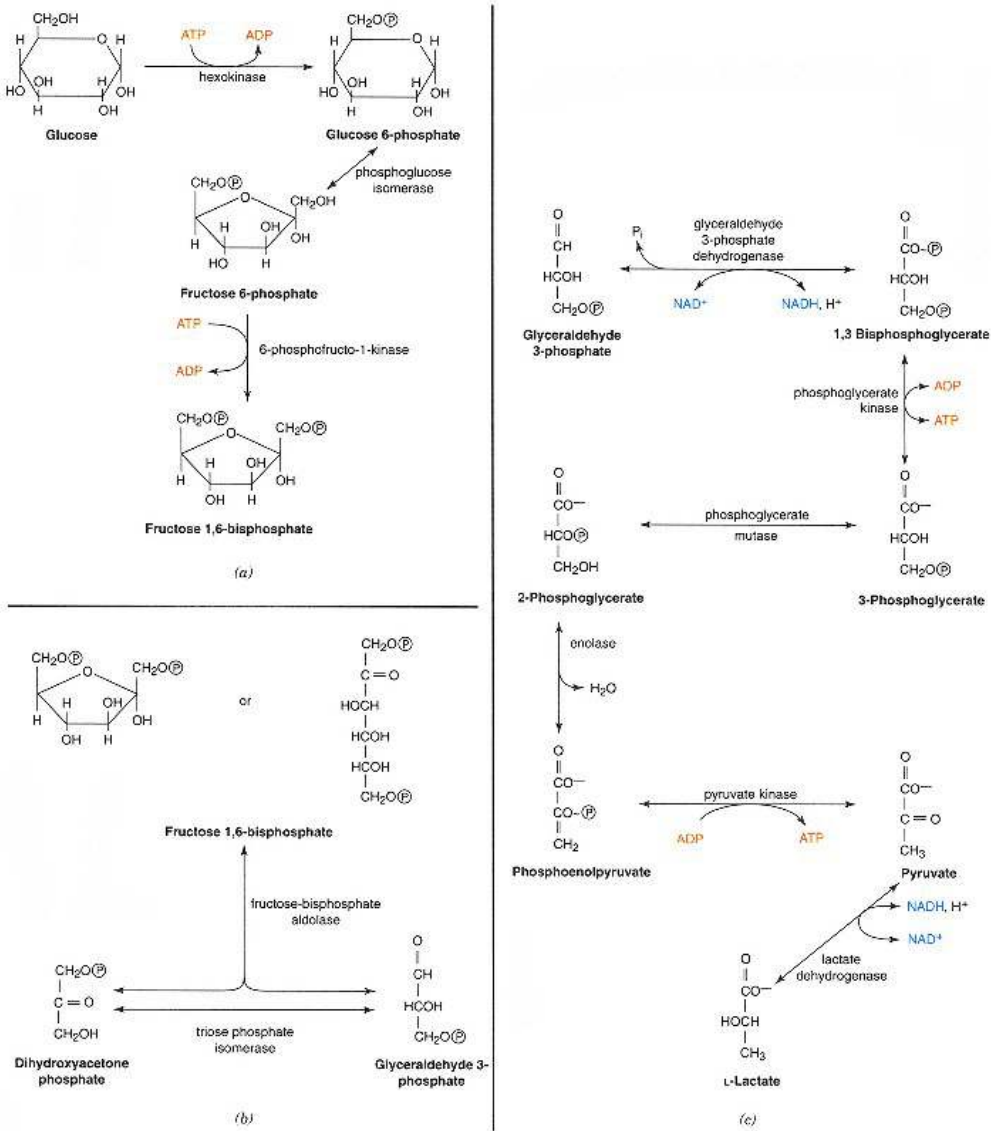
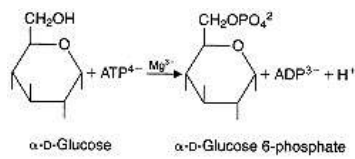
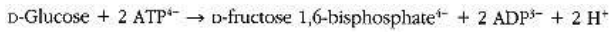

Figure 7.6
The glycolytic pathway, divided into its three stages.
 The symbol P refers to the phosphoryl group PO₃²⁻; ~ indicates a high-energy phosphate bond.
 (a) Priming stage.
 (b) Splitting stage.
 (c) Oxidoreduction-phosphorylation stage.

Glycolysis Occurs in Three Stages

Glycolysis can conveniently be pictured as occurring in three major stages (also see Figure 7.6).

Priming stage:



Splitting stage:

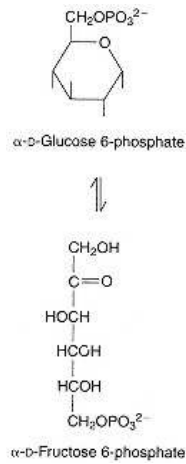
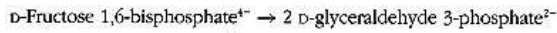

Oxidoreduction–phosphorylation stage:

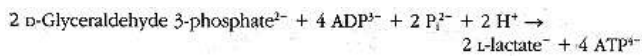

Sum:

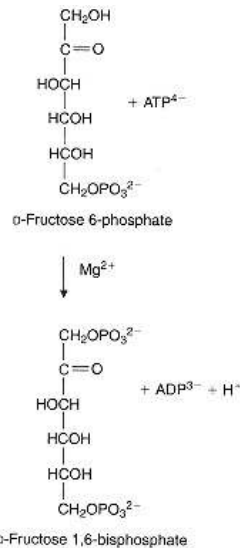
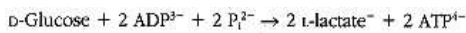

Priming stage involves input of two molecules of ATP to convert glucose into a molecule of fructose 1,6-bisphosphate. ATP is therefore "invested" in the priming stage of glycolysis. However, ATP beyond this investment is gained from the glycolytic process. The **splitting stage** "splits" the six-carbon molecule fructose 1,6-bisphosphate into two molecules of glyceraldehyde 3-phosphate. In the **oxidoreduction–phosphorylation stage** two molecules of glyceraldehyde 3-phosphate are converted into two molecules of lactate with the production of four molecules of ATP. The overall process of glycolysis generates two molecules of lactate and two molecules of ATP at the expense of one molecule of glucose.

Stage One Primes the Glucose Molecule

Hexokinase catalyzes the first step of glycolysis (see Figure 7.6a and Step 1). Although this reaction consumes ATP, it gets glycolysis off to a good start by trapping glucose as glucose 6-phosphate (G6P) within the cytosol of the cell where all of the glycolytic enzymes are located. Phosphate esters are charged hydrophilic compounds that do not readily penetrate cell membranes. The phosphorylation of glucose with ATP is a thermodynamically favorable reaction, requiring the use of one high-energy phosphate bond. It is irreversible under cellular conditions. It is not, however, a way to synthesize ATP or to hydrolyze G6P to give glucose by the reverse reaction. Hydrolysis of G6P is accomplished by a different reaction, catalyzed by **glucose 6-phosphatase**:

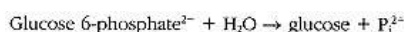

This reaction is thermodynamically favorable in the direction written and cannot be used in cells for the synthesis of G6P from glucose. (A common mistake is to note that ATP and ADP are involved in the hexokinase reaction but not to note that they are not involved in the glucose 6-phosphatase reaction.) Glucose 6-phosphatase is an important enzyme in liver, functioning to produce free glucose from G6P in the last step of both gluconeogenesis and glycogenolysis; it has no role in glycolysis.

The next reaction is a readily reversible step of the glycolytic pathway, catalyzed by **phosphoglucose isomerase** (Step 2). This step is not subject to regulation and, since it is readily reversible, functions in both glycolysis and gluconeogenesis.

6-Phosphofructo-1-kinase (or phosphofructokinase-1) catalyzes the next reaction, an ATP-dependent phosphorylation of fructose 6-phosphate (F6P) to give fructose 1,6-bisphosphate (FBP) (Step 3). This is a favorite enzyme of many students of biochemistry, being subject to regulation by several effectors and often considered the rate-limiting enzyme of the glycolytic pathway. The reac-

tion is irreversible under intracellular conditions; that is, it represents a way to produce FBP but not a way to produce ATP or F6P by the reverse reaction. This reaction utilizes the second ATP needed to "prime" glucose, thereby completing the first stage of glycolysis.

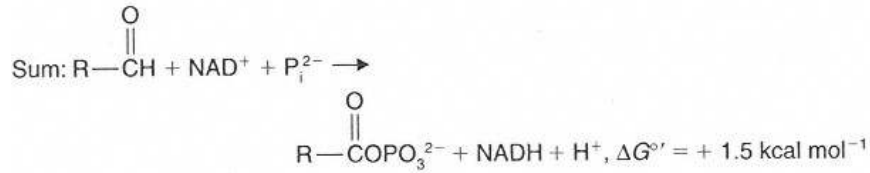

Step 4

Stage Two Is Splitting of a Phosphorylated Intermediate

Fructose 1,6-bisphosphate **aldolase** catalyzes the cleavage of fructose 1,6-bis-phosphate into a molecule each of dihydroxyacetone phosphate and glyceraldehyde 3-phosphate (GAP) (Figure 7.6b) (Step 4). This is a reversible reaction, the enzyme being called aldolase because the overall reaction is a variant of an aldol cleavage in one direction and an aldol condensation in the other. **Triose phosphate isomerase** then catalyzes the reversible interconversion of dihydroxyacetone phosphate and GAP to complete the splitting stage of glycolysis (Step 5). With the transformation of dihydroxyacetone phosphate (DHAP) into GAP, one molecule of glucose is converted into two molecules of GAP.

Stage Three Involves Oxidoreduction Reactions and the Synthesis of ATP

The first reaction of the last stage of glycolysis (Figure 7.6c) is catalyzed by **glyceraldehyde-3-phosphate dehydrogenase** (Step 6). This reaction is of considerable interest because of what is accomplished in a single enzyme-catalyzed step. An aldehyde (glyceraldehyde 3-phosphate) is oxidized to a carboxylic acid with the reduction of NAD^+ to NADH . In addition to NADH , the reaction produces 1,3-bisphosphoglycerate, a mixed anhydride of a carboxylic acid and phosphoric acid. 1,3-Bisphosphoglycerate has a large negative free energy of hydrolysis, enabling it to participate in a subsequent reaction that yields ATP. The overall reaction catalyzed by glyceraldehyde-3-phosphate dehydrogenase can be visualized as the coupling of a very favorable exergonic reaction with an unfavorable endergonic reaction. The exergonic reaction can be thought of as being composed of a half-reaction in which an aldehyde is oxidized to a carboxylic acid, which is then coupled with a half-reaction in which NAD^+ is reduced to NADH :

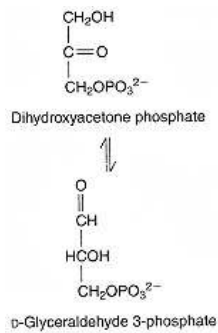

Step 5

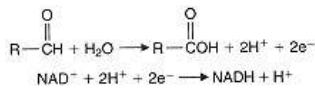

The overall reaction (sum of the half-reactions) is quite exergonic, with the aldehyde being oxidized to a carboxylic acid and NAD^+ being reduced to NADH :



The endergonic component of the reaction corresponds to the formation of a mixed anhydride between the carboxylic acid and phosphoric acid:

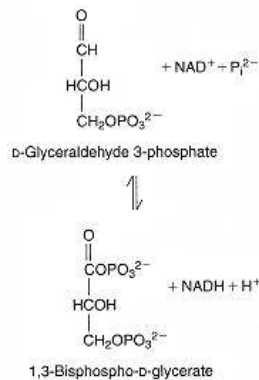
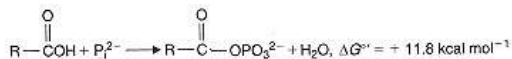

Step 6

The overall reaction involves coupling of the endergonic and exergonic components to give an overall standard free-energy change of $+1.5 \text{ kcal mol}^{-1}$.

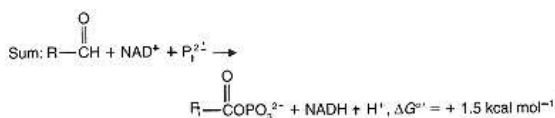

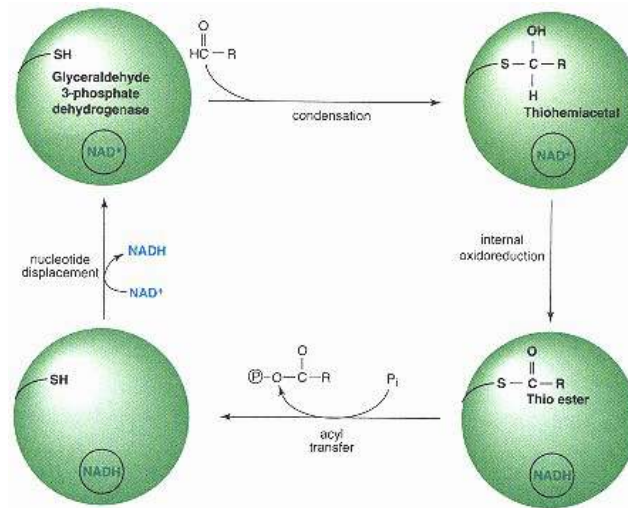
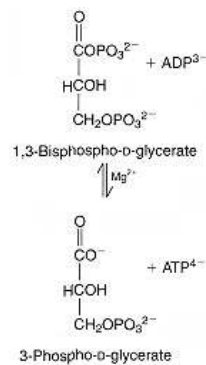

Figure 7.7
Mechanism of action of glyceraldehyde-3-phosphate dehydrogenase.
 Large sphere represents the enzyme; small circle, the binding site for NAD^+ ;
 RCH_2CHO , glyceraldehyde 3-phosphate; $-\text{SH}$, the sulfhydryl group of the cysteine residue located at the active site; and $\sim\text{P}$, the high-energy phosphate bond of 1,3-bisphosphoglycerate.

The reaction is freely reversible in cells and is used in both the glycolytic and gluconeogenic pathways. The proposed mechanism for the enzyme-catalyzed reaction is shown in Figure 7.7. Glyceraldehyde 3-phosphate reacts with a sulfhydryl group of a cysteine residue of the enzyme to generate a thiohemiacetal. An internal oxidation-reduction reaction occurs in which bound NAD^+ is reduced to NADH and the thiohemiacetal is oxidized to give a high-energy thiol ester. The high-energy thiol ester reacts with P_i to form the mixed anhydride and regenerate the free sulfhydryl group. The mixed anhydride dissociates from the enzyme. Exogenous NAD^+ then replaces the bound NADH . Note that a carboxylic acid (RCOOH) is not an intermediate in the actual reaction. Instead, the enzyme generates a high-energy thiol ester, which is converted into another high-energy compound, a mixed anhydride of carboxylic and phosphoric acids.

The reaction catalyzed by glyceraldehyde-3-phosphate dehydrogenase requires NAD^+ and produces NADH . Since the cytosol has only a limited amount of NAD^+ , it is imperative for continuous glycolytic activity that the NADH be reoxidized to NAD^+ , otherwise glycolysis will stop for want of NAD^+ . The options that cells have for accomplishing the regeneration of NAD^+ are considered later (see p. 281).



Step 7

The next reaction, catalyzed by **phosphoglycerate kinase**, produces ATP from the high-energy compound 1,3-bisphosphoglycerate (Figure 7.6c; Step 7). This is the first site of ATP production in the glycolytic pathway. Because two ATP molecules were invested for each glucose molecule in the priming stage, and because two molecules of 1,3-bisphosphoglycerate are produced from each glucose, all of the ATP "invested" in the priming stage is recovered in this step of glycolysis. Since ATP production occurs in the forward direction and ATP utilization in the reverse direction, it may seem surprising that the reaction is freely reversible and can be used in both the glycolytic and gluconeogenic pathways. The reaction provides a means for the generation of ATP in the glycolytic pathway but, when needed for glucose synthesis, can also be used in the reverse direction for the synthesis of 1,3-bisphosphoglycerate at the expense of ATP. The glyceraldehyde-3-phosphate dehydrogenase-phosphoglycerate kinase system is an example of **substrate-level phosphorylation**.

lation, a term used for a process in which a substrate participates in an enzyme-catalyzed reaction that yields ATP or GTP. Substrate-level phosphorylation stands in contrast to mitochondrial oxidative phosphorylation (see Chapter 6). Note, however, that the combination of the reactions catalyzed by glyceraldehyde-3-phosphate dehydrogenase and phosphoglycerate kinase accomplishes the coupling of an oxidation (an aldehyde goes to a carboxylic acid) to a phosphorylation.

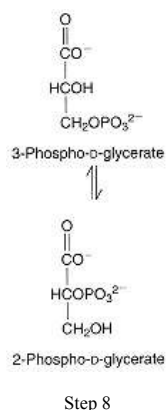

Phosphoglycerate mutase converts 3-phosphoglycerate to 2-phosphoglycerate (Step 8). This is a freely reversible reaction in which 2,3-bisphosphoglycerate (or 2,3-diphosphoglycerate) functions as an obligatory intermediate at the active site of the enzyme (E):

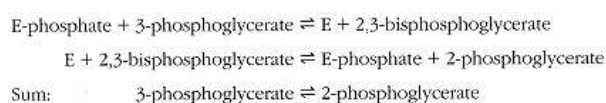

The involvement of 2,3-bisphosphoglycerate as an intermediate creates an absolute requirement for the presence of a catalytic amount of this compound in cells. This can be appreciated by noting that E-phosphate in this reaction cannot be generated without 2,3-bisphosphoglycerate. Cells synthesize 2,3-bisphosphoglycerate, independent of the reaction catalyzed by phosphoglycerate mutase, by a reaction catalyzed by 2,3-bisphosphoglycerate mutase:

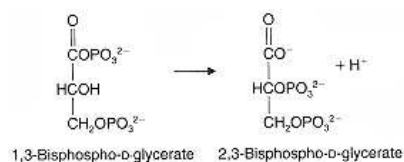

The mutase is unusual in that it is a bifunctional enzyme, serving also as a phosphatase that converts 2,3-bisphosphoglycerate to 3-phosphoglycerate and P_i . All cells contain at least minute quantities of 2,3-bisphosphoglycerate for no apparent purpose other than to produce the phosphorylated form of newly synthesized phosphoglycerate mutase. The amounts needed are small because phosphoglycerate mutase has to be phosphorylated only once, the phosphorylated enzyme being regenerated during each reaction cycle. Red blood cells contain very high 2,3-bisphosphoglycerate concentrations because it serves as an important allosteric effector of the association of oxygen with the hemoglobin (see Chapter 25). From 15% to 25% of the glucose converted to lactate in red blood cells goes by way of the "**BPG shunt**" (Figure 7.8). Catabolism of glucose by the BPG shunt generates no net ATP since the reaction catalyzed by the phosphoglycerate kinase is bypassed.

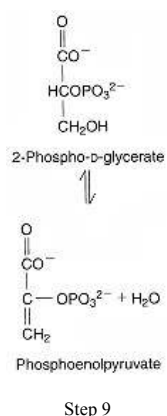

Enolase catalyzes elimination of water from 2-phosphoglycerate to form phosphoenolpyruvate (PEP) in the next reaction (Step 9; Figure 7.6c). This is a remarkable reaction from the standpoint that a high-energy phosphate compound is generated from one of markedly lower energy level. The standard free-energy change (ΔG°) for the hydrolysis of phosphoenolpyruvate is $-14.8 \text{ kcal mol}^{-1}$, a much greater value than the standard free energy for 2-phosphoglycerate hydrolysis ($-4.2 \text{ kcal mol}^{-1}$). Although the reaction catalyzed by enolase is freely reversible, a large change in the distribution of energy occurs as a consequence of its action on 2-phosphoglycerate. The free-energy levels of PEP and 2-phosphoglycerate are not markedly different; however, the free-energy levels of their products of hydrolysis (pyruvate and glycerate, respectively) are quite different. Since $\Delta G^{\circ f} = \Delta G_{\text{products}}^{\circ f} - G_{\text{substrates}}^{\circ f}$, this accounts for the marked differences in the standard free energy of hydrolysis of these two compounds.

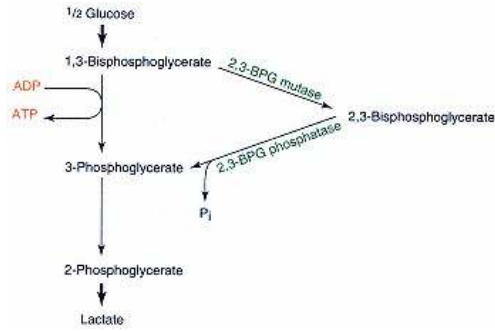
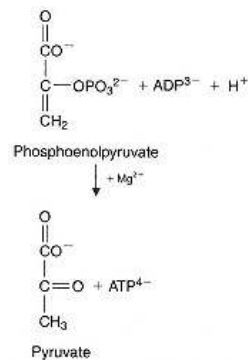

Figure 7.8

The 2,3-bisphosphoglycerate (2,3-BPG) shunt consists of reactions catalyzed by the bifunctional enzyme, 2,3-BPG mutase/phosphatase.

Pyruvate kinase (Step 10; Figure 7.6c) accomplishes another **substrate-level phosphorylation**: that is, the synthesis of ATP with the conversion of the high-energy compound PEP into pyruvate. It constitutes a way to synthesize ATP but, in contrast to the phosphoglycerate kinase reaction, is not reversible under conditions that exist in cells and cannot be used for the synthesis of PEP when needed for glucose synthesis.



Step 10

The last step of the glycolytic pathway is an oxidoreduction reaction catalyzed by **lactate dehydrogenase** (Step 11; Figure 7.6c). Pyruvate is reduced to give L-lactate and NADH is oxidized to NAD⁺. This is a freely reversible reaction and the only reaction that can result in L-lactate formation or L-lactate utilization.

**A Balance of Reduction of NAD⁺ and Reoxidation of NADH Is Required:
Role of Lactate Dehydrogenase**

There is a perfect coupling between the generation of NADH and its utilization in glycolysis (Figure 7.6c). Two molecules of NADH are generated at the level of glyceraldehyde-3-phosphate dehydrogenase and two molecules of NADH are utilized by lactate dehydrogenase in the conversion of one molecule of glucose into two molecules of lactate. NAD⁺, a soluble molecule present in the cytosol, is available in only limited amounts and must be regenerated from NADH for glycolysis to continue unabated. The overall reaction catalyzed by the combined actions of glyceraldehyde-3-phosphate dehydrogenase and lactate dehydrogenase is the conversion of pyruvate, glyceraldehyde 3-phosphate, and P_i into lactate and 1,3-bisphosphoglycerate. The two reactions are

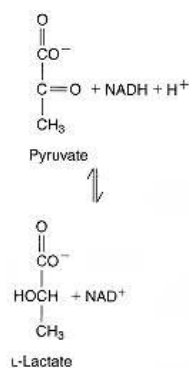

Step 11

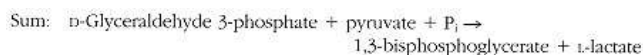
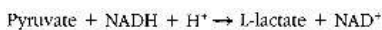
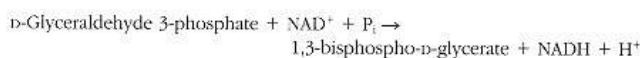

This perfect coupling of reducing equivalents in the glycolytic pathway has to occur under conditions of anaerobiosis or in cells that lack mitochondria. With the availability of oxygen and mitochondria, reducing equivalents in the form of NADH generated at the level of glyceraldehyde-3-phosphate dehydrogenase can be shuttled into the mitochondria for the synthesis of ATP, leaving pyruvate rather than lactate as the end product of glycolysis. Two shuttle systems are

known to exist for the transport of reducing equivalents from the cytosolic space to the mitochondrial matrix space (mitosol). The mitochondrial inner membrane is not permeable to NADH.

NADH Generated during Glycolysis Can Be Reoxidized Via Substrate Shuttle Systems

The **glycerol phosphate shuttle** is shown in Figure 7.9a and the **malate–aspartate shuttle** in Figure 7.9b. Tissues with cells that contain mitochondria have the capability of shuttling reducing equivalents from the cytosol to the mitosol. The relative proportion of the activities of the two shuttles varies from tissue to tissue, with liver making greater use of the malate–aspartate shuttle, whereas some muscle cells may be more dependent on the glycerol phosphate shuttle. The shuttle systems are irreversible; that is, they represent mechanisms for moving reducing equivalents into the mitosol, but not mechanisms for moving mitochondrial reducing equivalents into the cytosol.

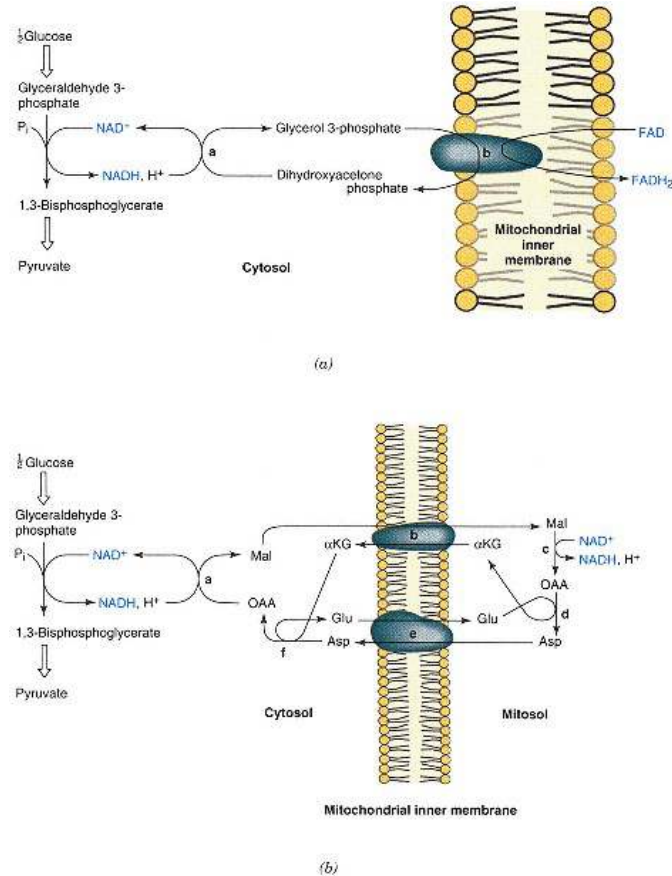

Figure 7.9

Shuttles for the transport of reducing equivalents from the cytosol to the mitochondrial electron-transfer chain.

(a) Glycerol phosphate shuttle: a, cytosolic glycerol 3-phosphate dehydrogenase oxidizes NADH; b, mitochondrial glycerol-3-phosphate dehydrogenase of the outer surface of the inner membrane reduces FAD.

(b) Malate–aspartate shuttle: a, cytosolic malate dehydrogenase reduces oxaloacetate (OAA) to malate; b, dicarboxylic acid antiport of the mitochondrial inner membrane catalyzes electrically silent exchange of malate for α -ketoglutarate (α -KG); c, mitochondrial malate dehydrogenase produces intramitochondrial NADH; d, mitochondrial aspartate aminotransferase transaminates glutamate and oxaloacetate; e, glutamate–aspartate antiport of the mitochondrial inner membrane catalyzes electrogenic exchange of glutamate for aspartate; f, cytosolic aspartate aminotransferase transaminates aspartate and α -ketoglutarate.

The transport of aspartate out of mitochondria in exchange for glutamate is the irreversible step in the malate–aspartate shuttle. The mitochondrial inner membrane has a large number of transport systems (see Chapter 6) but lacks one that is effective for oxaloacetate. For this reason oxaloacetate transaminates with glutamate to produce aspartate, which then exits irreversibly from the mitochondrion in exchange for glutamate. The aspartate entering the cytosol transaminates with α -ketoglutarate to give oxaloacetate and glutamate. The oxaloacetate accepts the reducing equivalents of NADH and becomes malate. Malate then penetrates the mitochondrial inner membrane, where it is oxidized by the mitochondrial **malate dehydrogenase**. This produces NADH within the mitosol and regenerates oxaloacetate to complete the cycle. The overall balanced equation for the sum of all the reactions of the malate–aspartate shuttle is simply

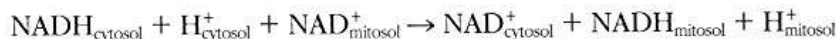

The glycerol phosphate shuttle is simpler, in the sense that fewer reactions are involved, but FADH_2 is generated within the mitochondrial inner membrane rather than NADH within the mitosolic compartment. The irreversible step of the shuttle is catalyzed by the mitochondrial **glycerol-3-phosphate dehydrogenase**. The active site of this enzyme is exposed on the cytosolic surface of the mitochondrial inner membrane, making it unnecessary for glycerol 3-phosphate to penetrate into the mitosol for oxidation. The overall balanced equation for the sum of the reactions of the glycerol phosphate shuttle is



Shuttles Are Important in Other Oxidoreductive Pathways

Alcohol Oxidation

The first step of **alcohol** (i.e., ethanol) metabolism is its oxidation to **acetaldehyde** with production of NADH by **alcohol dehydrogenase**.

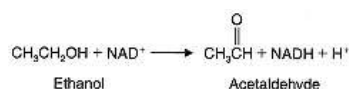

This enzyme is located almost exclusively in the cytosol of liver parenchymal cells. The acetaldehyde generated traverses the mitochondrial inner membrane for oxidation by a mitosolic **aldehyde dehydrogenase**.

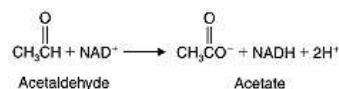

The NADH generated by the last step can be used directly by the mitochondrial electron-transfer chain. However, NADH generated by cytosolic alcohol dehydrogenase must be oxidized back to NAD^+ by one of the shuttles. Thus the capacity of a human being to oxidize alcohol is dependent on the ability of the liver to transport reducing equivalents from the cytosol to the mitosol by these shuttle systems.

Glucuronide Formation

The shuttles play an important role in the formation of water-soluble **glucuronides** of bilirubin and various drugs (see p. 1018) so that these compounds can be eliminated from the body in the urine and bile. In this process **UDP-glucose** (structure on p. 343) is oxidized to **UDP-glucuronic acid** (structure on p. 344).



CLINICAL CORRELATION 7.1**Alcohol and Barbiturates**

Acute alcohol intoxication causes increased sensitivity of an individual to the general depressant effects of barbiturates. Barbiturates and alcohol both interact with the γ -aminobutyrate (GABA)-activated chloride channel. Activation of the chloride channel inhibits neuronal firing, which may explain the depressant effects of both compounds. This drug combination is very dangerous and normal prescription doses of barbiturates have potentially lethal consequences in the presence of ethanol. In addition to the depressant effects of both ethanol and barbiturates on the central nervous system (CNS), ethanol inhibits the metabolism of barbiturates, thereby prolonging the time barbiturates remain effective in the body. Hydroxylation of barbiturates by the endoplasmic reticulum of the liver is inhibited by ethanol. This reaction, catalyzed by the NADPH-dependent cytochrome system, forms water-soluble derivatives of the barbiturates that are eliminated readily from the circulation by the kidneys. Blood levels of barbiturates remain high when ethanol is present, causing increased CNS depression.

Surprisingly, the alcoholic when sober is less sensitive to barbiturates. Chronic ethanol consumption apparently causes adaptive changes in the sensitivity of the CNS to barbiturates (cross-tolerance). It also results in the induction of the enzymes of liver endoplasmic reticulum involved in drug hydroxylation reactions. Consequently, the sober alcoholic is able to metabolize barbiturates more rapidly. This sets up the following scenario. A sober alcoholic has trouble falling asleep, even after taking several sleeping pills, because his/her liver has increased capacity to hydroxylate the barbiturate contained in the pills. In frustration he/she consumes more pills and then alcohol. Sleep results, but may be followed by respiratory depression and death because the alcoholic, although less sensitive to barbiturates when sober, remains sensitive to the synergistic effect of alcohol.

Misra, P. S., Lefevre, A., Ishii, H., Rubin, E., and Lieber, C. S. Increase of ethanol, meprobamate and pentobarbital metabolism after chronic ethanol administration in man and in rats. *Am. J. Med.* 51:346, 1971.

In a reaction that occurs primarily in the liver, the "activated" glucuronic acid molecule is then transferred to a nonpolar acceptor molecule, such as **bilirubin** or a compound foreign to the body:

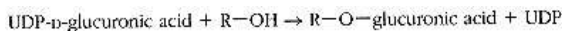

Excess NADH generated by the first reaction has to be reoxidized by the shuttles for this process to continue. Since ethanol oxidation and drug conjugation are properties of the liver, the two of them occurring together may overwhelm the combined capacity of the shuttles. A good thing to tell patients is not to mix the intake of pharmacologically active compounds and alcohol (see Clin. Corr. 7.1).

Two Shuttle Pathways Yield Different Amounts of ATP

The mitosomal NADH formed by the malate-aspartate shuttle activity can be used by the mitochondrial respiratory chain for the production of three molecules of ATP by oxidative phosphorylation:

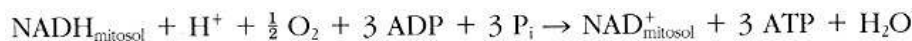

In contrast, the FADH_2 obtained by the glycerol phosphate shuttle yields only two ATP molecules:

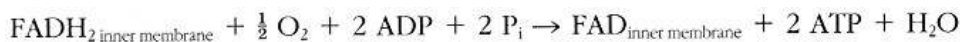

Without the intervention of the shuttle systems, conversion of one molecule of glucose to two molecules of lactate by glycolysis results in the net formation of two molecules of ATP. Two molecules of ATP are used in the priming stage to set glucose up so that it can be cleaved. However, subsequent steps then yield four molecules of ATP so that the overall net production of ATP by the glycolytic pathway is two molecules of ATP. Biological cells have only a limited amount of ADP and P_i . Therefore flux through the glycolytic pathway is also dependent on an adequate supply of these substrates. If the ATP is not utilized for performance of work, glycolysis will stop for want of ADP and/or P_i . Consequently, the ATP generated has to be used, that is, turned over, in normal work-related processes in order for glycolysis to occur. The equation for the use of ATP for any work-related process is simply

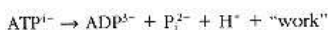

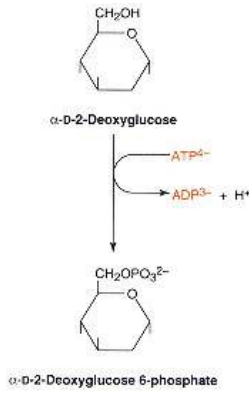

Figure 7.10
Hexokinase catalyzes the phosphorylation of 2-deoxyglucose.

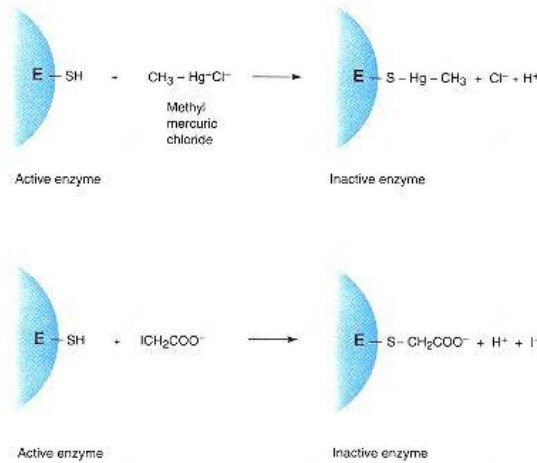
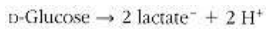

Figure 7.11
Mechanism responsible for inactivation of glyceraldehyde-3-phosphate dehydrogenase by sulfhydryl reagents.

When this equation is added to that given above for glycolysis, excluding the work accomplished, the overall balanced equation becomes



Glycolysis Can Be Inhibited at Different Stages

The best known inhibitors of the glycolytic pathway are **2-deoxyglucose**, sulfhydryl reagents, and **fluoride**. 2-Deoxyglucose is a substrate for hexokinase, being converted to its 6-phosphate ester (Figure 7.10). Like glucose 6-phosphate, 2-deoxyglucose 6-phosphate is an effective inhibitor of the reaction catalyzed by hexokinase but, unlike glucose 6-phosphate, will not function as a substrate for the reaction catalyzed by phosphoglucose isomerase. Thus it will accumulate in cells.

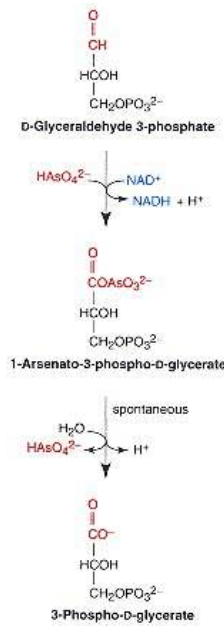

Figure 7.12
Arsenate uncouples oxidation from phosphorylation at the step catalyzed by glyceraldehyde-3-phosphate dehydrogenase.

Sulfhydryl reagents inhibit **glyceraldehyde-3-phosphate dehydrogenase**. This enzyme has a cysteine residue at the active site. The sulfhydryl group combines with glyceraldehyde 3-phosphate to give a thiohemiacetal (Figure 7.7). Sulfhydryl reagents are usually mercury-containing compounds or alkylating compounds, such as **iodoacetate**, which readily react with the sulfhydryl group of glyceraldehyde-3-phosphate dehydrogenase to prevent the formation of the thiohemiacetal (Figure 7.11).

Fluoride is a potent inhibitor of enolase. Mg^{2+} and P_i form an ionic complex with fluoride ion, which is responsible for inhibition of enolase by interfering with binding of its substrate (Mg^{2+} 2-phosphoglycerate).

Pentavalent arsenic or arsenate is special with respect to its effects on glycolysis. It is not an inhibitor of the process, and under some conditions can even stimulate glycolytic flux. Arsenate prevents net synthesis of ATP by causing arsenolysis in the glyceraldehyde-3-phosphate dehydrogenase reaction. Arsenate looks like P_i and is able to substitute for P_i in enzyme-catalyzed reactions. The result is the formation of a mixed anhydride of arsenic acid and the carboxyl group of 3-phosphoglycerate during the reaction catalyzed by glyceraldehyde-3-phosphate dehydrogenase (Figure 7.12). 1-Arsenato 3-phosphoglycerate is

unstable, undergoing spontaneous hydrolysis to give 3-phosphoglycerate and inorganic arsenate. Hence glycolysis continues unabated in the presence of arsenate, but 1,3-bisphosphoglycerate is not formed, resulting in the loss of the capacity to synthesize ATP at the step catalyzed by phosphoglycerate kinase. Thus net ATP synthesis does not occur when glycolysis is carried out in the presence of arsenate, the ATP invested in the priming stage being balanced by the ATP generated in the pyruvate kinase step. This, along with the fact that **arsenolysis** also interferes with ATP formation by oxidative phosphorylation, makes arsenate a toxic compound (see Clin. Corr. 7.2).

CLINICAL CORRELATION 7.2

Arsenic Poisoning

Most forms of arsenic are toxic, but the trivalent form (arsenite as AsO_2^-) is much more toxic than the pentavalent form (arsenate or HAsO_4^{2-}). Less ATP is produced whenever arsenate substitutes for P_i in biological reactions. Arsenate competes for P_i -binding sites on enzymes, resulting in the formation of arsenate esters that are unstable. Arsenite works by a completely different mechanism, involving the formation of a stable complex with enzyme-bound lipoic acid:

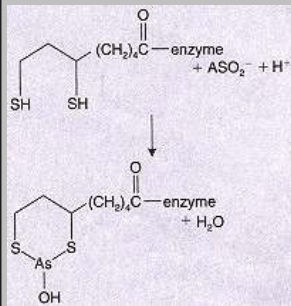

For the most part arsenic poisoning is explained by inhibition of those enzymes that require lipoic acid as a coenzyme. These include pyruvate dehydrogenase, α -ketoglutarate dehydrogenase, and branched-chain α -keto acid dehydrogenase. Chronic arsenic poisoning from well water contaminated with arsenical pesticides or through the efforts of a murderer is best diagnosed by determining the concentration of arsenic in the hair or fingernails of the victim. About 0.5 mg of arsenic would be found in a kilogram of hair from a normal individual. The hair of a person chronically exposed to arsenic could have 100 times as much.

Hindmarsh, J. T., and McCurdy, R. F. Clinical and environmental aspects of arsenic toxicity. *CRC Crit. Rev. Clin. Lab. Sci.* 23:315, 1986.

7.4— Regulation of the Glycolytic Pathway

The regulatory enzymes of the glycolytic pathway are **hexokinase**, **6-phosphofructo-1-kinase**, and **pyruvate kinase**. A summary of the important regulatory features of these enzymes is presented in Figure 7.13. A regulatory enzyme is controlled by either allosteric effectors or covalent modification (see p. 151). Both mechanisms are used by cells to control the most important of the regulatory enzymes. A regulatory enzyme can often be identified by determining whether the concentrations of the substrates and products within a cell indicate that the reaction catalyzed by the enzyme is close to equilibrium. An enzyme

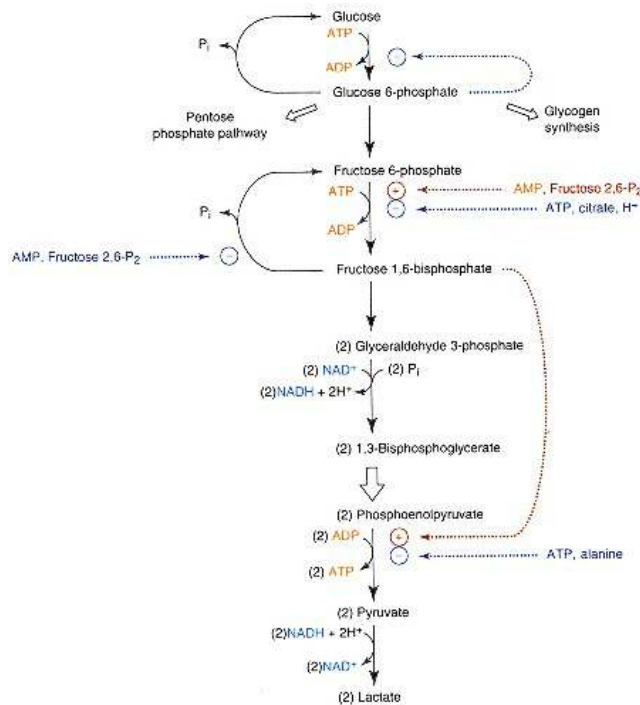

Figure 7.13
Important regulatory features of the glycolytic pathway.
 Because of differences in isoenzyme distribution, not all tissues of the body have all of the regulatory mechanisms shown here.

that is not subject to regulation will catalyze a "**near-equilibrium reaction**," whereas a regulatory enzyme will catalyze a "**nonequilibrium reaction**" under intracellular conditions. This makes sense because flux through the regulated enzyme is restricted by controls imposed on that enzyme. A nonregulatory enzyme is so active that it readily brings its substrates and products to equilibrium concentrations. Whether an enzyme-catalyzed reaction is near equilibrium or nonequilibrium can be determined by comparing the established equilibrium constant for the reaction with the mass-action ratio as it exists within a cell. The **equilibrium constant** for the reaction $A + B \rightleftharpoons C + D$ is defined as

$$K_{eq} = \frac{[C][D]}{[A][B]}$$

where the brackets indicate the concentrations at equilibrium. The **mass-action ratio** is calculated in a similar manner, except that the steady-state (ss) concentrations of reactants and products within the cell are used in the equation:

$$\text{Mass-action ratio} = \frac{[C]_{ss}[D]_{ss}}{[A]_{ss}[B]_{ss}}$$

If the mass-action ratio is approximately equal to the K_{eq} , the enzyme is said to be active enough to catalyze a near-equilibrium reaction and the enzyme is not considered subject to regulation. When the mass-action ratio is considerably different from the K_{eq} , the enzyme is said to catalyze a nonequilibrium reaction and usually will be found subject to regulation by one or more mechanisms. Mass-action ratios and equilibrium constants are compared for the glycolytic enzymes of liver in Table 7.1. The reactions catalyzed by **glucokinase** (liver isoenzyme of hexokinase), 6-phosphofructo-1-kinase, and pyruvate kinase in the intact liver are considered far enough from equilibrium to indicate that these enzymes are "regulatory" in this tissue.

Hexokinase and Glucokinase Have Different Properties

Different isoenzymes of **hexokinase** occur in different tissues. The hexokinase isoenzymes found in most tissues have a low K_m for glucose (<0.1 mM) relative

TABLE 7.1 Apparent Equilibrium Constants and Mass-Action Ratios for the Reactions of Glycolysis and Gluconeogenesis in Liver

Reaction Catalyzed by	Reaction in the Pathway of		Apparent Equilibrium Constant (K'_{eq})	Mass-Action Ratios	Considered Near-Equilibrium Reaction?
	Glycolysis	Gluconeogenesis			
Glucokinase	Yes	No	2×10^3	0.02	No
Glucose 6-phosphatase	No	Yes	850 M	120 M	No
Phosphoglucoisomerase	Yes	Yes	0.36	0.31	Yes
6-Phosphofructo-1-kinase	Yes	No	1×10^3	0.09	No
Fructose 1,6-bisphosphatase	No	Yes	530 M	19 M	No
Aldolase	Yes	Yes	13×10^{-5} M	12×10^{-7} M	Yes ^a
Glyceraldehyde-3-phosphate dehydrogenase + phosphoglycerate kinase	Yes	Yes	2×10^3 M ⁻¹	0.6×10^3 M ⁻¹	Yes
Phosphoglycerate mutase	Yes	Yes	0.1	0.1	Yes
Enolase	Yes	Yes	3.0	2.9	Yes
Pyruvate kinase	Yes	No	2×10^4	0.7	No
Pyruvate carboxylase + phosphoenolpyruvate carboxykinase	No	Yes	7.0 M	1×10^{-3} M	No

^a Reaction catalyzed by aldolase appears to be out of equilibrium by two orders of magnitude. However, *in vivo* concentrations of fructose 1,6-micromolar bisphosphate and glyceraldehyde 3-phosphate are so low (micromolar concentration range) that significant enzyme binding of both metabolites is believed to occur. Although only the total concentration of any metabolite of a tissue can be measured, only that portion of the metabolite that is not bound should be used in the calculations of mass-action ratios. This is usually not possible, introducing uncertainty in the comparison of *in vitro* equilibrium constants to *in vivo* mass-action ratios.

CLINICAL CORRELATION 7.3

Fructose Intolerance

Patients with hereditary fructose intolerance are deficient in the liver aldolase responsible for splitting fructose 1-phosphate into dihydroxyacetone phosphate and glyceraldehyde. Consumption of fructose by these patients results in the accumulation of fructose 1-phosphate and depletion of P_i and ATP in the liver. The reactions involved are those catalyzed by fructokinase and the enzymes of oxidative phosphorylation:

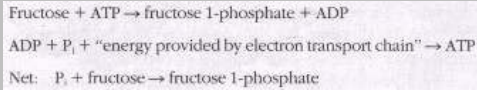

Tying up P_i in the form of fructose 1-phosphate makes it impossible for liver mitochondria to generate ATP by oxidative phosphorylation. The ATP levels fall precipitously, making it also impossible for the liver to carry out its normal work functions. Damage results to the cells in large part because they are unable to maintain normal ion gradients by means of the ATP-dependent cation pumps. The cells swell and eventually lose their internal contents by osmotic lysis (see Clin. Corr. 6.6).

Although patients with fructose intolerance are particularly sensitive to fructose, humans in general have a limited capacity to handle this sugar. The capacity of the normal liver to phosphorylate fructose greatly exceeds its capacity to split fructose 1-phosphate. This means that fructose use by the liver is poorly controlled and that excessive fructose could deplete the liver of P_i and ATP. Fructose was actually tried briefly in hospitals as a substitute for glucose in patients being maintained by parenteral nutrition. The rationale was that fructose would be a better source of calories than glucose because fructose utilization is relatively independent of the insulin status of a patient. Delivery of large amounts of fructose by intravenous feeding was soon found to result in severe liver damage. Similar attempts have been made to substitute sorbitol and xylitol for glucose. These sugars also tend to deplete the liver of ATP and, like fructose, should not be used for parenteral nutrition.

Gitzelmann, R., Steinmann, B., and Van den Berghe, G. Disorders of fructose metabolism. In: C. R. Scriver, A. L. Beaudet, W. S. Sly, and D. Valle (Eds.), *The Metabolic and Molecular Bases of Inherited Disease*, 7th ed. New York: McGraw-Hill, 1995, pp. 905–934.

to its concentration in blood (~5 mM) and are strongly inhibited by the product of the reaction, glucose 6-phosphate. The latter is an important regulatory feature because it prevents hexokinase from tying up all of the P_i of a cell in the form of phosphorylated hexoses (see Clin. Corr. 7.3). Thus the reaction catalyzed by hexokinase may not be at equilibrium within cells that contain this enzyme because of the inhibition imposed by G6P. Liver parenchymal cells are unique in that they contain glucokinase, an isoenzyme of hexokinase with strikingly different kinetic properties from the other hexokinases. This isoenzyme catalyzes an ATP-dependent phosphorylation of glucose but has a much higher K_m for glucose and is not subject to product inhibition by G6P. It is, however, inhibited by fructose 6-phosphate and activated by fructose 1-phosphate. These effects depend on an inhibitory protein that inhibits by binding tightly to glucokinase. Fructose 6-phosphate promotes but fructose 1-phosphate inhibits binding of the inhibitory protein to glucokinase. The high K_m of glucokinase for glucose contributes to the capacity of the liver to "buffer" blood glucose levels. Glucose equilibrates readily across the plasma membrane of the liver on the glucose transport protein GLUT-2, the concentration of glucose within the liver reflecting that of the blood. Since the K_m of glucokinase for glucose (~mM) is considerably greater than normal blood glucose concentrations (~5 mM), any increase in glucose concentration leads to a proportional increase in the rate of glucose phosphorylation by glucokinase (Figure 7.14). Likewise, any decrease in glucose concentration leads to a proportional decrease in the rate of glucose phosphorylation. Thus liver uses glucose at a significant rate only when blood glucose levels are greatly elevated. This buffering effect of liver glucokinase on blood glucose levels would not occur if glucokinase had the low K_m for glucose characteristic of other hexokinases and was therefore completely saturated at physiological concentrations of glucose (Figure 7.14). On the other hand, a low K_m form of hexokinase is a good choice for tissues such as the brain in that it allows phosphorylation of glucose even when blood and tissue glucose concentrations are dangerously low.

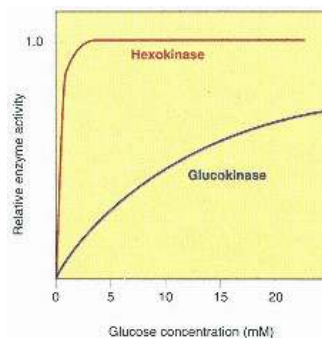

Figure 7.14
Comparison of the substrate saturation curves for hexokinase and glucokinase.

The reaction catalyzed by glucokinase is not at equilibrium under the intracellular conditions of liver cells (Table 7.1). Part of the explanation lies in the rate restriction imposed by the high K_m of glucokinase for glucose and part

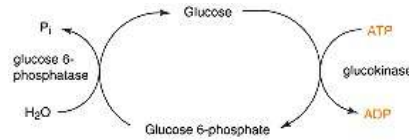

Figure 7.15
Phosphorylation of glucose followed by dephosphorylation constitutes a futile cycle in parenchymal cells of the liver.

is due to the inhibitory protein mentioned above. Yet another important factor is that the activity of glucokinase is opposed in liver by that of **glucose 6-phosphatase**. Like glucokinase, this enzyme has a high K_m (3 mM) with respect to the normal intracellular concentration (~0.2 mM) of its primary substrate, glucose 6-phosphate. Thus the flux through this step is almost directly proportional to the intracellular concentration of glucose 6-phosphate. As shown in Figure 7.15, the combined action of glucokinase and glucose 6-phosphatase constitutes a futile cycle; that is, the sum of their reactions is hydrolysis of ATP to give ADP and P_i without the performance of any work. When blood glucose concentrations are about 5 mM, the activity of glucokinase is almost exactly balanced by the opposing activity of glucose 6-phosphatase. The result is that no net flux occurs in either direction. This futile cycling between glucose and glucose 6-phosphate is wasteful of ATP but, combined with the process of gluconeogenesis, contributes significantly to the "buffering" action of the liver on blood glucose levels. Furthermore, it provides a mechanism for preventing glucokinase from tying up all of the P_i of the liver (see Clin. Corr. 7.3).

Fructose, a component of many vegetables, fruits, and sweeteners, promotes hepatic glucose utilization by an indirect mechanism. It is converted in liver to fructose 1-phosphate (see Clin. Corr. 7.3), which activates glucokinase activity by promoting dissociation of the inhibitory protein. This may be a factor in the adverse effects (e.g., **hypertriglyceridemia**) sometimes associated with excessive dietary fructose consumption.

Glucokinase is an inducible enzyme. Under various physiological conditions the amount of the enzyme protein increases or decreases. Induction of synthesis and repression of synthesis of an enzyme are relatively slow processes, usually requiring several hours before significant changes occur. **Insulin** increases the amount of glucokinase by promoting transcription of the glucokinase gene. An increase in blood glucose levels signals an increase in insulin release from the β cells of the pancreas. This results in an increase in blood insulin levels, which promotes transcription of the glucokinase gene and increases the amount of liver glucokinase enzyme protein. Thus the amount of glucokinase in liver reflects how much glucose is being delivered to the liver via the portal vein. In other words, a person consuming large meals rich in carbohydrate will have greater amounts of glucokinase in the liver than one who is not. The liver in which glucokinase has been induced can make a greater contribution to the lowering of elevated blood glucose levels. The absence of insulin makes the liver of the diabetic patient deficient in glucokinase, in spite of high blood glucose levels, and this is one of the reasons why the liver of the diabetic has less blood glucose "buffering" action (see Clin. Corr. 7.4).

6-Phosphofructo-1-kinase Is the Major Regulatory Site

Evidence suggests that **6-phosphofructo-1-kinase** is the rate-limiting enzyme and most important regulatory site of glycolysis in most tissues. Usually we think of the first step of a pathway as the most logical choice for the rate-limiting step. However, the first committed step of a pathway is most appropriate for the site of the greatest degree of control, and 6-phosphofructo-1-kinase catalyzes the first committed step of the glycolytic pathway. The phosphoglucose isomerase catalyzed reaction is reversible, and most cells can use glucose

CLINICAL CORRELATION 7.4

Diabetes Mellitus

Diabetes mellitus is a chronic disease characterized by derangements in carbohydrate, fat, and protein metabolism. Two major types are recognized clinically—the juvenile-onset or insulin-dependent type (see Clin. Corr. 14.7) and the maturity-onset or insulin-independent type (see Clin. Corr. 14.8).

In patients who do not have fasting hyperglycemia, the oral glucose tolerance test can be used for the diagnosis of diabetes. It consists of determining the blood glucose level in the fasting state and at intervals of 30–60 min for 2 h or more after consuming a 100-g carbohydrate meal. In a normal individual blood glucose returns to normal levels within 2 h after ingestion of the carbohydrate meal. In the diabetic patient, blood glucose will reach a higher level and remain elevated for longer periods of time, depending on the severity of the disease. However, many factors may contribute to an abnormal glucose tolerance test. The patient must have consumed a high carbohydrate diet for the preceding 3 days, presumably to allow for induction of enzymes of glucose-utilizing pathways, for example, glucokinase, fatty acid synthase, and acetyl-CoA carboxylase. In addition, almost any infection (even a cold) and less well-defined "stress" (presumably by effects on the sympathetic nervous system) can result in (transient) abnormalities of the glucose tolerance test. Because of problems with the glucose tolerance test, elevation of the fasting glucose level should probably be the *sine qua non* for the diagnosis of diabetes.

Glucose uptake by cells of insulin-sensitive tissues, that is, muscle and adipose, is decreased in the diabetic state. Insulin is required for glucose uptake by these tissues, and the diabetic patient either lacks insulin or has developed "insulin resistance" in these tissues. Resistance to insulin is an abnormality of the insulin receptor or in subsequent steps mediating the metabolic effects of insulin. Parenchymal cells of the liver do not require insulin for glucose uptake. Without insulin, however, the liver has diminished enzymatic capacity to remove glucose from the blood. This is explained in part by decreased glucokinase activity plus the loss of insulin's action on key enzymes of glycogenesis and the glycolytic pathway.

Taylor, S. I. Diabetes mellitus. In: C. R. Scriver, A. L. Beaudet, W. S. Sly, and D. Valle (Eds), *The Metabolic and Molecular Bases of Inherited Disease*, 7th ed. New York: McGraw-Hill, 1995, pp. 843–896.

6-phosphate for glycogen synthesis and in the pentose phosphate pathway. The reaction catalyzed by 6-phosphofructo-1-kinase commits the cell to the metabolism of glucose by glycolysis and is therefore a logical site for the step of the pathway that is rate limiting and subject to the greatest degree of regulation by allosteric effectors. Citrate, ATP, and hydrogen ions (low pH) are the most important negative allosteric effectors, whereas **AMP** and **fructose 2,6-bis-phosphate** are the most important positive allosteric effectors (Figure 7.13). Through their actions as strong inhibitors or activators of 6-phosphofructo-1-kinase, these compounds signal different rates of glycolysis in response to changes in (1) energy state of the cell (ATP and AMP), (2) internal environment of the cell (hydrogen ions), (3) availability of alternate fuels such as fatty acids and ketone bodies (citrate), and (4) insulin/glucagon ratio in the blood (fructose 2,6-bisphosphate). Evidence for the physiological importance of these effectors comes in part from application of the crossover theorem to the glycolytic pathway.

Crossover Theorem Explains Regulation of 6-Phosphofructo-1-kinase by ATP and AMP

For the hypothetical pathway $A \rightarrow B \rightarrow C \rightarrow D \rightarrow E \rightarrow F$, the **crossover theorem** proposes that an inhibitor that partially inhibits conversion of C to D will cause a "crossover" in the metabolite profile between C and D. Thus when the steady-state concentrations of intermediates in the presence and absence of an inhibitor are compared, the concentrations of intermediates before the site of inhibition should increase in response to the inhibitor, whereas those after the site should decrease. Crossover plots are constructed by setting the concentrations of all intermediates without some effector of the pathway equal to 100%. Concentrations of intermediates observed in the presence of the effector are then expressed as percentages of these values. The expected result with a negative effector is shown in Figure 7.16a. The effect of returning the perfused rat heart from an anoxic condition to a well-oxygenated state is also shown (Figure 7.16b). This transition with the perfused rat heart is known to

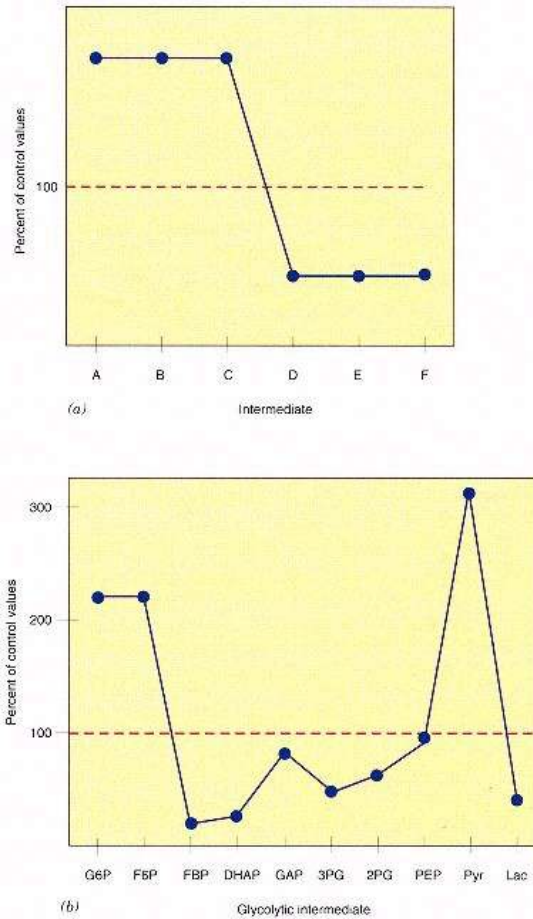

Figure 7.16
Crossover analysis is used to locate sites of regulation of a metabolic pathway.

(a) Theoretical effect of an inhibitor of the C to D step in the pathway of A B C D E F. Steady-state concentrations of all intermediates of the pathway without the inhibitor present are arbitrarily set equal to 100%. Steady-state concentrations of all intermediates when the inhibitor is present are then expressed as percentages of the control values.

(b) Effect of oxygen on the relative steady-state concentrations of the intermediates of the glycolytic pathway in the perfused rat heart. The changes in concentrations of metabolites caused by perfusion with oxygen are recorded as percentages of anoxic values. Oxygen strongly inhibits glucose utilization and lactate production under such conditions. The dramatic increase in pyruvate concentration occurs as a consequence of greatly increased utilization of cytosolic NADH by the shuttle systems. Abbreviations: G6P, glucose 6-phosphate; F6P, fructose 6-phosphate; FBP, fructose 1,6-bisphosphate; DHAP, dihydroxyacetone phosphate; GAP, glyceraldehyde 3-phosphate; 3PG, 3-phosphoglycerate; 2PG, 2-phosphoglycerate; PEP, phosphoenolpyruvate; Pyr, pyruvate; Lac, lactate.

Redrawn with permission from Williamson, J. R. *J. Biol. Chem.* 241:5026, 1966. © The American Society of Biological Chemists, Inc.

establish new steady-state concentrations of glycolytic intermediates, the flux being much greater through the glycolytic pathway in the absence of oxygen. Under the experimental conditions used, perfused hearts consumed glucose at rates some 20 times greater in the absence than in the presence of oxygen. This illustrates what is known as the **Pasteur effect**, defined as the inhibition of glucose utilization and lactate accumulation by the initiation of respiration (oxygen consumption). This is readily understandable on a thermodynamic basis, the complete oxidation of glucose to CO₂ and H₂O yielding much more ATP than anaerobic glycolysis:

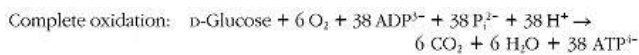
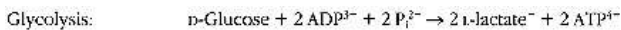

ATP is used by a cell only to meet its metabolic demand, that is, to provide the necessary energy for work processes inherent to that cell. Since so much more ATP is produced from glucose in the presence of oxygen, much less glucose is consumed to meet the metabolic demand of the cell. The "crossover" at the conversion of fructose 6-phosphate to fructose 1,6-bisphosphate argues that oxygen imposes an inhibition at the level of 6-phosphofructo-1-kinase. This can readily be rationalized since **ATP** is a well-recognized inhibitor of 6-phosphofructo-1-kinase, and more ATP is generated in the presence than in the absence of oxygen. However, ATP levels do not change greatly between these two conditions (in the experiment of Figure 7.16*b*, ATP increased from 4.7 $\mu\text{mol/g}$ of wet weight in the absence of oxygen to 5.6 $\mu\text{mol/g}$ of wet weight in the presence of oxygen). Since 6-phosphofructo-1-kinase is severely inhibited at concentrations of ATP (2.5–6 mM) normally present in cells, such a small difference in ATP concentration cannot account completely for the change in flux through 6-phosphofructo-1-kinase. However, much greater changes, percentage wise, occur in the concentrations of **AMP**, a positive allosteric effector of 6-phosphofructo-1-kinase. The change that occurs in steady-state concentrations of AMP when oxygen is introduced into the system is exactly what might have been predicted; that is, the level goes down dramatically. This results in less 6-phosphofructo-1-kinase activity. This greatly suppresses glycolysis and accounts in part for the Pasteur effect. Levels of AMP automatically go down in a cell when ATP levels increase. The reason is simple. The sum of the adenine nucleotides in a cell, that is, ATP + ADP + AMP, is nearly constant under most physiological conditions, but the relative concentrations are such that the ATP concentration is always much greater than the AMP concentration. Furthermore, adenine nucleotides are maintained in equilibrium in the cytosol through action of **adenylate kinase** (also referred to as **myokinase**), which catalyzes the reaction K'_{eq} for this reaction is given by

$$K'_{\text{eq}} = \frac{[\text{ATP}][\text{AMP}]}{[\text{ADP}]^2}$$

Since this reaction is "near equilibrium" under intracellular conditions, the concentration of AMP is given by

$$[\text{AMP}] = \frac{K'_{\text{eq}}[\text{ADP}]^2}{[\text{ATP}]}$$

Because intracellular $[\text{ATP}] \gg [\text{ADP}] \gg [\text{AMP}]$, a small decrease in [ATP] causes a substantially greater percentage increase in [ADP]; and, since [AMP] is related to the square of [ADP], an even greater percentage increase in [AMP]. Because of this relationship, a small decrease in ATP concentration leads to a greater percent increase in [AMP] than in the percent decrease in [ATP]. This makes the [AMP] an excellent signal of the energy status of the cell and allows it to function as an important allosteric effector of 6-phosphofructo-1-kinase activity. Furthermore, [AMP] influences in yet another way the effectiveness of 6-phosphofructo-1-kinase. The enzyme **fructose 1,6-bisphosphatase** catalyzes an irreversible reaction, which opposes that of 6-phosphofructo-1-kinase:

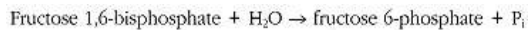

This enzyme sits "cheek by jowl" with 6-phosphofructo-1-kinase in the cytosol of many cells. Together they catalyze a futile cycle ($\text{ATP} \rightarrow \text{ADP} + \text{P}_i + \text{"heat"}$), and, at the very least, they decrease "effectiveness" of one another. AMP concentration is a perfect signal of the energy status of the cell— not only because AMP activates 6-phosphofructo-1-kinase but also because AMP inhibits fructose 1,6-bisphosphatase. Thus a small decrease in ATP concentration trig-

gers, via the increase in AMP concentration, a large increase in net conversion of fructose 6-phosphate into fructose 1,6-bisphosphate. This increases glycolytic flux by increasing the amount of substrate available for the splitting stage. In cells containing hexokinase, it also results in greater phosphorylation of glucose because a decrease in fructose 6-phosphate automatically causes a decrease in glucose 6-phosphate, which in turn results in less inhibition of hexokinase.

The decrease in lactate production in response to onset of respiration is another feature of the Pasteur effect that can readily be explained. The most important factor is decreased glycolytic flux caused by oxygen. Other factors include competition between lactate dehydrogenase and mitochondrial pyruvate dehydrogenase complex for pyruvate, as well as competition between lactate dehydrogenase and shuttle systems for NADH. For the most part, lactate dehydrogenase loses the competition in the presence of oxygen.

Intracellular pH Can Regulate 6-Phosphofructo-1-kinase

It would make sense that lactate, as the end product of glycolysis, should inhibit the rate-limiting enzyme of glycolysis. It does not. However, **hydrogen ions**, the other glycolytic end product, do inhibit 6-phosphofructo-1-kinase. As shown in Figure 7.17, glycolysis in effect generates **lactic acid**, and the cell must dispose of it as such. This explains why excessive glycolysis in the body lowers blood pH and leads to an emergency medical situation termed **lactic acidosis** (see Clin. Corr. 7.5). Plasma membranes of cells contain a symport for lactate and hydrogen ions. That allows release of lactic acid into the bloodstream. This is a defense mechanism, preventing pH from getting so low that everything becomes pickled (see Clin. Corr. 7.6). The sensitivity of 6-phosphofructo-1-kinase to hydrogen ions is also part of this mechanism. Hydrogen ions are able to shut off glycolysis, the process responsible for decreasing pH. Transport of lactic acid out of a cell requires that blood be available to carry it away. When

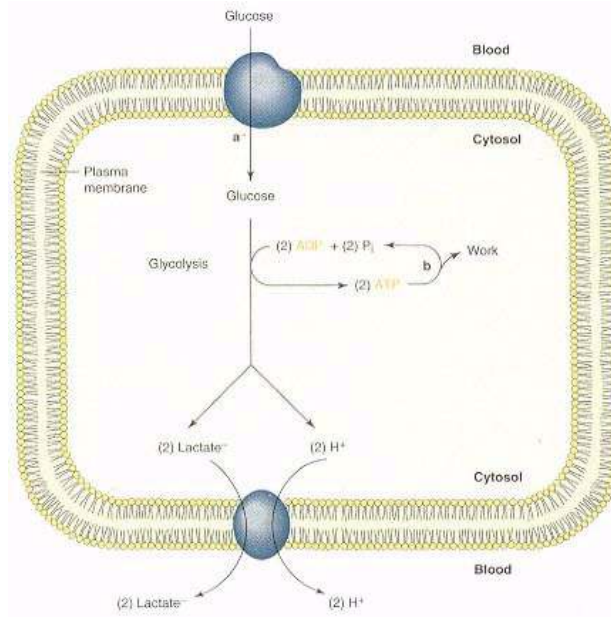

Figure 7.17

Unless lactate formed by glycolysis is transported out of the cell, the intracellular pH will be decreased by the accumulation of intracellular lactic acid.

The low pH decreases 6-phosphofructo-1-kinase activity so that further lactic acid production by glycolysis is shut off.

- (a) Glucose transport into the cell.
- (b) All work performances that convert ATP back to ADP and P_i.
- (c) Lactate–hydrogen ion symport (actual stoichiometry of one lactate⁻ and one H⁺ transported by the symport).

CLINICAL CORRELATION 7.5**Lactic Acidosis**

This problem is characterized by elevated blood lactate levels, usually greater than 5 mM, along with decreased blood pH and bicarbonate concentrations. Lactic acidosis is the most commonly encountered form of metabolic acidosis and can be the consequence of overproduction of lactate, underutilization of lactate, or both. Lactate production is normally balanced by lactate utilization, with the result that lactate is usually not present in the blood at concentrations greater than 1.2 mM. All tissues of the body have the capacity to produce lactate by anaerobic glycolysis, but most tissues do not produce large quantities because much more ATP can be gained by the complete oxidation of the pyruvate produced by glycolysis. However, all tissues respond with an increase in lactate generation when oxygenation is inadequate. A decrease in ATP resulting from reduced oxidative phosphorylation allows the activity of 6-phosphofructo-1-kinase to increase. These tissues have to rely on anaerobic glycolysis for ATP production under such conditions and this results in lactic acid production. A good example is muscle exercise, which can deplete the tissue of oxygen and cause an overproduction of lactic acid. Tissue hypoxia occurs, however, in all forms of shock, during convulsions, and in diseases involving circulatory and pulmonary failure.

The major fate of lactate in the body is either complete combustion to CO₂ and H₂O or conversion back to glucose by the process of gluconeogenesis. Both require oxygen. Decreased oxygen availability therefore increases lactate production and decreases lactate utilization. The latter can also be decreased by liver diseases, ethanol, and a number of other drugs. Phenformin, a drug that was once used to treat the hyperglycemia of insulin-independent diabetes, was well-documented to induce lactic acidosis in certain patients.

Bicarbonate is usually administered in an attempt to control the acidosis associated with lactic acid accumulation. The key to successful treatment, however, is to find and eliminate the cause of the overproduction and/or underutilization of lactic acid and most often involves the restoration of circulation of oxygenated blood.

Newsholme, E. A., and Leech, A. R. *Biochemistry for the Medical Sciences*. New York: Wiley, 1983; and Kruse, J. A., and Carlson, R. W. Lactate metabolism. *Crit. Care Clin.* 3:725, 1985.

blood flow is inadequate, for example, in heavy exercise of a skeletal muscle or an attack of **angina pectoris** in the case of the heart, hydrogen ions cannot escape from cells fast enough. Yet, the need for ATP within such cells, because of lack of oxygen, may partially override inhibition of 6-phosphofructo-1-kinase by hydrogen ions. Unabated accumulation of hydrogen ions then results in pain, which, in the case of skeletal muscle, can be relieved by simply terminating

CLINICAL CORRELATION 7.6**Pickled Pigs and Malignant Hyperthermia**

In patients with malignant hyperthermia, a variety of agents, especially the widely used general anesthetic halothane, will produce a dramatic rise in body temperature, metabolic and respiratory acidosis, hyperkalemia, and muscle rigidity. This genetic abnormality occurs in about 1 in 15,000 children and 1 in 50,000–100,000 adults. It is dominantly inherited. Death may result the first time a susceptible person is anesthetized. Onset occurs within minutes of drug exposure and the hyperthermia must be recognized immediately. Packing the patient in ice is effective and should be accompanied by measures to combat acidosis. The drug dantrolene is also effective.

A phenomenon similar, if not identical, to malignant hyperthermia is known to occur in pigs. Pigs with this problem, called porcine stress syndrome, respond poorly to stress. This genetic disease usually manifests itself as the pig is being shipped to market. Pigs with the syndrome can be identified by exposure to halothane, which triggers the same response seen in patients with malignant hyperthermia. The meat of pigs that have died as a result of the syndrome is pale, watery, and of very low pH (i.e., nearly pickled).

Muscle is the site of the primary lesion in both malignant hyperthermia and porcine stress syndrome. In response to halothane the skeletal muscles become rigid and generate heat and lactic acid. The sarcoplasmic reticulum of such pigs and patients have a genetic abnormality in the ryanodine receptor, a Ca²⁺ release channel, that plays an important function in excitation–contraction coupling in muscle. Because of a defect in this protein, the anesthetic triggers inappropriate release of Ca²⁺ from the sarcoplasmic reticulum. This results in uncontrolled stimulation of a number of heat-producing processes, including myosin ATPase, glycogenolysis, glycolysis, and cyclic uptake and release of Ca²⁺ by mitochondria and sarcoplasmic reticulum. Muscle cells become irreversibly damaged as consequence of excessive heat production, lactic acidosis, and ATP loss.

Kalow, W., and Grant, D. M. Pharmacogenetics. In: C. R. Scriver, A. L. Beaudet, W. S. Sly, and D. Valle (Eds.), *The Metabolic and Molecular Bases of Inherited Disease*, 7th ed. New York: McGraw-Hill, 1995, pp. 293–326.

CLINICAL CORRELATION 7.7

Angina Pectoris and Myocardial Infarction

Chest pain associated with reversible myocardial ischemia is termed angina pectoris (literally, strangling pain in the chest). The pain is the result of an imbalance between demand for and supply of blood flow to cardiac muscles and is most commonly caused by narrowing of the coronary arteries. The patient experiences a heavy squeezing pressure or ache substernally, often radiating to either the shoulder and arm or occasionally to the jaw or neck. Attacks occur with exertion, last from 1 to 15 min, and are relieved by rest. The coronary arteries involved are obstructed by atherosclerosis (i.e., lined with characteristic fatty deposits) or less commonly narrowed by spasm. Myocardial infarction occurs if the ischemia persists long enough to cause severe damage (necrosis) to the heart muscle. Commonly, a blood clot forms at the site of narrowing and completely obstructs the vessel. In myocardial infarction, tissue death occurs and the characteristic pain is longer lasting, and often more severe.

Nitroglycerin and other nitrates are frequently prescribed to relieve the pain caused by the myocardial ischemia of angina pectoris. These drugs can be used prophylactically, enabling patients to participate in activities that would otherwise precipitate an attack of angina. Nitroglycerin may work in part by causing dilation of the coronary arteries, improving oxygen delivery to the heart and washing out lactic acid. Probably more important is the effect of nitroglycerin on the peripheral circulation. Breakdown of nitroglycerin produces nitric oxide (NO), a compound that relaxes smooth muscle, causing venodilation throughout the body. This reduces arterial pressure and allows blood to accumulate in the veins. The result is decreased return of blood to the heart, and a reduced volume of blood the heart has to pump, which reduces the energy requirement of the heart. In addition, the heart empties itself against less pressure, which also spares energy. The overall effect is a lowering of the oxygen requirement of the heart, bringing it in line with the oxygen supply via the diseased coronary arteries. Other useful agents are calcium channel blockers, which are coronary vasodilators, and β -adrenergic blockers. The β -blockers prevent the increase in myocardial oxygen consumption induced by sympathetic nervous system stimulation of the heart, as occurs with physical exertion.

The coronary artery bypass operation is used in severe cases of angina that cannot be controlled by medication. In this operation veins are removed from the leg and interposed between the aorta and coronary arteries of the heart. The purpose is to bypass the portion of the artery diseased by atherosclerosis and provide the affected tissue with a greater blood supply. Remarkable relief from angina can be achieved by this operation, with the patient being able to return to normal productive life in some cases.

Hugenholtz, P. G. Calcium antagonists for angina pectoris. *Ann. N. Y. Acad. Sci.* 522:565, 1988; Feilishch, M., and Noack, E. A. Correlation between nitric oxide formation during degradation of organic nitrates and activation of guanylate cyclase. *Eur. J. Pharmacol.* 139:19, 1987; and Ignarro, L. J. Biological actions and properties of endothelium-derived nitric oxide formed and released from artery and vein. *Circ. Res.* 65:1, 1989.

the exercise. In the case of the heart, rest or pharmacologic agents that increase blood flow or decrease the need for ATP within myocytes may be effective (see Clin. Corr. 7.7).

Intracellular Citrate Levels Regulate 6-Phosphofructo-1-kinase

Many tissues prefer to use fatty acids and ketone bodies as oxidizable fuels in place of glucose. Most of these tissues can use glucose but actually prefer to oxidize fatty acids and ketone bodies. This helps preserve glucose for tissues, such as brain, that are absolutely dependent on glucose as an energy source. Oxidation of both fatty acids and ketone bodies elevates levels of cytosolic citrate, which inhibits 6-phosphofructo-1-kinase. The result is decreased glucose utilization by the tissue when fatty acids or ketone bodies are available.

Hormonal Control of 6-Phosphofructo-1-kinase by cAMP and Fructose 2,6-bisphosphate

Fructose 2,6-bisphosphate (Figure 7.18), like AMP, functions as a positive allosteric effector of 6-phosphofructo-1-kinase and as a negative allosteric effector of fructose 1,6-bisphosphatase. Indeed, without the presence of this compound, glycolysis could not occur in liver because 6-phosphofructo-1-kinase would have insufficient activity and fructose 1,6-bisphosphatase would have too much activity for net conversion of fructose 6-phosphate to fructose 1,6-bisphosphate.

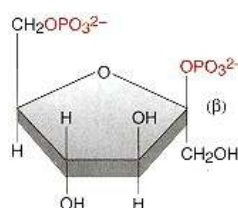

Figure 7.18
Structure of fructose
2,6-bisphosphate.

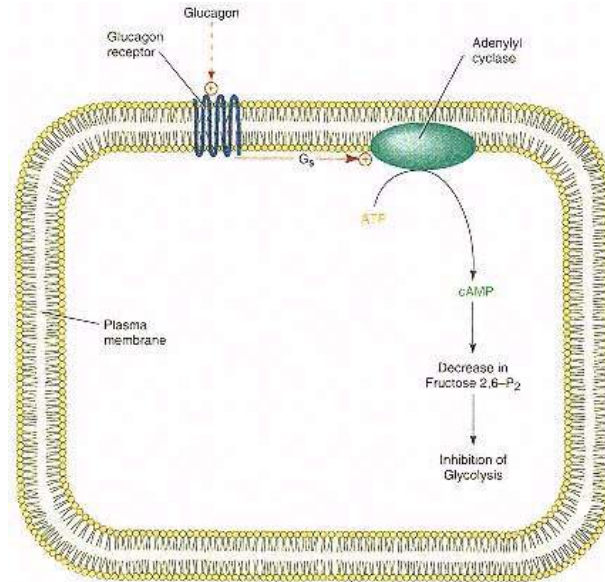
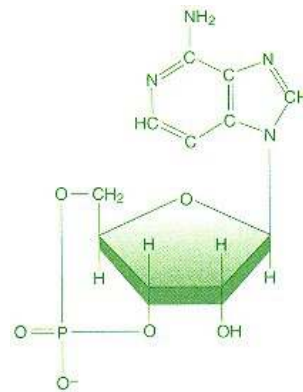

Figure 7.19
Overview of the mechanism responsible for glucagon inhibition of hepatic glycolysis.

Binding of glucagon to its receptor (a protein that spans the membrane seven times) activates adenylyl cyclase (an intrinsic membrane protein) activity through the action of a stimulatory G-protein (G_s). The (+) symbol indicates activation.

Figure 7.19 gives a brief overview of the role of fructose 2,6-bisphosphate in hormonal control of hepatic glycolysis. Understanding this mechanism requires an appreciation of the role of **cAMP** (Figure 7.20) as the "second messenger" of hormone action. As discussed in more detail in Chapters 14 and 20, **glucagon** is released from α cells of pancreas and circulates in blood until it comes in contact with glucagon receptors located on the outer surface of liver plasma membrane (Figure 7.19). Binding of glucagon to these receptors is sensed by **adenylyl** (adenylyl) **cyclase**, an enzyme located on the inner surface of the plasma membrane, stimulating it to convert ATP into cAMP. Cyclic AMP triggers a series of intracellular events that result ultimately in a decrease in fructose 2,6-bisphosphate levels. A decrease in this compound makes 6-phosphofructo-1-kinase less effective but makes fructose 1,6-bisphosphatase more effective, thereby severely restricting flux from fructose 6-phosphate to fructose 1,6-bisphosphate in glycolysis.

Fructose 2,6-bisphosphate is not an intermediate of glycolysis. As shown in Figure 7.21, fructose 2,6-bisphosphate is produced from F6P by the enzyme **6-phosphofructo-2-kinase**. We now have two "phosphofructokinases" to contend with: one produces an intermediate (FBP) of glycolysis and the other



Cyclic AMP

Figure 7.20
 Structure of cAMP.

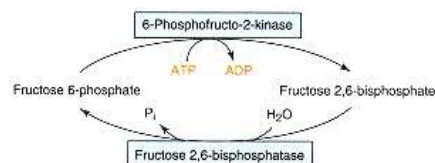

Figure 7.21
 Reactions involved in the formation and degradation of fructose 2,6-bisphosphate.

produces a positive allosteric effector (fructose 2,6-bisphosphate) of the first enzyme. Fructose 2,6-bisphosphate can be destroyed by being converted back to F6P by fructose 2,6-bisphosphatase (Figure 7.21). This is a simple hydrolysis, with no ATP or ADP being involved. Synthesis and degradation of fructose 2,6-bisphosphate are catalyzed by a **bifunctional enzyme**; that is, 6-phosphofructo-2-kinase and fructose 2,6-bisphosphatase are part of the same protein. Because of its bifunctional nature, the combined name of 6-phosphofructo-2-kinase/fructose 2,6-bisphosphatase is used to refer to this enzyme that makes and degrades fructose 2,6-bisphosphate. cAMP regulates fructose 2,6-bisphosphate levels in liver. How is this possible when the same enzyme carries out both synthesis and degradation of the molecule? The answer is that a mechanism exists whereby cAMP inactivates the kinase function and, at the same time, activates the phosphatase function of this bifunctional enzyme.

cAMP Activates Protein Kinase A

Cyclic AMP activates **protein kinase A** (also called **cAMP-dependent protein kinase**). In its inactive state, this enzyme consists of two regulatory subunits plus two catalytic subunits. Binding of cAMP to regulatory subunits causes conformational changes with release of catalytic subunits, which are active only when dissociated from regulatory subunits. Liberated protein kinase then catalyzes phosphorylation of specific serine residues of several different enzymes (Figure 7.22).

Phosphorylation of an enzyme can conveniently be abbreviated as

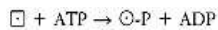

where $\odot\text{-P}$ are used to indicate dephosphorylated and phosphorylated enzymes, respectively. Circle and square symbols are used because **phosphorylation** of enzymes subject to regulation by covalent modification causes a change in their conformation, which affects the active site. The change in conformation due to phosphorylation increases catalytic activity of some enzymes but decreases catalytic activity of others. Direction of change in activity depends on the enzyme involved. Many enzymes are subject to this type of regulation, an important type of **covalent modification**. Regardless of whether phosphorylation or dephosphorylation activates the enzyme, the active form of the enzyme is called the *a* form and the inactive form the *b* form. Likewise, regardless of the effect of phosphorylation on catalytic activity, the action of a protein kinase is always opposed by that of a phosphoprotein phosphatase, which catalyzes the reaction of

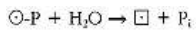

Putting these together creates a **cyclic control system** (see Figure 7.23), such that the ratio of phosphorylated enzyme to dephosphorylated enzyme is a function of the relative activities of protein kinase and phosphoprotein phosphatase. If the kinase has greater activity than the phosphatase, more enzyme will be in the phosphorylated mode, and vice versa. Since activity of an interconvertible enzyme (i.e., an enzyme subject to covalent modification) is determined by whether it is in the phosphorylated or dephosphorylated mode, the relative

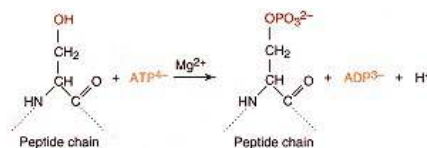

Figure 7.22
Enzymes subject to covalent modification are usually phosphorylated on specific serine residues. Tyrosine and threonine residues are also important sites of covalent modification by phosphorylation.

activities of kinase and phosphatase determine the amount of a particular enzyme that is in the catalytically active state.

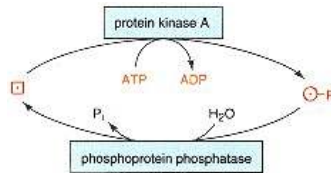

Figure 7.23
General model of the mechanism responsible for regulation of enzymes by phosphorylation–dephosphorylation.

The symbols \odot -P indicate that different conformational and activity states of the enzyme are produced as a result of phosphorylation–dephosphorylation.

6-Phosphofructo-2-kinase and Fructose 2,6-bisphosphatase Are Domains of a Bifunctional Polypeptide Regulated by Phosphorylation—Dephosphorylation

Most enzymes are either turned on or off by phosphorylation but with **6-phosphofructo-2-kinase** and **fructose 2,6-bisphosphatase**, advantage is taken of the bifunctional nature of the enzyme. In the case of the isoenzyme present in liver, phosphorylation causes inactivation of the active site responsible for synthesis of fructose 2,6-bisphosphate but activation of the active site responsible for hydrolysis of fructose 2,6-bisphosphate (Figure 7.24). Dephosphorylation of the enzyme has the opposite effects. A sensitive mechanism has therefore evolved to set the intracellular concentration of **fructose 2,6-bisphosphate** in liver cells in response to changes in blood levels of **glucagon** or **epinephrine** (Figure 7.25). Increased levels of glucagon or epinephrine, acting through plasma membrane glucagon receptors and β -adrenergic receptors, respectively, have the common effect of inducing an increase in intracellular levels of **cAMP**. This second messenger activates **protein kinase A**, which phosphorylates a single serine residue of 6-phosphofructo-2-kinase/fructose 2,6-bisphosphatase (Figure 7.26). This inhibits fructose 2,6-bisphosphate synthesis and promotes its degradation. The resulting decrease in fructose 2,6-bisphosphate makes 6-phosphofructo-1-kinase less effective and fructose 1,6-bisphosphatase more effective. The result is inhibition of glycolysis at the level of the conversion of fructose 6-phosphate to fructose 1,6-bisphosphate. Decreased levels of either glucagon or epinephrine in blood result in less cAMP in liver because adenylate cyclase is less active and cAMP that had accumulated is converted to AMP by the action of **cAMP phosphodiesterase**. Loss of the cAMP signal results in inactivation of protein kinase A and a corresponding decrease in phosphorylation of 6-phosphofructo-2-kinase/fructose 2,6-bisphosphatase by protein kinase A. A **phosphoprotein phosphatase** removes phosphate from the bifunctional enzyme to produce active 6-phosphofructo-2-kinase and inactive fructose 2,6-bisphosphatase. Fructose 2,6-bisphosphate can now accumulate to a higher steady-state concentration and, by activating 6-phosphofructo-1-kinase and inhibiting fructose 1,6-bisphosphatase, greatly increases glycolysis. Thus glucagon and epinephrine are extracellular signals that stop liver from using glucose, whereas fructose 2,6-bisphosphate is an intracellular signal that promotes glucose utilization by this tissue.

Insulin opposes the actions of glucagon and epinephrine, but exactly how insulin works after binding to the plasma membrane remains a subject of intense investigation (see Chapter 20). There is evidence that insulin promotes formation of a second messenger, much as glucagon promotes formation of cAMP. Obvious enzyme targets that a second messenger might influence include cAMP phosphodiesterase, protein kinase A, and phosphoprotein phosphatase (Figure 7.27). There also is evidence, however, that insulin signals a cascade of events that depends upon activation of a number of protein kinases (see Chapter 20).

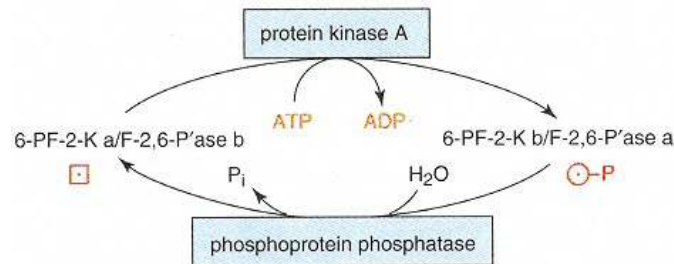

Figure 7.24
Mechanism responsible for covalent modification of the bifunctional enzyme 6-phosphofructo-2-kinase/fructose 2,6-bisphosphatase.
Name of the enzyme is abbreviated as 6-PF-2-K/F-2,6-P'ase. Letters *a* and *b* indicate the active and inactive forms of the enzymes, respectively.

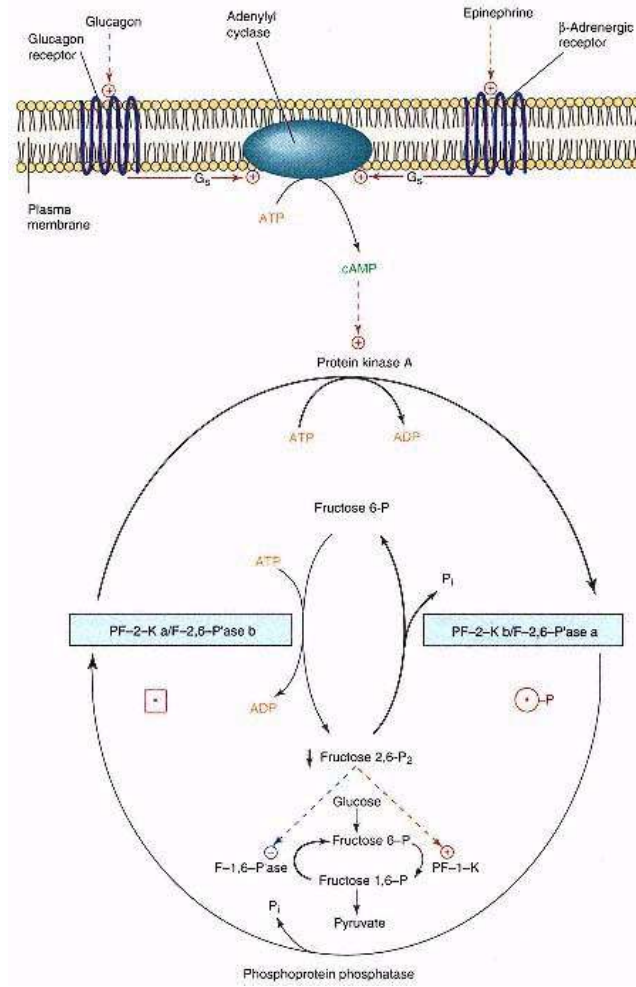

Figure 7.25
Mechanism of glucagon and epinephrine inhibition of hepatic glycolysis via cAMP-mediated decrease in fructose 2,6-bisphosphate concentration.
 See legend for Figure 7.19. The heavy arrows indicate the reactions that predominate in the presence of glucagon. Small arrow before fructose 2,6-bisphosphate indicates a decrease in concentration of this compound.

Regardless of its exact mechanism, insulin acts in the opposite direction from that of glucagon and epinephrine in determining the levels of fructose 2,6-bisphosphate in liver cells and, therefore, the rate of glycolysis.

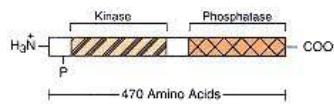

Figure 7.26
Schematic diagram of the primary structure of the liver isoenzyme of 6-phosphofructo-2-kinase/fructose-2,6-bisphosphatase.

NH₂ and CO₂H designate the N-terminal and C-terminal ends of the enzyme, respectively. Domain with kinase activity is located in the N-terminal half of the enzyme; domain with phosphatase activity in the C-terminal half of the enzyme. The letter P indicates the site (serine 32) phosphorylated by protein kinase A.

Heart Contains a Different Isoenzyme of the Bifunctional Enzyme

An increase in blood level of **epinephrine** has a markedly different effect on glycolysis in **heart** from that in liver. Glycolysis is inhibited in liver to conserve glucose for use by other tissues. Epinephrine stimulates glycolysis in heart as part of a mechanism to meet the increased demand for ATP caused by an epinephrine-signalized increase in work load. As in liver, epinephrine acts on

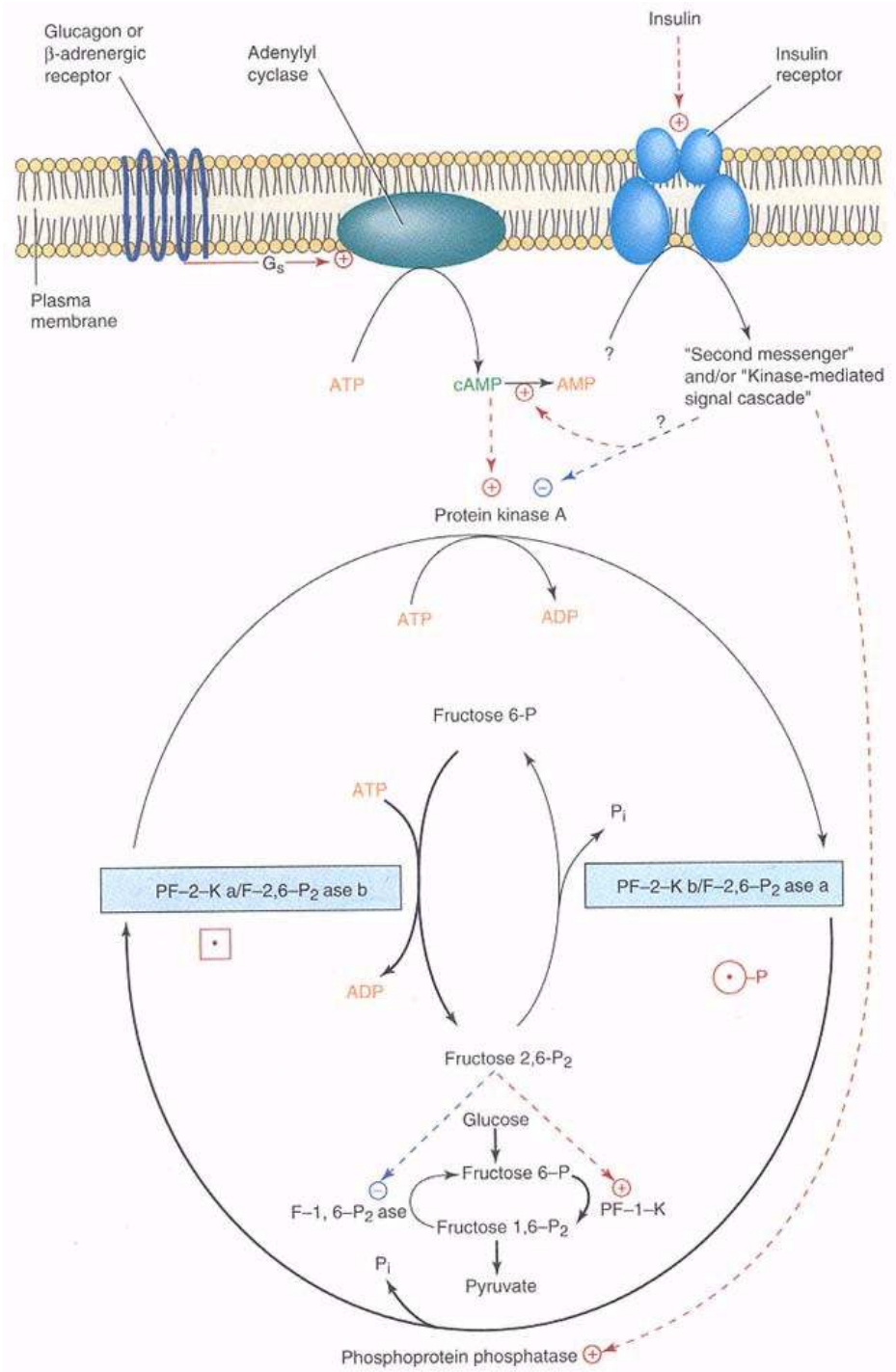

Figure 7.27
Mechanism responsible for accelerated rates of hepatic glycolysis when the concentration of glucagon and epinephrine are low and that of insulin is high in the blood.
 See legends for Figures 7.19 and 7.25. The insulin receptor is an intrinsic component of the plasma membrane. Small arrow before fructose 2,6-bisphosphate indicates an increase in concentration. The question marks indicate that the details of the mechanism of action of insulin are unknown at this time.

the heart by way of a β -adrenergic receptor on the plasma membrane, promoting formation of cAMP by adenylate cyclase (Figure 7.28). This results in the activation of protein kinase A, which in turn phosphorylates 6-phosphofructo-2-kinase/fructose 2,6-bisphosphatase. In contrast, however, to what happens in liver, phosphorylation of the bifunctional enzyme in heart produces an increase rather than a decrease in fructose 2,6-bisphosphate levels. This is because heart expresses a different isoenzyme of the bifunctional enzyme. Although still a bifunctional enzyme that carries out exactly the same reactions as the liver enzyme, the amino acid sequence of the heart isoenzyme is different, and phosphorylation by protein kinase A occurs at a site that activates rather than inhibits 6-phosphofructo-2-kinase (Figure 7.29). Increased fructose 2,6-bisphos-

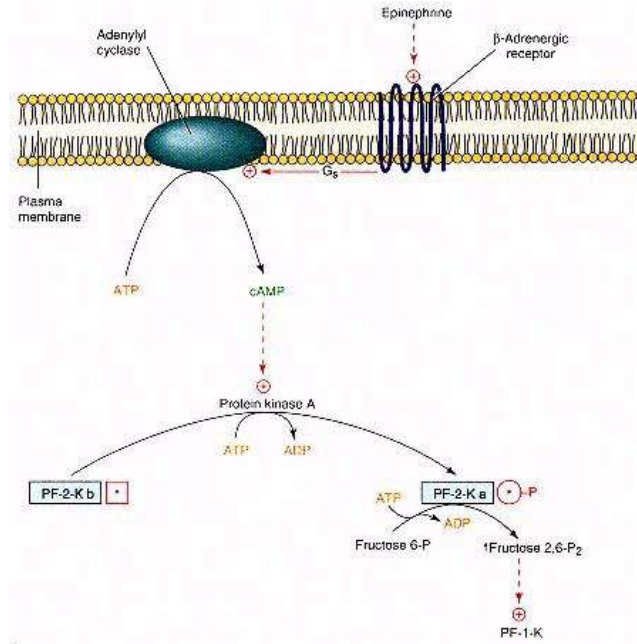

Figure 7.28
Mechanism responsible for accelerated rates of glycolysis in the heart in response to epinephrine.
 See legends for Figures 7.19 and 7.27.

phate results in increased 6-phosphofructo-1-kinase activity and increased glycolytic flux in response to epinephrine in heart.

Pyruvate Kinase Is a Regulated Enzyme of Glycolysis

Pyruvate kinase is another regulatory enzyme of glycolysis (see Clin. Corr. 7.8). This enzyme is drastically inhibited by physiological concentrations of ATP, so much so that its potential activity is never fully realized under physiological conditions. The isoenzyme found in liver is greatly activated by fructose 1,6-bisphosphate, thereby linking regulation of pyruvate kinase to what is happening to 6-phosphofructo-1-kinase. Thus, if conditions favor increased flux through 6-phosphofructo-1-kinase, the level of FBP increases and acts as a feed-forward activator of pyruvate kinase. The liver enzyme is also subject to covalent modification, being active in the dephosphorylated state and inactive in the phosphorylated state (Figure 7.30); phosphorylation is catalyzed by protein kinase A in liver. Thus glucagon inhibition of hepatic glycolysis and stimulation

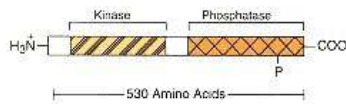

Figure 7.29
Schematic diagram of the primary structure of the heart isoenzyme of 6-phosphofructo-2-kinase/fructose 2,6-bisphosphatase that is present in the heart.
 See legend for Figure 7.26. The letter P indicates the site (serine 466) phosphorylated by protein kinase A.

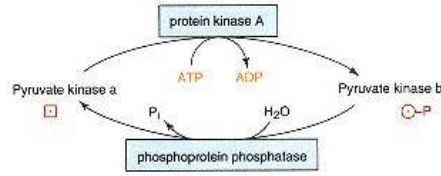

Figure 7.30
Glucagon acts via cAMP-mediated activation of protein kinase A to cause the phosphorylation and inactivation of hepatic pyruvate kinase.

of hepatic gluconeogenesis are explained in part by elevation of cAMP levels caused by this hormone. This aspect is explored more thoroughly in Section 7.5 in the discussion of gluconeogenesis.

Pyruvate kinase, like glucokinase, is induced to higher steady-state concentrations in liver by combination of high carbohydrate intake and high insulin levels. This increase in enzyme concentration is a major reason why liver of the well-fed individual has much greater capacity for utilizing carbohydrate than a fasting or diabetic person (see Clin. Corr. 7.4).

CLINICAL CORRELATION 7.8

Pyruvate Kinase Deficiency and Hemolytic Anemia

Mature erythrocytes are absolutely dependent on glycolytic activity for ATP production. ATP is needed for the ion pumps, especially the Na⁺, K⁺-ATPase, which maintain the biconcave disk shape of erythrocytes, a characteristic that helps erythrocytes slip through the capillaries as they deliver oxygen to the tissues. Without ATP the cells swell and lyse. Anemia due to excessive erythrocyte destruction is referred to as hemolytic anemia. Pyruvate kinase deficiency is rare but is by far the most common genetic defect of the glycolytic pathway known to cause hemolytic anemia. Most pyruvate kinase-deficient patients have 5–25% of normal red blood cell pyruvate kinase levels and flux through the glycolytic pathway is restricted severely, resulting in markedly lower ATP concentrations. The expected crossover of the glycolytic intermediates is observed; that is, those intermediates proximal to the pyruvate kinase-catalyzed step accumulate, whereas pyruvate and lactate concentrations decrease. Normal ATP levels are observed in reticulocytes of patients with this disease. Although deficient in pyruvate kinase, these "immature" red blood cells have mitochondria and can generate ATP by oxidative phosphorylation. Maturation of reticulocytes into red blood cells results in the loss of mitochondria and complete dependence on glycolysis for ATP production. Since glycolysis is defective, the mature cells are lost rapidly from the circulation. Anemia results because the cells cannot be replaced rapidly enough by erythropoiesis.

Valentine, W. N. The Stratton lecture: hemolytic anemia and inborn errors of metabolism. *Blood* 54:549, 1979; and Tanaka, K. R., and Paglia, D. E. Pyruvate kinase and other enzymopathies of the erythrocyte. In: C. R. Scriver, A. L. Beaudet, W. S. Sly, and D. Valle (Eds.), *The Metabolic and Molecular Bases of Inherited Disease*, 7th ed. New York: McGraw-Hill, 1995, pp. 3485–3511.

**7.5—
Gluconeogenesis**

Glucose Synthesis Is Required for Survival

Net synthesis or formation of glucose from various substrates is termed **gluconeogenesis**. This includes use of various amino acids, lactate, pyruvate, propionate, and glycerol, as sources of carbon for the pathway (see Figure 7.31). Glucose is also synthesized from galactose and fructose. **Glycogenolysis**, that is, formation of glucose or glucose 6-phosphate from glycogen, should be differentiated from gluconeogenesis; glycogenolysis refers to

Glycogen or (glucose)_n → molecules of glucose

and thus does not correspond to *de novo* synthesis of glucose, the hallmark of the process of gluconeogenesis.

The capacity to synthesize glucose is crucial for survival of humans and other animals. Blood glucose levels have to be maintained to support metabolism of tissues that use glucose as their primary substrate (see Clin. Corr. 7.9). These include brain, red blood cells, kidney medulla, lens, cornea, testis, and a number of other tissues. Gluconeogenesis enables the maintenance of blood glucose levels long after all dietary glucose has been absorbed and completely oxidized.

The Cori and Alanine Cycles

Two important cycles between tissues that involve gluconeogenesis are recognized. The **Cori cycle** and the alanine cycle (Figure 7.32) depend on gluconeogenesis.

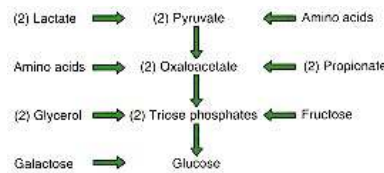

Figure 7.31
Abbreviated pathway of gluconeogenesis, illustrating the major substrate precursors for the process.

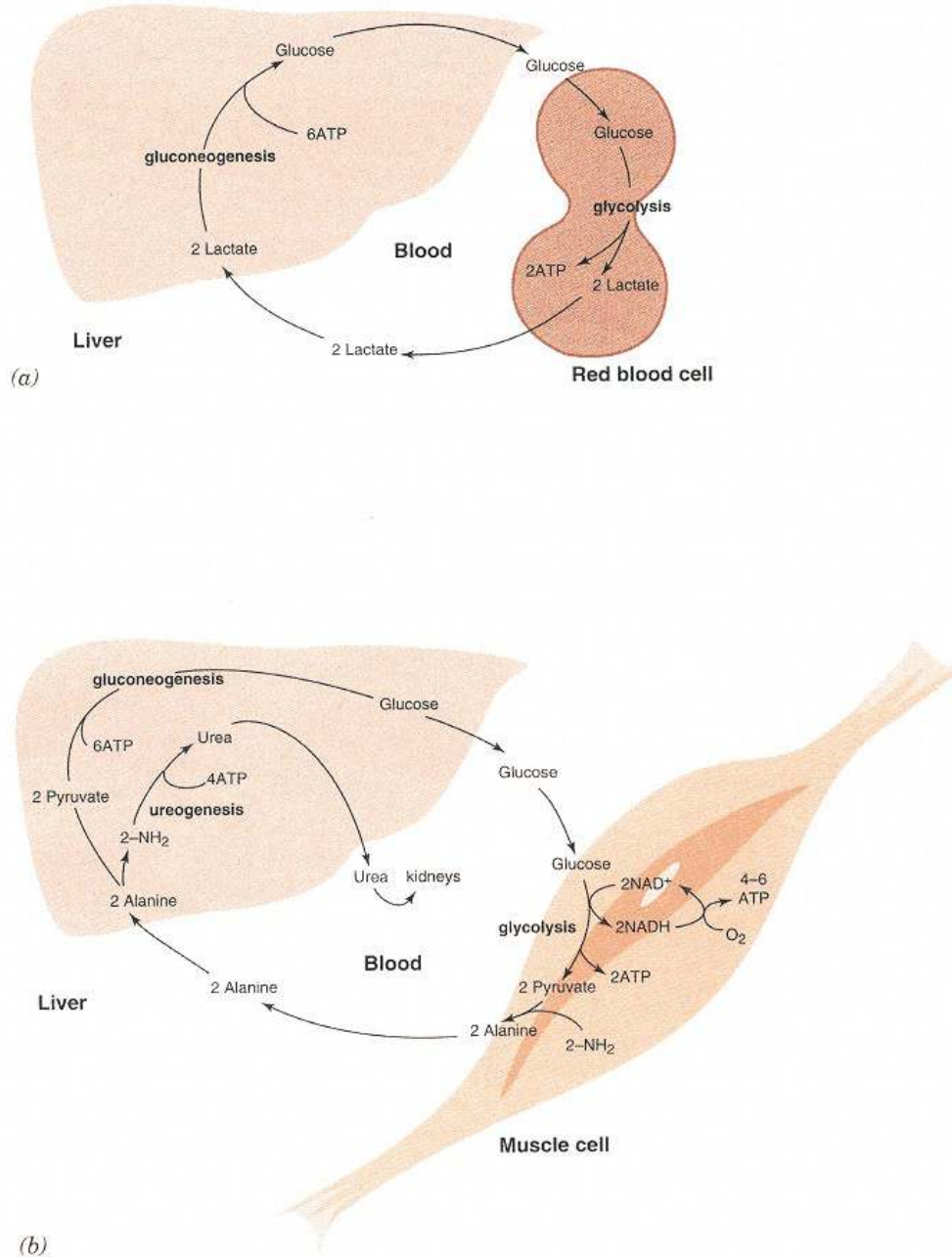

Figure 7.32
Relationship between gluconeogenesis in the liver and glycolysis in the rest of the body.
 (a) Cori cycle.
 (b) Alanine cycle.

CLINICAL CORRELATION 7.9

Hypoglycemia and Premature Infants

Premature and small-for-gestational-age neonates have a greater susceptibility to hypoglycemia than full-term, appropriate-for-gestational-age infants. Several factors appear to be involved. Children in general are more susceptible than adults to hypoglycemia, simply because they have larger brain/body weight ratios and the brain utilizes disproportionately greater amounts of glucose than the rest of the body. Newborn infants have a limited capacity for ketogenesis, apparently because the transport of long-chain fatty acids into liver mitochondria of the neonate is poorly developed. Since ketone body use by the brain is directly proportional to the circulating ketone body concentration, the neonate is unable to spare glucose to any significant extent by using ketone bodies. The consequence is that the neonate's brain is almost completely dependent on glucose obtained from liver glycogenolysis and gluconeogenesis.

The capacity for hepatic glucose synthesis from lactate and alanine is also limited in newborn infants. This is because the rate limiting enzyme phosphoenolpyruvate carboxykinase is present in very low amounts during the first few hours after birth. Induction of this enzyme to the level required to prevent hypoglycemia during the stress of fasting requires several hours. Premature and small-for-gestational-age infants are believed to be more susceptible to hypoglycemia than normal infants because of smaller stores of liver glycogen. Fasting depletes their glycogen stores more rapidly, making these neonates more dependent on gluconeogenesis than normal infants.

Ballard, F. J. The development of gluconeogenesis in rat liver: controlling factors in the newborn. *Biochem. J.* 124:265, 1971; and Newsholme, E. A., and Leech, A. R. *Biochemistry for the Medical Sciences*. New York: Wiley, 1983.

genesis in liver followed by delivery of glucose and its use in a peripheral tissue. Both cycles provide a mechanism for continuously supplying tissues that require glucose as their primary energy source. The cycles are only functional between liver and tissues that do not completely oxidize glucose to CO_2 and H_2O . In order to participate in these cycles, peripheral tissues must release either alanine or lactate as the end product of glucose metabolism. The type

of recycled three-carbon intermediate is the major difference between the Cori cycle (Figure 7.32a) and the alanine cycle (Figure 7.32b), carbon returning to liver as lactate in the Cori cycle but as alanine in the alanine cycle. Another major difference is that NADH generated by glycolysis in the alanine cycle cannot be used to reduce pyruvate to lactate. In tissues that have mitochondria, electrons of NADH can be transported into the mitochondria by the malate–aspartate shuttle or the glycerol phosphate shuttle for the synthesis of ATP by oxidative phosphorylation:

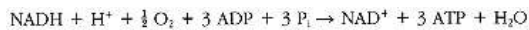

or

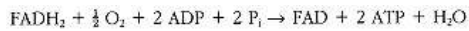

The consequence is that six to eight molecules of ATP can be formed per glucose molecule in peripheral tissues that participate in the alanine cycle. This stands in contrast to the Cori cycle in which only two molecules of ATP per molecule of glucose are produced. Overall stoichiometry for the Cori cycle is

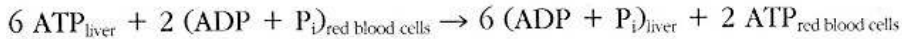

Six molecules of ATP are needed in liver to provide the energy necessary for glucose synthesis. The alanine cycle also transfers the energy from liver to peripheral tissues and, because of the six to eight molecules of ATP produced per molecule of glucose, is an energetically more efficient cycle. Participation of alanine in the cycle presents liver with amino nitrogen, which must be disposed of as urea (Figure 7.32b and p. 453). Urea synthesis is expensive since four ATP molecules are consumed per urea molecule. The concurrent need for urea synthesis results in more ATP being needed per glucose molecule synthesized in liver. Overall stoichiometry for the alanine cycle is



In contrast to the Cori cycle, oxygen and mitochondria are required in peripheral tissue for participation in the alanine cycle.

Pathway of Glucose Synthesis from Lactate

Gluconeogenesis from lactate is an ATP-requiring process with the overall equation of

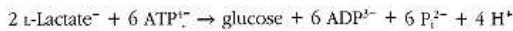

Many enzymes of glycolysis are common to the gluconeogenic pathway. Additional reactions have to be involved because glycolysis produces 2 ATPs and gluconeogenesis requires 6 ATPs per molecule of glucose. Also, certain steps of glycolysis are irreversible under intracellular conditions and are replaced by irreversible steps of the gluconeogenic pathway. The reactions of gluconeogenesis from lactate are given in Figure 7.33. The initial step is conversion of lactate to pyruvate by **lactate dehydrogenase**. NADH is generated and is also needed for a subsequent step in the pathway. Pyruvate cannot be converted to phosphoenolpyruvate (PEP) by **pyruvate kinase** because the reaction is irreversible under intracellular conditions. Pyruvate is converted into the high-energy phosphate compound PEP by coupling of two reactions requiring high-energy phosphate compounds (an ATP and a GTP). The first is catalyzed by pyruvate carboxylase and the second by PEP carboxykinase (see Figure 7.34).

Pyruvate Carboxylase and Phosphoenolpyruvate Carboxykinase

GTP, required for the **PEP carboxykinase**, is equivalent to an ATP through the action of **nucleoside diphosphate kinase** ($\text{GDP} + \text{ATP} \rightleftharpoons \text{GTP} + \text{ADP}$),

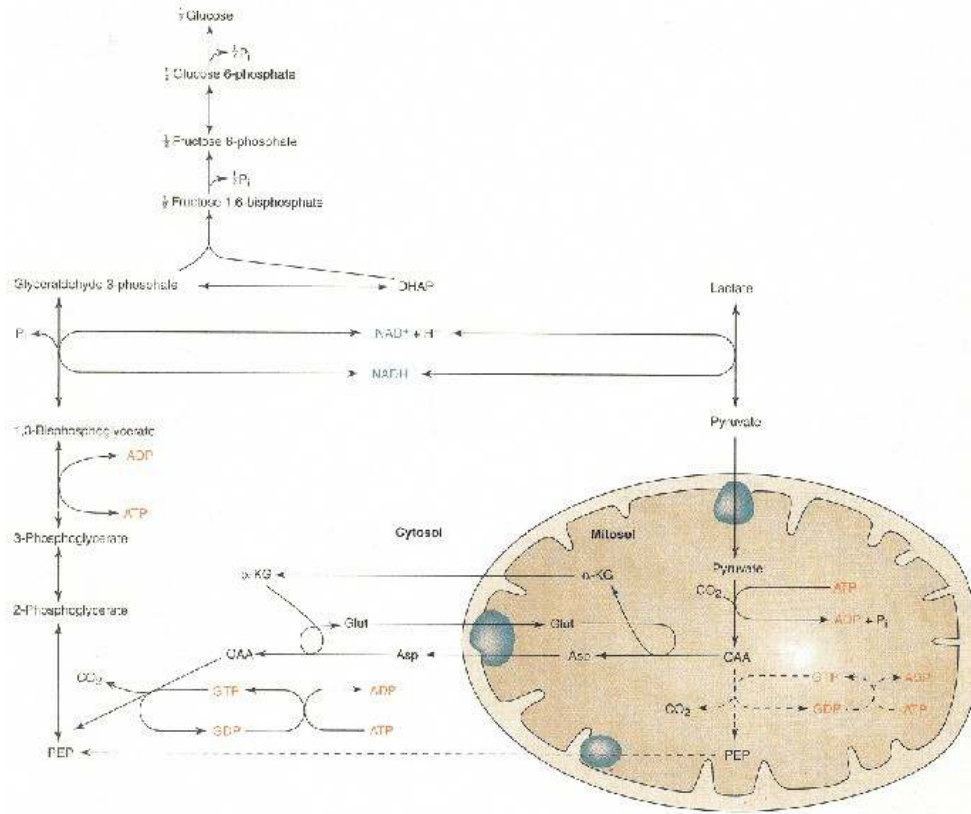
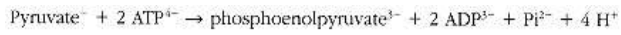

Figure 7.33
Pathway of gluconeogenesis from lactate.
 The involvement of the mitochondrion in the process is indicated. Dashed arrows refer to an alternate route, which employs mitosomal PEP carboxykinase rather than the cytosolic isoenzyme. Abbreviations: OAA, oxaloacetate; -KG, -ketoglutarate; PEP, phosphoenolpyruvate; DHAP, dihydroxyacetone phosphate.

and CO_2 and HCO_3^- readily equilibrate by action of **carbonic anhydrase** ($\text{CO}_2 + \text{H}_2\text{O} \rightleftharpoons \text{H}_2\text{CO}_3 \rightleftharpoons \text{H}^+ + \text{HCO}_3^-$). Thus the sum of these reactions is



Thus conversion of pyruvate into PEP during gluconeogenesis costs the cell two molecules of ATP whereas conversion of PEP to pyruvate during glycolysis yields the cell one molecule of ATP.

The intracellular location of **pyruvate carboxylase** makes the mitochondrion mandatory for conversion of cytosolic pyruvate into cytosolic PEP (Figure 7.33). There are two routes that oxaloacetate can then take to glucose. This

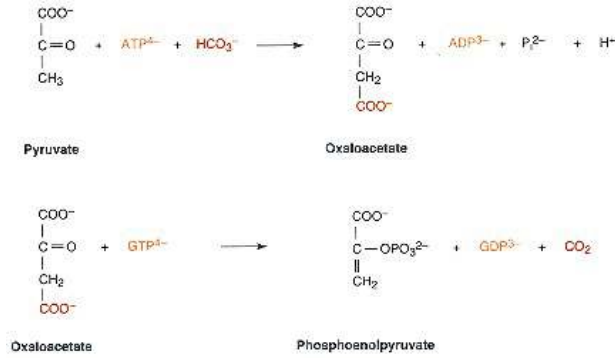

Figure 7.34
Energy-requiring steps involved in phosphoenolpyruvate formation from pyruvate.
 Reactions are catalyzed by pyruvate carboxylase and PEP carboxykinase, respectively.

happens because PEP carboxykinase is present in both cytosolic and mitosomal compartments. The simplest pathway involves the mitochondrial PEP carboxykinase. Oxaloacetate is converted within the mitochondrion into PEP, which then traverses the mitochondrial inner membrane. The second pathway would be just as simple if oxaloacetate could traverse the mitochondrial inner membrane. However, oxaloacetate cannot be transported out of mitochondria for want of a transporter (Figure 7.9b). Thus oxaloacetate is converted into aspartate, which is transported out by the **glutamate-aspartate antiport**. In the cytosol, transamination with α -ketoglutarate converts aspartate back to oxaloacetate.

Gluconeogenesis Uses Many Glycolytic Enzymes but in the Reverse Direction

The steps from PEP to fructose 1,6-bisphosphate are steps of the glycolytic pathway in reverse. NADH generated by lactate dehydrogenase is utilized by glyceraldehyde-3-phosphate dehydrogenase, establishing an equal balance of generation and utilization of reducing equivalents.

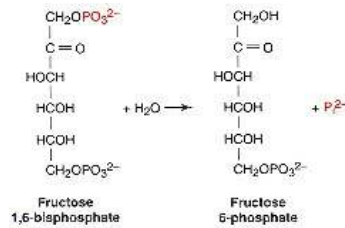

Figure 7.35
 Reaction catalyzed by fructose 1,6-bisphosphatase.

6-Phosphofructo-1-kinase catalyzes an irreversible step in glycolysis and cannot be used for conversion of FBP to fructose 6-phosphate. A way around this step is provided by **fructose 1,6-bisphosphatase**, which catalyzes irreversible hydrolysis of fructose 1,6-bisphosphate (Figure 7.35). This reaction produces F6P but, since the reaction is irreversible, it cannot be used in glycolysis to produce FBP.

Phosphoglucose isomerase is freely reversible and functions in both glycolytic and gluconeogenic pathways. **Glucose 6-phosphatase**, which is used instead of glucokinase for the last step, catalyzes an irreversible hydrolytic reaction under intracellular conditions (Figure 7.36). Nucleotides have no role in this reaction; the function of this enzyme is to generate glucose, not to convert glucose into glucose 6-phosphate. Glucose 6-phosphatase is a membrane-bound enzyme, within the endoplasmic reticulum, with its active site available for G6P hydrolysis on the cisternal surface of the tubules (see Figure 7.37). A translocase for G6P is required to move G6P from the cytosol to its site of

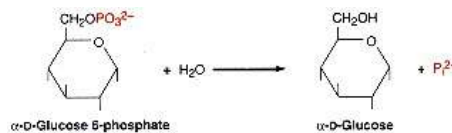

Figure 7.36
 Reaction catalyzed by glucose 6-phosphatase.

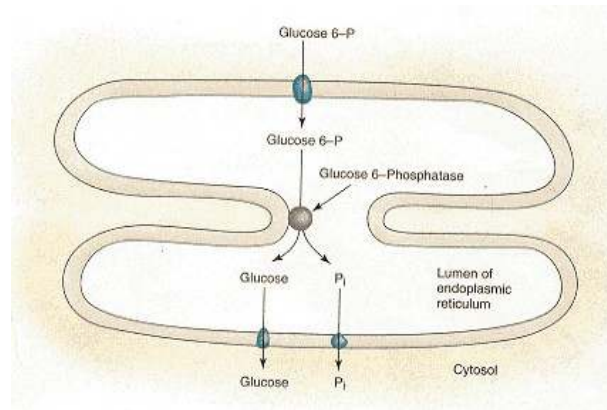

Figure 7.37

Glucose 6-phosphate is hydrolyzed by glucose 6-phosphatase located on the cisternal surface of the endoplasmic reticulum.

Three transporters are involved: one moves glucose 6-phosphate into the lumen, a second moves P_i back to the cytosol, and a third moves glucose back into the cytosol.

hydrolysis within the endoplasmic reticulum. A genetic defect in either the translocase or the phosphatase interferes with gluconeogenesis and results in accumulation of glycogen in liver, as discussed later for glycogen metabolism (Section 7.6).

Glucose Is Synthesized from the Carbon Chains of Some Amino Acids

All **amino acids** except **leucine** and **lysine** can supply carbon for net synthesis of glucose by gluconeogenesis (see Chapter 11). If catabolism of an amino acid can yield either net pyruvate or net oxaloacetate formation, then net glucose synthesis can occur from that amino acid. Oxaloacetate is an intermediate in gluconeogenesis and pyruvate is readily converted to oxaloacetate by action of pyruvate carboxylase (Figure 7.34). The abbreviated pathway given in Figure 7.31 shows where amino acid catabolism fits with the process of gluconeogenesis. Catabolism of amino acids feeds carbon into the tricarboxylic cycle at more than one point. As long as net synthesis of a TCA cycle intermediate occurs as a consequence of catabolism of a particular amino acid, net synthesis of oxaloacetate will follow. Reactions that lead to net synthesis of TCA cycle intermediates are called **anaplerotic reactions (anaplerosis)** and support gluconeogenesis because they provide for net synthesis of oxaloacetate. Reactions catalyzed by pyruvate carboxylase and glutamate dehydrogenase are good examples of anaplerotic reactions:

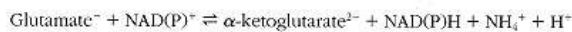
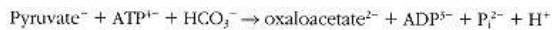

On the other hand, the reaction catalyzed by glutamate–oxaloacetate transaminase (α -ketoglutarate + aspartate \rightleftharpoons glutamate + oxaloacetate) is not anaplerotic because net synthesis of a TCA cycle intermediate is not accomplished. An intermediate of the TCA cycle is utilized in the reaction.

Since gluconeogenesis from amino acids imposes a nitrogen load on liver, a close relationship exists between urea synthesis and glucose synthesis from amino acids. This relationship is illustrated in Figure 7.38 for alanine. Two alanine molecules are shown being metabolized, one yielding NH_4^+ and the other aspartate, the primary substrates for the urea cycle. Aspartate leaves the mitochondrion and becomes part of the urea cycle after reacting with citrulline. Carbon of aspartate is released from the urea cycle as fumarate, which is then converted to malate by cytosolic fumarase. Both this malate and another malate

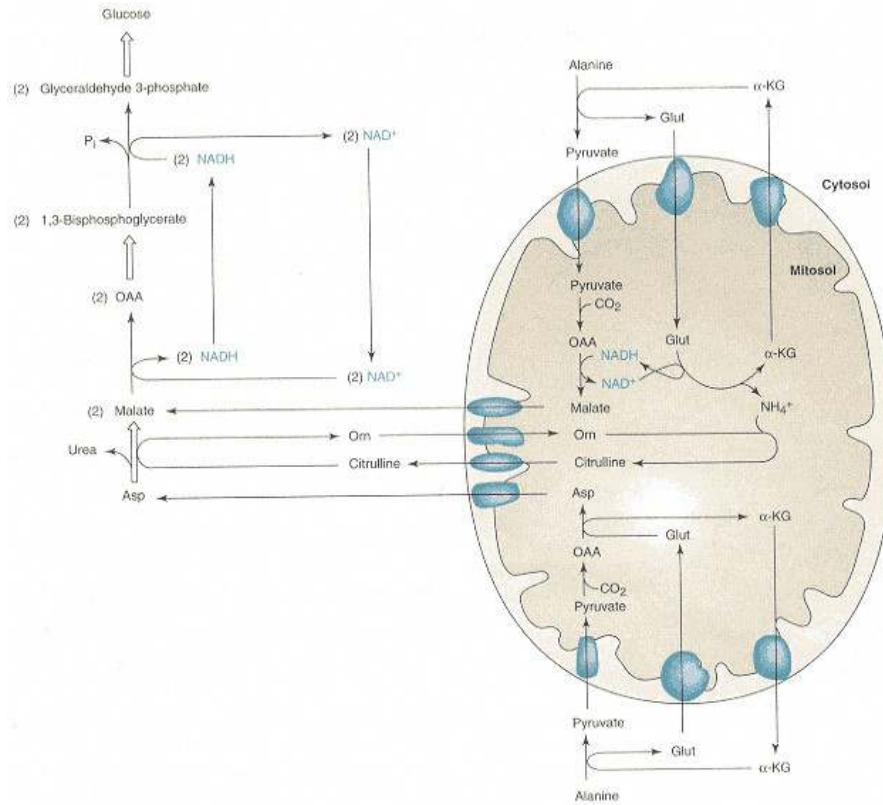

Figure 7.38

Pathway of gluconeogenesis from alanine and its relationship to urea synthesis.

exiting from the mitochondria are converted to glucose by cytosolic enzymes of gluconeogenesis. A balance is achieved between reducing equivalents (NADH) generated and those required in the cytosol and mitosol.

Leucine and **lysine** are the only amino acids that cannot function as carbon sources for net synthesis of glucose. These amino acids are **ketogenic** but not **glucogenic**. As shown in Table 7.2, all other amino acids are classified as glucogenic, or at least both glucogenic and ketogenic. Glucogenic amino acids give rise to net synthesis of either pyruvate or oxaloacetate, whereas amino acids that are both glucogenic and ketogenic also yield the ketone body acetoacetate, or acetyl CoA, which is readily converted into ketone bodies. Acetyl CoA is the end product of lysine metabolism, and acetoacetate and acetyl CoA are end products of leucine metabolism. No pathway exists for converting acetoacetate or acetyl CoA into pyruvate or oxaloacetate in humans and other animals. Acetyl CoA cannot be used for net synthesis of glucose because the reaction catalyzed by the **pyruvate dehydrogenase** complex is irreversible:

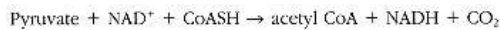
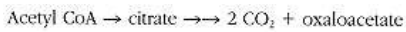

TABLE 7.2 Glucogenic and Ketogenic Amino Acids

<i>Glucogenic</i>	<i>Ketogenic</i>	<i>Both</i>
Glycine	Leucine	Threonine
Serine	Lysine	Isoleucine
Valine		Phenylalanine
Histidine		Tyrosine
Arginine		Tryptophan
Cysteine		
Proline		
Hydroxyproline		
Alanine		
Glutamate		
Glutamine		
Aspartate		
Asparagine		
Methionine		

It might be argued that oxaloacetate is generated from acetyl CoA by the TCA cycle:



However, this is a fallacious argument because it ignores the requirement for oxaloacetate in formation of citrate from acetyl CoA by **citrate synthase**:

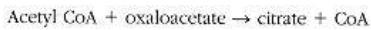

The TCA cycle then catalyzes

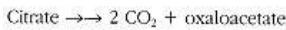

The true sum reaction is then

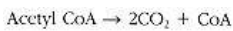

Since net synthesis of a **TCA cycle** intermediate does not occur during oxidation of acetyl CoA, it is impossible for animals to synthesize glucose from acetyl CoA.

Glucose Can Be Synthesized from Odd-Chain Fatty Acids

Lack of an anaplerotic pathway from acetyl CoA also means that in general it is impossible to synthesize glucose from fatty acids. Most fatty acids found in humans have straight chains with an even number of carbon atoms. Their catabolism by fatty acid oxidation followed by ketogenesis or complete oxidation to CO₂ can be abbreviated as in Figure 7.39. Since acetyl CoA and other intermediates of even-numbered fatty acid oxidation cannot be converted to oxaloacetate or any other intermediate of gluconeogenesis, it is impossible to synthesize glucose from fatty acids. An exception to this general rule applies to fatty acids with methyl branches (e.g., **phytanic acid**, a breakdown product of chlorophyll; see discussion of **Refsum's disease**, Clin. Corr. 9.6) and fatty acids with an odd number of carbon atoms. Catabolism of such compounds yields propionyl CoA:

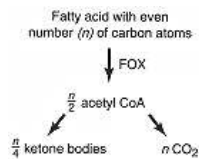
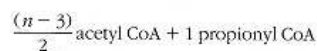

Figure 7.39
Overview of the catabolism of fatty acids to ketone bodies and CO₂.

Fatty acid with an odd number (*n*) of carbon atoms →



Propionate is a good precursor for gluconeogenesis, generating oxaloacetate by the anaplerotic pathway shown in Figure 7.40. The coenzyme A ester of

propionate is also produced in catabolism of valine and isoleucine and conversion of cholesterol into bile acids.

It is sometimes loosely stated that fat *cannot* be converted into carbohydrate (glucose) by liver. In a sense this is certainly true since catabolism of fatty acids with an even number of carbon atoms cannot give rise to net synthesis of glucose. However, the term "fat" refers to triacylglycerols, which are composed of three *O*-acyl groups combined with one glycerol molecule. Hydrolysis of a triacylglycerol yields three fatty acids and glycerol, the latter compound being an excellent substrate for gluconeogenesis (Figure 7.41). Phosphorylation of glycerol by **glycerol kinase** produces glycerol 3-phosphate, which can be converted by glycerol-3-phosphate dehydrogenase into dihydroxyacetone phosphate, an intermediate of the gluconeogenic pathway (see Figure 7.33). The last stage of glycolysis can compete with the gluconeogenic pathway and convert dihydroxyacetone phosphate into lactate (or into pyruvate for subsequent complete oxidation to CO₂ and H₂O).

Glucose Is Synthesized from Other Sugars

Fructose

Humans consume considerable quantities of fructose in the form of sucrose hydrolyzed in the small bowel. In the liver, fructose is phosphorylated by a special ATP-linked kinase (Figure 7.42), yielding fructose 1-phosphate (see Clin. Corr. 7.3). A special aldolase then cleaves **fructose 1-phosphate** to yield one molecule of dihydroxyacetone phosphate and one of glyceraldehyde. The latter is reduced to glycerol and used by the same pathway given in the previous figure. Two molecules of dihydroxyacetone phosphate obtainable from one molecule of fructose can be converted to glucose by enzymes of gluconeogenesis or, alternatively, into pyruvate or lactate by the last stage of glycolysis. In analogy to glycolysis, conversion of fructose into lactate is called **fructolysis**.

The major energy source of spermatozoa is fructose, formed from glucose by cells of seminal vesicles as shown in Figure 7.43. An NADPH-dependent reduction of glucose to sorbitol is followed by an NAD⁺-dependent oxidation of sorbitol to fructose. Fructose is secreted from seminal vesicles in a fluid that becomes part of semen. Although the fructose concentration in human semen can exceed 10 mM, tissues that come in contact with semen utilize fructose poorly, allowing this substrate to be conserved to meet the energy demands of spermatozoa in their search for ova. Spermatozoa contain mitochondria and thus can metabolize fructose completely to CO₂ and H₂O by the combination of fructolysis and TCA cycle activity.

Galactose

Milk sugar or **lactose** is an important source of **galactose** in the human diet. Glucose formation from galactose follows the pathway shown in Figure 7.44. **UDP-glucose** serves as a recycling intermediate in the overall process of converting galactose into glucose. Absence of the enzyme **galactose 1-phosphate uridylyltransferase** accounts for most cases of **galactosemia** (see Clin. Corr. 8.3).

Mannose

Mannose is found in very limited quantities in our diet. It is phosphorylated by hexokinase and then converted into fructose 6-phosphate by mannose phosphate isomerase:

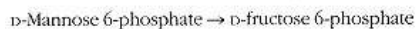
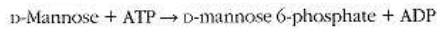

The latter compound can then be used in either glycolysis or gluconeogenesis.

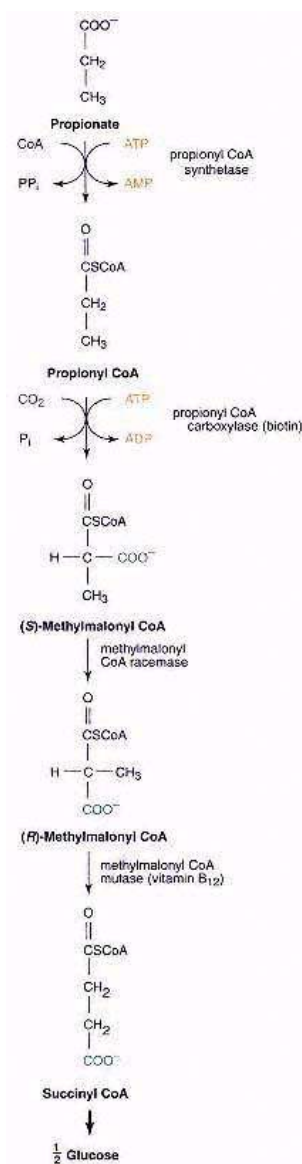

Figure 7.40

Pathway of gluconeogenesis from propionate.

The large arrow refers to steps of the tricarboxylic acid cycle plus steps of lactate gluconeogenesis (see Figure 7.33).

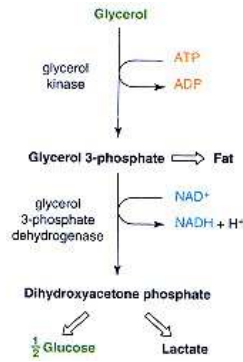

Figure 7.41
Pathway of gluconeogenesis from glycerol, along with competing pathways.

Large arrows indicate steps of the glycolytic and gluconeogenic pathways that have been given in detail in Figures 7.6 and 7.33, respectively. The large arrow pointing to fat refers to the synthesis of triacylglycerols and glycerophospholipids.

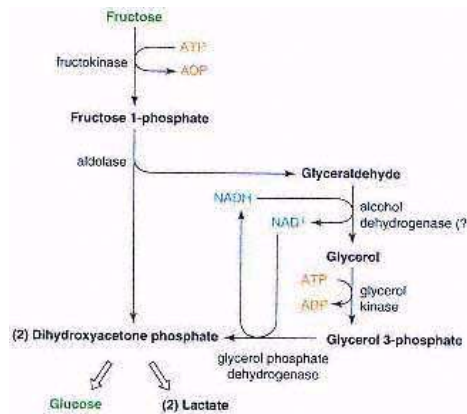

Figure 7.42
Pathway of glucose formation from fructose, along with the competing pathway of fructolysis.

Large arrows indicate steps of the glycolytic and gluconeogenic pathways that have been given in detail in Figures 7.6 and 7.33, respectively.

Gluconeogenesis Requires Expenditure of ATP

Synthesis of glucose is costly in terms of ATP. Six molecules are required for synthesis of one molecule of glucose from two molecules of lactate. ATP needed by liver cells for glucose synthesis is provided in large part by fatty acid oxidation. Metabolic conditions under which liver is required to synthesize glucose generally favor increased availability of fatty acids in blood. These fatty acids are oxidized by liver mitochondria to ketone bodies with concurrent production of large amounts of ATP. This ATP is used to support the energy requirements of gluconeogenesis, regardless of the substrate being used as carbon source for the process.

Gluconeogenesis Has Several Sites of Regulation

Sites of regulation of the gluconeogenesis pathway are apparent from the mass-action ratios and equilibrium constants in Table 7.1 and are further indicated in Figure 7.45. Those enzymes that are used to "go around" the irreversible steps of glycolysis are primarily involved in regulation of the pathway, that is, pyruvate carboxylase, PEP carboxykinase, fructose 1,6-bisphosphatase, and glucose 6-phosphatase. Regulation of hepatic gluconeogenesis is almost the

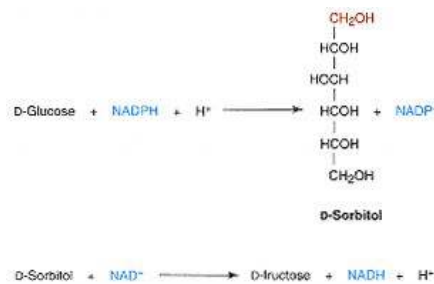

Figure 7.43
 The pathway responsible for the formation of sorbitol and fructose from glucose.

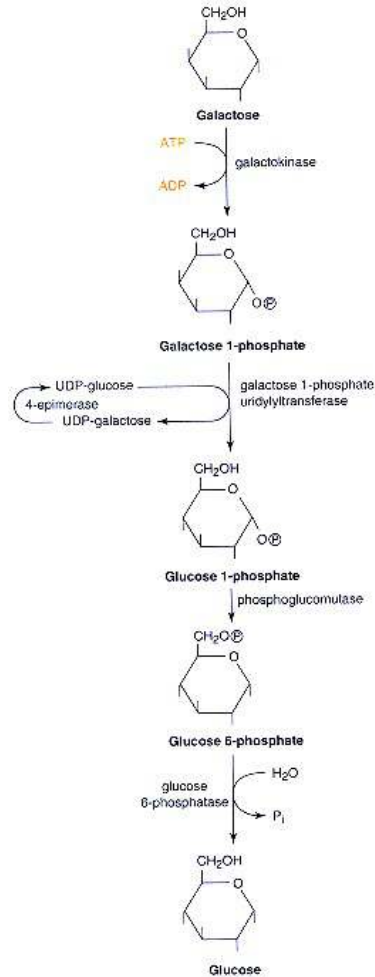

Figure 7.44
Pathway of glucose formation from galactose.

same as regulation of hepatic glycolysis. Inhibition of glycolysis at its chief regulatory sites, or repressing synthesis of enzymes involved at these sites (glucokinase, 6-phosphofructo-1-kinase, and pyruvate kinase), greatly increases effectiveness of opposing gluconeogenic enzymes. Turning on gluconeogenesis is therefore accomplished in large part by shutting off glycolysis. Fatty acid oxidation does more than just supply ATP for the process. It promotes glucose synthesis by increasing the steady-state concentration of mitochondrial acetyl CoA, a positive allosteric effector of the mitochondrial **pyruvate carboxylase**. The increase in acetyl CoA and in pyruvate carboxylase activity results in a greater synthesis of citrate, a negative effector of 6-phosphofructo-1-kinase. A secondary effect of inhibition of 6-phosphofructo-1-kinase is a decrease in fructose 1,6-bisphosphate concentration, an activator of pyruvate kinase. This

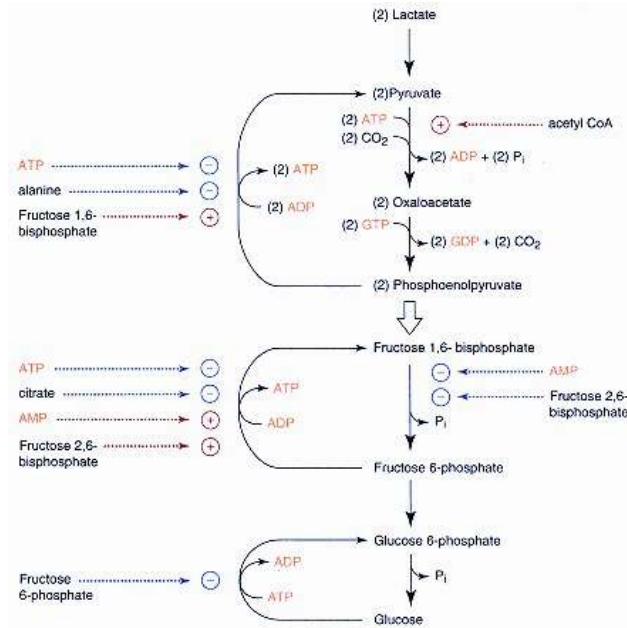

Figure 7.45

Important allosteric regulatory features of the gluconeogenic pathway.

decreases the flux of PEP to pyruvate by pyruvate kinase and increases effectiveness of the combined efforts of pyruvate carboxylase and PEP carboxykinase in conversion of pyruvate to PEP. An increase in ATP levels with the consequential decrease in AMP levels would favor gluconeogenesis by way of inhibition of 6-phosphofructo-1-kinase and pyruvate kinase and activation of fructose 1,6-bisphosphatase (see Figure 7.45 and the discussion of regulation of glycolysis, p. 283). A shortage of oxygen for respiration, a shortage of fatty acids for oxidation, or any inhibition or uncoupling of oxidative phosphorylation would be expected to cause liver to turn from gluconeogenesis to glycolysis.

Hormonal Control of Gluconeogenesis Is Critical for Homeostasis

Hormonal control of gluconeogenesis is a matter of regulating the supply of fatty acids to liver and the enzymes of both the glycolytic and gluconeogenic pathways. Glucagon increases plasma fatty acids by promoting lipolysis in adipose tissue, an action opposed by insulin. The greater availability of fatty acids results in more fatty acid oxidation by liver, which promotes glucose synthesis. Insulin has the opposite effect. Glucagon and insulin also regulate gluconeogenesis by influencing the state of phosphorylation of hepatic enzymes subject to covalent modification. As discussed previously (Figure 7.30), pyruvate kinase is active in the dephosphorylated mode and inactive in the phosphorylated mode. Glucagon activates adenylate cyclase to produce cAMP, which activates protein kinase A, which, in turn, phosphorylates and inactivates pyruvate kinase. Inactivation of this glycolytic enzyme stimulates the opposing pathway gluconeogenesis, by blocking the futile conversion of PEP to pyruvate. Glucagon also stimulates gluconeogenesis at the conversion of fructose 1,6-bisphosphate to fructose 6-phosphate by decreasing the concentration of fructose 2,6-bisphosphate in liver. **Fructose 2,6-bisphosphate** is an allosteric

activator of 6-phosphofructo-1-kinase and an allosteric inhibitor of fructose 1,6-bisphosphatase. Glucagon, again working via its second messenger cAMP, lowers fructose 2,6-bisphosphate levels by stimulating the phosphorylation of the bifunctional enzyme 6-phosphofructo-2-kinase/fructose 2,6-bisphosphatase. Phosphorylation of this enzyme inactivates the kinase activity that makes fructose 2,6-bisphosphate from F6P but activates the phosphatase activity that hydrolyzes fructose 2,6-bisphosphate back to F6P. The consequence is a glucagon-induced fall in fructose 2,6-bisphosphate levels, leading to a decrease in activity of 6-phosphofructo-1-kinase while fructose 1,6-bisphosphatase becomes more active (Figure 7.45). The overall effect is an increased conversion of FBP to F6P and a corresponding increase in the rate of gluconeogenesis. A resulting increase in fructose 6-phosphate may also favor gluconeogenesis by inhibition of glucokinase via an inhibitory protein (see discussion of the regulation of glycolysis, p. 283). Insulin has effects opposite to those of glucagon by mechanisms not completely defined.

Glucagon and insulin also have long-term effects on hepatic glycolysis and gluconeogenesis by induction and repression of synthesis of key enzymes of the pathways. A high glucagon/insulin ratio in blood increases the enzymatic capacity for gluconeogenesis and decreases enzymatic capacity for glycolysis in liver. A low glucagon/insulin ratio has the opposite effects. The glucagon/insulin ratio increases when gluconeogenesis is needed and decreases when glucose is plentiful from the gastrointestinal tract. Glucagon signals induction of synthesis of greater quantities of PEP carboxykinase, fructose 1,6-bisphosphatase, glucose 6-phosphatase, and various aminotransferases. A model for how this occurs is given in Figure 7.46. Binding of glucagon to its plasma membrane receptor increases cAMP, which activates protein kinase A. Protein kinase A

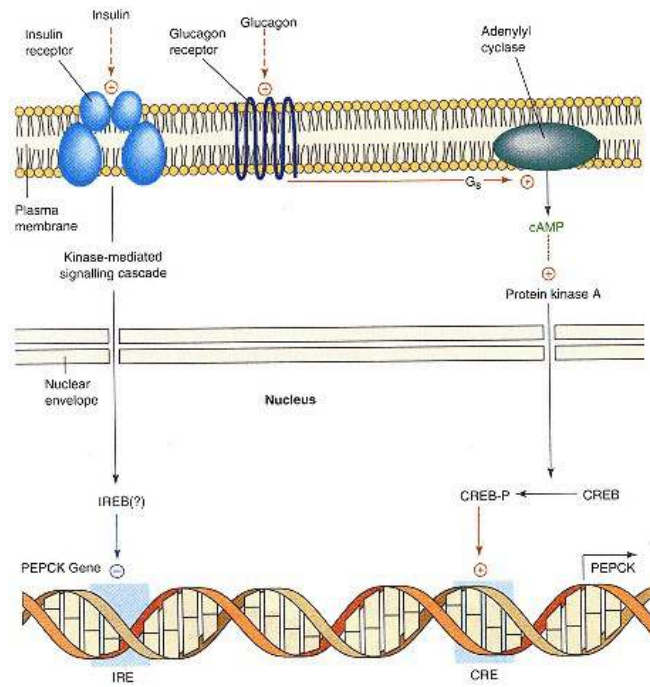

Figure 7.46

Glucagon promotes transcription of the gene that encodes PEP carboxykinase.

Abbreviations: PEPCK, PEP carboxykinase; CRE, cAMP-response element; CREB, cAMP-response element binding protein; IRE, insulin-response element; IREB, insulin-response element binding protein.

CLINICAL CORRELATION 7.10**Hypoglycemia and Alcohol Intoxication**

Consumption of alcohol, especially by an undernourished person, can cause hypoglycemia. The same effect can result from drinking alcohol after strenuous exercise. In both cases the hypoglycemia results from the inhibitory effects of alcohol on hepatic gluconeogenesis and thus occurs under circumstances of hepatic glycogen depletion. The problem is caused by the NADH produced during the metabolism of alcohol. The liver simply cannot handle the reducing equivalents provided by ethanol oxidation fast enough to prevent metabolic derangements. The extra reducing equivalents block the conversion of lactate to glucose and promote the conversion of alanine into lactate, resulting in considerable lactate accumulation in the blood. Since lactate has no place to go, lactic acidosis (see Clin. Corr. 7.5) can develop, although it is usually mild.

Low doses of alcohol cause impaired motor and intellectual performance; high doses have a depressant effect that can lead to stupor and anesthesia. Low blood sugar can contribute to these undesirable effects of alcohol. What is more, a patient may be thought to be inebriated when in fact the patient is suffering from hypoglycemia that may lead to irreversible damage to the central nervous system. Children are highly dependent on gluconeogenesis while fasting, and accidental ingestion of alcohol by a child can produce severe hypoglycemia (see Clin. Corr. 7.9).

Krebs, H. A., Freedland, R. A., Hems, R., and Stubbs, M. Inhibition of hepatic gluconeogenesis by ethanol. *Biochem. J.* 112:117, 1969; and Service, F. J. Hypoglycemia. *Med. Clin. North Am.* 79:1, 1995.

then phosphorylates a protein called the **cAMP-response element binding protein (CREB)**, a trans-acting factor that in its phosphorylated form can bind to a **cAMP-response element (CRE)**, a cis acting element within the regulatory region of genes that respond to cAMP. This promotes transcription of genes encoding key gluconeogenic enzymes such as **PEP carboxykinase** (Figure 7.46). By a similar mechanism, but one that causes repression of **gene transcription**, glucagon acts to decrease the amounts of glucokinase, 6-phosphofructo-1-kinase, and pyruvate kinase. Insulin opposes the action of glucagon (Figure 7.46), acting through a signal cascade that results in activation of an insulin-response element binding protein (IREB), which inhibits transcription of genes encoding key gluconeogenic enzymes by binding to an **insulin-response element (IRE)** in the regulatory region of such genes. When glucose synthesis is not needed, synthesis of key gluconeogenic enzymes is turned off and synthesis of key glycolytic enzymes is turned on as a consequence of a decrease in the blood glucagon/insulin ratio.

Ethanol Ingestion Inhibits Gluconeogenesis

Ethanol inhibits gluconeogenesis by liver (see Clin. Corr. 7.10). It is oxidized primarily in liver with production of a large load of reducing equivalents that must be transported into the mitochondria by the **malate-aspartate shuttle**. This excess NADH in the cytosol creates problems for liver gluconeogenesis because it forces the equilibrium of the lactate dehydrogenase- and malate dehydrogenase-catalyzed reactions in the directions of lactate and malate formation, respectively:

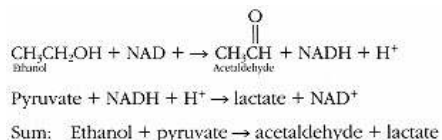

or

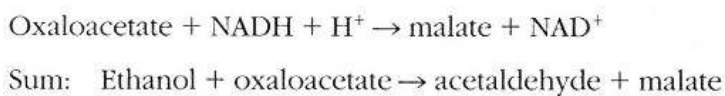

Forcing these reactions in the directions shown above inhibits glucose synthesis by limiting the amounts of pyruvate and oxaloacetate available for the reactions catalyzed by pyruvate carboxylase and PEP carboxykinase, respectively.

7.6—**Glycogenolysis and Glycogenesis****Glycogen, a Storage Form of Glucose, Is Required as a Ready Source of Energy**

Glycogenolysis refers to breakdown of glycogen to glucose or glucose 6-phosphate; and **glycogenesis** refers to synthesis of glycogen. These processes are of some importance in almost every tissue but especially in muscle and liver. The liver has tremendous capacity for storing glycogen. In the well-fed human, liver glycogen content can account for as much as 10% of wet weight of this organ. Muscle stores less when expressed on the same basis—a maximum of only 1–2% of its wet weight. However, since the average person has more muscle than liver, there is about twice as much total muscle glycogen as liver glycogen.

Muscle and liver **glycogen stores** serve completely different roles. Glycogen serves as a fuel reserve for the synthesis of ATP within muscle, whereas liver glycogen functions as a glucose reserve for the maintenance of blood glucose concentrations. Liver glycogen levels vary greatly in response to the intake of food, accumulating to high levels shortly after a meal and then decreasing slowly as it is mobilized to help maintain a nearly constant blood glucose level (see Figure 7.47). Liver glycogen is called into play between meals and to a greater extent during the nocturnal fast. In both humans and the rat, the store of liver glycogen lasts somewhere between 12 and 24 h during fasting, depending greatly, of course, on whether the individual under consideration is caged or running wild.

Muscle glycogen is a source of ATP for increased muscular activity. Most of the glucose of glycogen is consumed within muscle cells without formation of free glucose as an intermediate. However, because of a special feature of glycogen catabolism to be discussed below, about 8% of muscle glycogen is converted into free glucose within the tissue. Some of this glucose may be released into the bloodstream, but most gets metabolized by glycolysis in muscle. Since muscle lacks glucose 6-phosphatase, and most free glucose formed during glycogen breakdown is further catabolized, muscle glycogen is not of quantitative importance in maintenance of blood glucose levels in the fasting state. Liver glycogen converted to glucose by glycogenolysis and glucose 6-phosphatase is of much greater importance as a source of blood glucose in the fasting state. Conversion of glucose to glycogen in muscle plays an important role in lowering blood glucose levels elevated by a high carbohydrate meal. Glycogenesis in liver contributes to the lowering of blood glucose but is of less importance than glycogen synthesis in muscle.

Exercise of a muscle triggers mobilization of muscle glycogen for formation of ATP. The yield of ATP and the fate of the carbon of glycogen depend on whether a "white" or "red" muscle is under consideration. Red muscle fibers are supplied with a rich blood flow, contain large amounts of myoglobin, and are packed with mitochondria. Glycogen mobilized within these cells is converted into pyruvate, which, because of the availability of O_2 and mitochondria, can be converted into CO_2 and H_2O . In contrast, white muscle fibers have a poorer blood supply and fewer mitochondria. **Glycogenolysis** within this tissue supplies substrate for glycolysis, with the end product being primarily lactate. **White muscle fibers** have enormous capacity for glycogenolysis and glycolysis, much more than **red muscle fibers**. Since their glycogen stores are limited, however, muscles of this type can only function at full capacity for relatively short periods of time. Breast muscle and the heart of chicken are good examples of white and red muscles, respectively. The heart has to beat

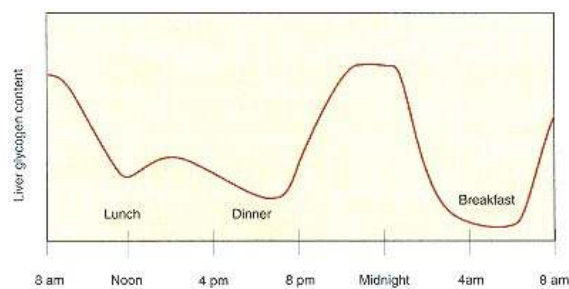

Figure 7.47
Variation of liver glycogen levels between meals and during the nocturnal fast.

continuously and has many mitochondria and a rich supply of blood via the coronary arteries. The heart stores glycogen to be used when a greater work load is imposed. Breast muscle of chicken is not continuously carrying out work. Its important function is to enable the chicken to fly rapidly for short distances, as in fleeing from predators (or amorous roosters). Because glycogen can be mobilized so rapidly, breast muscle is designed for maximal activity for a relatively short period of time. Although it was easy to point out readily recognizable white and red muscles in the chicken, most skeletal muscles of the human body are composed of a mixture of red and white fibers in order to provide for both rapid and sustained muscle activity. The distribution of white and red muscle fibers in cross sections of a human skeletal muscle can be shown by using special staining procedures (see Figure 7.48).

Glycogen granules are abundant in **liver** of the well-fed animal but are virtually absent from liver of the 24-h-fasted animal (Figure 7.49). Heavy exercise causes the same loss of glycogen granules in muscle fibers. These granules of glycogen correspond to clusters of glycogen molecules, the molecular weights of which can approach 2×10^7 Da. Glycogen is composed entirely of glucosyl residues, the majority of which are linked together by α -1,4-glycosidic linkages (Figure 7.50). Branches also occur in the glycogen molecule, however, because of frequent α -1,6-glycosidic linkages (Figure 7.50). A limb of the glycogen "tree" (see Figure 7.51) is characterized by branches at every fourth glucosyl residue within the more central core of the molecule. These branches occur much less frequently in outer regions of the molecule. An interesting question, which we shall attempt to answer below, is why this polymer is constructed with so many intricate branches and loose ends. Glycogen certainly stands in contrast to proteins and nucleic acids in this regard but, of course, it is a storage form of fuel and never has to catalyze a reaction or convey information within a cell.

Glycogen Phosphorylase Catalyzes the First Step in Glycogen Degradation

Glycogen phosphorylase catalyzes **phosphorolysis** of glycogen, a reaction in which P_i is used in the cleavage of an α -1,4-glycosidic linkage to yield glucose 1-phosphate (Figure 7.52). This always occurs at a terminal, nonreducing end of a glycogen molecule:

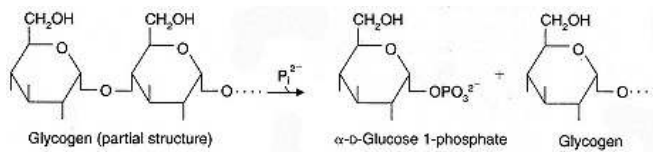

The reaction catalyzed by glycogen phosphorylase should be distinguished from that catalyzed by α -amylase, which degrades glycogen and starch in the gut (see Chapter 26). **α -Amylase** acts by simple hydrolysis, using water rather than inorganic phosphate to cleave α -1,4-glycosidic bonds. Glycogen may contain up to 100,000 glucose residues; its structure is usually abbreviated (glucose)_n. The reaction catalyzed by glycogen phosphorylase is written as

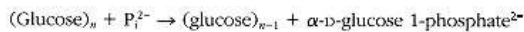

The next step of glycogen degradation is catalyzed by **phosphoglucomutase**:

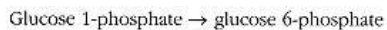

This is a near-equilibrium reaction under intracellular conditions, allowing it to function in both glycogen degradation and synthesis. Like phosphoglycerate mutase (see p. 277), a bisphosphate compound is an obligatory interme-

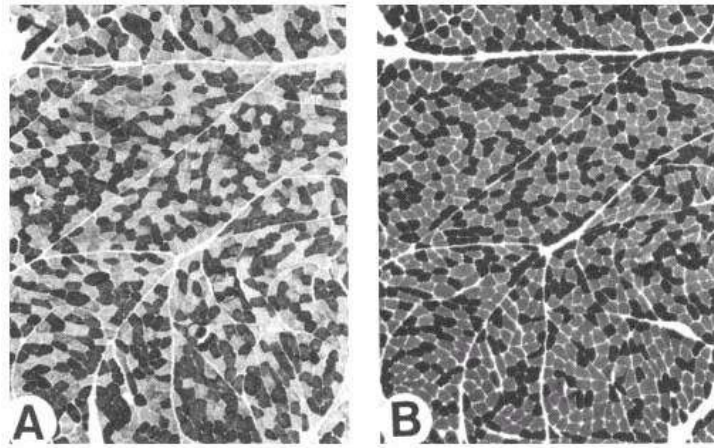

Figure 7.48

Cross section of human skeletal muscle showing red and white muscle fibers.

Sections were stained for NADH diaphorase activity in (a) for ATPase activity in (b). The red fibers are dark and the white fibers are light in (a); vice versa in (b).

Pictures generously provided by Dr. Michael H. Brooke of the Jerry Lewis Neuromuscular Research Center, St. Louis, Missouri.

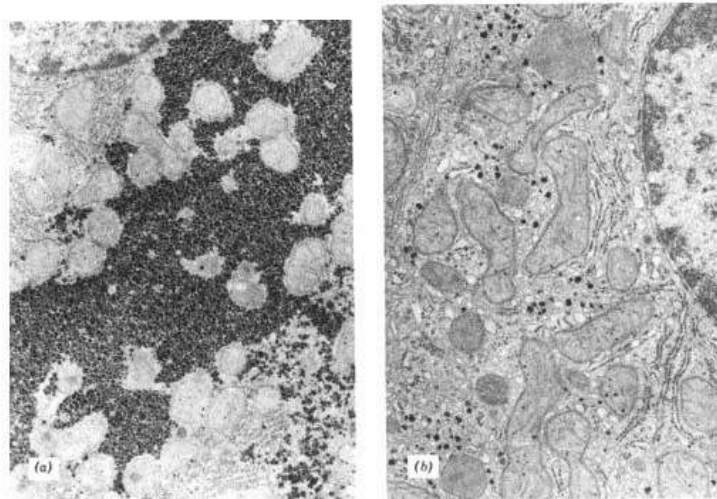

Figure 7.49

Electron micrographs showing glycogen granules (darkly stained material) in the liver of a well-fed rat (a) and the relative absence of such granules in the liver of a rat starved for 24 h (b).

Micrographs generously provided by Dr. Robert R. Cardell of the Department of Anatomy at the University of Cincinnati.

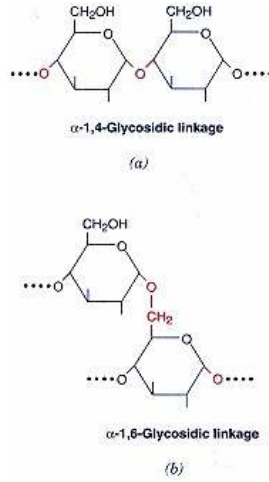
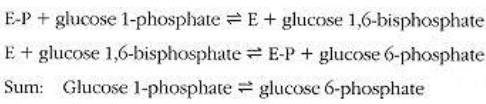
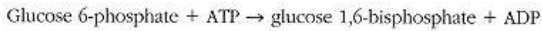

Figure 7.50
Two types of linkage between glucose molecules are present in glycogen.

diate:



A catalytic amount of glucose 1,6-bisphosphate must be present for the reaction to occur. It is produced in small quantities for this specific purpose by an enzyme called **phosphoglucokinase**:



The next enzyme involved in glycogenolysis depends on the tissue under consideration (Figure 7.52). In liver, glucose 6-phosphate produced by glycogenolysis is hydrolyzed by **glucose 6-phosphatase** to give free glucose:

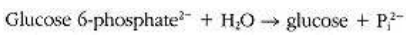

Lack of this enzyme or of the translocase that transports G6P into the endoplasmic reticulum (Figure 7.37) results in type 1 **glycogen storage disease** (see Clin. Corr. 7.11). The overall balanced equation for removal of one glucosyl residue from glycogen in liver by glycogenolysis is then

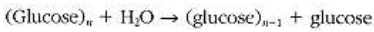

In other words, glycogenolysis in liver involves phosphorolysis but, because the phosphate ester is cleaved by a phosphatase, the overall reaction adds up to hydrolysis of glycogen. No ATP is used or formed in glycogenolysis.

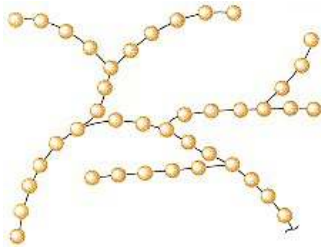

Figure 7.51
The branched structure of glycogen.

In peripheral tissues the G6P generated by glycogenolysis is used by glycolysis, leading primarily to the generation of lactate in white muscle fibers and primarily to complete oxidation to CO_2 in red muscle fibers. Since no ATP had to be invested to produce G6P obtained from glycogen, the overall equation

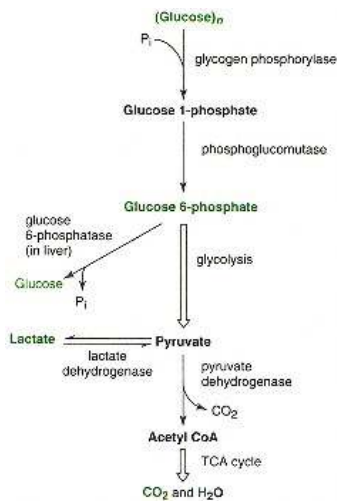

Figure 7.52
Glycogenolysis and the fate of glycogen degraded in liver versus its fate in peripheral tissues.

CLINICAL CORRELATION 7.11**Glycogen Storage Diseases**

There are a number of well-characterized glycogen storage diseases, all due to inherited defects of one or more of the enzymes involved in the synthesis and degradation of glycogen. The liver is usually the tissue most affected, but heart and muscle glycogen metabolism can also be defective.

Chen, Y. T., and Burchell, A. Glycogen storage diseases. In C. R. Scriver, A. L. Beaudet, W. S. Sly, and D. Valle (Eds.), *The Metabolic and Molecular Bases of Inherited Disease*, 7th ed. New York: McGraw-Hill, 1995, pp. 935–965.

Von Gierke's Disease

The most common glycogen storage disease, referred to as type I or von Gierke's disease, is caused by a deficiency of liver, intestinal mucosa, and kidney glucose 6-phosphatase. Thus diagnosis by small bowel biopsy is possible. Patients with this disease can be further subclassified into those lacking the glucose 6-phosphatase enzyme per se (type Ia) and those lacking the glucose 6-phosphatase translocase (type Ib) (see Figure 7.37). A genetic abnormality in glucose 6-phosphate hydrolysis occurs in only about 1 person in 200,000 and is transmitted as an autosomal recessive trait. Clinical manifestations include fasting hypoglycemia, lactic acidemia hyperlipidemia, and hyperuricemia with gouty arthritis. The fasting hypoglycemia is readily explained as a consequence of the glucose 6-phosphatase deficiency, the enzyme required to obtain glucose from liver glycogen and gluconeogenesis. The liver of these patients does release some glucose by the action of the glycogen debranching enzyme. The lactic acidemia occurs because the liver cannot use lactate effectively for glucose synthesis. In addition, the liver inappropriately produces lactic acid in response to glucagon. This hormone should trigger glucose release without lactate production; however, the opposite occurs because of the lack of glucose 6-phosphatase. Hyperuricemia results from increased purine degradation in the liver; hyperlipidemia results because of increased availability of lactic acid for lipogenesis and lipid mobilization from the adipose tissue caused by high glucagon levels in response to hypoglycemia. The manifestations of von Gierke's disease can greatly be diminished by providing carbohydrate throughout the day to prevent hypoglycemia. During sleep this can be done by infusion of carbohydrate into the gut by a nasogastric tube.

Cori, G. T., and Cori, C. F. Glucose-6-phosphatase of the liver in glycogen storage disease. *J. Biol. Chem.* 199:661, 1952.

Pompe's Disease

Type II glycogen storage disease or Pompe's disease is caused by the absence of α -1,4-glucosidase (or acid maltase), an enzyme normally found in lysosomes. The absence of this enzyme leads to the accumulation of glycogen in virtually every tissue. This is somewhat surprising, but lysosomes take up glycogen granules and become defective with respect to other functions if they lack the capacity to destroy the granules. Because other synthetic and degradative pathways of glycogen metabolism are intact, metabolic derangements such as those in von Gierke's disease are not seen. The reason for extralysosomal glycogen accumulation is unknown. Massive cardiomegaly occurs and death results at an early age from heart failure.

Hers, H. G. α -Glucosidase deficiency in generalized glycogen storage disease (Pompe's disease). *Biochem. J.* 86:11, 1963.

Cori's Disease

Also called type III glycogen storage disease, Cori's disease is caused by a deficiency of the glycogen debranching enzyme. Glycogen accumulates because only the outer branches can be removed from the molecule by phosphorylase. Hepatomegaly occurs but diminishes with age. The clinical manifestations are similar to but much milder than those seen in von Gierke's disease, because gluconeogenesis is unaffected, and hypoglycemia and its complications are less severe.

Van Hoff, F., and Hers, H. G. The subgroups of type III glycogenesis. *Eur. J. Biochem.* 2:265, 1967.

McArdle's Disease

Also called the type V glycogen storage disease, McArdle's disease is caused by an absence of muscle phosphorylase. Patients suffer from painful muscle cramps and are unable to perform strenuous exercise, presumably because muscle glycogen stores are not available to the exercising muscle. Thus the normal increase in plasma lactate (released from the muscle) following exercise is absent. The muscles are probably damaged because of inadequate energy supply and glycogen accumulation. Release of muscle enzymes creatine kinase and aldolase and of myoglobin is common; elevated levels of these substances in the blood suggests a muscle disorder.

McArdle, B. Myopathy due to a defect in muscle glycogen breakdown. *Clin. Sci.* 10:13, 1951.

for glycogenolysis followed by glycolysis is

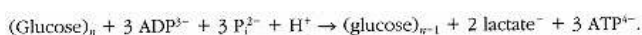
**Debranching Enzyme Is Required for Complete Hydrolysis of Glycogen**

The first enzyme involved in glycogen degradation, glycogen phosphorylase, is specific for α -1,4-glycosidic linkages. However, it stops attacking α -1,4-glycosidic linkages four glucosyl residues from an α -1,6-branch point. A glycogen molecule that has been degraded by phosphorylase to the limit caused by the branches is called phosphorylase-**limit dextrin**. The action of a **debranching**

enzyme is what allows glycogen phosphorylase to continue to degrade glycogen. Debranching enzyme is a bifunctional enzyme that catalyzes two reactions necessary for debranching of glycogen. The first is a 4- α -D-glucanotransferase activity in which a strand of three glucosyl residues is removed from a four glucosyl residue branch of the glycogen molecule (Figure 7.53). The strand remains covalently attached to the enzyme until it can be transferred to a free 4-hydroxyl of a glucosyl residue at the end of the same or an adjacent glycogen molecule. The result is a longer amylose chain with only one glucosyl residue remaining in α -1,4-linkage. This linkage is broken hydrolytically by the second enzyme activity of debranching enzyme, which is its **amyllo- α -1,6-glucosidase** activity:

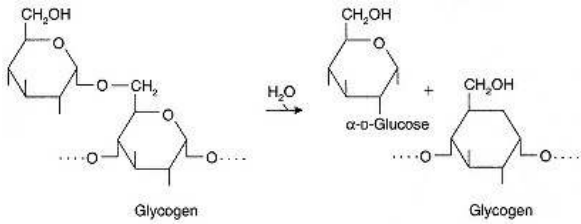

The cooperative and repetitive action of phosphorylase and debranching enzyme results in complete phosphorolysis and hydrolysis of glycogen. **Glycogen**

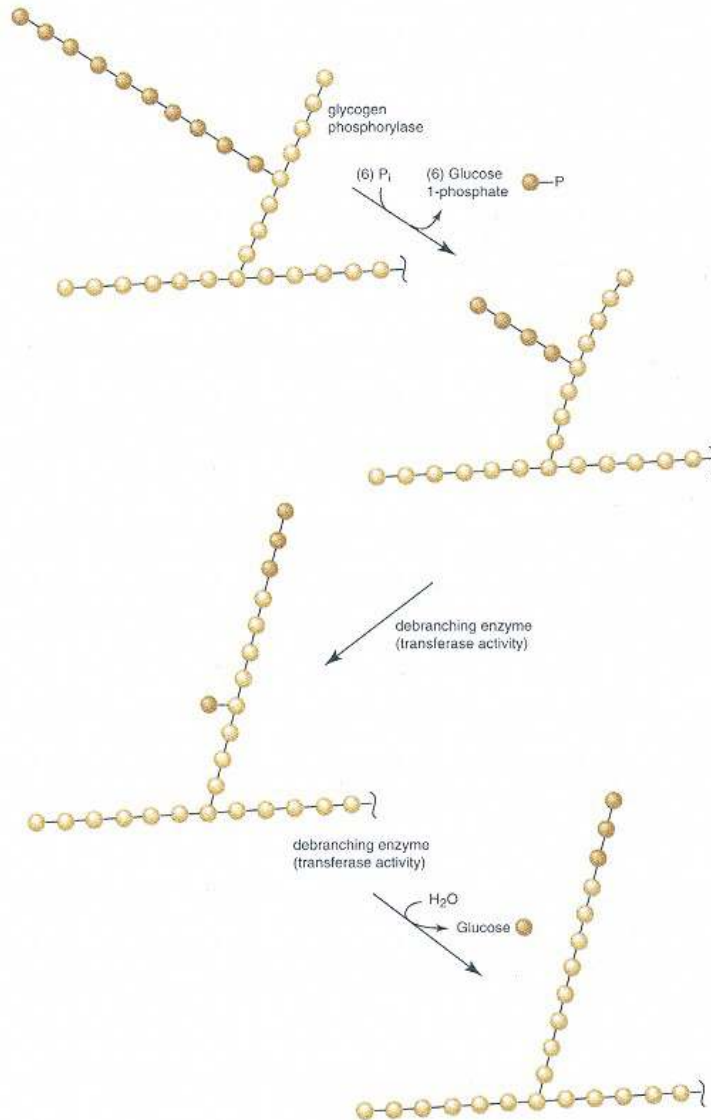

storage diseases result when either of these enzymes is defective. The average molecule of glycogen yields about 12 molecules of glucose 1-phosphate by action of phosphorylase for every molecule of free glucose produced by action of debranching enzyme.

There is another, albeit quantitatively less important, pathway for glycogen degradation. A defect in this minor pathway, however, creates a major problem. As pointed out in Clin. Corr. 7.11, a **glucosidase** present in lysosomes degrades glycogen that enters these organelles during normal turnover of intracellular components.

Synthesis of Glycogen Requires Unique Enzymes

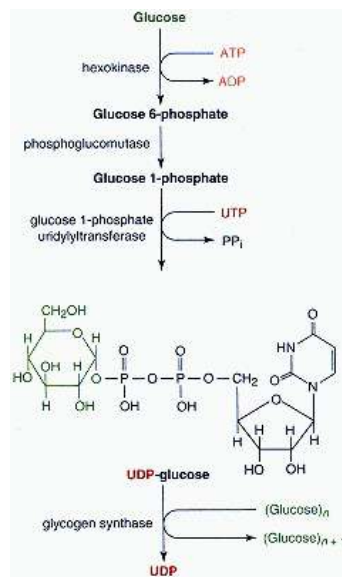
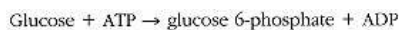
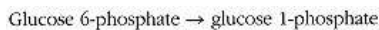

Figure 7.54
Pathway of glycogen synthesis.

The first reaction involved in **glycogen synthesis** (Figure 7.54) is already familiar, being catalyzed by glucokinase in hepatic tissue and hexokinase in peripheral tissues:



Phosphoglucomutase, discussed in relation to glycogen degradation, catalyzes a readily reversible reaction as follows:



A unique reaction found at the next step involves formation of UDP-glucose by action of **glucose 1-phosphate uridylyltransferase**:

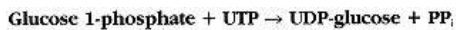

This reaction generates UDP-glucose, sometimes called "**activated glucose**" because of its large negative free energy of hydrolysis, which is used to build the glycogen molecule. Formation of UDP-glucose is made energetically favorable and irreversible by hydrolysis of pyrophosphate by **pyrophosphatase**:

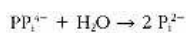

Glycogen Synthase

Glycogen synthase catalyzes transfer of the activated glucosyl moiety of UDP-glucose to a glycogen molecule to form a new glycosidic bond between the hydroxyl group of C-1 of the activated sugar and C-4 of a glucosyl residue of the growing glycogen chain. The reducing end of glucose (C-1 of glucose is an aldehyde that can reduce other compounds) is always added to a nonreducing end of the glycogen chain. The glycogen molecule, regardless of its size, theoretically has only one free reducing end tucked away within its core. UDP formed as a product of glycogen synthase is converted back to UTP by action of **nucleoside diphosphate kinase**:

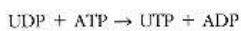

Glycogen synthase creates chains of glucose molecules with α -1,4-glycosidic linkages, but does not form the α -1,6-glycosidic branches found in glycogen. Its action alone would only produce α -amylose, a straight-chain polymer of glucose with α -1,4-glycosidic linkages. Once an amylose chain of at least 11 residues has been formed, a "**branching**" enzyme comes into play. Its name is **1,4- α -glucan branching enzyme** because it removes a block of about seven glucosyl residues from a growing chain and transfers it to another chain to produce an α -1,6 linkage (see Figure 7.55). The new branch has to be introduced at least four glucosyl residues from an adjacent branch point. Thus the creation of the highly branched structure of glycogen requires the concerted efforts of glycogen synthase and branching enzyme. The overall balanced equation for

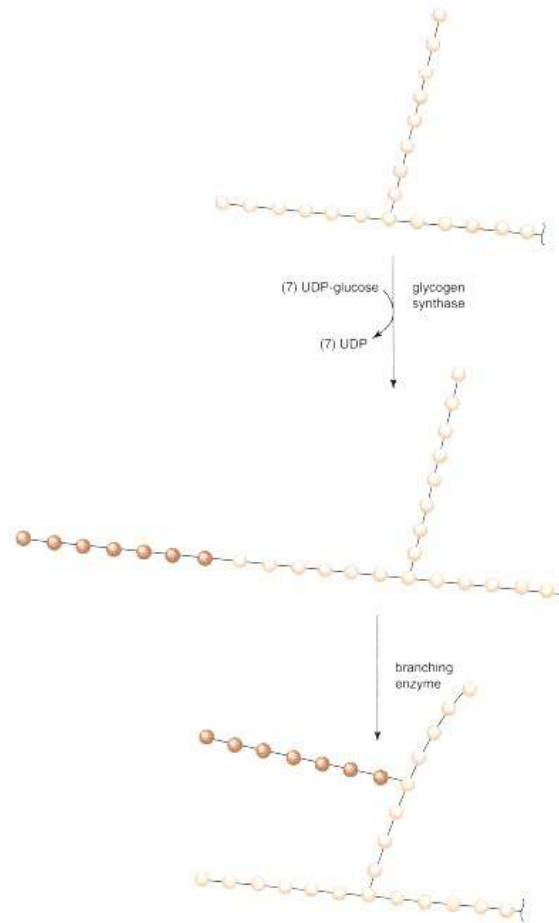
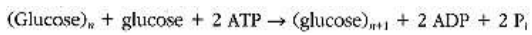
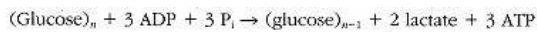

Figure 7.55
Action of the glycogen branching enzyme.

glycogen synthesis by the pathway just outlined is



As noted above, the combination of glycogenolysis and glycolysis yields only three molecules of ATP per glucosyl residue:



Thus the combination of glycogen synthesis plus glycogen degradation to lactate actually yields only one ATP. However, glycogen synthesis and degradation are normally carried out at different times in a cell. For example, white muscle fibers synthesize glycogen at rest when glucose is plentiful and less ATP is needed for muscle contraction. Glycogen is then used during periods of exertion. Although in such terms glycogen storage is not a very efficient process, it provides cells with a fuel reserve that can be very quickly and efficiently mobilized.

Special Features of Glycogen Degradation and Synthesis

Why Store Glucose As Glycogen?

Since **glycogen** is such a good fuel reserve, it is obvious why we synthesize and store glycogen in liver and muscle. But why not store our excess glucose calories entirely as fat instead of glycogen? The answer is at least threefold: (1) we do store **fat**, but fat cannot be mobilized nearly as rapidly in muscle as glycogen; (2) fat cannot be used as a source of energy in the absence of oxygen; and (3) fat cannot be converted to glucose to maintain blood glucose levels. Why not just pump glucose into cells and store it as free glucose until needed? Why waste so much ATP making a polymer out of glucose? The problem is that glucose is osmotically active. It would cost ATP to "pump" glucose into a cell against a concentration gradient, and glucose would have to reach concentrations of 400 mM in liver cells to match the "glucose reserve" provided by the usual liver glycogen levels. Unless balanced by outward movement of some other osmotically active compound, accumulation of such concentrations of glucose would cause uptake of considerable water and osmotic lysis of the cell. Assuming the molecular mass of a glycogen molecule is of the order of 10^7 Da, 400 mM glucose is in effect stored at an intracellular glycogen concentration of $0.01 \mu\text{M}$. Storage of glucose as glycogen therefore creates no osmotic pressure problem for the cell.

Glycogenin Is Required As a Primer for Glycogen Synthesis

Like DNA synthesis, a primer is needed for glycogen synthesis. No template, however, is required. Glycogen itself is the usual **primer**, in that glycogen synthesis can take place by addition of glucosyl units to glycogen "core" molecules, which are almost invariably present in the cell. The outer regions of the glycogen molecule get removed and resynthesized more rapidly than the inner core. Glycogen within a cell is frequently sheared by the combined actions of glycogen phosphorylase and debranching enzyme but is seldom obliterated before glycogen synthase and branching enzyme rebuild the molecule. This begs the question why glycogen is a branched molecule with only one real beginning (the reducing end) and many branches terminating with nonreducing glucosyl units. The answer is that this gives numerous sites of attack for glycogen phosphorylase on a mature glycogen molecule and the same number of sites that function as primers for the addition of glucosyl units by glycogen synthase. If cells synthesized **α -amylase**, that is, an unbranched glucose polymer, there would only be one nonreducing end per molecule. This would surely make glycogen degradation and synthesis much slower. As it is, glycogen phosphorylase and glycogen synthase are found in tight association with glycogen granules in a cell. By taking up residence in the branches of the glycogen tree, both enzymes have ready access to a multitude of nonreducing sugars at the ends of the limbs.

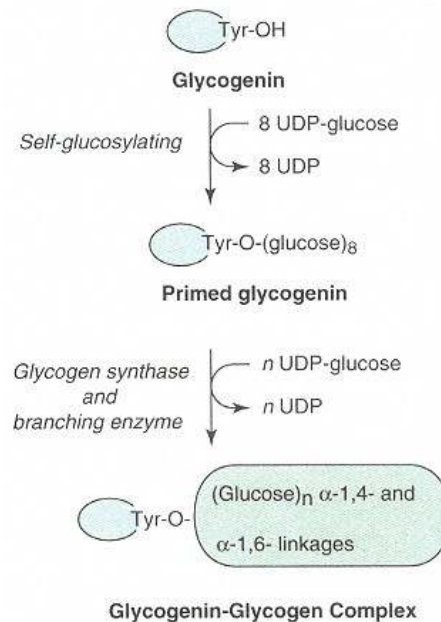

Figure 7.56
Glycogenin provides a primer for glycogen synthesis by glycogen synthase. Tyr designates a tyrosine residue of glycogenin.

But why is a primer needed for glycogen synthesis? It turns out to be impossible to initiate glycogen synthesis with simply a glucose molecule as the acceptor of an activated glucosyl residue from UDP-glucose. Glycogen synthase has a very low K_m for very large glycogen molecules and therefore readily adds glucosyl residues to make even larger glycogen molecules. However, the K_m gets larger and larger as the glycogen molecule gets smaller and smaller. This phenomenon is so pronounced that glucose, at its physiological concentration, could never function as a primer. This led for some time to the notion that glycogen must be immortal; that is, some glycogen must be handed down from one cell generation to the next in order for glycogen to be synthesized. However, it is now known that a polypeptide of 332 amino acids called **glycogenin** functions as a primer for glycogen synthesis. Glycogenin is a self-glucosylating enzyme that uses UDP-glucose to link glucose to one of its own tyrosine residues (Figure 7.56). Glycosylated glycogenin then serves as a primer for synthesis of glycogen. Alas, glycogen is not immortal.

Glycogen Limits Its Own Synthesis

If glycogen synthase becomes more efficient as the glycogen molecule gets bigger, how is synthesis of this ball of sugar curtailed? Fat cells have an almost unlimited capacity to pack away fat— but then fat cells have nothing else to do. Muscle cells participate in mechanical activity and liver cells carry out many processes other than glycogen synthesis. Even in the face of excess glucose, there has to be a way to limit the intracellular accumulation of glycogen. Glycogen itself inhibits glycogen synthase by a mechanism discussed later (see p. 326).

Glycogen Synthesis and Degradation Are Highly Regulated Pathways

Glycogen synthase and glycogen phosphorylase are regulatory enzymes of glycogen synthesis and degradation, respectively. Both catalyze nonequilibrium reactions, and both are subject to control by allosteric effectors and covalent modification.

Regulation of Glycogen Phosphorylase

Glycogen phosphorylase is subject to allosteric activation by AMP and allosteric inhibition by glucose and ATP (Figure 7.57). Control by these effectors is integrated with a very elaborate control by covalent modification. Phosphorylase exists in an *a* form, which is active, and a *b* form, which is inactive. These forms are interconverted by the actions of **phosphorylase kinase** and **phosphoprotein phosphatase** (Figure 7.57). A conformational change caused by phosphorylation transforms the enzyme into a more active catalytic state. Phosphorylase *b* has some catalytic activity and can be greatly activated by AMP. This allosteric effector has little activating effect, however, on the already active phosphorylase *a*. Hence the covalent modification mechanism can be bypassed by the allosteric mechanism and vice versa.

Phosphorylase kinase is responsible for phosphorylation and activation of phosphorylase (Figure 7.57). Moreover, phosphorylase kinase itself is also sub-

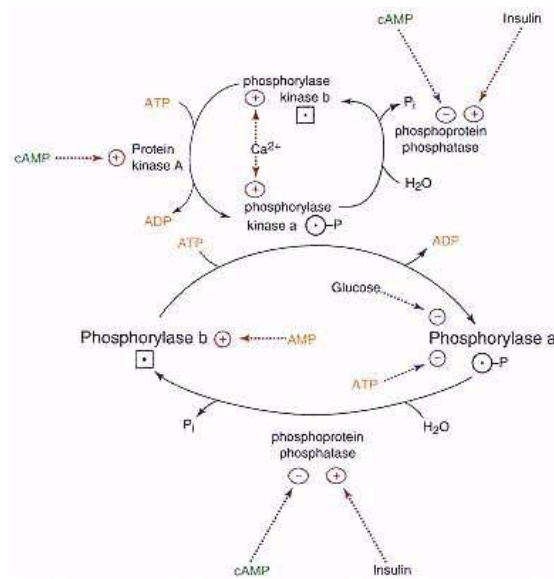

Figure 7.57
Regulation of glycogen phosphorylase by covalent modification.
 Phosphorylation converts glycogen phosphorylase and phosphorylase kinase from their inactive *b* forms to their active *a* forms.

ject to regulation by a cyclic phosphorylation–dephosphorylation mechanism. Protein kinase A phosphorylates and activates phosphorylase kinase; phospho-protein phosphatase in turn dephosphorylates and inactivates phosphorylase kinase. Phosphorylase kinase is a large enzyme complex (1.3×10^6 Da), composed of four subunits with four molecules of each subunit in the complex ($\alpha, \beta, \gamma, \delta$). Catalytic activity resides with the γ subunit; α , β , and δ subunits exert regulatory control. The α and β subunits are phosphorylated in the transition from the inactive *b* form to the active *a* form of the enzyme. Protein kinase A can only exert an effect on phosphorylase via its ability to phosphorylate and activate phosphorylase kinase. Thus a bicyclic system is required for activation of phosphorylase in response to cAMP-mediated signals.

The δ subunit of phosphorylase kinase also plays a regulatory role. It corresponds to a Ca^{2+} -binding regulatory protein, called **calmodulin**. Not unique to phosphorylase kinase, calmodulin is found in cells as the free molecule and also bound to other enzyme complexes. It functions as a Ca^{2+} receptor in the cell, responding to changes in intracellular Ca^{2+} concentration and affecting the relative activities of a number of enzyme systems. Binding of Ca^{2+} to the calmodulin subunit of phosphorylase kinase changes the conformation of the complex, making the enzyme more active with respect to the phosphorylation of phosphorylase. As shown in Figure 7.57, Ca^{2+} is an activator of both phosphorylase kinase *a* and phosphorylase kinase *b*. Maximum activation of phosphorylase kinase requires both phosphorylation of specific serine residues of the enzyme and interaction of Ca^{2+} with the calmodulin subunit of the enzyme. This is one mechanism by which Ca^{2+} functions as an important "second messenger" of hormone action, as will be discussed below.

Activation of phosphorylase kinase by phosphorylation and Ca^{2+} will have a substantial effect on the activity of glycogen phosphorylase. It is equally obvious, however, that turning off the phosphoprotein phosphatase that modulates the phosphorylation states of both phosphorylase kinase and glycogen phosphorylase (Figure 7.57) could achieve the same effect. Ultimate control of glycogen phosphorylase would involve the reciprocal regulation of phosphoprotein phosphatase and phosphorylase kinase activities. Although numerous details remain to be understood, there is evidence that activities of phosphoprotein phosphatase and phosphorylase kinase are controlled in a reciprocal manner. Regulation of phosphoprotein phosphatase activity is linked to cAMP (see p. 325). The important point in Figure 7.57 is that hormones that increase cAMP levels, such as **glucagon** and **epinephrine**, promote activation of glycogen phosphorylase by signaling activation of phosphorylase kinase and inactivation of phosphoprotein phosphatase. On the other hand, **insulin**, which acts either through a second messenger or a kinase-mediated signal cascade (see p. 879), exerts the opposite effect on phosphorylase by promoting activation of phosphoprotein phosphatase activity.

The Cascade that Regulates Glycogen Phosphorylase Amplifies a Small Signal into a Very Large Effect

There is a good reason for the existence of the bicyclic control system for phosphorylation of glycogen phosphorylase. It provides a tremendous amplification mechanism of a very small initial signal. Activation of **adenylate cyclase** by one molecule of epinephrine causes formation of many molecules of cAMP. Each cAMP molecule activates a protein kinase A molecule, which in turn activates many molecules of phosphorylase kinase as well as many molecules of phosphoprotein phosphatase. In turn, phosphorylase kinase phosphorylates many molecules of glycogen phosphorylase, which in turn catalyze phosphorolysis of many glycosidic bonds of glycogen. A very elaborate amplification system is therefore provided in which the signal provided by just a few molecules of hormone is amplified into production of an enormous number of glucose 1-phosphate molecules. If each step represents, for argument's sake, an amplification factor of 100, then a total of four steps would result in an amplification

of 100 million! This system is so rapid, in large part because of this **amplification mechanism**, that all of the stored glycogen of white muscle fibers could be completely mobilized within just a few seconds.

Regulation of Glycogen Synthase

Glycogen synthase has to be active for glycogen synthesis and inactive for glycogen degradation. The combination of the reactions catalyzed by glycogen synthase, glycogen phosphorylase, glucose 1-phosphate uridylyltransferase, and nucleoside diphosphate kinase adds up to a futile cycle with the overall equation $\text{ATP} \rightarrow \text{ADP} + \text{P}_i$. Hence glycogen synthase needs to be turned off when glycogen phosphorylase is turned on, and vice versa.

Activation of **glycogen synthase** by glucose 6-phosphate, an allosteric effector, is probably of physiological significance under some circumstances (Figure 7.58). However, as with glycogen phosphorylase, this mode of control is integrated with regulation by covalent modification (Figure 7.58). Glycogen synthase exists in two forms. One is designated the D form because it is dependent on the presence of G6P for activity. The other is designated the I form because its activity is independent of the presence of G6P. The D form corresponds to the *b* or inactive form of the enzyme, the I form to the *a* or active form of the enzyme. Phosphorylation of glycogen synthase is catalyzed by several different kinases, which in turn are regulated by second messengers of

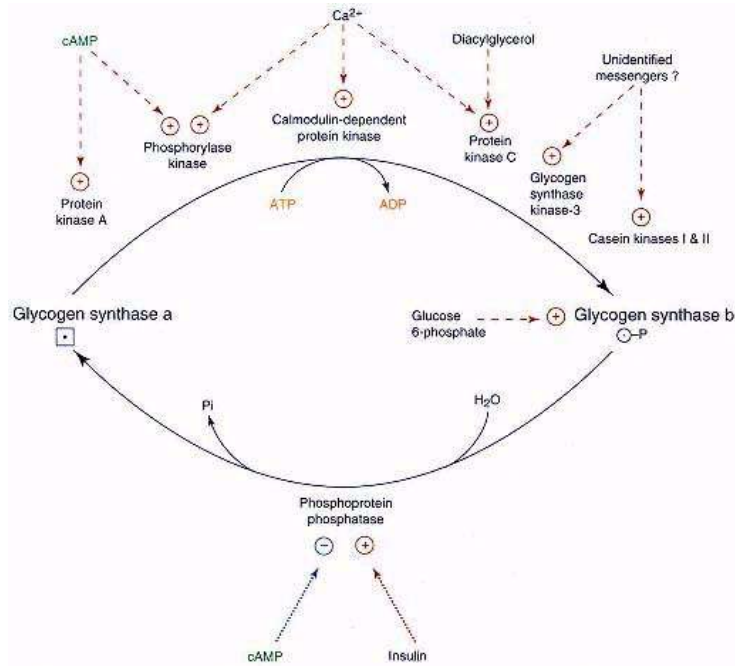

Figure 7.58

Regulation of glycogen synthase by covalent modification.

Phosphorylation converts glycogen synthase from its active *a* form to its inactive *b* form.

hormone action, including cAMP, Ca^{2+} , **diacylglycerol**, and probably yet to be identified compounds. Each of the protein kinases shown in Figure 7.58 is capable of catalyzing the phosphorylation and contributing to inactivation of glycogen synthase. Although glycogen synthase is a simple tetramer (α_4) of only one subunit type (mol wt 85,000 Da), it can be phosphorylated on at least nine different serine residues. Eleven different protein kinases have been identified that can phosphorylate glycogen synthase. This stands in striking contrast to glycogen phosphorylase, which is regulated by phosphorylation of one site by one specific kinase.

Cyclic AMP is an extremely important intracellular signal for reciprocally controlling glycogen synthase (Figure 7.58) and glycogen phosphorylase (Figure 7.57). An increase in cAMP signals activation of glycogen phosphorylase and inactivation of glycogen synthase via activation of protein kinase A and inhibition of phosphoprotein phosphatase. Ca^{2+} likewise can influence the phosphorylation state of both enzymes and reciprocally regulate their activity via its effects on phosphorylase kinase. Two cAMP-independent, Ca^{2+} -activated protein kinases have been identified that also may have physiological significance. One of these is a calmodulin-dependent protein kinase and the other a Ca^{2+} - and phospholipid-dependent protein kinase (protein kinase C). Both enzymes phosphorylate glycogen synthase, but neither can phosphorylate glycogen phosphorylase. Protein kinase C requires phospholipid, diacylglycerol, and Ca^{2+} for full activity. There is considerable interest in protein kinase C because **tumor-promoting agents** called **phorbol esters** have been found to mimic diacylglycerol as activators of this enzyme. Diacylglycerol is considered an important "second messenger" of hormone action, acting via protein kinase C to regulate numerous cellular processes (see p. 865).

Glycogen synthase is also phosphorylated by glycogen synthase kinase-3, casein kinase I, and casein kinase II. These kinases are not subject to regulation by cAMP or Ca^{2+} . It is likely, however, that special regulatory mechanisms exist to regulate these kinases. Herein may lie solutions to unsolved problems such as the mechanism of action of insulin and other hormones.

The phosphoprotein phosphatase that converts glycogen synthase *b* back to glycogen synthase *a* (Figure 7.58) is regulated in a manner analogous to that described in the discussion of glycogen phosphorylase regulation (Figure 7.57). Cyclic AMP promotes inactivation whereas insulin promotes activation of glycogen synthase through opposite effects on phosphoprotein phosphatase activity.

Regulation of Phosphoprotein Phosphatases

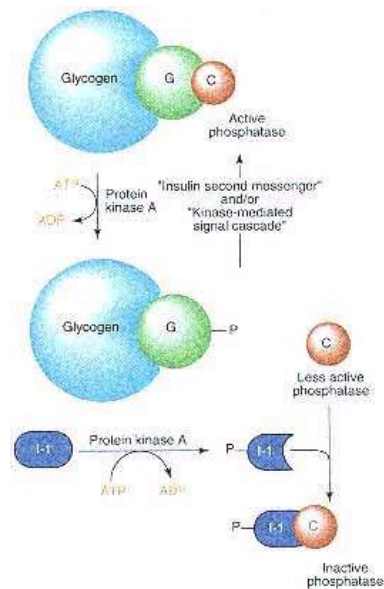

Figure 7.59

Mechanism for regulation of a phosphatase that binds to glycogen.

The glycogen-binding subunit G binds directly to glycogen; the phosphoprotein phosphatase catalytic subunit C binds to glycogen via the G subunit; and the phosphorylated inhibitor 1 (I-1) binds the free catalytic subunit.

About a dozen different **phosphoprotein phosphatases** with specificity for removal of phosphate from serine residues of proteins are currently being studied. In general, phosphoprotein phosphatases occur as catalytic subunits associated with a number of different regulatory subunits that control the activity of the catalytic subunit, determine which substrate(s) the catalytic subunit can interact with and dephosphorylate, and target the association of a catalytic subunit with a specific structure or component within a cell. One such regulatory protein important for glycogen metabolism has been given the name **G subunit**, denoting a glycogen-binding protein. G subunit binds both glycogen and a phosphatase catalytic subunit (Figure 7.59). This association makes the phosphatase ten times more active toward glycogen synthase and glycogen phosphorylase and thereby greatly promotes their dephosphorylation. However, phosphorylation of the G subunit by protein kinase A results in release of the phosphatase catalytic subunit, which is then less active. Interaction of the free catalytic subunit with yet another regulatory protein (called **inhibitor 1**) then causes further inhibition of phosphatase activity. Effective inhibition of the residual phosphatase activity of the catalytic subunit requires phosphorylation of inhibitor 1 by protein kinase A, thereby creating yet another link to hormones that increase cAMP levels. **Insulin** has effects opposite to those of cAMP;

that is, insulin promotes activation of the catalytic subunit of phosphoprotein phosphatase. This presumably involves reversal of the steps promoted by cAMP, but details of how this is accomplished remain to be established.

Effector Control of Glycogen Metabolism

Certain muscles are known to mobilize their glycogen stores rapidly in response to anaerobic conditions without marked conversion of phosphorylase *b* to phosphorylase *a* or glycogen synthase *a* to glycogen synthase *b*. Presumably this is accomplished by effector control in which ATP levels decrease, causing less inhibition of phosphorylase; glucose 6-phosphate levels decrease, causing less activation of glycogen synthase; and AMP levels increase, causing activation of phosphorylase. This enables muscle to keep working, for at least a short period of time, by using ATP produced by glycolysis of glucose 6-phosphate obtained from glycogen.

Proof that effector control can operate has also been obtained in studies of a special strain of mice that are deficient in muscle phosphorylase kinase. Phosphorylase *b* in muscle of such mice cannot be converted into phosphorylase *a*. Nevertheless, heavy exercise of these mice results in depletion of muscle glycogen, presumably because of stimulation of phosphorylase *b* by effectors.

Negative Feedback Control of Glycogen Synthesis by Glycogen

Glycogen exerts feedback control over its own formation. The portion of glycogen synthase in the active *a* form decreases as glycogen accumulates in a particular tissue. The mechanism is not well understood, but glycogen may make the *a* form a better substrate for one of the protein kinases, or, alternatively, glycogen may inhibit dephosphorylation of glycogen synthase *b* by phosphoprotein phosphatase. Either mechanism would account for the shift in the steady state in favor of glycogen synthase *b* that occurs in response to glycogen accumulation.

Phosphorylase *a* Functions As a "Glucose Receptor" in the Liver

Consumption of a carbohydrate-containing meal results in an increase in blood and liver glucose, which signals an increase in glycogen synthesis in the latter tissue. The mechanism involves glucose stimulation of insulin release from the pancreas and its effects on hepatic glycogen phosphorylase and glycogen synthase. However, hormone-independent mechanisms also appear to be important in liver (Figure 7.60). Direct inhibition of phosphorylase *a* by glucose is probably of importance. Binding of glucose to phosphorylase makes the *a* form of phosphorylase a better substrate for dephosphorylation by phosphoprotein phosphatase. Therefore phosphorylase *a* functions as a glucose receptor in liver. Binding of glucose to phosphorylase *a* promotes inactivation of phosphorylase *a*, with the overall result being inhibition of glycogen degradation by glucose. This "negative feedback" control of glycogenolysis by glucose would not necessarily promote glycogen synthesis. However, there also is evidence that phosphorylase *a* is an inhibitor of the dephosphorylation of glycogen synthase *b* by phosphoprotein phosphatase. This inhibition is lost once phosphorylase *a* has been converted to phosphorylase *b* (Figure 7.60). In other words, phosphoprotein phosphatase can turn its attention to glycogen synthase *b* only following dephosphorylation of phosphorylase *a*. Thus, as a result of interaction of glucose with phosphorylase *a*, phosphorylase becomes inactivated, glycogen synthase becomes activated, and glycogen is synthesized rather than degraded in liver. Phosphorylase *a* can serve this function of "glucose receptor" in liver because the concentration of glucose in liver always reflects the blood concentration of glucose. This is not true for extrahepatic tissues. Liver cells have a very high-capacity transport system for glucose and a high K_m enzyme for glucose phosphorylation (glucokinase). Cells of extrahepatic

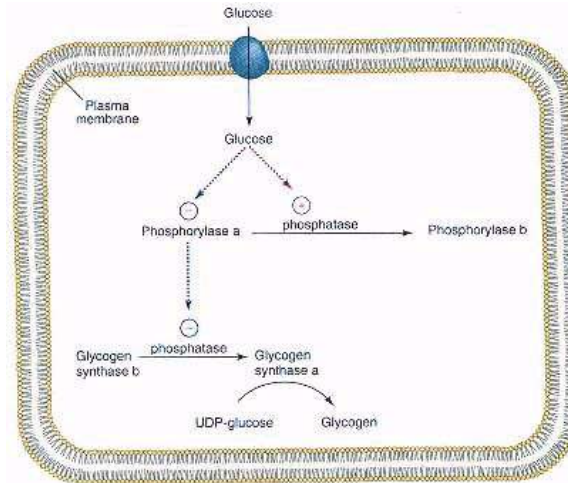

Figure 7.60
Overview of the mechanism responsible for glucose stimulation of glycogen synthesis in the liver.

tissues as a general rule have glucose transport and phosphorylation systems that maintain intracellular glucose at concentrations too low for phosphorylase *a* to function as a "glucose receptor."

Glucagon Stimulates Glycogen Degradation in the Liver

Glucagon is released from α cells of pancreas in response to low blood glucose levels. One of glucagon's primary jobs during periods of low food intake (fasting or starvation) is to mobilize **liver glycogen**, that is, stimulate glycogenolysis, in order to ensure that adequate blood glucose is available to meet the needs of glucose-dependent tissues. Glucagon circulates in blood until it interacts with glucagon receptors such as those located on the plasma membrane of liver cells (see Figure 7.61). Binding of glucagon to these receptors activates adenylate cyclase and triggers the cascades that result in activation of glycogen phosphorylase and inactivation of glycogen synthase by the mechanisms given in Figures 7.57 and 7.58, respectively. Glucagon also inhibits glycolysis at the level of 6-phosphofructo-1-kinase and pyruvate kinase by the mechanisms given in Figures 7.25 and 7.30, respectively. The net result of these effects of glucagon, all mediated by the second messenger cAMP and covalent modification, is a very rapid increase in blood glucose levels. Hyperglycemia might be expected but does not occur because less glucagon is released from the pancreas as blood glucose levels increase.

Epinephrine Stimulates Glycogen Degradation in the Liver

Epinephrine is released into blood from chromaffin cells of the adrenal medulla in response to stress. This hormone is our "fright, flight, or fight" hormone, preparing the body for either combat or escape.

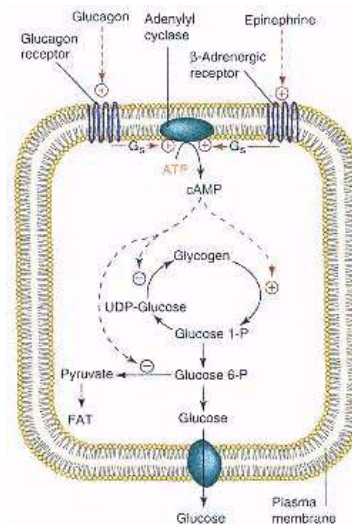

Figure 7.61
Cyclic AMP mediates the stimulation of glycogenolysis in liver by glucagon and β agonists (epinephrine).
See legends for Figures 7.19 and 7.25.

Epinephrine interacts directly with receptors in the plasma membrane of liver cells to activate **adenylate cyclase** (Figure 7.61). The resulting increase in cAMP has the same effect as that caused by glucagon, that is, activation of glycogenolysis and inhibition of glycogenesis and glycolysis to maximize the release of glucose from liver. The plasma membrane receptor for epinephrine,

which is in communication with adenylate cyclase, is the β -adrenergic receptor. The plasma membrane of liver cells also has another binding protein for epinephrine, called the α -adrenergic receptor. Interaction of epinephrine with α -adrenergic receptors leads to formation of **inositol 1,4,5-trisphosphate (IP₃)** and **diacylglycerol** (Figure 7.62). These compounds are second messengers, produced in the plasma membrane by the action of a phospholipase C on phosphatidylinositol 4,5-bisphosphate (Figure 7.63). Inositol 1,4,5-trisphosphate stimulates the release of Ca²⁺ from the endoplasmic reticulum (Figure 7.62). As previously discussed (Figure 7.57), the increase in Ca²⁺ activates phosphorylase kinase, which in turn activates glycogen phosphorylase. Likewise (Figure 7.58), Ca²⁺-mediated activation of phosphorylase kinase, calmodulin-dependent protein kinase, and protein kinase C, as well as diacylglycerol-mediated activation of protein kinase C, may all be important for inactivation of glycogen synthase.

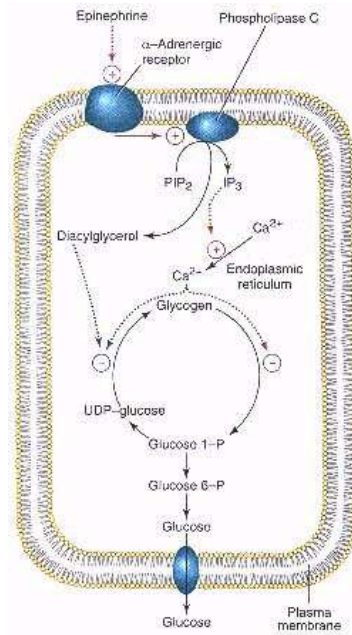

Figure 7.62
Inositol trisphosphate (IP₃) and Ca²⁺ mediate the stimulation of glycogenolysis in liver by α agonists.

The α -adrenergic receptor and glucose transporter are intrinsic components of the plasma membrane. Although not indicated, phosphatidylinositol 4,5-bisphosphate (PIP₂) is also a component of the plasma membrane.

The consequences of epinephrine action is an increased release of glucose into the blood from the glycogen stored in liver. This makes more blood glucose available to tissues that are called upon to meet the challenge of the stressful situation that triggered the release of epinephrine from adrenal medulla.

Epinephrine Stimulates Glycogen Degradation in Heart and Skeletal Muscle

Epinephrine also stimulates glycogen degradation in heart and skeletal muscle. Cyclic AMP, produced in response to epinephrine stimulation of adenylate cyclase via β -adrenergic receptors (Figure 7.64), signals concurrent activation of glycogen phosphorylase and inactivation of glycogen synthase by mechanisms given previously in Figures 7.57 and 7.58, respectively. This does not lead, however, to glucose release into blood from these tissues. In contrast to liver, heart and skeletal muscle lack glucose 6-phosphatase, and in these tissues cAMP does not inhibit but rather stimulates glycolysis (see Figure 7.28). Thus the role of epinephrine on glycogen metabolism in heart and skeletal muscle is to make more glucose 6-phosphate available for glycolysis. ATP generated by glycolysis can then be used to meet the metabolic demand imposed on these muscles by the stress that triggered epinephrine release.

Neural Control of Glycogen Degradation in Skeletal Muscle

Nervous excitation of muscle activity is mediated via changes in intracellular Ca²⁺ concentrations (Figure 7.65). A **nerve impulse** causes **membrane depo-**

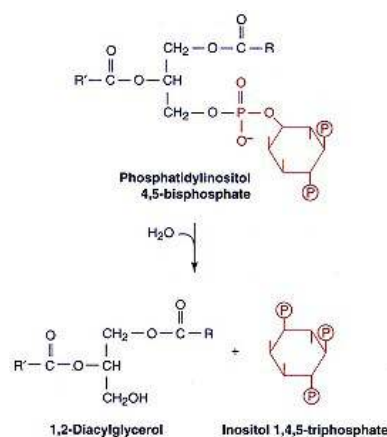

Figure 7.63
Phospholipase C cleaves phosphatidylinositol 4,5-bisphosphate to produce 1,2-diacylglycerol and inositol 1,4,5-trisphosphate.

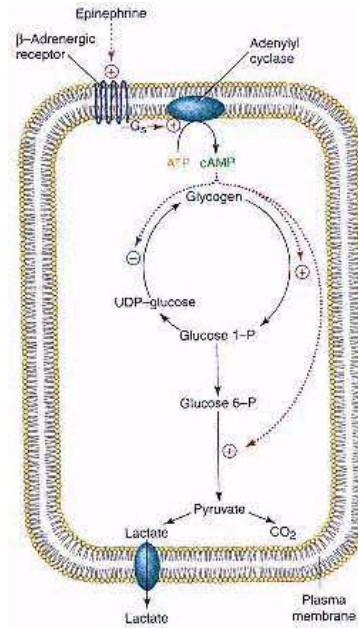

Figure 7.64
Cyclic AMP mediates the stimulation of glycogenolysis in muscle by β agonists (epinephrine).

The β -adrenergic receptor is an intrinsic component of the plasma membrane that acts to stimulate adenylate cyclase via a stimulatory G-protein (G_s).

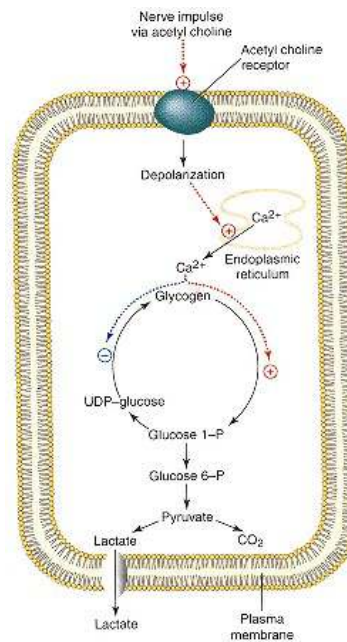

Figure 7.65

Ca^{2+} mediates the stimulation of glycogenolysis in muscle by nervous excitation.

larization, which in turn causes Ca^{2+} release from the **sarcoplasmic reticulum** into the sarcoplasm of muscle cells. This release of Ca^{2+} triggers muscle contraction, whereas reaccumulation of Ca^{2+} by the sarcoplasmic reticulum causes relaxation. The same change in Ca^{2+} concentration effective in causing muscle contraction (from 10^{-8} to 10^{-6} M) also greatly affects the activity of phosphorylase kinase. As Ca^{2+} concentrations increase there is more muscle activity and a greater need for ATP. Activation of phosphorylase kinase by Ca^{2+} leads to the subsequent activation of glycogen phosphorylase and perhaps the inactivation of glycogen synthase. The result is that more glycogen is converted to glucose 6-phosphate so that more ATP can be produced to meet the greater energy demand of muscle contraction.

Insulin Stimulates Glycogen Synthesis in Muscle and Liver

An increase in blood glucose signals release of insulin from β cells of the pancreas. Insulin circulates in blood, serving as a first messenger to inform several tissues that excess glucose is present. Insulin receptors, located on the plasma membranes of insulin-responsive cells, respond to insulin binding by either producing a second messenger of insulin action or inducing a protein kinase cascade that promotes glucose use within these tissues (Figures 7.66 and 7.67). The pancreas responds to a decrease in blood glucose with less release of insulin but greater release of glucagon. These hormones have opposite effects on glucose utilization by liver, thereby establishing the pancreas as a fine-tuning device that prevents dangerous fluctuations in blood glucose levels.

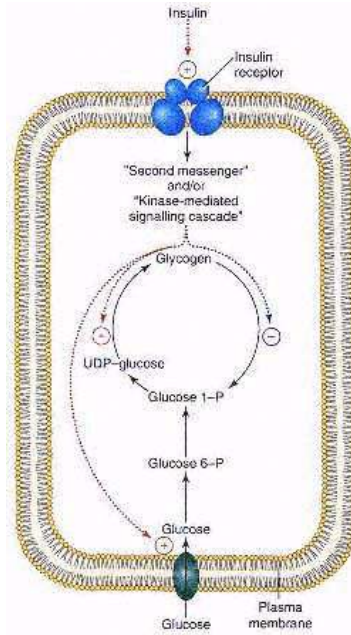

Figure 7.66
Insulin acts via a plasma membrane receptor to promote glycogen synthesis in muscle.

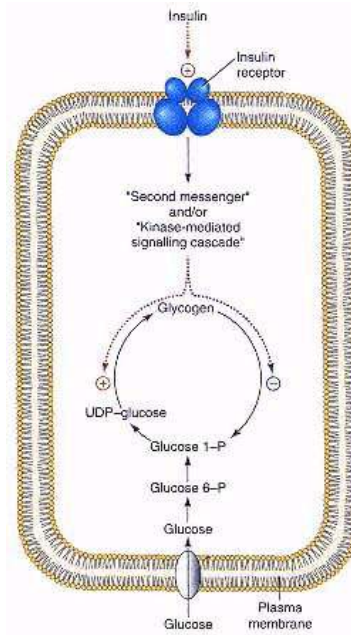

Figure 7.67
Insulin acts via a plasma membrane receptor to promote glycogen synthesis in liver.

Insulin increases glucose utilization in part by promoting glycogenesis and inhibiting glycogenolysis in muscle (Figure 7.66) and liver (Figure 7.67). Insulin stimulation of glucose transport at the plasma membrane is essential for these effects in muscle but not liver. Hepatocytes have a high-capacity, **insulin-insensitive glucose transport system** (GLUT-2), whereas muscle cells and adipocytes are equipped with a **glucose transport system** (GLUT-4) that requires insulin for maximum rates of glucose uptake. Insulin stimulates muscle and adipose tissue glucose transport by signaling an increase in the number of functional GLUT-4 proteins associated with the plasma membrane. This is accomplished by promoting translocation of GLUT-4 from an intracellular pool to the plasma membrane (see Chapter 20). Insulin further promotes glycogen accumulation in both tissues by activating glycogen synthase and inhibiting glycogen phosphorylase as discussed previously (Figures 7.57, 7.58, and 7.59).

Bibliography

- Arion, W. J., Lange, A. J., Walls, H. E., and Ballas, L. M. Evidence for the participation of independent translocases for phosphate and glucose 6-phosphate in the microsomal glucose 6-phosphatase system. *J. Biol. Chem.* 255:10396, 1980.
- Berridge, M. J. Review article: inositol trisphosphate and diacylglycerol as second messengers. *Biochem. J.* 220:345, 1984.
- Brooke, M. H., and Kaiser, K. K. The use and abuse of muscle histochemistry. *Ann. N.Y. Acad. Sci.* 228:121, 1974.
- Cheatham, B., and Kahn, C. R. Insulin action and the insulin signaling network. *Endocr. Rev.* 16:117, 1995.
- Cohen, P. Dissection of the protein phosphorylation cascades involved in insulin and growth factor action. *Biochem. Soc. Trans.* 21:555, 1993.
- DeFronzo, R. A., and Ferrannini, E. Regulation of hepatic glucose metabolism in humans. *Diabetes Metab. Reviews* 3:415, 1987.
- DePaoli-Roach, A. A., Park, I.-K., Cerovsky, V., Csontos, C., Durbin, S. D., Kuntz, M. J., Sitikov, A., Tang, P. M., Verin, A., and Zolnierowicz, S.

- Serine/threonine protein phosphatases in the control of cell function. *Adv. Enzyme Regul.* 34:199, 1994.
- Exton, J. H. Mechanisms of hormonal regulation of hepatic glucose metabolism. *Diabetes Metab. Rev.* 3:163, 1987.
- Garcia, C. K., Goldstein, J. L., Pathak, R. K., Anderson, R. G. W., and Brown, M. S. Molecular characterization of a membrane transporter for lactate, pyruvate, and other monocarboxylates: implications for the Cori cycle. *Cell* 76:865, 1994.
- Geelen, M. J. H., Harris, R. A., Beynen, A. C., and McCune, S. A. Short-term hormonal control of hepatic lipogenesis. *Diabetes* 29:1006, 1980.
- Gitzelmann, R., Steinmann, B., and Van den Berghe, G. Disorders of fructose metabolism. In: C. R. Scriver, A. L. Beaudet, W. S. Sly, and D. Valle (Eds.), *The Metabolic and Molecular Bases of Inherited Disease*, 7th ed. New York: McGraw-Hill, 1995, pp. 905–934.
- Gould, G. W., and Holman, G. D. The glucose transporter family: structure, function and tissue-specific expression. *Biochem. J.* 295:329, 1993.
- Greene, H. L., Slonin, A. E., and Burr, I. M. Type I glycogen storage disease: a metabolic basis for advances in treatment. In: L. A. Barnes (Ed.), *Advances in Pediatrics*, Vol. 26. Chicago: Year Book Publishers, 1979, p. 63.
- Gurney, A. L., Park, E. A., Liu, J., Giralt, M., McGrane, M. M., Patel, Y. M., Crawford, D. R., Nizielski, S. E., Savon, S., and Hanson, R. W. Metabolic regulation of gene transcription. *J. Nutr.* 124:1533S, 1994.
- Hallfrisch, J. Metabolic effects of dietary fructose. *FASEB J.* 4:2652, 1990.
- Hanson, R. W., and Mehlman, M. A. (Eds.). *Gluconeogenesis, Its Regulation in Mammalian Species*. New York: Wiley, 1976.
- Hunter, T. Protein kinases and phosphatases: the yin and yang of protein phosphorylation and signaling. *Cell* 80:225, 1995.
- Ingebritsen, T. S., and Cohen, P. Protein phosphatases: properties and role in cellular regulation. *Science* 221:331, 1983.
- Isselbacher, K. J., Adams, R. D., Braundwald, E., Petersdorf, R. B., and Wilson, J. D. (Eds.). *Harrison's principles of internal medicine*, 9th ed. New York: McGraw-Hill, 1980.
- Lalli, E., and Sassone-Corsi, P. Signal transduction and gene regulation: the nuclear response to cAMP. *J. Biol. Chem.* 269:17359, 1994.
- Lieber, C. S. The metabolism of alcohol. *Sci. Am.* 234:25, 1976.
- Lomako, J., Lomako, W. M., and Whelan, W. J. A self-glucosylating protein is the primer for rabbit muscle glycogen biosynthesis. *FASEB J.* 2:3097, 1988.
- Metzler, D. E. *Biochemistry, The Chemical Reactions of Living Cells*. New York: Academic Press, 1977.
- Newsholme, E. A., and Leech, A. R. *Biochemistry for the Medical Sciences*. New York: Wiley, 1983.
- Newsholme, E. A., and Start, C. *Regulation in Metabolism*. New York: Wiley, 1973.
- Pilkis, S. J., Claus, T. H., Kurland, I. J., and Lange, A. J. 6-Phosphofructo-2-kinase/fructose-2,6-bisphosphatase: a metabolic signaling enzyme. *Annu. Rev. Biochem.* 64:799, 1995.
- Pilkis, S. J., and El-Maghrabi, M. R. Hormonal regulation of hepatic gluconeogenesis and glycolysis. *Annu. Rev. Biochem.* 57:755, 1988.
- Roach, P. J. Hormonal control of glycogen metabolism. In: H. Rupp (Ed.), *Regulation of Heart Function: Basic Concepts and Clinical Applications*. New York: Thieme-Stratton, 1985.
- Roach, P. J. Principles of the regulation of enzyme activity. In: L. Goldstein and D. M. Prescott (Eds.), *Cell Biology, A Comprehensive Treatise*, Vol. IV. New York: Academic Press, 1980.
- Scriver, C. R., Beaudet, A. L., Sly, W. S., and Valle, D. (Eds.). *The Metabolic and Molecular Bases of Inherited Disease*, 7th ed. New York: McGraw-Hill, 1995.
- Stanley, C. A., Anday, E. K., Baker, L., and Delivoria-Papadopolous, M. Metabolic fuel and hormone responses to fasting in newborn infants. *Pediatrics* 64:613, 1979.
- Taylor, S. I. Diabetes mellitus. In: C. R. Scriver, A. L. Beaudet, W. S. Sly, and D. Valle (Eds.), *The Metabolic and Molecular Bases of Inherited Disease*, 7th ed. New York: McGraw-Hill, 1995, pp. 843–896.
- van de Werve, G., and Jeanrenaud, B. Liver glycogen metabolism: an overview. *Diabetes Metab. Rev.* 3:47, 1987.
- van Schaftingen, E., Vandercammen, A., Detheux, M., and Davies, D. R. The regulatory protein of liver glucokinase. *Adv. Enzyme Regul.* 32:133, 1992.
- Vaulont, S., and Kahn, A. Transcriptional control of metabolic regulation genes by carbohydrates. *FASEB J.* 8:28, 1994.
- Viskupic, E., Cao, Y., Zhang, W., Cheng, C., DePaoli-Roach, A. A., and Roach, P. J. Rabbit skeletal muscle glycogenin. *J. Biol. Chem.* 267:25759, 1992.

Questions

J. Baggott and C. N. Angstadt

- In glycolysis ATP synthesis is catalyzed by:
 - hexokinase.
 - 6-phosphofructo-1-kinase.
 - glyceraldehyde-3-phosphate dehydrogenase.
 - phosphoglycerate kinase.
 - none of the above.
- The irreversible reactions of glycolysis include that catalyzed by:
 - phosphoglucose isomerase.
 - 6-phosphofructo-1-kinase.
 - fructose-bisphosphate aldolase.
 - glyceraldehyde-3-phosphate dehydrogenase.
 - phosphoglycerate kinase.
- NAD⁺ can be regenerated in the cytoplasm if NADH reacts with any of the following EXCEPT:
 - pyruvate.
 - dihydroxyacetone phosphate.
 - oxaloacetate.
 - the flavin bound to NADH dehydrogenase.
- Glucokinase:
 - has a K_m considerably greater than the normal blood glucose concentration.
 - is found in muscle.
 - is inhibited by glucose 6-phosphate.
 - is also known as the GLUT-2 protein.
 - has glucose 6-phosphatase activity as well as kinase activity.
- The primary short-term regulation of glucokinase activity in the liver is effected by:
 - substrate concentration.
 - fructose 1-phosphate concentration.
 - induction of glucokinase synthesis by high intracellular glucose concentrations.
 - insulin-induced increase in transcription of the glucokinase gene.
 - allosteric activation by ADP.

6. 6-Phosphofructo-1-kinase activity can be decreased by all of the following EXCEPT:
- ATP at high concentrations.
 - citrate.
 - AMP.
 - low pH.
 - decreased concentration of fructose 2,6-bisphosphate.
7. Which of the following supports gluconeogenesis?
- α -ketoglutarate + aspartate = glutamate + oxaloacetate
 - pyruvate + ATP + HCO₃ \rightleftharpoons oxaloacetate + ADP + P_i + H⁺
 - acetyl CoA + oxaloacetate + H₂O \rightleftharpoons citrate + CoA
 - leucine degradation
 - lysine degradation
8. In the Cori cycle:
- only tissues with aerobic metabolism (i.e., mitochondria and O₂) are involved.
 - a three-carbon compound arising from glycolysis is converted to glucose at the expense of energy from fatty acid oxidation.
 - glucose is converted to pyruvate in anaerobic tissues, and this pyruvate returns to the liver, where it is converted to glucose.
 - the same amount of ATP is used in the liver to synthesize glucose as is released during glycolysis, leading to no net effect on whole-body energy balance.
 - nitrogen from alanine must be converted to urea, increasing the amount of energy required to drive the process.
9. The uncontrolled production of NADH from NAD⁺ during ethanol metabolism blocks gluconeogenesis from all of the following EXCEPT:
- galactose.
 - glycerol.
 - α -ketoglutarate.
 - oxaloacetate.
 - pyruvate.
10. Gluconeogenic enzymes include all of the following EXCEPT:
- fructose 1,6-bisphosphatase.
 - glucose 6-phosphatase.
 - phosphoenolpyruvate carboxykinase.
 - phosphoglucomutase.
 - pyruvate carboxylase.
11. When blood glucagon rises, which of the following hepatic enzyme activities FALLS?
- adenylate cyclase
 - protein kinase
 - 6-phosphofructo-2-kinase
 - fructose 1,6-bisphosphatase
 - hexokinase
12. Phospho–dephospho regulation of 6-phosphofructo-1-kinase, 6-phosphofructo-2-kinase, and pyruvate kinase is an important regulatory mechanism in:
- brain.
 - erythrocytes.
 - intestine.
 - liver.
 - skeletal muscle.

Refer to the following for Questions 13–15.

- glycogen phosphorylase
 - phosphoglucomutase
 - phosphoglucokinase
 - glucose 6-phosphatase
 - debranching enzyme
13. A bifunctional enzyme.
14. Lacking in muscle, but present in normal liver.
15. Catalyzes phosphorolysis of glycogen.
16. Phosphorylation activates all of the following EXCEPT:
- glycogen phosphorylase.
 - inhibitor 1.
 - phosphorylase kinase.
 - protein kinase.
17. cAMP activates:
- glycogen phosphorylase.
 - hexokinase.
 - 6-phosphofructo-1-kinase.
 - protein kinase.
 - protein kinase C.

Answers

- D Phosphoglycerate kinase synthesizes ATP in the forward direction (p. 276). A and B use ATP. C synthesizes 1,3-bisphosphoglycerate.
- B E: The phosphoglycerate kinase reaction is reversible because the product contains a high energy carboxylic acid–phosphoric acid anhydride link. Many other kinases, including 6-phosphofructo-1-kinase, form phosphate esters, which have low-energy bonds.
- D The flavin is mitochondrial (p. 279). A may be converted to lactate. B and C are the cytoplasmic acceptors for shuttle systems.
- A Blood glucose is ~5 mM. K_m of glucokinase is ~10 mM. B: Glucokinase is hepatic, and, unlike the muscle hexokinase, it is not inhibited by glucose 6-phosphate (p. 285).
- A B, C, and D affect glucokinase activity, but they are not the primary short-term regulators (pp. 285–286). E: ADP is not a known effector of glucokinase.
- C AMP is an allosteric regulator that relieves inhibition by ATP (p. 287). B and D are probably important physiological regulators in muscle, and E is critical in liver.

7. B This reaction is on the direct route of conversion of pyruvate to glucose. A : α -Ketoglutarate and oxaloacetate both give rise to glucose; interconversion of one to the other accomplishes nothing (p. 304). C: Citrate ultimately gives rise to oxaloacetate, losing two carbon atoms in the process; again nothing is gained (p. 306). D and E involve the two amino acids that are strictly ketogenic.
8. B The liver derives the energy required for gluconeogenesis from aerobic oxidation of fatty acids. A: The liver is an essential organ in the Cori cycle; it is aerobic. C: In anaerobic tissues the end product of glycolysis is lactate; in aerobic tissues it is pyruvate, but there the pyruvate would likely be oxidized aerobically. D: Gluconeogenesis requires six ATP molecules per glucose synthesized; glycolysis yields two ATP molecules per glucose metabolized. E: Alanine is not part of the Cori cycle. See Figure 7.32, p. 300.
9. A Gluconeogenesis from galactose is not affected by the redox state of the cell (p. 309, Figure 7.44). B is converted to α -glycerophosphate, which cannot be oxidized to dihydroxyacetone phosphate when NADH/NAD⁺ is high. For the same reason, C and D will be trapped as malate, since the interconversion of malate and oxaloacetate strongly favors malate even under normal conditions. E will be converted to lactate. Clearly, very high NADH blocks gluconeogenesis at many points (p. 312). If an inebriated person has depleted glycogen stores and has not been ingesting carbohydrates, sources of blood glucose are seriously compromised, and hypoglycemia could become life-threatening (Clin. Corr 7.10). The oft-heard statement that alcohol is metabolized as a carbohydrate is false.
10. D Phosphoglucomutase is on the pathway of glycogen metabolism (p. 314). A–C and E are the so-called gluconeogenic enzymes; they get around the irreversible steps of glycolysis (p. 303).
11. C As blood glucagon rises, A is activated, producing cAMP; cAMP activates B, and B inactivates C. Low levels of fructose 2,6-bisphosphate increase the activity of D (p. 310). E is not an important hepatic enzyme; its role is filled in liver by glucokinase.
12. D Regulation of these enzymes by hormonally controlled phosphorylation and dephosphorylation is of central importance in liver. 6-Phosphofructo-2-kinase is present in other tissues but does not appear to change its activity in response to hormones except in liver. Other enzymes in extrahepatic tissues, such as those of glycogen metabolism in muscle, are under phospho–dephospho regulation.
13. E Debranching enzyme has 4- α -D-glucanotransferase activity, which moves a strand of three glucosyl units from a branch to an end of a glucosyl chain. It also has amylo- α -[1,6]-glucosidase activity, which hydrolyzes the last glucosyl residue from the branch, yielding free glucose (p. 318).
14. D This is why muscle glycogen cannot contribute directly to blood glucose (p. 316).
15. A Note that it is phosphorolysis, not hydrolysis; the product is glucose 1-phosphate, not glucose (p. 314).
16. D A, B, and C are activated by phosphorylation (p. 322, Figure 7.57). Protein kinase (sometimes referred to as protein kinase A) is not a phospho–dephospho enzyme (p. 323).
17. D A (p. 322) and C (p. 287) are allosterically activated by AMP. B is controlled by glucose 6-phosphate. E is activated by Ca²⁺, phospholipid, and diacylglycerol (p. 325).

**Chapter 8—
Carbohydrate Metabolism II:
Special Pathways**

Nancy B. Schwartz

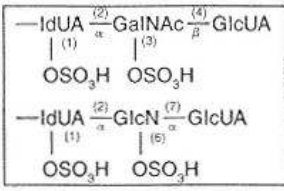

8.1 Overview	336
8.2 Pentose Phosphate Pathway	336
The Pentose Phosphate Pathway Has Two Phases	336
Glucose 6-Phosphate Is Oxidized and Decarboxylated to a Pentose Phosphate	336
Interconversions of Pentose Phosphates Lead to Glycolytic Intermediates	338
Glucose 6-Phosphate Can Be Completely Oxidized to CO ₂	340
Pentose Phosphate Pathway Produces NADPH	341
8.3 Sugar Interconversions and Nucleotide Sugar Formation	341
Isomerization and Phosphorylation Are Common Reactions for Interconverting Carbohydrates	341
Nucleotide-Linked Sugars Are Intermediates in Many Sugar Transformations	342
Epimerization Interconverts Glucose and Galactose	343
Glucuronic Acid Is Formed by Oxidation of UDP-Glucose	344
Decarboxylation, Oxidoreduction, and Transamination of Sugars Produce Necessary Products	344
Sialic Acids Are Derived from N-Acetylglucosamine	345
8.4 Biosynthesis of Complex Carbohydrates	346
8.5 Glycoproteins	348
Glycoproteins Contain Variable Amounts of Carbohydrate	348
Carbohydrates Are Covalently Linked to Glycoproteins by <i>N</i> - or <i>O</i> -Glycosyl Bonds	349
Synthesis of <i>N</i> -Linked Glycoproteins Involves Dolichol Phosphate	350
8.6 Proteoglycans	351
Hyaluronate Is a Copolymer of <i>N</i> -Acetylglucosamine and Glucuronic Acid	353
Chondroitin Sulfates Are the Most Abundant Glycosaminoglycans	354
Dermatan Sulfate Contains L-Iduronic Acid	354
Heparin and Heparan Sulfate Differ from Other Glycosaminoglycans	354
Keratan Sulfate Exists in Two Forms	355
Biosynthesis of Chondroitin Sulfate Is Typical of Glycosaminoglycan Formation	356
Bibliography	357
Questions and Answers	357
Clinical Correlations	
8.1 Glucose 6-Phosphate Dehydrogenase: Genetic Deficiency or Presence of Genetic Variants in Erythrocytes	338
8.2 Essential Fructosuria and Fructose Intolerance: Deficiency of Fructokinase and Fructose 1-Phosphate Aldolase	342
8.3 Galactosemia: Inability to Transform Galactose into Glucose	343
8.4 Pentosuria: Deficiency of Xylitol Dehydrogenase	345
8.5 Glucuronic Acid: Physiological Significance of Glucuronide Formation	346
8.6 Blood Group Substances	348
8.7 Aspartylglycosylaminuria: Absence of 4-L-Aspartylglycosamine Amidohydrolase	349
8.8 Heparin Is an Anticoagulant	350
8.9 Mucopolysaccharidoses	352

8.1—

Overview

In addition to catabolism of glucose for the specific purpose of energy production in the form of ATP, several other pathways involving sugar metabolism exist in cells. One, the **pentose phosphate pathway**, known also as the **hexose monophosphate shunt** or the **6-phosphogluconate pathway**, is particularly important in animal cells. It functions side by side with glycolysis and the tricarboxylic acid cycle for production of reducing power in the form of NADPH and pentose intermediates. It has previously been mentioned that NADPH serves as a hydrogen and electron donor in reductive biosynthetic reactions, while in most biochemical reactions NADH is oxidized by the respiratory chain to produce ATP (Chapter 6). The enzymes involved in this pathway are located in the cytosol, indicating that the oxidation that occurs is not dependent on mitochondria or the tricarboxylic acid cycle. Another important function is to convert hexoses into pentoses, particularly ribose 5-phosphate. This C₅ sugar or its derivatives are components of ATP, CoA, NAD, FAD, RNA, and DNA. The pentose phosphate pathway also catalyzes the interconversion of C₃, C₄, C₆, and C₇ sugars, some of which can enter glycolysis.

There are also specific pathways for synthesis and degradation of monosaccharides, oligosaccharides, and polysaccharides (other than glycogen) and a profusion of chemical **interconversions**, whereby one sugar can be changed into another. All monosaccharides, and most oligo- and polysaccharides synthesized from the monosaccharides, can originate from glucose. The interconversion reactions by which one sugar is changed into another can occur directly or at the level of nucleotide-linked sugars. In addition to their important role in sugar transformation, nucleotide sugars are the obligatory activated form for polysaccharide synthesis. Monosaccharides are also often found as components of more complex macromolecules like oligo- and polysaccharides, glycoproteins, glycolipids, and proteoglycans. In higher animals these complex carbohydrate molecules are predominantly structural elements filling the extracellular space in tissues and associated with cell membranes. However, more dynamic functions for these complex macromolecules, such as recognition markers and determinants of biological specificity, have been discovered. The discussion of complex carbohydrates in this chapter is limited to the chemistry and biology of those complex carbohydrates found in animal tissues and fluids. The Appendix discusses the nomenclature and chemistry of the carbohydrates.

8.2—

Pentose Phosphate Pathway*The Pentose Phosphate Pathway Has Two Phases*

The oxidative pentose phosphate pathway provides a means for cutting the carbon chain of a sugar molecule one carbon at a time. However, in contrast to glycolysis and the tricarboxylic acid cycle, the operation of this pathway does not occur as a consecutive set of reactions leading directly from glucose 6-phosphate (G6P) to six molecules of CO₂. The pathway can be visualized as occurring in two stages. In the first stage, hexose is decarboxylated to pentose, followed by two oxidation reactions that lead to formation of NADPH. The pathway then continues and, by a series of transformations, six molecules of pentose undergo rearrangements to yield five molecules of hexose. To understand this pathway, it is necessary to examine each reaction individually.

Glucose 6-Phosphate Is Oxidized and Decarboxylated to a Pentose Phosphate

The first reaction of the pentose phosphate pathway (Figure 8.1) is **dehydrogenation** of G6P at C-1 to form **6-phosphoglucono- δ -lactone** and **NADPH**.

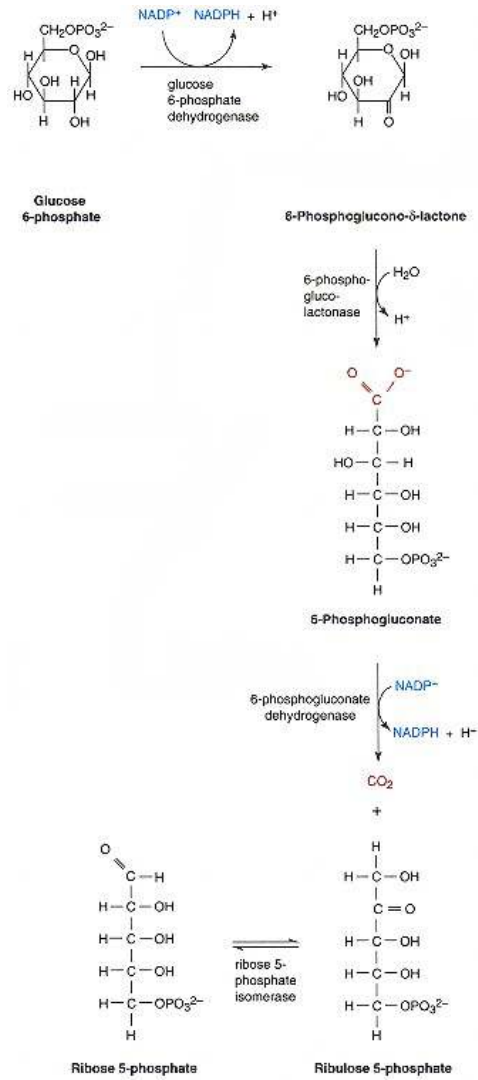

Figure 8.1
Formation of pentose phosphate.

The enzyme catalyzing this reaction is **G6P dehydrogenase**, the first enzyme found to be specific for NADP^+ and the major regulatory site for the pathway. Special interest in this enzyme stems from the severe anemia that may result from the absence of G6P dehydrogenase in erythrocytes or from the presence of one of several genetic variants of the enzyme (see Clin. Corr. 8.1). The intermediate product of this reaction, a lactone, is a substrate for gluconolacto-

CLINICAL CORRELATION 8.1**Glucose 6-Phosphate Dehydrogenase: Genetic Deficiency or Presence of Genetic Variants in Erythrocytes**

When certain seemingly harmless drugs, such as antimalarials, antipyretics, or sulfa antibiotics, are administered to susceptible patients, an acute hemolytic anemia may result in 48–96 h. Susceptibility to drug-induced hemolytic disease may be due to a deficiency of G6P dehydrogenase activity in erythrocytes and was one of the early indications that X-linked genetic deficiencies of this enzyme exist. This enzyme, which catalyzes the oxidation of G6P to 6-phosphogluconate and the reduction of NADP⁺, is particularly important, since the pentose phosphate pathway is the major pathway of NADPH production in the red cell. For example, red cells with the relatively mild A-type of glucose-6-phosphate dehydrogenase deficiency can oxidize glucose at a normal rate when the demand for NADPH is normal. However, if the rate of NADPH oxidation is increased, the enzyme-deficient cells cannot increase the rate of glucose oxidation and carbon dioxide production adequately. In addition, cells lacking glucose-6-phosphate dehydrogenase do not reduce enough NADP to maintain glutathione in its reduced state. Reduced glutathione is necessary for the integrity of the erythrocyte membrane, thus rendering enzyme-deficient red cells more susceptible to hemolysis by a wide range of compounds. Therefore the basic abnormality in G6P deficiency is the formation of mature red blood cells that have diminished glucose-6-phosphate dehydrogenase activity. Young red blood cells may have significantly higher enzyme activity than older cells, because of an unstable enzyme variant; following an episode of hemolysis, young red cells predominate and it may not be possible to diagnose this genetic deficiency until the red cell population ages. This enzymatic deficiency, which is usually undetected until administration of certain drugs, illustrates the interplay of heredity and environment on the production of disease. Enzyme defects are only one of several abnormalities that can affect enzyme activity, and others have been detected independent of drug administration. There are more than 300 known genetic variants of this enzyme that contains 516 amino acids, accounting for a wide range of symptoms. These variants can be distinguished from one another by clinical, biochemical, and molecular differences (see Clin. Corr. 4.5).

nase, which ensures that the reaction goes to completion. The overall equilibrium of these two reactions lies far in the direction of NADPH maintaining a high NADPH/NADP⁺ ratio within cells. A second **dehydrogenation** and decarboxylation is catalyzed by **6-phosphogluconate dehydrogenase** and produces the pentose phosphate, **ribulose 5-phosphate**, and a second molecule of NADPH. The final step in synthesis of ribose 5-phosphate is the **isomerization**, through an enediol intermediate, of ribulose 5-phosphate by **ribose isomerase**.

These first reactions result in decarboxylation and production of NADPH and are considered to be the most important. Under certain metabolic conditions, the pentose phosphate pathway can end at this point, with utilization of NADPH for reductive biosynthetic reactions and ribose 5-phosphate as a precursor for nucleotide synthesis. The overall equation may be written as

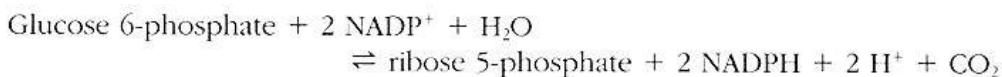
***Interconversions of Pentose Phosphates Lead to Glycolytic Intermediates***

In certain cells more NADPH is needed for **reductive biosynthesis** than ribose 5-phosphate for incorporation into nucleotides. A **sugar rearrangement** system (Figure 8.2) forms triose, tetrose, hexose, and heptose sugars from the pentoses, thus creating a **disposal mechanism** for ribose 5-phosphate and providing a **reversible link** between the pentose phosphate pathway and glycolysis via intermediates common to both pathways. For the interconversions, another pentose phosphate, **xylulose 5-phosphate**, must first be formed through **isomerization of ribulose 5-phosphate** by the action of **phosphopentose epimerase**. As a consequence, these three pentose phosphates exist as an equilibrium mixture and can then undergo further transformations catalyzed by **transketolase** and **transaldolase**. Both enzymes catalyze chain cleavage and transfer reactions involving the same group of substrates.

Transketolase requires thiamine pyrophosphate (TPP) and Mg²⁺, transfers a C₂ unit designated "**active glycolaldehyde**" from **xylulose 5-phosphate**

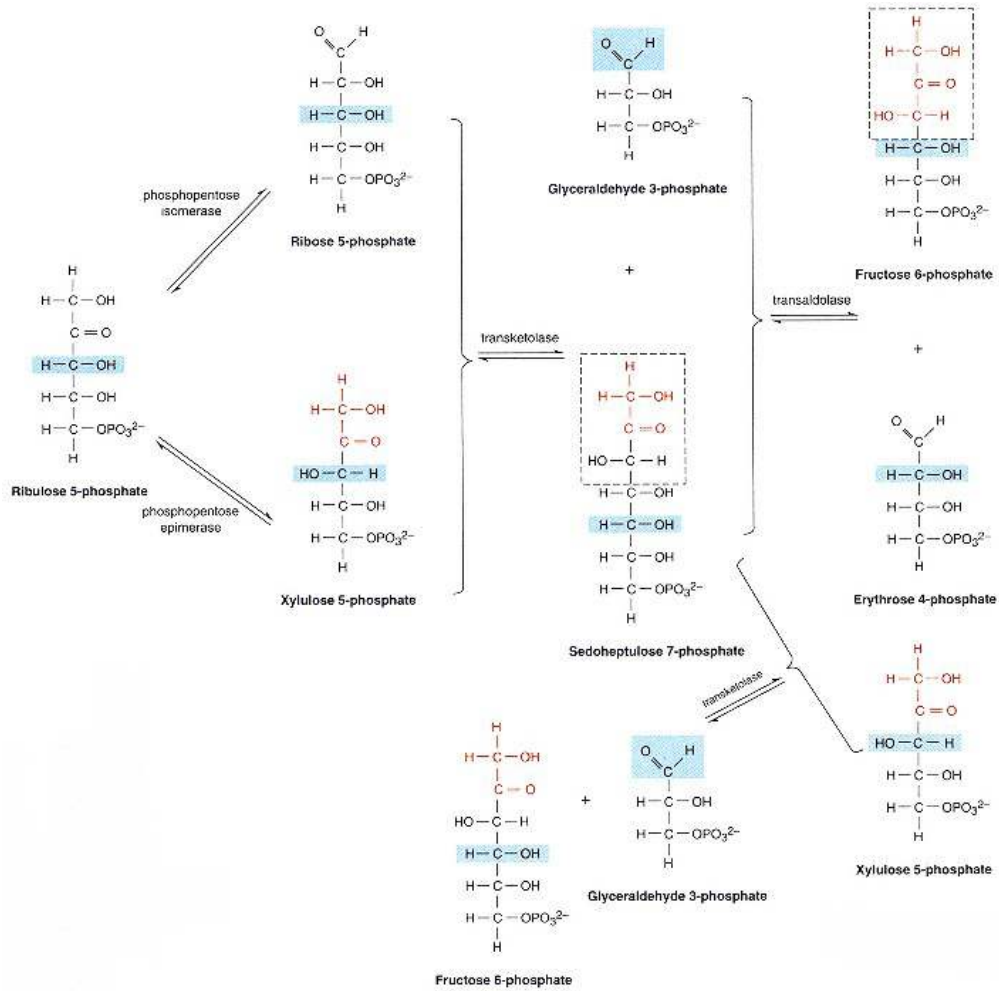
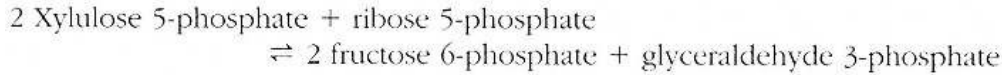

Figure 8.2
Interconversions of pentose phosphates.

to **ribose 5-phosphate**, and produces the C_7 sugar **sedoheptulose** and **glyceraldehyde 3-phosphate**, an intermediate of glycolysis. A further transfer reaction, catalyzed by transaldolase, results in the recovery of the first hexose phosphate. In this reaction a C_3 unit (**dihydroxyacetone**) from sedoheptulose 7-phosphate is transferred to glyceraldehyde 3-phosphate, forming the tetrose, **erythrose 4-phosphate**, and fructose 6-phosphate, another intermediate of glycolysis. In a third reaction, transketolase catalyzes the synthesis of fructose 6-phosphate and glyceraldehyde 3-phosphate from erythrose 4-phosphate and a second molecule of xylulose 5-phosphate. In this case, the C_2 unit is transferred

from xylulose 5-phosphate to an acceptor C₄ sugar, forming two glycolytic intermediates. The sum of these reactions is



Since xylulose 5-phosphate is derived from ribose 5-phosphate, the net reaction starting from ribose 5-phosphate is

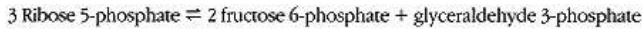

Therefore excess ribose 5-phosphate, whether it arises from the initial oxidation of G6P or from the degradative metabolism of nucleic acids, is effectively scavenged by conversion to intermediates that can enter the carbon flow of glycolysis.

Glucose 6-Phosphate Can Be Completely Oxidized to CO₂

In certain tissues, like lactating mammary gland, a pathway for complete **oxidation of G6P** to CO₂, with concomitant reduction of NADP⁺ to NADPH, also exists (Figure 8.3). By a complex sequence of reactions, ribulose 5-phosphate produced by the pentose phosphate pathway is recycled into G6P by transketolase, transaldolase, and certain enzymes of the gluconeogenic pathway. Hexose continually enters this system, and CO₂ evolves as the only carbon compound. A balanced equation for this process would involve the oxidation of six molecules of G6P to six molecules of ribulose 5-phosphate and six molecules of CO₂. This represents essentially the first part of the pentose phosphate pathway and results in transfer of 12 pairs of electrons to NADP⁺, the requisite

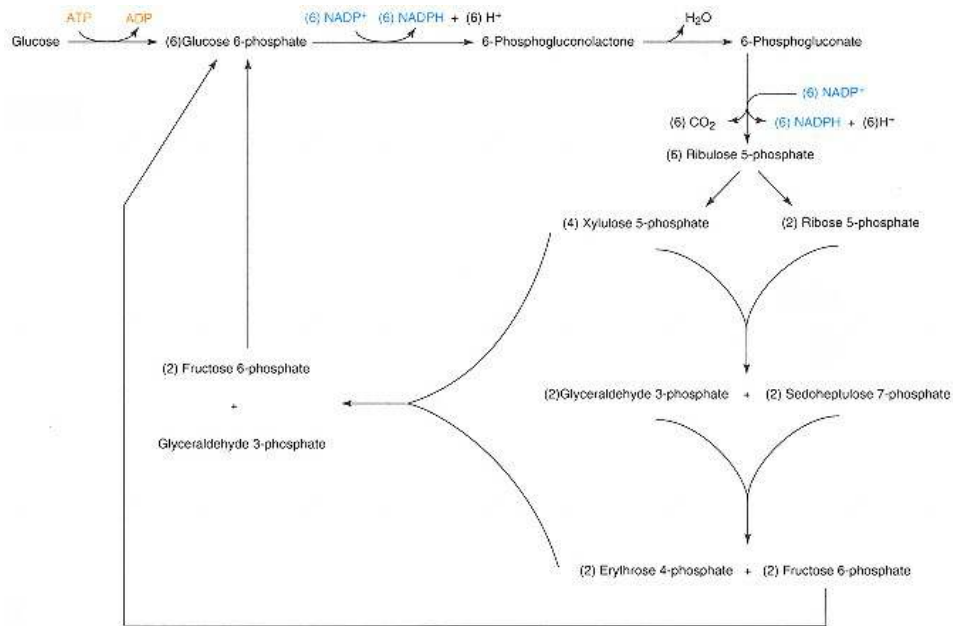
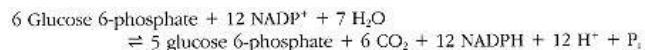
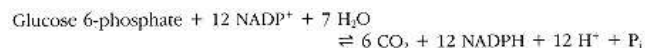

Figure 8.3
Pentose phosphate pathway.

amount for total oxidation of one glucose to six CO₂. The remaining six molecules of ribulose 5-phosphate are then rearranged by the pathway described above to regenerate five molecules of G6P. The overall equation can be written as



The net reaction is therefore



Pentose Phosphate Pathway Produces NADPH

The pentose phosphate pathway serves several purposes, including synthesis and degradation of sugars other than hexoses, particularly pentoses necessary for nucleotides and nucleic acids, and other glycolytic intermediates. Most important is the ability to synthesize NADPH, which has a unique role in biosynthetic reactions. The direction of flow and path taken by G6P after entry into the pathway is determined largely by the needs of the cell for NADPH or sugar intermediates. When more NADPH than ribose 5-phosphate is required, the pathway leads to complete oxidation of G6P to CO₂ and resynthesis of G6P from ribulose 5-phosphate. Alternatively, if more ribose 5-phosphate than NADPH is required, G6P is converted to fructose 6-phosphate and glyceraldehyde 3-phosphate by the glycolytic pathway. Two molecules of fructose 6-phosphate and one molecule of glyceraldehyde 3-phosphate are converted into three molecules of ribose 5-phosphate by reversal of the transaldolase and transketolase reactions.

The **distribution** of the **pentose phosphate pathway** in tissues is consistent with its functions. It is present in erythrocytes for production of NADPH, used to generate reduced glutathione, which is essential for maintenance of normal red cell structure. It is also active in liver, mammary gland, testis, and adrenal cortex, sites of fatty acid or steroid synthesis, which also require the reducing power of NADPH. In contrast, in mammalian striated muscle, which exhibits little fatty acid or steroid synthesis, all catabolism proceeds via glycolysis and the TCA cycle and no direct oxidation of glucose 6-phosphate occurs through the pentose phosphate pathway. In some other tissues like liver, 20–30% of the CO₂ produced may arise from the pentose phosphate pathway, and the balance between glycolysis and the pentose phosphate pathway depends on the metabolic requirements of the cell.

8.3—

Sugar Interconversions and Nucleotide Sugar Formation

In considering the general principles of carbohydrate metabolism, certain aspects of the origin and fate of other monosaccharides, oligosaccharides, and polysaccharides should be included. Most monosaccharides found in biological compounds derive from glucose. The most common reactions for sugar transformations in mammalian systems are summarized in Figure 8.4.

Isomerization and Phosphorylation Are Common Reactions for Interconverting Carbohydrates

Formation of some sugars can occur directly, starting from glucose via modification reactions, such as the conversion of G6P to fructose 6-phosphate by phosphoglucose isomerase in the glycolytic pathway. A similar **aldose–ketose**

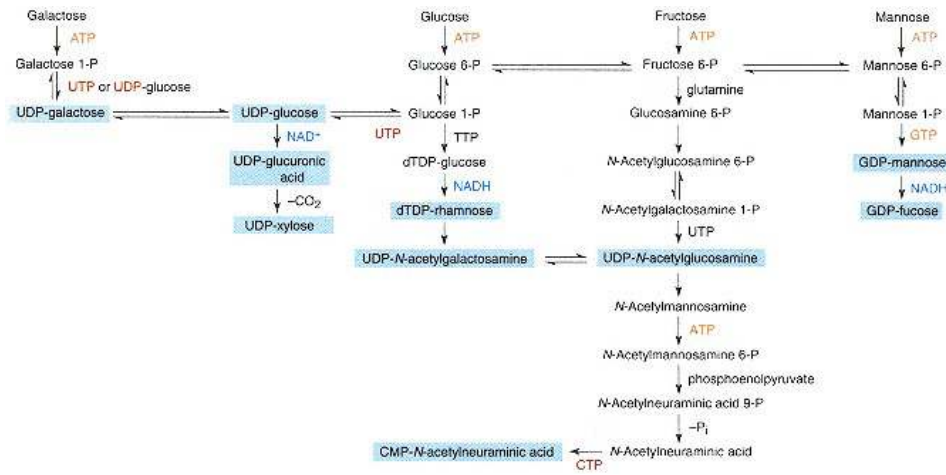

Figure 8.4
Pathways of formation of nucleotide sugars and interconversions of some hexoses.

isomerization catalyzed by **phosphomannose isomerase** results in synthesis of mannose 6-phosphate.

Internal transfer of a phosphate group on the same sugar molecule from one hydroxyl group to another is a common modification. Glucose 1-phosphate, resulting from enzymatic phosphorolysis of glycogen, is converted to G6P by phosphoglucomutase. Galactose can be phosphorylated directly to galactose 1-phosphate by a galactokinase and mannose to mannose 6-phosphate by a mannosokinase. Free fructose, an important dietary constituent, can be phosphorylated in the liver to fructose 1-phosphate by a special fructokinase. However, no mutase exists to interconvert fructose 1-phosphate and fructose 6-phosphate, nor can phosphofructokinase synthesize fructose 1,6-bisphosphate from fructose 1-phosphate. Rather, a fructose 1-phosphate aldolase cleaves fructose 1-phosphate to dihydroxyacetone phosphate (DHAP), which enters the glycolytic pathway directly, and glyceraldehyde, which must first be reduced to glycerol, phosphorylated, and then reoxidized to DHAP. Lack of this aldolase leads to fructose intolerance (see Clin. Corr. 8.2).

CLINICAL CORRELATION 8.2

Essential Fructosuria and Fructose Intolerance: Deficiency of Fructokinase and Fructose 1-Phosphate Aldolase

Fructose may account for 30–60% of the total carbohydrate intake of mammals. It is predominantly metabolized by a specific fructose pathway. The first enzyme in this pathway, fructokinase, is deficient in essential fructosuria. This disorder is a benign asymptomatic metabolic anomaly, which appears to be inherited as an autosomal recessive. Following intake of fructose, blood levels and urinary fructose are unusually high; however, 90% of fructose is eventually metabolized. In contrast, hereditary fructose intolerance is characterized by severe hypoglycemia after ingestion of fructose. Prolonged ingestion in young children may lead to death. In this disorder fructose 1-phosphate aldolase is deficient, and fructose 1-phosphate accumulates intracellularly (see Clin. Corr. 7.3).

Steinitz, H., and Mizrohy, O. Essential fructosuria and hereditary fructose intolerance. *N. Eng. J. Med.* 280:222, 1969.

Nucleotide-Linked Sugars Are Intermediates in Many Sugar Transformations

Most other sugar transformation reactions require prior conversion into **nucleotide-linked sugars**. Formation of nucleoside diphosphate (NDP)-sugar involves the reaction of hexose 1-phosphate and nucleoside triphosphate (NTP), catalyzed by a pyrophosphorylase. While these reactions are readily reversible, *in vivo* pyrophosphate is rapidly hydrolyzed by pyrophosphatase, thereby driving the synthesis of nucleotide sugars. These reactions are summarized as follows:

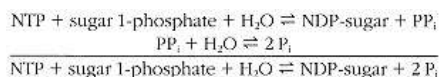

UDP-glucose is a common nucleotide sugar involved in synthesis of glycogen and glycoproteins. It is synthesized from glucose 1-phosphate and UTP in a reaction catalyzed by UDP-glucose pyrophosphorylase.

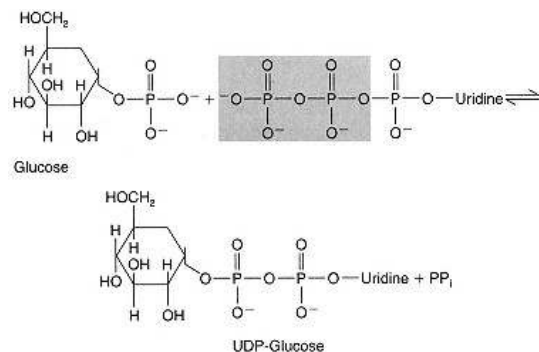

Nucleoside diphosphate-sugars contain two phosphoryl bonds, with a large negative ΔG of hydrolysis, that contribute to the energized character of these compounds as glycosyl donors in further transformation and transfer reactions, as well as conferring specificity on the enzymes catalyzing these reactions. For instance, uridine diphosphate usually serves as the glycosyl carrier, while ADP, GDP, and CMP act as carriers in other reactions. Many sugar transformation reactions, including epimerization, oxidation, decarboxylation, reduction, and rearrangement, occur only at the level of nucleotide sugars.

CLINICAL CORRELATION 8.3

Galactosemia: Inability to Transform Galactose into Glucose

Reactions of galactose are of particular interest because in humans they are subject to genetic defects resulting in the hereditary disorder galactosemia. When a defect is present, individuals are unable to metabolize the galactose derived from lactose (milk sugar) to glucose metabolites, often with resultant cataract formation, growth failure, mental retardation, or eventual death from liver damage. The genetic disturbance is expressed as a cellular deficiency of either galactokinase, causing a relatively mild disorder characterized by early cataract formation, or of galactose 1-phosphate uridylyl-transferase, resulting in severe disease.

Galactose is reduced to galactitol in a reaction similar to the reduction of glucose to sorbitol. Galactitol is the initiator of cataract formation in the lens and may play a role in the central nervous system damage. Accumulation of galactose 1-phosphate is responsible for liver failure; the toxic effects of galactose metabolites disappear when galactose is removed from the diet.

Segal, S., Blair, A., and Roth, H. The metabolism of galactose by patients with congenital galactosemia. *Am. J. Med.* 83:62, 1965.

Epimerization Interconverts Glucose and Galactose

Epimerization is a common type of reaction in carbohydrate metabolism. Reversible conversion of glucose to galactose in animals occurs by epimerization of UDP-glucose to UDP-galactose, catalyzed by UDP-glucose epimerase. UDP-galactose is also an important intermediate in metabolism of free galactose, derived from the hydrolysis of lactose in the intestinal tract. Galactose is phosphorylated by galactokinase and ATP to yield galactose 1-phosphate. Then galactose 1-phosphate uridylyltransferase transforms galactose 1-phosphate into UDP-galactose by displacing glucose 1-phosphate from UDP-glucose. These reactions are summarized as follows:

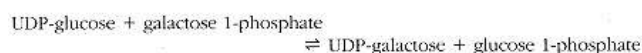

A hereditary disorder, galactosemia, results from the absence of this uridylyl-transferase (see Clin. Corr. 8.3).

A combination of these reactions allows an efficient transformation of dietary galactose into glucose 1-phosphate, which can then be further metabolized by previously described pathways. Alternatively, the 4-epimerase can operate in the reverse direction when UDP-galactose is needed for biosynthesis. Epimerization reactions are not exclusively restricted to nucleotide-linked sugars but also occur at the polymer level; D-glucuronic acid is epimerized to L-iduronic acid after incorporation into heparin and dermatan sulfate (see Section 8.6).

Glucuronic Acid Is Formed by Oxidation of UDP-Glucose

Oxidation and reduction interconversions result in formation of several additional sugars. **Glucuronic acid** is formed by oxidation of UDP-glucose catalyzed by **UDP-glucose dehydrogenase** (Figure 8.5) and most likely follows the outline in Figure 8.6. In humans glucuronic acid is converted to L-xylulose, the ketopentose excreted in **essential pentosuria** (see Clin. Corr. 8.4), and participates in detoxification by production of glucuronide conjugates (see Clin. Corr. 8.5).

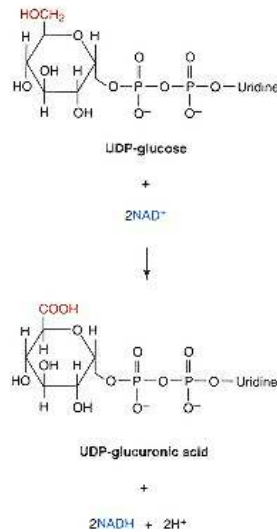

Figure 8.5
Formation of UDP-glucuronic acid from UDP-glucose.

Glucuronic acid is a precursor of **L-ascorbic acid** in those animals that synthesize vitamin C. Free glucuronic acid can be metabolized by reduction with NADPH to L-gulonic acid (Figure 8.7), which is then converted by a two-step process through L-gulonolactone to L-ascorbic acid (vitamin C) in plants and most higher animals. Humans, other primates, and the guinea pig lack the enzyme that converts L-gulonolactone to L-ascorbic acid and therefore must satisfy their needs for ascorbic acid by its ingestion. Gulonic acid can also be oxidized to 3-ketogulonic acid and decarboxylated to L-xylulose. L-Xylulose is reduced to xylitol, reoxidized to D-xylulose, and phosphorylated with ATP and an appropriate kinase to xylulose 5-phosphate. The latter compound can then reenter the pentose phosphate pathway described previously. The glucuronic acid pathway represents another pathway for oxidation of glucose. This pathway operates in adipose tissue, and its activity can be increased in tissue from starved or diabetic animals.

Decarboxylation, Oxidoreduction, and Transamination of Sugars Produce Necessary Products

Although **decarboxylation**, which degrades sugars one carbon atom at a time, has been encountered previously in the major metabolic pathways, the only known decarboxylation of a nucleotide sugar is the conversion of UDP-glucuronic acid to UDP-xylose. UDP-xylose is necessary for synthesis of proteoglycans (Section 8.6) and is a potent inhibitor of UDP-glucose dehydrogenase, the enzyme that oxidizes UDP-glucose to UDP-glucuronic acid (Figure 8.5). Thus the level of these nucleotide sugar precursors is regulated by this sensitive feedback mechanism.

Deoxyhexoses and **dideoxyhexoses** are also synthesized while the sugars are attached to nucleoside diphosphates, by a multistep process. For example, L-rhamnose is synthesized from glucose by a series of oxidation–reduction reactions starting with dTDP-glucose and yielding dTDP-rhamnose, catalyzed by oxidoreductases. Presumably, similar reactions account for synthesis of GDP-fucose from GDP-mannose and for various dideoxyhexoses.

Formation of amino sugars, major components of human oligo- and polysaccharides and as constituents of antibiotics, occurs by **transamidation**. For example, synthesis of glucosamine 6-phosphate occurs by reaction of fructose 6-phosphate with glutamine.

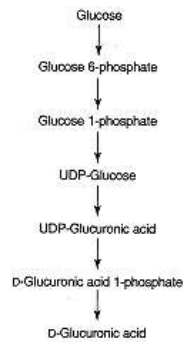
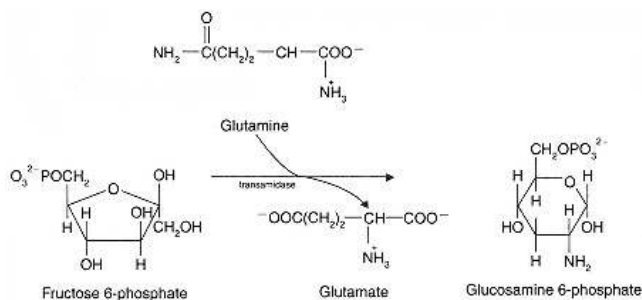

Figure 8.6
Biosynthesis of D-glucuronic acid from glucose.



Glucosamine 6-phosphate can be *N*-acetylated, forming *N*-acetylglucosamine 6-phosphate, followed by isomerization to *N*-acetylglucosamine 1-phosphate. This latter sugar is converted to UDP-*N*-acetylglucosamine by reactions similar to those of UDP-glucose synthesis. UDP-*N*-acetylglucosamine, a precursor of glycoprotein synthesis, can be epimerized to UDP-*N*-acetylgalactosamine, necessary for proteoglycan synthesis. The fructose 6-phosphate–glutamine transamidase reaction is under negative feedback control by UDP-*N*-acetylglucosamine; thus synthesis of both nucleotide sugars is regulated (Figure 8.4). This regulation is meaningful in certain tissues such as skin, in which this pathway can involve up to 20% of glucose flux.

CLINICAL CORRELATION 8.4

Pentosuria: Deficiency of Xylitol Dehydrogenase

The glucuronic acid oxidation pathway presumably is not essential for human carbohydrate metabolism, since individuals in whom the pathway is blocked suffer no ill effects. A metabolic variation, called idiopathic pentosuria, results from reduced activity of NADP-linked L-xylulose reductase, the enzyme that catalyzes the reduction of xylulose to xylitol. Hence affected individuals excrete large amounts of pentose into the urine especially following intake of glucuronic acid.

Wang, Y. M., and van Eys, J. The enzymatic defect in essential pentosuria. *N. Engl. J. Med.* 282:892, 1970.

Sialic Acids Are Derived from *N*-Acetylglucosamine

Another product derived from UDP-*N*-acetylglucosamine is **acetylneuraminic acid**, one of a family of C₉ sugars, called **sialic acids** (Figure 8.8). The first

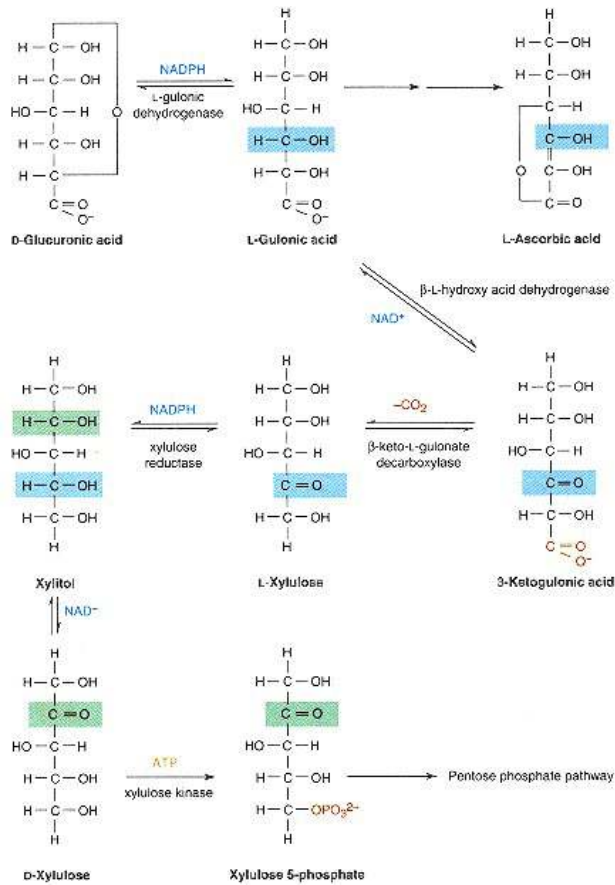

Figure 8.7
Glucuronic acid oxidation pathway.

reaction involves epimerization of UDP-*N*-acetylglucosamine by a 2-epimerase to *N*-acetylmannosamine, concomitant with elimination of UDP. Since the monosaccharide product is no longer bound to nucleotide, this epimerization is clearly different from those previously encountered. Most likely, this 2-epimerase reaction proceeds by a trans elimination of UDP, with formation of the unsaturated intermediate, 2-acetamidoglucal. In mammalian tissues *N*-acetyl-mannosamine is phosphorylated by ATP to *N*-acetylmannosamine 6-phosphate, which then condenses with phosphoenolpyruvate to form *N*-acetylneuraminic acid 9-phosphate. This product is cleaved by a phosphatase and activated by CTP to form the CMP derivative, CMP-*N*-acetylneuraminic acid. This is an unusual nucleotide sugar, containing only one phosphate group, and is formed by an irreversible reaction. *N*-Acetylneuraminic acid is a precursor of other sialic acid derivatives, some of which evolve by modification of *N*-acetyl to *N*-glycolyl or *O*-acetyl after incorporation into glycoprotein.

8.4—

Biosynthesis of Complex Carbohydrates

In complex carbohydrate-containing molecules, sugars are linked to other sugars by glycosidic bonds, formed by specific **glycosyltransferases**. Energy is required for synthesis of a glycosidic bond and is derived from nucleotide sugars as donor substrates. A glycosyltransferase reaction proceeds by donation of the glycosyl unit from the nucleotide derivative to the nonreducing end of an acceptor sugar. The nature of the bond formed is determined by the specificity of the glycosyltransferase, which is unique for the sugar acceptor, the sugar transferred, and the linkage formed. Thus polysaccharide synthesis is controlled by a nontemplate mechanism directed by specific glycosyltransferases. A glycosyltransferase reaction is summarized as follows:

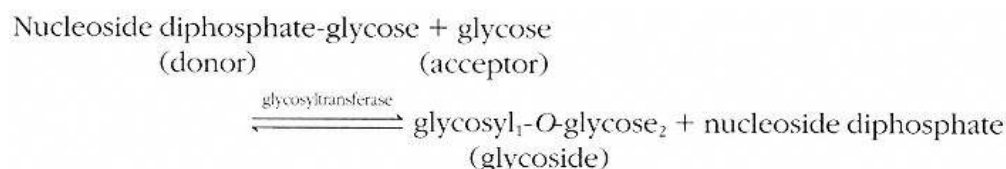

At least 40 different glycosidic bonds have been identified in mammalian oligosaccharides and about 15 more in connective tissue polysaccharides. The number of possible linkages is even greater and arises both from the diversity of monosaccharides covalently bonded and from the formation of both α and β

CLINICAL CORRELATION 8.5

Glucuronic Acid: Physiological Significance of Glucuronide Formation

The biological significance of glucuronic acid extends to its ability to be conjugated with certain endogenous and exogenous substances, forming a group of compounds collectively termed glucuronides in a reaction catalyzed by UDP-glucuronyltransferase. Conjugation of a compound with glucuronic acid produces a strongly acidic compound that is more water soluble at physiological pH than its precursor and therefore may alter the metabolism, transport, or excretion properties. Glucuronide formation is important in drug detoxification, steroid excretion, and bilirubin metabolism. Bilirubin is the major metabolic breakdown product of heme, the prosthetic group of hemoglobin. The central step in excretion of bilirubin is conjugation with glucuronic acid by UDP-glucuronyltransferase. Development of this conjugating mechanism occurs gradually and may take several days to 2 weeks after birth to become fully active in humans. So-called physiological jaundice of the newborn results in most cases from the inability of the neonatal liver to form bilirubin glucuronide at a rate comparable to that of bilirubin production. A defect in glucuronide synthesis has been found in a mutant strain of Wistar ("Gunn") rats, due to a deficiency of UDP-glucuronyltransferase and results in hereditary hyperbilirubinemia. In humans a similar defect is found in congenital familial nonhemolytic jaundice (Crigler–Najjar syndrome). Patients with this condition are also unable to conjugate foreign compounds efficiently with glucuronic acid.

Crigler, J. F., and Najjar, V. A. Congenital familial non-hemolytic jaundice with kernicterus. *Pediatrics* 10:169, 1952; Gunn, C. H. Hereditary acholuric jaundice in a new mutant strain of rats. *J. Hered.* 29:137, 1938; and Ostrow, J. D. (Ed.). *Bile Pigments and Jaundice*. New York: Marcel Dekker, 1986.

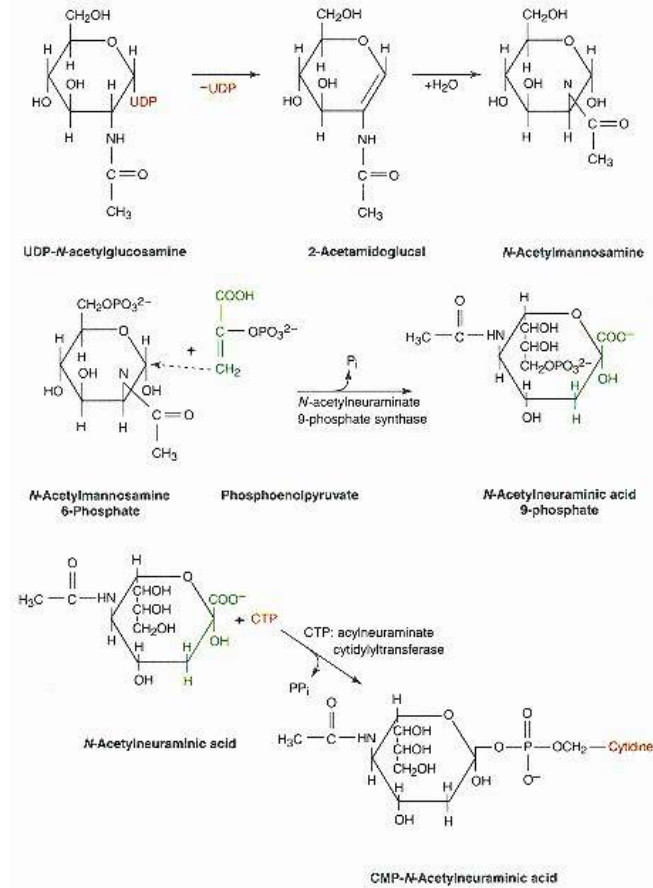

Figure 8.8
Biosynthesis of CMP-*N*-acetylneuraminic acid.

linkages, with each of the available hydroxyl groups on the acceptor saccharide. The large and diverse number of molecules that can be generated suggests that oligosaccharides have the potential for great informational content. In fact, it is known that the specificity of many biological molecules is determined by the nature of the composite sugar residues. For example, the specificity of the major blood types is determined by sugars (see Clin. Corr. 8.6). *N*-Acetylgalactosamine is the immunodeterminant of blood type A and galactose of blood type B. Removal of *N*-acetylgalactosamine from type A erythrocytes, or of galactose from type B erythrocytes, converts both to type O erythrocytes. Increasingly, other examples of sugars as determinants of specificity for cell surface receptor and lectin interactions, targeting of cells to certain tissues, and survival or clearance from the circulation of certain molecules are being recognized. All glycosidic bonds identified in biological compounds are degraded by specific hydrolytic enzymes, glycosidases. In addition to being valuable tools for the

CLINICAL CORRELATION 8.6**Blood Group Substances**

The surface of human erythrocytes is covered with a complex mosaic of specific antigenic determinants, many of which are polysaccharides. There are about 100 blood group determinants, belonging to 21 independent human blood group systems. The most widely studied are the antigenic determinants of the ABO blood group system and the closely related Lewis system. From the study of these systems, a definite correlation was established between gene activity as it relates to specific glycosyltransferase synthesis and oligosaccharide structure. The genetic variation is achieved through specific glycosyltransferases responsible for synthesis of the heterosaccharide determinants. For example, the *H* gene codes for a fucosyltransferase, which adds fucose to a peripheral galactose in the heterosaccharide precursor. The *A*, *B*, and *O* genes are located on chromosome 9. The *A* gene encodes an *N*-acetylgalactosamine glycosyltransferase, the *B* gene encodes a galactosyltransferase, and the *O* gene encodes an inactive enzyme. The sugars are added to the *H*-specific oligosaccharide. The Lewis (*Le*) gene codes for another fucosyltransferase, which adds fucose to a peripheral *N*-acetylglucosamine residue in the precursor. Absence of the *H* gene gives rise to the *Le*^a-specific determinant, whereas in the presence of both the *H* and *Le* genes, the interaction product responsible for the *Le*^b specificity is found. The elucidation of the structures of these oligosaccharide determinants represents a milestone in carbohydrate chemistry. This knowledge is essential to blood transfusion practices and for legal and historical purposes. For example, tissue dust containing complex carbohydrates has been used in serological analysis to establish the blood group of Tutankhamen and his probable ancestral background.

Watkins, W. M. Blood group substances. *Science* 152:172, 1966.

structural elucidation of oligosaccharides, interest in this class of enzymes exists because many genetic diseases of complex carbohydrate metabolism result from defects in glycosidases (see Clin. Corr. 8.7 and 8.8).

8.5—**Glycoproteins**

Glycoproteins have been restrictively defined as conjugated proteins that contain, as a prosthetic group, one or more saccharides lacking a serial repeat unit and bound covalently to a peptide chain. This definition excludes proteoglycans, which are discussed in Section 8.6.

The functions of glycoproteins in the human are of great interest. Glycoproteins in cell membranes may have an important role in the group behavior of cells and other important biological functions of the membrane. Glycoproteins form a major part of the mucus that is secreted by epithelial cells, where they perform an important role in lubrication and in the protection of tissues lining the body's ducts. Many other proteins secreted from cells into extracellular fluids are glycoproteins. These proteins include hormones found in blood, such as follicle-stimulating hormone, luteinizing hormone, and chorionic gonadotropin; and plasma proteins such as the orosomucoids, ceruloplasmin, plasminogen, prothrombin, and immunoglobulins (see Clin. Corr. 2.7).

Glycoproteins Contain Variable Amounts of Carbohydrate

The percentage of carbohydrate in glycoproteins is highly variable. Some glycoproteins such as IgG contain low amounts (4%) of carbohydrate by weight, while glycophorin, the human red cell membrane glycoprotein, contains 60% carbohydrate. Human ovarian cyst glycoprotein contains 70% carbohydrate, and human gastric glycoprotein is 82% carbohydrate. The carbohydrate can be distributed fairly evenly along the polypeptide chain or concentrated in defined regions. For example, in human glycophorin A the carbohydrate is found in the NH₂-terminal half of the polypeptide chain that lies on the outside of the cellular membrane.

The carbohydrate attached at one or at multiple points along a polypeptide chain usually contains less than 12–15 sugar residues. In some cases the carbohydrate component consists of a single sugar moiety, as in the submaxillary gland glycoprotein (single *N*-acetyl- α -D-galactosaminyl residue) and in some types of

CLINICAL CORRELATION 8.7**Aspartylglycosylaminuria: Absence of 4-L-Aspartylglycosamine Amidohydrolase**

A group of human inborn errors of metabolism involving storage of glycolipids, glycopeptides, mucopolysaccharides, and oligosaccharides exists. These diseases are caused by defects in lysosomal glycosidase activity, which prevents the catabolism of oligosaccharides. The disorders involve gradual accumulation in tissues and urine of compounds derived from incomplete degradation of the oligosaccharides and may be accompanied by skeletal abnormalities, hepatosplenomegaly, cataracts, or mental retardation. One disorder resulting from a defect in catabolism of asparagine-*N*-acetylglucosamine-linked oligosaccharides is aspartylglycosylaminuria. A deficiency in the enzyme 4-L-aspartylglycosylamine amidohydrolase allows accumulation of aspartylglucosamine-linked structures. (See accompanying table.)

Other disorders have been described involving accumulation of oligosaccharides derived from both glycoproteins and glycolipids, which may share common oligosaccharide structures (see table). Examples of genetic diseases include mannosidosis (α -mannosidase), the GM₂ gangliosidosis variant O (Sandhoff-Jatzkewitz disease; β -*N*-acetylhexosaminidases A and B), and GM₁ gangliosidosis (β -galactosidase). Mucopolipidosis II ("I-Cell Disease") is a generalized degradative disorder resulting from a deficiency of UDP-GlcNAc: lysosomal enzyme precursor GlcNAc phosphotransferase, which attacks Man-6-PO₄ (see also Chapter 10).

Sewell, A. C. Urinary oligosaccharide excretion in disorders of glycolipid, glycoprotein, and glycogen metabolism: a review of screening for differential diagnosis. *Eur. J. Pediatr* 134:183, 1980.

Enzymic Defects in Degradation of Asn-GlcNAc Type Glycoproteins^a

<i>Disease</i>	<i>Deficient Enzyme^b</i>
Aspartylglycosylaminuria	4-L-Aspartylglycosylamine amidohydrolase (a)
β -Mannosidosis	β -Mannosidase (7)
α -Mannosidosis	α -Mannosidase (3)
GM ₂ Gangliosidosis variant O (Sandhoff-Jatzkewitz disease)	β - <i>N</i> -Acetylhexosaminidases (A and B) (4)
GM ₁ Gangliosidosis	β -Galactosidase (5)
Mucopolipidosis I (Sialidosis)	Sialidase (6)
Fucosidosis	α -Fucosidase (8)

^a A typical Asn-GlcNAc oligosaccharide structure.

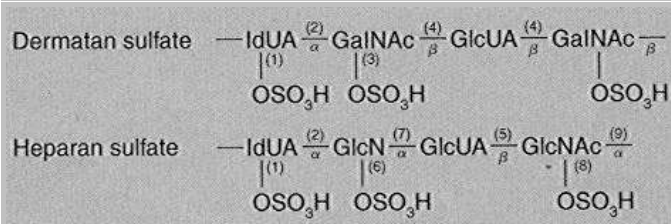

^b The numbers in parentheses refer to the enzymes that hydrolyze those bonds.

mammalian collagens (single α -D-galactosyl residue). In general, glycoproteins contain sugar residues in the D form, except for L-fucose, L-arabinose, and L-iduronic acid. A glycoprotein from different animal species often has an identical primary structure in the protein component, but a variable carbohydrate component. This heterogeneity of a given protein may even be true within a single organism. For example, pancreatic ribonuclease A and B forms have identical amino acid sequences and a similar kinetic specificity toward substrates, but they differ significantly in their carbohydrate composition.

Carbohydrates Are Covalently Linked to Glycoproteins by *N*- or *O*-Glycosyl Bonds

At present, the structures of a limited number of oligosaccharide components have been elucidated completely. **Microheterogeneity** of glycoproteins, arising from incomplete synthesis or partial degradation, makes structural analyses

CLINICAL CORRELATION 8.8**Heparin Is an Anticoagulant**

Heparin is a naturally occurring sulfated polysaccharide that is used to reduce the clotting tendency of patients. Both *in vivo* and *in vitro* heparin prevent the activation of clotting factors but do not act directly on the clotting factors. Rather, the anticoagulant activity of heparin is brought about by the binding interaction of heparin with an inhibitor of the coagulation process. Presumably, heparin binding induces a conformational change in the inhibitor that generates a complementary interaction between the inhibitor and the activated coagulation factor, thereby preventing the factor from participating in the coagulation process. The inhibitor that interacts with heparin is antithrombin III, a plasma protein inhibitor of serine proteases. In the absence of heparin, antithrombin III slowly (10–30 min) combines with several clotting factors, yielding complexes devoid of proteolytic activity. In the presence of heparin, inactive complexes are formed within a few seconds. Antithrombin III contains an arginine residue that combines with the active site serine of factors Xa and IXa; thus the inhibition is stoichiometric. Heterozygous antithrombin III deficiency results in an increased risk of thrombosis in the veins and resistance to the action of heparin.

Rosenberg, R. D., and Rosenberg, J. S. Natural anticoagulant mechanisms. *J. Clin. Invest.* 74:1, 1984.

extremely difficult. However, certain generalities about the structure of glycoproteins have emerged. Covalent linkage of sugars to the peptide chain is a central part of glycoprotein structure, and only a limited number of bonds are found (see Chapter 2). The three major types of **glycopeptide bonds**, as shown in Figure 8.9 and Figure 2.45, are *N*-glycosyl to **asparagine** (Asn), *O*-glycosyl to **serine** (Ser) or **threonine** (Thr), and *O*-glycosyl to **5-hydroxylysine**. The latter linkage, representing the carbohydrate side chains of either a single galactose or the disaccharide glucosylgalactose covalently bonded to hydroxylysine, is generally confined to the collagens. The other two linkages occur in a wide variety of glycoproteins. Of the three major types, only the *O*-glycosidic linkage to serine or threonine is labile to alkali cleavage. By this procedure two types of oligosaccharides (simple and complex) are released. Examination of the simple class from porcine submaxillary mucins reveals some general structural features. A core structure exists, consisting of galactose (Gal) linked $\beta(1 \rightarrow 3)$ to *N*-acetylgalactosamine (GalNAc) *O*-glycosidically linked to serine or threonine residues. Residues of L-fucose (Fuc), sialic acid (NeuAc), and another *N*-acetylgalactosamine are found at the nonreducing periphery of this class of glycopeptides. The general structure of this type of glycopeptide is as follows:

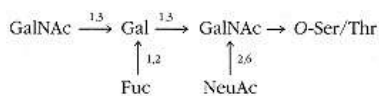

More complex heterosaccharides are also linked to peptides via serine or threonine residues and are exemplified by the blood group substances. Study of these determinants has shown how complex and variable these structures are, as well as how the oligosaccharides of cell surfaces are assembled and how that assembly pattern is genetically determined. An example of how oligosaccharide structures on the surface of red blood cells determine blood group specificity is presented in Clin. Corr. 8.6. Certain common structural features of the oligosaccharide *N*-glycosidically linked to asparagine have also emerged. These glycoproteins commonly contain a core structure consisting of mannose (Man) residues linked to *N*-acetylglucosamine (GlcNAc) in the following structure:

**Synthesis of *N*-Linked Glycoproteins Involves Dolichol Phosphate**

While the synthesis of *O*-glycosidically linked glycoproteins involves the sequential action of a series of glycosyltransferases, the synthesis of *N*-glycosidically linked peptides involves a somewhat different and more complex mechanism (Figure 8.10). A common core is preassembled as a **lipid-linked oligosaccharide** prior to incorporation into the polypeptide. During synthesis, the oligosaccharide intermediates are bound to derivatives of **dolichol phosphate**.

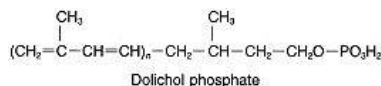

Dolichols are polyprenols ($\text{C}_{80} - \text{C}_{100}$) containing 16–20 isoprene units, in which the final isoprene unit is saturated. These lipids participate in two types of reactions in core oligosaccharide synthesis. The first reaction involves formation of *N*-acetylglucosaminylpyrophosphoryldolichol with release of UMP from the respective nucleotide sugar. The second *N*-acetylglucosamine and the mannose transferase reactions proceed by sugar transfer from the nucleotide without formation of intermediates. Subsequent addition of mannose units occurs via

a dolichol-linked mechanism. In the final step, the oligosaccharide is transferred from the dolichol pyrophosphate to an asparagine residue in the polypeptide chain.

After synthesis of the specific core region, the oligosaccharide chains are completed by action of glycosyltransferases without further participation of lipid intermediates. Extensive processing in the Golgi body, involving addition and subsequent removal of certain glycosyl residues, occurs during the course of synthesis of asparagine-*N*-acetylglucosamine-linked glycoproteins. Just as the synthesis of oligosaccharides requires specific glycosyltransferases, degradation requires specific glycosidases. Exoglycosidases remove sugars sequentially from the nonreducing end, exposing the substrate for the subsequent glycosidase. The absence of a particular glycosidase prevents the action of the next enzyme, resulting in cessation of catabolism and accumulation of the product (see Clin. Corr. 8.7). Endoglycosidases with broader specificity also exist and the action of endo- and exoglycosidases results in catabolism of glycoproteins. Although the primary degradation process occurs in lysosomes, there are specific endo-plasmic reticulum glycosidases involved in processing of glycoproteins during synthesis as well.

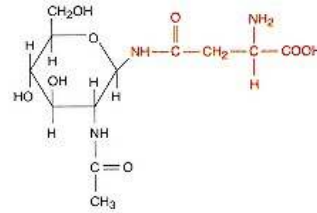

Type I *N*-Glycosyl linkage to asparagine

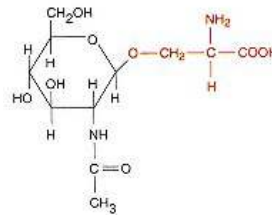

Type II *O*-Glycosyl linkage to serine

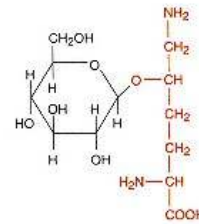

Figure 8.9

Structure of three major glycopeptide bonds.

8.6— Proteoglycans

In addition to glycoproteins, which usually contain proportionally less carbohydrate than protein by weight, there is another class of complex macromolecules, which can contain as much as 95% or more carbohydrate. Their properties resemble polysaccharides more than proteins. To distinguish these compounds

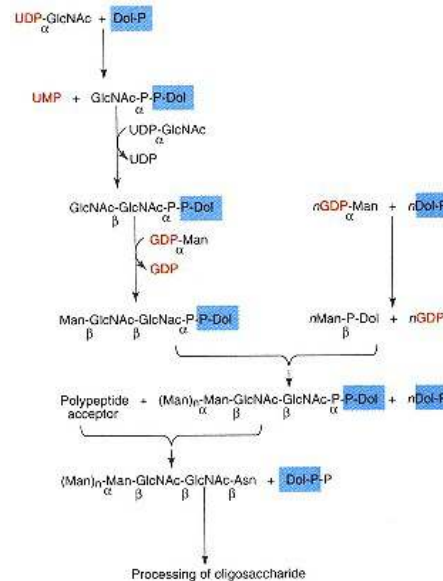

Figure 8.10

Biosynthesis of the oligosaccharide core in asparagine-*N*-acetylgalactosamine-linked glycoproteins.

Dol, dolichol.

from other glycoproteins, they are referred to as **proteoglycans** and their carbohydrate chains as **glycosaminoglycans**. An older name, mucopolysaccharides, is still in use, especially in reference to the group of storage diseases, mucopolysaccharidoses, which result from an inability to degrade these molecules (see Clin. Corr. 8.9).

Proteoglycans are high molecular weight polyanionic substances consisting of many different glycosaminoglycan chains linked covalently to a protein core. Although six distinct classes of glycosaminoglycans are now recognized,

CLINICAL CORRELATION 8.9

Mucopolysaccharidoses

A group of human genetic disorders characterized by excessive accumulation and excretion of the oligosaccharides of proteoglycans exists, collectively called mucopolysaccharidoses. These disorders result from a deficiency of one or more lysosomal hydrolases responsible for the degradation of dermatan and/or heparan sulfate. The enzymes lacking in specific mucopolysaccharidoses that have been identified are presented in the accompanying table.

Although the chemical basis for this group of disorders is similar, their mode of inheritance as well as clinical manifestations may vary. Hurler's syndrome and Sanfilippo's syndrome are transmitted as autosomal recessives, whereas Hunter's syndrome is X-linked. Both Hurler's syndrome and Hunter's syndrome are characterized by skeletal abnormalities and mental retardation, which in severe cases may result in early death. In contrast, in the Sanfilippo syndrome, the physical defects are relatively mild, while the mental retardation is severe. Collectively, the incidence for all mucopolysaccharidoses is 1 per 30,000 births.

In addition to those listed in the table, some others exist. Morquio's syndrome involves impaired degradation of keratan sulfate, and two types have been identified: type A due to deficiency of galactose 6-sulfatase and type B due to deficiency of β -galactosidase. Multiple sulfatase deficiency (MSD) is characterized by decreased activity of all known sulfatases. Recent evidence suggests that a co- or posttranslational modification of a cysteine to a 2-amino 3-oxopropionic acid is required for active sulfatases and that a lack of this modification results in MSD.

These disorders are amenable to prenatal diagnosis, since the pattern of metabolism by affected cells obtained from amniotic fluid is strikingly different from normal.

McKusick 5th ed. New York: McGraw-Hill, 1983, V., and Neufeld, E. F. The mucopolysaccharide storage diseases. In: J. B. Stansbury, J. B. Wyngaarden, D. S. Frederickson, J. L. Goldstein, and M. S. Brown (Eds.). *The Metabolic Basis of Inherited Disease*, p. 751.

Enzymic Defects in the Mucopolysaccharidoses

Disease	Accumulated Products ^a	Deficient Enzyme ^b
Hunter	Heparan sulfate Dermatan sulfate	Iduronate sulfatase (1)
Hurler + Scheie	Heparan sulfate Dermatan sulfate	-L-Iduronidase (2)
Maroteaux-Lamy	Dermatan sulfate	N-Acetylgalactosamine (3) sulfatase
Mucopolipidosis VII	Heparan sulfate Dermatan sulfate	-Glucuronidase (5)
Sanfilippo A	Heparan sulfate	Heparan sulfamidase (6)
Sanfilippo B	Heparan sulfate	N-Acetylglucosaminidase (9)
Sanfilippo D	Heparan sulfate	N-Acetylglucosamine 6-sulfatase (8)

^a Structures of dermatan sulfate and heparan sulfate.

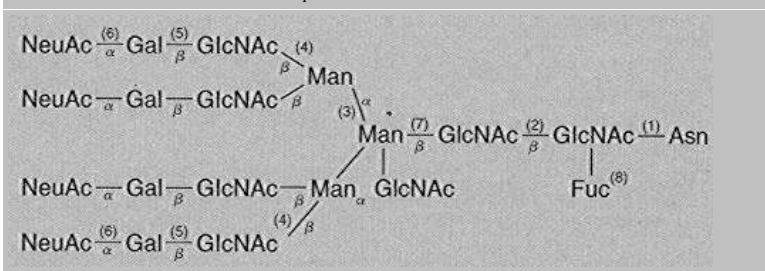

^b The numbers in parentheses refer to the enzymes that hydrolyze those bonds.

certain features are common to all classes. The long unbranched heteropolysaccharide chains are made up largely of disaccharide repeating units, in which one sugar is a hexosamine and the other a uronic acid. Other common constituents of glycosaminoglycans are sulfate groups, linked by ester bonds to certain monosaccharides or by amide bonds to the amino group of glucosamine. An exception, hyaluronate, is not sulfated and has not been shown to exist covalently attached to protein. The carboxyl from uronic acids and sulfate groups contribute to the highly charged polyanionic nature of glycosaminoglycans. Both their electrical charge and macromolecular structure aid in their biological role as lubricants and support elements in connective tissue. Proteoglycans form solutions with high viscosity and elasticity by absorbing large volumes of water. This allows them to act in stabilizing and supporting fibrous and cellular elements of tissues, as well as contributing to the maintenance of water and salt balance in the body. Increasingly more dynamic roles as receptors for growth factors, transport proteins, and viruses are being elucidated for the proteoglycans.

Hyaluronate Is a Copolymer of *N*-Acetylglucosamine and Glucuronic Acid

Hyaluronate is very different from the other five types of glycosaminoglycans. It is unsulfated, not covalently complexed with protein, and the only glycosaminoglycan not limited to animal tissue; it is also produced by bacteria. It is classified as a glycosaminoglycan because of its structural similarity to these other polymers, since it consists solely of repeating disaccharide units of *N*-acetylglucosamine and glucuronic acid (Figure 8.11). Although hyaluronate has the least complex chemical structure of all the glycosaminoglycans, the chains can reach molecular weights of 10^5 – 10^7 . The large molecular weight, polyelec-

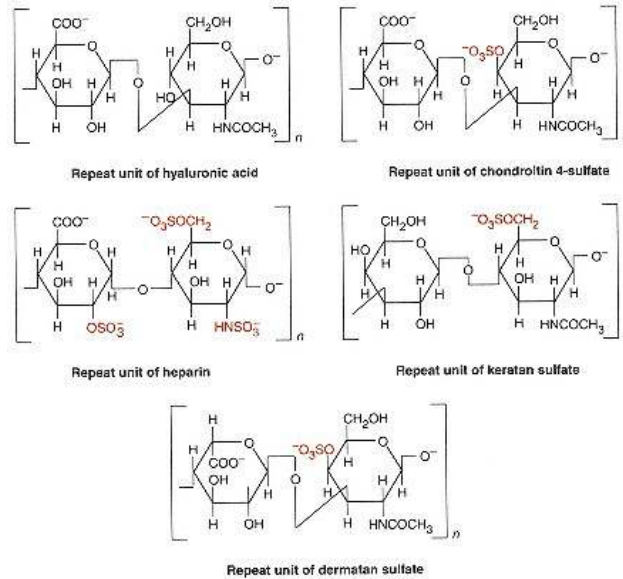

Figure 8.11

Major repeat units of glycosaminoglycan chains.

trolyte character, and large volume it occupies in solution all contribute to the properties of hyaluronate as a lubricant and shock absorbent. Hence it is found predominantly in synovial fluid, vitreous humor, and umbilical cord.

Chondroitin Sulfates Are the Most Abundant Glycosaminoglycans

The most abundant glycosaminoglycans in the body are the chondroitin sulfates. Individual polysaccharide chains are attached to specific serine residues in a protein core of variable molecular weight through a tetrasaccharide linkage region.

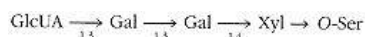

The characteristic repeating disaccharide units of *N*-acetylgalactosamine and glucuronic acid are covalently attached to this linkage region (Figure 8.11). The disaccharides can be sulfated in either the 4 or 6 position of *N*-acetylgalactosamine. Each polysaccharide chain contains between 30 and 50 such disaccharide units, corresponding to molecular weights of 15,000–25,000. An average chondroitin sulfate proteoglycan molecule has approximately 100 chondroitin sulfate chains attached to the protein core, giving a molecular weight of $1.5\text{--}2 \times 10^6$. Proteoglycan preparations are, however, extremely heterogeneous, differing in length of protein core, degree of substitution, distribution of polysaccharide chains, length of chondroitin sulfate chains, and degree of sulfation. Chondroitin sulfate proteoglycans have also been shown to aggregate noncovalently with hyaluronate, forming much larger structures. They are prominent components of cartilage tendons, ligaments, and aorta and have also been isolated from brain, kidney, and lung.

Dermatan Sulfate Contains L-Iduronic Acid

Dermatan sulfate differs from chondroitin 4- and 6-sulfates in that its predominant uronic acid is L-iduronic acid, although D-glucuronic acid is also present in variable amounts. The glycosidic linkages have the same position and configuration as in chondroitin sulfates, with average polysaccharide chains of molecular weights of $2\text{--}5 \times 10^4$. Unlike the chondroitin sulfates, dermatan sulfate is antithrombic like heparin, but in contrast to heparin, it shows only minimal whole-blood anticoagulant and blood lipid-clearing activities. As a connective tissue macromolecule, dermatan sulfate is found in skin, blood vessels, and heart valves.

Heparin and Heparan Sulfate Differ from Other Glycosaminoglycans

Heparin differs from other glycosaminoglycans in a number of important respects. Glucosamine and D-glucuronic acid or L-iduronic acid form the characteristic disaccharide repeat unit, as in dermatan sulfate (Figure 8.11). In contrast to most other glycosaminoglycans, heparin contains α -glycosidic linkages. Almost all glucosamine residues contain sulfamide linkages, but a small number of glucosamine residues are *N*-acetylated. The sulfate content of heparin, although variable, approaches 2.5 sulfate residues per disaccharide unit in preparations with the highest biological activity. In addition to *N*-sulfate and *O*-sulfate on C-6 of glucosamine, heparin can also contain sulfate on C-3 of the hexosamine and C-2 of the uronic acid. Unlike other glycosaminoglycans, heparin is an intracellular component of mast cells and functions predominantly as an anticoagulant and lipid-clearing agent (see Clin. Corr. 8.8 on p. 350).

Heparan sulfate contains a similar disaccharide repeat unit but has more *N*-acetyl groups, fewer *N*-sulfate groups, and a lower degree of *O*-sulfate groups. Heparan sulfate may be extracellular or an integral and ubiquitous component of the cell surface in many tissues including blood vessel walls, amyloid, and brain.

Keratan Sulfate Exists in Two Forms

Keratan sulfate is composed principally of the repeating disaccharide unit of *N*-acetylglucosamine and galactose, with no uronic acid in the molecule (Figure 8.11). Sulfate content is variable, with ester sulfate present on C-6 of both galactose and hexosamine. Two types of keratan sulfate differ in overall carbohydrate content and tissue distribution. Both contain as additional monosaccharides, mannose, fucose, sialic acid, and *N*-acetylgalactosamine. Keratan sulfate I, isolated from cornea, is linked to protein by an *N*-acetylglucosamine–asparaginyl bond, typical of glycoproteins. Keratan sulfate II, isolated from cartilage, is attached to protein through *N*-acetylgalactosamine in *O*-glycosidic linkage to either serine or threonine. Skeletal keratan sulfates are often found covalently attached to the same core protein as are the chondroitin sulfate chains.

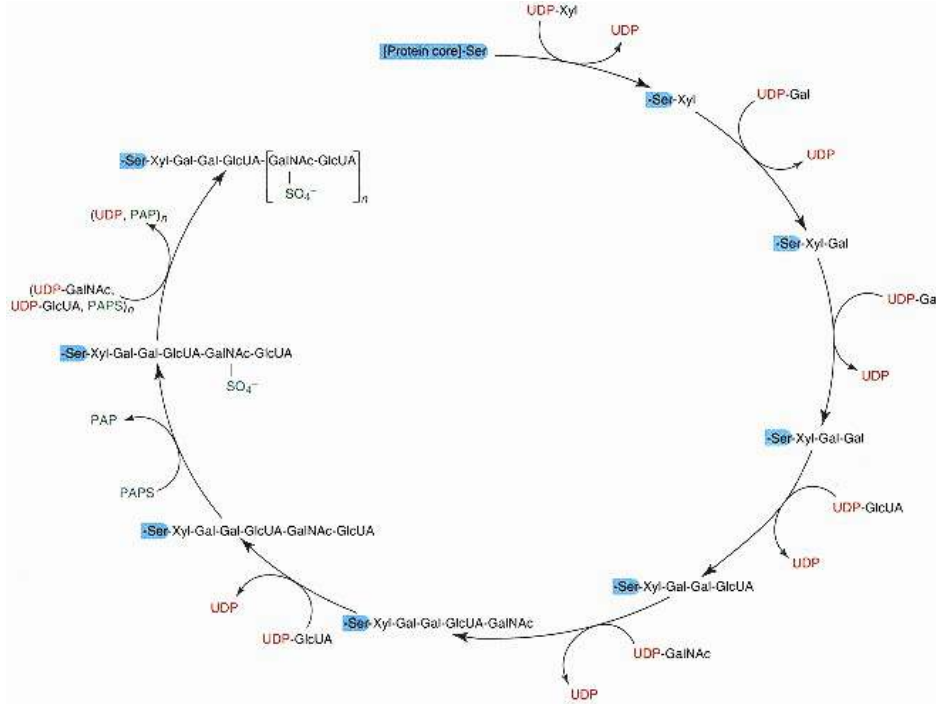

Figure 8.12

Synthesis of chondroitin sulfate proteoglycan.

Xyl, xylose; Gal, galactose; GlcUA, glucuronic acid; GalNAc, *N*-acetylgalactosamine; PAPS, 3-phosphoadenosine 5-phosphosulfate.

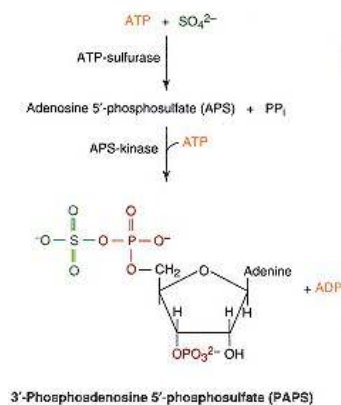

Figure 8.13
Biosynthesis of 3-phosphoadenosine
5-phosphosulfate (PAPS).

Biosynthesis of Chondroitin Sulfate Is Typical of Glycosaminoglycan Formation

The polysaccharide chains of proteoglycans are assembled by sequential action of a series of glycosyltransferases in the endoplasmic reticulum, which catalyze the transfer of a monosaccharide from a nucleotide sugar to an appropriate acceptor, either the nonreducing end of another sugar or a polypeptide. Since the biosynthesis of the chondroitin sulfates is most thoroughly understood, this pathway will be discussed as the prototype for glycosaminoglycan formation (Figure 8.12 on p. 355).

Formation of the core protein of the chondroitin sulfate proteoglycan is the first step in this process, followed by assembly of the polysaccharide chains catalyzed by six different glycosyltransferases in the lumen of the endoplasmic reticulum. Strict substrate specificity is required for completion of the unique tetrasaccharide linkage region. Polymerization then results from the concerted action of two glycosyltransferases, an *N*-acetylgalactosaminyltransferase and a glucuronosyltransferase, which alternately add the two monosaccharides, forming the characteristic repeating disaccharide units. Sulfation of *N*-acetylgalactosamine residues in either the 4 or 6 position apparently occurs along with chain elongation. The sulfate donor, as in other biological systems, is 3-phosphoadenosine 5-phosphosulfate (PAPS), which is formed from ATP and sulfate in two steps (Figure 8.13).

Synthesis of other glycosaminoglycans requires additional transferases specific for the sugars and linkages found in these molecules. Completion often involves modifications in addition to *O*-sulfation, including epimerization, acetylation, and *N*-sulfation. Interestingly, the epimerization of D-glucuronic acid to L-iduronic acid occurs after incorporation into the polymer chain and is coupled with the process of sulfation.

Synthesis of both proteoglycans and glycoproteins is regulated by the same mechanism at the level of hexosamine synthesis. The fructose 6-phosphate-glutamine transamidase reaction (Figure 8.4) is subject to feedback inhibition by UDP-*N*-acetylglucosamine, which is in equilibrium with UDP-*N*-acetylgalactosamine. More specific to proteoglycan synthesis, the levels of UDP-xylose and UDP-glucuronic acid are stringently controlled by the inhibition by UDP-xylose of the UDP-glucose dehydrogenase conversion of UDP-glucose to UDP-glucuronic acid (Figure 8.4). Since xylose is the first sugar added during synthesis of chondroitin sulfate, dermatan sulfate, heparin, and heparan sulfate, the earliest effect of decreased core protein synthesis would be accumulation of UDP-xylose, which aids in maintaining a balance between synthesis of protein and polysaccharide moieties of these complex macromolecules.

Proteoglycans, like glycoproteins, are degraded by the sequential action of proteases and **glycosidases**, as well as **deacetylases** and **sulfatases**. Much of the information about metabolism and degradation of proteoglycans has been derived from the study of **mucopolysaccharidoses** (see Clin. Corr. 8.9). This group of human genetic disorders is characterized by accumulation in tissues and excretion in urine of oligosaccharide products derived from incomplete breakdown of the proteoglycans, due to a deficiency of one or more lysosomal hydrolases. In the diseases for which the biochemical defect has been identified, a product accumulates that has a nonreducing terminus that would have been the substrate for the deficient enzyme.

Although proteoglycans continue to be defined on the basis of the glycosaminoglycan chain they contain, new ones are increasingly being described based largely on functional properties or location. Aggrecan and versican are the predominant extracellular species; syndecan, CD44, and thrombomodulin are integral membrane proteins; neurocan, brevican, cerebrosin, and phosphacan are largely restricted to the nervous system; while many proteoglycans (i.e., aggrecan, syndecan, and betaglycan) carry two types of glycosaminoglycan

chains, whose size and ratio may change with development, age, or disease. Thus it appears that the versatile structure of these abundant carbohydrate-containing molecules is well exploited by cells in many as yet undiscovered ways.

Bibliography

- Dutton, G. J. (Ed.). *Glucuronic Acid, Free and Combined*. New York: Academic Press, 1966.
- Ginsburg, V., and Robbins, P. (Eds.). *Biology of Carbohydrates*. New York: Wiley, 1984.
- Horecker, B. L. *Pentose Metabolism in Bacteria*. New York: Wiley, 1962.
- Kornfeld, R., and Kornfeld, S. Assembly of Asn-linked oligosaccharides. *Annu. Rev. Biochem.* 54:631, 1985.
- Lennarz, W. J. (Ed.). *The Biochemistry of Glycoproteins*. New York: Plenum Press, 1980.
- Menkes, J. A. Metabolic diseases of the nervous system. In: *Textbook of Child Neurology*, 4th ed. Philadelphia: Lea & Febiger, 1990, p. 28.
- Nyhan, W. L., and Sakati, N. A. Mucopolysaccharidoses and related disorders. In: *Diagnostic Recognition of Genetic Disease*. Philadelphia: Lea & Febiger, 1987, p. 371.
- Rademacker, T. W., Parck, R. B., and Dwek, R. A. Glycobiology. *Annu. Rev. Biochem.* 57:285, 1988.
- Schwartz, N. B., and Smalheiser, N. Biosynthesis of glycosaminoglycans and proteoglycans. In: *Neurobiology of Glycoconjugates*. New York: Plenum Press, 1989, p. 151.
- Scriver, C. R., Beaudet, A. L., Sly, W. S. and Valle, D. (Eds.) *The Metabolic and Molecular Bases of Inherited Disease*, 7th ed. New York: McGraw-Hill, 1995.

Questions

C. N. Angstadt and J. Baggott

- [NADPH/NADP⁺] is maintained at a high level in cells primarily by:
 - lactate dehydrogenase.
 - the combined actions of glucose-6-phosphate dehydrogenase and gluconolactonase.
 - the action of the electron transport chain.
 - shuttle mechanisms such as the α -glycerophosphate dehydrogenase shuttle.
 - the combined actions of transketolase and transaldolase.
- Transketolase:
 - transfers a C₂ fragment to an aldehyde acceptor.
 - transfers a C₃ ketone-containing fragment to an acceptor.
 - converts the ketose sugar ribulose 5-phosphate to ribose 5-phosphate.
 - is part of the irreversible oxidative phase of the pentose phosphate pathway.
 - converts two C₅ sugar phosphates to fructose 6-phosphate and erythrose 4-phosphate.
- If a cell requires more NADPH than ribose 5-phosphate:
 - only the first phase of the pentose phosphate pathway would occur.
 - glycolytic intermediates would flow into the reversible phase of the pentose phosphate pathway.
 - there would be sugar interconversions but no net release of carbons from glucose 6-phosphate.
 - the equivalent of the carbon atoms of glucose 6-phosphate would be released as 6 CO₂.
 - only part of this need could be met by the pentose pathway, and the rest would have to be supplied by another pathway.
- All of the following interconversions of monosaccharides (or derivatives) require a nucleotide-linked sugar intermediate EXCEPT:
 - galactose 1-phosphate to glucose 1-phosphate.
 - glucose 6-phosphate to mannose 6-phosphate.
 - glucose to glucuronic acid.
 - glucuronic acid to xylose.
 - glucosamine 6-phosphate to *N*-acetylneuraminic acid (a sialic acid).
- Fructose:
 - unlike glucose, cannot be catabolized by the glycolytic pathway.
 - in the liver, enters directly into glycolysis as fructose 6-phosphate.
 - must be isomerized to glucose before it can be metabolized.
 - is converted to a UDP-linked form and then epimerized to UDP-glucose.
 - catabolism in liver uses fructokinase and a specific aldolase that recognizes fructose 1-phosphate.
- Galactosemia:
 - is a genetic deficiency of a uridylyltransferase that exchanges galactose 1-phosphate for glucose on UDP-glucose.
 - results from a deficiency of an epimerase.
 - is not apparent at birth but symptoms develop in later life.
 - is an inability to form galactose 1-phosphate.
 - would be expected to interfere with the use of fructose as well as galactose because the deficient enzyme is common to the metabolism of both sugars.
- All of the following are true about glucuronic acid EXCEPT:
 - it enhances the water solubility of compounds to which it is conjugated.
 - as a UDP derivative, it can be decarboxylated to a component used in proteoglycan synthesis.
 - it is a precursor of ascorbic acid in humans.
 - its formation from glucose is under feedback control by a UDP-linked intermediate.
 - it can ultimately be converted to xylulose 5-phosphate and thus enter the pentose phosphate pathway.
- The conversion of fructose 6-phosphate to glucosamine 6-phosphate:
 - is a transamination reaction with glutamate as the nitrogen donor.
 - is stimulated by UDP-*N*-acetylglucosamine.
 - requires that fructose 6-phosphate first be linked to a nucleotide.
 - is a first step in the formation of *N*-acetylated amine sugars.
 - occurs only in the liver.

9. Roles for the complex carbohydrate moiety of glycoproteins include all of the following EXCEPT:
- determinant of blood type.
 - template for the synthesis of glycosaminoglycans.
 - cell surface receptor specificity.
 - determinant of the rate of clearance from the circulation of certain molecules.
 - targeting of cells to certain tissues.
10. Glycoproteins:
- may contain 95% or more carbohydrate.
 - always contain a serially repeating carbohydrate unit.
 - are found only intracellularly.
 - from different animal species may have a different primary sequence in the protein but have identical carbohydrate chains.
 - have the carbohydrate linked to the protein by either *N*- or *O*-glycosidic bonds.
11. The carbohydrate core structure is assembled on dolichol phosphate before transfer to the protein for:
- N*-linked glycoproteins.
 - O*-linked glycoproteins.
 - proteoglycans.
 - glycosaminoglycans.
 - all of the above.
12. Fucose and sialic acid:
- are found most commonly in *N*-linked glycoproteins.
 - are the parts of the carbohydrate chain that are covalently linked to the protein.
 - can be found in the core structure of certain *O*-linked glycoproteins.
 - are transferred to a carbohydrate chain when it is attached to dolichol phosphate.
 - are the repeating unit of proteoglycans.
13. Glycosaminoglycans:
- are the carbohydrate portion of glycoproteins.
 - contain large segments of a repeating unit typically consisting of a hexosamine and a uronic acid.
 - are low molecular weight cations.
 - exist in only two forms.
 - are bound to protein by ionic interaction.

Refer to the following for Questions 14–16.

- chondroitin sulfate
 - dermatan sulfate
 - heparin
 - hyaluronate
 - keratan sulfate
14. Differs from other glycosaminoglycans in being predominantly intracellular rather than extracellular.
15. Only glycosaminoglycan not covalently linked to protein.
16. The most abundant glycosaminoglycan in the body.
17. All of the following are true of proteoglycans EXCEPT:
- specificity is determined, in part, by the action of glycosyltransferases.
 - synthesis is regulated, in part, by UDP-xylose inhibition of the conversion of UDP-glucose to UDP-glucuronic acid.
 - synthesis involves sulfation of carbohydrate residues by PAPS.
 - synthesis of core protein is balanced with synthesis of the polysaccharide moieties.
 - degradation is catalyzed in the cytosol by nonspecific glycosidases.

Answers

- B Although the glucose-6-phosphate dehydrogenase reaction, specific for NADP, is reversible, hydrolysis of the lactone assures that the overall equilibrium lies far in the direction of NADPH. A, C, and D: These all use NAD, not NADP. E: These enzymes are part of the pentose phosphate pathway but catalyze freely reversible reactions that do not involve NADP (pp. 337–338).
- A Both reactions catalyzed by transketolase are of this type. B and E describe transaldolase. C describes an isomerase. D: Transketolase is part of the reversible phase of the pentose phosphate pathway that also allows glycolytic intermediates to be converted to pentose sugars, if necessary (p. 338).
- D A, C, D, E: Glucose 6-phosphate yields ribose 5-phosphate + CO₂ in the oxidative phase. If this is multiplied by six, the six ribose 5-phosphates can be rearranged to five glucose 6-phosphates by the second, reversible phase. B: If more ribose 5-phosphate than NADPH were required, the flow would be in this direction to supply the needed pentoses (pp. 338–340).
- B The glucose and mannose phosphates are both in equilibrium with fructose 6-phosphate by phosphohexose isomerases. A: This occurs via an epimerase at the UDP-galactose level. C and D: This oxidation of glucose is catalyzed by UDP-glucose dehydrogenase and the product can be decarboxylated to UDP-xylose. E: Again, an epimerization occurs on the nucleotide intermediate (p. 342, Fig. 8.4).
- E A, C, E: Fructokinase produces fructose 1-phosphate. Since this cannot be converted to fructose 1,6-bisphosphate, a specific aldolase cleaves it to dihydroxyacetone phosphate and glyceraldehyde. The first product is a glycolytic intermediate; the second requires modification to enter glycolysis. D: Glucose and fructose are not epimers (p. 342, Clin. Corr. 8.2).
- A B: The epimerase is normal. C: Galactose is an important sugar for infants. E: Fructose metabolism does not use the uridylyltransferase that is deficient in galactosemia (p. 353, Clin. Corr. 8.3).
- C Humans do not make ascorbic acid. A: Enhancing water solubility is a major physiological role for glucuronic acid,

for example, bilirubin metabolism. B and D: Decarboxylation of UDP-glucuronic acid gives UDP-xylose, which is a potent inhibitor of the oxidation of UDP-glucose to the acid. E: The reduction of D-glucuronic acid to L-gulonic acid leads to ascorbate as well as xylulose 5-phosphate for the pentose phosphate pathway (p. 345, Figure 8.7).

8. D Glucosamine 6-phosphate is acetylated. UDP-*N*-acetylglucosamine is formed, and the UDP derivative can be epimerized to the galactose derivative. A and C: This conversion is a transamidation of the amide nitrogen of glutamine and does not involve nucleotide intermediates. B: This is a feedback inhibitor of the transamidase reaction, thus controlling formation of the nucleotide sugars. E: May account for 20% of the glucose flux in skin (p. 344).

9. B Synthesis of complex carbohydrates is not template directed but determined by the specificity of individual enzymes. A, C, D, and E: Because of the diversity possible with oligosaccharides, they play a significant role in determining the specificity of many biological molecules (pp. 345–347).

10. E A and B: This is true of proteoglycans. C: Some hormones in blood are glycoproteins. D: Heterogeneity of carbohydrates is common (pp. 348–350).

11. A This is characteristic of *N*-linked glycoproteins. B, C, and D: Synthesis of *O*-linked glycoproteins involves the sequential addition to the *N*-acetylgalactosamine linked to serine or threonine (p. 350).

12. C Core also contains galactose and *N*-acetylgalactosamine. A and D: Core structure of *N*-linked carbohydrates contains mannose and *N*-acetylglucosamine. B: Usually found at the periphery of the carbohydrate. E: Repeating unit is hexosamine and uronic acids (pp. 350 and 353).

13. B This is a major distinction from glycoproteins, which, by definition, do not have a serial repeating unit. A: These are carbohydrate of proteoglycans. C: They have anionic character contributed by carboxyl and sulfate (another common feature) groups. D: There are at least six different classes. E: Carbohydrates are bound by covalent links (p. 353).

14. C (p. 354).

15. D Classified as a glycosaminoglycan because of its structural similarity to the others (p. 353).

16. A (p. 354).

17. E Degradation is lysosomal; deficiencies of one or more lysosomal hydrolases lead to accumulation of proteoglycans in the mucopolysaccharidoses. A: Strict substrate specificity of the enzymes is important in determining the type and quantity of proteoglycans synthesized. Formation of specific protein acceptors for the carbohydrate is also important. B and D: Both xylose and glucuronic acid levels are controlled by this; xylose is the first sugar added in the synthesis of four of the six types and would accumulate if core protein synthesis is decreased. C: This is necessary for the formation of all proteoglycans (hyaluronic acid is not part of a proteoglycan) (p. 356).

**Chapter 9—
Lipid Metabolism I:
Utilization and Storage of Energy in Lipid Form**

J. Denis McGarry

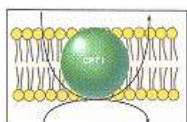

9.1 Overview	362
9.2 Chemical Nature of Fatty Acids and Acylglycerols	363
Fatty Acids Are Alkyl Chains Terminating in a Carboxyl Group	363
Nomenclature of Fatty Acids	364
Most Fatty Acids in Humans Occur As Triacylglycerols	364
The Hydrophobic Nature of Lipids Is Important for Their Biological Function	365
9.3 Sources of Fatty Acids	365
Most Fatty Acids Are Supplied in the Diet	365
Palmitate Is Synthesized from Acetyl CoA	366
Formation of Malonyl CoA Is the Commitment Step of Fatty Acid Synthesis	366
Reaction Sequence for Synthesis of Palmitic Acid	368
Mammalian Fatty Acid Synthase Is a Multifunctional Polypeptide	369
Stoichiometry of Fatty Acid Biosynthesis	369
Acetyl CoA Must Be Transported from Mitochondria to the Cytosol for Palmitate Synthesis	369
Palmitate Is the Precursor of Other Fatty Acids	371
Elongation Reactions	372
Formation of Monoenoic Acids by Stearoyl CoA Desaturase	372
Formation and Modification of Polyunsaturated Fatty Acids	372
Formation of Hydroxy Fatty Acids in Nerve Tissue	373
Fatty Acid Synthase Can Produce Fatty Acids Other Than Palmitate	374
Fatty Acyl CoAs May Be Reduced to Fatty Alcohols	374
9.4 Storage of Fatty Acids As Triacylglycerols	375
Triacylglycerols Are Synthesized from Fatty Acyl CoAs and Glycerol 3-Phosphate in Most Tissues	376
Mobilization of Triacylglycerols Requires Hydrolysis	376
9.5 Methods of Interorgan Transport of Fatty Acids and Their Primary Products	378
Lipid-Based Energy Is Transported in Blood in Different Forms	378
Plasma Lipoproteins Carry Triacylglycerols and Other Lipids	379
Fatty Acids Are Bound to Serum Albumin	379
Ketone Bodies Are a Lipid-Based Energy Supply	379
Lipases Must Hydrolyze Blood Triacylglycerols for Their Fatty Acids to Become Available to Tissues	380
9.6 Utilization of Fatty Acids for Energy Production	381
β -Oxidation of Straight-Chain Fatty Acids Is the Major Energy-Producing Process	381
Fatty Acids Are Activated by Conversion to Fatty Acyl CoA	381
Carnitine Carries Acyl Groups across the Mitochondrial Membrane	382
β -Oxidation Is a Sequence of Four Reactions	382
Energy-Yield from β -Oxidation of Fatty Acids	383
Comparison of the β -Oxidation Scheme with Palmitate Biosynthesis	383
Some Fatty Acids Require Modification of β -Oxidation for Metabolism	384
Propionyl CoA Is Produced by Oxidation of Odd-Chain Fatty Acids	384
Oxidation of Unsaturated Fatty Acids Requires Additional Enzymes	384
Some Fatty Acids Undergo ω -Oxidation	387
ω -Oxidation Gives Rise to a Dicarboxylic Acid	387
Ketone Bodies Are Formed from Acetyl CoA	387
HMG CoA Is an Intermediate in the Synthesis of Acetoacetate from Acetyl CoA	388
Acetoacetate Forms Both D- β -Hydroxybutyrate and Acetone	388

Utilization of Ketone Bodies by Nonhepatic Tissues Requires Formation of Acetoacetyl CoA	389
Starvation and Certain Pathological Conditions Lead to Ketosis	389
Peroxisomal Oxidation of Fatty Acids Serves Many Functions	390
Bibliography	391
Questions and Answers	391
Clinical Correlations	
9.1 Obesity	378
9.2 Leptin and Obesity	378
9.3 Genetic Abnormalities in Lipid-Energy Transport	380
9.4 Genetic Deficiencies in Carnitine Transport or Carnitine Palmitoyltransferase	384
9.5 Genetic Deficiencies in the Acyl-CoA Dehydrogenases	385
9.6 Refsum's Disease	387
9.7 Diabetic Ketoacidosis	390

9.1—

Overview

As the human body builds and renews its structures, obtains and stores energy, and performs its various functions, there are many circumstances in which it is essential to use molecules or parts of molecules that do not associate with water. This property of being **nonpolar** and **hydrophobic** is the defining characteristic of substances classed as **lipids**. Most of these are molecules that contain or are derived from **fatty acids**. In the early stages of biochemical research, lipids were not investigated as intensively as other body constituents, largely because techniques for studying aqueous systems were easier to develop. This benign neglect led to assumptions that lipids were relatively inert and their metabolism was of lesser importance than that of carbohydrates, for instance.

As the methodology for analyzing lipid metabolism developed, it became evident that fatty acids and their derivatives had at least two major roles in the body. On the one hand, oxidation of fatty acids was shown to be a major means of metabolic energy production. It also became clear that their storage in the form of **triacylglycerols** was more efficient and quantitatively more important than storage of carbohydrates as glycogen. On the other hand, as details of the chemistry of biological structures were defined, hydrophobic structures were found to be largely composed of fatty acids and their derivatives. Thus the major separation of cells and subcellular structures into separate aqueous compartments is accomplished with membranes whose hydrophobic characteristics are largely supplied by the fatty acid moieties of complex lipids. These latter compounds contain constituents other than fatty acids and glycerol. They frequently have significant covalently bound hydrophilic moieties, notably carbohydrates in the glycolipids and organic phosphate esters in phospholipids.

Lipids have several other quantitatively less important roles, which are nonetheless of great functional significance. These include the use of surface active properties of some complex lipids for specific functions, such as maintenance of lung alveolar integrity and solubilization of nonpolar substances in body fluids. In addition, several classes of lipids, for example, steroid hormones and prostaglandins, have highly potent and specific physiological roles in control of metabolic processes. The interrelationships of some processes involved in lipid metabolism are outlined in Figure 9.1. The metabolism of fatty acids and triacylglycerols is so crucial to proper functioning of the human body that imbalances and deficiencies in these processes can have serious pathological consequences. Disease states related to fatty acid and triacylglycerol metabolism include obesity, diabetes, ketoacidosis, and abnormalities in transport of lipids in blood. In addition, some unique deficiencies have been found, such as Refsum's disease and familial hypercholesterolemia, which have helped to elucidate some pathways in lipid metabolism.

This chapter is concerned primarily with the structure and metabolism of fatty acids and of their major storage form, triacylglycerols. After a discussion of the structures of the more important fatty acids found in humans, how they

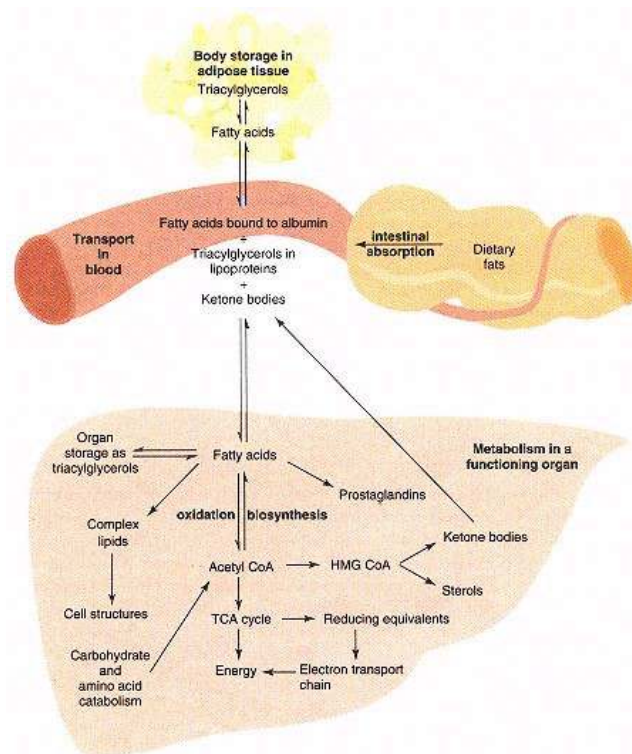

Figure 9.1
Metabolic interrelationships of fatty acids in the human.

are supplied from the diet or by biosynthesis is described. The mechanism for storage as triacylglycerols and how fatty acids are mobilized and transported throughout the body to sites where they are needed are discussed. The central process of energy production from fatty acids is then examined, and finally the mechanisms by which the ketone bodies are synthesized and used are presented.

The Appendix includes the nomenclature and chemistry of lipids and in Chapter 26 there is a discussion of digestion and absorption of lipids.

9.2—

Chemical Nature of Fatty Acids and Acylglycerols

Fatty Acids Are Alkyl Chains Terminating in a Carboxyl Group

Fatty acids consist of an **alkyl chain** with a terminal carboxyl group, the basic formula of completely saturated species being $\text{CH}_3-(\text{CH}_2)_n-\text{COOH}$. The important fatty acids for humans have relatively simple structures, although in some organisms they may be quite complex, containing cyclopropane rings or extensive branching. Unsaturation occurs commonly in human fatty acids, with up to six double bonds per chain, these being almost always of the *cis* configuration. If there is more than one double bond per molecule, they are always separated by a **methylene** ($-\text{CH}_2-$) **group**. The most common fatty acids

in biological systems have an even number of carbon atoms, although some organisms do synthesize those with an odd number of carbon atoms. Humans can use the latter for energy but incorporate them into complex lipids to a minimal degree.

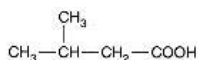

Figure 9.2
Isovaleric acid.

A few fatty acids with an α -OH group are produced and used structurally by humans. However, more oxidized forms are normally produced only as metabolic intermediates during energy production or for specific physiological activity in the case of prostaglandins and thromboxanes. Some animals, including humans, also produce relatively simple **branched-chain acids**, branching being limited to methyl groups along the chain at one or more positions. These are apparently produced to contribute specific physical properties to some secretions and structures. For instance, large amounts of branched-chain fatty acids, particularly isovaleric acid (Figure 9.2), occur in lipids of echo-locating structures in marine mammals. Elucidation of the role of these compounds in sound focusing should be fascinating.

Most fatty acids in humans have C16, C18, or C20 atoms, but there are several with longer chains that occur principally in lipids of the nervous system. These include nervonic acid and a C22 acid with six double bonds (Figure 9.3).

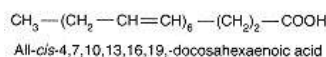
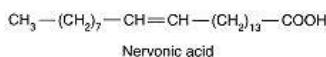

Figure 9.3
Long-chain fatty acids.

Nomenclature of Fatty Acids

The most abundant fatty acids have common names that have been accepted for use in the official nomenclature. Examples are given in Table 9.1 with official systematic names. The approved abbreviations consist of the number of carbon atoms followed, after a colon, by the number of double bonds. Carbon atoms are numbered with the carboxyl carbon as number 1, and double bond locations are designated by the number of the carbon atom on the carboxyl side of it. These designations of double bonds are in parentheses after the rest of the symbol.

Most Fatty Acids in Humans Occur As Triacylglycerols

Fatty acids occur primarily as esters of glycerol, as shown in Figure 9.4, when they are stored for future use. Compounds with one (**monoacylglycerols**) or two (**diacylglycerols**) acids esterified are present only in relatively minor amounts and occur largely as metabolic intermediates in biosynthesis and degradation of glycerol-containing lipids. Most fatty acids in humans exist as **triacylglycerols**, in which all three hydroxyl groups on glycerol are esterified with a fatty acid. These compounds have been called "neutral fats or triglycerides." There are other types of "neutral fats" in the body, and the terms "triglyceride," "monoglyceride," and "diglyceride" are chemically incorrect and should not be used.

The distribution of different fatty acids in the three positions of the glycerol moiety of triacylglycerols in the body at any given time is influenced by many

TABLE 9.1 Fatty Acids of Importance to Humans

Numerical Symbol	Structure	Trivial Name	Systematic Name
16: 0	$\text{CH}_3-(\text{CH}_2)_{14}-\text{COOH}$	Palmitic	Hexadecanoic
16: 1(9)	$\text{CH}_3-(\text{CH}_2)_5-\text{CH}=\text{CH}-(\text{CH}_2)_7-\text{COOH}$	Palmitoleic	<i>cis</i> -9-Hexadecenoic
18: 0	$\text{CH}_3-(\text{CH}_2)_{16}-\text{COOH}$	Stearic	Octadecanoic
18: 1(9)	$\text{CH}_3-(\text{CH}_2)_7-\text{CH}=\text{CH}-(\text{CH}_2)_7-\text{COOH}$	Oleic	<i>cis</i> -9-Octadecenoic
18: 2(9,12)	$\text{CH}_3-(\text{CH}_2)_3-(\text{CH}_2-\text{CH}=\text{CH})_2-(\text{CH}_2)_7-\text{COOH}$	Linoleic	<i>cis,cis</i> -9,12-Octadecadienoic
18: 3(9,12,15)	$\text{CH}_3-(\text{CH}_2-\text{CH}=\text{CH})_3-(\text{CH}_2)_7-\text{COOH}$	Linolenic	<i>cis,cis,cis</i> -9,12,15-Octadecatrienoic
20: 4(5,8,11,14)	$\text{CH}_3-(\text{CH}_2)_3-(\text{CH}_2-\text{CH}=\text{CH})_4-(\text{CH}_2)_3-\text{COOH}$	Arachidonic	<i>cis,cis,cis,cis</i> -5,8,11,14-Eicosatetraenoic

factors, including diet and anatomical location of the triacylglycerol. Compounds with the same fatty acid in all three positions of glycerol are rare; the usual case is for a complex mixture.

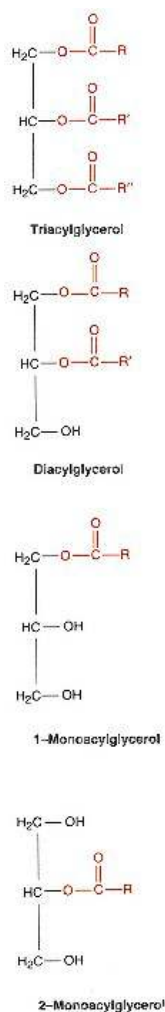

Figure 9.4
Acylglycerols.

The Hydrophobic Nature of Lipids Is Important for Their Biological Function

One significant property of fatty acids and triacylglycerols is their lack of affinity for water. Long hydrocarbon chains have negligible possibility for hydrogen bonding. Acids, whether unesterified or in a complex lipid, have a much greater tendency to associate with each other or other hydrophobic structures, such as sterols and hydrophobic side chains of amino acids, than they do with water or polar organic compounds. This hydrophobic character is essential for construction of complex biological structures such as membranes.

The **hydrophobic nature** of triacylglycerols and their highly reduced state make them efficient compounds in comparison to glycogen for storing energy. Three points deserve emphasis. First, on a weight basis pure triacylglycerols yield near two and one-half times the amount of ATP on complete oxidation than does pure glycogen. Second, triacylglycerols can be stored without associated water, whereas glycogen is very hydrophilic and binds about twice its weight of water when stored in tissues. Thus the equivalent amount of metabolically recoverable energy stored as hydrated glycogen would weigh about four times as much as if it were stored as triacylglycerols. Third, the average 70-kg person stores about 350 g of carbohydrate as liver and muscle glycogen. This represents about 1400 kcal of available energy, barely enough to sustain bodily functions for 24 hours of fasting. By contrast, a normal complement of fat stores will provide sufficient energy to allow several weeks of survival during total food deprivation.

In humans most of the fatty acids are either saturated or contain only one double bond. Although they are readily catabolized by appropriate enzymes and cofactors, they are fairly inert chemically. The highly unsaturated fatty acids in tissues are much more susceptible to oxidation.

9.3— Sources of Fatty Acids

Both diet and biosynthesis supply the fatty acids needed by the human body for energy and for construction of hydrophobic parts of biomolecules. Excess amounts of protein and carbohydrate in the diet are readily converted to fatty acids and stored as triacylglycerols.

Most Fatty Acids Are Supplied in the Diet

Various animal and vegetable lipids are ingested, hydrolyzed at least partially by digestive enzymes, and absorbed through the intestinal mucosa to be distributed through the body, first in the lymphatic system and then in the bloodstream. These processes are discussed in Chapter 25. To a large extent dietary supply governs the composition of fatty acids in body lipids. Metabolic processes in various tissues modify both dietary and *de novo* synthesized fatty acids to produce nearly all the required structures. With one exception, the actual composition of fatty acids supplied in the diet is relatively unimportant. This exception involves the need for appropriate proportions of relatively highly unsaturated fatty acids because many higher mammals, including humans, are unable to synthesize fatty acids with double bonds near the methyl end of the molecule. Certain **polyunsaturated acids** with double bonds within the last seven linkages toward the methyl end are essential for specific functions. Although all

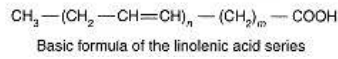
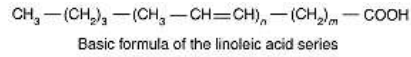

Figure 9.5
Linoleic and linolenic acid series.

the reasons for this need are not yet explained, one is that some of these acids are precursors of prostaglandins, very active oxidation products (see p. 431).

In humans a dietary precursor is essential for two series of fatty acids. These are the linoleic series and the linolenic series (Figure 9.5).

Palmitate Is Synthesized from Acetyl CoA

The second major source of fatty acids for humans is their biosynthesis from small-molecule intermediates derived from metabolic breakdown of sugars, some amino acids, and other fatty acids. In a majority of instances the saturated, straight-chain C16 acid, **palmitic acid**, is first synthesized, and all other fatty acids are made by modification of palmitic acid. Acetyl CoA is the direct source of all carbon atoms for this synthesis. Fatty acids are synthesized by sequential addition of two-carbon units to the activated carboxyl end of a growing chain. In mammalian systems the sequence of reactions is carried out by **fatty acid synthase**.

Fatty acid synthase is a fascinating enzyme complex that is still studied intensely. In bacteria it is a complex of several proteins, whereas in mammalian cells it is a single multifunctional protein. Either acetyl CoA or butyryl CoA is the priming unit for fatty acid synthesis, and the methyl end of these primers becomes the methyl end of palmitate. Addition of the rest of the two-carbon units requires activation of the methyl carbon of acetyl CoA by carboxylation to malonyl CoA. However, CO₂ added in this process is lost when condensation of malonyl CoA to the growing chain occurs, so carbon atoms in the palmitate chain originate only from acetyl CoA.

Formation of Malonyl CoA Is the Commitment Step of Fatty Acid Synthesis

The reaction that commits acetyl CoA to fatty acid synthesis is its carboxylation to **malonyl CoA** by the enzyme **acetyl-CoA carboxylase** (Figure 9.6). This reaction is similar in many ways to carboxylation of pyruvate, which starts the process of gluconeogenesis. The reaction requires ATP and HCO₃⁻ as the source of CO₂. As with pyruvate carboxylase, the first step is formation of activated CO₂ on the biotin moiety of acetyl-CoA carboxylase using energy from ATP. This is then transferred to acetyl CoA.

Acetyl-CoA carboxylase, a key control point in the overall synthesis of fatty acids, can be isolated in a protomeric state that is inactive. The protomers aggregate to form enzymatically active polymers upon addition of citrate *in*

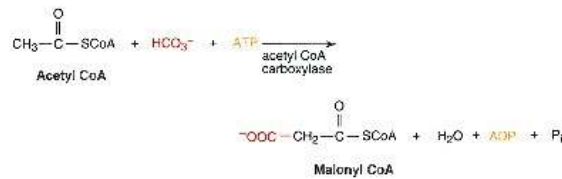

Figure 9.6
Acetyl-CoA carboxylase reaction.

vitro. Pamitoyl CoA *in vitro* inhibits the active enzyme. The action of these two effectors is very logical. Increased synthesis of fatty acids to store energy is desirable when citrate is in high concentration, and decreased synthesis is necessary if high levels of product accumulate. However, the degree to which these regulatory mechanisms actually operate *in vivo* is still unclear.

Acetyl-CoA carboxylase is also controlled by a cAMP-mediated phosphorylation–dephosphorylation mechanism in which the phosphorylated enzyme is less active than the dephosphorylated one. There is evidence suggesting that phosphorylation is promoted by glucagon (via cAMP) as well as by AMP (via an AMP-activated kinase) and that the active form is fostered by insulin. These effects of hormone-mediated phosphorylation are separate from the allosteric effects of citrate and palmitoyl CoA (see Table 9.2).

TABLE 9.2 Regulation of Fatty Acid Synthesis

<i>Enzyme</i>	<i>Regulatory Agent</i>		<i>Effect</i>
<i>Palmitate Biosynthesis</i>			
Acetyl-CoA carboxylase	Short term	{ Citrate C16–C18 acyl CoAs Insulin Glucagon cAMP-mediated phosphorylation Dephosphorylation	Allosteric activation
			Allosteric inhibition
			Stimulation
			Inhibition
			Inhibition
			Stimulation
	Long term	{ High-carbohydrate diet Fat-free diet High-fat diet Fasting Glucagon	Stimulation by increased enzyme synthesis
			Stimulation by increased enzyme synthesis
			Inhibition by decreased enzyme synthesis
			Inhibition by decreased enzyme synthesis
			Inhibition by decreased enzyme synthesis
Fatty acid synthase			Allosteric activation
			Stimulation by increased enzyme synthesis
			Stimulation by increased enzyme synthesis
			Inhibition by decreased enzyme synthesis
			Inhibition by decreased enzyme synthesis
<i>Biosynthesis of Fatty Acids Other than Palmitate</i>			
Fatty acid synthase		High ratio of methylmalonyl CoA/malonyl CoA Thioesterase cofactor	Increased synthesis of methylated fatty acids
			Termination of synthesis with short-chain product
Stearyl CoA desaturase		Various hormones Dietary polyunsaturated fatty acids	Stimulation of unsaturated fatty acid synthesis by increased enzyme synthesis
			Decreased activity

The rate of synthesis of acetyl-CoA carboxylase is also regulated. More enzyme is produced by animals on high-carbohydrate or fat-free diets, whereas on fasting or high-fat diets the rate of enzyme synthesis is decreased.

Reaction Sequence for Synthesis of Palmitic Acid

The first step catalyzed by fatty acid synthase in bacteria is transacylation of the primer molecule, either acetyl CoA or butyryl CoA, to a 4-phosphopantetheine moiety on a protein constituent of the enzyme complex. This protein is **acyl carrier protein (ACP)**, and its phosphopantetheine unit is identical with that in CoA. The mammalian enzyme also contains a phosphopantetheine. Six or seven two-carbon units are then added sequentially to the enzyme complex until the palmitate molecule is completed. After each addition of a two-carbon unit a series of reductive steps takes place. The reaction sequence starting with an acetyl CoA primer and leading to butyryl-ACP is as presented in Figure 9.7.

The next round of synthesis is initiated by transfer of the newly formed fatty acid chain from 4-phosphopantetheine moiety of ACP to a functional –SH group of **β -ketoacyl-ACP synthase** (analogous to Reaction 3a). This liberates the –SH group of ACP for acceptance of a second malonyl unit from

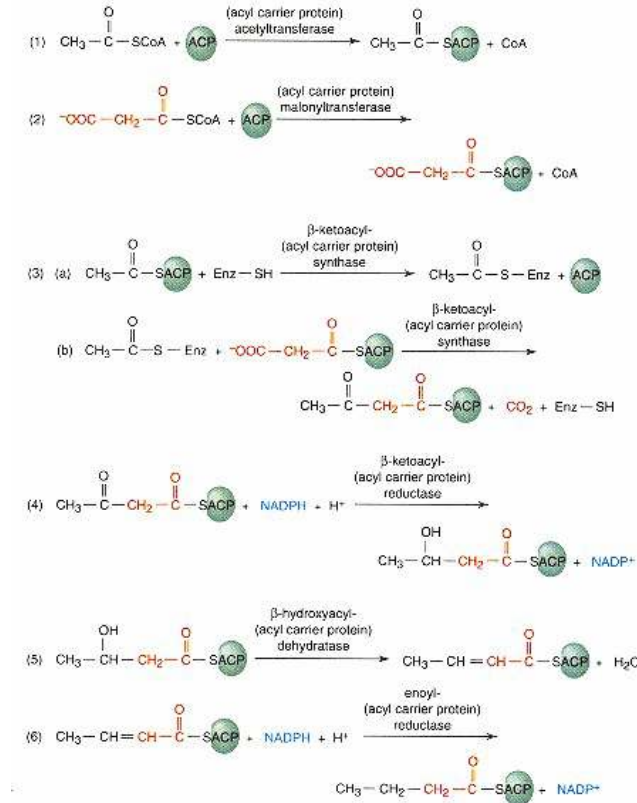

Figure 9.7
Reactions catalyzed by fatty acid synthase.

malonyl CoA (Reaction 2) and allows Reactions 3b to 6 to generate hexanoyl-ACP. The process is repeated five more times at which point palmitoyl-ACP is acted on by a **thioesterase** with production of free palmitic acid (Figure 9.8). Note that at this stage the sulfhydryl groups of ACP and β -ketoacyl-ACP synthase are both free so that another cycle of fatty acid synthesis can begin.

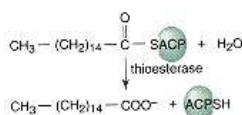

Figure 9.8
Release of palmitic acid from fatty acid synthase.

Mammalian Fatty Acid Synthase Is a Multifunctional Polypeptide

The reaction sequence given above is the basic pattern for fatty acid biosynthesis in living systems. The details of the reaction mechanisms are still unclear and may vary between species. The enzyme complex termed fatty acid synthase catalyzes all these reactions, but its structure and properties vary considerably. The individual enzymes in *Escherichia coli* are dissociable. By contrast, **mammalian synthase** is composed of two possibly identical subunits, each of which is a multienzyme polypeptide containing all of the necessary catalytic activities in a linear array. Even between mammalian species and tissues there are variations.

It appears that the growing fatty acid chain is continually bound to the multifunctional protein and is sequentially transferred between the 4'-phospho-pantetheine group of ACP, a domain on the protein, and the sulfhydryl group of a cysteine residue on β -ketoacyl-ACP synthase during the condensation reaction (Reaction 3, Figure 9.7) (see also Figure 9.9). An intermediate acylation to a serine residue probably takes place when acyl CoA units add to enzyme-bound ACP in the transacylase reactions.

Regulation of palmitate biosynthesis probably occurs primarily by controlling the rate of synthesis and degradation of the enzyme. The agents and conditions that do this are given in Table 9.2. They are logical in terms of balancing an efficient utilization of the various biological energy substrates.

Stoichiometry of Fatty Acid Biosynthesis

If acetyl CoA is the primer for palmitate biosynthesis, the overall reaction is

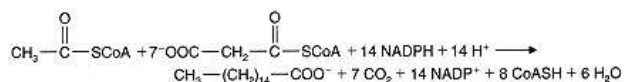

To calculate the energy needed for the overall conversion of acetyl CoA to palmitate, we must add the ATP used in formation of malonyl CoA:

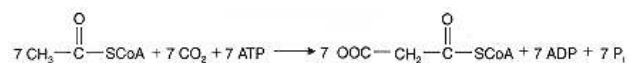

Then the stoichiometry for conversion of acetyl CoA to palmitate is

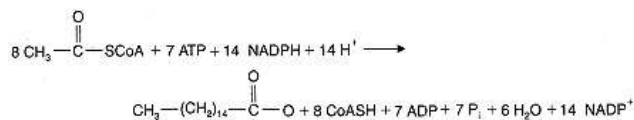

Acetyl CoA Must Be Transported from Mitochondria to the Cytosol for Palmitate Synthesis

Fatty acid synthase and acetyl-CoA carboxylase are found primarily in the cytosol where biosynthesis of palmitate occurs. Mammalian tissues must use special processes to ensure an adequate supply of acetyl CoA and NADPH for this synthesis in the cytosol. The major source of acetyl CoA is the pyruvate dehydro-

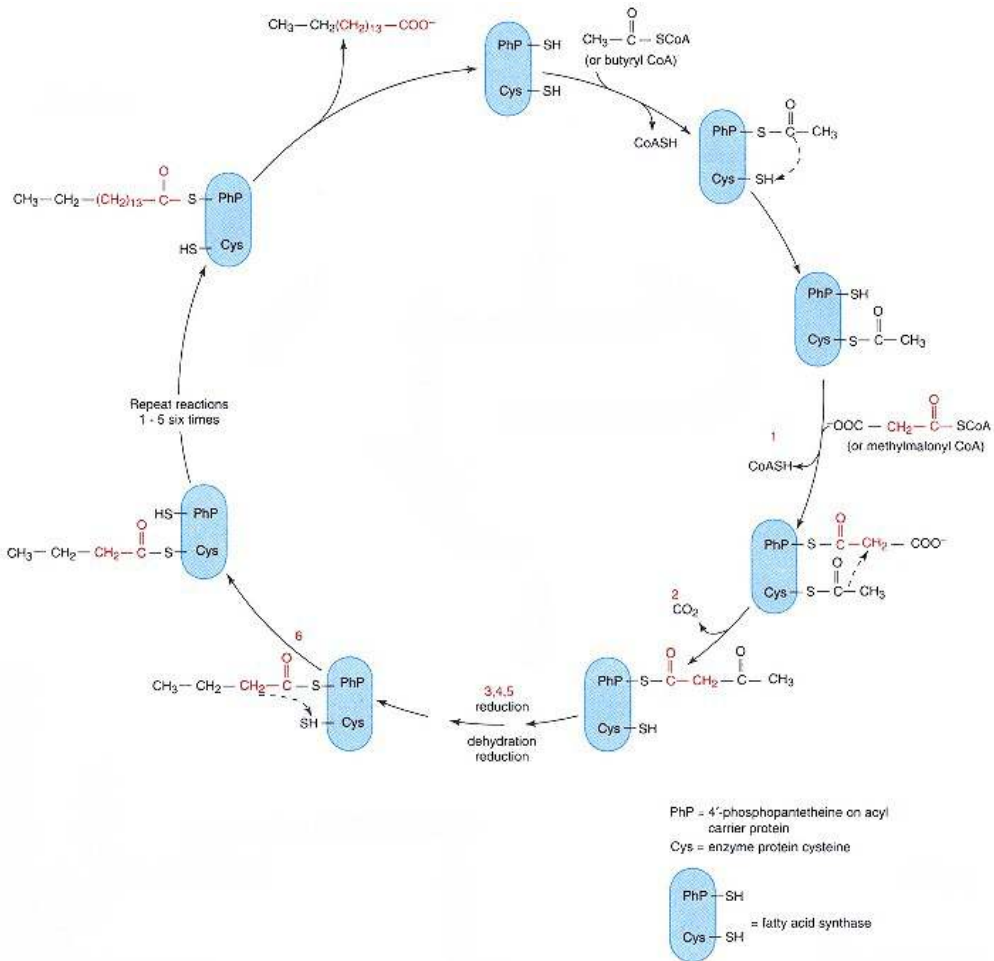

Figure 9.9
Proposed mechanism of elongation reactions taking place on mammalian fatty acid synthase.

genase reaction in the matrix of mitochondria. Since the mitochondrial inner membrane is not readily permeable to acetyl CoA, a process involving citrate moves the C2 unit to the cytosol for palmitate biosynthesis. This mechanism (Figure 9.10) takes advantage of the facts that citrate exchanges freely from mitochondria to cytosol (see p. 243) and that an enzyme exists in cytosol to convert citrate to acetyl CoA and oxaloacetate. When there is an excess of citrate from the TCA cycle, this intermediate will pass into the cytosol and supply acetyl CoA for fatty acid biosynthesis. The cleavage reaction, which is

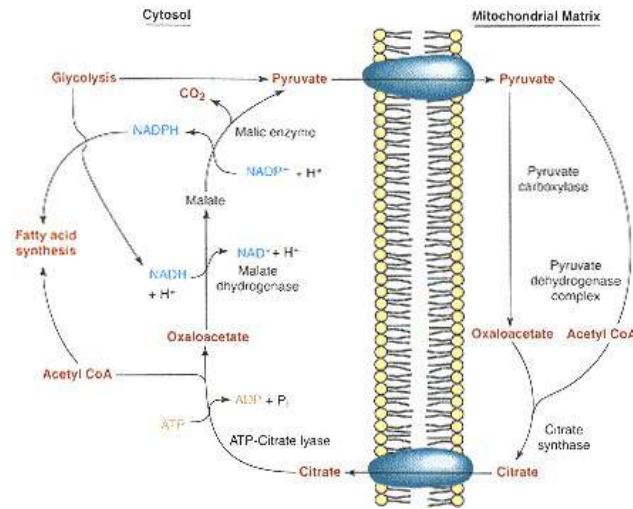

Figure 9.10
Mechanism for transfer of acetyl CoA from mitochondria to cytosol for fatty acid biosynthesis.

energy requiring, is catalyzed by **ATP-citrate lyase**:



This mechanism has other advantages because CO_2 and NADPH for synthesis of palmitate can be produced from excess cytosolic oxaloacetate. As shown in Figure 9.10, NADH reduces oxaloacetate to malate via **malate dehydrogenase**, and malate is then decarboxylated by **NADP-linked malic enzyme** (malate: NADP⁺ oxidoreductase-decarboxylating) to produce NADPH, pyruvate, and CO_2 . Thus NADPH is produced from NADH generated in glycolysis. The cycle is completed by return of pyruvate to the mitochondrion where it can be carboxylated to regenerate oxaloacetate, as described in the process of gluconeogenesis (see p. 299).

In summary, 1 NADH is converted to NADPH for each acetyl CoA transferred from mitochondria to cytosol, each transfer requiring 1 ATP. The transfer of the 8 acetyl CoA used for each molecule of palmitate supplies 8 NADPH. Since palmitate biosynthesis requires 14 NADPH mol⁻¹, the other 6 NADPH must be supplied by the cytosolic pentose phosphate pathway. This stoichiometry is, of course, hypothetical. The *in vivo* relationships are complicated because transport of citrate and other di- and tricarboxylic acids across the inner mitochondrial membrane occurs by one-for-one exchanges. The actual flow rates are probably controlled by a composite of the concentration gradients of several of these exchange systems.

Palmitate Is the Precursor of Other Fatty Acids

Humans can synthesize all of the fatty acids they need from palmitate except the essential, polyunsaturated fatty acids (see p. 365). These syntheses involve a variety of enzyme systems in a number of locations. Palmitate produced by fatty acid synthase is modified by three processes: elongation, desaturation, and hydroxylation.

Elongation Reactions

In mammals **elongation of fatty acids** occurs in either the endoplasmic reticulum or mitochondria; the processes are slightly different in these two loci. In the endoplasmic reticulum the sequence of reactions is similar to that occurring in the cytosolic fatty acid synthase with malonyl CoA as the source of two-carbon units and NADPH providing the reducing power. The preferred substrate for elongation is palmitoyl CoA. In contrast to palmitate synthesis, intermediates in subsequent reactions are CoA esters rather than attached to a protein, suggesting that the process is carried out by separate enzymes rather than a complex like fatty acid synthase. In most tissues this elongation system in the endoplasmic reticulum converts palmitate to stearate almost exclusively. Brain, however, contains one or more additional elongation systems, which synthesize longer chain acids (up to C24) needed for brain lipids. These other systems also use malonyl CoA as substrate.

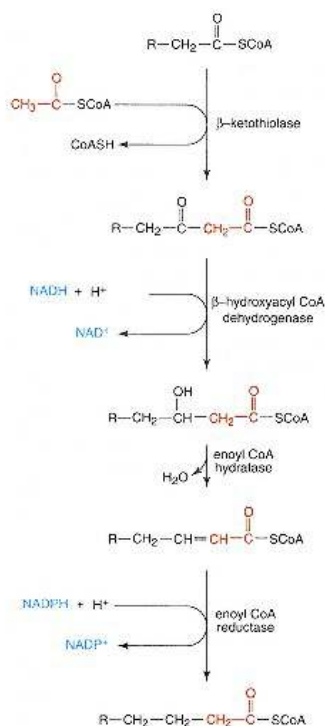
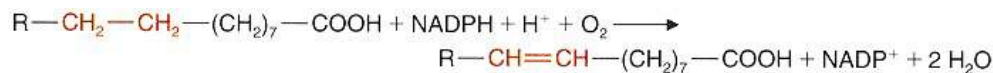

Figure 9.11
Mitochondrial elongation of fatty acids.

The elongation system in mitochondria differs in that acetyl CoA is the source of the added two-carbon units and both NADH and NADPH serve as reducing agents (Figure 9.11). This system operates by reversal of the pathway of fatty acid β -oxidation (see Section 9.6) with the exception that NADPH-linked enoyl-CoA reductase (last step of elongation) replaces FAD-linked acyl-CoA dehydrogenase (first step in β -oxidation). The process has little activity with acyl CoA substrates of C16 atoms or longer, suggesting that it serves primarily in elongation of shorter chain species.

Formation of Monoenoic Acids by Stearoyl CoA Desaturase

In higher animals **desaturation of fatty acids** occurs in the endoplasmic reticulum, and the oxidizing system used to introduce cis double bonds is significantly different from the main fatty acid oxidation process in mitochondria. The systems in endoplasmic reticulum have sometimes been termed "**mixed function oxidases**" because the enzymes simultaneously oxidize two substrates. In fatty acid desaturation one of these substrates is NADPH and the other is the fatty acid. Electrons from NADPH are transferred through a specific flavoprotein reductase and a cytochrome to "active" oxygen so that it will then oxidize the fatty acid. Although the complete mechanism has not been determined, this latter step may involve a hydroxylation. The three components of the system are the **desaturase enzyme**, **cytochrome b_5** , and **NADPH-cytochrome b_5 reductase**. The overall reaction is



The enzyme specificity is such that the R group must contain at least six carbon atoms.

The regulatory mechanisms that govern the conversion of palmitate to unsaturated fatty acids are largely unexplored. An important consideration is the control of the proportions of unsaturated fatty acids for proper maintenance of the physical state of stored triacylglycerols and membrane phospholipids. A committed step in the formation of unsaturated fatty acids from palmitate or stearate is introduction of the first double bond between C-9 and C-10 atoms by **stearoyl CoA desaturase** to produce palmitoleic or oleic acid, respectively. The activity of this enzyme and its synthesis are controlled by both dietary and hormonal mechanisms. Increasing the amounts of polyunsaturated fatty acids in the diet of experimental animals decreases the activity of stearoyl CoA desaturase in liver, and insulin, triiodothyronine, and hydrocortisone cause its induction.

Formation and Modification of Polyunsaturated Fatty Acids

A variety of **polyunsaturated fatty acids** are synthesized by humans through a combination of elongation and desaturation reactions. Once the initial double

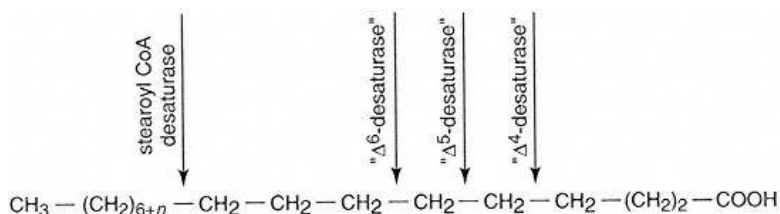
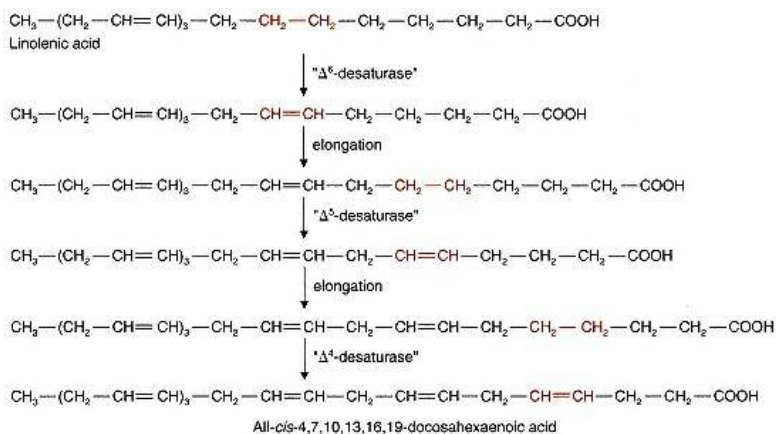

Figure 9.12
Positions in the fatty acid chain where desaturation can occur in the human.

There must always be at least six single bonds in the chain toward the methyl end of the molecule just beyond the bond being desaturated.

bond has been placed between carbons 9 and 10 by stearyl CoA desaturase, additional double bonds can be introduced just beyond C-4, C-5, or C-6 atoms. Desaturation at C-8 probably occurs also in some tissues. The positions of these desaturations are shown in Figure 9.12. The relative specificities of the various enzymes are still to be determined completely, but it seems likely that elongation and desaturation can occur in either order. Conversion of linolenic acid to all *cis*-4, 7, 10, 13, 16, 19-docosahexaenoic acid in brain is a specific example of such a sequence.



Polyunsaturated fatty acids, particularly arachidonic acid, are precursors of the highly active prostaglandins and thromboxanes. Different classes of prostaglandins are formed depending on the precursor fatty acid and the sequence of oxidations that convert the acids to active compounds. A detailed discussion of these substances and their formation is found in Chapter 10. Polyunsaturated fatty acids in living systems have a significant potential for auto-oxidation, a process that may have important physiological and/or pathological consequences. Auto-oxidation reactions cause rancidity in fats and curing of linseed oil in paints.

Formation of Hydroxy Fatty Acids in Nerve Tissue

There are apparently two different processes that produce α -hydroxy fatty acids in higher animals. One occurs in the mitochondria of many tissues and acts on relatively short-chain fatty acids (see Section 9.6). The other has been demonstrated only in tissues of the nervous system where it produces long-chain fatty acids with a hydroxyl group on C-2. These are needed for the formation of some myelin lipids. The specific case of α -hydroxylation of lignoceric acid to cerebronic acid has been studied. These enzymes preferentially use C22 and C24 fatty acids and show characteristics of the "mixed function oxidase" systems, requiring molecular oxygen and NADH or NADPH. This

synthesis may be closely coordinated with biosynthesis of sphingolipids that contain hydroxylated fatty acids.

Fatty Acid Synthase Can Produce Fatty Acids Other than Palmitate

The schemes outlined, which synthesize and modify palmitate, account for the great bulk of fatty acid biosynthesis in the human body, particularly that involved in energy storage. There are, however, many special instances where smaller amounts of different fatty acids are needed for specific structural or functional purposes. These acids are produced by modification of the process carried out by fatty acid synthase. Two examples are production of fatty acids shorter than palmitate in mammary glands and synthesis of branched-chain fatty acids in certain secretory glands.

Milk produced by many animals contains varying amounts of fatty acids with shorter chain lengths than palmitate. The amounts produced by **mammary gland** apparently vary with species and especially with the physiological state of the animal. This is probably true of humans, although most investigations have been carried out with rats, rabbits, and various ruminants. The same fatty acid synthase that produces palmitate synthesizes shorter chain acids when the linkage of the growing chain with acyl carrier protein is split before the full C16 chain is completed. This hydrolysis is caused by soluble **thioesterases** whose activity is under hormonal control.

There are relatively few branched-chain fatty acids in higher animals. Until recently, their metabolism has been studied mostly in primitive species such as mycobacteria, where they are present in greater variety and amount. Simple branched-chain fatty acids are synthesized by tissues of higher animals for specific purposes, such as the production of waxes in sebaceous glands and avian preen glands and the elaboration of structures in echo-locating systems of porpoises.

The majority of branched-chain fatty acids in higher animals are synthesized by fatty acid synthase and are methylated derivatives of saturated, straight-chain acids. When **methylmalonyl CoA** is used as a substrate instead of malonyl CoA, a methyl side chain is inserted in the fatty acid, and the reaction is as follows:

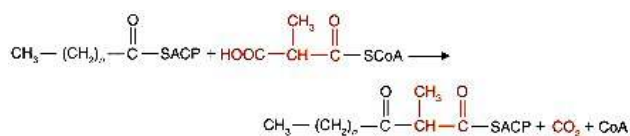

Regular reduction steps then follow. Apparently these reactions occur in many tissues normally at a rate several orders of magnitude lower than the utilization of malonyl CoA to produce palmitate. The proportion of branched-chain fatty acids synthesized is largely governed by the relative availability of the two precursors. An increase in branching can occur by decreasing the ratio of malonyl CoA to methylmalonyl CoA. A malonyl-CoA decarboxylase capable of causing this decrease occurs in many tissues. It has also been suggested that increased levels of methylmalonyl CoA in pathological situations, such as vitamin B₁₂ deficiency, can lead to excessive production of branched-chain fatty acids.

Fatty Acyl CoAs May Be Reduced to Fatty Alcohols

As discussed in Chapter 10, many phospholipids contain fatty acid chains in ether linkage rather than ester linkage. The biosynthetic precursors of these

ether-linked chains are **fatty alcohols** (Figure 9.13) rather than fatty acids. These alcohols are formed in higher animals by a two-step, NADPH-linked reduction of fatty acyl CoAs in the endoplasmic reticulum. In organs that produce relatively large amounts of ether-containing lipids, the concurrent production of fatty acids and fatty alcohols is probably closely coordinated.

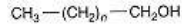

Figure 9.13
Fatty alcohol.

9.4—
Storage of Fatty Acids As Triacylglycerols

Most tissues in the body can convert fatty acids to triacylglycerols (Figure 9.14) by a common sequence of reactions, but liver and adipose tissue carry out this process to the greatest extent. Adipose tissue is a specialized connective tissue designed for synthesis, storage, and hydrolysis of triacylglycerols. This is the main system for long-term energy storage in humans. We are concerned here with white adipose tissue as opposed to brown adipose tissue, which occurs in much lesser amounts and has other specialized functions. Triacylglycerols are stored as liquid droplets in the cytoplasm, but this is not "dead storage" since they turn over with an average half-life of only a few days. Thus, in a homeostatic situation, there is continuous synthesis and breakdown of triacylglycerols in adipose tissue. Some storage also occurs in skeletal and cardiac muscle, but only for local consumption.

Triacylglycerol synthesis in liver is used primarily for production of blood lipoproteins, although the products can serve as energy sources for other liver

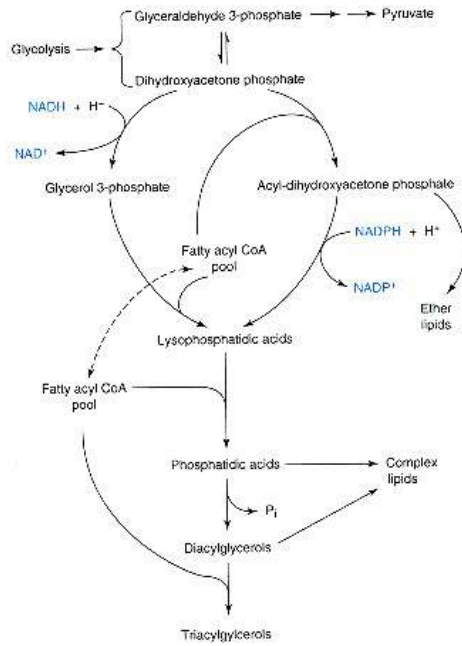

Figure 9.14
Alternative pathways for biosynthesis of triacylglycerols from dihydroxyacetone phosphate.

functions. Required fatty acids may come from the diet, from adipose tissue via blood transport, or from *de novo* biosynthesis. Acetyl CoA for biosynthesis is derived principally from glucose catabolism.

Triacylglycerols Are Synthesized from Fatty Acyl CoAs and Glycerol 3-Phosphate in Most Tissues

Triacylglycerols are synthesized in most tissues from activated fatty acids and a phosphorylated three-carbon product of glucose catabolism (see Figure 9.14), which can be either **glycerol 3-phosphate** or **dihydroxyacetone phosphate**. Glycerol 3-phosphate is formed either by reduction of dihydroxyacetone phosphate produced in glycolysis or by phosphorylation of glycerol. White adipose tissue contains little or no glycerol kinase, so it derives glycerol phosphate from glycolytic intermediates. Fatty acids are activated by conversion to their CoA esters in the following reaction:



This two-step reaction has an acyl adenylate as intermediate and is driven by hydrolysis of pyrophosphate to P_i .

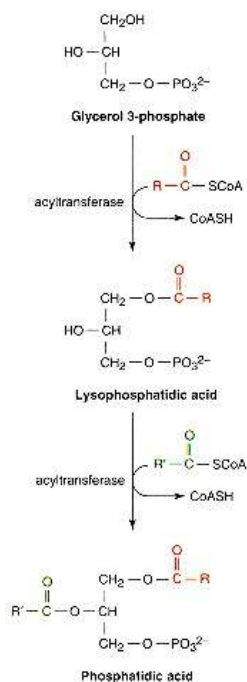

Figure 9.15
Synthesis of phosphatidic acid from glycerol 3-phosphate.

Synthesis of triacylglycerols from phosphorylated three-carbon fragments involves formation of **phosphatidic acid**, which is a key intermediate in synthesis of other lipids as well (see Chapter 10). This may be formed by two sequential acylations of glycerol 3-phosphate, as shown in Figure 9.15. Alternatively, dihydroxyacetone phosphate may be acylated directly at C-1 followed by reduction at C-2. The resultant lysophosphatidic acid can then be further esterified, as illustrated in Figure 9.16. If phosphatidic acid from either of these routes is used for synthesis of triacylglycerol, the phosphate group is next hydrolyzed by **phosphatidate phosphatase** to yield diacylglycerol, which is then acylated to triacylglycerol (Figure 9.17).

There is at least one tissue, **intestinal mucosa**, in which the synthesis of triacylglycerols does not require formation of phosphatidic acid as described above. A major product of intestinal digestion of lipids is 2-monoacylglycerols, which are absorbed as such into mucosa cells. An enzyme in these cells catalyzes acylation of these monoacylglycerols with acyl CoA to form 1,2-diacylglycerols, which then can be further acylated as shown above.

The specificity of the acylation reactions in all these steps is still quite controversial. Analysis of **fatty acid patterns** in triacylglycerols from various human tissues shows that the distribution of different acids on the three positions of glycerol is neither random nor absolutely specific. The patterns in different tissues show some characteristic tendencies. Palmitic acid tends to be concentrated in position 1 and oleic acid in positions 2 and 3 of human adipose tissue triacylglycerols. Two main factors that determine localization of a particular fatty acid to a given position on glycerol are the specificity of acyltransferase involved and relative availability of different fatty acids in the fatty acyl CoA pool. Other factors are probably involved but their relative importance has not been determined.

Mobilization of Triacylglycerols Requires Hydrolysis

The first step in recovering stored fatty acids for energy production is hydrolysis of triacylglycerols. A variety of lipases catalyze this reaction, the sequence of hydrolysis from the three positions on glycerol depending on the specificities of the particular lipases involved.

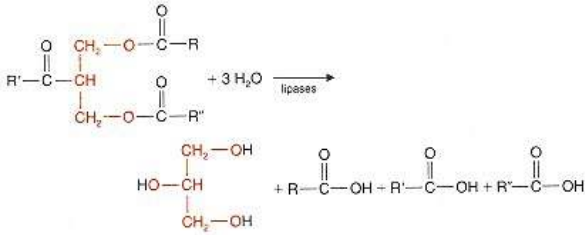

Lipases in adipose tissue are, of course, key enzymes for release of the major energy stores. The lipase that removes the first fatty acid is a controlled enzyme, which is sensitive to a variety of circulating hormones. This control of triacylglycerol hydrolysis must be balanced with the process of triacylglycerol synthesis to assure adequate energy stores and avoid obesity (see Clin. Corr. 9.1 and 9.2). Fatty acids and glycerol produced by adipose tissue lipases are released to circulating blood, where fatty acids are bound by serum albumin and transported to tissues for use. Glycerol returns to liver, where it is converted to dihydroxyacetone phosphate and enters glycolytic or gluconeogenic pathways.

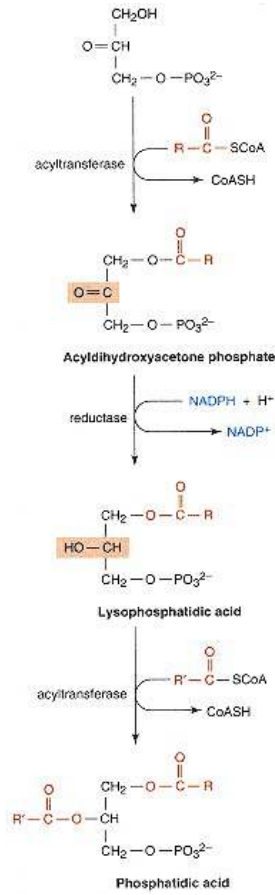

Figure 9.16
Synthesis of phosphatidic acid from dihydroxyacetone phosphate.

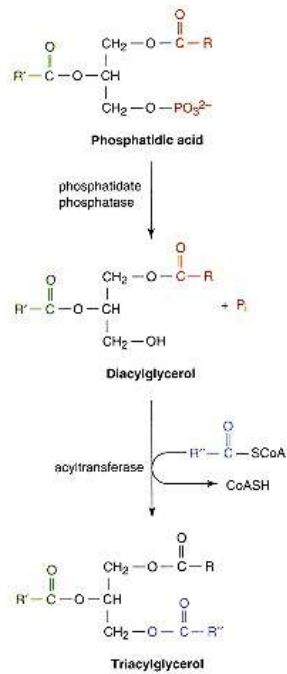

Figure 9.17
Synthesis of triacylglycerol from phosphatidic acid.

CLINICAL CORRELATION 9.1**Obesity**

The terms obesity and overweight refer to excess in body weight relative to height. Their definitions are arbitrary and are based on actuarial estimates of ideal body weight (IBW), that is, body weight associated with the lowest morbidity and mortality. Relative weight is body weight relative to IBW: overweight is defined as relative weight up to 20% above normal and obesity is relative weight over 20% above IBW. The body mass index (BMI) is well correlated with measures of body fat and is defined as weight (kg) divided by height² (m²). Overweight is defined as a BMI of 25–30 kg per m², and obesity as a BMI > 30 kg per m². Skinfold thickness also is a measure of body fat stores.

The cause of most cases of obesity is not known. Endocrine diseases such as hypothyroidism or Cushing's disease (overproduction of corticosteroids) are rare causes. Genetic factors interact with environmental factors: 80% of children of two obese parents will be obese, while only 14% of children of normal weight parents are obese. The major mechanism of weight gain is consumption of calories in excess of daily energy requirements, but the normal processes controlling food intake are not very well understood. Rarely, tumors of the hypothalamus result in pathological overeating (hyperphagia). However, a specific defect in most cases of human obesity has not been demonstrated.

The treatment of obesity revolves about dietary restriction, increased physical activity, and behavior modification. The real problem is to modify the patients' eating patterns long term, and even in those who lose weight, regain of the weight is very common. Currently, no pharmacological agents are effective in promoting long-term weight control. Surgery to limit the size of the gastric reservoir can be considered for patients over 100% above IBW. Medical complications of obesity include a two- to threefold increase in hypertension, gallstones, and diabetes, and fivefold increase in risk of endometrial carcinoma. Obese patients have decreased plasma antithrombin III levels, which predisposes them to venous thrombosis (see Clin. Corr. 8.8).

Bray, G. A. Complications of obesity. *Ann. Intern. Med.* 103:1052, 1985; and Bray, G. A. The syndromes of obesity: an endocrine approach. In: L. J. DeGroot (Ed.), *Endocrinology*, Vol. 3, 3rd ed. Philadelphia: Saunders, 1995, p. 2624.

9.5—**Methods of Interorgan Transport of Fatty Acids and Their Primary Products*****Lipid-Based Energy Is Transported in Blood in Different Forms***

The energy available in fatty acids needs to be distributed throughout the body from the site of fatty acid absorption, biosynthesis, or storage to functioning tissues that consume them. This transport is closely integrated with that of other lipids, especially cholesterol, and is intimately involved in pathological processes leading to atherosclerosis. Various mechanisms are being intensively studied, but many important questions are still unanswered.

In humans, three types of substances are used as vehicles to transport lipid-based energy: (1) chylomicrons and other plasma lipoproteins in which

CLINICAL CORRELATION 9.2**Leptin and Obesity**

In 1994 the *OB* gene of mice, its protein product, and their human homologues were identified. The human gene encodes a polypeptide of 166 amino acids that is expressed in adipose tissue in proportion to the severity of the obesity. The secreted protein, called leptin, contains 146 amino acids, can be measured by immunoassay, and is highly homologous to the murine protein.

Mice of the *ob/ob* strain that inherit a nonsense mutation in the leptin gene, leading to a truncated protein of 104 amino acids that is not secreted, are obese, diabetic, and exhibit reduced activity, metabolism, and body temperature. Injection of recombinant leptin into mice homozygous for this mutation lowered their food intake, body weight, percentage of body fat, and serum glucose and insulin concentrations, and increased their metabolic rate, body temperature, and activity level.

There is no difference in the structure of leptin between lean and obese human subjects. This suggests that the problem in obese individuals might be decreased sensitivity to leptin. Interestingly, a leptin receptor present in the hypothalamus has been shown to be defective in the *db/db* mouse and the *fa/fa* Zucker rat. In both cases the phenotype is similar to that of the *ob/ob* mouse. Whether an analogous situation applies in human obesity remains to be established.

Considine, R. V., Sinha, M. K., Heiman, M. L., et al. Serum immunoreactive-leptin concentrations in normal-weight and obese humans. *N. Engl. J. Med.* 334:292, 1996; and Lee, G. H., Proenca, R., Montez, J. M., et al. Abnormal splicing of the leptin receptor in diabetic mice. *Nature* 379:632, 1996.

triacylglycerols are carried in protein-coated lipid droplets, both of which contain other lipids; (2) fatty acids bound to serum albumin; and (3) so-called ketone bodies, acetoacetate and β -hydroxybutyrate. These three vehicles are used in varying proportions to carry energy in the bloodstream via three routes. One is transport of dietary fatty acids as chylomicrons throughout the body from the intestine after absorption. Another is transport of lipid-based energy processed by or synthesized in liver and distributed either to adipose tissue for storage or to other tissues for use; this includes "ketone bodies" and plasma lipoproteins other than chylomicrons. Finally, there is transport of energy released from storage in adipose tissue to the rest of the body in the form of fatty acids that are bound to serum albumin.

The proportion of energy being transported in any one of the modes outlined above varies considerably with metabolic and physiological state. At any time, the largest amount of lipid in blood is in the form of triacylglycerols in various lipoproteins. Fatty acids bound to albumin, however, are utilized and replaced very rapidly so total energy transport for a given period by this mode may be very significant.

Plasma Lipoproteins Carry Triacylglycerols and Other Lipids

Plasma lipoproteins are synthesized in both intestine and liver and are a heterogeneous group of lipid-protein complexes composed of various types of lipids and apoproteins (see p. 56 for a detailed discussion of structure). The two most important vehicles for delivery of lipid-based energy are **chylomicrons** and **very low density lipoprotein (VLDL)**, because they contain relatively large amounts of triacylglycerols. Chylomicrons are formed in the intestine and function in absorption and transport of dietary triacylglycerol, cholesterol, and fat-soluble vitamins. The exact precursor-product relationships between the other types of plasma lipoproteins have yet to be completely defined, as do the roles of various protein components. Liver synthesizes VLDL and fatty acids from triacylglycerols in VLDL are taken up by adipose tissue and other tissues. In the process VLDLs are converted to **low density lipoproteins (LDLs)**. The role of **high density lipoprotein (HDL)** in transport of lipid-based energy is yet to be clarified. All of these lipoproteins are integrally involved in transport of other lipids, especially cholesterol. Lipid components can interchange to some extent between different classes of lipoprotein, and some apoproteins probably have functional roles in modifying enzyme activity during exchange of lipids between plasma lipoproteins and tissues. Other apoproteins serve as specific recognition sites for cell surface receptors. Such interaction constitutes the first step in receptor-mediated endocytosis of certain lipoproteins. Studies of rare genetic abnormalities have been helpful in explaining the roles of some of these apoproteins (see Clin. Corr. 9.3).

Fatty Acids Are Bound to Serum Albumin

Serum albumin acts as a carrier for a number of substances in blood, some of the most important being fatty acids. These acids are water insoluble in themselves, but when they are released into plasma during triacylglycerol hydrolysis they are quickly bound to albumin. This protein has a number of binding sites for fatty acid, some of them having very high affinity. At any one time the number of sites on albumin actually occupied with fatty acids is far from maximal, but the turnover of these fatty acids is high, so binding by this mechanism constitutes a major route of energy transfer.

Ketone Bodies Are a Lipid-Based Energy Supply

The third mode of transport of lipid-based energy-yielding molecules is in the form of small water-soluble molecules, **acetoacetate** and **β -hydroxybutyrate** (Figure 9.18), produced primarily by liver during oxidation of fatty acids. The reactions involved in their formation and utilization will be discussed later.

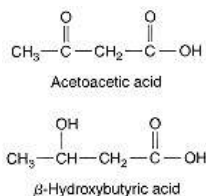

Figure 9.18
Structures of ketone bodies.

CLINICAL CORRELATION 9.3

Genetic Abnormalities in Lipid-Energy Transport

Diseases that affect the transport of lipid-based energy frequently result in abnormally high plasma triacylglycerols, cholesterol, or both. They are classified as hyperlipidemias. Some of them are genetically transmitted, and presumably they result from the alteration or lack of one or more proteins involved in the production or processing of plasma lipids. The nature and function of all of these proteins are yet to be determined, so the elucidation of exact causes of the pathology in most of these diseases is still in the early stages. However, in several cases a specific protein abnormality has been associated with altered lipid transport in the patient's plasma.

In the extremely rare disease, analbuminemia, there is an almost complete lack of serum albumin. In a rat strain with analbuminemia, a 7 base-pair deletion in an intron of the albumin gene results in the inability to process the nuclear mRNA for albumin. Despite the many functions of this protein, the symptoms of the disease are surprisingly mild. Lack of serum albumin effectively eliminates the transport of fatty acids unless they are esterified in acylglycerols or complex lipids. However, since patients with analbuminemia do have elevated plasma triacylglycerol levels, presumably the deficiency in lipid-based energy transport caused by the absence of albumin to carry fatty acids is filled by increased use of plasma lipoproteins to carry triacylglycerols.

A more serious genetic defect is the absence of lipoprotein lipase. The major problem here is the inability to process chylomicrons after a fatty meal. Pathological fat deposits occur in the skin (eruptive xanthomas) and the patients typically suffer from pancreatitis. If patients are put on a low-fat diet they respond reasonably well.

Another rare but more severe disease, abetalipoproteinemia, is caused by defective synthesis of apoprotein B, an essential component in the formation of chylomicrons and VLDL. Under these circumstances the major pathway for transporting lipid-based energy from the diet to the body is unavailable. Chylomicrons, VLDL, and LDL are absent from the plasma and fat absorption is deficient or nonexistent. There are other serious symptoms, including neuropathy and red cell deformities, whose etiology is less clear.

Havel, R. J., and Kane, J. P. Structure and metabolism of plasma lipoproteins. In: C. R. Scriver, A. L. Beaudet, W. S. Sly, and D. Valle (Eds.), *The Metabolic and Molecular Bases of Inherited Disease*, Vol. II, 7th ed. New York: McGraw-Hill, 1995, p. 1841; and Brunzell, J. D. Familial lipoprotein lipase deficiency and other causes of the chylomicronemia syndrome. In: C. R. Scriver, A. L. Beaudet, W. S. Sly, and D. Valle (Eds.), *The Metabolic and Molecular Bases of Inherited Disease*, Vol. II, 7th ed. New York: McGraw-Hill, 1995, p. 1913.

Under certain conditions, these substances can reach excessive concentrations in blood, leading to ketosis and acidosis. Spontaneous decarboxylation of acetoacetate to **acetone** also occurs, which is detectable as the smell of acetone in the breath when acetoacetate concentrations are high. This led early investigators to call the group of soluble products "**ketone bodies.**" In fact, β -hydroxybutyrate and acetoacetate are continually produced by liver and, to a lesser extent, by kidney. Skeletal and cardiac muscle utilize them to produce ATP. Nervous tissue, which normally obtains almost all of its energy from glucose, is unable to take up and use fatty acids bound to albumin for energy production. However, it can use ketone bodies when glucose supplies are insufficient.

Lipases Must Hydrolyze Blood Triacylglycerols for Their Fatty Acids to Become Available to Tissues

Fatty acids bound to albumin and ketone bodies are readily taken up by various tissues for oxidation and production of ATP. The energy in fatty acids stored or circulated as triacylglycerols, however, is not directly available, but rather triacylglycerols must be enzymatically hydrolyzed to release the fatty acids and glycerol. Two types of lipases are involved: (1) **lipoprotein lipase**, which hydrolyzes triacylglycerols in plasma lipoproteins; and (2) "**hormone-sensitive triacylglycerol lipase,**" which initiates hydrolysis of triacylglycerols in adipose tissue and release of fatty acids and glycerol into plasma.

Lipoprotein lipase is located on the surface of endothelial cells of capillaries and possibly of adjoining tissue cells. It hydrolyzes fatty acids from the 1 and/ or 3 position of tri- and diacylglycerols present in VLDL or chylomicrons. One of the lipoprotein apoproteins (ApoC-II) must be present to activate the process. Fatty acids released are either bound to serum albumin or taken up by the tissue. Monoacylglycerol products may either pass into the cells or be further hydrolyzed by serum **monoacylglycerol hydrolase.**

A completely distinct type of lipase controls mobilization of fatty acids from triacylglycerols stored in adipose tissue. One of them is hormonally controlled

TABLE 9.3 Regulation of Triacylglycerol Metabolism

<i>Enzyme</i>	<i>Regulatory Agent</i>	<i>Effect</i>
	<i>Triacylglycerol Mobilization</i>	
"Hormone-sensitive" lipase	"Lipolytic hormones," e.g., epinephrine, glucagon, and ACTH	Stimulation by cAMP-mediated phosphorylation of relatively inactive enzyme
	Insulin	Inhibition
	Prostaglandins	Inhibition
Lipoprotein lipase	Apolipoprotein C-II	Activation
	Insulin	Activation
	<i>Triacylglycerol Biosynthesis</i>	
Phosphatidate phosphatase	Steroid hormones	Stimulation by increased enzyme synthesis

by a cAMP-mediated mechanism. There are a number of lipase activities in the tissue, but the enzyme attacking triacylglycerols initiates the process. Two other lipases then rapidly complete the hydrolysis of mono- and diacylglycerols, releasing fatty acids to plasma where they are bound to serum albumin. Triacylglycerol metabolism is tightly controlled by both hormones and required cofactors. Some of the key regulatory factors are presented in Table 9.3.

9.6—

Utilization of Fatty Acids for Energy Production

Fatty acids that arrive at the surface of cells are taken up and used for energy production primarily in mitochondria in a process intimately integrated with energy generation from other sources. Energy-rich intermediates produced from fatty acids are the same as those obtained from sugars, that is, NADH and FADH₂. The final stages of the oxidation process are exactly the same as for carbohydrates, that is, the metabolism of acetyl CoA by the TCA cycle and production of ATP in the mitochondrial electron transport system.

The degree of utilization of fatty acids for energy production varies considerably from tissue to tissue and depends to a significant extent on the metabolic status of the body, whether it is fed or fasted, exercising or at rest, and so on. For instance, nervous tissue oxidizes fatty acids to a minimal degree, if at all, but cardiac and skeletal muscle depend heavily on fatty acids as a major energy source. During prolonged fasting most tissues can use fatty acids or ketone bodies for their energy requirements.

β-Oxidation of Straight-Chain Fatty Acids Is the Major Energy-Producing Process

For the most part, fatty acids are oxidized by a mechanism that is similar to, but not identical with, a reversal of the process of palmitate synthesis. That is, two-carbon fragments are removed sequentially from the carboxyl end of the acid after steps of **dehydrogenation**, **hydration**, and **oxidation** to form a *β*-keto acid, which is split by **thiolysis**. These processes take place while the acid is activated in a thioester linkage to the 4'-phosphopantetheine of CoA.

Fatty Acids Are Activated by Conversion to Fatty Acyl CoA

The first step in oxidation of a fatty acid is its activation to a fatty acyl CoA. This is the same reaction described for synthesis of triacylglycerols in Section 9.4 and occurs in the endoplasmic reticulum or the outer mitochondrial membrane.

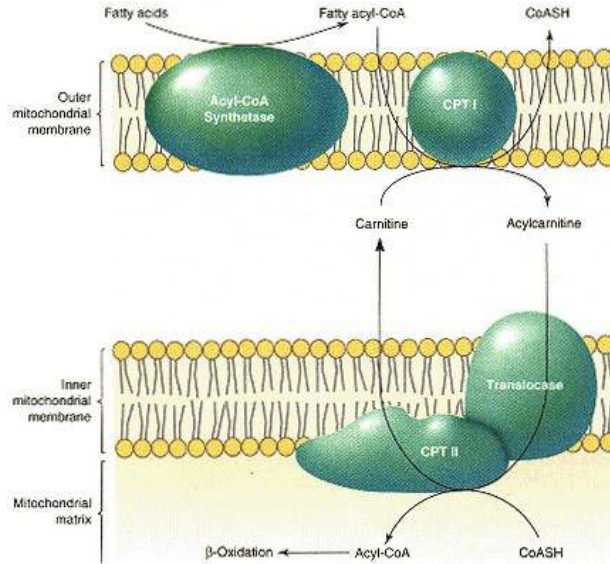
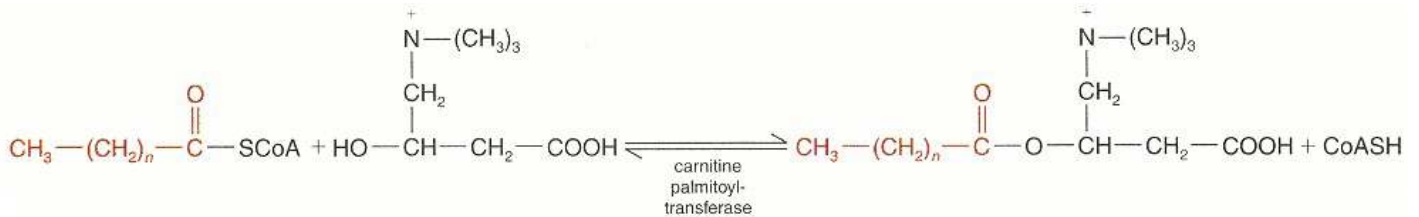

Figure 9.19
Mechanism for transfer of fatty acids from the cytosol through the inner mitochondrial membrane for oxidation.

Carnitine Carries Acyl Groups across the Mitochondrial Membrane

Whereas most fatty acyl CoAs are formed outside mitochondria, the oxidizing machinery is inside the inner membrane, which is impermeable to CoA and its derivatives. The cell overcomes this problem by using **carnitine (4-trimethylamino-3-hydroxybutyrate)** as the carrier of acyl groups across the membrane. The steps involved are outlined in Figure 9.19. Enzymes on both sides of the membrane transfer fatty acyl groups between CoA and carnitine.



On the outer mitochondrial membrane the acyl group is transferred to carnitine catalyzed by **carnitine palmitoyltransferase I (CPT I)**. Acyl carnitine then exchanges across the inner mitochondrial membrane with free carnitine by a carnitine–acylcarnitine antiporter translocase. Finally, the fatty acyl group is transferred back to CoA by **carnitine palmitoyltransferase II (CPT II)** located on the matrix side of the inner membrane. This process functions primarily in mitochondrial transport of fatty acyl CoAs with chain lengths of C12–C18. Genetic abnormalities in the system lead to serious pathology (see Clin. Corr. 9.4). By contrast, entry of shorter chain fatty acids is independent of carnitine because they cross the inner mitochondrial membrane directly and become activated to their CoA derivatives in the matrix compartment.

β-Oxidation Is a Sequence of Four Reactions

The four reactions of β-oxidation are presented in Figure 9.20. Once the fatty acyl groups have been transferred back to CoA at the inner surface of the inner

mitochondrial membrane, they can be oxidized (see Reaction 1) by a group of **acyl-CoA dehydrogenases**. Dehydrogenases are present on the inner membrane and remove hydrogen atoms to form enoyl CoA with a trans double bond between C-2 and C-3 atoms. There are several different dehydrogenases with different specificities for chain length of the acyl CoA. All are flavoproteins (see Clin. Corr. 9.5). As in the TCA cycle, enzyme-bound FADH₂ transfers electrons through several other electron-transferring flavoproteins to ubiquinone in the electron transport system, yielding two ATPs for each double bond formed.

The second step in β -oxidation is hydration of the trans double bond to a **3-L-hydroxyacyl CoA**. This reaction is stereospecific, in that the L isomer is the product when the trans double bond is hydrated. The stereospecificity of the oxidative pathway is governed by the enzyme catalyzing the third reaction, which is specific for the L isomer as its substrate. The final step is the cleavage of the two-carbon fragment by a thiolase, which, like the preceding two enzymes, has relatively broad specificity with regard to chain length of the acyl group being oxidized. In the overall process then, an acetyl CoA is produced and the acyl CoA product is ready for the next round of oxidation starting with acyl-CoA dehydrogenase.

It has been impossible to show conclusively that any of the enzymes in the β -oxidation scheme are control points, although under rather rigid *in vitro* conditions some apparently have slower maximum rates of reaction than others. It is assumed that control is exerted by availability of substrates and cofactors and by the rate of processing of acetyl CoA by the TCA cycle. One way in which substrate availability is controlled is by regulation of the carnitine shuttle mechanism that transports fatty acids into mitochondria, a phenomenon of central importance in the regulation of hepatic ketone body production (see p. 387).

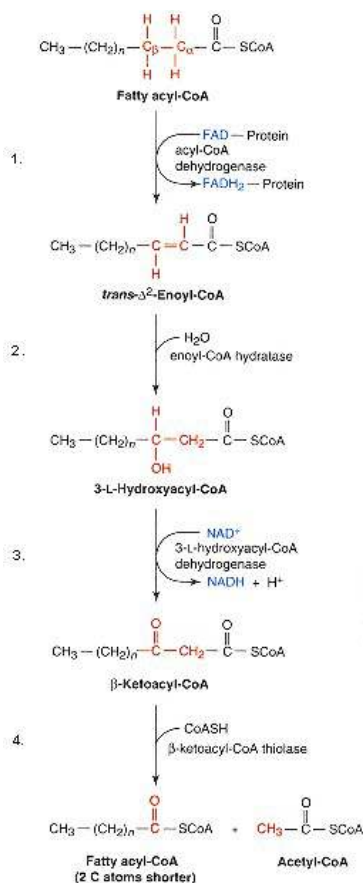

Figure 9.20
Pathway of fatty acid β -oxidation.

Energy-Yield from β -Oxidation of Fatty Acids

Each set of oxidations resulting in production of a two-carbon fragment yields, in addition to acetyl CoA, one reduced flavoprotein and one NADH. In the oxidation of palmitoyl CoA, seven such cleavages take place, and in the last cleavage two acetyl CoA molecules are formed. Thus the products of β -oxidation of palmitate are eight acetyl CoAs, seven reduced flavoproteins, and seven NADH. Each of the reduced nucleotides yield 35 ATP per palmitoyl CoA. As described in Chapter 6, oxidation of each acetyl CoA through the TCA cycle yields 12 ATP, so the eight two-carbon fragments from a palmitate molecule produce 96 ATP. However, 2 ATP equivalents (1 ATP going to 1 AMP) were used to activate palmitate to palmitoyl CoA. Therefore each palmitic acid entering the cell from the action of lipoprotein lipase or from its combination with serum albumin can yield 129 ATP mol⁻¹ by complete oxidation. The significance of the role of fatty acids in supplying the energy needs in humans is discussed on page 536.

Comparison of the β -Oxidation Scheme with Palmitate Biosynthesis

In living metabolic systems the reactions in a catabolic pathway are sometimes quite similar to those in a reversal of the corresponding anabolic sequence, but there are usually mechanisms that provide for separate control of the two schemes. This is true in the case of fatty acid biosynthesis and β -oxidation. The critical differences between the two pathways are outlined in Table 9.4. They include separation by subcellular compartmentation (β -oxidation occurs in the mitochondria and palmitate biosynthesis in the cytosol) and use of different cofactors (NADPH in biosynthesis, FAD and NAD⁺ in oxidation).

CLINICAL CORRELATION 9.4

Genetic Deficiencies in Carnitine Transport or Carnitine Palmitoyltransferase

A number of diseases result from genetic abnormalities in the transport of long-chain fatty acids across the inner mitochondrial membrane. They stem from deficiencies either in the level of carnitine or in the functioning of the carnitine palmitoyltransferase (CPT) enzyme system.

The clinical symptoms of carnitine deficiency range from mild, recurrent muscle cramping to severe weakness and death. Two categories of the disorder, primary and secondary, are now recognized. Primary carnitine deficiency is caused by a defect in the high-affinity plasma membrane carnitine transporter in tissues such as muscle, kidney, heart, and fibroblasts (but apparently not in liver where a different transporter is operative). It results in extremely low levels of carnitine in affected tissues and also in plasma (because of failure to the kidneys to reabsorb carnitine). The very low carnitine level in heart and skeletal muscle seriously compromises long-chain fatty acid oxidation. Dietary carnitine therapy, by raising the plasma concentration of carnitine and forcing its entry into tissues in a nonspecific manner, is frequently beneficial. Secondary carnitine deficiency is often associated with inherited defects in the β -oxidation pathway that give rise to the accumulation of acyl CoAs and, in turn, acylcarnitines. The latter compounds can be excreted in the urine (see Clin. Corr. 9.5), thus draining the body's carnitine pool; in addition, they are thought to impair the tissue uptake of free carnitine.

CPT deficiency also presents as distinct clinical entities. The most common deficiency results from mutations in the CPT II gene that give rise to a partial loss of enzyme activity. The patient generally experiences muscle weakness during prolonged exercise when muscle relies heavily on fatty acids as an energy source. Myoglobinuria, due to breakdown of muscle tissue, is a frequent accompaniment. The disorder is usually referred to as the "muscular" form of CPT II deficiency. Mutations causing more severe (90% or greater) loss of CPT II activity can have serious consequences in early infancy. These are usually precipitated by periods of fasting and include hypoketotic hypoglycemia, hyperammonemia, cardiac malfunction, and sometimes death. Similar morbidity and mortality are associated with mutations in the gene for liver CPT I. To date only a few patients with hepatic CPT I deficiency have been reported, the small number possibly indicating that the disease is frequently lethal and has gone undiagnosed. Muscle CPT I is now known to be a different isoform from its liver counterpart, but no defects at this locus have yet been reported.

The first patient with carnitine–acylcarnitine translocase deficiency was described as recently as 1992. Clinical features included intermittent hypoglycemic coma, hyperammonemia, muscle weakness, and cardiomyopathy. The condition proved fatal at age 3 years. Three additional cases with similar symptomatology have since been reported.

The hallmark of treatment for all inherited disorders of the carnitine transport/CPT system is avoidance of starvation and a diet low in long-chain fatty acids. Supplementary dietary medium-chain triacylglycerols, the fatty acids of which are oxidized by a carnitine-independent mechanism, have proved beneficial.

Stanley, C. A., Hale, D. E., Berry, G. T., Deleeno, S., Boxer, J., and Bonnefont, J.-P. A deficiency of carnitine–acylcarnitine translocase in the inner mitochondrial membrane. *N. Engl. J. Med.* 327:19, 1992; and Roe, C R., and Coates, P. M. Mitochondrial fatty acid oxidation disorders. In: C. R. Scriver, A. L. Beaudet, W. S. Sly, and D. Valle (Eds.), *The Metabolic and Molecular Bases of Inherited Disease*, Vol. II, 7th ed. New York: McGraw-Hill, 1995, p. 1501.

Some Fatty Acids Require Modification of β -Oxidation for Metabolism

The β -oxidation scheme accounts for the bulk of energy production from fatty acids in the human. These reactions, however, must be supplemented by other mechanisms so that ingested odd-chain and unsaturated fatty acids can be oxidized. In addition, reactions catalyze α - and ω -oxidation of fatty acids. **α -Oxidation** occurs at C-2 instead of C-3, as in the β -oxidation scheme. **ω -Oxidation** occurs at the methyl end of the fatty acid molecule. Partial oxidation of fatty acids with cyclopropane ring structures probably occurs in humans, but the mechanisms are not worked out.

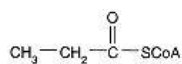

Figure 9.21
Propionyl CoA.

Propionyl CoA Is Produced by Oxidation of Odd-Chain Fatty Acids

Oxidation of fatty acids with an odd number of carbon atoms proceeds exactly as described above, but the final product is a molecule of propionyl CoA (Figure 9.21). For this compound to be further oxidized, it undergoes carboxylation to methylmalonyl CoA, molecular rearrangement, and conversion to succinyl CoA. These reactions are identical with those described on page 479 for the metabolism of **propionyl CoA** formed in the metabolic breakdown of some amino acids.

Oxidation of Unsaturated Fatty Acids Requires Additional Enzymes

Many unsaturated fatty acids in the diet are available for production of energy by humans. Structures encountered in these dietary acids may differ from those

CLINICAL CORRELATION 9.5**Genetic Deficiencies in the Acyl-CoA Dehydrogenases**

The acyl-CoA dehydrogenase deficiencies represent a recently discovered group of inherited defects that impair the β -oxidation of fatty acids at different stages of the chain shortening process. The affected enzyme may be the long-chain acyl-CoA dehydrogenase (LCAD), the medium-chain acyl-CoA dehydrogenase (MCAD), or the short-chain acyl-CoA dehydrogenase (SCAD), whose substrate specificities are for acyl CoA chains of greater than C12, C6–C12, and C4–C6, respectively. The three conditions are inherited in autosomal recessive fashion and share many of the same clinical features. The best characterized is MCAD deficiency, which, though first recognized as late as 1982, is now thought to be one of the most common of all inborn errors of metabolism.

Medium-chain acyl-CoA dehydrogenase deficiency usually manifests itself within the first 2 years of life after a fasting period of 12 h or more. Typical symptoms include vomiting, lethargy, and frequently coma, accompanied by hypoketotic hypoglycemia and dicarboxylic aciduria. The absence of starvation ketosis is accounted for by the block in hepatic fatty acid oxidation, which also causes a slowdown of gluconeogenesis. This, coupled with impaired fatty acid oxidation in muscle, which promotes glucose utilization, leads to profound hypoglycemia. Accumulation of medium-chain acyl CoAs in tissues forces their metabolism through alternative pathways including ω -oxidation and transesterification to glycine or carnitine. Excessive urinary excretion of the reaction products (medium-chain dicarboxylic acids together with medium-chain esters of glycine and carnitine) provide diagnostic clues.

Most patients with this disorder do well simply by avoiding prolonged periods of starvation, which is consistent with the fact that the metabolic complications of MCAD deficiency are seen only when body tissues become heavily dependent on fatty acids as a source of energy (e.g., with carbohydrate deprivation). In retrospect, it now seems likely that many cases previously diagnosed loosely as "Reye-like syndrome" or "sudden infant death syndrome" were in fact due to MCAD deficiency.

Coates, P. M., and Tanaka, K. Molecular basis of mitochondrial fatty acid oxidation defects. *J. Lipid Res.* 33:1099, 1992.

required by the specificity of enzymes in β -oxidation pathway. Oxidation of linoleoyl CoA, outlined in Figure 9.22, illustrates two special reactions required for oxidation of unsaturated fatty acids.

One problem is that in β -oxidation of unsaturated fatty acids the sequential excision of C2 fragments can generate an acyl CoA intermediate with a double bond between C-3 and C-4 atoms instead of between C-2 and C-3 atoms as

TABLE 9.4 Comparison of Schemes for Biosynthesis and β -Oxidation of Palmitate

<i>Parameter</i>	<i>Biosynthesis</i>	<i>β-Oxidation</i>
Subcellular localization	Primarily cytosolic	Primarily mitochondrial
Phosphopantetheine-containing active carrier	Acyl carrier protein	Coenzyme A
Nature of small carbon fragment added or removed	C-1 and C-2 atoms of malonyl CoA after initial priming	Acetyl CoA
Nature of oxidation–reduction coenzyme	NADPH	FAD when saturated chain dehydrogenated, NAD ⁺ when hydroxy acid dehydrogenated
Stereochemical configuration of β -hydroxy intermediates	D- β -Hydroxy	L -Hydroxy
Energy equivalents yielded or utilized in interconversion of palmitate and acetyl CoA	7 ATP + 14 NADPH = 49 ATP equiv	7 FADH ₂ + 7 NADH – 2 ATP – 33 ATP equiv

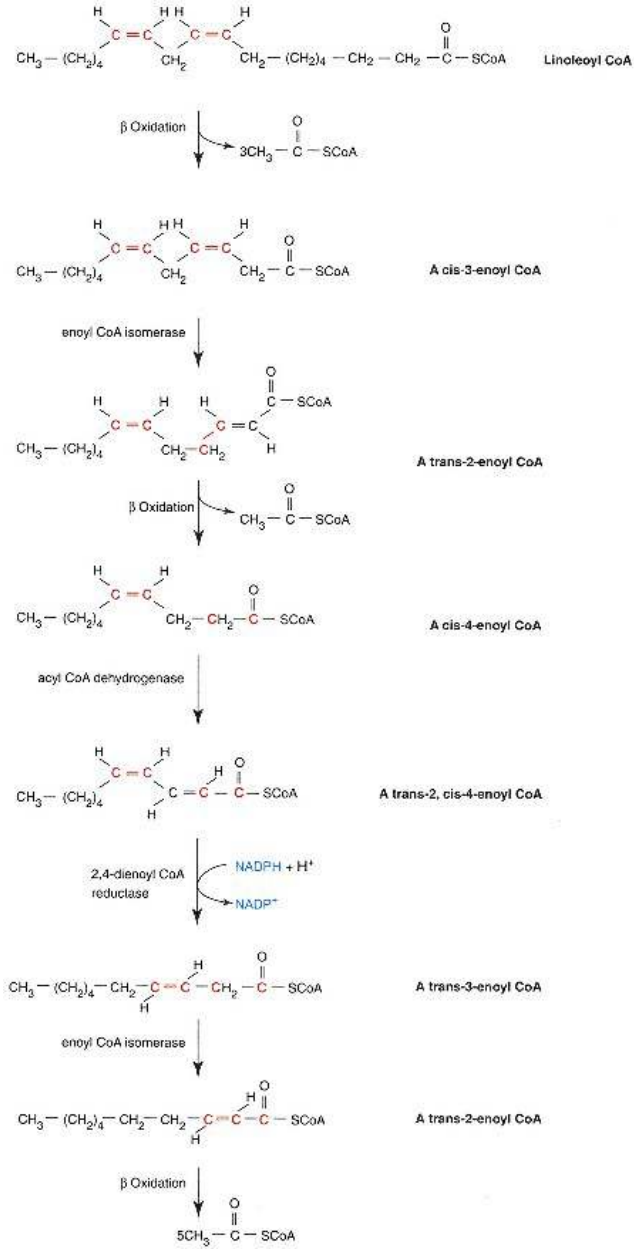

Figure 9.22
Oxidation of linoleoyl CoA.

required for the enoyl CoA hydratase reaction. If so, the cis bond between C-3 and C-4 atoms is isomerized into a trans bond between C-2 and C-3 atoms by an auxiliary enzyme, enoyl CoA isomerase. The regular process can then proceed.

A second problem occurs if the cis double bond of the acyl CoA intermediate resides between C-4 and C-5 atoms. In this case the action of acyl-CoA dehydrogenase gives rise to a *trans*-2, *cis*-4-enoyl CoA. This is acted on by 2,4-dienoyl CoA reductase that, using reducing equivalents from NADPH, produces a *trans*-3-enoyl CoA. This will serve as a substrate for enoyl CoA isomerase producing *trans*-2-enoyl CoA needed for the next round of β -oxidation.

Some Fatty Acids Undergo α -Oxidation

As noted earlier, there are several mechanisms for **hydroxylation of fatty acids**. The one discussed previously is for a hydroxylation of long-chain acids needed for synthesis of sphingolipids. In addition, there are systems in other tissues that hydroxylate the α carbon of shorter chain acids in order to start their oxidation. The sequence is as follows:

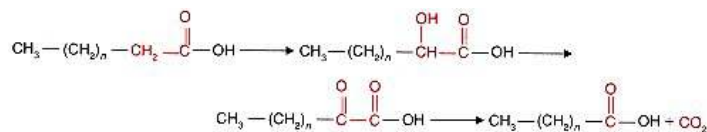

These hydroxylations probably occur in the endoplasmic reticulum and mitochondria and involve the "mixed function oxidase" type of mechanism discussed previously, because they require molecular oxygen, reduced nicotinamide nucleotides and specific cytochromes. Such reactions are particularly important in oxidation of methylated fatty acids (see Clin. Corr. 9.6).

ω -Oxidation Gives Rise to a Dicarboxylic Acid

Another minor pathway for fatty acid oxidation also involves hydroxylation and occurs in the endoplasmic reticulum of many tissues. In this case hydroxylation takes place on the methyl carbon at the other end of the molecule from the carboxyl group or on the carbon next to the methyl end. It uses the "mixed function oxidase" type of reaction requiring cytochrome P450, O_2 , and NADPH, as well as the necessary enzymes (see Chapter 23). Hydroxylated fatty acid can be further oxidized to a **dicarboxylic acid** via sequential action of cytosolic **alcohol** and **aldehyde dehydrogenases**. The process occurs primarily with medium-chain fatty acids. The overall reactions are

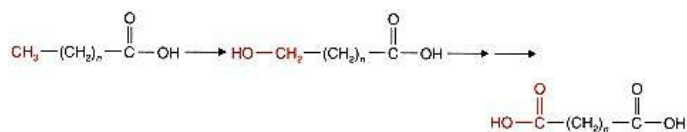

The dicarboxylic acid so formed can be activated at either end of the molecule to form a CoA ester, which in turn can undergo β -oxidation to produce shorter chain dicarboxylic acids such as adipic (C6) and succinic (C4) acids. This process appears to occur primarily in peroxisomes (see p. 19).

Ketone Bodies Are Formed from Acetyl CoA

The ketone bodies are water-soluble forms of lipid-based energy and consist mainly of acetoacetic acid and its reduction product β -hydroxybutyric acid. β -Hydroxybutyryl CoA and acetoacetyl CoA are intermediates near the end of the β -oxidation sequence, and it was initially presumed that enzymatic removal

CLINICAL CORRELATION 9.6

Refsum's Disease

Although the use of the α -oxidation scheme is a relatively minor one in terms of total energy production, it is significant in the metabolism of dietary fatty acids that are methylated. A principal example of these is phytanic acid,

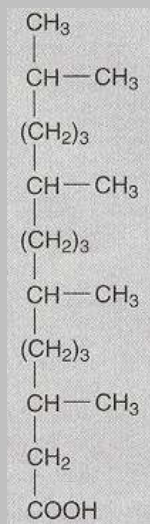

Phytanic acid

a metabolic product of phytol, which occurs as a constituent of chlorophyll. Phytanic acid is a significant constituent of milk lipids and animal fats, and normally it is metabolized by an initial α -hydroxylation followed by dehydrogenation and decarboxylation. β -Oxidation cannot occur initially because of the presence of the 3-methyl group, but it can proceed after the decarboxylation. The whole reaction produces three molecules of propionyl CoA, three molecules of acetyl CoA, and one molecule of isobutyryl CoA.

In a rare genetic disease called Refsum's disease, the patients lack the α -hydroxylating enzyme and accumulate large quantities of phytanic acid in their tissues and sera. This leads to serious neurological problems such as retinitis pigmentosa, peripheral neuropathy, cerebellar ataxia, and nerve deafness. The restriction of dietary dairy products and meat products from ruminants results in lowering of plasma phytanic acid and regression of neurologic symptoms.

Steinberg, D. Refsum disease. In: C. R. Scriver, A. L. Beaudet, W. S. Sly, and D. Valle (Eds.), *The Metabolic and Molecular Bases of Inherited Disease*, Vol. II, 7th ed. New York: McGraw-Hill, 1995, p. 2351.

of CoA from these compounds was the main route for production of the free acids. However, β -oxidation proceeds completely to acetyl CoA production without accumulation of any intermediates, and acetoacetate and β -hydroxybutyrate are formed subsequently from acetyl CoA by a separate mechanism.

HMG CoA Is an Intermediate in the Synthesis of Acetoacetate from Acetyl CoA

The primary site for formation of ketone bodies is liver, with lesser activity occurring in kidney. The entire process takes place within the mitochondrial matrix and begins with condensation of two acetyl CoA molecules to form acetoacetyl CoA (Figure 9.23). The enzyme involved, **β -ketothiolase**, is probably an isozyme of that which catalyzes the reverse reaction as the last step of β -oxidation. Acetoacetyl CoA then condenses with another molecule of acetyl CoA to form **β -hydroxy- β -methylglutaryl coenzyme A (HMG CoA)**. Cleavage of HMG CoA then yields acetoacetic acid and acetyl CoA.

Acetoacetate Forms Both D- β -Hydroxybutyrate and Acetone

In mitochondria a fraction of the acetoacetate is reduced to D- β -hydroxybutyrate depending on the intramitochondrial $[NADH]/[NAD^+]$ ratio. Note that the product of this reaction is D- β -hydroxybutyrate, whereas β -hydroxybutyryl CoA formed during β -oxidation is of the L configuration. **β -Hydroxybutyrate dehydrogenase** is tightly associated with the inner mitochondrial membrane and, because of its high activity in liver, the concentrations of substrates and products

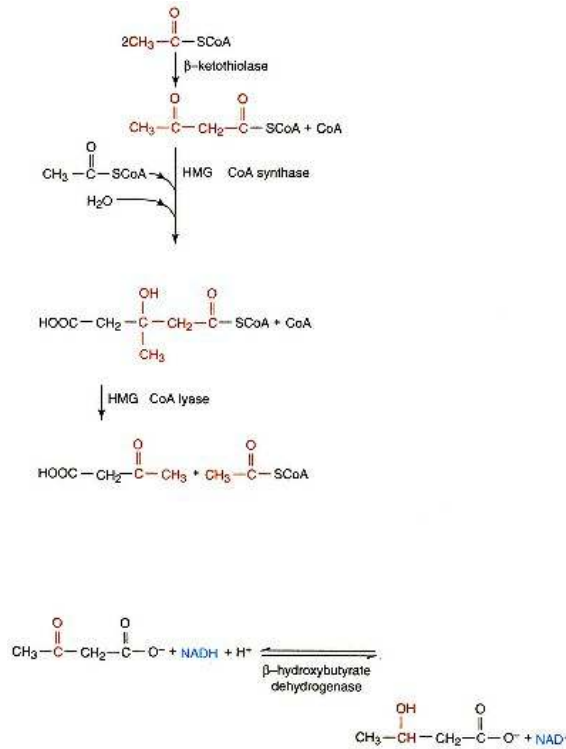
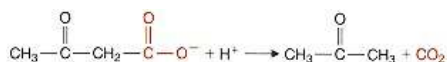

Figure 9.23
Pathway of acetoacetate formation.

of the reaction are maintained close to equilibrium. Thus the ratio of β -hydroxybutyrate to acetoacetate in blood leaving liver can be taken as a reflection of the mitochondrial $[\text{NADH}]/[\text{NAD}^+]$ ratio.

Some acetoacetate continually undergoes slow, spontaneous nonenzymatic decarboxylation to acetone:



Under normal conditions acetone formation is negligible, but when pathological accumulations of acetoacetate occur, as, for example, in severe diabetic ketoacidosis (see Clin. Corr. 9.7), the amount of acetone in blood can be sufficient to cause it to be detectable in a patient's breath.

As seen from Figure 9.24, the pathway leading from acetyl CoA to HMG CoA also operates in the cytosolic space of liver cells (indeed, this applies to essentially all tissues of the body). However, in this compartment HMG CoA lyase is absent and the HMG CoA formed is used for cholesterol biosynthesis (see Chapter 10). What distinguishes liver from nonhepatic tissues is its high complement of intramitochondrial **HMG CoA synthase**, thus providing an enzymological basis for the primacy of this organ in ketone body production.

Utilization of Ketone Bodies by Nonhepatic Tissues Requires Formation of Acetoacetyl CoA

Acetoacetate and β -hydroxybutyrate produced by liver serve as excellent fuels for a variety of nonhepatic tissues, such as cardiac and skeletal muscle, particularly when glucose is in short supply (starvation) or inefficiently used (insulin deficiency). But since under these conditions the same tissues can readily use free fatty acids (whose blood concentration rises as insulin levels fall) as a source of energy, a nagging question for many years was why liver should produce ketone bodies in the first place. The answer emerged in the late 1960s with the recognition that during prolonged starvation in humans the ketone bodies replace glucose as the major fuel of respiration for the central nervous system, which has a low capacity for fatty acid oxidation. Also noteworthy is the fact that during the neonatal period of development, acetoacetate and β -hydroxybutyrate serve as important precursors for cerebral lipid synthesis.

Use of ketone bodies requires that acetoacetate first be reactivated to its CoA derivative. This is accomplished by a mitochondrial enzyme, acetoacetate:succinyl CoA CoA transferase, present in most nonhepatic tissues but absent from liver. Succinyl CoA serves as the source of the coenzyme. The reaction is depicted in Figure 9.25. Through the action of β -ketothiolase, acetoacetyl CoA is then converted into acetyl CoA, which in turn enters the TCA cycle with production of energy. Mitochondrial β -hydroxybutyrate dehydrogenase in non-hepatic tissues reconverts β -hydroxybutyrate into acetoacetate as the concentration of the latter is decreased.

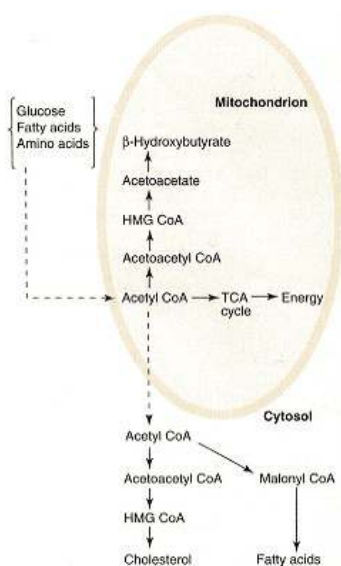

Figure 9.24
Interrelationships of ketone bodies with lipid, carbohydrate, and amino acid metabolism in liver.

Starvation and Certain Pathological Conditions Lead to Ketosis

Under normal feeding conditions, hepatic production of acetoacetate and β -hydroxybutyrate is minimal and the concentration of these compounds in the blood is very low (≤ 0.2 mM). However, with food deprivation ketone body synthesis is greatly accelerated, and the circulating level of acetoacetate plus β -hydroxybutyrate may rise to the region of 3–5 mM. This is a normal response of the body to a shortage of carbohydrate and serves a number of crucial roles. In the early stages of fasting, use of ketone bodies by heart and skeletal muscle conserves glucose for support of the central nervous system. With more prolonged starvation, increased blood concentrations of acetoacetate and β -hydroxybutyrate ensure their efficient uptake by brain, thereby further sparing glucose consumption.

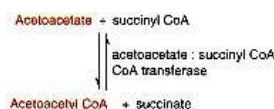

Figure 9.25
Initial step in utilization of acetoacetate by nonhepatic tissues.

CLINICAL CORRELATION 9.7

Diabetic Ketoacidosis

Diabetic ketoacidosis (DKA) is a common illness among patients with insulin-dependent diabetes mellitus. Although mortality rates have declined, they are still in the range of 6–10%. The condition is triggered by severe insulin deficiency coupled with glucagon excess and is frequently accompanied by concomitant elevation of other stress hormones, such as epinephrine, norepinephrine, cortisol, and growth hormone. The major metabolic derangements are marked hyperglycemia, excessive ketonemia, and ketonuria. Blood concentrations of acetoacetic acid plus β -hydroxybutyric acid as high as 20 mM are not uncommon. Because these are relatively strong acids ($pK \approx 3.5$), the situation results in life-threatening metabolic acidosis.

The massive accumulation of ketone bodies in the blood in DKA stems from a greatly accelerated hepatic production rate such that the capacity of nonhepatic tissues to use them is exceeded. In biochemical terms the initiating events are identical with those operative in the development of starvation ketosis; that is, increased glucagon/insulin ratio elevation of liver cAMP decreased malonyl CoA deactivation of CPT I activation of fatty acid oxidation and ketone production (see text for details). However, in contrast to physiological ketosis, where insulin secretion from the pancreatic β cells limits free fatty acid (FFA) availability to the liver, this restraining mechanism is absent in the diabetic individual. As a result, plasma FFA concentrations can reach levels as high as 3–4 mM, which drive hepatic ketone production at maximal rates.

Correction of DKA requires rapid treatment that will be dictated by the severity of the metabolic abnormalities and the associated tissue water and electrolyte imbalance. Insulin is essential. It lowers the plasma glucagon level, antagonizes the catabolic effects of glucagon on the liver, inhibits the flow of ketogenic and gluconeogenic substrates (FFA and amino acids) from the periphery, and stimulates glucose uptake in target tissues.

Foster, J. D., and McGarry, J. D. Metabolic derangements and treatment of diabetic ketoacidosis. *N. Engl. J. Med.* 309:159, 1983; and Foster, D. W., and McGarry, J. D. Acute complications of diabetes: ketoacidosis, hyperosmolar coma, lactic acidosis. In: L. J. DeGroot (Ed.), *Endocrinology*, Vol. 2, 3rd ed. Philadelphia: Saunders, 1995, p. 1506.

In contrast to the **physiological ketosis of starvation**, certain pathological conditions, most notably **diabetic ketoacidosis** (see Clin. Corr. 9.7), are characterized by excessive accumulation of ketone bodies in the blood (up to 20 mM). Hormonal and biochemical factors operative in the overall control of hepatic ketone body production are discussed in detail in Chapter 14.

Peroxisomal Oxidation of Fatty Acids Serves Many Functions

Although the bulk of cellular fatty acid oxidation occurs in mitochondria it has recently become clear that a significant fraction also takes place in **peroxisomes** of liver, kidney, and other tissues. Peroxisomes are a class of subcellular organelles with distinctive morphological and chemical characteristics. Their initial distinguishing property was a high content of the enzyme catalase and it has been suggested that peroxisomes may function in a protective role against oxygen toxicity. Several lines of evidence suggest that they are also involved in lipid catabolism. First, the analogous structures in plants, glyoxysomes, are capable of oxidizing fatty acids. Second, a number of drugs used clinically to decrease triacylglycerol levels in patients cause a marked increase in peroxisomes. Third, liver peroxisomes, isolated by differential centrifugation, oxidize fatty acids and contain most of the enzymes needed for the β -oxidation process.

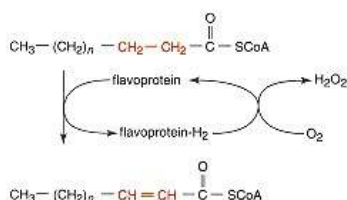

Figure 9.26
Initial step in peroxisomal fatty acid oxidation.

The mammalian **peroxisomal fatty acid oxidation** scheme is similar to that in plant glyoxysomes but differs from the mitochondrial β -oxidation system in three important respects. First, the initial dehydrogenation is accomplished by a cyanide-insensitive oxidase system, as shown in Figure 9.26. H_2O_2 formed is eliminated by **catalase**, and the remaining steps are the same as in the mitochondrial system. Second, there is evidence that the peroxisomal and mitochondrial enzymes are slightly different and that the specificity in peroxisomes is for somewhat longer chain length. Third, although rat liver mitochondria will oxidize a molecule of palmitoyl CoA to eight molecules of acetyl CoA, the β -oxidation system in peroxisomes from the same organ will not proceed beyond the stage of octanoyl CoA (C8). The possibility is thus raised that one function

of peroxisomes is to shorten the chains of relatively long-chain fatty acids to a point at which β -oxidation can be completed in mitochondria.

Other peroxisomal reactions include chain shortening of dicarboxylic acids, as noted earlier, conversion of cholesterol into bile acids, and formation of ether lipids. Given these diverse metabolic roles it is not surprising that the congenital absence of functional peroxisomes, an inherited defect known as Zellweger syndrome, has such devastating effects (see Clin. Corr. 1.3).

Bibliography

- Foster, D. W., and McGarry, J. D. Acute complications of diabetes: ketogenesis, hyperosmolar coma, lactic acidosis. In: L. J. DeGroot (Ed.), *Endocrinology*, Vol. 2, 3rd ed. Philadelphia: Saunders, 1995, p. 1506.
- Goldstein, J. L., Hobbs, H. H., and Brown, M. S. Familial hypercholesterolemia. In: C. R. Scriver, A. L. Beaudet, W. S. Sly, and D. Valle (Eds.), *The Metabolic and Molecular Bases of Inherited Disease*, Vol. II, 7th ed. New York: McGraw-Hill, 1995, p. 1981.
- Gurr, M. I., and James, A. T. *Lipid Biochemistry, An Introduction*, 3rd ed. London: Chapman and Hall, 1980.
- Kane, J. P., and Havel, R. J. Disorders of the biogenesis and secretion of lipoproteins containing the B apolipoproteins. In: C. R. Scriver, A. L. Beaudet, W. S. Sly, and D. Valle (Eds.), *The Metabolic and Molecular Bases of Inherited Disease*, Vol. II, 7th ed. New York: McGraw-Hill, 1995, p. 1853.
- McGarry, J. D., and Foster, D. W. Regulation of hepatic fatty acid oxidation and ketone body production. *Annu. Rev. Biochem.* 49:395, 1980.
- McGarry, J. D., Woeltje, K. F., Kuwajima, M., and Foster, D. W. Regulation of ketogenesis and the renaissance of carnitine palmitoyltransferase. *Diabetes Metab. Rev.* 5:271, 1989.
- Nilsson-Ehle, P., Garfinkel, A. S., and Schotz, M. C. Lipolytic enzymes and plasma lipoprotein metabolism. *Annu. Rev. Biochem.* 49:667, 1980.
- Robinson, A. M., and Williamson, D. H. Physiological roles of ketone bodies as substrates and signals in mammalian tissues. *Physiol. Rev.* 60:143, 1980.
- Saudubray, J.-M., Mitchell, G., Bonnefont, J.-P., Schwartz, G., et al. Approach to the patient with a fatty acid oxidation disorder. In: P. M. Coates and K. Tanaka (Eds.), *New Developments in Fatty Acid Oxidation*. New York: Wiley-Liss, 1992, p. 271.
- Stanley, C. A. Plasma and mitochondrial membrane carnitine transport defects. In: P. M. Coates and K. Tanaka (Eds.), *New Developments in Fatty Acid Oxidation*. New York: Wiley-Liss, 1992, p. 289.
- Wakil, S.J., Stoops, J.K., and Joshi, V. C. Fatty acid synthesis and its regulation. *Annu. Rev. Biochem.* 52:537, 1983.

Questions

C. N. Angstadt and J. Baggott

- Fatty acids occurring in humans most commonly:
 - are highly branched structures.
 - have double bonds present in trans configuration.
 - contain an even number of carbon atoms.
 - are limited to 16 or fewer carbon atoms.
 - if polyunsaturated, have a conjugated double-bond system.
- Triacylglycerols:
 - would be expected to be good emulsifying agents.
 - yield about the same amount of ATP on complete oxidation as would an equivalent weight of glycogen.
 - are stored as hydrated molecules.
 - in the average individual, represent sufficient energy to sustain life for several weeks.
 - are generally negatively charged molecules at physiological pH.
- In humans, fatty acids:
 - can be synthesized from excess dietary carbohydrate or protein.
 - are not required at all in the diet.
 - containing double bonds cannot be synthesized.
 - must be supplied entirely by the diet.
 - other than palmitate, must be supplied by the diet.
- All of the following statements about acetyl-CoA carboxylase are correct EXCEPT:
 - it undergoes protomer-polymer interconversion during its physiological regulation.
 - it requires biotin.
 - it is inhibited by cAMP-mediated phosphorylation.
 - it is activated by both palmitoyl CoA and citrate.
 - its content in a cell responds to changes in fat content in the diet.
- In the synthesis of palmitate:
 - the addition of malonyl CoA to fatty acid synthase elongates the growing chain by three carbon atoms.
 - a β -keto residue on the 4-phosphopantetheine moiety is reduced to a saturated residue by NADPH.
 - palmitoyl CoA is released from the synthase.
 - transfer of the growing chain from ACP to another -SH occurs after the addition of the next malonyl CoA.
 - the first compound to add to fatty acid synthase is malonyl CoA.
- Citrate stimulates fatty acid synthesis by all of the following EXCEPT:
 - allosterically activating acetyl-CoA carboxylase.
 - providing a mechanism to transport acetyl CoA from the mitochondria to the cytosol.
 - participating in a pathway that ultimately produces CO₂ and NADPH in the cytosol.
 - participating in the production of ATP.

7. Fatty acyl CoAs shorter than 16 carbon atoms are the preferred substrates for:
- fatty acid elongation in the brain.
 - carnitine transport into the mitochondria.
 - fatty acid elongation in mitochondria.
 - fatty acid elongation in the endoplasmic reticulum.
 - all of the above.
8. Fatty acid synthase:
- synthesizes only palmitate.
 - yields an unsaturated fatty acid by skipping a reductive step.
 - produces hydroxy fatty acids in nerve tissue.
 - can stop synthesis with the release of a fatty alcohol instead of an acid.
 - can produce a branched-chain fatty acid if methylmalonyl CoA is used as a substrate.
9. In humans, desaturation of fatty acids:
- occurs primarily in mitochondria.
 - is catalyzed by an enzyme system that uses NADPH and a cytochrome.
 - introduces double bonds primarily of trans configuration.
 - can occur only after palmitate has been elongated to stearic acid.
 - introduces the first double bond at the methyl end of the molecule.
10. All of the following events are usually involved in the synthesis of triacylglycerols in adipose tissue EXCEPT:
- addition of a fatty acyl CoA to a diacylglycerol.
 - addition of a fatty acyl CoA to a lysophosphatide.
 - a reaction catalyzed by glycerol kinase.
 - hydrolysis of phosphatidic acid by a phosphatase.
 - reduction of dihydroxyacetone phosphate.
11. Plasma lipoproteins:
- are the only carriers of lipid-based energy in the blood.
 - usually have a nonpolar core containing triacylglycerols and cholesterol esters.
 - are composed primarily of free (unesterified) fatty acids.
 - include chylomicrons generated in the liver.
 - include high density lipoproteins (HDL) as the major carrier of lipid-based energy.
12. Lipoprotein lipase:
- is an intracellular enzyme.
 - is stimulated by cAMP-mediated phosphorylation.
 - functions to mobilize stored triacylglycerols from adipose tissue.
 - is stimulated by one of the apoproteins present in VLDL.
 - readily hydrolyzes three fatty acids from a triacylglycerol.
13. A deficiency of carnitine might be expected to interfere with:
- β -oxidation.
 - ketone body formation from acetyl CoA.
 - palmitate synthesis.
 - mobilization of stored triacylglycerols from adipose tissue.
 - uptake of fatty acids into cells from the blood.
14. β -Oxidation of fatty acids:
- generates ATP only if acetyl CoA is subsequently oxidized.
 - is controlled primarily by allosteric effectors.
 - uses only even-chain, saturated fatty acids as substrates.
 - uses NADP⁺
 - occurs by a repeated sequence of four reactions.
15. Ketone bodies:
- are formed by removal of CoA from the corresponding intermediate of β -oxidation.
 - are synthesized from cytoplasmic β -hydroxy- β -methylglutaryl coenzyme A (HMG CoA).
 - are excellent energy substrates for liver.
 - include both β -hydroxybutyrate and acetoacetate, the ratio reflecting the intramitochondrial [NADH]/[NAD⁺] ratio in liver.
 - form when β -oxidation is interrupted.
16. The high glucagon/insulin ratio seen in starvation:
- promotes mobilization of fatty acids from adipose stores.
 - stimulates β -oxidation by inhibiting the production of malonyl CoA.
 - leads to increased concentrations of ketone bodies in the blood.
 - all of the above.
 - none of the above.
17. Peroxisomal oxidation of fatty acids:
- is identical to β -oxidation in the mitochondria.
 - involves a flavoprotein that produces H₂O₂.
 - has a preference for fatty acids shorter than 12 carbons.
 - does not use NAD⁺.
 - is effective only for dicarboxylic acids.

Answers

- C A: Some may have methyl branches but most are straight chain. B: Most naturally occurring double bonds are cis, an important factor in β -oxidation of unsaturated fatty acids. D: C18 and C20 fatty acids are very common. E: Double bonds are separated by $-\text{CH}_2-$ (p. 363).
- D A, C, and E: Triacylglycerols are neutral, hydrophobic molecules with no hydrophilic portion and therefore are not emulsifying agents and are stored anhydrously. B: Their more reduced state, compared to carbohydrates, makes them more energy-rich (p. 365).
- A It is important to realize that triacylglycerol is the ultimate storage form of excess dietary intake. B–E: We can synthesize most fatty acids, including those with double bonds, except for the essential fatty acids, linoleic and linolenic acids (p. 365).
- D A: Acetyl-CoA carboxylase shifts between its protomeric (inactive) and polymeric (active) forms under the influence of a variety of regulatory factors. C: Since cAMP increases at times when energy is needed, it is consistent that a process that uses energy would be inhibited. E: Long-term control is

related to enzyme synthesis and responds appropriately to dietary changes (Table 9.2, p. 367).

5. B A: Splitting CO_2 from malonyl CoA is the driving force for the condensation reaction so the chain grows two carbon atoms at a time. C: Palmitate is released as the free acid; the conversion to the CoA ester is by a different enzyme (p. 369). D: It is important to realize that only ACP binds the incoming malonyl CoA so it must be freed before another addition can be made. E: Acetyl CoA adds first to form the foundation for the rest of the chain (p. 368).

6. D Citrate consumes ATP when acted upon by citrate cleavage enzyme (p. 371). A: Table 9.2. B: Acetyl CoA is generated primarily in mitochondria but does not cross the membrane readily. C: Oxaloacetate generated by citrate cleavage enzyme, when converted to malate, yields CO_2 and NADPH by the malic enzyme (Figure 9.10).

7. C C and D: The role of mitochondrial fatty acid elongation seems to be to elongate short-chain fatty acids; the cytoplasmic system is most active with palmitate. A: Brain elongates 18 carbon acids to meet its needs. B: Short- and medium-chain fatty acids are capable of entering mitochondria and their activation to CoA esters occurs there (p. 372).

8. E This is much slower than reaction with malonyl CoA, but it is significant. A: In certain tissues, for example, mammary glands, shorter chain products are formed. B–D: These products are all formed by other processes. Reactions proceeding on a multienzyme complex generally do not "stop" at intermediate steps (p. 374).

9. B A: Desaturation occurs in the endoplasmic reticulum. C: Naturally occurring fatty acids are cis. D: Elongation and unsaturation can occur in any order. E: If this were true we could make linoleic acid (p. 372).

10. C This does not occur to any significant extent in adipose tissue. A, B, and D: The sequential addition of fatty acyl CoAs to glycerol 3-phosphate forms lysophosphatidic acid, then phosphatidic acid whose phosphate is removed before the addition of the third fatty acyl residue. E: This is the formation of α -glycerol phosphate in adipose tissue (p. 375).

11. B All lipoproteins (Section 9.5) have this same general structure, a nonpolar core surrounded by a more polar shell. A and C: Fatty acids bound to serum albumin and ketone bodies are other sources. D: Chylomicrons carry dietary lipid from the intestine. E: HDL function is to carry cholesterol away from tissues (p. 379).

12. D A–C: These are characteristics of hormone-sensitive lipase. E: It generally requires more than one lipase to hydrolyze all of the fatty acids (p. 381, Table 9.3).

13. A Carnitine functions in transport of fatty acyl CoA esters formed in cytosol into the mitochondria (p. 382).

14. E A and D: It is important to realize that β -oxidation, itself, generates FADH_2 and NADH, which can be reoxidized to generate ATP. B: Carnitine transport to provide the substrate and reoxidation of reduced cofactors control β -oxidation. C: β -Oxidation is a general process requiring only minor modifications to oxidize nearly any fatty acid in the cell (p. 385, Table 9.4).

15. D A and E: β -Oxidation proceeds to completion; ketone bodies are formed by a separate process. B and C: Ketone bodies are formed, but not used, in liver mitochondria; cytosolic HMG CoA is a precursor of cholesterol (pp. 387–389).

16. D High glucagon/insulin ratio results in cAMP-mediated phosphorylations that activate hormone-sensitive lipase and inhibit acetyl-CoA carboxylase. Both of these, as well as other events, promote ketone body formation by greatly increasing acetyl CoA production in mitochondria, thereby assuring efficient uptake and utilization by brain (pp. 377, 381, 389).

17. B A and B: This is one of the differences between the peroxisomal and mitochondrial systems. C and E: Role seems to be to oxidize longer chain fatty acids to a point where mitochondrial oxidation can work. D: Except for the flavoprotein, the reactions are the same as the mitochondrial process (p. 390).

**Chapter 10—
Lipid Metabolism II:
Pathways of Metabolism of Special Lipids**

Robert H. Glew

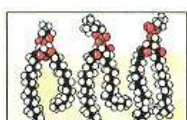

10.1 Overview	396
10.2 Phospholipids	397
Phospholipids Contain 1,2-Diacylglycerol and a Base Connected by a Phosphodiester Bridge	397
Phospholipids in Membranes Serve a Variety of Roles	398
Dipalmitoyllecithin Is Necessary for Normal Lung Function	398
Inositides Play a Role in Signal Transduction	399
Phosphatidylinositol Serves to Anchor Glycoproteins to the Plasma Membrane	401
Biosynthesis of Phospholipids	402
Phosphatidic Acid Is Synthesized from α -Glycerophosphate and Fatty Acyl CoA	402
Specific Phospholipids Are Synthesized by Addition of a Base to Diacylglycerol	404
The Asymmetric Distribution of Fatty Acids in Phospholipids Is Due to Remodeling Reactions	406
Plasmalogens Are Synthesized from Fatty Alcohols	408
10.3 Cholesterol	409
Cholesterol, an Alicyclic Compound, Is Widely Distributed in Free and Esterified Forms	409
Cholesterol Is a Membrane Component and Precursor of Bile Salts and Steroid Hormones	410
Cholesterol Is Synthesized from Acetyl CoA	410
Mevalonic Acid Is a Key Intermediate	411
Mevalonic Acid Is a Precursor of Farnesyl Pyrophosphate	412
Cholesterol Is Formed from Farnesyl Pyrophosphate via Squalene	413
Cholesterol Biosynthesis Is Carefully Regulated	415
Plasma Cholesterol Is in a Dynamic State	417
Cholesterol Is Excreted Primarily as Bile Acids	417
Vitamin D Is Synthesized from an Intermediate of Cholesterol Biosynthesis	420
10.4 Sphingolipids	420
Biosynthesis of Sphingosine	420
Ceramides Are Fatty Acid Amide Derivatives of Sphingosine	421
Sphingomyelin Is the Only Sphingolipid Containing Phosphorus	421
Sphingomyelin Is Synthesized from a Ceramide and Phosphatidylcholine	422
Glycosphingolipids Usually Have a Galactose or Glucose Unit	422
Cerebrosides Are Glycosylceramides	422
Sulfatide Is a Sulfuric Acid Ester of Galactocerebroside	425
Globosides Are Ceramide Oligosaccharides	425
Gangliosides Contain Sialic Acid	426
Sphingolipidoses Are Lysosomal Storage Diseases with Defects in the Catabolic Pathway for Sphingolipids	427
Diagnostic Enzyme Assays for Sphingolipidoses	429
10.5 Prostaglandins and Thromboxanes	431
Prostaglandins and Thromboxanes Are Derivatives of Twenty-Carbon, Monocarboxylic Acids	431
Synthesis of Prostaglandins Involves a Cyclooxygenase	433
Prostaglandin Production Is Inhibited by Steroidal and Nonsteroidal Anti-inflammatory Agents	435
Prostaglandins Exhibit Many Physiological Effects	435
10.6 Lipoxygenase and Oxy-Eicosatetraenoic Acids	436
Monohydroperoxyeicosatetraenoic Acids Are Products of Lipoxygenase Action	436
Leukotrienes and Hydroxyeicosatetraenoic Acids Are Hormones Derived from HPETEs	437
Leukotrienes and HETEs Affect Several Physiological Processes	439
Bibliography	440
Questions and Answers	441

Clinical Correlations

10.1 Respiratory Distress Syndrome	400
10.2 Treatment of Hypercholesterolemia	416
10.3 Atherosclerosis	417
10.4 Diagnosis of Gaucher's Disease in an Adult	430

**10.1—
Overview**

Lipid is a general term that describes substances that are relatively water insoluble and extractable by nonpolar solvents. Complex lipids of humans fall into one of two broad categories: nonpolar lipids, such as triacylglycerols and cholesterol esters, and polar lipids, which are amphipathic in that they contain both a hydrophobic domain and a hydrophilic region in the same molecule. This chapter discusses polar lipids including *phospholipids*, *sphingolipids*, and *eicosanoids*. The hydrophobic and hydrophilic regions are bridged by a glycerol moiety in glycerophospholipids and by sphingosine in sphingomyelin and glycosphingolipids. Triacylglycerol is confined largely to storage sites in adipose tissue, whereas polar lipids occur primarily in cellular membranes. Oils of soybean, oil palm, rapeseed, sunflower, cottonseed, and peanut account for 80% of worldwide plant oil production and consist mainly of palmitic, stearic, oleic, linoleic, and α -linolenic acids. Membranes generally contain 40% of their dry weight as lipid and 60% as protein.

Cell-cell recognition, phagocytosis, contact inhibition, and rejection of transplanted tissues and organs are all phenomena of medical significance that involve highly specific recognition sites on the surface of plasma membranes. Synthesis of the complex glycosphingolipids that play a role in these important biological events will be described. Glycolipids are worthy of study because ABO antigenic determinants of blood groups are primarily glycolipid in nature. In addition, various sphingolipids are the storage substances that accumulate in liver, spleen, kidney, or nervous tissue of persons suffering from certain genetic disorders called sphingolipidoses. In order to understand the basis of

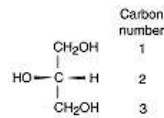

Figure 10.1
Stereospecific numbering of glycerol.

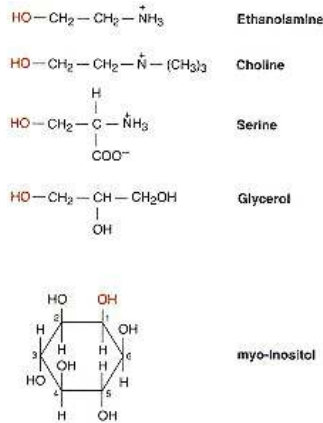

Figure 10.2
Structure of some common polar groups of phospholipids.

these enzyme-deficiency states, a knowledge of relevant chemical structures involved is required.

A very important lipid is *cholesterol*. This chapter describes the pathway of cholesterol biosynthesis and its regulation and shows how cholesterol functions as a precursor to bile salts and steroid hormones. Also described is the role of high-density lipoprotein (HDL) and lecithin:cholesterol acyltransferase (LCAT) in the management of plasma cholesterol.

Finally, the metabolism and function of two pharmacologically powerful classes of hormones derived from arachidonic acid, namely, prostaglandins and leukotrienes, will be discussed. See the Appendix, for a discussion of nomenclature and chemistry of lipids.

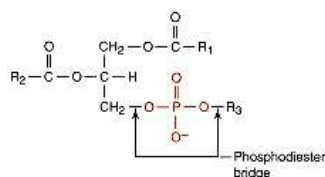

Figure 10.3

Generalized structure of a phospholipid where R₁ and R₂ represent the aliphatic chains of fatty acids, and R₃ represents a polar group.

10.2—

Phospholipids

Two principal classes of **acylglycerolipids** are **triacylglycerols** and **glycerophospholipids**. They are referred to as glycerolipids because the core of these compounds is provided by the C3 polyol, glycerol. Two primary alcohol groups of glycerol are not stereochemically identical and in the case of phospholipids, it is usually the same hydroxyl group that is esterified to the phosphate residue. The stereospecific numbering system is the best way to designate different hydroxyl groups. In this system, when the structure of glycerol is drawn in the Fischer projection with the C-2 hydroxyl group projecting to the left of the page, the carbon atoms are numbered as shown in Figure 10.1. When the stereospecific numbering (*sn*) system is employed, the prefix *sn*- is used before the name of the compound. Glycerophospholipids usually contain an *sn*-glycerol 3-phosphate moiety. Although each contains the glycerol moiety as a fundamental structural element, neutral triacylglycerols and charged ionic phospholipids have very different physical properties and functions.

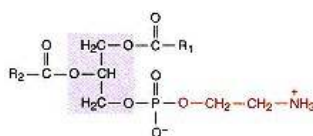

Phosphatidylethanolamine

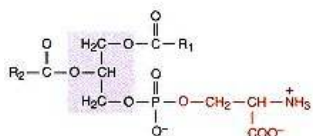

Phosphatidylserine

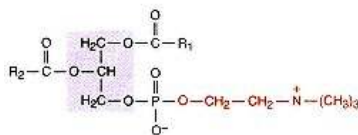

Figure 10.4

Structures of some common phospholipids.

Phospholipids Contain 1,2-Diacylglycerol and a Base Connected by a Phosphodiester Bridge

Phospholipids are polar, ionic lipids composed of 1,2-diacylglycerol and a phosphodiester bridge that links the glycerol backbone to some base, usually a nitrogenous one, such as choline, serine, or ethanolamine (Figures 10.2 and 10.3). The most abundant phospholipids in human tissues are **phosphatidylcholine** (also called lecithin), **phosphatidylethanolamine**, and **phosphatidylserine** (Figure 10.4). At physiologic pH, phosphatidylcholine and phosphatidylethanolamine have no net charge and exist as dipolar zwitterions, whereas phosphatidylserine has a net charge of -1 , causing it to be an acidic phospholipid. Phosphatidylethanolamine (PE) is related to phosphatidylcholine in that trimethylation of PE produces lecithin. Most phospholipids contain more than one kind of fatty acid per molecule, so that a given class of phospholipids from any tissue actually represents a family of molecular species. Phosphatidylcholine (PC) contains mostly palmitic acid (16:0) or stearic acid (18:0) in the *sn*-1 position and primarily unsaturated C18 fatty acids oleic, linoleic, or α -linolenic in the *sn*-2 position. Phosphatidylethanolamine has the same saturated fatty acids as PC at the *sn*-1 position but contains more of the long-chain polyunsaturated fatty acids—namely, 18:2, 20:4, and 22:6—at the *sn*-2 position.

Phosphatidylinositol is an acidic phospholipid that occurs in mammalian membranes (Figure 10.5). Phosphatidylinositol is rather unusual because it often contains almost exclusively stearic acid in the *sn*-1 position and arachidonic acid (20:4) in the *sn*-2 position.

Another phospholipid comprised of a polyol polar head group is **phosphatidylglycerol** (Figure 10.5), which occurs in relatively large amounts in

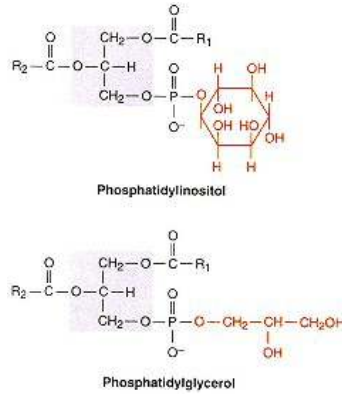

Figure 10.5
Structures of phosphatidylglycerol and phosphatidylinositol.

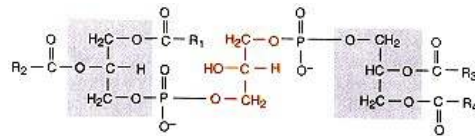

Figure 10.6
Structure of cardiolipin.

mitochondrial membranes and pulmonary surfactant and is a precursor of **cardiolipin**. Phosphatidylglycerol and phosphatidylinositol both carry a formal charge of -1 at neutral pH and are therefore acidic lipids. Cardiolipin, a very acidic (charge, -2) phospholipid, is composed of two molecules of phosphatidic acid linked together covalently through a molecule of glycerol (Figure 10.6). It occurs primarily in the inner membrane of mitochondria and in bacterial membranes.

Phospholipids mentioned so far contain only *O*-acyl residues attached to glycerol. *O*-(1-Alkenyl) substituents occur at C-1 of the *sn*-glycerol in phosphoglycerides in combination with an *O*-acyl residue esterified to the C-2 position; compounds in this class are known as **plasmalogens** (Figure 10.7). Relatively large amounts of ethanolamine plasmalogen (also called plasmenylethanolamine) occur in myelin with lesser amounts in heart muscle where choline plasmalogen is abundant.

An unusual phospholipid called "**platelet-activating factor**" (PAF) (Figure 10.8) is a major mediator of hypersensitivity, acute inflammatory reactions and anaphylactic shock. In hypersensitive individuals, cells of the polymorphonuclear (PMN) leukocyte family (basophils, neutrophils, and eosinophils), macrophages, and monocytes are coated with IgE molecules that are specific for a particular antigen (e.g., ragweed pollen and bee venom). Subsequent reexposure to the antigen and formation of antigen-IgE complexes on the surface of the aforementioned inflammatory cells provoke synthesis and release of PAF. Platelet-activating factor contains an *O*-alkyl moiety at the *sn*-1 position and an acetyl residue instead of a long-chain fatty acid (e.g., stearic acid) in position 2 of the glycerol moiety. PAF is not stored; it is synthesized and released when PMNs are stimulated. Platelet aggregation, cardiovascular and pulmonary changes, edema, hypotension, and PMN cell chemotaxis are affected by PAF.

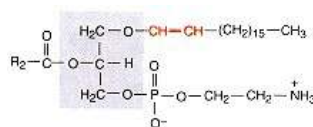

Figure 10.7
Structure of ethanolamine plasmalogen.

Phospholipids in Membranes Serve a Variety of Roles

Although present in body fluids such as plasma and bile, phospholipids are found in highest concentration in various cellular membranes where they serve as structural and functional components. Nearly one-half the mass of the erythrocyte membrane is comprised of various phospholipids (see Chapter 5). Phospholipids also activate certain enzymes. β -Hydroxybutyrate dehydrogenase, an enzyme imbedded in the inner membrane of mitochondria (see p. 388), has an absolute requirement for phosphatidylcholine; phosphatidylserine and phosphatidylethanolamine cannot substitute.

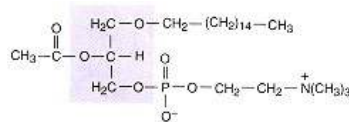

Figure 10.8
Structure of platelet activating factor (PAF).

Dipalmitoyllecithin Is Necessary for Normal Lung Function

Normal lung function depends on a constant supply of **dipalmitoyllecithin** in which the lecithin molecule contains palmitic acid (16:0) residues in both the *sn*-1 and *sn*-2 positions. More than 80% of the phospholipid in the extracellular liquid layer that lines alveoli of normal lungs is dipalmitoyllecithin. This particular phospholipid, called **surfactant**, is produced by type II epithelial cells and prevents atelectasis at the end of the expiration phase of breathing

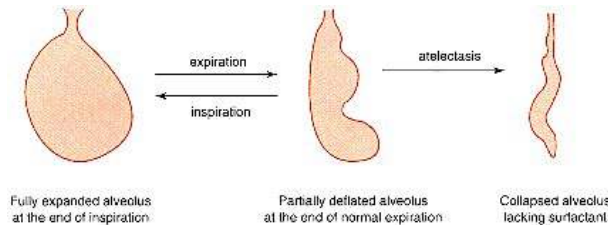

Figure 10.9
Role of surfactant in preventing atelectasis.

(Figure 10.9). This lipid decreases surface tension of the aqueous surface layer of the lung. Lecithin molecules that do not contain two residues of palmitic acid are not effective in lowering surface tension of the fluid layer lining alveoli. Surfactant also contains phosphatidylglycerol, phosphatidylinositol, and 18- and 36-kDa proteins (designated surfactant proteins), which contribute significantly to the surface tension lowering property of pulmonary surfactant.

During the third trimester—before the 28th week of gestation—fetal lung synthesizes primarily sphingomyelin. Normally, at this time, glycogen that has been stored in epithelial type II cells is converted to fatty acids and then to dipalmitoyllecithin. During lung maturation there is a good correlation between increase in lamellar inclusion bodies that represent the intracellular pulmonary surfactant (phosphatidylcholine) storage organelles, called lamellar bodies, and the simultaneous decrease in glycogen content of type II pneumocytes. At the 24th week of gestation the type II granular pneumocytes appear in the alveolar epithelium, and within a few days they produce their typical osmiophilic lamellar inclusion bodies. The number of type II cells increases until the 32nd week, at which time surface active agent appears in the lung and amniotic fluid. Surface tension decreases when inclusion bodies increase in the type II cells. In the few weeks before term one can perform screening tests on amniotic fluid to detect newborns that are at risk for respiratory distress syndrome (RDS) (see Clin. Corr. 10.1). These tests are useful in timing elective deliveries, in applying vigorous preventive therapy to the newborn infant, and to determine if the mother should be treated with a glucocorticoid drug to accelerate maturation of the fetal lung. Dexamethasone therapy has also been used in neonates with chronic lung disease (bronchopulmonary dysplasia); however, while such corticosteroid therapy may be effective in some cases in improving lung function, in others it causes periventricular abnormalities in the brain.

Respiratory failure due to an insufficiency in surfactant can also occur in adults whose type II cells or surfactant-producing pneumocytes have been destroyed as an adverse side effect of the use of immunosuppressive medications or chemotherapeutic drugs.

The **detergent properties** of phospholipids, especially phosphatidylcholine, play an important role in bile where they function to solubilize cholesterol. An impairment in phospholipid production and secretion into bile can result in formation of cholesterol stones and bile pigment gallstones. Phosphatidylinositol and phosphatidylcholine also serve as sources of arachidonic acid for synthesis of prostaglandins, thromboxanes, leukotrienes, and related compounds.

Inositides Play a Role in Signal Transduction

Inositol-containing phospholipids (inositides) play a central role in signal transduction systems; the most important is **phosphatidylinositol 4,5-bisphosphate (PIP₂)** (Figure 10.10). When certain ligands bind to their respective receptors on the plasma membrane of mammalian cells (see Chapter 19), PIP₂

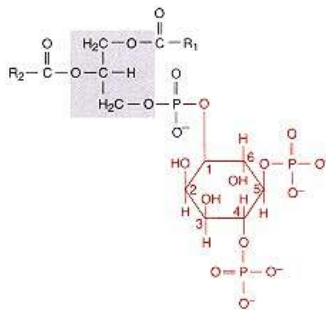

Figure 10.10
Structure of phosphatidylinositol
4,5-bisphosphate (PIP₂ or PtdIns (4,5)P₂).

CLINICAL CORRELATION 10.1

Respiratory Distress Syndrome

Respiratory distress syndrome (RDS) is a major cause of neonatal morbidity and mortality in many countries. It accounts for approximately 15–20% of all neonatal deaths in Western countries and somewhat less in developing countries. The disease affects only premature babies and its incidence varies directly with the degree of prematurity. Premature babies develop RDS because of immaturity of their lungs, resulting from a deficiency of pulmonary surfactant. The maturity of the fetal lung can be predicted antenatally by measuring the lecithin/sphingomyelin (L/S) ratio in the amniotic fluid. The mean L/S ratio in normal pregnancies increases gradually with gestation until about 31 or 32 weeks when the slope rises sharply. The ratio of 2.0 that is characteristic of the term infant at birth is achieved at the gestational age of about 34 weeks. For predicting pulmonary maturity, the critical L/S ratio, is 2.0 or greater. The risk of developing RDS when the L/S ratio is 1.5–1.9 is approximately 40%, and for a ratio less than 1.5 about 75%. Although the L/S ratio in amniotic fluid is still widely used to predict the risk of RDS, the results are unreliable if the amniotic fluid specimen has been contaminated by blood or meconium obtained during a complicated pregnancy.

In recent years determinations of saturated palmitoylphosphatidylcholine (SPC), phosphatidylglycerol, and phosphatidylinositol have been found to be additional predictors of the risk of RDS. Exogenous surfactant replacement therapy using surfactant from human and animal lungs is effective in the prevention and treatment of RDS.

Merritt, T. A., Hallman, M., Bloom, B.T., et al. Prophylactic treatment of very premature infants with human surfactant. *N. Engl. J. Med.* 315:785, 1986; and Simon, N. V., Williams, G. H., Fairbrother, P. F., Elser, R. C., and Perkins, R. P. Prediction of fetal lung maturity by amniotic fluid fluorescence polarization, L/S ratio, and phosphatidylglycerol. *Obstet. Gynecol.* 57:295, 1981.

localized to the inner leaflet of the membrane becomes a substrate for a receptor-dependent phosphoinositidase C (PIC), which hydrolyzes it into two intracellular signals (Figure 10.11): **inositol 1,4,5-trisphosphate** (IP_3), which triggers release of Ca^{2+} from special vesicles of the endoplasmic reticulum, and **1,2-diacylglycerol**, which stimulates activity of protein kinase C. Regulatory functions of these products of the PIC reaction are discussed in Chapter 19. Phosphatidic acid, a product of phospholipase D action on phospholipids, has been implicated as a second messenger.

The complex pathways of inositol phosphate metabolism serve three roles: (1) removal and inactivation of the potent intracellular signal IP_3 ; (2) conservation of inositol; and (3) synthesis of polyphosphates such as inositol pentakis-

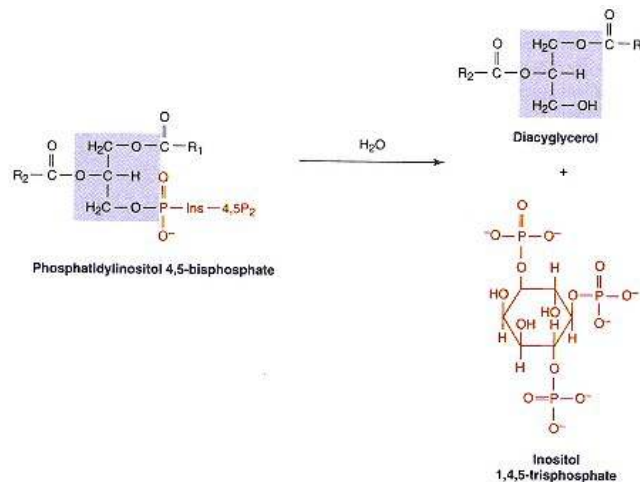

Figure 10.11

Generation of 1,2-diacylglycerol and inositol 1,4,5-trisphosphate by action of phospholipase C on phosphatidylinositol 4,5-bisphosphate.

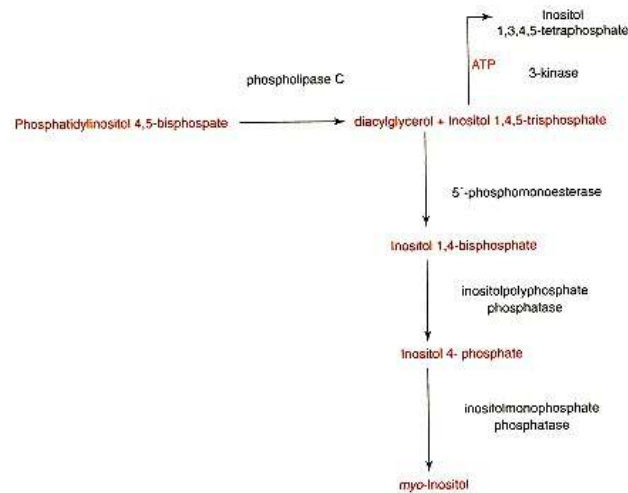

Figure 10.12

Pathways for the removal of intracellular inositol 1,4,5-trisphosphate.

phosphate (InsP_3) and inositol hexakisphosphate (InsP_6) whose functions have not been determined. Inositol 1,4,5-trisphosphate is metabolized by two enzymes: first a 5-phosphomonoesterase that converts IP_3 to inositol 1,4-bisphosphate and second a 3-kinase that forms inositol 1,3,4,5-tetraphosphate. A family of phosphatases in turn convert $\text{Ins}(1,4)\text{P}_2$ to *myo*-inositol (Figure 10.12). Inositol is eventually reincorporated into the phospholipid pool.

Phosphatidylinositol Serves to Anchor Glycoproteins to the Plasma Membrane

In addition to its role as a structural component of membranes and source of arachidonic acid for prostaglandin and leukotriene synthesis (see p. 431), phosphatidylinositol serves as an anchor to tether certain glycoproteins to the external surface of plasma membranes. In trypanosomal parasites (e.g., *Trypanosoma brucei*, which causes sleeping sickness), the external surface of the plasma membrane is coated with a protein called **variable surface glycoprotein (VSG)** linked to the membrane through a glycopospholipid anchor, specifically phosphatidylinositol (Figure 10.13). The salient structural features of the protein–lipid linkage region of the **glycosylphosphatidylinositol (GPI) anchor** are: (1) the diacylglyceride (DAG) moiety of phosphatidylinositol is integrated into the outer leaflet of the lipid bilayer of the plasma membrane; (2) the inositol residue is linked to DAG through a phosphodiester bond; (3) inositol is bonded to glucosamine, which contains a free, unacetylated amino group; (4) the presence of a mannose-rich glycan domain; and (5) a phosphoethanolamine residue linked to the carboxy terminus of the protein. Depending on the protein to which it is attached and the tissue or organism in which it is expressed, the GPI core may be decorated with additional carbohydrates and phosphatidylethanolamines that extend from the core mannoses; these include mannose, glucose, galactose, *N*-acetylgalactose, *N*-acetylneuraminic acid, and *N*-acetylgalactosamine. Some other proteins that are attached to the external surface of the plasma membrane include acetylcholine esterase, alkaline phosphatase, and 5'-nucleotidase.

The GPI anchor serves several functions. First, it confers on the protein to which it is attached unrestricted lateral mobility within the lipid bilayer, thereby allowing the protein to move about rapidly on the surface of the plasma membrane. Second, the presence of phospholipase C-type activity on the cell surface

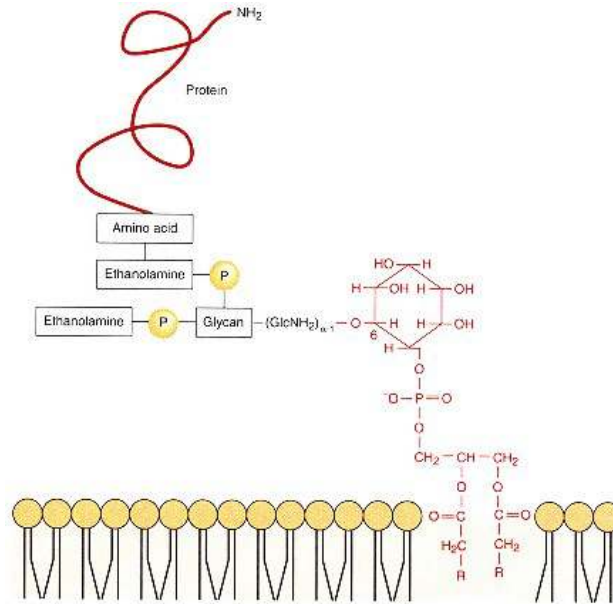

Figure 10.13

Structure of a typical phosphatidylinositol membrane protein anchor; GlcNH_2 , glucosamine.

permits shedding of the phosphatidylinositol-anchored protein. As an example, this provides trypanosomes with a means for discarding surface antigens, thus changing their coat and escaping antibodies of the host's immune system. Third, the action of phospholipase C on the phosphatidylinositol anchor releases diacylglyceride, a second messenger that can activate protein kinase C (see p. 865). Biosynthesis of GPI anchors has been characterized extensively.

Other types of protein lipidation (co- or posttranslational modification of proteins by specific lipids) include *N*-myristoylation at the amino terminus of proteins, *S*-palmitoylation at internal cysteines, and *S*-prenylation by farnesyl or geranylgeranyl residues at cysteines at the carboxyl terminus of proteins.

Biosynthesis of Phospholipids

Phosphatidic Acid Is Synthesized from α -Glycerophosphate and Fatty Acyl CoA

1- α -Phosphatidic acid (commonly called phosphatidic acid) and 1,2-diacyl-*sn*-glycerol are common intermediates in the pathways of phospholipid and triacylglycerol biosynthesis (Figure 10.14) and both pathways share some of the same enzymes (see Chapter 9). Essentially all cells are capable of synthesizing phospholipids to some degree (except mature erythrocytes), whereas triacylglycerol biosynthesis occurs only in liver, adipose tissue, and intestine. In most tissues, the pathway for phosphatidic acid synthesis begins with α -glycerophosphate (*sn*-glycerol 3-phosphate). The most general source of α -glycerophosphate, particularly in adipose tissue, is from reduction of the glycolytic intermediate, dihydroxyacetone phosphate, in the reaction catalyzed by α -glycerophosphate dehydrogenase:

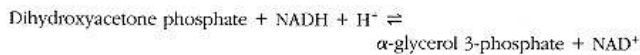

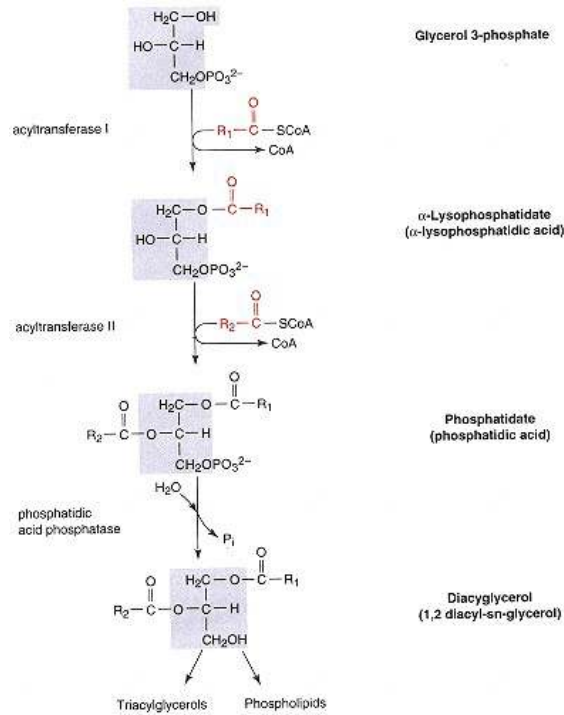
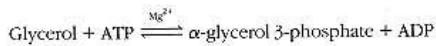

Figure 10.14
Phosphatidic acid biosynthesis from glycerol 3-phosphate and the role of phosphatidic acid phosphatase in synthesis of phospholipids and triacylglycerols.

A few specialized tissues, including liver and kidney, derive α -glycerophosphate by means of the glycerol kinase reaction:



The next two steps in phosphatidic acid biosynthesis involve stepwise transfer of long-chain fatty acyl groups from fatty acyl CoA. The first acyltransferase (I) is called **glycerol phosphate:acyltransferase** and attaches predominantly saturated fatty acids or oleic acid to the *sn*-1 to produce 1-acylglycerol phosphate or α -lysophosphatidic acid. The second enzyme (II), **1-acylglycerol phosphate:acyltransferase**, acylates the *sn*-2 position, usually with an unsaturated fatty acid (Figure 10.14). In both cases the donor of acyl groups is the CoA thioester derivative of the appropriate long-chain fatty acid.

The specificity of the two acyltransferases does not always match the fatty acid asymmetry found in the phospholipids of a particular cell. Remodeling reactions, discussed below, modify the fatty acid composition at C-1 and C-2 of the glycerol phosphate backbone.

Cytosolic phosphatidic acid phosphatase (also called phosphatidic acid phosphohydrolase) hydrolyzes phosphatidic acid (1,2-diacylglycerophosphate) that is generated on the endoplasmic reticulum, thereby yielding 1,2-diacyl-*sn*-glycerol that serves as the branch point in triacylglycerol and phospholipid synthesis (Figure 10.14). Phosphatidic acid can also be formed by a second pathway that begins with DHAP. This is usually an alternative supportive route used by some tissues to produce phosphatidic acid (see Chapter 9).

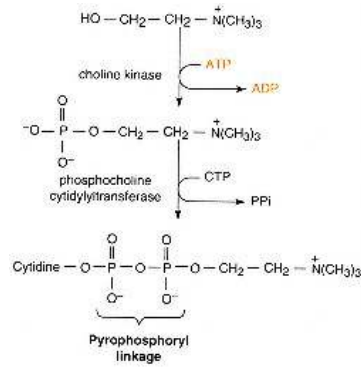

Figure 10.15
Biosynthesis of CDP-choline from choline.

Specific Phospholipids Are Synthesized by Addition of a Base to Diacylglycerol

The major pathway for biosynthesis of phosphatidylcholine (lecithin) involves sequential conversion of choline to phosphocholine, CDP-choline, and phosphatidylcholine. In this pathway, the phosphocholine polar head group is activated using CTP, according to the following reactions. Free choline, a dietary requirement for most mammals, is first phosphorylated by ATP by choline kinase (Figure 10.15). Phosphocholine is converted to CDP-choline at the expense of CTP in the reaction catalyzed by **phosphocholine cytidyltransferase**. Note inorganic pyrophosphate (PP_i) is a product of this reaction. The high-energy pyrophosphoryl bond in CDP-choline is very unstable and reactive so that the phosphocholine moiety can be transferred readily to the nucleophilic center provided by the OH group at position 3 of 1,2-diacylglycerol by choline phosphotransferase (Figure 10.16). This is the principal pathway for the synthesis of dipalmitoyllecithin in lung.

The rate-limiting step for phosphatidylcholine biosynthesis is the cytidyl-transferase reaction that forms CDP-choline (Figure 10.15). This enzyme is regulated by a novel mechanism involving exchange of enzyme between cytosol and endoplasmic reticulum. The cytosolic form of cytidyltransferase is inactive and appears to function as a reservoir of enzyme; binding of the enzyme to the membrane results in activation. Translocation of cytidyltransferase from the cytosol to the endoplasmic reticulum is regulated by cAMP and fatty acids. Reversible phosphorylation of the enzyme by a cAMP-dependent kinase causes it to be released from the membrane, rendering it inactive. Subsequent dephos-

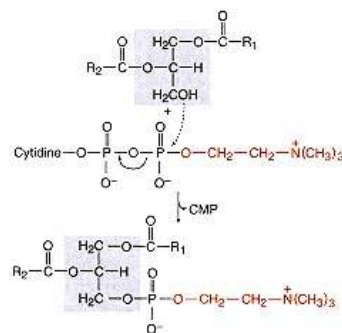

Figure 10.16
Choline phosphotransferase reaction.

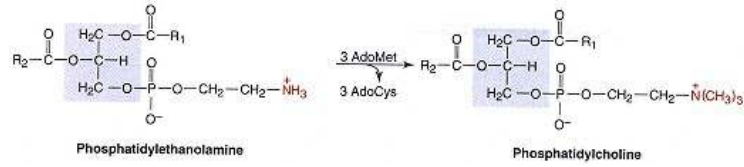
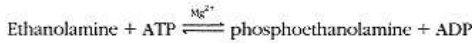

Figure 10.17

Biosynthesis of phosphatidylcholine from phosphatidylethanolamine and *S*-adenosylmethionine (AdoMet) and *S*-adenosylhomocysteine (AdoCys).

phorylation will cause cytidylyltransferase to rebound to the membrane and become active. Fatty acyl CoAs activate the enzyme by promoting its binding to the endoplasmic reticulum. In liver only, phosphatidylcholine is formed by repeated methylation of phosphatidylethanolamine. **Phosphatidylethanol-amine *N*-methyltransferase**, an enzyme of the endoplasmic reticulum, catalyzes transfer of methyl groups one at a time from ***S*-adenosylmethionine (AdoMet)** to phosphatidylethanolamine to produce phosphatidylcholine (Figure 10.17).

The primary pathway for phosphatidylethanolamine synthesis in liver and brain involves **ethanolamine phosphotransferase** of the endoplasmic reticulum that catalyzes the reaction shown in Figure 10.18. This enzyme is particularly abundant in liver. CDP-ethanolamine is formed by **ethanolamine kinase**:



and **phosphoethanolamine cytidylyltransferase**:

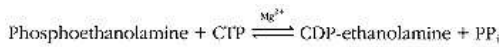

Liver mitochondria also generate phosphatidylethanolamine by decarboxylation of phosphatidylserine; however, this is thought to represent only a minor pathway (Figure 10.19).

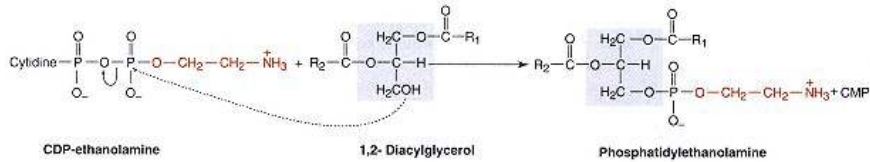

Figure 10.18

Biosynthesis of phosphatidylethanolamine from CDP-ethanolamine and diacylglycerol; the reaction is catalyzed by ethanolamine phosphotransferase.

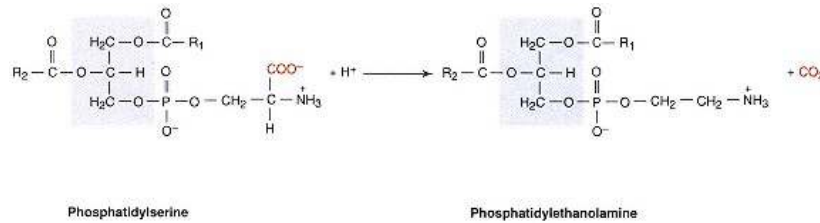

Figure 10.19

Formation of phosphatidylethanolamine by the decarboxylation of phosphatidylserine.

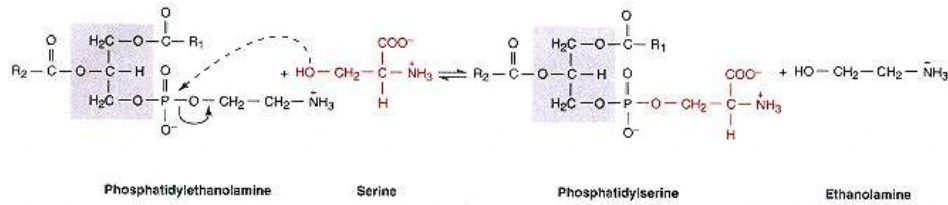

Figure 10.20

Biosynthesis of phosphatidylserine from serine and phosphatidylethanolamine by "base exchange."

The major source of phosphatidylserine in mammalian tissues is provided by the "base-exchange" reaction (Figure 10.20) in which the polar head group of phosphatidylethanolamine is exchanged for serine. Since there is no net change in the number or kinds of bonds, this reaction is reversible and has no requirement for ATP or any other high-energy compound. The reaction is initiated by attack on the phosphodiester bond of phosphatidylethanolamine by the hydroxyl group of serine.

Phosphatidylinositol is made via CDP-diacylglycerol and free *myo*-inositol (Figure 10.21) in a reaction catalyzed by **phosphatidylinositol synthase**, another enzyme of the endoplasmic reticulum.

The Asymmetric Distribution of Fatty Acids in Phospholipids Is Due to Remodeling Reactions

Two phospholipases, phospholipase A_1 and phospholipase A_2 , occur in many tissues and play a role in the formation of specific phospholipid structures containing appropriate fatty acids in the *sn*-1 and *sn*-2 positions. Most fatty acyl CoA transferases and phospholipid synthesizing enzymes discussed above lack the specificity required to account for the asymmetric position or distribution of fatty acids found in many tissue phospholipids. The fatty acids found in the *sn*-1 and *sn*-2 positions of the various phospholipids are often not the same ones transferred to the glycerol backbone in the initial acyl transferase reactions of the phospholipid biosynthetic pathways. **Phospholipases A_1 and A_2** catalyze reactions indicated in Figure 10.22 where X represents the polar head group of a phospholipid. The products of the action of phospholipases A_1 and A_2 are called lysophosphatides.

If it becomes necessary for a cell to remove some undesired fatty acid, such as stearic acid from the *sn*-2 position of phosphatidylcholine, and replace it by a more unsaturated one like arachidonic acid, then this can be accomplished by the action of phospholipase A_2 followed by a reacylation reaction. Insertion of arachidonic acid into the 2 position of *sn*-2-lysophosphatidylcholine can

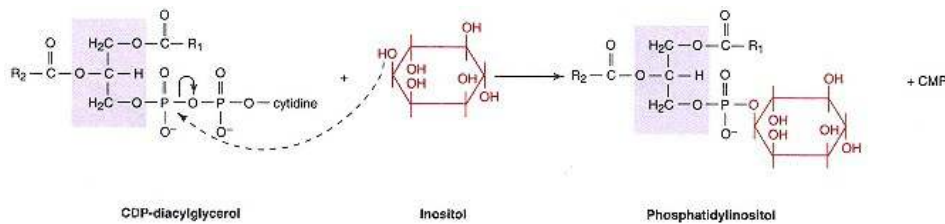

Figure 10.21

Biosynthesis of phosphatidylinositol.

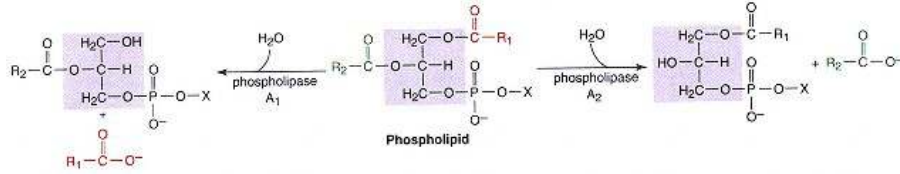

Figure 10.22
Reactions catalyzed by phospholipase A₁ and phospholipase A₂.

be accomplished either by direct acylation from arachidonoyl CoA involving **arachidonic acid-specific acyl CoA transacylase** (Figure 10.23) or from some other arachidonic acid-containing phospholipid by an exchange-type reaction (Figure 10.24) catalyzed by **lysolecithin: lecithin acyltransferase (LLAT)** (Figure 10.24). Since there is no change in either number or nature of the bonds involved in products and reactants, ATP is not required. Reacylation of lysophosphatidylcholine from acyl CoA is the major route for remodeling of phosphatidylcholine.

Lysophospholipids, particularly *sn*-1-lysophosphatidylcholine, can also serve as sources of fatty acid in remodeling reactions. Those involved in synthe-

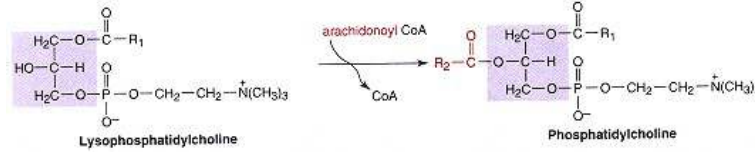

Figure 10.23
Synthesis of phosphatidylcholine by reacylation of lysophosphatidylcholine

where $R_2-C(=O)-O-$ represents arachidonic acid.

This reaction is catalyzed by acyl CoA:1-acylglycerol-3-phosphocholine *O*-acyltransferase

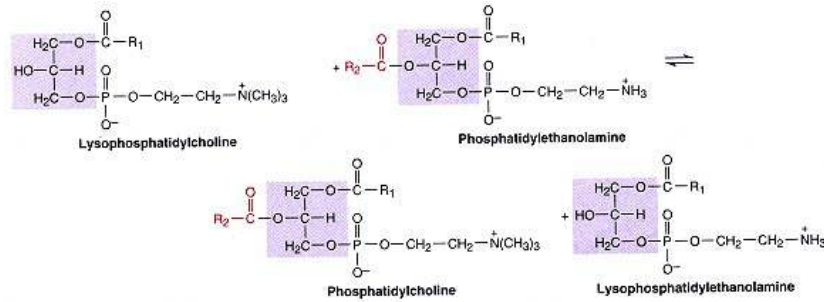

Figure 10.24

Formation of phosphatidylcholine by lysolecithin exchange, where $R_2-C(=O)-O-$ represents arachidonic acid.

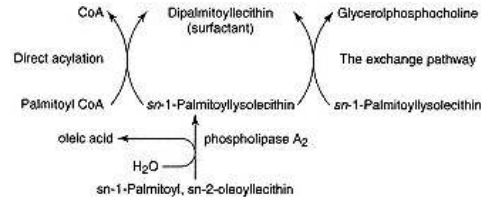

Figure 10.25
Two pathways for biosynthesis of dipalmitoyllecithin from *sn*-1 palmitoyl-lysolecithin.

sis of dipalmitoyllecithin (surfactant) from 1-palmitoyl-2-oleoylphosphatidyl-choline are presented in Figure 10.25. Note that *sn*-1-palmitoyllysolecithin is the source of palmitic acid in the acyltransferase exchange reaction.

Plasmalogenes Are Synthesized from Fatty Alcohols

Ether glycerolipids are synthesized from DHAP, long-chain fatty acids, and long-chain fatty alcohols; the reactions are summarized in Figure 10.26. Acyldihydroxyacetone phosphate is formed by **acyl CoA: dihydroxyacetone phosphate acyltransferase** (enzyme 1) acting on dihydroxyacetone phosphate and long-chain fatty acyl CoA. The ether bond is introduced by **dihydroxyacetone phosphate synthase** (Figure 10.26, enzyme 2), which exchanges the 1-*O*-acyl

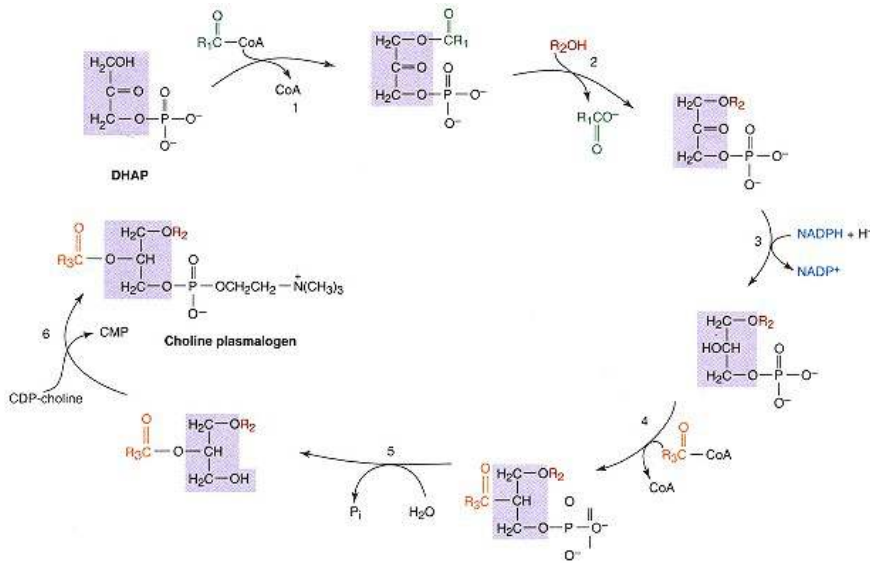

Figure 10.26
Pathway of choline plasmalogen biosynthesis from DHAP.
1, acyl CoA: dihydroxyacetone phosphate acyltransferase; 2, alkyl dihydroxyacetone phosphate synthase;
3, NADPH: alkyl dihydroxyacetone phosphate oxidoreductase; 4, acyl CoA: 1-alkyl-2- lyso-*sn*-glycerol-3-phosphate acyltransferase; 5, 1-alkyl-2-acyl-*sn*- glycerol-3-phosphate phosphohydrolase; 6, CDP-choline: 1-alkyl-2-acyl-*sn*-glycerol cholinephosphotransferase.

group of acyl dihydroxyacetone phosphate with a long-chain fatty alcohol. The synthase occurs in peroxisomes. Plasmalogen synthesis is completed by transfer of a long-chain fatty acid from its respective CoA donor to the *sn*-2 position of 1-alkyl-2-lyso-*sn*-glycero-3-phosphate (Figure 10.26, Reaction 4). Patients with Zellweger's disease lack peroxisomes and cannot synthesize adequate amounts of plasmalogen.

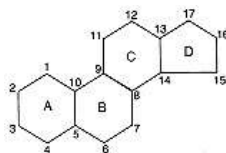

Figure 10.27
The cyclopentanoperhydrophenanthrene ring.

10.3— Cholesterol

Cholesterol, an Alicyclic Compound, Is Widely Distributed in Free and Esterified Forms

Cholesterol is an alicyclic compound whose structure includes: (1) the perhydrocyclopentanoperhydrophenanthrene nucleus with its four fused rings; (2) a single hydroxyl group at C-3, (3) an unsaturated center between C-5 and C-6 atoms; (4) an eight-membered branched hydrocarbon chain attached to the D ring at position 17; and (5) a methyl group (designated C-19) attached at position 10 and another methyl group (designated C-18) attached at position 13 (see Figures 10.27 and 10.28).

In terms of physical properties, cholesterol is a lipid with very low solubility in water; at 25°C, the limit of solubility is approximately 0.2 mg/100 mL. The actual concentration of cholesterol in plasma of healthy people is usually 150–200 mg/100 mL; this value is almost twice the normal concentration of blood glucose. This high solubility of cholesterol in blood is due to plasma lipoproteins (mainly LDL and VLDL) that have the ability to bind and thereby solubilize large amounts of cholesterol (see p. 56). Actually, only about 30% of the total plasma cholesterol occurs free; approximately 70% of the cholesterol in plasma lipoproteins exists in the form of **cholesterol esters** where some long-chain fatty acid, usually linoleic acid, is attached by an ester bond to the OH group on C-3 of the A ring. The long-chain fatty acid residue enhances the hydrophobicity of cholesterol (Figure 10.29). Cholesterol is a ubiquitous and essential component of mammalian cell membranes.

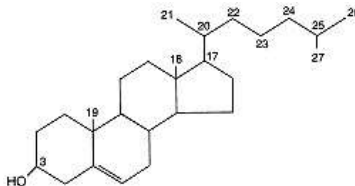

Figure 10.28
Structure of cholesterol (5-cholesten-3-ol).

Cholesterol is also abundant in bile where the normal concentration is 390 mg/100 mL. Only 4% of cholesterol in bile is esterified to a long-chain fatty acid. Bile does not contain appreciable amounts of lipoproteins and solubilization of free cholesterol is achieved in part by the detergent property of phospholipids present in bile that are produced in liver (see p. 1078). A chronic disturbance in phospholipid metabolism in liver can result in deposition of cholesterol-rich gallstones. Bile salts, which are derivatives of cholesterol, also aid in keeping cholesterol in solution in bile. Cholesterol also appears to protect membranes of the gallbladder from potentially irritating or harmful effects of bile salts.

In the clinical laboratory, total cholesterol is estimated by the Liebermann–Burchard reaction. The proportions of free and esterified cholesterol can be determined by gas–liquid chromatography or reverse-phase high-pressure liquid chromatography (HPLC).

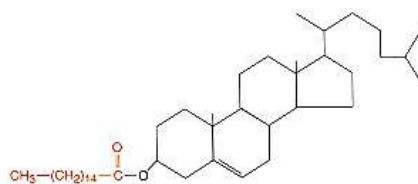

Figure 10.29
Structure of cholesterol (palmitoyl) ester.

Cholesterol Is a Membrane Component and Precursor of Bile Salts and Steroid Hormones

Cholesterol, derived from the diet or synthesized *de novo* in virtually all cells of humans, has a number of important roles. It is the major sterol in humans and a component of virtually all plasma and intracellular membranes. Cholesterol is especially abundant in myelinated structures of brain and central nervous system but is present in small amounts in the inner membrane of the mitochondrion (see p. 186). In contrast to the situation in plasma, most cholesterol in cellular membranes occurs in the free, unesterified form.

Cholesterol is the immediate precursor of **bile acids** synthesized in liver and that function to facilitate absorption of dietary triacylglycerols and fat-soluble vitamins (Chapter 26). It is important to realize that the ring structure of cholesterol cannot be metabolized to CO₂ and water in humans. Excretion of cholesterol is by way of the liver and gallbladder through the intestine in the form of bile acids.

Another physiological role of cholesterol is as the precursor of various **steroid hormones** (Chapter 21). Progesterone is the C₂₁ keto steroid sex hormone secreted by the corpus luteum of the ovary and by placenta. The metabolically powerful corticosteroids of adrenal cortex are derived from cholesterol; these include deoxycorticosterone, corticosterone, cortisol, and cortisone. The mine ralocorticoid aldosterone is derived from cholesterol in the zona glomerulosa tissue of the cortex of the adrenal gland. Cholesterol is also the precursor of female steroid hormones (estrogens, e.g., estradiol) in the ovary and of male steroids (e.g., testosterone) in the testes. Although all steroid hormones are structurally related to and biochemically derived from cholesterol, they have widely different physiological properties that relate to spermatogenesis, pregnancy, lactation and parturition, mineral balance, and energy (amino acids, carbohydrate, and fat) metabolism.

The hydrocarbon skeleton of cholesterol is also found in plant sterols, for example, **ergosterol**, a precursor of vitamin D (Figure 10.30). Ergosterol is converted in skin by ultraviolet irradiation to vitamin D₂. Vitamin D₂ is involved in calcium and phosphorus metabolism (Chapter 28).

Cholesterol Is Synthesized from Acetyl CoA

Although *de novo* biosynthesis of cholesterol occurs in virtually all cells, this capacity is greatest in liver, intestine, adrenal cortex, and reproductive tissues, including ovaries, testes, and placenta. From an inspection of its structure it is apparent that cholesterol biosynthesis will require a source of carbon atoms and considerable reducing power to generate the numerous carbon-carbon and carbon-hydrogen bonds. All carbon atoms of cholesterol are derived from acetate. Reducing power in the form of NADPH is provided mainly by glucose 6-phosphate dehydrogenase and 6-phosphogluconate dehydrogenase of the hexose monophosphate shunt (see p. 336). The pathway of cholesterol synthesis occurs in the cytosol and is driven in large part by hydrolysis of high-energy thioester bonds of acetyl CoA and phosphoanhydride bonds of ATP.

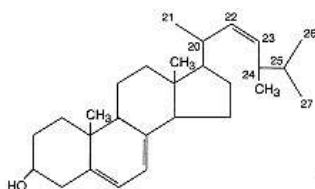
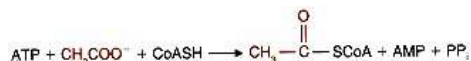

Figure 10.30
Structure of ergosterol.

Mevalonic Acid Is a Key Intermediate

The first compound unique to cholesterol biosynthesis is mevalonic acid derived from acetyl CoA. Acetyl CoA can be obtained from several sources: (1) the β -oxidation of fatty acids (Chapter 9); (2) the oxidation of ketogenic amino acids such as leucine and isoleucine (Chapter 11); and (3) the pyruvate dehydrogenase reaction. Free acetate can be activated to its thioester derivative at the expense of ATP by **acetylkinase**, also referred to as **acetate thiokinase**:



The first two reactions in cholesterol biosynthesis are shared by the pathway that produces ketone bodies (see p. 387). Two molecules of acetyl CoA condense to form acetoacetyl CoA in a reaction catalyzed by acetoacetyl CoA thiolase (acetyl CoA:acetyl CoA acetyltransferase):

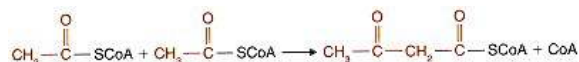

Formation of the carbon-carbon bond in acetoacetyl CoA in this reaction is favored energetically by cleavage of a thioester bond and generation of free coenzyme A.

The next step introduces a third molecule of acetyl CoA into the cholesterol pathway and forms the branched-chain compound **3-hydroxy-3-methylglutaryl CoA** (HMG CoA) (Figure 10.31). This condensation reaction is catalyzed by **HMG CoA synthase** (3-hydroxy-3-methylglutaryl CoA:acetoacetyl CoA lyase). Liver parenchymal cells contain two isoenzyme forms of HMG CoA synthase; one in the cytosol is involved in cholesterol synthesis, while the other has a mitochondrial location and functions in synthesis of ketone bodies (see p. 388). In the HMG CoA synthase reaction, an aldol condensation occurs between the methyl carbon of acetyl CoA and the β -carbonyl group of acetoacetyl CoA with the simultaneous hydrolysis of the thioester bond of acetyl CoA. The thioester bond in the original acetoacetyl CoA substrate molecule remains intact. HMG CoA can also be formed from oxidative degradation of the branched-chain amino acid leucine, through the intermediates 3-methylcrotonyl CoA and 3-methylglutaconyl CoA (Chapter 11).

The step that produces the unique compound mevalonic acid from HMG CoA is catalyzed by the important microsomal enzyme **HMG CoA reductase** (mevalonate:NAD⁺ oxidoreductase) that has an absolute requirement for NADPH as the reductant (Figure 10.32). This reductive step (1) consumes two molecules of NADPH, (2) results in hydrolysis of the thioester bond of HMG CoA, and (3) generates a primary alcohol residue in mevalonate. This reduction reaction is irreversible and produces (*R*)-(+)-mevalonate, which contains six carbon atoms. HMG CoA reductase catalyzes the rate-limiting reaction in the pathway of cholesterol biosynthesis. HMG CoA reductase is an intrinsic membrane protein of the endoplasmic reticulum whose carboxyl terminus extends into the cytosol and carries the enzyme's active site. Phosphorylation regulates

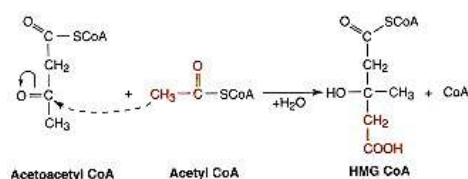

Figure 10.31
HMG CoA synthase reaction.

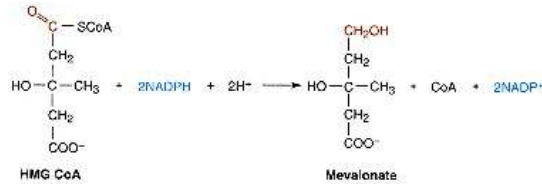

Figure 10.32
HMG CoA reductase reaction.

HMG CoA reductase activity of the cell by diminishing its catalytic activity (V_{max}) and enhancing the rate of its degradation by increasing its susceptibility to proteolytic attack. Increased amounts of intracellular cholesterol stimulate phosphorylation of HMG CoA reductase.

Mevalonic Acid Is a Precursor of Farnesyl Pyrophosphate

Reactions involved in conversion of mevalonate to **farnesyl pyrophosphate** are summarized in Figure 10.33. The stepwise transfer of the terminal γ -phosphate group from two molecules of ATP to mevalonate (A) to form 5-pyrophosphomevalonate (B) are catalyzed by mevalonate kinase (enzyme I) and phosphomevalonate kinase (enzyme II). The next step affects decarboxylation of 5-pyrophosphomevalonate and generates Δ^3 -isopentenyl pyrophosphate (D); this reaction is catalyzed by pyrophosphomevalonate decarboxylase. In this ATP-dependent reaction in which ADP, P_i , and CO_2 are produced, it is thought that decarboxylation–dehydration proceeds by way of the triphosphate intermediate, 3-phosphomevalonate 5-pyrophosphate (C). Isopentenyl pyrophosphate is converted to its allylic isomer 3,3-dimethylallyl pyrophosphate (E) in a reversible reaction catalyzed by isopentenyl pyrophosphate isomerase. The condensation of 3,3-dimethylallyl pyrophosphate (E) and Δ^3 -isopentenyl pyrophosphate (D) generates **geranyl pyrophosphate** (F).

The stepwise condensation of three C_5 isopentenyl units to form the C_{15} unit farnesyl pyrophosphate (G) is catalyzed by one enzyme, a cytoplasmic prenyl transferase called geranyltransferase.

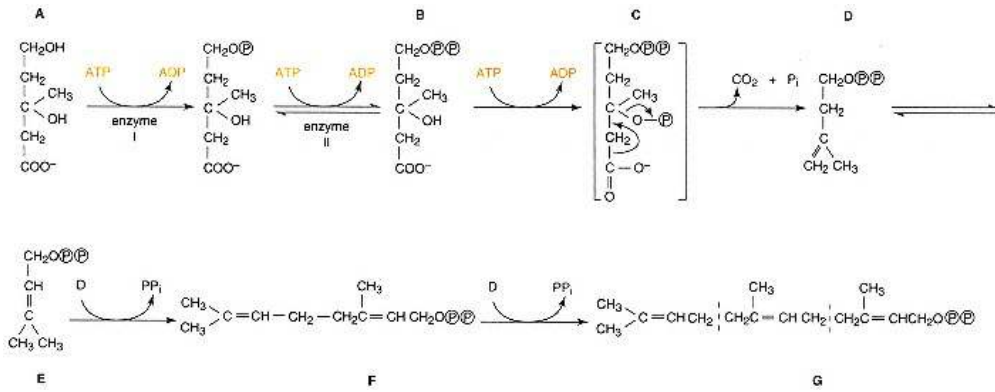

Figure 10.33
Formation of farnesyl pyrophosphate (F) from mevalonate (A).
Dotted lines divide molecules into isoprenoid-derived units. D is 3-isopentenyl pyrophosphate.

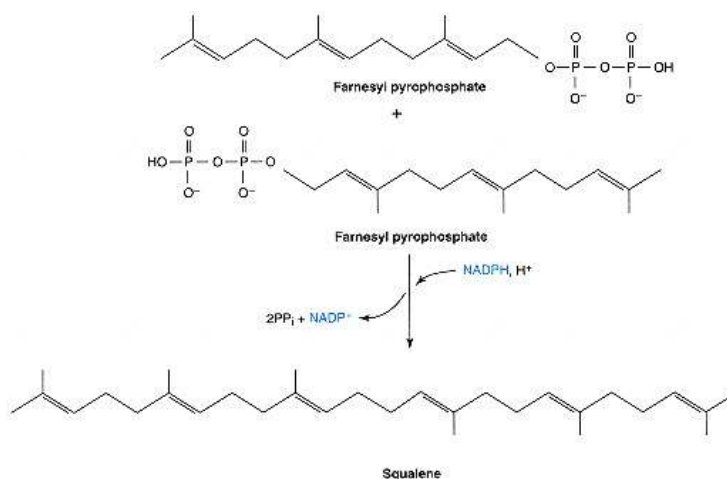

Figure 10.34

Formation of squalene from two molecules of farnesyl pyrophosphate.

Cholesterol Is Formed from Farnesyl Pyrophosphate via Squalene

The last steps in cholesterol biosynthesis involve "head-to-head" fusion of two molecules of farnesyl pyrophosphate to form **squalene** and finally cyclization of squalene to yield cholesterol. The reaction that produces the C₃₀ squalene molecule from two C₁₅ farnesyl pyrophosphate moieties (Figure 10.34) and is unlike the previous carbon-carbon bond-forming reactions in the pathway (Figure 10.33). **Squalene synthase**, present in the endoplasmic reticulum, releases two pyrophosphate groups, with loss of a hydrogen atom from one molecule of farnesyl pyrophosphate and replacement by a hydrogen from NADPH. Several different intermediates probably occur between farnesyl pyrophosphate and squalene. By rotation about carbon-carbon single bonds, the conformation of squalene indicated in Figure 10.35 can be obtained. Note the similarity of the overall shape of the compound to cholesterol and that squalene is devoid of oxygen atoms.

Cholesterol biosynthesis from squalene proceeds through the intermediate **lanosterol**, which contains the fused tetracyclic ring system and a C₈ side chain:

Squalene → squalene 2,3-epoxide → lanosterol

The many carbon-carbon bonds formed during cyclization of squalene are generated in a concerted fashion as indicated in Figure 10.36. The OH group

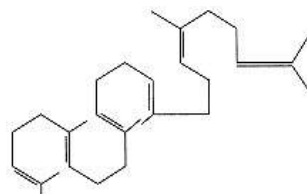

Figure 10.35

Structure of squalene, C₃₀.

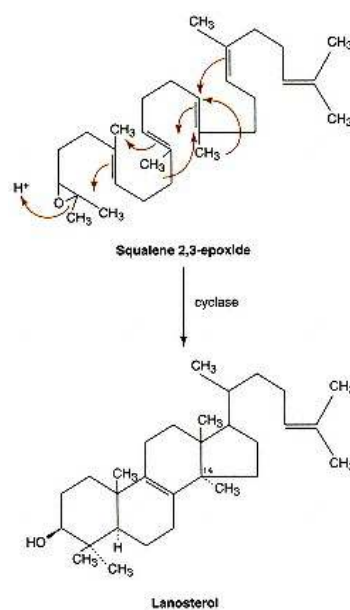

Figure 10.36

Conversion of squalene 2,3-epoxide to lanosterol.

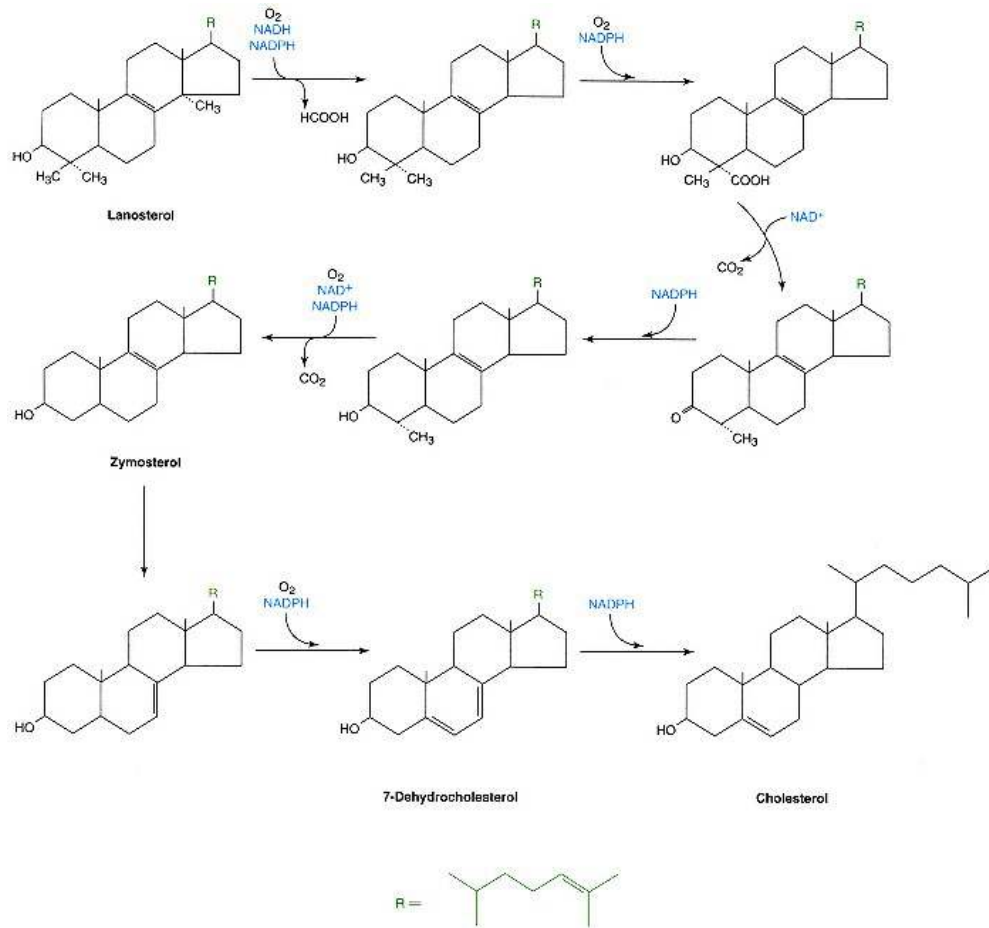
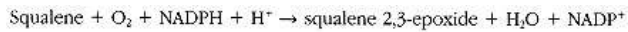

Figure 10.37
Conversion of lanosterol to cholesterol.

of lanosterol projects above the plane of the A ring; this is referred to as the β orientation. Groups that extend down below the ring in a trans relationship to the OH group are designated as α by a dotted line. During this reaction sequence an OH group is added to C-3, two methyl groups undergo shifts, and a proton is eliminated. The oxygen atom is derived from molecular oxygen. The reaction is catalyzed by an endoplasmic reticulum enzyme, **squalene oxidocyclase**, that is composed of at least two activities, squalene epoxidase or monooxygenase and a cyclase (lanosterol cyclase).

The cyclization process is initiated by epoxide formation at the expense of NADPH:



This reaction is catalyzed by the monooxygenase or epoxidase component. Hydroxylation at C-3 by way of the epoxide intermediate triggers the cyclization of squalene to form lanosterol (Figure 10.36). In the cyclization, two hydrogen atoms and two methyl groups migrate to neighboring positions.

Transformation of lanosterol to cholesterol involves many poorly understood steps and a number of different enzymes. These steps include: (1) removal of the methyl group at C-14; (2) removal of two methyl groups at C-4; (3) migration of the double bond from C-8 to C-5; and (4) reduction of the double bond between C-24 and C-25 in the side chain (see Figure 10.37).

Cholesterol Biosynthesis Is Carefully Regulated

The cholesterol pool of the body is derived from absorption of dietary cholesterol and biosynthesis primarily in liver and intestine. When the amount of dietary cholesterol is reduced, cholesterol synthesis is increased in liver and intestine to satisfy the needs of other tissues and organs. Cholesterol synthesized *de novo* is transported from liver and intestine to peripheral tissues in the form of lipoproteins. These are the only tissues that manufacture **apolipoprotein B**, the protein component of cholesterol transport proteins LDL and VLDL. Most apolipoprotein B is secreted into the circulation as VLDL, which is converted into LDL by removal of triacylglycerol and apolipoprotein C components, probably in plasma and liver. When the quantity of dietary cholesterol increases, cholesterol synthesis in liver and intestine is almost totally suppressed. Thus the rate of *de novo* cholesterol synthesis is inversely related to the amount of dietary cholesterol taken up by the body.

The primary site for control of cholesterol biosynthesis is HMG CoA reductase, which catalyzes the step that produces mevalonic acid. This is the committed step and the rate-limiting reaction in the pathway of cholesterol biosynthesis (Figure 10.38). Cholesterol effects feedback inhibition of its own synthesis by inhibiting the activity of preexisting HMG CoA reductase and also by promoting rapid inactivation of the enzyme by mechanisms that remain to be elucidated.

In a normal healthy adult on a low-cholesterol diet, about 1300 mg of cholesterol is returned to the liver each day for disposal. This cholesterol comes from cholesterol reabsorbed from the gut by means of the enterohepatic circulation and HDL, which carries cholesterol to the liver from peripheral tissues. Liver disposes of cholesterol by: (1) excretion in bile as free cholesterol and

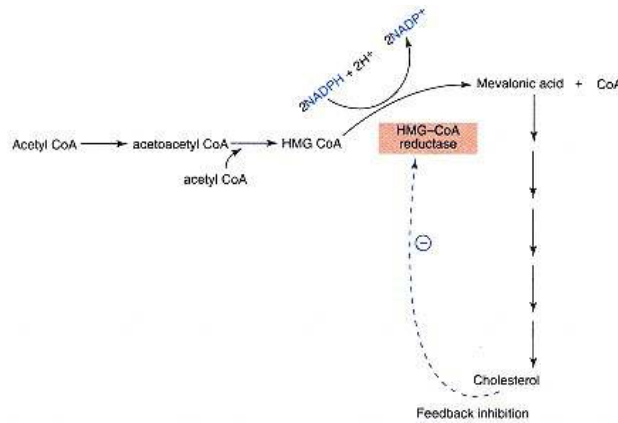

Figure 10.38
Summary of the pathway of cholesterol synthesis indicating feedback inhibition of HMG CoA reductase by cholesterol.

after conversion to bile salts; each day, about 250 mg of bile salts and 550 mg of cholesterol are lost from the enterohepatic circulation; (2) esterification and storage in liver as cholesterol esters; and (3) incorporation into lipoproteins (VLDL and LDL) and secretion into the circulation. On a low-cholesterol diet, liver will synthesize ~800 mg of cholesterol per day to replace bile salts and cholesterol lost from the enterohepatic circulation in the feces.

The mechanism of suppression of cholesterol biosynthesis by LDL-bound cholesterol involves specific **LDL receptors** that project from the surface of human cells. The first step of the regulatory mechanism involves the binding of the lipoprotein LDL to these LDL receptors, thereby extracting the LDL particles from the blood. The binding reaction is characterized by its saturability, high affinity, and high degree of specificity. The receptor recognizes only LDL and VLDL, the two plasma lipoproteins that contain apolipoprotein B-100. Once binding to receptor occurs at sites on the plasma membrane that contain pits coated with a protein called **clathrin**, the cholesterol-charged lipoprotein is endocytosed in the form of clathrin-coated vesicles. Intracellularly, the coated vesicle loses its clathrin and becomes an endosome (see p. 379). This process is termed **receptor-mediated endocytosis**. The next step involves the fusion of the endosome with a lysosome that contains numerous hydrolytic enzymes, including proteases and cholesterol esterase. The LDL receptor separates from LDL and returns to the cell surface. Inside the lysosome the cholesterol esters of LDL are hydrolyzed by cholesterol esterase to produce free cholesterol and a long-chain fatty acid. Free cholesterol then diffuses into the cytoplasm where, by some unknown mechanism, it inhibits the activity of HMG CoA reductase and suppresses the synthesis of HMG CoA reductase enzyme. There is evidence that cholesterol acts at the level of DNA and protein synthesis to decrease the rate of synthesis of HMG CoA reductase. At the same time, **fatty acyl CoA:cholesterol acyltransferase (ACAT)** in the endoplasmic reticulum is activated by cholesterol, promoting the formation of cholesterol esters, principally cholesterol oleate. Accumulation of intracellular cholesterol eventually inhibits the replenishment of LDL receptors on the cell surface, a phenomenon called **down regulation**, thereby blocking further uptake and accumulation of cholesterol.

The LDL receptor is a single-chain glycoprotein; numerous mutations in its gene are associated with familial hypercholesterolemia. The receptor spans the plasma membrane once with the carboxyl terminus on the cytoplasmic face and the amino terminus, which contains the LDL-binding site, extending into the extracellular space. **Apoprotein B-100** and **apoprotein E**, which is present in IDL (intermediate density lipoprotein) and some forms of HDL, are the two proteins through which particular lipoproteins bind to the LDL receptor.

CLINICAL CORRELATION 10.2

Treatment of Hypercholesterolemia

Many authorities recommend screening asymptomatic individuals by measuring plasma cholesterol. A level less than 200 mg% is considered desirable, and a level over 240 mg% requires lipoprotein analysis, especially determination of LDL cholesterol. Reduction of LDL cholesterol depends on dietary restriction of cholesterol to less than 300 mg day⁻¹, of calories to attain ideal body weight, and of total fat intake to less than 30% of total calories. Approximately two-thirds of the fat should be mono- or polyunsaturated. The second line of therapy is with drugs. Cholestyramine and colestipol are bile salt-binding drugs that promote excretion of bile salts in the stool. This in turn increases the rate of hepatic bile salt synthesis and of LDL uptake by the liver. Lovastatin is an inhibitor of HMG CoA reductase. Since this enzyme is limiting for cholesterol synthesis, lovastatin decreases endogenous synthesis of cholesterol and stimulates uptake and LDL via the LDL receptor. The combination of lovastatin and cholestyramine is sometimes used for severe hyperlipidemia.

Expert Panel. Evaluation and treatment of high blood cholesterol in adults. *Arch. Intern. Med.* 148:36, 1988.

The correlation between high levels of blood cholesterol, particularly LDL cholesterol, and heart attacks and strokes have led to the development of dietary and therapeutic approaches to lower blood cholesterol (see Clin. Corr. 10.2). Patients with **familial** (genetic) **hypercholesterolemia** suffer from accelerated atherosclerosis (see Clin. Corr. 10.3). In most cases, there is a lack of functional LDL receptors on the cell surface because the mutant alleles produce little or no LDL receptor protein; these patients are referred to as receptor-negative. In others the LDL receptor is synthesized and transported normally to the cell surface; an amino acid substitution or other alteration in the protein's primary structure, however, adversely affects the LDL-binding region of the receptor. As a result, there is little or no binding of LDL to the cell, cholesterol is not transferred into the cell, cholesterol synthesis is not inhibited, and the blood cholesterol level increases. Another LDL-deficient group of hypercholesterolemic patients is able to synthesize the LDL receptor but has a defect in the transport mechanism that delivers the glycoprotein to its proper location on the plasma membrane. And finally, there is another subclass of genetically determined hypercholesterolemics whose LDL receptors have a defect in the

cytoplasmic carboxyl terminus; they populate their cell surfaces with LDL receptors normally but are unable to internalize the LDL–LDL receptor complex due to an inability to cluster this complex in coated pits.

In specialized tissues such as the adrenal gland and ovary, the cholesterol derived from LDL serves as a precursor to the steroid hormones made by these organs, such as cortisol and estradiol, respectively. In liver, cholesterol extracted from LDL and HDL is converted into bile salts that function in intestinal fat digestion.

CLINICAL CORRELATION 10.3

Atherosclerosis

Atherosclerosis is the leading cause of death in Western industrialized countries. The risk of developing it is directly related to the plasma concentration of LDL cholesterol and inversely related to that of HDL cholesterol. This explains why the former is frequently called "bad" cholesterol and the latter "good" cholesterol, though chemically there is only one cholesterol. Atherosclerosis is a disorder of the arterial wall characterized by accumulation of cholesteryl esters in cells derived from the monocyte–macrophage line, smooth muscle cell proliferation, and fibrosis. The earliest abnormality is migration of blood monocytes to the subendothelium of the artery. Once there, they differentiate into macrophages. These cells accumulate cholesterol esters derived from plasma LDL. Why these cells do not regulate cellular cholesterol stores normally is not completely understood. Some of the LDL may be taken up via pathways distinct from the classical LDL receptor pathway. For instance, receptors that mediate uptake of acetylated LDL or LDL complexed with dextran sulfate have been described and these are not regulated by cellular cholesterol content. Distortion of the subendothelium leads to platelet aggregation on the endothelial surface and release of platelet-derived mitogens such as platelet-derived growth factor (PDGF). This is thought to stimulate smooth muscle cell growth. Death of the foam cells results in the accumulation of a cellular lipid that can stimulate fibrosis. The resulting atherosclerotic plaque narrows the blood vessel and serves as the site of thrombus formation, which precipitates myocardial infarction (heart attack).

Ross, R. The pathogenesis of atherosclerosis—an update. *N. Engl. J. Med.* 314:488, 1986.

Plasma Cholesterol Is in a Dynamic State

Plasma cholesterol is in a dynamic state, entering the blood complexed with lipoproteins that keep the lipid in solution and leaving the blood as tissues take up cholesterol from these lipoproteins. Plasma lipoproteins contain free cholesterol and cholesterol esterified to a long-chain fatty acid. From 70% to 75% of plasma cholesterol is esterified to long-chain fatty acids. It is the free, unesterified form of cholesterol that exchanges readily between different lipoproteins and the plasma membrane of cells.

The mechanism for entry of cholesterol into liver cells from the three types of plasma lipoprotein is quite different. While the metabolism of chylomicrons and LDL has been quite well defined, that of HDL is just beginning to be understood. Chylomicrons that have had their triacylglycerol content reduced by plasma lipoprotein lipase become chylomicron remnants, which are rich in dietary cholesterol (free and esterified) and in fat-soluble vitamins. They are taken up by receptor-mediated endocytosis into liver cells, as is LDL.

High-density lipoproteins and the enzyme **lecithin: cholesterol acyltransferase** (LCAT) play important roles in the elimination of cholesterol from the body. LCAT catalyzes the freely reversible reaction (Figure 10.39), which transfers the fatty acid in the *sn*-2 position of phosphatidylcholine to the 3-hydroxyl of cholesterol. LCAT is a plasma enzyme produced mainly by liver. The actual substrate for LCAT is cholesterol contained in HDL. The LCAT–HDL system functions to protect cells, especially their plasma membrane, from the damaging effects of excessive amounts of free cholesterol. Cholesterol ester generated in the LCAT reaction diffuses into the core of the HDL particle where it is then transported from the tissues and plasma to liver, the latter being the only organ capable of metabolizing and excreting cholesterol. Thus, by this mechanism, referred to as the reverse transport of cholesterol, LCAT acting on HDL provides a vehicle for transporting cholesterol from peripheral tissues to the liver.

Cholesterol Is Excreted Primarily As Bile Acids

The bile acids are the end products of cholesterol metabolism. Primary bile acids are synthesized in hepatocytes directly from cholesterol. The most abundant bile

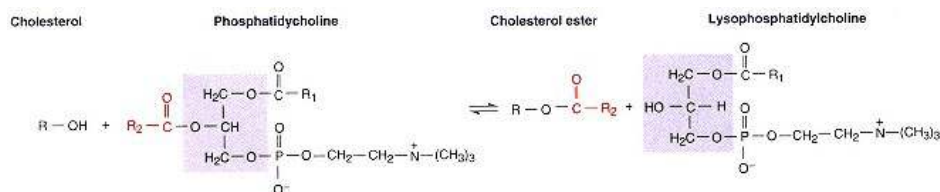

Figure 10.39
Lecithin:cholesterol acyltransferase (LCAT) reaction, where R—OH indicates cholesterol.

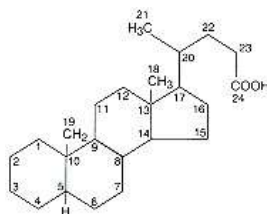

Figure 10.40
Structure of cholic acid.

acids in humans are derivatives of cholic acid (Figure 10.40), that is, **cholic acid** and **chenodeoxycholic acid** (Figure 10.41). The primary bile acids are composed of 24 carbon atoms, contain two or three OH groups, and have a side chain that ends in a carboxyl group that is ionized at pH 7.0 (hence the name bile salt). The carboxyl group of the bile acids is often conjugated via an amide bond to either glycine ($\text{NH}_2\text{-CH}_2\text{-COOH}$) or taurine ($\text{NH}_2\text{-CH}_2\text{-CH}_2\text{-SO}_3\text{H}$) to form **glycocholic** or **taurocholic acid**, respectively. The structure of glycocholic acid is shown in Figure 10.42.

When the primary bile acids undergo chemical reactions by microorganisms in the gut, they give rise to secondary bile acids that also possess 24 carbon atoms. Examples of secondary bile acids are deoxycholic acid and lithocholic acid, which are derived from cholic acid and chenodeoxycholic acid, respectively, by the removal of one OH group (Figure 10.41). Transformation of cholesterol to bile acids requires: (1) epimerization of the 3β -OH group; (2) reduction of the C-5 double bond; (3) introduction of OH groups at C-7 (chenodeoxycholic acid) or at C-7 and C-12 (cholic acid); and (4) conversion of the C-27 side chain into a C-24 carboxylic acid by elimination of a propyl equivalent.

Bile acids are secreted into bile canaliculi, specialized channels formed by adjacent hepatocytes. Bile canaliculi unite with bile ductules, which in turn come together to form bile ducts. The bile acids are carried to the gallbladder for storage and ultimately to the small intestine where they are excreted. The capacity of liver to produce bile acids is insufficient to meet the physiological demands, so the body relies on an efficient **enterohepatic circulation** that carries the bile acids from the intestine back to the liver several times each day. The primary conjugated bile acids, after removal of the glycine or taurine residue in the gut, are reabsorbed by an active transport process from the intestine, primarily in the ileum, and returned to the liver by way of the portal vein. Bile acids that are not reabsorbed are acted on by bacteria in the gut and converted into secondary bile acids; a portion of secondary bile acids, primarily deoxycholic acid and lithocholic acid, are reabsorbed passively in the colon and

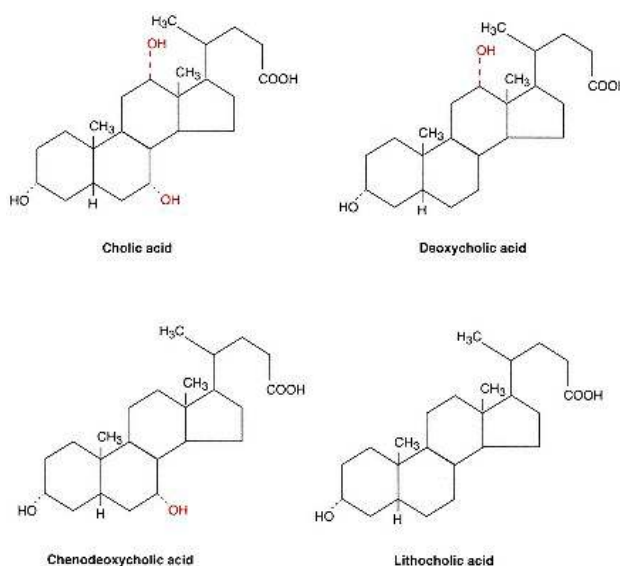

Figure 10.41
Structures of some common bile acids.

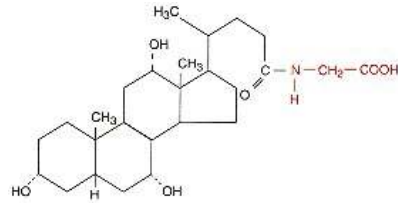

Figure 10.42
Structure of glycocholic acid, a conjugated bile acid.

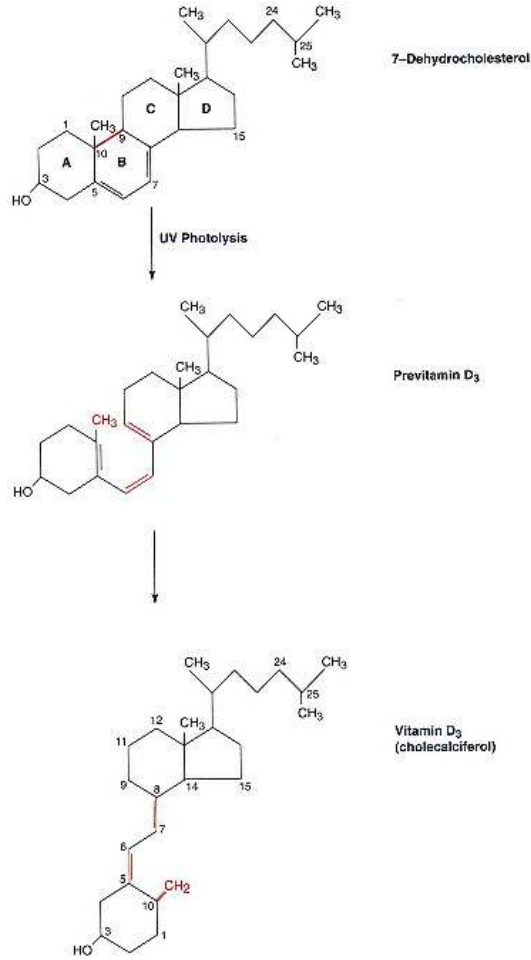

Figure 10.43
Photochemical conversion of 7-dehydrocholesterol to vitamin D₃ (cholecalciferol).

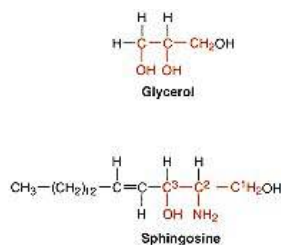

Figure 10.44
Comparison of the structures of
glycerol and sphingosine
(*trans*-1,3, dihydroxy-2- amino-
4- octadecene).

returned to the liver where they are secreted into the gallbladder. Hepatic synthesis normally produces 0.2–0.6 g of bile acids per day to replace those lost in the feces. The gallbladder pool of bile acids is 2–4 g. Because the enterohepatic circulation recycles 6–12 times each day, the total amount of bile acids absorbed per day from the intestine corresponds to 12–32 g.

Bile acids are significant in medicine for several reasons. They represent the only significant way in which cholesterol can be excreted; the carbon skeleton of cholesterol is not oxidized to CO_2 and H_2O in humans but is excreted in bile as free cholesterol and bile acids. Bile acids prevent the precipitation of cholesterol out of solution in the gallbladder. Bile acids and phospholipids function to solubilize cholesterol in bile and act as emulsifying agents to prepare dietary triacylglycerols for hydrolysis by pancreatic lipase. Bile acids may also play a direct role in activating pancreatic lipase (see Chapter 25) and they facilitate the absorption of fat-soluble vitamins, particularly vitamin D, from the intestine.

Vitamin D Is Synthesized from an Intermediate of Cholesterol Biosynthesis

Cholesterol biosynthesis provides substrate for the photochemical production of **vitamin D₃** in skin. The metabolism and function of vitamin D₃ are discussed in Chapter 27. Vitamin D₃ is a secosteroid in which the 9,10 carbon bond of the B ring of the cholesterol nucleus has undergone fission (Figure 10.43). The most important supply of vitamin D₃ is that manufactured in the skin. **7-Dehydrocholesterol** is an intermediate in the pathway of cholesterol biosynthesis and is converted in the skin to provitamin D₃ by irradiation with UV rays of the sun (285–310 nm). Provitamin D₃ is biologically inert and labile and converted thermally and slowly (~36 h) to the double-bond isomer by a nonenzymatic reaction to the biologically active vitamin, cholecalciferol (vitamin D₃). As little as 10-min exposure each day of the hands and face to sunlight will satisfy the body's need for vitamin D. Photochemical action on the plant sterol ergosterol also provides a dietary precursor to a compound designated **vitamin D₂ (calciferol)** that can satisfy the vitamin D requirement.

10.4— Sphingolipids

Biosynthesis of Sphingosine

Sphingolipids are complex lipids whose core structure is provided by the long-chain amino alcohol **sphingosine** (Figure 10.44) (4-sphingenine or *trans*-1,3-dihydroxy-2-amino-4-octadecene). Sphingosine has two asymmetric carbon atoms (C-2 and C-3); of the four possible optical isomers, naturally occurring sphingosine is of the D-erythro form. The double bond of sphingosine has the *trans* configuration. The primary alcohol group at C-1 is a nucleophilic center that forms covalent bonds with sugars to form glycosphingolipids and phosphocholine to form sphingomyelin. The amino group at C-2 always bears a long-

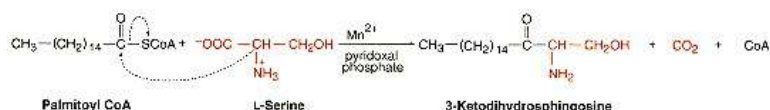

Figure 10.45
Formation of 3-ketodihydrosphingosine from serine and palmitoyl CoA.

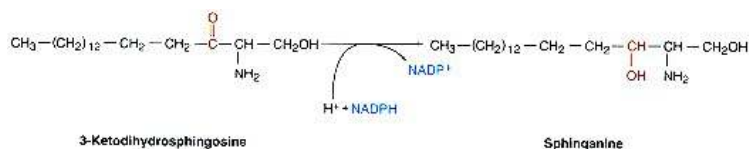

Figure 10.46
Conversion of 3-ketodihydrospingosine to sphinganine.

chain fatty acid (usually C_{20} – C_{26}) in amide linkage. The secondary alcohol at C-3 is always free. It is useful to appreciate the structural similarity of a part of the sphingosine molecule to the glycerol moiety of the acylglycerols (Fig. 10.44).

Sphingolipids are present in blood and nearly all body tissues. The highest concentrations are found in the white matter of the central nervous system. Various sphingolipids are components of the plasma membrane of practically all cells.

Sphingosine is synthesized by way of **sphinganine** (dihydrospingosine) in two steps from the precursors serine and palmitoyl CoA. Serine is the source of C-1, C-2, and the amino group of sphingosine, while palmitic acid provides the remaining carbon atoms. Condensation of serine and palmitoyl CoA is catalyzed by a pyridoxal phosphate-dependent enzyme, serine palmitoyltransferase. The driving force for the reaction is provided by both cleavage of the reactive, high-energy thioester bond of palmitoyl CoA and the release of CO_2 from serine (Figure 10.45). The next step involves the reduction of the carbonyl group in 3-ketodihydrospingosine with reducing equivalents being derived from NADPH to produce sphinganine (Figure 10.46). The insertion of the double bond into sphinganine to produce sphingosine occurs at the level of ceramide (see below).

Ceramides Are Fatty Acid Amide Derivatives of Sphingosine

Sphingosine does not occur naturally. The core structure of the natural sphingolipids is **ceramide**, a long-chain fatty acid amide derivative of sphingosine. The long-chain fatty acid is attached to the 2-amino group of sphingosine through an amide bond (Figure 10.47). Most often the acyl group is **behenic acid**, a saturated C22 fatty acid, but other long-chain acyl groups can be used. There are two long-chain hydrocarbon domains in the ceramide molecule; these hydrophobic regions are responsible for the lipid character of sphingolipids.

Ceramide is synthesized from dihydrospingosine and a molecule of long-chain fatty acyl CoA by a microsomal enzyme with dihydroceramide as an intermediate that is then oxidized by dehydrogenation at C-4 and C-5 (Figure 10.48). Free ceramide is not a component of membrane lipids but rather is an intermediate in the biosynthesis and catabolism of glycosphingolipids and sphingomyelin. Structures of prominent sphingolipids of humans are presented in Figure 10.49 in diagrammatic form.

Sphingomyelin Is the Only Sphingolipid Containing Phosphorus

Sphingomyelin, a major structural lipid of membranes of nervous tissue, is the only sphingolipid that is a phospholipid. In sphingomyelin the primary alcohol at C-1 of sphingosine is esterified to choline through a phosphodiester bridge of the kind that occurs in the acyl glycerophospholipids and the amino group of sphingosine is attached to a long-chain fatty acid by an amide bond. Sphingomyelin is therefore a ceramide phosphocholine. It contains one negative

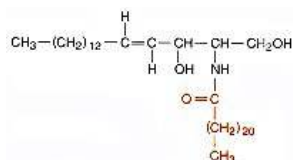

Figure 10.47
Structure of a ceramide
(N-acylsphingosine).

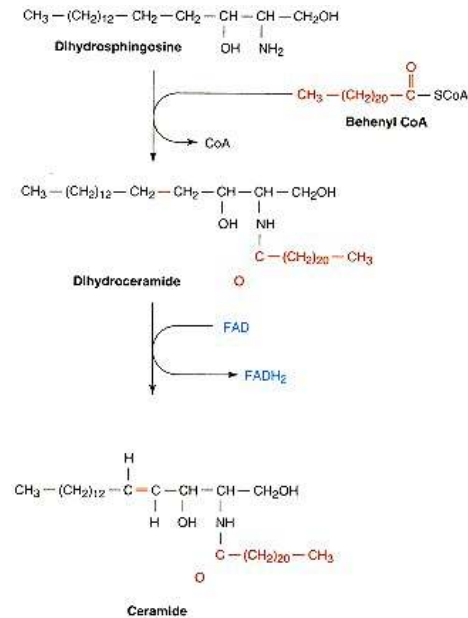

Figure 10.48
Formation of ceramide from dihydrosphingosine.

and one positive charge so that it is neutral at physiological pH (Figure 10.50). The most common fatty acids in sphingomyelin are palmitic (16:0), stearic (18:0), lignoceric (24:0), and nervonic acid (24:1). The sphingomyelin of myelin contains predominantly longer chain fatty acids, mainly lignoceric and nervonic, whereas that of gray matter contains largely stearic acid. Excessive accumulations of sphingomyelin occur in Niemann–Pick disease.

Sphingomyelin Is Synthesized from a Ceramide and Phosphatidylcholine

Conversion of ceramide to sphingomyelin involves transfer of a phosphocholine moiety from phosphatidylcholine (lecithin), not from CDP–choline as was suspected for many years; this reaction is catalyzed by **sphingomyelin synthase** (Figure 10.51).

Glycosphingolipids Usually Have a Galactose or Glucose Unit

The principal glycosphingolipid classes are cerebrosides, sulfatides, globosides, and gangliosides. In the glycolipid class of compounds the polar head group is attached to sphingosine via the glycosidic linkage of a sugar molecule rather than a phosphate ester bond, as in phospholipids.

Cerebrosides Are Glycosylceramides

Cerebrosides are ceramide monohexosides; the two most common are **galactocerebroside** and **glucocerebroside**. Unless specified otherwise, the term cerebroside usually refers to galactocerebroside, also called "**galactolipid**." In Figure 10.52 note that the monosaccharide units are attached at C-1 of the sugar

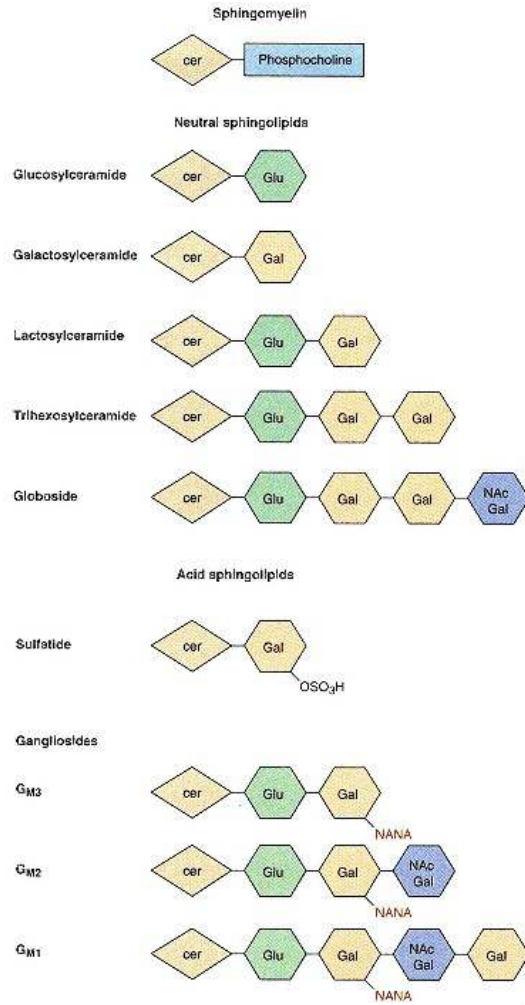

Figure 10.49

Structures of some common sphingolipids in diagrammatic form.

Cer, ceramide; Glu, glucose; Gal, galactose; NAcGal, *N*-acetyl-galactosamine; and NANA, *N*-acetylneuraminic acid (sialic acid).

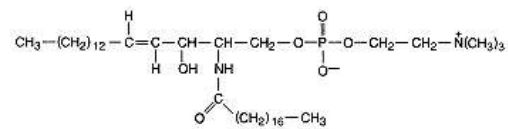

Figure 10.50

Structure of sphingomyelin.

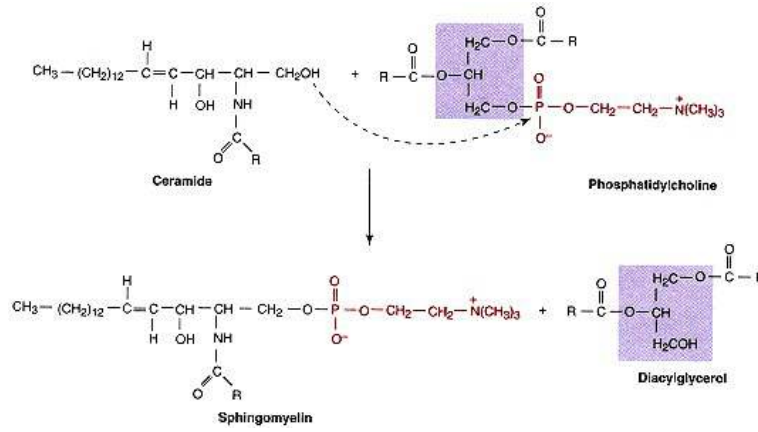

Figure 10.51
Sphingomyelin synthesis from ceramide and phosphatidylcholine.

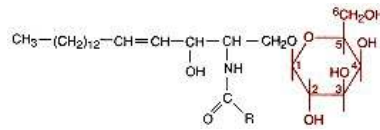

Figure 10.52
Structure of galactocerebroside (galactolipid).

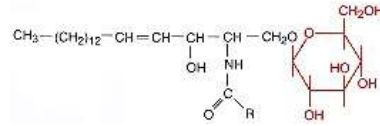

Figure 10.53
Structure of glucocerebroside.

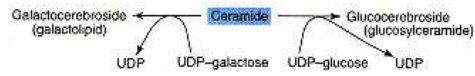

Figure 10.54
Synthesis of galacto- and glucocerebroside.

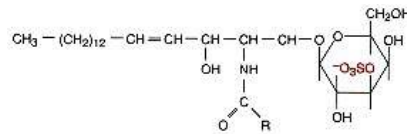

Figure 10.55
Structure of galactocerebroside sulfate (sulfolipid).

moiety to the C-1 position of ceramide, and the anomeric configuration of the glycosidic bond between ceramide and hexose in both galactocerebroside and glucocerebroside is β . The largest amount of galactocerebroside in healthy individuals is found in the brain. Moderately increased amounts of galactocerebroside accumulate in the white matter in Krabbe's disease, also called globoid leukodystrophy, due to a deficiency in the lysosomal enzyme galactocerebrosidase.

Glucocerebroside (glucosylceramide) is not normally a component of membranes but is an intermediate in the synthesis and degradation of more complex glycosphingolipids (see Figure 10.53). However, 100-fold increases or more in the glucocerebroside content of spleen and liver occur in the genetic lipid storage disorder called Gaucher's disease, which results from a deficiency of lysosomal glucocerebrosidase.

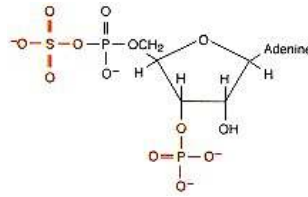
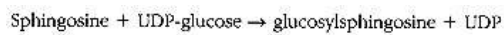
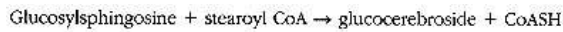

Figure 10.56
Structure of PAPS (3-phosphoadenosine 5-phosphosulfate).

Galactocerebroside and glucocerebroside are synthesized from ceramide and the activated nucleotide sugars UDP-galactose and UDP-glucose, respectively. The enzymes that catalyze these reactions, **glucosyl** and **galactosyl-transferases**, are associated with the endoplasmic reticulum (Figure 10.54). In some tissues, the synthesis of glucocerebroside (glucosylceramide) proceeds by glucosylation of sphingosine catalyzed by glucosyltransferase:



followed by fatty acylation:



Sulfatide Is a Sulfuric Acid Ester of Galactocerebroside

Sulfatide, or **sulfogalactocerebroside**, is a sulfuric acid ester of galactocerebroside. Galactocerebroside 3-sulfate is the major sulfolipid in brain and accounts for approximately 15% of the lipids of white matter (see Figure 10.55). Galactocerebroside sulfate is synthesized from galactocerebroside and 3-phosphoadenosine 5-phosphosulfate (PAPS) in a reaction catalyzed by sulfotransferase:

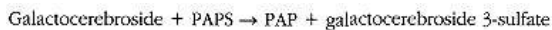

The structure of PAPS, sometimes referred to as "activated sulfate," is indicated in Figure 10.56. Large quantities of sulfatide accumulate in the central nervous system in metachromatic leukodystrophy due to a deficiency of a specific lysosomal sulfatase.

Globosides Are Ceramide Oligosaccharides

Globosides are cerebroside that contain two or more sugar residues, usually galactose, glucose, or *N*-acetylgalactosamine. The ceramide oligosaccharides are neutral compounds and contain no free amino groups. Lactosylceramide is a component of the erythrocyte membrane (Figure 10.57). Another prominent globoside is **ceramide trihexoside** or ceramide galactosyllactoside: ceramide- β -glc(4 1)- β -gal(4 1)- α -gal. Note that the terminal galactose residue of this globoside has the α -anomeric configuration. Ceramide trihexoside accumulates in kidneys of patients with Fabry's disease who are deficient in lysosomal α -galactosidase A.

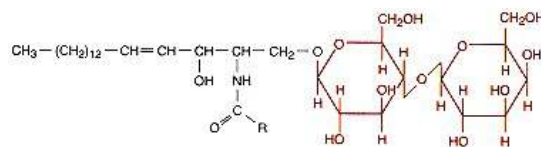

Figure 10.57
Structure of ceramide- β -glc(4 1)- β -gal (lactosylceramide).

Gangliosides Contain Sialic Acid

Gangliosides are sialic acid-containing glycosphingolipids highly concentrated in the ganglion cells of the central nervous system, particularly in the nerve endings. The central nervous system is unique among human tissues because more than one-half of the sialic acid is in ceramide-lipid bound form, with the remainder of the sialic acid occurring in the oligosaccharides of glycoproteins. Lesser amounts of gangliosides are present in the surface membranes of the cells of most extraneural tissues, where they account for less than 10% of the total sialic acid.

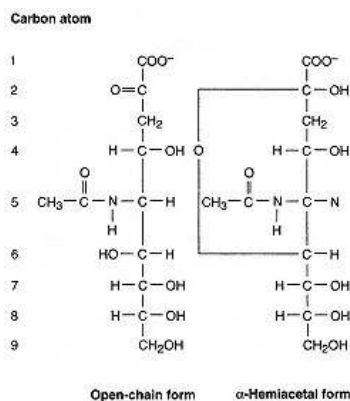

Figure 10.58
Structure of N-acetylneuraminic acid (NANA).

Neuraminic acid (abbreviated Neu) is present in gangliosides, glycoproteins, and mucins. The amino group of neuraminic acid occurs most often as the *N*-acetyl derivative, and the resulting structure is called ***N*-acetylneuraminic acid** or **sialic acid**, commonly abbreviated NANA (see Figure 10.58). The OH group on C-2 occurs most often in the α -anomeric configuration and the linkage between NANA and the oligosaccharide ceramide always involves the OH group on position 2 of *N*-acetylneuraminic acid. Structures of some common gangliosides are indicated in Table 10.1. The principal gangliosides in brain are G_{M1} , G_{D1a} , G_{D1b} , and G_{T1b} . Nearly all gangliosides of the body are derived from the family of compounds originating with glucosylceramide. In the nomenclature of

TABLE 10.1 Structures of Some Common Gangliosides

Code Name	Chemical Structure
G_{M3}	Gal β → 4Glc β → Cer 3 ↑ α NANA
G_{M2}	GalNAc β → 4Gal β → 4Glc β → Cer 3 ↑ α NANA
G_{M1}	Gal β → 3GalNAc β → 4Gal β → 4Glc β → Cer 3 ↑ α NANA
G_{D1a}	Gal β → 3GalNAc β → 4Gal β → 4Glc β → Cer 3 3 ↑ ↑ α NANA α NANA
G_{D1b}	Gal β → 3GalNAc β → 4Gal β → 4Glc β → Cer 3 ↑ α NANA β ← α NANA
G_{T1a}	Gal β → 3GalNAc β → 4Gal β → 4Glc β → Cer 3 3 ↑ ↑ α NANA β ← α NANA α NANA
G_{T1b}	Gal β → 3GalNAc β → 4Gal β → 4Glc β → Cer 3 3 ↑ ↑ α NANA α NANA β ← α NANA
G_{Q1b}	Gal β → 3GalNAc β → 4Gal β → 4Glc β → Cer 3 3 ↑ ↑ α NANA β ← α NANA α NANA β ← α NANA

the sialoglycosphingolipids, the letter G refers to the name ganglioside. The subscripts M, D, T, and Q indicate mono-, di-, tri-, and quatra (tetra)-sialic acid-containing gangliosides and subscripts 1, 2, and 3 designate the carbohydrate sequence that is attached to ceramide as indicated as follows: 1, Gal-GalNAc-Gal-Glc-ceramide; 2, GalNAc-Gal-Glc-ceramide; and 3, Gal-Glc-ceramide. Consider the nomenclature of the Tay–Sachs ganglioside; the designation G_{M_2} denotes the ganglioside structure shown in Table 10.1.

A specific ganglioside on intestinal mucosal cells mediates the action of cholera toxin, a protein of mol wt 84,000, secreted by the pathogen *Vibrio cholerae*. The toxin stimulates the secretion of chloride ions into the gut lumen, resulting in the severe diarrhea characteristic of cholera. Two kinds of subunits, A and B, comprise the cholera toxin; there is one copy of the A subunit (28,000 Da) and five copies of the B subunit (~ 11,000 Da each). After binding to the cell surface membrane through a domain on the B subunit, the active subunit A passes into the cell. There it acts as an **ADP-ribosyltransferase** and transfers ADP-ribose of NAD^+ on to the G_{α_s} subunit of a G-protein on the cytoplasmic side of the cell membrane (see p. 859). This leads to activation of adenylate cyclase. The cAMP generated stimulates chloride ion transport and produces diarrhea. The cholera toxin domain, as the B subunits are called, binds to the **ganglioside G_{M_1}** that has the structure shown in Table 10.1.

Gangliosides are also thought to be receptors for other toxins, such as tetanus toxin, and certain viruses, such as the influenza viruses. There is also speculation that gangliosides play an informational role in cell–cell interactions by providing specific recognition determinants on the surface of cells. There are several lipid storage disorders that involve the accumulation of sialic acid-containing glycosphingolipids. The two most common gangliosidoses involve the storage of the gangliosides G_{M_1} (G_{M_1} gangliosidosis) and G_{M_2} (Tay–Sachs disease). G_{M_1} gangliosidosis is an autosomal recessive metabolic disease characterized by impaired psychomotor function, mental retardation, hepatosplenomegaly, and death within the first few years of life. The massive cerebral and visceral accumulation of G_{M_1} ganglioside is due to a marked deficiency of β -galactosidase.

Sphingolipidoses Are Lysosomal Storage Diseases with Defects in the Catabolic Pathway for Sphingolipids

Sphingolipids are normally degraded within lysosomes of phagocytic cells, particularly the histiocytes or macrophages of the reticuloendothelial system located primarily in liver, spleen, and bone marrow. Degradation of the sphingolipids by visceral organs begins with the engulfment of the membranes of white cells and erythrocytes that are rich in lactosylceramide (Cer-Glc-Gal) and hematoside (Cer-Glc-Gal-NANA). In the brain, the majority of the cerebroside-type lipids are gangliosides. Particularly during the neonatal period, ganglioside turnover in the central nervous system is extensive so that glycosphingolipids are rapidly being broken down and resynthesized. The pathway of sphingolipid catabolism is summarized in Figure 10.59. Note that among the various sphingolipids that comprise this pathway, there occurs a sulfate ester (in sulfolipid or sulfogalactolipid); *N*-acetylneuraminic acid groups (in the gangliosides); an α -linked galactose residue (in ceramide trihexoside); several β -galactosides (in galactocerebroside and G_{M_1}); the ganglioside G_{M_2} , which terminates in a β -linked *N*-acetylgalactosamine unit; and glucocerebroside, which is composed of a single glucose residue attached to ceramide through a β linkage. The phosphodiester bond in sphingomyelin is broken to produce ceramide, which in turn is converted in sphingosine by the cleavage of an amide bond to a long-chain fatty acid. This overall pathway of sphingolipid catabolism is composed of a series of enzymes that cleave specific bonds in the compounds including α - and β -galactosidases, a β -glucosidase, a neuraminidase, a

sphingomyelin-specific phosphodiesterase (sphingomyelinase), a sulfate esterase (sulfatase), and a ceramide-specific amidase (ceramidase). The important features of the sphingolipid catabolic pathway are as follows: (1) all the reactions take place within the lysosome; that is, the enzymes of the pathway are contained in lysosomes; (2) the enzymes are hydrolases; therefore one of the substrates in each reaction is water; (3) the pH optimum of each of the hydrolases is in the acid range, pH 3.5–5.5; (4) most of the enzymes are relatively stable and occur as isoenzymes; for example, **hexosaminidase** occurs in two forms: hexosaminidase A (HexA) and hexosaminidase B (HexB); (5) the hydrolases that comprise the sphingolipid pathway are glycoproteins and often occur firmly bound to the lysosomal membrane; and (6) the pathway is composed of intermediates that differ by only one sugar molecule, a sulfate group, or a fatty acid residue. The substrates are converted to products by the sequential, stepwise removal of constituents such as sugars and sulfate, by hydrolytic, irreversible reactions.

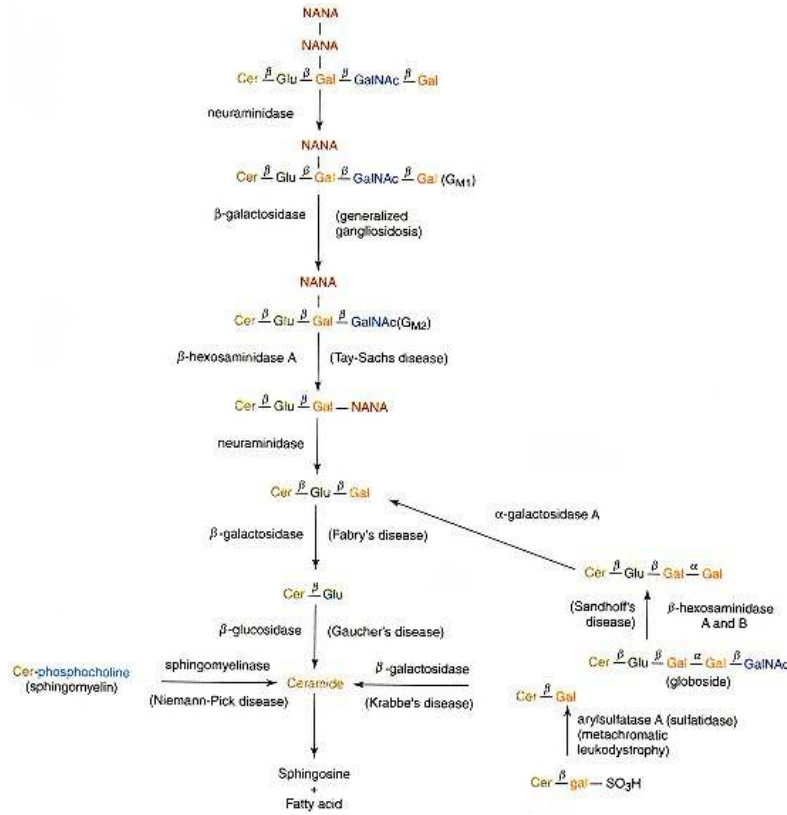

Figure 10.59
Summary of the pathways for catabolism of sphingolipids by lysosomal enzymes.
 The genetically determined enzyme deficiency diseases are indicated in parentheses.

TABLE 10.2 Sphingolipid Storage Diseases of Humans

<i>Disorder</i>	<i>Principal Signs and Symptoms</i>	<i>Principal Storage Substance</i>	<i>Enzyme Deficiency</i>
1. Tay-Sachs disease	Mental retardation, blindness, cherry red spot on macula, death between second and third year	Ganglioside G _{M2}	Hexosaminidase A
2. Gaucher's disease	Liver and spleen enlargement, erosion of long bones and pelvis, mental retardation in infantile form only	Glucocerebroside	Glucocerebrosidase
3. Fabry's disease	Skin rash, kidney failure, pains in lower extremities	Ceramide trihexoside	-Galactosidase A
4. Niemann–Pick disease	Liver and spleen enlargement, mental retardation	Sphingomyelin	Sphingomyelinase
5. Globoid leukodystrophy (Krabbe's disease)	Mental retardation, absence of myelin	Galactocerebroside	Galactocerebrosidase
6. Metachromatic leukodystrophy	Mental retardation, nerves stain yellowish brown with cresyl violet dye (metachromasia)	Sulfatide	Arylsulfatase A
7. Generalized gangliosidosis	Mental retardation, liver enlargement, skeletal involvement	Ganglioside G _{M1}	G _{M1} ganglioside: β -galactosidase
8. Sandhoff–Jatzkewitz disease	Same as 1; disease has more rapidly progressing course	G _{M2} ganglioside, globoside	Hexosaminidase A and B
9. Fucosidosis	Cerebral degeneration, muscle spasticity, thick skin	Pentahexosylfucoglycolipid	-L-Fucosidase

In most cases, sphingolipid catabolism functions smoothly, and all of the various complex glycosphingolipids and sphingomyelin are degraded to the level of their basic building blocks, namely, sugars, sulfate, fatty acid, phosphocholine, and sphingosine. However, when the activity of one of the hydrolytic enzymes is markedly reduced due to a genetic error, then the substrate for the defective or missing enzyme accumulates and is deposited within the lysosomes of the tissue responsible for the catabolism of that sphingolipid. For most of the reactions in Figure 10.59, patients have been identified who lack the enzyme that normally catalyzes that reaction. These disorders, called **sphingolipidoses**, are summarized in Table 10.2.

We can generalize about some of the common features of **lipid storage diseases**: (1) usually only a single sphingolipid accumulates in the involved organs; (2) the ceramide portion is common to the various storage lipids; (3) the rate of biosynthesis of the accumulating lipid is normal; (4) a catabolic enzyme is missing in each of these disorders; and (5) the extent of the enzyme deficiency is the same in all tissues.

Diagnostic Enzyme Assays for Sphingolipidoses

Diagnosis of a given sphingolipidosis can be made from a biopsy of the involved organ, usually bone marrow, liver, or brain, on morphologic grounds on the basis of the highly characteristic appearance of the storage lipid within lysosomes. Assay of enzyme activity is used to confirm the diagnosis of a particular lipid storage disease. Of great practical value is the fact that, for most of the diseases, peripheral leukocytes, cultured skin fibroblasts, and chorionic villi express the relevant enzyme deficiency and can be used as a source of enzyme for diagnostic purposes. In some cases (e.g., Tay–Sachs disease) serum and even tears are a source of enzyme for the diagnosis of a lipid storage disorder. Sphingolipidoses, for the most part, are autosomal recessive, with the disease occurring only in homozygotes with a defect in both alleles. Enzyme assays can identify carriers or heterozygotes.

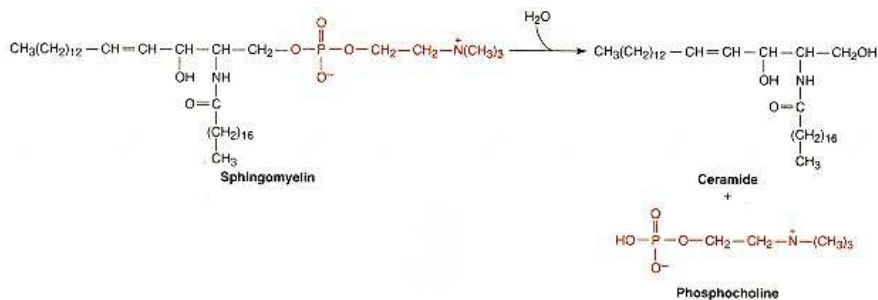

Figure 10.60
Sphingomyelinase reaction.

In **Niemann–Pick disease**, the deficient enzyme is **sphingomyelinase**, which normally catalyzes the reaction shown in Figure 10.60. Sphingomyelin, radiolabeled in the methyl groups of choline with carbon-14, provides a useful substrate for determining sphingomyelinase activity. Extracts of white blood cells from healthy, appropriate controls will hydrolyze the labeled substrate and produce the water-soluble product, phosphocholine. Extraction of the final incubation medium with an organic solvent such as chloroform will result in radioactivity in the upper, aqueous phase; the unused, lipid-like substrate sphingomyelin will be found in the chloroform phase. On the other hand, if the white blood cells were derived from a patient with Niemann–Pick disease, then after incubation with labeled substrate and extraction with chloroform, little or no radioactivity (i.e., phosphocholine) would be found in the aqueous phase and the diagnosis would be confirmed.

CLINICAL CORRELATION 10.4

Diagnosis of Gaucher's Disease in an Adult

Gaucher's disease is an inherited disease of lipid catabolism that results in deposition of glucocerebroside in macrophages of the reticuloendothelial system. Because of the large numbers of macrophages in spleen, bone marrow, and liver, hepatomegaly, splenomegaly and its sequelae (thrombocytopenia or anemia), and bone pain are the most common signs and symptoms of the disease.

Gaucher's disease results from a deficiency of glucocerebrosidase. Although this enzyme deficiency is inherited, different clinical patterns are observed. Some patients suffer severe neurologic deficits as infants, while others do not exhibit symptoms until adulthood. The diagnosis can be made by assaying leukocytes or fibroblasts for their ability to hydrolyze the β -glycosidic bond of artificial substrates (β -glucosidase activity) or of glucocerebroside (glucocerebrosidase activity). Gaucher's disease has been treated with regular infusions of purified glucocerebrosidase and the long-term efficacy of the therapy looks encouraging.

Brady, R. O., Kanfer, J. N., Bradley, R. M., and Shapiro, D. Demonstration of a deficiency of glucocerebroside-cleaving enzyme in Gaucher's disease. *J. Clin. Invest.* 45:1112, 1966.

Another disease that can be diagnosed by use of an artificial substrate is **Tay–Sachs disease**, the most common form of **G_{M2} gangliosidosis**. In this fatal disorder the ganglion cells of the cerebral cortex are swollen and the lysosomes are engorged with the acidic lipid, G_{M2} ganglioside. This results in a loss of ganglion cells, proliferation of glial cells, and demyelination of peripheral nerves. The pathognomonic finding is a cherry red spot on the macula caused by swelling and necrosis of ganglion cells in the eye. In Tay–Sachs disease, the commercially available artificial substrate 4-methylumbelliferyl- β -N-acetyl-glucosamine is used to confirm the diagnosis. The compound is hydrolyzed by hexosaminidase A, the deficient lysosomal hydrolase, to produce the intensely fluorescent product 4-methylumbelliferone (Figure 10.61). Unfortunately, the diagnosis may be confused by the presence of hexosaminidase B in tissue extracts and body fluids. This enzyme is not deficient in the Tay–Sachs patient and will hydrolyze the test substrate, thereby confusing the interpretation of results. The problem is usually resolved by taking advantage of the relative heat lability of hexosaminidase A and heat stability of hexosaminidase B. The tissue extract or serum specimen to be tested is first heated at 55°C for 1 h and then assayed for hexosaminidase activity. The amount of heat-labile activity is a measure of hexosaminidase A, and this value is used in making the diagnosis.

Enzyme assays of serum or extracts of tissues, peripheral leukocytes, and fibroblasts have proved useful in heterozygote detection. Once carriers of a lipid storage disease have been identified, or if there has been a previously affected child in a family, the pregnancies at risk for these diseases can be monitored. All nine of the lipid storage disorders are transmitted as recessive genetic abnormalities. In all but one the allele is carried on an autosomal chromosome. Fabry's disease is linked to the X chromosome. In all of these conditions statistically one of four fetuses will be homozygous (or hemizygous in Fabry's disease), two fetuses will be carriers, and one will be completely

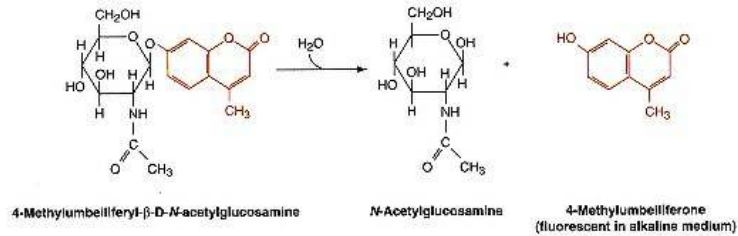

Figure 10.61
-Hexosaminidase reaction.

normal. The enzyme assays have been used to detect affected fetuses and carriers *in utero*, using cultured fibroblasts obtained by amniocentesis as a source of enzyme.

Except for Gaucher's disease, there is no therapy for the sphingolipidoses; the role of medicine at present is prevention through genetic counseling based on enzyme assays of the type discussed above. A discussion of the diagnosis and therapy of **Gaucher's disease** is presented in Clin. Corr. 10.4.

10.5— Prostaglandins and Thromboxanes

Prostaglandins and Thromboxanes Are Derivatives of Twenty-Carbon, Monocarboxylic Acids

In mammalian cells two major pathways of arachidonic acid metabolism produce important mediators of cellular and bodily functions: the **cyclooxygenase** and the **lipoxygenase pathways**. The substrate for both pathways is unesteri-

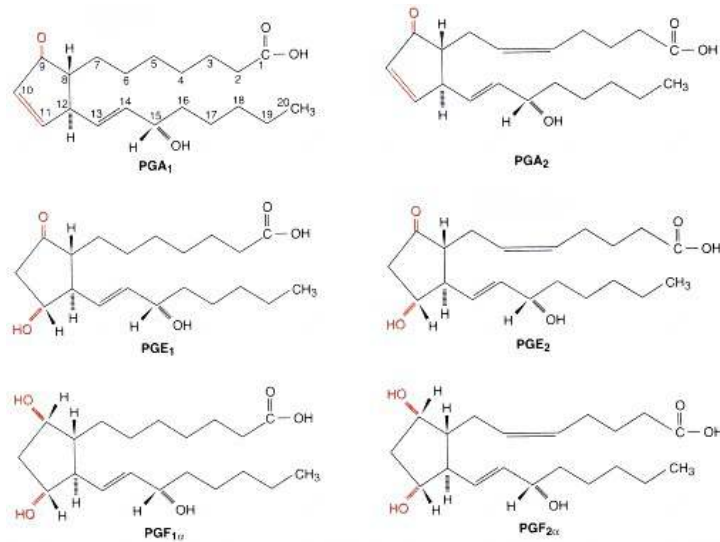

Figure 10.62
Structures of the major prostaglandins.

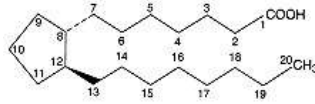

Figure 10.63
Structure of prostanoic acid.

fied arachidonic acid. The cyclooxygenase pathway leads to a series of compounds including prostaglandins and thromboxanes. Prostaglandins were discovered through their effects on smooth muscle, specifically their ability to promote the contraction of intestinal and uterine muscle and the lowering of blood pressure. Although the complexity of their structures and the diversity of their sometimes conflicting functions often create a sense of frustration, the potent pharmacological effects of the prostaglandins have afforded them an important place in human biology and medicine. With the exception of the red blood cell, the prostaglandins are produced and released by nearly all mammalian cells and tissues; they are not confined to specialized cells. Unlike most hormones, prostaglandins are not stored in cells but instead are synthesized and released immediately.

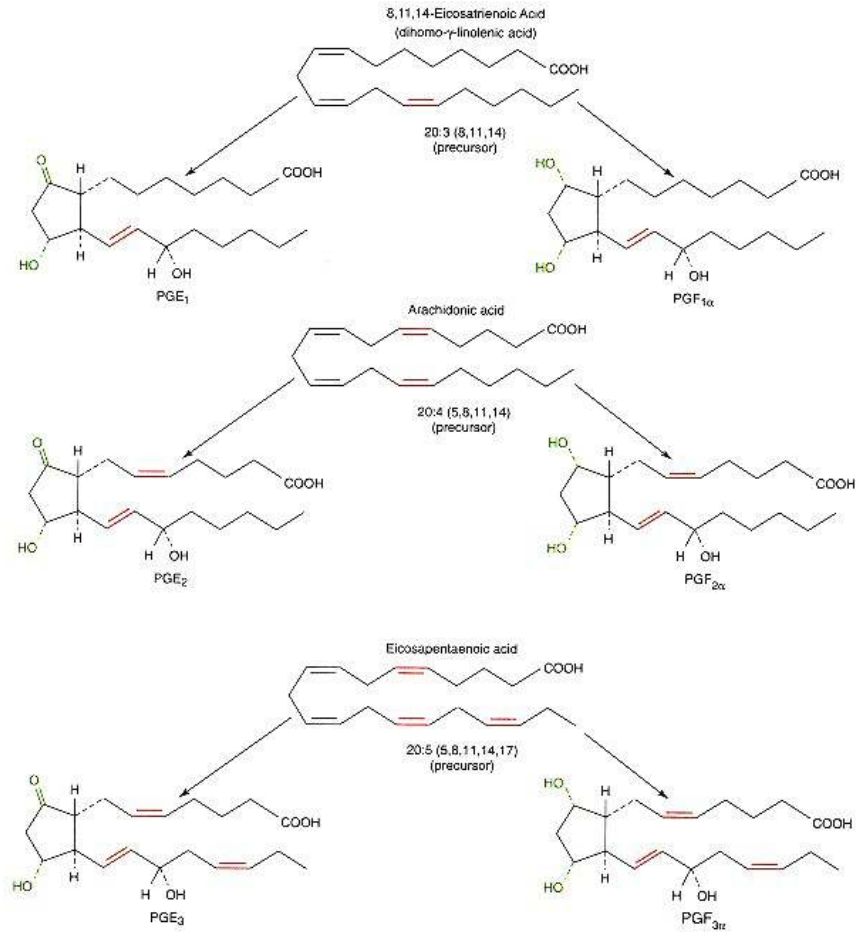

Figure 10.64
Synthesis of E and F prostaglandins from fatty acid precursors.

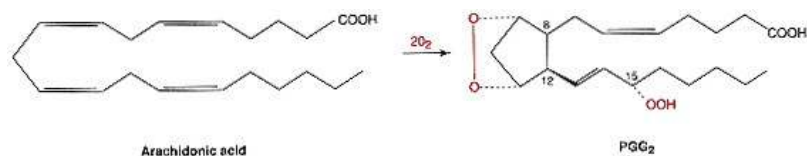

Figure 10.65
Cyclooxygenase reaction.

There are three major classes of primary **prostaglandins**, the **A**, **E**, and **F** series. The structures of the more common prostaglandins A, E, and F are shown in Figure 10.62 (p. 431). All are related to the hypothetical parent compound, prostanoic acid (Figure 10.63). Note that the prostaglandins contain a multiplicity of functional groups; for example, PGE₂ contains a carboxyl group, a β -hydroxyketone, a secondary alkylic alcohol, and two carbon–carbon double bonds. The three classes (A, E, and F) are distinguished on the basis of the functional groups about the cyclopentane ring (Figure 10.64): the E series contains a β -hydroxyketone, the F series are 1,3-diols, and those in the A series are $\alpha\beta$ -unsaturated ketones. The subscript numerals 1, 2, and 3, refer to the number of double bonds in the side chains. The subscript α refers to the configuration of the C-9 OH group: an α -hydroxyl group projects "down" from the plane of the ring.

The most important dietary precursor of the prostaglandins is linoleic acid (18:2), which is an essential fatty acid. In adults linoleic acid is ingested daily in amounts of about 10 g. Only a very minor part of this total intake is converted by carbon chain elongation and desaturation in liver to arachidonic acid (eicosatetraenoic acid) and to some extent also to dihomo- γ -linolenic acid. Since the total daily excretion of prostaglandins and their metabolites is only about 1 mg, it is clear that the formation of prostaglandins is a quantitatively unimportant pathway in the overall metabolism of fatty acids. At the same time, however, the metabolism of prostaglandins is completely dependent on a regular and constant supply of linoleic acid. When the diet is deficient in linoleic acid, there is decreased production of prostaglandins. The diet also provides arachidonic acid.

Synthesis of Prostaglandins Involves a Cyclooxygenase

The immediate precursors to the prostaglandins are C₂₀ polyunsaturated fatty acids containing 3, 4, and 5 carbon–carbon double bonds. Since **arachidonic acid** and most of its metabolites contain 20 carbon atoms, they are referred to as **eicosanoids**. During their transformation into various prostaglandins they are cyclized and take up oxygen. Dihomo- γ -linolenic acid (20:3(8,11,14)) is the precursor to PGE₁ and PGF_{1 α} ; arachidonic acid (20:4(5,8,11,14)) is the precursor to PGE₂ and PGF_{2 α} ; and eicosapentaenoic acid (20:4(5,8,11,14,17)) is the precursor to PGE₃ and PGF_{3 α} (see Figure 10.64).

Compounds of the 2-series derived from arachidonic acid are the principal prostaglandins in humans and are of the greatest significance biologically. The

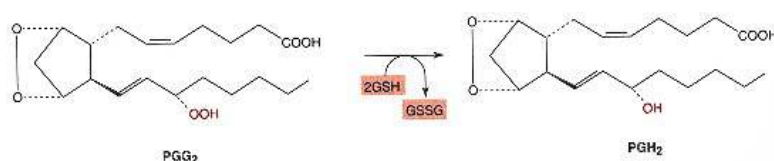

Figure 10.66
Conversion of PGG₂ to PGH₂; PG hydroperoxidase (PGH synthase) reaction.

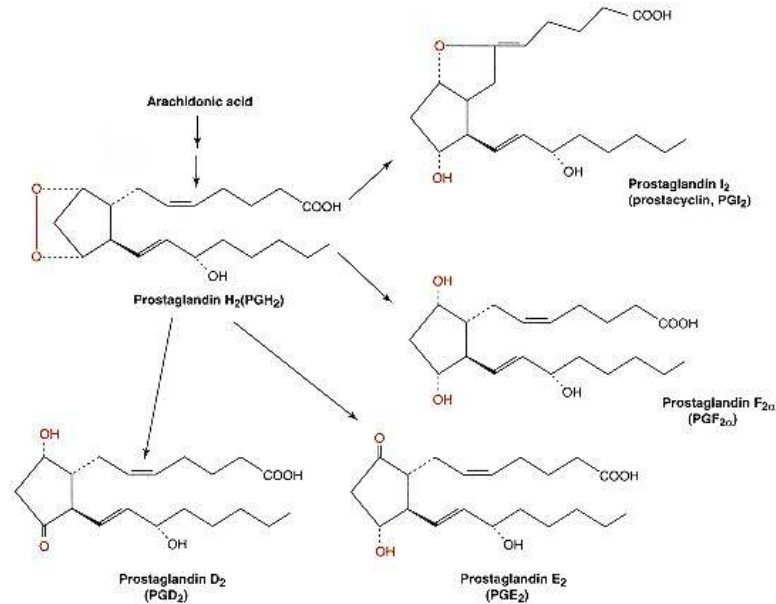

Figure 10.67
Major routes of prostaglandin biosynthesis.

central enzyme system in prostaglandin biosynthesis is the **prostaglandin synthase (PGS) complex**, which catalyzes oxidative cyclization of polyunsaturated fatty acids. Arachidonic acid is derived from membrane phospholipids by the action of the hydrolase **phospholipase A₂**. This cleavage step is the rate-limiting step in prostaglandin synthesis and some agents that stimulate prostaglandin production act by stimulating the activity of phospholipase A₂. Cholesterol esters containing arachidonic acid may also serve as a source of arachidonic acid substrate.

The **cyclooxygenase** component of the prostaglandin synthase complex catalyzes the cyclization of C-8–C-12 of arachidonic acid to form the cyclic 9,11-endoperoxide 15-hydroperoxide, PGG₂. The reaction requires two molecules of oxygen (Figure 10.65; see p. 433). PGG₂ is then converted to prostaglandin H₂ (PGH₂) by a reduced **glutathione (GSH)-dependent peroxidase** (PG hydroperoxidase) (Figure 10.66; see p. 433). Details of the additional steps leading to individual prostaglandins remain to be elucidated. Reactions that cyclize polyunsaturated fatty acids are found in the membranes of the endoplasmic reticulum. Major pathways of prostaglandin biosynthesis are summarized in Figure 10.67. Formation of primary prostaglandins of the D, E, and F series and of thromboxanes or prostacyclin (PGI₂) is mediated by different specific enzymes, whose presence varies depending on the cell type and tissue. This results in a degree of tissue specificity as to the type and quantity of prostaglandin produced. In kidney and spleen PGE₂ and PGF_{2α} are the major prostaglandins formed. In contrast, blood vessels produce mostly PGI₂ and PGF_{2α}. In the heart PGE₂, PGF_{2α}, and PGI₂ are formed in about equal amounts. Thromboxane A₂ (TXA₂) is the main prostaglandin endoperoxide formed in platelets.

There are two forms of cyclooxygenase (COX) or **prostaglandin synthase (PGS)**. COX-1, or PGS-1, is a constitutive enzyme found in gastric mucosa,

platelets, vascular endothelium, and kidney. COX-2, or PGS-2, is inducible and is generated in response to inflammation. It is expressed mainly in activated macrophages and monocytes when they are stimulated by platelet-activating factor (PAF), interleukin-1, or bacterial lipopolysaccharide (LPS), and in smooth muscle cells, epithelial and endothelial cells, and neurons. PGS-2 induction is inhibited by glucocorticoids. The two forms of PGS catalyze both oxygenation of arachidonic acid to PGG_2 and the reduction of PGG_2 to PGH_2 , which is the peroxidase reaction.

Prostaglandins have a very short half-life. Soon after release they are rapidly taken up by cells and inactivated either by oxidation of the 15-hydroxy group or by β -oxidation from the C_1 -COOH end of the fatty acid chain. The lungs appear to play an important role in inactivating prostaglandins.

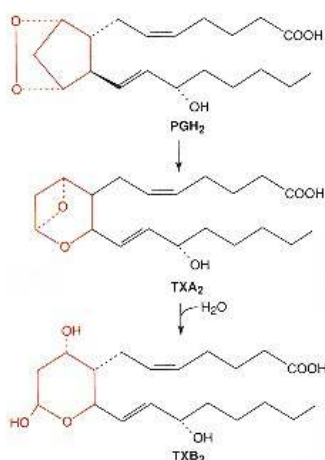

Figure 10.68
Synthesis of TXB_2 from PGH_2 .

Thromboxanes are highly active metabolites of the PGG_2 - and PGI_2 -type prostaglandin endoperoxides that have the cyclopentane ring replaced by a six-membered oxygen-containing (oxane) ring. The term thromboxane is derived from the fact that these compounds have a thrombus-forming potential. **Thromboxane A synthase**, present in the endoplasmic reticulum, is abundant in lung and platelets and catalyzes conversion of endoperoxide PGH_2 to TXA_2 . The half-life of TXA_2 is very short in water ($t_{1/2} \sim 1$ min) as the compound is transformed rapidly into inactive thromboxane B_2 (TXB_2) by the reaction shown in Figure 10.68.

Prostaglandin Production Is Inhibited by Steroidal and Nonsteroidal Anti-inflammatory Agents

Two types of drugs affect prostaglandin metabolism and are therapeutically useful. The **nonsteroidal, anti-inflammatory drugs (NSAIDs)**, such as aspirin (acetylsalicylic acid), indomethacin, and phenylbutazone, block prostaglandin production by inhibiting cyclooxygenase. In the case of aspirin, irreversible inhibition occurs by acetylation of the enzyme. Other NSAIDs inhibit cyclooxygenase but do so by binding noncovalently to the enzyme instead of acetylating it; they are called "non-aspirin NSAIDs." Certain NSAIDs inhibit COX-1 more than COX-2 and vice versa. These drugs are not without their undesirable side effects; aplastic anemia can result from phenylbutazone therapy. **Steroid anti-inflammatory drugs** like hydrocortisone, prednisone, and betamethasone block prostaglandin release by inhibiting phospholipase A_2 activity so as to interfere with mobilization of arachidonic acid (see Figure 10.69). The rate-limiting step in the synthesis of prostaglandins is release of arachidonic acid from membrane phospholipid stores in response to phospholipase A_2 activation.

Factors that govern the biosynthesis of prostaglandins are poorly understood, but, in general, prostaglandin release seems to be triggered following hormonal or neural excitation or after muscular activity. For example, histamine stimulates an increase in the prostaglandin concentration in gastric perfusates. Also, prostaglandins are released during labor and after cellular injury (e.g., platelets exposed to thrombin, lungs irritated by dust).

Prostaglandins Exhibit Many Physiological Effects

Prostaglandins are natural mediators of **inflammation**. Inflammatory reactions most often involve the joints (rheumatoid arthritis), skin (psoriasis), and eyes, and inflammation of these sites is frequently treated with corticosteroids that inhibit prostaglandin synthesis. Administration of PGE_2 or PGE_1 induce the signs of inflammation that include redness and heat (due to arteriolar vasodilation) and swelling and edema resulting from increased capillary permeability. PGE_2 generated in immune tissues (e.g., macrophages, mast cells, B cells) evokes chemokinesis of T cells. PGE_2 in amounts that alone do not cause **pain**, prior to administration of the autocooids, histamine and bradykinin, enhance both the intensity and duration of pain caused by these two agents. It is thought that

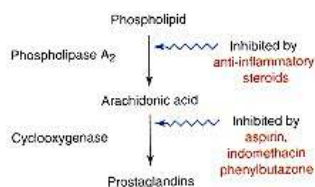

Figure 10.69
Site of action of inhibitors of prostaglandin synthesis.

pyrogens (**fever**-inducing agents) activate the prostaglandin biosynthetic pathway resulting in release of PGE₂ in the region of the hypothalamus where body temperature is regulated. Aspirin, which is an antipyretic drug, acts by inhibiting cyclooxygenase. The prostaglandins have been used extensively as drugs in **reproduction**. Both PGE₂ and PGF₂ have been used to induce parturition and for the termination of an unwanted pregnancy, specifically in the second trimester. There is also evidence that the PGE series of prostaglandins may play some role in infertility in males.

Synthetic prostaglandins have proved to be very effective in inhibiting **gastric acid secretion** in patients with **peptic ulcers**. The inhibitory effect of PGE compounds appears to be due to inhibition of cAMP formation in gastric mucosal cells. Prostaglandins also accelerate the healing of gastric ulcers. Prostaglandins play an important role in controlling blood vessel tone and arterial **blood pressure**. The vasodilator prostaglandins, PGE, PGA, and PGI₂, lower systemic arterial pressure, thereby increasing local blood flow and decreasing peripheral resistance. TXA₂ causes contraction of vascular smooth muscle and glomerular mesangium. There is hope that the prostaglandins may eventually prove useful in the treatment of hypertension. PGE₂ functions in the fetus to maintain the patency of the **ductus arteriosus** prior to birth. If the ductus remains open after birth, closure can be hastened by administration of the cyclooxygenase inhibitor indomethacin. In other situations it may be desirable to keep the ductus open. For example, in infants born with congenital abnormalities where the defect can be corrected surgically, infusion of prostaglandins will maintain blood flow through the ductus over this interim period.

Certain prostaglandins, especially PGI₂, inhibit **platelet aggregation**, whereas PGE₂ and TXA₂ promote this clotting process. TXA₂ is produced by platelets and accounts for the spontaneous aggregation that occurs when platelets contact some foreign surface, collagen, or thrombin. Endothelial cells lining blood vessels release PGI₂ and this may account for the lack of adherence of platelets to the healthy blood vessel wall. PGE₂ and PGD₂ dilate renal blood vessels and increase blood flow through the kidney. They also regulate sodium secretion and glomerular filtration rate.

10.6—

Lipoxygenase and Oxy-Eicosatetraenoic Acids

Cyclooxygenase directs polyunsaturated fatty acids into the prostaglandin pathway. Another equally important arachidonic acid-oxygenating enzyme, called **lipoxygenase**, is a dioxygenase. Actually, there is a family of lipoxygenases that differ in the position of the double bond on the arachidonic acid molecule at which oxygen attack initially occurs (e.g., positions 5, 11, or 15). In humans the most important leukotrienes are the 5-lipoxygenase products that are involved in the mediation of inflammatory disorders.

Monohydroperoxyeicosatetraenoic Acids Are Products of Lipoxygenase Action

The products of the lipoxygenase reaction, which arise by addition of hydroperoxy groups to arachidonic acid, are designated **monohydroperoxyeicosatetraenoic acids** (HPETEs). Figure 10.70 shows the conversion of arachidonic acid to the three major HPETEs. Thus, in contrast to the cyclooxygenase of prostaglandin endoperoxide synthase, which catalyzes the bis-dioxygenation of unsaturated fatty acids to endoperoxides, lipoxygenases catalyze the monodioxygenation of unsaturated fatty acids to allylic hydroperoxides. Hydroperoxy substitution of arachidonic acid by lipoxygenases may occur at position 5, 12, or 15. 5-HPETE is the major lipoxygenase product in basophils, polymorphonuclear (PMN) leukocytes, macrophages, mast cells, and any organ undergoing

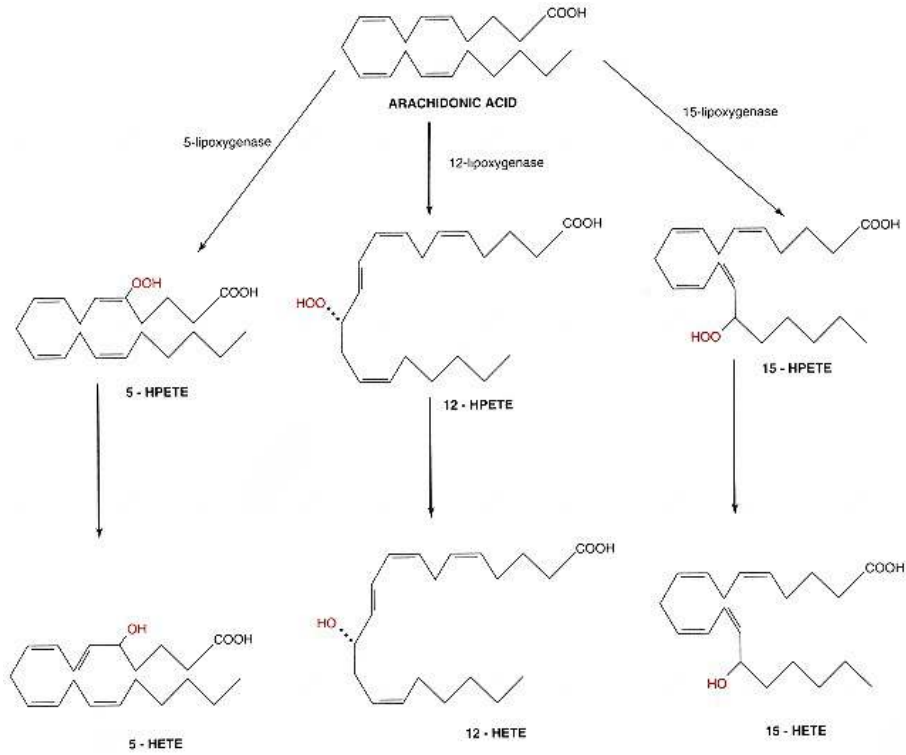

Figure 10.70

Lipoygenase reaction and role of 5-hydroperoxyeicosatetraenoic acids (HPETEs) as precursors of hydroxyeicosatetraenoic acids (HETEs).

an inflammatory response; 12-HPETE predominates in platelets, pancreatic endocrine islet cells, vascular smooth muscle, and glomerular cells; 15-HPETE is the principal lipoygenase product in reticulocytes, eosinophils, T-lymphocytes, and tracheal epithelial cells. The 5-, 12-, and 15-lipoygenases occur mainly in the cytosol. Specific stimuli or signals determine which type of lipoygenase product a given type of cell produces. The oxygenated carbon atom in HPETEs is asymmetric and there are two possible stereoisomers of the hydroperoxy acid, (*R*) or (*S*). All three major HPETEs are of the (*S*) configuration. 5-Lipoygenase (5-LO) exhibits both a dioxygenase activity that converts arachidonic acid to 5-HPETE and a dehydrase activity that transforms 5-HPETE to LTA_4 . 5-LO activity is restricted to a few cell types, including B lymphocytes but not T lymphocytes. It is activated by an accessory protein called 5-lipoygenase activating protein.

Leukotrienes and Hydroxyeicosatetraenoic Acids Are Hormones Derived from HPETEs

HPETE-hydroperoxides are not hormones, but are highly reactive, unstable intermediates that are converted either to the analogous alcohol (hydroxy fatty

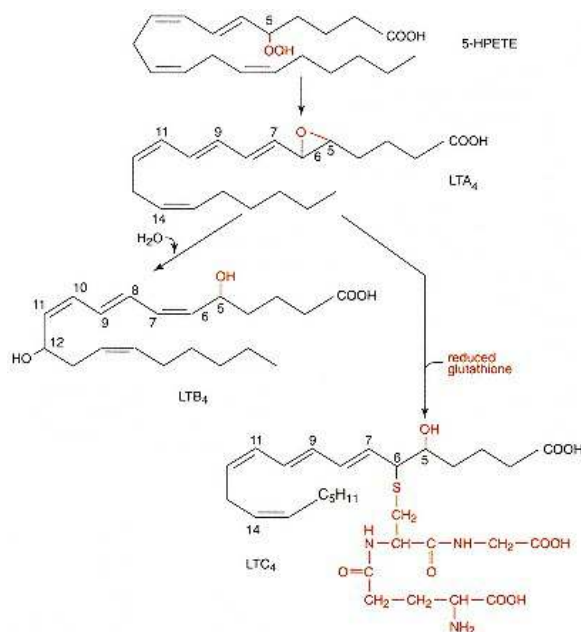

Figure 10.71

Conversion of 5-HPETE to LTB₄ and LTC₄ through LTA₄ as Intermediate.

acid) by reduction of the peroxide moiety or to leukotrienes. Leukotrienes are lipoxygenase products containing at least three conjugated double bonds. Figure 10.71 shows how 5-HPETE rearranges to the epoxide **leukotriene A₄** (LTA₄), which is then converted to LTB₄ or LTC₄, emphasizing that 5-HPETE occurs at an important branch point in the lipoxygenase pathway.

Peroxidative reduction of 5-HPETE to the stable **5-hydroxyeicosatetraenoic acid** (5-HETE) is illustrated in Figure 10.70. Note that the double bonds in 5-HETE occur at positions 6, 8, 11, and 14, and that they are unconjugated and that the geometry of the double bonds is trans, cis, cis, and cis, respectively. Two other common forms of HETE are 12- and 15-HETE. The HPETEs are reduced either spontaneously or by the action of peroxidases to the corresponding HETEs.

Leukotrienes are derived from the unstable precursor 5-HPETE by a reaction catalyzed by **LTA₄ synthase** that generates an epoxide called LTA₄. In the leukotriene series, the subscript indicates the number of double bonds. Thus, while double-bond rearrangement may occur, the number of double bonds in the leukotriene product is the same as in the original arachidonic acid. LTA₄ occurs at a branch point (Figure 10.71) and can be converted either to 5,12-dihydroxyeicosatetraenoic acid (designated leukotriene B₄ or LTB₄) or to LTC₄ and LTD₄.

Conversion of 5-HPETE to the diol LTB₄ (Figure 10.71) is catalyzed by a cytosolic enzyme, **LTB₄ synthase** (LTA₄ hydrolase), which adds water to the double bond between C-11 and C-12. The diversion of LTA₄ to leukotrienes LTC₄, LTD₄, and LTE₄ requires the participation of reduced glutathione that opens the epoxide ring in LTA₄ to produce LTC₄ (Figure 10.71). Sequential removal of glutamic acid and glycine residues by specific dipeptidases yields

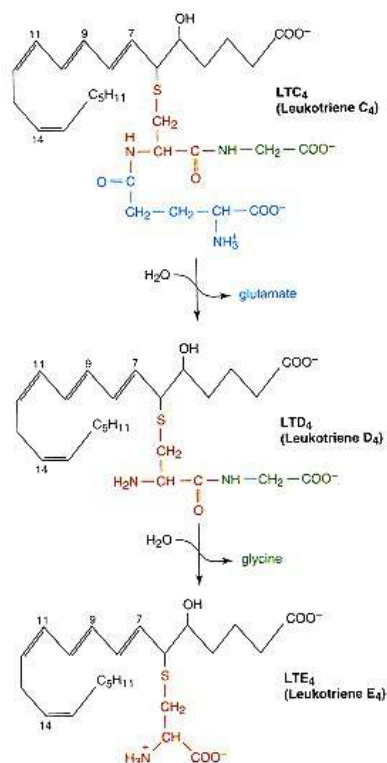

Figure 10.72
Conversion of LTC_4 to LTD_4 and LTE_4 .

the leukotrienes LTD_4 and LTE_4 (Figure 10.72). The subscript 4 denotes the total number of double bonds.

Leukotrienes and HETEs Affect Several Physiological Processes

Leukotrienes persist for as long as 4 h in the body. Stepwise ω -oxidation of the methyl end and β -oxidation of the resulting COOH -terminated fatty acid chain are responsible for the inactivation and degradation of LTB_4 and LTE_4 . These reactions occur in mitochondria and peroxisomes. The actions of the thionyl peptides LTC_4 , LTD_4 , and LTE_4 comprise the **slow-reacting substance of anaphylaxis (SRS-A)**. They cause slowly evolving but protracted contraction of smooth muscles in the airways and gastrointestinal tract. LTC_4 is rapidly converted to LTD_4 and then slowly converted to LTE_4 . These conversions are catalyzed by enzymes in plasma. LTB_4 and the sulfidopeptides LTC_4 , LTD_4 , and LTE_4 exert their biological actions through specific ligand–receptor interactions.

In general, HETEs (especially 5-HETE) and LTB_4 are involved mainly in regulating neutrophil and eosinophil function: they mediate chemotaxis, stimulate adenylate cyclase, and induce PMNs to degranulate and release lysosomal hydrolytic enzymes. In contrast, LTC_4 and LTD_4 are humoral agents that promote smooth muscle contraction, constriction of pulmonary airways, trachea, and

intestine, and increases in capillary permeability (edema). HETEs appear to exert their effects by being incorporated into the phospholipids of target cells. It is thought that the presence of fatty acyl chains containing a polar OH group disturbs the packing of lipids and thus the structure and function of the membrane. LTB₄ has immunosuppressive activity exerted through inhibition of CD4⁺ cells and proliferation of suppressor CD8⁺ cells. LTB₄ also promotes neutrophil–endothelial cell adhesion.

Mono-hydroxyeicosatetraenoic acids that comprise the lipoxygenase pathway are potent mediators of processes involved in allergy (hypersensitivity) and inflammation, secretion (e.g., insulin), cell movement, cell growth, and calcium fluxes. The initial allergic event, namely, the binding of IgE antibody to receptors on the surface of the mast cell, causes the release of substances, including leukotrienes, that are referred to as mediators of immediate hypersensitivity. Lipoxygenase products are usually produced within minutes after the stimulus. The leukotrienes LTC₄, LTD₄, and LTE₄ are much more potent than histamine in contracting nonvascular smooth muscles of bronchi and intestine. LTD₄ increases the permeability of the microvasculature. Mono-HETEs and LTB₄ stimulate migration (chemotaxis) of eosinophils and neutrophils, making them the principal mediators of PMN–leukocyte infiltration in inflammatory reactions.

Eicosatrienoic acids (e.g., dihomο- γ -linolenic acid) and **eicosapentaenoic acid** (Figure 10.64) also serve as lipoxygenase substrates. The content of these C20 fatty acids with three and five double bonds in tissues is less than that of arachidonic acid, but special diets can increase their levels. The lipoxygenase products of these tri- and pentaicosanoids are usually less active than LTA₄ or LTB₄. It remains to be determined if fish oil diets rich in eicosapentaenoic acid are useful in the treatment of allergic and autoimmune diseases.

Pharmaceutical research into therapeutic uses of lipoxygenase and cyclo-oxygenase inhibitors and inhibitors and agonists of leukotrienes in treatment of inflammatory diseases such as asthma, psoriasis, rheumatoid arthritis, and ulcerative colitis is very active.

Bibliography

Phospholipid Metabolism

Downes, C. P. The cellular functions of *myo*-inositol. *Biochem. Soc. Trans.* 17:259, 1989.

Johnson, D. R., Bhatnager, R. S., Knoll, L. J., and Gordon, J. I. Genetic and biochemical studies of protein *N*-myristoylation. *Annu. Rev. Biochem.* 63:869, 1994.

Kent, C., Carman, G. M., Spence, W., and Dowhan, W. Regulation of eukaryotic phospholipid metabolism. *FASEB J.* 5:2258, 1991.

Low, M. G. Biochemistry of the glycosyl-phosphatidyl inositol membrane protein anchors. *Biochem. J.* 244:1, 1987.

McConville, M. J., and Ferguson, M. A. J. The structure, biosynthesis and function of glycosylated phosphatidylinositols in the parasitic protozoa and higher eukaryotes. *Biochem. J.* 294:305, 1993.

Nishizuka, Y. Protein kinase C and lipid signaling for sustained cellular responses. *FASEB J.* 9:484, 1995.

Raetz, C. R. H. Molecular genetics of membrane phospholipid synthesis. *Am. Rev. Genet.* 20:253, 1986.

Shears, S. B. Metabolism of the inositol phosphates produced upon receptor activation. *Biochem. J.* 260:313, 1989.

Snyder, F. Platelet-activating factor and its analogs metabolic pathways and related intracellular processes. *Biochem. Biophys. Acta* 1254:231, 1995.

Stevens, V. L. Biosynthesis of glycosylphosphatidylinositol membrane anchors. *Biochem. J.* 310:361, 1995.

Vance, D. E., and Vance, J. E. *Biochemistry of Lipids and Membranes*. Menlo Park, CA:Benjamin/Cummings, 1985.

Cholesterol Synthesis

Brown, M. S., and Goldstein, J. L. A receptor-mediated pathway for cholesterol homeostasis. *Science* 232:68, 1986.

Edwards, P. A. Regulation of sterol biosynthesis and isoprenylation of proteins. In D. E. Vance and J. E. Vance (Eds.), *Biochemistry of Lipids, Lipoproteins and Membranes*. Amsterdam: Elsevier Science Publishers, 1991.

Goldstein, J. L., and Brown, M. S. Regulation of the mevalonate pathway. *Nature* 343:425, 1990.

Gordon, D. J., and Rifkind, B. M. High-density lipoprotein: the clinical implications of recent studies. *N. Engl. J. Med.* 321:1311, 1989.

Sphingolipids and Sphingolipidoses

Grabowski, G. A., Gatt, S., and Horowitz, M. Acid β -glucosidase: enzymology and molecular biology of Gaucher disease. *Crit. Rev. Biochem. Mol. Biol.* 25:385, 1990.

Robinson, D. Shedding light on lysosomes—applications of fluorescence techniques to cell biology and diagnosis of lysosomal disorders. *Biochem. Soc. Trans.* 16:11, 1988.

Tsuji, S., Choudary, P. V., Martin, B. M., Stubblefield, B. K., Mayor, J. A., Barranger, J. A., and Ginns, E. I. A mutation in the human glucocerebrosidase gene in neuronopathic Gaucher's disease. *N. Engl. J. Med.* 316:570, 1987.

Lung Surfactant

Caminici, S. P., and Young, S. The pulmonary surfactant system. *Hosp. Pract.* 26:87, 1991.

Konishi, M., Fujiwara, T., Naito, T., Tokeuchi, Y., Ogawa, Y., Inukai, K., Fujimura, M., Nakamura, H., and Hashimoto, T. Surfactant replacement therapy in neonatal respiratory distress syndrome. *Eur. J. Pediatr.* 147:20, 1988.

Prostaglandins, Thromboxanes, and Leukotrienes

Fitzpatrick, F. A., and Murphy, R. C. Cytochrome P-450 metabolism of arachidonic acid: formation and biological actions of "epoxygenase"-derived eicosanoids. *Pharmacol. Rev.* 40:229, 1989.

Fordhutchinson, A. W., et al. 5-Lipoxygenase. *Annu. Rev. Biochem.* 63:383, 1994.

Goetzl, E. J., An, S., and Smith, W. L. Specificity of expression and effects of eicosanoid mediators in normal physiology and human diseases. *FASEB J.* 9:1051, 1995.

Henderson, W. R. Jr. The role of leukotrienes in inflammation. *Ann. Intern. Med.* 121:684, 1994.

Mayatepek, E., and Hoffmann, G. Leukotrienes: biosynthesis, metabolism and pathophysiologic significance. *Pediatr. Res.* 37:1, 1995.

Parker, C. W. Lipid mediators produced through the lipoxygenase pathway. *Annu. Rev. Immunol.* 5:65, 1987.

Sardesai, V. M. Biochemical and nutritional aspects of eicosanoids. *J. Nutr. Biochem.* 3:562, 1992.

Yamamoto, S. Mammalian lipoxygenases molecular and catalytic properties. *Prostaglandins Leukot. Essent. Fatty Acids* 35:219, 1989.

Bile Acids

Angelin, B., and Einarsson, K. Bile acids and lipoprotein metabolism. In: S. M. Grundy (Ed.), *Bile Acids and Atherosclerosis*. New York: Raven, 1986, p. 41.

Bjorkhem, I. Mechanism of bile acid biosynthesis in mammalian liver. In: H. Danielsson and J. Sjovald (Eds.), *New Comprehensive Biochemistry* Amsterdam: Elsevier Science Publishers, 1985, pp. 231–278.

Questions

C. N. Angstadt and J. Baggott

Refer to the following structures for Questions 1–3.

1. A plasmalogen.

2. A cardiolipin.

3. An acylglycerol that would likely be liquid at room temperature.

A

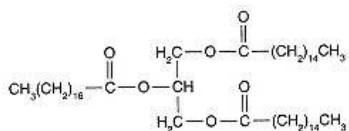

B

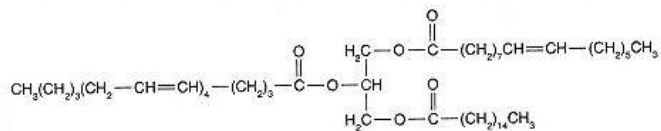

C

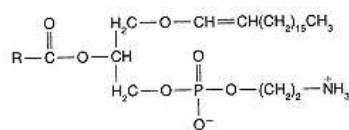

D

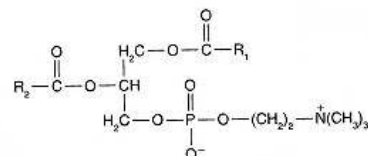

E

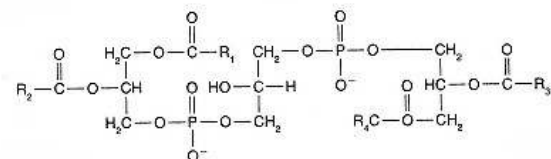

4. Roles of various phospholipids include all of the following EXCEPT:

- A. cell–cell recognition.
- B. a surfactant function in the lung.
- C. activation of certain membrane enzymes.
- D. signal transduction.
- E. mediator of hypersensitivity and acute inflammatory reactions.

5. Which of the following represents a correct group of enzymes involved in phosphatidylcholine synthesis in adipose tissue?

- A. choline phosphotransferase, glycerol kinase, phosphatidic acid phosphatase.
- B. choline phosphotransferase, glycerol phosphate:acyltransferase, phosphatidylethanolamine *N*-methyltransferase
- C. glycerol phosphate:acyltransferase, α -glycerol-phosphate dehydrogenase, phosphatidic acid phosphatase.
- D. glycerol phosphate:acyltransferase, α -glycerol-phosphate dehydrogenase, glycerol kinase.
- E. α -glycerol-phosphate dehydrogenase, glycerol kinase, phosphatidic acid phosphatase.

6. CDP-X (where X is the appropriate alcohol) reacts with 1,2-diacylglycerol in the primary synthetic pathway for:

- A. phosphatidylcholine.
- B. phosphatidylinositol.
- C. phosphatidylserine.
- D. all of the above.
- E. none of the above.

7. Phospholipases A₁ and A₂:

- A. have no role in phospholipid synthesis.
- B. are responsible for the initial insertion of fatty acids in *sn*-1 and *sn*-2 positions during synthesis.
- C. are responsible for base exchange in the interconversion of phosphatidylethanolamine and phosphatidylserine.
- D. hydrolyze a phosphatidic acid to a diglyceride.
- E. remove a fatty acid in an *sn*-1 or *sn*-2 position so it can be replaced by another in phospholipid synthesis.

8. In the biosynthesis of cholesterol:

- A. 3-hydroxy-3-methyl glutaryl CoA (HMG CoA) is synthesized by mitochondrial HMG CoA synthase.
- B. HMG CoA reductase catalyzes the rate-limiting step.
- C. the conversion of mevalonic acid to farnesyl pyrophosphate proceeds via the condensation of three molecules of mevalonic acid.
- D. the condensation of two farnesyl pyrophosphates to form squalene is a freely reversible reaction.
- E. the conversion of squalene to lanosterol is initiated by formation of the fused ring system, followed by addition of oxygen.

9. The cholesterol present in LDL (low-density lipoprotein):

- A. binds to a cell receptor and diffuses across the cell membrane.
- B. when it enters a cell, suppresses the activity of ACAT (acyl CoA:cholesterol acyltransferase)
- C. once in the cell is converted to cholesterol esters by LCAT (lecithin:cholesterol acyltransferase).
- D. once it has accumulated in the cell, inhibits the replenishment of LDL receptors.
- E. represents primarily cholesterol that is being removed from peripheral cells.

10. Primary bile acids.

- A. are any bile acids that are found in the intestinal tract.
- B. are any bile acids reabsorbed from the intestinal tract.
- C. are synthesized in the intestinal tract by bacteria.
- D. are synthesized in hepatocytes directly from cholesterol.
- E. are converted to secondary bile acids by conjugation with glycine or taurine.

11. A ganglioside may contain all of the following EXCEPT:

- A. a ceramide structure.
- B. glucose or galactose.
- C. phosphate.
- D. one or more sialic acids.
- E. sphingosine.

12. Sphingomyelins differ from the other sphingolipids in that they are:

- A. not based on a ceramide core.
- B. acidic rather than neutral at physiological pH.
- C. the only types containing *N*-acetylneuraminic acid.
- D. the only types that are phospholipids.
- E. not amphipathic.

13. All of the following are true about the degradation of sphingolipids EXCEPT it:

- A. occurs by hydrolytic enzymes contained in lysosomes.
- B. terminates at the level of ceramides.
- C. is a sequential, stepwise removal of constituents.
- D. is inhibited in the types of diseases known as sphingolipidoses (lysosomal storage diseases).
- E. is catalyzed by enzymes that are specific for a type of linkage rather than for a particular compound.

14. Structural features that are common to all prostaglandins include:

- A. 20-carbon atoms.
- B. an oxygen-containing internal heterocyclic ring.
- C. a peroxide group at C-15.
- D. two double bonds.
- E. a ketone group.

15. The prostaglandin synthase complex:

- A. catalyzes the rate-limiting step of prostaglandin synthesis.
- B. is inhibited by anti-inflammatory steroids.
- C. contains both a cyclooxygenase and a peroxidase component.
- D. produces PGG₂ as the end product.
- E. uses as substrate the pool of free arachidonic acid in the cell.

16. Thromboxane A₂:

- A. is a long-lived prostaglandin.
- B. is an inactive metabolite of PGE₂.
- C. is the major prostaglandin produced in all cells.
- D. does not contain a ring structure.
- E. is synthesized from the intermediate PGH₂.

17. Hydroperoxy eicosatetraenoic acids (HPETEs):

- A. are derived from arachidonic acid by a peroxidase reaction.
- B. are mediators of hypersensitivity reactions.
- C. are intermediates in the formation of leukotrienes.
- D. are relatively stable compounds (persist for as long as 4 h).
- E. are the inactivated forms of leukotrienes.

Answers

1. C Only one with an ether instead of an ester link at *sn*-1. D is a phosphatidylcholine (p. 397).
2. E Two phosphatidic acids connected by glycerol (p. 398).
3. B Note the two unsaturated fatty acids. A: With all saturated fatty acids, would likely be solid at room temperature.
4. A This function appears to be associated with complex glycosphingolipids (p. 427). B: Especially dipalmitoyllecithin (p. 398). C: For example, β -hydroxybutyrate dehydrogenase (p. 399). D: Especially the phosphatidylinositols (p. 400). E: Platelet activating factor (PAF) does this (p. 398).
5. C A, D, and E: Glycerol kinase is not present in adipose tissue, which must rely on the α -glycerol-phosphate dehydrogenase. This is a liver process only (p. 402).
6. A B: Phosphatidylinositol is formed from CDP-diglyceride reacting with *myo*-inositol (Figure 10.21, p. 406). C: This is formed by "base exchange" (Figure 10.20, p. 406).
7. E Phospholipases A_1 and A_2 , as their names imply, hydrolyze a fatty acid from a phospholipid and so are part of phospholipid degradation. They are also important in synthesis, however, in assuring the asymmetric distribution of fatty acids that occurs in phospholipids (p. 406).
8. B A: Remember that cholesterol biosynthesis is cytosolic; mitochondrial biosynthesis of HMG CoA leads to ketone body formation. C: The rate-limiting step produces the isoprene pyrophosphates, which are the condensing units. D: Pyrophosphate is hydrolyzed, which prevents reversal. E: The process is initiated by epoxide formation (pp. 411–414).
9. D This is one of the ways to prevent overload in the cell. A: The LDL binds to the cell receptor and is endocytosed and then degraded in lysosome to release cholesterol. B: ACAT is activated to facilitate storage. C: LCAT is a plasma enzyme. E: The primary role of LDLs is to deliver cholesterol to peripheral tissues (pp. 415–417).
10. D The intestinal tract contains a mixture of primary and secondary bile acids, both of which can be reabsorbed. Secondary bile acids are formed by bacteria in the intestine by chemical reactions, such as the removal of the C-7 OH group (pp. 417 and 418).
11. C The glycosphingolipids do not contain phosphate. A and E: Ceramide, which is formed from sphingosine, is the base structure from which the glycosphingolipids are formed. D: By definition, gangliosides must contain sialic acid (p. 426).
12. D Sphingomyelins are not glycosphingolipids. They are formed from ceramides, are amphipathic, and are neutral. C is the definition of gangliosides (p. 421).
13. B Ceramides are hydrolyzed to sphingosine and the fatty acid. E: Many of the sphingolipids share the same types of bonds (e.g., a β -galactosidic bond), and one enzyme (e.g., β -galactosidase), will hydrolyze it whenever it occurs (p. 428, Figure 10.59).
14. A Prostaglandins are eicosanoids. B: This is true of thromboxanes but the prostaglandin ring contains only carbons. C: True only of the intermediate of synthesis, PGG₂. D: The number of double bonds is variable. E: True of the A and E series but not of the F series (Figures 10.64–10.68).
15. C A and B: The release of the precursor fatty acid by phospholipase A_2 is the rate-limiting step and the one inhibited by anti-inflammatory steroids. D: The peroxidase component converts the PGG₂ to PGH₂. E: Arachidonic acid is not free in the cell but is part of the membrane phospholipids (p. 433).
16. E TXA₂ is very active, has a very short half-life, contains a six-membered ring, and is the main prostaglandin in platelets but not all tissues (p. 435).
17. C A: The enzyme is a lipoxygenase. B–E: HPETEs themselves are not hormones but highly unstable intermediates that are converted to either HETEs (mediators of hypersensitivity) or leukotrienes (p. 436).

Chapter 11— Amino Acid Metabolism

Marguerite W. Coomes

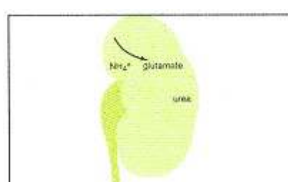

11.1 Overview	446
11.2 Incorporation of Nitrogen into Amino Acids	447
Most Amino Acids Are Obtained from the Diet	447
Amino Groups Are Transferred from One Amino Acid to Form Another	448
Pyridoxal Phosphate Is Cofactor for Aminotransferases	449
Glutamate Dehydrogenase Incorporates and Produces Ammonia	450
Free Ammonia Is Incorporated into and Produced from Glutamine	450
Amide Group of Asparagine Is Derived from Glutamine	452
Amino Acid Oxidases Remove Amino Groups	452
11.3 Transport of Nitrogen to Liver and Kidney	452
Protein Is Degraded on a Regular Basis	452
Amino Acids Are Transported from Muscle after Proteolysis	453
Ammonia Is Released in Liver and Kidney	453
11.4 Urea Cycle	453
Nitrogens of Urea Come from Ammonia and Aspartate	453
Synthesis of Urea Requires Five Enzymes	454
Urea Synthesis Is Regulated by an Allosteric Effector and Enzyme Induction	455
Metabolic Disorders of Urea Synthesis Have Serious Results	455
11.5 Synthesis and Degradation of Individual Amino Acids	456
Glutamate Is a Precursor of Glutathione and γ -Aminobutyrate	457
Arginine Is Also Synthesized in Intestines	457
Ornithine and Proline	458
Serine and Glycine	459
Tetrahydrofolate Is a Cofactor in Many Reactions of Amino Acids	460
Threonine	463
Phenylalanine and Tyrosine	463
Tyrosine Is the First Intermediate in Phenylalanine Metabolism	465
Dopamine, Epinephrine, and Norepinephrine Are Derivatives of Tyrosine	466
Tyrosine Is Involved in Synthesis of Melanin, Thyroid Hormone, and Quinoproteins	468
Methionine and Cysteine	469
Methionine Is First Reacted with Adenosine Triphosphate	469
S-Adenosylmethionine Is a Methyl Group Donor	471
AdoMet Is the Precursor of Spermidine and Spermine	472
Metabolism of Cysteine Produces Sulfur-Containing Compounds	473
Tryptophan	474
Tryptophan Is a Precursor of NAD	475
Pyridoxal Phosphate Has a Prominent Role in Tryptophan Metabolism	476
Kynurenine Gives Rise to Neurotransmitters	476
Serotonin and Melatonin Are Tryptophan Derivatives	476
Tryptophan Induces Sleep	476
Branched-Chain Amino Acids	476
Initial Reactions of BCAA Metabolism Are Shared	477
Pathways of Valine and Isoleucine Metabolism Are Similar	477
The Leucine Pathway Differs from Those of the Other Two Branched-Chain Amino Acids	478
Propionyl CoA Is Metabolized to Succinyl CoA	479
Lysine	479
Carnitine Is Derived from Lysine	481
Histidine	481
Urinary Formiminoglutamate Is Diagnostic of Folate Deficiency	481
Histamine, Carnosine, and Anserine Are Produced from Histidine	482
Creatine	483
Glutathione	484
Glutathione Is Synthesized from Three Amino Acids	485
The γ -Glutamyl Cycle Transports Amino Acids	485
Glutathione Concentration Affects the Response to Toxins	485
Bibliography	486

Questions and Answers	486
Clinical Correlations	
11.1 Carbamoyl Phosphate Synthetase and N-Acetylglutamate Synthetase Deficiencies	456
11.2 Deficiencies of Urea Cycle Enzymes	457
11.3 Nonketotic Hyperglycinemia	461
11.4 Folic Acid Deficiency	463
11.5 Phenylketonuria	465
11.6 Disorders of Tyrosine Metabolism	467
11.7 Parkinson's Disease	467
11.8 Hyperhomocysteinemia and Atherogenesis	471
11.9 Other Diseases of Sulfur Amino Acids	471
11.10 Diseases of Metabolism of Branched-Chain Amino Acids	479
11.11 Diseases of Propionate and Methylmalonate Metabolism	480
11.12 Diseases Involving Lysine and Ornithine	481
11.13 Histidinemia	482
11.14 Diseases of Folate Metabolism	483

**11.1—
Overview**

Amino acids and the relationship between their structure and the structure and function of proteins were presented in Chapter 2. This chapter describes the metabolism of amino acids, emphasizing the importance of dietary protein as the major source of amino acids for humans.

Molecular nitrogen, N_2 , exists in the atmosphere in great abundance. Before it can be utilized by animals it must be "fixed," that is, reduced from N_2 to NH_3 by microorganisms, plants, and electrical discharge from lightning. Ammonia is then incorporated into amino acids and proteins, and these become part of the food chain (Figure 11.1). Humans can synthesize only 11 of the 20 amino acids needed for protein synthesis. Those that cannot be synthesized *de novo* are termed "**essential**" because they must be obtained from dietary foodstuffs that contain them (Table 11.1).

This chapter includes discussion of interconversions of amino acids, removal and excretion of ammonia, and synthesis of "nonessential" amino acids

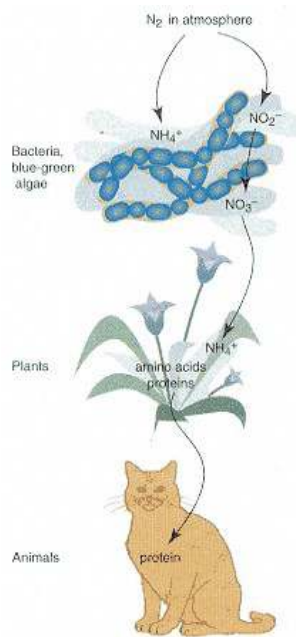

Figure 11.1
Outline of entry of atmospheric nitrogen into the human diet.
This occurs initially by reduction of nitrogen to ammonia by enzymes in microorganisms and plants.

TABLE 11.1 Dietary Requirements of Amino Acids

Essential	Nonessential
Arginine ^a	Alanine
Histidine	Aspartate
Isoleucine	Cysteine
Leucine	Glutamate
Lysine	Glycine
Methionine ^b	Proline
Phenylalanine ^c	Serine
Threonine	Tyrosine
Tryptophan	
Valine	

^a Arginine is synthesized by mammalian tissues, but the rate is not sufficient to meet the need during growth.

^b Methionine is required in large amounts to produce cysteine if the latter is not supplied adequately by the diet.

^c Phenylalanine is needed in larger amounts to form tyrosine if the latter is not supplied adequately by the diet.

by the body. As part of ammonia metabolism, synthesis and degradation of glutamate, glutamine, aspartate, asparagine, alanine, and arginine are discussed. Synthesis and degradation of other nonessential amino acids are then described, as well as the degradation of the essential amino acids. Synthetic pathways of amino acid derivatives and some diseases of amino acid metabolism are also presented.

Carbons from amino acids enter intermediary metabolism at one of seven points. Glucogenic amino acids are metabolized to pyruvate, 3-phosphoglycerate, α -ketoglutarate, oxaloacetate, fumarate, or succinyl CoA. Ketogenic amino acids produce acetyl CoA or acetoacetate. Metabolism of some amino acids results in more than one of the above and they are therefore both glucogenic and ketogenic (Figure 11.2). Products of amino acid metabolism can be used to provide energy. Additional energy-generating compounds, usually NADH, are also produced during degradation of some of the amino acids.

11.2—
Incorporation of Nitrogen into Amino Acids

Most Amino Acids Are Obtained from the Diet

A healthy adult eating a varied and plentiful diet is generally in "nitrogen balance," a state where the amount of nitrogen ingested each day is balanced by the amount excreted, resulting in no net change in the amount of body nitrogen. In the well-fed condition, excreted nitrogen comes mostly from digestion of excess protein or from normal turnover. Protein turnover is defined as the synthesis and degradation of protein. Under some conditions the body is either in negative or positive nitrogen balance. In **negative nitrogen balance** more nitrogen is excreted than ingested. This occurs in starvation and certain diseases. During starvation carbon chains of amino acids from proteins are needed for gluconeogenesis; ammonia released from amino acids is excreted mostly as urea and is not reincorporated into protein. A diet deficient in an essential amino acid also leads to a negative nitrogen balance, since body proteins are degraded to provide the deficient essential amino acid, and the

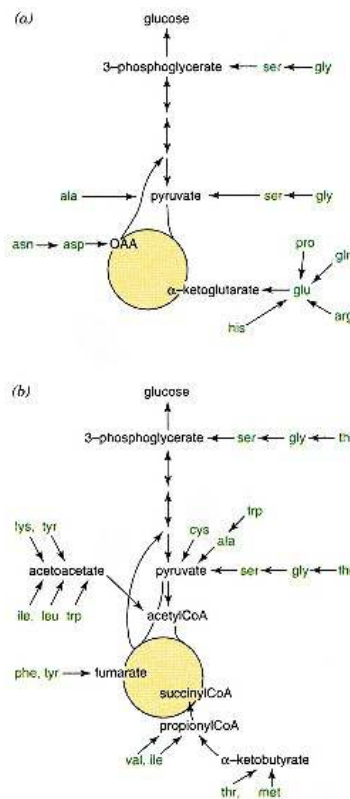

Figure 11.2
Metabolic fate of
(a) nonessential amino acids;
(b) essential amino acids plus cysteine and tyrosine.

other 19 amino acids liberated are metabolized. Negative nitrogen balance may also exist in senescence. **Positive nitrogen balance** occurs in growing children, who are increasing their body weight and incorporating more amino acids into proteins than they break down. Cysteine and arginine are not essential in adults but are essential in children because they are synthesized from methionine and ornithine. These amino acids are readily available in adults but limited in children because of their greater use of all amino acids. Positive nitrogen balance also occurs in pregnancy and during refeeding after starvation.

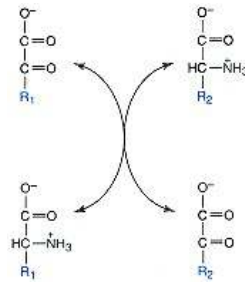

Figure 11.3
Amino transferase reaction.

Amino Groups Are Transferred from One Amino Acid to Form Another

Most amino acids used by the body to synthesize protein or as precursors for amino acid derivatives are obtained from the diet or from protein turnover. When necessary, nonessential amino acids are synthesized from α -keto acid precursors via transfer of a preexisting amino group from another amino acid by **aminotransferases**, also called **transaminases** (Figure 11.3). Transfer of amino groups also occurs during degradation of amino acids. Figure 11.4 shows how the amino group of alanine is transferred to α -ketoglutarate to form glutamate. In this reaction the pyruvate produced provides carbons for gluconeogenesis or for energy production via the TCA cycle. This reaction is necessary since ammonia cannot enter the urea cycle directly from alanine but can be donated by glutamate. The opposite reaction would occur if there were a need for alanine for protein synthesis that was not being met by dietary intake or protein turnover. Transamination involving essential amino acids is normally unidirectional since the body cannot synthesize the equivalent α -keto acid. Figure 11.5 shows transamination of valine, an essential amino acid. The resulting α -ketoisovalerate is further metabolized to succinyl CoA as discussed on page 477. Transamination is the most common reaction involving free amino acids, and only threonine and lysine do not participate in an aminotransferase reaction. An obligate amino and α -keto acid pair in all of these reactions is glutamate and α -ketoglutarate. This means that amino group transfer between alanine and aspartate would have to occur via coupled reactions, with a glutamate intermediate (Figure 11.6). The equilibrium constant for aminotransferases is close to one so that the reactions are freely reversible. When nitrogen excretion is impaired and **hyperammonemia** occurs, as in liver failure, amino acids, including the essential amino acids, can be replaced in the diet by α -keto acid analogs, with the exception of threonine and lysine as mentioned above. The α -keto acids are transaminated by aminotransferases to produce the different amino acids. Figure 11.5 shows valine formation after administration of α -ketoisovalerate as therapy for hyperammonemia.

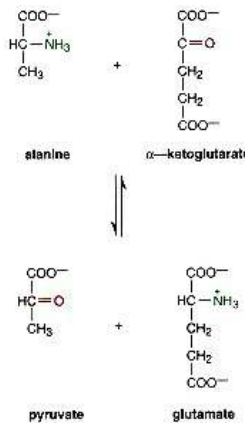

Figure 11.4
Glutamate-pyruvate
aminotransferase reaction.

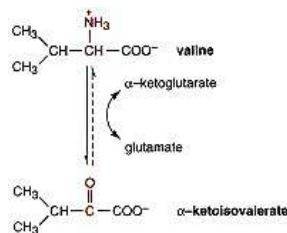

Figure 11.5
Transamination of valine.
Valine can be formed
from α -ketoisovalerate only
when this compound is
administered therapeutically.

Tissue distribution of some of the aminotransferase family is used diagnostically by measuring the release of a specific enzyme during tissue damage; for instance, the presence of glutamate oxaloacetate aminotransferase in plasma is a sign of liver damage (see p. 166).

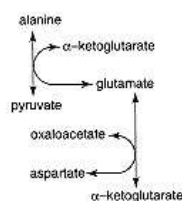

Figure 11.6
A coupled transamination
reaction.

Pyridoxal Phosphate Is Cofactor for Aminotransferases

Transfer of amino groups occurs via enzyme-associated intermediates derived from **pyridoxal phosphate**, the functional form of vitamin B₆ (Figure 11.7). The active site of the "resting" aminotransferase contains pyridoxal phosphate covalently attached to a ϵ -amino group of a lysine residue that forms part of the amino acid chain of the transferase (Figure 11.8). The complex is further stabilized by ionic and hydrophobic interactions. The linkage, $-\text{CH}=\text{N}-$, is called a **Schiff base**. The carbon originates in the aldehyde group of pyridoxal phosphate, and the nitrogen is donated by the lysine residue. When a substrate amino acid, ready to be metabolized, approaches the active site, its amino group displaces the lysine ϵ -amino group and a Schiff base linkage is formed with the amino group of the amino acid substrate (Figure 11.9). At this point the pyridoxal phosphate-derived molecule is no longer covalently attached to the enzyme but is held in the active site only by ionic and hydrophobic interactions between it and the protein. The Schiff base linkage involving the amino acid substrate is in tautomeric equilibrium between an aldimine, $-\text{CH}=\text{N}-\text{CHR}_2$, and a ketimine, $-\text{CH}_2-\text{N}=\text{CR}$. Hydrolysis of the ketimine liberates an α -keto acid, leaving the amino group as part of the pyridoxamine structure. A reversal of the process is now possible; an α -keto acid reacts with the amine group, the double bond is shifted, and then hydrolysis liberates an amino acid. Pyridoxal phosphate now reforms its Schiff base with the "resting" enzyme (Figure 11.8). Most pyridoxal phosphate-requiring reactions involve transamination, but the ability of the Schiff base to transfer electrons between different atoms allows this cofactor to participate

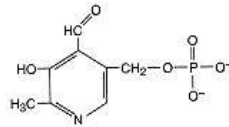

Figure 11.7
Pyridoxal phosphate.

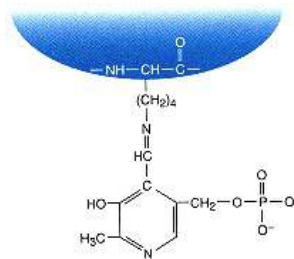

Figure 11.8
Pyridoxal phosphate in aldimine linkage to protein lysine residue.

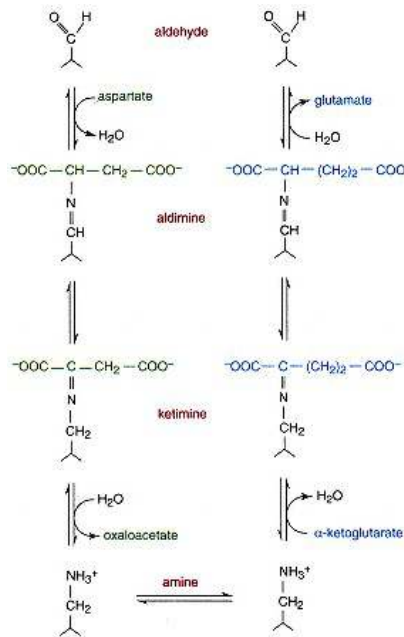

Figure 11.9
Different forms of pyridoxal phosphate during a transamination reaction.

when other groups, such as carboxyls, are to be eliminated. Figure 11.10 shows the reaction of a **pyridoxal-dependent decarboxylase** and an **α -, β -elimination**.

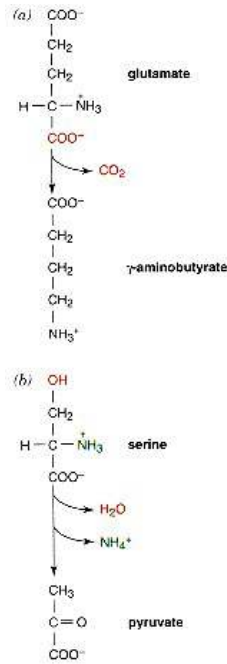

Figure 11.10
Glutamate decarboxylase and serine dehydratase are pyridoxal phosphate-dependent reactions.

The effective concentration of vitamin B₆ in the body may be decreased by administration of certain drugs, such as the antitubercular, isoniazid, which forms a Schiff base with pyridoxal making it unavailable for catalysis.

Glutamate Dehydrogenase Incorporates and Produces Ammonia

In the liver ammonia is incorporated as the amino group of nitrogen by **glutamate dehydrogenase** (Figure 11.11). This enzyme also catalyzes the reverse reaction. Glutamate always serves as one of the amino acids in transaminations and is thus the "gateway" between free ammonia and amino groups of most amino acids (Figure 11.12). NADPH is used in the synthetic reaction, whereas NAD⁺ is used in liberation of ammonia, a degradative reaction. The enzyme is involved in the production of ammonia from amino acids when these are needed as glucose precursors or for energy. Formation of NADH during the oxidative deamination reaction is a welcome bonus, since it can be reoxidized by the respiratory chain with formation of ATP. The reaction as shown is readily reversible in the test tube but it is likely that *in vivo* it occurs more frequently in the direction of ammonia formation. The concentration of ammonia needed for the reaction to produce glutamate is toxic and under normal conditions would rarely be attained except in the perivenous region of the liver. A major source of ammonia is **bacterial metabolism** in the intestine, the released ammonia being absorbed and transported to the liver. Glutamate dehydrogenase incorporates this ammonia, as well as that produced locally, into glutamate. The enzyme's dominant role in ammonia removal is emphasized by its location inside liver mitochondria, where the initial reactions of the urea cycle occur.

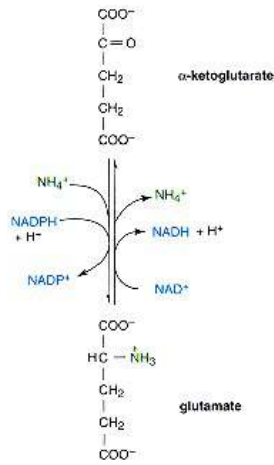

Figure 11.11
Glutamate dehydrogenase reaction.

Glutamate dehydrogenase is regulated allosterically by purine nucleotides. When there is need for oxidation of amino acids for energy, the activity is increased in the direction of glutamate degradation by ADP and GDP, which are indicative of a low cellular energy level. GTP and ATP, indicative of an ample energy level, are allosteric activators in the direction of glutamate synthesis (Figure 11.13).

Free Ammonia Is Incorporated into and Produced from Glutamine

Free ammonia is toxic and is preferentially transported in the blood in the form of amino or amide groups. Fifty percent of circulating amino acids are **glutamine**, an ammonia transporter. The amide group of glutamine is important as a nitrogen donor for several classes of molecules, including purine bases, and the amino group of cytosine. Glutamate and ammonia are substrates for **glutamine synthetase** (Figure 11.14). ATP is needed for activation of the α -carboxyl group to make the reaction energetically favorable.

Removal of the amide group is catalyzed by **glutaminase** (Figure 11.15). There are tissue-specific isozymes. Mitochondrial glutaminase I of kidney and

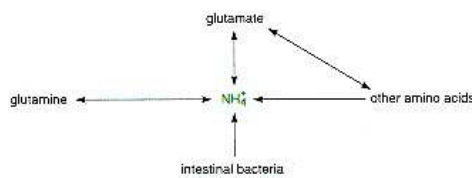

Figure 11.12
Role of glutamate in amino acid synthesis, degradation, and interconversion.

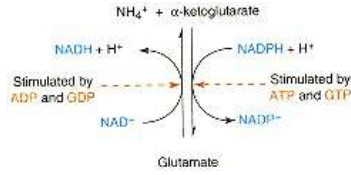

Figure 11.13
Allosteric regulation of glutamate dehydrogenase.

liver requires phosphate for activity. Liver contains glutamine synthetase and glutaminase but is neither a net consumer nor a net producer of glutamine. The two enzymes are confined to parenchymal cells in different segments of the liver. The **periportal region** is in contact with blood coming from skeletal muscle and contains glutaminase (and the urea cycle enzymes). The **perivenous area** represents 5% of parenchymal cells; blood from it flows to the kidney and cells in this area contain glutamine synthetase. This "**intercellular glutamine cycle**" (Figure 11.16) can be considered a mechanism for scavenging ammonia that has not been incorporated into urea. The enzymes of urea synthesis are found in the same periportal cells as glutaminase, whereas the uptake of glutamate and α -ketoglutarate for glutamine synthesis predominates in the perivenous region. The glutamine cycle makes it possible to control flux of ammonia either to urea or to glutamine and thence to excretion of ammonia by the kidney under different pH conditions (see p. 1045).

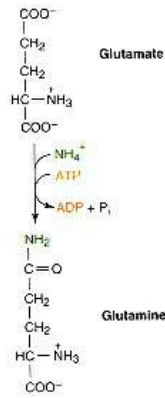

Figure 11.14
Reaction catalyzed by glutamine synthetase.

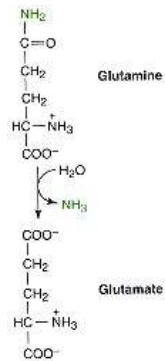

Figure 11.15
Reaction catalyzed by glutaminase.

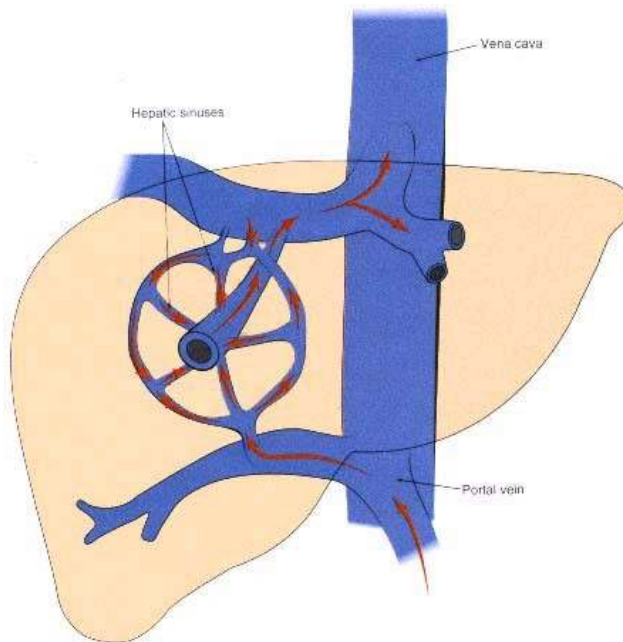

Figure 11.16
Intercellular glutamine cycle.
Periportal cells surround incoming blood vessels, and perivenous cells surround outgoing blood vessels.

Amide Group of Asparagine Is Derived from Glutamine

The amide group of **asparagine** comes from that of glutamine (Figure 11.17), and not from free ammonia, as in the synthesis of glutamine. ATP is needed to activate the receptor α -carboxyl group. Asparagine is readily synthesized in most cells, but some leukemic cells seem to have lost this ability. A therapeutic approach that has been tried for patients with **asparagine synthetase**-deficient tumors is treatment with exogenous **asparaginase** to hydrolyze the blood-borne asparagine on which these cells rely (Figure 11.18). Normal cells synthesize and degrade asparagine.

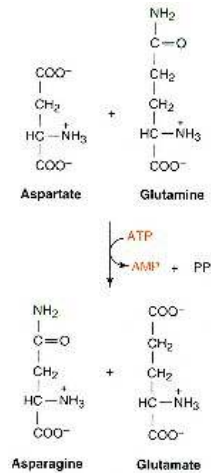

Figure 11.17
Synthesis of asparagine.

Amino Acid Oxidases Remove Amino Groups

Many amino acids are substrates for **L-amino acid oxidase** (Figure 11.19). The significance of this reaction in the metabolism of amino acids is uncertain, but appears to be small. The enzyme contains flavin mononucleotide (FMN) and produces hydrogen peroxide. After the hydrogen peroxide is reduced to water, the final products are an α -keto acid, ammonia, and water, the same products as those of the glutamate dehydrogenase reaction. In the amino acid oxidase reaction, unlike the reaction catalyzed by glutamate dehydrogenase, there is no concomitant production of NADH, and therefore no production of ATP.

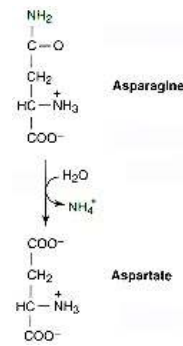

Figure 11.18
Reaction catalyzed by asparaginase.

A **D-amino acid oxidase** also occurs in human cells. Very little of the D-amino acid isomer is found in humans and the role of D-amino acid oxidase may be in degradation of D-amino acids derived from intestinal bacteria.

11.3—

Transport of Nitrogen to Liver and Kidney

Protein Is Degraded on a Regular Basis

Whole cells die on a regular and planned basis, and their component molecules are metabolized. This "**planned cell death**" is called **apoptosis**. Individual proteins also undergo regular turnover under normal conditions. Even though the reactions involved in intracellular protein degradation have been identified, an understanding of the regulation of protein degradation is in its infancy. The half-life of a protein can be an hour or less, such as for ornithine decarboxylase, phosphokinase C, and insulin, several months for hemoglobin and histones,

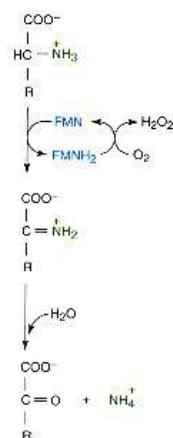

Figure 11.19
Reaction of L-amino acid oxidase, a flavoprotein.

or the life of the organism for the crystallins of the lens. The majority, however, turn over every few days. Selection of a particular protein molecule for degradation is not well understood but may, in many cases, occur by "marking" with covalently bound molecules of an oligopeptide, termed **ubiquitin**. Ubiquitin contains 76 amino acid residues and is attached via its C-terminal glycine residue to the terminal amino group and to lysine residues in the protein to be marked for degradation. This is a nonlysosomal, ATP-dependent process and requires a complex of three enzymes known as ubiquitin protein ligase. Recently, ubiquitination and protein degradation have been found to regulate the cell cycle by influencing the availability of proteins required in the S and G₁ phases. Other protein degradation occurs in the lysosomes, or extralysosomally by calcium-dependent enzymes.

Amino Acids Are Transported from Muscle after Proteolysis

The majority of protein, and consequently of amino acids, is in skeletal muscle. Under conditions of energy need, this protein is degraded and amino groups from the amino acids are transferred to glutamine and alanine and transported to liver or kidney. Urea is produced in liver and ammonia (from glutamine) in kidney (Figure 11.20). Carbon skeletons are either used for energy or transported to the liver for gluconeogenesis. Muscle protein responds to conditions such as starvation, trauma, burns, and septicemia, by undergoing massive degradation. Of the amino acids released, most important as a source of fuel are **branched-chain amino acids** (valine, leucine, and isoleucine). The first step in their degradation is transamination, which occurs almost exclusively in muscle. Protein is, of course, degraded throughout the body, but muscle is by far the greatest source of free amino acids for metabolism.

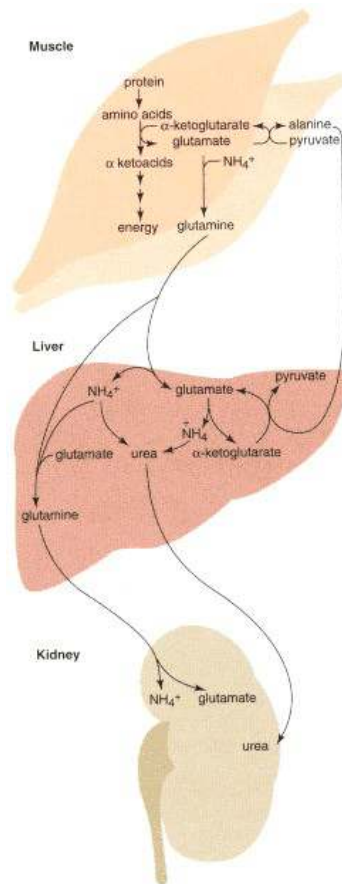

Figure 11.20
Major pathways of interorgan nitrogen transport following muscle proteolysis.

Ammonia Is Released in Liver and Kidney

The main destination of glutamine and alanine in the blood is the liver (see Figure 11.20). Here ammonia is released by alanine aminotransferase, glutaminase, and glutamate dehydrogenase. Glutamate dehydrogenase not only releases ammonia but also produces NADH and α -ketoglutarate, a glucogenic intermediate. Under conditions of energy need these products are very beneficial. Many tumors produce a condition called **cachexia**, characterized by wasting of muscle. This is caused not at the level of regulation of the rate of muscle protein breakdown, but rather by an increase in the rate at which liver removes amino acids from plasma, which, in turn, has a potentiating effect on muscle proteolysis. When circulating glucagon concentration is high (a signal that carbon is required by the liver for gluconeogenesis), it also potentiates amino acid metabolism by stimulating amino acid uptake by the liver.

Some glutamine and alanine is taken up by the kidney. Ammonia is released by the same enzymes that are active in liver, protonated to ammonium ion and excreted. When acidosis occurs the body shunts glutamine from liver to kidney to **conserve bicarbonate**, since formation of urea, the major mechanism for removal of NH_4^+ , requires bicarbonate. To avoid use and excretion of this anion as urea during acidosis, uptake of glutamine by liver is suppressed, and more is transported to kidney for excretion as ammonium ion (see p. 1045).

11.4— Urea Cycle

Nitrogens of Urea Come from Ammonia and Aspartate

The **urea cycle** and the tricarboxylic acid (TCA) cycle were discovered by Sir Hans Krebs and co-workers. In fact, the urea cycle was described before the

TCA cycle. In land-dwelling mammals, the urea cycle is the mechanism of choice for nitrogen excretion. The two nitrogens in each urea molecule (Figure 11.21) are derived from two sources, free ammonia and the amino group of aspartate. The cycle starts and finishes with **ornithine**. Unlike the TCA cycle, where carbons of oxaloacetate at the start are different from those at the end, the carbons in the final ornithine are the same carbons with which the molecule started.

Ammonia (first nitrogen for urea) enters the cycle after condensation with bicarbonate to form **carbamoyl phosphate** (Figure 11.22), which reacts with ornithine to form **citrulline**. Aspartate (the donor of the second urea nitrogen) and citrulline react to form **argininosuccinate**, which is then cleaved to arginine and fumarate. Arginine is hydrolyzed to urea and ornithine is regenerated. Urea is then transported to the kidney and excreted in urine. The cycle requires 4 ATPs to excrete each two nitrogen atoms. It is therefore more energy efficient to incorporate ammonia into amino acids than to excrete it. The major regulatory step is the initial synthesis of carbamoyl phosphate, and the cycle is also regulated by induction of the enzymes involved.

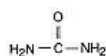

Figure 11.21
Urea

Synthesis of Urea Requires Five Enzymes

Carbamoyl phosphate synthetase I is technically not a part of the urea cycle, although it is essential for urea synthesis. Free ammonium ion and bicarbonate are condensed, at the expense of 2 ATPs, to form carbamoyl phosphate. One ATP activates bicarbonate, and the other donates the phosphate group of carbamoyl phosphate. Carbamoyl phosphate synthetase I occurs in the mitochondrial matrix, uses ammonia as nitrogen donor, and is absolutely dependent on **N-acetylglutamate** for activity (Figure 11.23). Another enzyme with similar activity, **carbamoyl phosphate synthase II**, is cytosolic, uses the amide group of glutamine, and is not affected by *N*-acetylglutamate. It participates in pyrimidine biosynthesis (see p. 505).

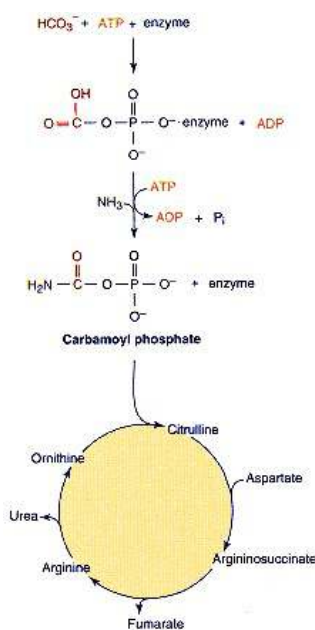

Figure 11.22
Synthesis of carbamoyl phosphate and entry into urea cycle.

Formation of citrulline is catalyzed by **ornithine transcarbamoylase** (11.24) in the mitochondrial matrix. Citrulline is transported from the mitochondria, and other reactions of the urea cycle occur in the cytosol. Argininosuccinate production by **argininosuccinate synthetase** requires hydrolysis of ATP to AMP and PP_i , the equivalent of hydrolysis of two molecules of ATP. Cleavage of argininosuccinate by **argininosuccinate lyase** produces fumarate and arginine. Arginine is cleaved by **arginase** to ornithine and urea. Ornithine reenters the mitochondrion for another turn of the cycle. The inner mitochondrial membrane contains a **citrulline/ornithine exchange transporter**.

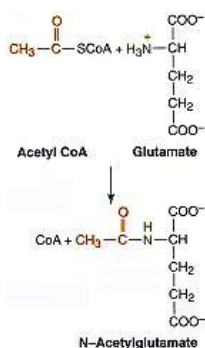

Figure 11.23
Reaction catalyzed by *N*-acetylglutamate synthetase.

Synthesis of additional ornithine from glutamate for the cycle will be described later. Since arginine is produced from carbons and nitrogens of ornithine, ammonia, and aspartate, it is a nonessential amino acid. In growing children, however, where there is net incorporation of nitrogen into the body, *de novo* synthesis of arginine is inadequate and the amino acid becomes essential.

Carbons from aspartate, released as fumarate, may enter the mitochondrion and be metabolized to oxaloacetate by the TCA enzymes fumarase and malate dehydrogenase, transaminated, and then theoretically enter another turn of the urea cycle as aspartate. Most oxaloacetate (about two-thirds) from fumarate is metabolized via phosphoenolpyruvate to glucose (Figure 11.25). The amount of fumarate used to form ATP is approximately equal to that required for the urea cycle and gluconeogenesis, meaning that the liver itself gains no net energy in the process of amino acid metabolism.

Since humans cannot metabolize urea it is transported to the kidney for filtration and excretion. Any urea that enters the intestinal tract is cleaved by the intestinal **urease**-containing bacteria, the resulting ammonia being absorbed and used by the liver.

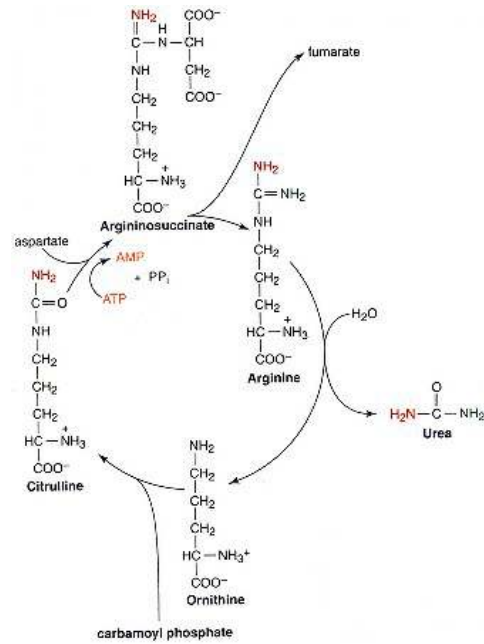

Figure 11.24
Urea cycle.

Urea Synthesis Is Regulated by an Allosteric Effector and Enzyme Induction

Carbamoyl phosphate synthetase has a mandatory requirement for the allosteric activator *N*-acetylglutamate (see Figure 11.23). This compound is synthesized from glutamate and acetyl CoA by *N*-acetylglutamate synthetase, which is activated by arginine. Acetyl CoA, glutamate, and arginine are needed to supply intermediates or energy for the urea cycle, and the presence of *N*-acetylglutamate indicates that they are all available. Tight regulation is desirable for a pathway that controls the plasma level of potentially toxic ammonia and that is also highly energy dependent.

Induction of urea cycle enzymes occurs (10- to 20-fold) when delivery of ammonia or amino acids to liver rises. Concentration of cycle intermediates also plays a role in its regulation through mass action. A high-protein diet (net excess amino acids) and starvation (need to metabolize excess nitrogen in order to provide carbons for energy production) result in induction of urea cycle enzymes.

Metabolic Disorders of Urea Synthesis Have Serious Results

The urea cycle is the major mechanism for the elimination of ammonia, a very toxic substance. Metabolic disorders that arise from abnormal function of enzymes of urea synthesis are potentially fatal and cause coma when ammonia concentrations become high. Loss of consciousness may be a consequence of ATP depletion. The major source of ATP is oxidative phosphorylation, which

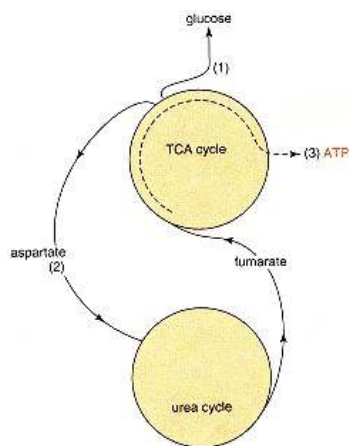

Figure 11.25
Fumarate from the urea cycle is a source of glucose (1), aspartate (2), or energy (3).

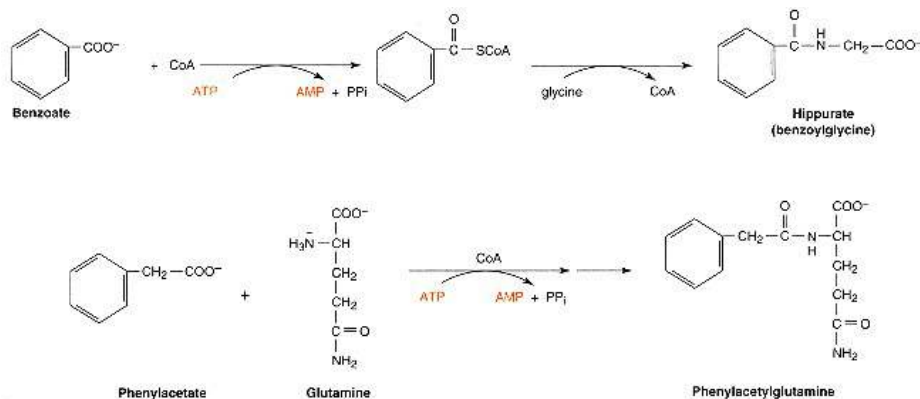

Figure 11.26

Detoxification reactions as alternatives to the urea cycle.

is linked to transfer of electrons from the TCA cycle down the electron transport chain. A high concentration of ammonia sequesters α -ketoglutarate to form glutamate, thus depleting the TCA cycle of important intermediates and reducing ATP production.

Patients with a deficiency in each of the urea cycle enzymes have been found. Therapy for these deficiencies has a threefold basis: (1) to limit protein intake and potential buildup of ammonia, (2) to remove excess ammonia, and (3) to replace any intermediates missing from the urea cycle. The first is accomplished by limiting ingestion of amino acids, replacing them if necessary with the equivalent α -keto acids to be transaminated *in vivo*. The bacterial source of ammonia in the intestines can be decreased by a compound that acidifies the colon, such as levulose, a poorly absorbed synthetic disaccharide that is metabolized by colonic bacteria to acidic products. This promotes the excretion of ammonia in feces as protonated ammonium ions. Antibiotics can also be administered to kill ammonia-producing bacteria. The second is achieved by compounds that bind covalently to amino acids and produce nitrogen-containing molecules that are excreted in urine. Figure 11.26 shows condensation of benzoate and glycine to form **hippurate**, and of phenylacetate and glutamine to form **phenylacetylglutamine**. Phenylacetate is extremely unpalatable and is given as the precursor sodium phenylbutyrate. Both reactions require energy for activation of the carboxyl groups by addition of CoA.

Clinical Correlations 11.1 and 11.2 give examples of therapy for specific enzyme deficiencies, which often includes administration of urea cycle intermediates.

CLINICAL CORRELATION 11.1

Carbamoyl Phosphate Synthetase and *N*-Acetylglutamate Synthetase Deficiencies

Hyperammonemia has been observed in infants with 0–50% of the normal level of carbamoyl synthetase activity in their livers. In addition to the treatments described in the text, these infants have been treated with arginine, on the hypothesis that activation of *N*-acetylglutamate synthetase by arginine would stimulate the residual carbamoyl phosphate synthetase. This enzyme deficiency generally leads to mental retardation. A case of *N*-acetylglutamate synthetase deficiency has been described and treated successfully by administering carbamoyl glutamate, an analog of *N*-acetylglutamate, that is also able to activate carbamoyl phosphate synthetase.

11.5— Synthesis and Degradation of Individual Amino Acids

Other aspects of metabolism of glutamate, glutamine, aspartate, asparagine, pyruvate, and arginine, the amino acids whose basic metabolism has already been covered, are now discussed. Synthesis of other nonessential amino acids and degradation of all the amino acids will be covered, as well as synthesis of physiologically important amino acid derivatives.

CLINICAL CORRELATION 11.2

Deficiencies of Urea Cycle Enzymes

Ornithine Transcarbamoylase Deficiency

The most common deficiency involving urea cycle enzymes is lack of ornithine transcarbamoylase. Mental retardation and death often result, but the occasional finding of normal development in treated patients suggests that the mental retardation usually associated is caused by the excess ammonia before adequate therapy. The gene for ornithine transcarbamoylase is on the X chromosome, and males generally are more seriously affected than heterozygotic females. In addition to ammonia and amino acids appearing in the blood in increased amounts, orotic acid also increases, presumably because carbamoyl phosphate that cannot be used to form citrulline diffuses into the cytosol, where it condenses with aspartate, ultimately forming orotate (Chapter 12).

Argininosuccinate Synthetase and Lyase Deficiency

The inability to condense citrulline with aspartate results in accumulation of citrulline in blood and excretion in urine (citrullinemia). Therapy for this normally benign disease requires specific supplementation with arginine for protein synthesis and for formation of creatine. Impaired ability to split argininosuccinate to form arginine resembles argininosuccinate synthetase deficiency in that the substrate, in this case argininosuccinate, is excreted in large amounts. The severity of symptoms in this disease varies greatly so that it is hard to evaluate the effect of therapy, which includes dietary supplementation with arginine.

Arginase Deficiency

Arginase deficiency is rare but causes many abnormalities in development and function of the central nervous system. Arginine accumulates and is excreted. Precursors of arginine and products of arginine metabolism may also be excreted. Unexpectedly, some urea is also excreted; this has been attributed to a second type of arginase found in the kidney. A diet including essential amino acids but excluding arginine has been used effectively.

Brusilow, S. W., Danney, M., Waber, L. J., Batshaw, M., et al. Treatment of episodic hyperammonemia in children with inborn errors of urea synthesis. *N. Engl. J. Med.* 310:1630, 1984.

Glutamate Is a Precursor of Glutathione and γ -Aminobutyrate

Glutamate is a component of **glutathione**, which is discussed at the end of this chapter (see p. 484). It is also a precursor for **γ -aminobutyric acid**, a neurotransmitter (Figure 11.27), which will be discussed in Chapter 21, and of proline and ornithine, described below.

Arginine Is Also Synthesized in Intestines

Production of arginine for protein synthesis, rather than as an intermediate in the urea cycle, occurs in kidney, which lacks arginase. The major site of synthesis of citrulline to be used as an arginine precursor is intestinal mucosa, which has all necessary enzymes to convert glutamate (via ornithine as described below) to citrulline, which is then transported to the kidney to produce arginine. Arginine is also a precursor for **nitric oxide** (Chapter 22); in brain, **agmatine**, a compound that may have antihypertensive properties, is an arginine derivative (Figure 11.28).

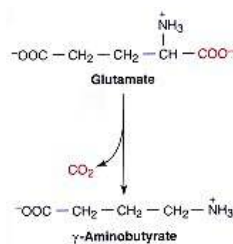

Figure 11.27
Synthesis of γ -aminobutyric acid.

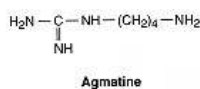

Figure 11.28
Agmatine.

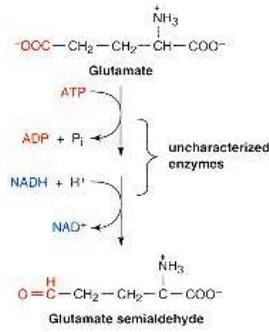

Figure 11.29
Synthesis of glutamic semialdehyde.

Ornithine and Proline

Ornithine, the precursor of citrulline and arginine, and **proline** are both synthesized from glutamate and degraded, by a slightly different pathway, to glutamate. Synthesis of these two nonessential amino acids starts from α -ketoglutarate with a shared reaction that uses ATP and NADH (Figure 11.29) and forms **glutamic semialdehyde**. This spontaneously will cyclize to form a Schiff base between the aldehyde and amino groups, which is then reduced by NADPH to proline. Glutamic semialdehyde can undergo transamination of the aldehyde group, preventing cyclization and producing ornithine (Figure 11.30).

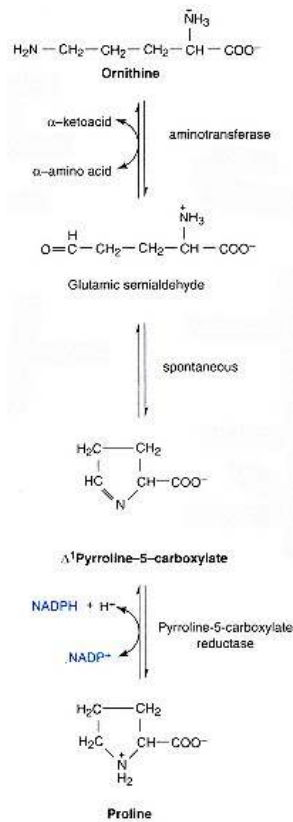

Figure 11.30
Synthesis of ornithine and proline from glutamic semialdehyde, a shared intermediate.

Proline is converted back to the Schiff base intermediate, Δ^1 -pyrroline 5-carboxylate, which is in equilibrium with glutamic semialdehyde. The transaminase reaction in the ornithine synthetic pathway is freely reversible and forms glutamic semialdehyde from ornithine (Figure 11.30). Proline residues can be hydroxylated after incorporation into a protein. This posttranslational modification forms **3- or 4-hydroxyproline** (Figure 11.31). When these are released by protein degradation and metabolized they produce glyoxalate and pyruvate, and 4-hydroxy-2-ketoglutarate, respectively.

Ornithine is a precursor of putrescine, the foundation molecule of polyamines, highly cationic molecules that interact with DNA. Ornithine decarboxylase catalyzes this reaction (Figure 11.32). It is regulated by phosphorylation at several sites, presumably in response to specific hormones, growth factors, or cell cycle regulatory signals. It can also be induced, and this is often the first easily measurable sign that cell division is imminent, since polyamines must be synthesized before mitosis can occur. Other common **polyamines** are **spermidine** and **spermine** (see Figure 11.59), which are synthesized from putrescine by addition of propylamine, a product of methionine metabolism (see p. 472).

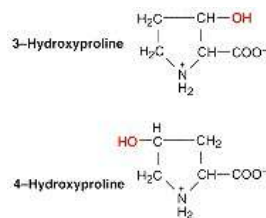

Figure 11.31
Hydroxyprolines.

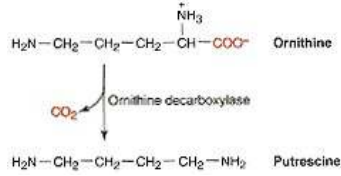
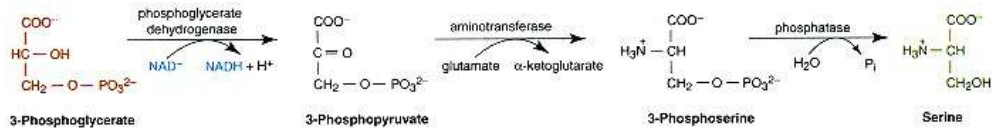

Figure 11.32
Decarboxylation of ornithine to putrescine.
 Structures of spermidine and spermine are shown in Figure 11.59.

Serine and Glycine

Serine is synthesized *de novo* starting with 3-phosphoglycerate from the glycolytic pathway. When serine provides gluconeogenic intermediates this is also the product of its degradation, although the enzymes and intermediates in the two pathways are different. Synthesis of serine uses phosphorylated intermediates between 3-phosphoglycerate and serine (Figure 11.33a), loss of the phosphate being the last step. From serine to 3-phosphoglycerate the intermediates are unphosphorylated, the addition of a phosphate being the last step. The enzymes that catalyze the reactions in the two pathways are not the same (Figure 11.33b). Another reaction for entry of serine into intermediary metabolism is via **serine dehydratase**, which forms pyruvate with loss of the amino group as NH_4^+ (Figure 11.34). The same enzyme catalyzes a similar reaction with threonine (see p. 463).



(a) Synthesis of serine from a glycolytic intermediate

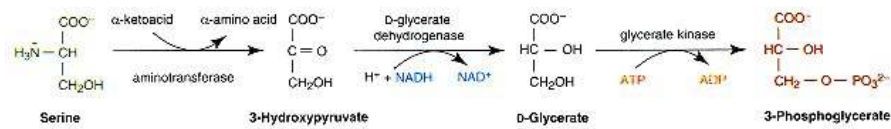

(b) Reactions from serine to a gluconeogenic intermediate

Figure 11.33
 Pathways for
 (a) synthesis of serine and
 (b) metabolism of serine for gluconeogenesis.

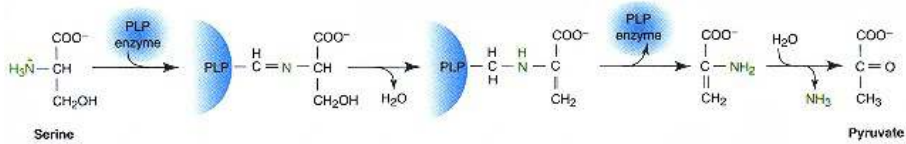

Figure 11.34
 Reaction of serine dehydratase requires pyridoxal phosphate.

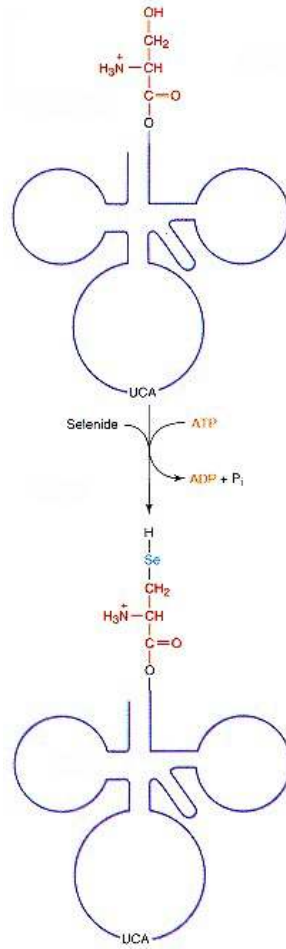

Figure 11.35
Formation of selenocysteineyl
tRNA from seryl tRNA
is via a phosphoseryl tRNA
intermediate.

Serine is precursor of an unusual but important amino acid. Certain proteins, notably **glutathione peroxidase**, contain **selenocysteine** (Figure 11.35). In mRNA for selenoproteins the codon UGA, which generally serves as a termination codon, codes for selenocysteine. This amino acid is formed from serine after formation of the seryl-tRNA complex (serine bound to a specific tRNA^{Ser} with the anticodon to UGA).

Ethanolamine, choline, and betaine (Figure 11.36) are derivatives of serine. Ethanolamine and choline are components of lipids, and betaine is a methyl donor in a minor pathway leading to methionine salvage (see p. 472). Serine is also a sulfhydryl group acceptor from homocysteine in cysteine synthesis (see p. 470).

In some enzymes a serine residue is modified to form a prosthetic group. In humans the only example described so far is **S-adenosylmethionine decarboxylase** (discussed below in relation to polyamine formation; see p. 473). The prosthetic group formed is similar to pyruvate. S-Adenosylmethionine de-carboxylase is synthesized in precursor form that is then cleaved autocatalytically between a glutamate and a serine residue to form two polypeptides. During cleavage other reactions convert the new N-terminal serine of one of the resulting peptides into a pyruvate (Figure 11.37). The pyruvate functions in decarboxylation by forming a Schiff base with the amino group of S-adenosylmethionine.

Serine is converted reversibly to **glycine** in a reaction that requires pyridoxal phosphate and **tetrahydrofolate**. **N⁵, N¹⁰-methylene tetrahydrofolate** (N⁵, N¹⁰-THF) is produced (Figure 11.38). The demand for serine or glycine and the amount of N⁵, N¹⁰-THF available determine the direction of this reaction. Glycine is degraded to CO₂ and ammonia by a **glycine cleavage complex** (Figure 11.39; see Clin. Corr. 11.3). This reaction is reversible in the test tube, but not *in vivo*, as the K_m values for ammonia and N⁵, N¹⁰-THF are much higher than their respective physiological concentrations.

Glycine is the precursor of **glyoxalate**, which can be transaminated back to glycine or oxidized to **oxalate** (Figure 11.40). Excessive production of oxalate forms the insoluble calcium oxalate salt, which may lead to kidney stones. In Chapter 21 the role of glycine as a neurotransmitter is described.

Tetrahydrofolate Is a Cofactor in Many Reactions of Amino Acids

The **tetrahydrofolate** molecule is the reduced form of folic acid, one of the B vitamins, and often occurs as a polyglutamyl derivative (Figure 11.41).

Tetrahydrofolate, involved in two reactions described earlier in the chapter, is a **one-carbon carrier** that facilitates interconversion of methenyl, formyl, formimino,

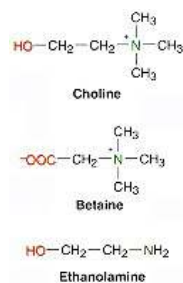

Figure 11.36
Choline and related
compounds.

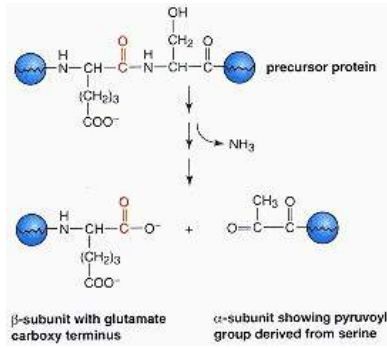

Figure 11.37
Formation of enzyme with covalently bound pyruvoyl prosthetic group.

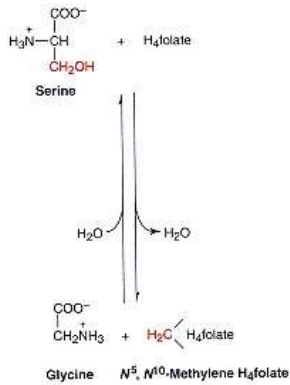

Figure 11.38
Serine hydroxymethyltransferase.

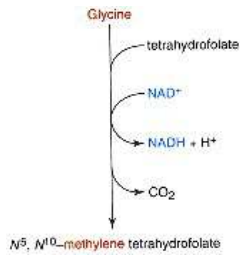

Figure 11.39
Glycine cleavage is pyridoxal phosphate dependent.

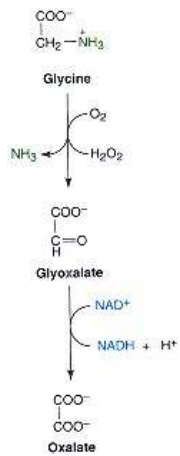

Figure 11.40
Oxidation of glycine.

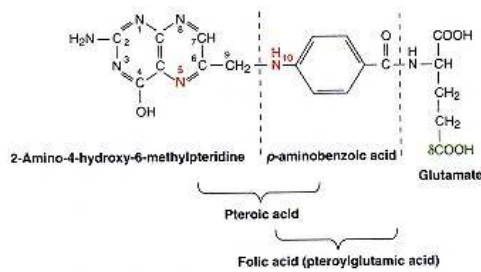

Figure 11.41
Components of folate.
Polyglutamate can be added to the -carboxyl group.

CLINICAL CORRELATION 11.3

Nonketotic Hyperglycinemia

Nonketotic hyperglycinemia is characterized by severe mental deficiency, and many patients do not survive infancy. The name of this very serious disease is meant to distinguish it from ketoacidosis in abnormalities of branched-chain amino acid metabolism in which, for unknown reasons, the glycine level in the blood is also elevated. Deficiency of glycine cleavage complex has been demonstrated in homogenates of liver from several patients, and isotopic studies *in vivo* have confirmed that this enzyme is not active in these patients. The glycine cleavage complex consists of four different protein subunits. Inherited abnormalities have been found in three of these. The severity of this disease suggests that glycine cleavage is of major importance in the catabolism of glycine. Glycine is a major inhibitory neurotransmitter, which probably explains some neurological complications of the disease. Vigorous measures to reduce the glycine levels fail to alter the course of the disease.

Nyhan, W. L. Metabolism of glycine in the normal individual and in patients with non-ketotic hyperglycinemia. *J. Inherit. Metab. Dis.* 5:105, 1982.

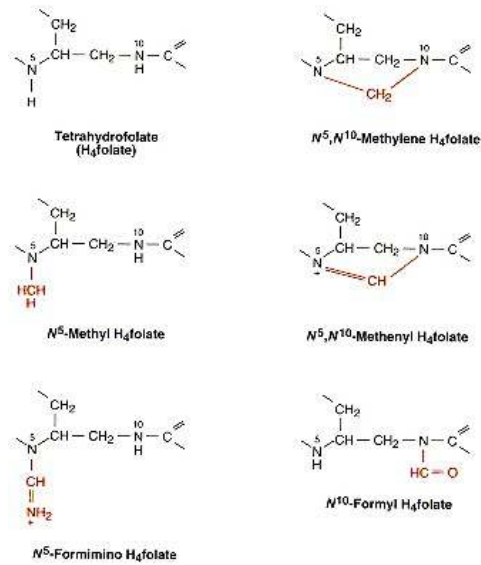

Figure 11.42
Active center of THF.

N⁵ is the site of attachment of methyl groups; N¹⁰ is the site for formyl and formimino; methylene and methenyl groups form bridges between N⁵ and N¹⁰.

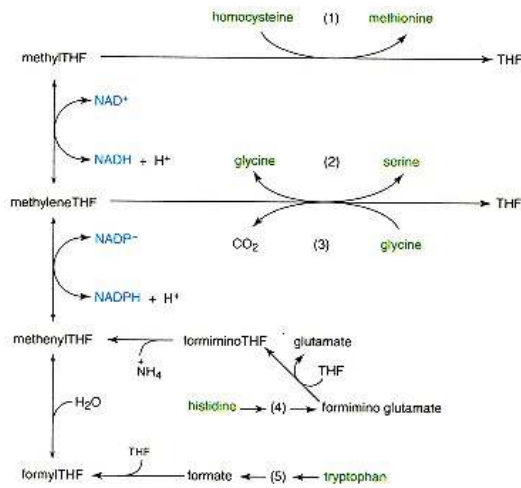

Figure 11.43
Inter-conversion of derivatized THF and roles in amino acid metabolism.

- (1) Methionine salvage,
- (2) serine hydroxymethyltransferase,
- (3) glycine cleavage complex,
- (4) histidine degradation, and
- (5) tryptophan metabolism.

methylene, and methyl groups (Figure 11.42). This occurs at the expense of pyridine nucleotide reduction or oxidation and occurs while the carbon moiety is attached to THF (Figure 11.43). The most oxidized forms, formyl and methenyl, are bound to N¹⁰ of the pteridine ring, methylene forms a bridge between N⁵ and N¹⁰, and methyl is bound to N⁵. The interconversions permit use of a carbon that is removed from a molecule in one oxidation state for addition in a different oxidation state to a different molecule (Fig. 11.42).

In reduction of the N⁵,N¹⁰-methylene bridge of tetrahydrofolate to a methyl group for transfer to the pyrimidine ring (Figure 11.44), a reaction found in **thymidylate synthesis** (Chapter 12), the reducing power comes not from pyridine nucleotide but from the pteridine ring itself. The resulting oxidized form of folate, dihydrofolate, has no physiological role and must be reduced back to tetrahydrofolate. The reaction is catalyzed by NADPH-dependent dihydrofolate reductase (see Clin. Corr. 11.4). The net result of the two reactions is oxidation of NADPH and reduction of the methylene bridge to a methyl group, analogous to the one-step reactions shown in Figure 11.43.

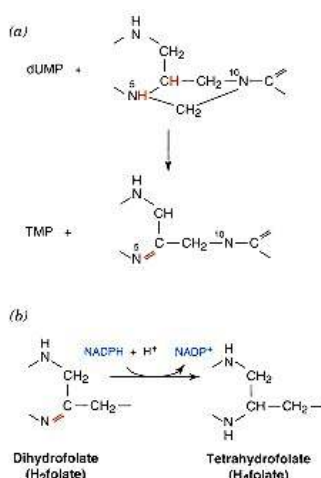

Figure 11.44

Reduction reactions involving THF.

(a) Reduction of methylene group on THF to a methyl group and transfer to dUMP to form TMP.

(b) Reduction of resulting dihydrofolate to tetrahydrofolate.

Threonine

Threonine is usually metabolized to lactate (Figure 11.45), but an intermediate in this pathway can undergo thiolysis with CoA to acetyl CoA and glycine. Thus the α -carbon atom of threonine can contribute to the one-carbon pool. In an alternative, but less common pathway, the enzyme described earlier in serine metabolism, **serine dehydratase** (see p. 459), converts threonine to α -ketobutyrate. A complex similar to pyruvate dehydrogenase metabolizes this to propionyl CoA.

Phenylalanine and Tyrosine

Tyrosine and **phenylalanine** are discussed together, since tyrosine results from hydroxylation of phenylalanine and is the first product in phenylalanine degradation. Because of this, tyrosine is not usually considered to be essential, whereas phenylalanine is. Three-quarters of ingested phenylalanine is metabo-

CLINICAL CORRELATION 11.4

Folic Acid Deficiency

The 100–200 mg of folic acid required daily by an average adult can theoretically be obtained easily from conventional Western diets. Deficiency of folic acid, however, is not uncommon. It may result from limited diets, especially when food is cooked at high temperatures for long periods, which destroys the vitamin. Intestinal diseases, notably celiac disease, are often characterized by folic acid deficiency caused by malabsorption. Inability to absorb folate is rare. Folate deficiency is usually seen only in newborns and produces symptoms of megaloblastic anemia. Of the few cases studied, some were responsive to large doses of oral folate but one required parenteral administration, suggesting a carrier-mediated process for absorption. Besides the anemia, mental and other central nervous system symptoms are seen in patients with folate deficiency, and all respond to continuous therapy although permanent damage appears to be caused by delayed or inadequate treatment. A classical experiment was carried out by a physician, apparently serving as his own experimental subject, to study the human requirements for folic acid. His diet consisted only of foods (boiled repeatedly to extract the water-soluble vitamins) to which vitamins (and minerals) were added, omitting folic acid. Symptoms attributable to folate deficiency did not appear for seven weeks, altered appearance of blood cells and formiminoglutamate excretion were seen only at 13 weeks, and serious symptoms (irritability, forgetfulness, and macrocytic anemia) appeared only after four months. Neurological symptoms were alleviated within two days after folic acid was added to the diet; the blood picture became normal more slowly. The occurrence of folic acid in essentially all natural foods makes deficiency difficult, and apparently a normal person accumulates more than adequate reserves of this vitamin. For pregnant women the situation is very different. Needs of the fetus for normal growth and development include constant, uninterrupted supplies of coenzymes (in addition to amino acids and other cell constituents). Recently, folate deficiency has been implicated in spina bifida.

Herbert, V. Experimental nutritional folate deficiency in man. *Trans. Assoc. Am. Physicians* 75:307, 1962.

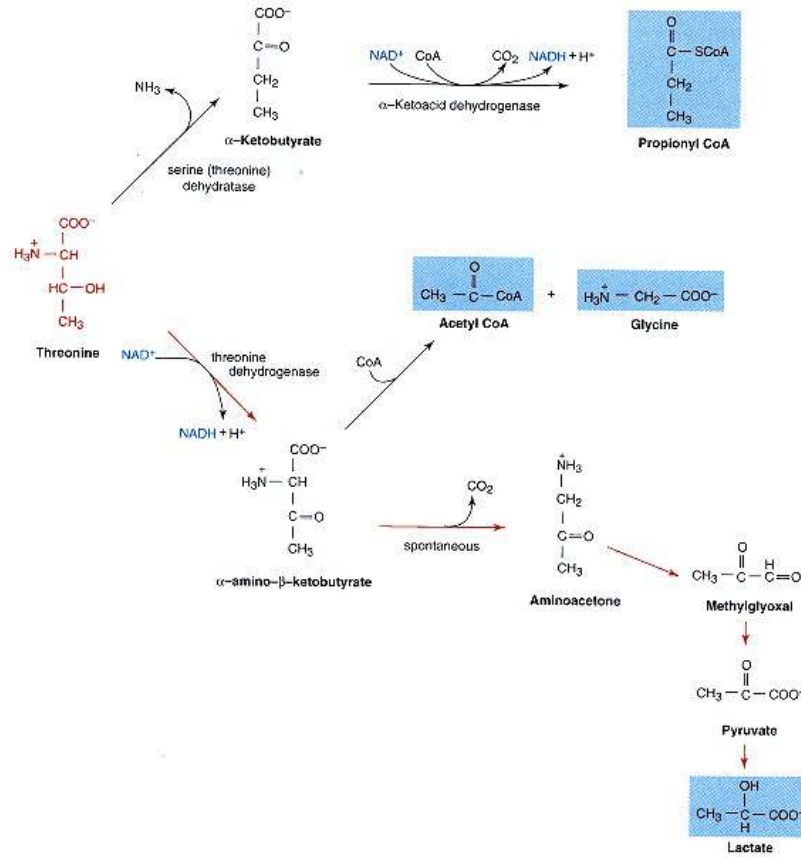

Figure 11.45
Outline of threonine metabolism.
 Major pathway is in color.

lized to tyrosine. This is catalyzed by **phenylalanine hydroxylase** (Figures 11.46 and Clin. Corr. 11.5), which is **tetrahydrobiopterin dependent** (Figure 11.48). This reaction occurs only in the direction of tyrosine formation, and phenylalanine cannot be synthesized from tyrosine. **Biopterin**, unlike folic

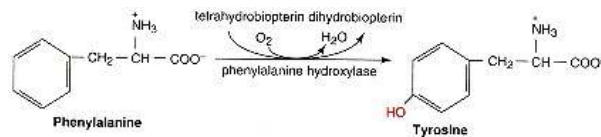

Figure 11.46
 Phenylalanine hydroxylase.

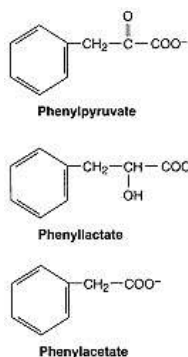

Figure 11.47
Minor products
of phenylalanine
metabolism.

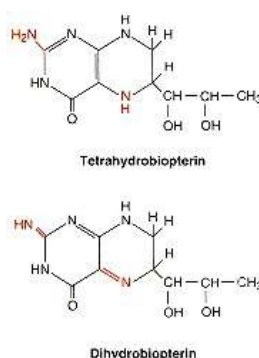

Figure 11.48
Biopterin.

The dihydro- (quinonoid) form is produced during oxidation of aromatic amino acids and is then reduced to the tetrahydro-form by a dehydrogenase using NADH and H⁺.

acid, which it resembles in containing a pteridine ring, is not a vitamin. It is synthesized from GTP. (See Clin. Corr. 11.5.)

Tyrosine Is the First Intermediate in Phenylalanine Metabolism

The first step in metabolism of tyrosine is transamination by **tyrosine amino-transferase** to *p*-hydroxyphenylpyruvate (Figure 11.49). The enzyme is inducible, its synthesis being increased by glucocorticoids and dietary tyrosine. ***p*-Hydroxyphenylpyruvate oxidase** produces **homogentisic acid**. This complex reaction involves decarboxylation, oxidation, migration of the carbon side chain, and hydroxylation. Ascorbic acid is required for at least one of these activities, but all four are catalyzed by the one enzyme. The aromatic ring is next cleaved by an iron-containing enzyme, homogentisate oxidase, to maleyla-

CLINICAL CORRELATION 11.5

Phenylketonuria

Phenylketonuria (PKU) is the most common disease caused by a deficiency of an enzyme of amino acid metabolism. The name comes from the excretion of phenylpyruvic acid, a phenylketone, in the urine. Phenyllactate is also excreted (Figure 11.47), as is an oxidation product of phenylpyruvate, phenylacetate, which gives the urine a "mousey" odor. These three metabolites are found only in trace amounts in urine in the healthy person. The symptoms of mental retardation associated with this disease can be prevented by a phenylalanine-free diet. Routine screening is required by governments in many parts of the world. Classical PKU is an autosomal recessive deficiency of phenylalanine hydroxylase. Over 170 mutations in the gene have been reported. In some cases there are severe neurological symptoms and very low IQ. These are generally attributed to toxic effects of phenylalanine, possibly because of reduced transport and metabolism of other aromatic amino acids in the brain due to competition from the high phenylalanine concentration. Another characteristic is light color of skin and eyes, due to underpigmentation because of tyrosine deficiency. Conventional treatment is to feed affected infants a synthetic diet low in phenylalanine, but including tyrosine, for about four to five years, and impose dietary protein restriction for several more years or for life. About 3% of infants with high levels of phenylalanine have normal hydroxylase but are defective in either synthesis or reduction of biopterin. Biopterin deficiency can be treated by addition to the diet. Deficiency in dihydrobiopterin reductase is more serious. Since biopterin is also necessary for the synthesis of catecholamines and serotonin, which function as neurotransmitters, central nervous system functions are more seriously affected and treatment at this time includes administration of precursors of serotonin and catecholamines.

Brewster, T. G., Moskowitz, M. A., Kaufman, S., et al. Dihydrobiopterin reductase deficiency associated with severe neurologic disease and mild hyperphenylalanemia. *Pediatrics* 63:94, 1979; Kaufman, S. Regulation of the activity of hepatic phenylalanine hydroxylase. *Adv. Enzyme Regul.* 25:37, 1986; Scriver, C. R. and Clow, L. L. Phenylketonuria: epitome of human biochemical genetics. *N. Engl. J. Med.* 303:1336, 1980; Woo, S. L. C. Molecular basis and population genetics of phenylketonuria. *Biochemistry* 28:1, 1989.

cetoacetate. This will isomerize from cis to trans to give fumarylacetoacetate, in a reaction catalyzed by maleylacetoacetate isomerase, an enzyme that seems to require glutathione for activity. Fumarylacetoacetate is then cleaved to fumarate and acetoacetate. Fumarate can be further utilized in the TCA cycle for energy or for gluconeogenesis. Acetoacetate can be used, as acetyl CoA, for lipid synthesis or energy. (See Clin. Corr. 11.6.)

Dopamine, Epinephrine, and Norepinephrine Are Derivatives of Tyrosine

Most tyrosine not incorporated into proteins is metabolized to acetoacetate and fumarate. Some is used as precursor of **catecholamines**. The eventual metabolic fate of tyrosine carbons is determined by the first step in each pathway. Catecholamine synthesis (Figure 11.50) starts with **tyrosine hydroxylase**, which, like phenylalanine and tryptophan hydroxylase, is dependent on tetrahydrobiopterin. All three are affected by biopterin deficiency or a defect in dihydrobiopterin reductase (see Figure 11.48). Tyrosine hydroxylase produces dihydroxyphenylalanine, also known as DOPA, dioxophenylalanine. **DOPA decarboxylase**, with pyridoxal phosphate as cofactor, forms **dopamine**, the active neurotransmitter, from DOPA. In the substantia nigra and some other parts of the brain, this is the last enzyme in this pathway (see Clin. Corr. 11.7). The adrenal medulla converts dopamine to **norepinephrine** and **epinephrine**

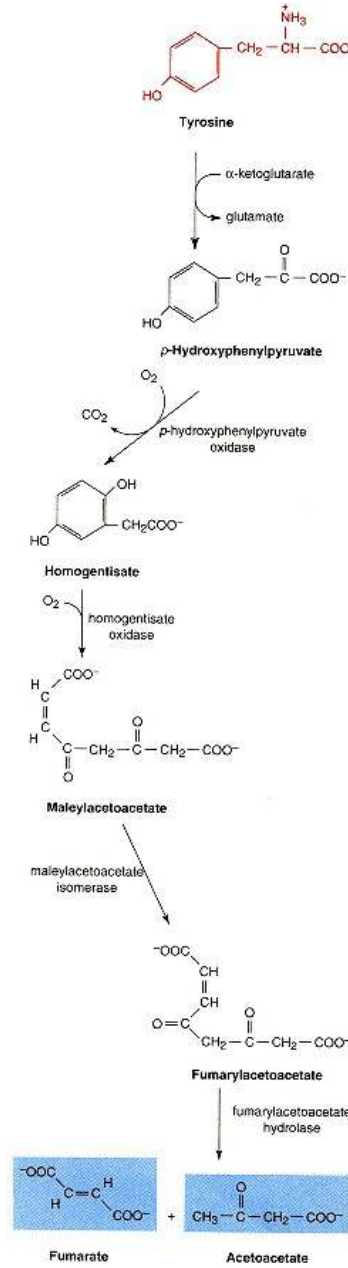

Figure 11.49
Degradation of tyrosine.

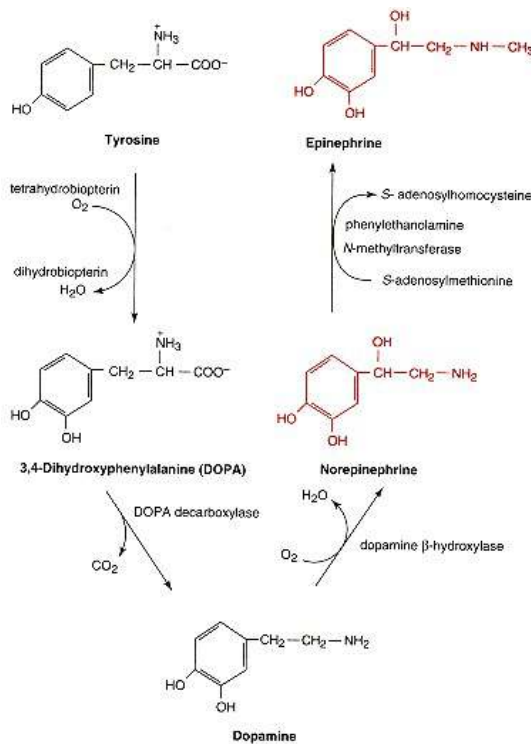

Figure 11.50
Synthesis of catecholamines.

CLINICAL CORRELATION 11.6**Disorders of Tyrosine Metabolism****Tyrosinemias**

The absence or deficiency of tyrosine aminotransferase produces accumulation and excretion of tyrosine and metabolites. The disease, oculocutaneous or type II tyrosinemia, results in eye and skin lesions and mental retardation. Type I, hepatorenal tyrosinemia, is more serious, involving liver failure, renal tubular dysfunction, rickets, and polyneuropathy, caused by a deficiency of fumarylacetoacetate hydrolase. Accumulation of fumarylacetoacetate and maleylacetate, both of which are alkylating agents, can lead to DNA alkylation and tumorigenesis. Both diseases are autosomal recessive and rare.

Alcaptonuria

The first condition identified as an "inborn error of metabolism" was alcaptonuria. Individuals deficient in homogentisate oxidase excrete almost all ingested tyrosine as the colorless homogentisic acid in their urine. This auto-oxidizes to the corresponding quinone, which polymerizes to form an intensely dark color. Concern about the dark urine is the only consequence of this condition early in life. Homogentisate is slowly oxidized to pigments that are deposited in bones, connective tissue, and other organs, a condition called ochronosis because of the ochre color of the deposits. This is thought to be responsible for the associated arthritis, especially in males. The study of alcaptonuria by Archibald Garrod, who first indicated its autosomal recessive genetic basis, includes an unusual historical description of the iatrogenic suffering of the first patient treated for the condition, which is frequently benign.

Albinism

Skin and hair color are controlled by an unknown number of genetic loci in humans and exist in infinite variation; in mice, 147 genes have been identified in color determination. Many conditions have been described in which the skin has little or no pigment. The chemical basis is not established for any except classical albinism, which results from a lack of tyrosinase. Lack of pigment in the skin makes albinos sensitive to sunlight, increasing carcinoma of the skin in addition to burns; lack of pigment in the eyes may contribute to photophobia.

Fellman, J. H., Vanbellinghan, P. J., Jones, R. T., and Koler, R. D. Soluble and mitochondrial tyrosine aminotransferase. Relationship to human tyrosinemia. *Biochemistry* 8:615, 1969; Kvittingen, E. A. Hereditary tyrosinemia type I. An overview. *Scand. J. Clin. Lab. Invest.* 46:27, 1986

(also called **adrenaline**). The methyl group of epinephrine is derived from *S*-adenosylmethionine (see p. 469).

Brain plasma tyrosine regulates norepinephrine formation. Estrogens decrease tyrosine concentration and increase tyrosine aminotransferase activity, diverting tyrosine into the catabolic pathway. Furthermore, estrogen sulfate competes for the pyridoxal phosphate site on DOPA decarboxylase. These three effects combined may help explain mood variations during the menstrual cycle. Tyrosine is therapeutic in some cases of depression and stress. Its transport appears to be reduced in skin fibroblasts from schizophrenic patients, indicating other roles for tyrosine derivatives in mental disorders.

CLINICAL CORRELATION 11.7**Parkinson's Disease**

Usually in people over the age of 60 years but occasionally earlier, tremors may develop that gradually interfere with motor function of various muscle groups. This condition is named for the physician who described "shaking palsy" in 1817. The primary cause is unknown, and there may be more than one etiological agent. The defect is caused by degeneration of cells in certain small nuclei of the brain called substantia nigra and locus caeruleus. Their cells normally produce dopamine as a neurotransmitter, the amount released being proportional to the number of surviving cells. A dramatic outbreak of parkinsonism occurred in young adult drug addicts using a derivative of pyridine (methylphenyl-tetrahydropyridine, MPTP). It (or a contaminant produced during its manufacture) appears to be directly toxic to dopamine-producing cells of substantia nigra. Symptomatic relief, often dramatic, is obtained by administering DOPA, the precursor of dopamine. Clinical problems developed when DOPA (L-DOPA, levo-DOPA) was used for treatment of many people who have Parkinson's disease. Side effects included nausea, vomiting, hypotension, cardiac arrhythmias, and various central nervous system symptoms. These were explained as effects of dopamine produced outside the central nervous system. Administration of DOPA analogs that inhibit DOPA decarboxylase but are unable to cross the blood-brain barrier has been effective in decreasing side effects and increasing effectiveness of the DOPA. The interactions of the many brain neurotransmitters are very complex, cell degeneration continues after treatment, and elucidation of the major biochemical abnormality has not yet led to complete control of the disease. Recently, attempts have been made at treatment by transplantation of fetal adrenal medullary tissue into the brain. The adrenal tissue synthesizes dopamine and improves the movement disorder.

Calne, D. B., and Langston, J. W. Aetiology of Parkinson's disease. *Lancet* 2:1457, 1983; and Cell and tissue transplantation into the adult brain. *Ann. N.Y. Acad. Sci.* 495, 1987.

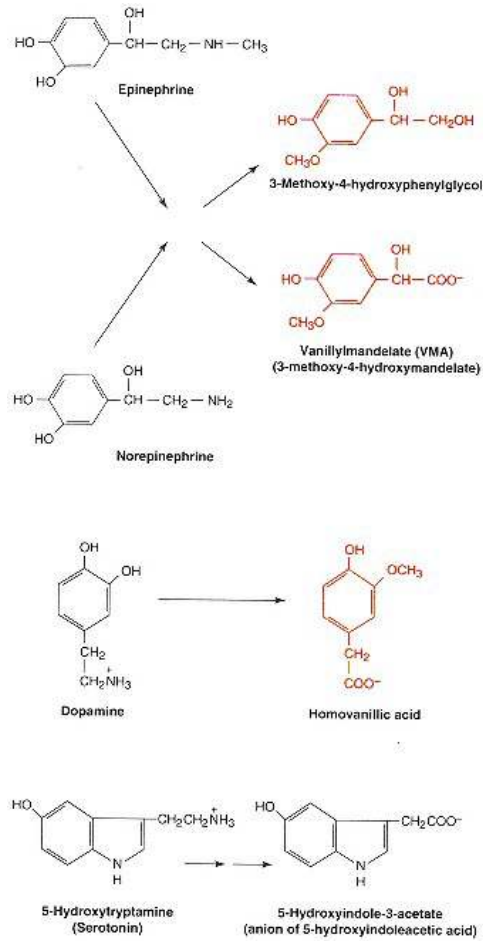

Figure 11.51
Major urinary excretion products of dopamine, epinephrine, norepinephrine, and serotonin.

Catecholamines are metabolized by **monoamine oxidase** and catecholamine **O-methyltransferase**. Major metabolites are shown in Figure 11.51. Absence of these metabolites in urine is diagnostic of a deficiency in synthesis of catecholamines. Lack of synthesis of serotonin (see p. 866) is indicated by lack of 5-hydroxyindole-3-acetic acid, shown in the same figure.

Tyrosine Is Involved in Synthesis of Melanin, Thyroid Hormone, and Quinoproteins

Conversion of tyrosine to melanin requires **tyrosinase**, a copper-containing protein (Figure 11.52a). The two-step reaction uses DOPA as a cofactor internal to the reaction and produces **dopaquinone**. During melanogenesis, following

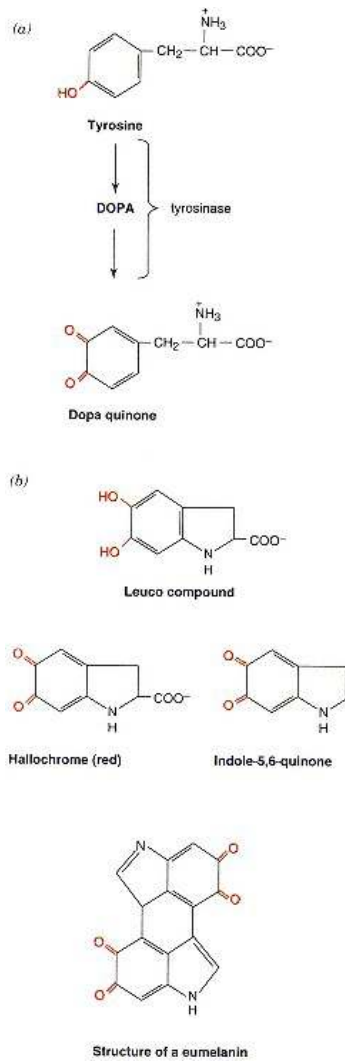

Figure 11.52
(a) Tyrosinase uses DOPA as a cofactor/intermediate;
(b) some intermediates in melanin synthesis and an example of the family of black eumelanins.

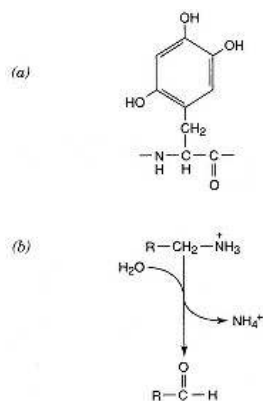

Figure 11.53
(a) Topaquinone and
(b) amine oxidase reaction.

exposure to UVB light, tyrosinase and a protein called tyrosinase-related protein, which may function in posttranslational modification of tyrosinase, are induced. A lack of tyrosinase activity produces **albinism**.

There are various types of **melanin** (Figure 11.52b). All are aromatic quinones and the conjugated bond system gives rise to color. The dark pigment that is usually associated with melanin is eumelanin, from the Greek for "good melanin." Other melanins are yellow or colorless. The role of tyrosine residues of thyroglobulin in thyroid hormone synthesis is presented in the chapter on hormones (Chapter 20).

Some proteins use a modified tyrosine residue as a prosthetic group in oxidation–reduction reactions. The only example reported in humans is **topaquinone** (trihydroxyphenylalanylquinone), which is present in some plasma amine oxidases (Figure 11.53).

Methionine and Cysteine

De novo synthesis of **methionine** does not occur and methionine is essential. **Cysteine**, however, is synthesized by transfer of the sulfur atom derived from methionine to the hydroxyl group of serine. As long as the supply of methionine is adequate, cysteine is nonessential. The disposition of individual atoms of methionine and cysteine is a prime example of how cells regulate pathways to fit their immediate needs for energy or for other purposes. Conditions under which various pathways are given preference will be emphasized.

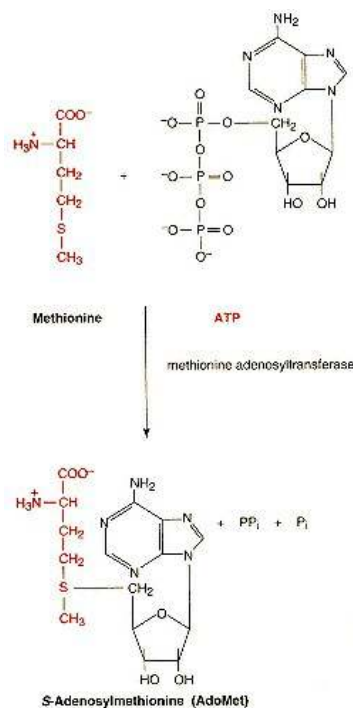

Figure 11.54
Synthesis of AdoMet.

Methionine Is First Reacted with Adenosine Triphosphate

When excess methionine is present its carbons can be used for energy or for gluconeogenesis, and the sulfur retained as the sulfhydryl of cysteine. Figure 11.54 shows the first step, catalyzed by **methionine adenosyltransferase**. All phosphates of ATP are lost, and the product is **S-adenosylmethionine** (abbreviated **AdoMet**, or **SAM** in older references). The sulfonium ion is highly reactive, and the methyl is a good leaving group. AdoMet as a methyl group donor will be described below. After a methyltransferase removes the methyl group, the resulting **S-adenosylhomocysteine** is cleaved by **adenosylhomocysteinase** (Figure 11.55). Note that homocysteine is one carbon longer than cysteine. Although the carbons are destined for intermediary metabolism, the

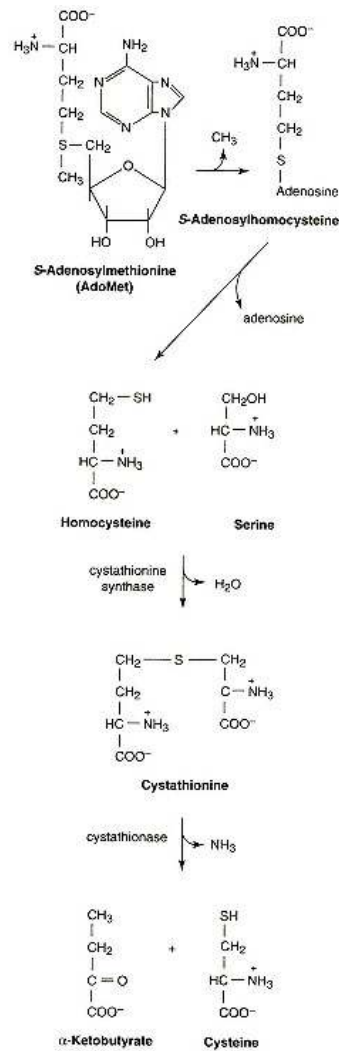

Figure 11.55
Synthesis of cysteine from
S-adenosylmethionine.

sulfur, a more specialized atom, will be conserved through transfer to serine to form cysteine. This requires the pyridoxal phosphate-dependent **cystathionine synthase** and **cystathionase** (Figure 11.55; see Clin. Corr. 11.8). Since the bond to form cystathionine is made on one side of the sulfur, and that cleaved is on the other side, the result is a **transsulfuration** (see Clin. Corr. 11.9). Homocysteine produces α-ketobutyrate and ammonia. α-Ketobutyrate is decarboxylated by a multienzyme complex resembling pyruvate dehydrogenase to

CLINICAL CORRELATION 11.8**Hyperhomocysteinemia and Atherogenesis**

Deficiency of cystathionine synthase causes homocysteine to accumulate, and remethylation leads to high levels of methionine. Many minor products of these amino acids are formed and excreted. No mechanism has been established to explain why accumulation of homocysteine should lead to some of the pathological changes. Homocysteine may react with and block lysyl aldehyde groups on collagen. The lens of the eye is frequently dislocated some time after the age of 3, and other ocular abnormalities often occur. Osteoporosis develops during childhood. Mental retardation is frequently the first indication of this deficiency. Attempts at treatment include restriction of methionine intake and feeding of betaine (or its precursor, choline). In some cases significant improvement has been obtained by feeding pyridoxine (vitamin B₆), suggesting that the deficiency may be caused by more than one type of gene mutation; one type may affect the K_m for pyridoxal phosphate and others may alter the K_m for other substrates, V_{max} , or the amount of enzyme. A theory relating hyperhomocysteinemia to atherogenesis has been proposed. Excess homocysteine can form homocysteine thiolactone, a highly reactive intermediate, which thiolates free amino groups in low density lipoproteins (LDLs) and causes them to aggregate and be endocytosed by macrophages. The lipid deposits form atheromas. Homocysteine can have other effects, including lipid oxidation and platelet aggregation, which in turn lead to fibrosis and calcification of atherosclerotic plaques. About one-quarter of patients with atherosclerosis who exhibit none of the other risk factors (such as smoking or oral contraceptive therapy) have been found to be deficient in cystathionine synthase activity.

Kaiser-Kupfer, M. I., Fujikawa, L., Kuwabara, T., et al. Removal of corneal crystals by topical cysteamine in nephrotic cystinosis. *N. Engl. J. Med.* 316:775, 1987; McCully, K. S. Chemical pathology of homocysteine I. Atherogenesis. *Ann. Clin. Lab. Sci.* 23:477, 1993.

yield propionyl CoA, which is then converted to succinyl CoA as described on page 479.

When the need is for energy, and not for cysteine, homocysteine produced in the above pathway is metabolized by **homocysteine desulfhydrase** to α -ketobutyrate, NH₃, and H₂S (Figure 11.56).

S-Adenosylmethionine Is a Methyl Group Donor

The role of tetrahydrofolate as a one-carbon group donor has been described (see p. 460). Although this cofactor could in theory serve as a source of methyl groups, the vast majority of methyltransferase reactions utilize **S-adenosylmethionine**. Methyl group transfer from AdoMet to a methyl acceptor is irre-

CLINICAL CORRELATION 11.9**Other Diseases of Sulfur Amino Acids**

Congenital deficiency of any of the enzymes involved in transsulfuration results in accumulation of sulfur-containing amino acids. Hypermethioninemia has been attributed to deficiency of methionine adenosyltransferase, probably caused by a K_m mutant that requires higher than normal concentrations of methionine for saturation, but functions normally in methylation reactions. Lack of cystathionase does not seem to cause any clinical abnormalities other than cystathioninuria. The first reported case of this deficiency was about a mentally retarded patient and the retardation was attributed to the deficiency. Apparently the mental retardation was coincidental, the condition being benign. The amount of cysteine synthesized in these deficiencies is unknown, but treatment with a low-methionine diet for hypermethioninemia is unnecessary.

Diseases Involving Cystine

Cystinuria is a defect of membrane transport of cystine and basic amino acids (lysine, arginine, and ornithine) that results in their increased renal excretion. Extracellular sulfhydryl compounds are quickly oxidized to disulfides. Low solubility of cystine results in crystals and the formation of calculi, a serious feature of this disease. Treatment is limited to removal of stones, prevention of precipitation by drinking large amounts of water or alkalinizing the urine to solubilize cystine, or formation of soluble derivatives by conjugation with drugs. Much more serious is cystinosis in which cystine accumulates in lysosomes. The stored cystine forms crystals in many cells, with a serious loss of function of the kidneys, usually causing renal failure within ten years. The defect is believed to be in the cystine transporter of lysosomal membranes.

Seashore, M. R., Durant, J. L., and Rosenberg, L. E. Studies on the mechanisms of pyridoxine responsive homocystinuria. *Pediatr. Res.* 6:187, 1972; Mudd, S. H. The natural history of homocystinuria due to cystathionine β -synthase deficiency. *Am. J. Hum. Genet.* 37:1, 1985; and Frimpter, G. W. Cystathionuria: nature of the defect. *Science* 149:1095, 1965.

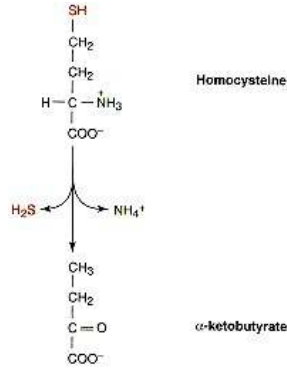

Figure 11.56
Homocysteine desulfhydrase.

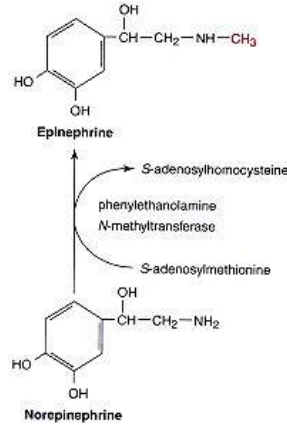

Figure 11.57
S-adenosylmethyltransferase reaction.

versible. An example is shown in Figure 11.57. *S*-Adenosylhomocysteine left after methyl group transfer can be metabolized to cysteine, α -ketobutyrate, and ammonia. When cells need to resynthesize methionine, since the methyltransferase reaction is irreversible, another enzyme is required (Figure 11.58). **Homocysteine methyltransferase** is one of two enzymes known to require a vitamin B₁₂ cofactor (the other is described on p. 479). The methyl group comes from *N*⁵-**methyltetrahydrofolate**. This is the only reaction known that uses this form of tetrahydrofolate as a methyl donor. The net result of reactions in Figures 11.57 and 11.58 is donation of a methyl group and regeneration of methionine under methionine-sparing conditions. A minor salvage pathway uses a methyl group from betaine instead of *N*⁵-methyltetrahydrofolate.

AdoMet Is the Precursor of Spermidine and Spermine

Propylamine added to putrescine (see p. 459) to form spermidine and spermine is also derived from AdoMet, leaving methylthioadenosine. Putrescine is formed by decarboxylation of ornithine (see p. 459), and with propylamine forms spermidine. Addition of another propylamine gives spermine (Figure 11.59). The methylthioadenosine that remains can be used to resynthesize methionine. Much of the polyamine needed by the body is provided by microflora in the gut or from the diet and is carried by the enterohepatic circulation. Meat has

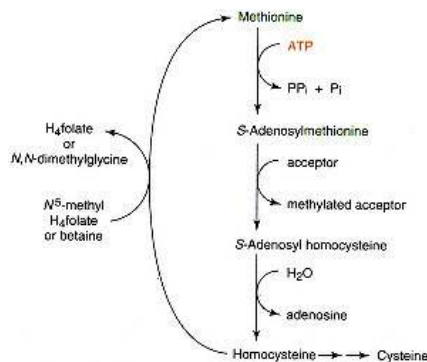

Figure 11.58
Resynthesis of methionine, a methylcobalamin-dependent reaction.

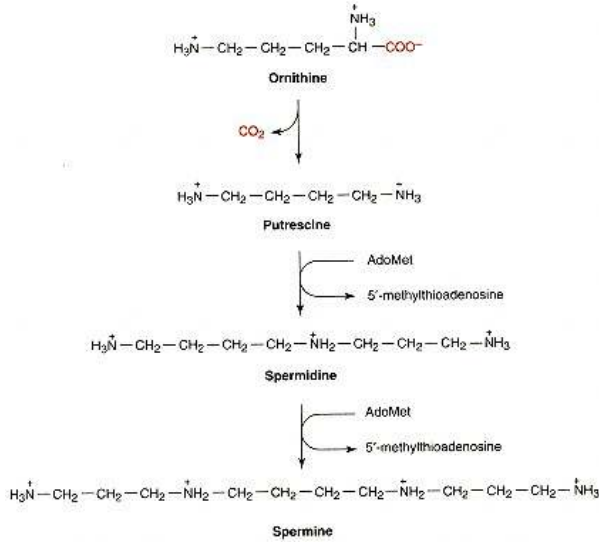

Figure 11.59
Polyamine synthesis.

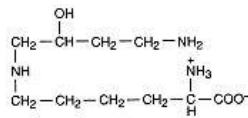

Figure 11.60
Hypusine.

a high content of putrescine, but other foods contain more spermidine and spermine.

The butylamino group of spermidine is used for posttranslational modification of a specific lysine residue in eIF-4D, an initiation factor for eukaryotic protein synthesis. The group is then hydroxylated, and the modified residue that results is called **hypusine** (Figure 11.60).

Metabolism of Cysteine Produces Sulfur-Containing Compounds

Cysteine, derived from the sulfur of homocysteine and a molecule of serine, is metabolized in several ways. The pathway chosen is determined by the needs of the cell. The major metabolite is **cysteinesulfinate** (Figure 11.61). This is further metabolized to sulfite and pyruvate, or to hypotaurine and taurine.

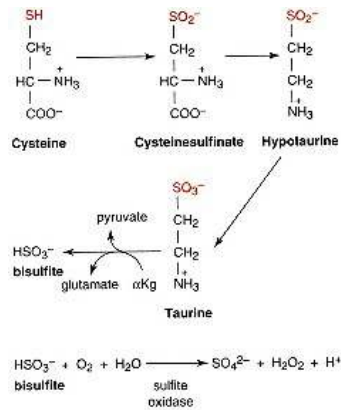

Figure 11.61
Formation of taurine and sulfate from cysteine.

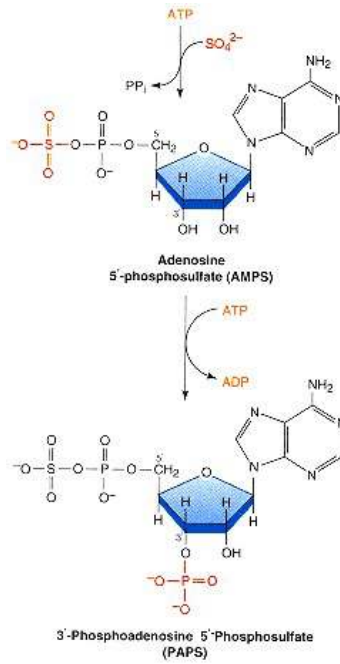

Figure 11.62
Synthesis of PAPS.

Taurine is an abundant intracellular free amino acid, but its exact role is unknown. It appears to play a necessary role in brain development. It forms conjugates with bile acids (see p. 418) and may enhance bile flow and increase cholesterol clearance by the liver. Taurine may also play a role in salvaging toxic intermediates, in regulating intracellular calcium, and, because of its abundance, in osmoregulation.

Sulfite produced from cysteine metabolism can be oxidized to **sulfate** (Figure 11.61), and this can be used in formation of **3'-phosphoadenosine-5'-phosphosulfate (PAPS)**, the source of sulfate groups for addition to biological molecules (Figure 11.62).

Another reaction of cysteine metabolism catalyzed by cystathionase moves the sulfur from one cysteine to another cysteine (Figure 11.63) to form **thio-cysteine**. Thiosulfate is formed from cysteine as shown in Figure 11.64. An enzyme called **rhodanese** can incorporate a sulfur from thiosulfate or thiocysteine into other molecules such as cyanide ion (Figure 11.65).

Tryptophan

Metabolism of **tryptophan** has many branch points. The dominant or oxidative pathway of tryptophan in the human (Figure 11.66, in color) starts with oxidation of tryptophan to *N*-formylkynurenine by a heme-containing enzyme, **tryptophan dioxygenase**, also called **tryptophan pyrrolase** or **tryptophan oxygenase**, because the pyrrole ring is cleaved in the reaction. Tryptophan dioxygenase is induced by glucocorticoids and glucagon. It is found in liver; other tissues contain a similar enzyme called indolamine dioxygenase, which is less substrate specific. Formamidase then hydrolyzes formylkynurenine to formate and kynurenine. At this point the pathway begins to branch. In the dominant pathway, reactions lead to 3-hydroxykynurenine, 3-hydroxyanthranilic acid and alanine, amino-carboxymuconic semialdehyde, and, by decarboxylation, to aminomuconic semialdehyde. This can be further metabolized in several steps to glutarate and eventually acetoacetyl CoA, or recycled nonenzymatically to **picolinic acid**, which is excreted in the urine.

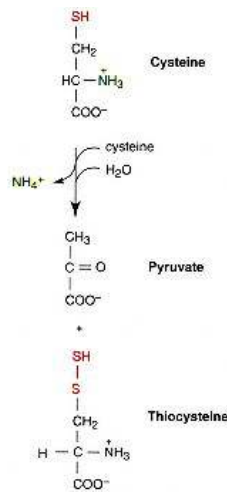

Figure 11.63
Synthesis of thiocysteine.

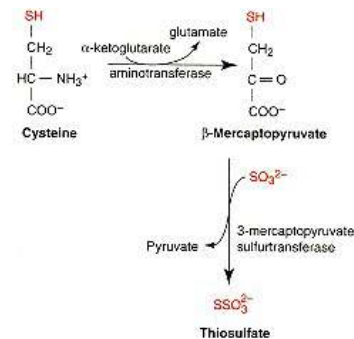

Figure 11.64
Formation of thiosulfate.

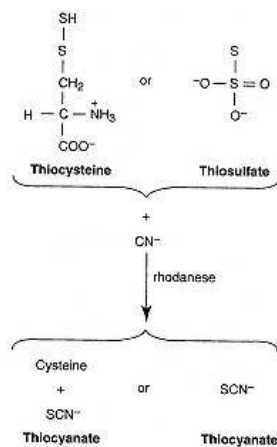

Figure 11.65
Detoxification of cyanide by products of cysteine metabolism.

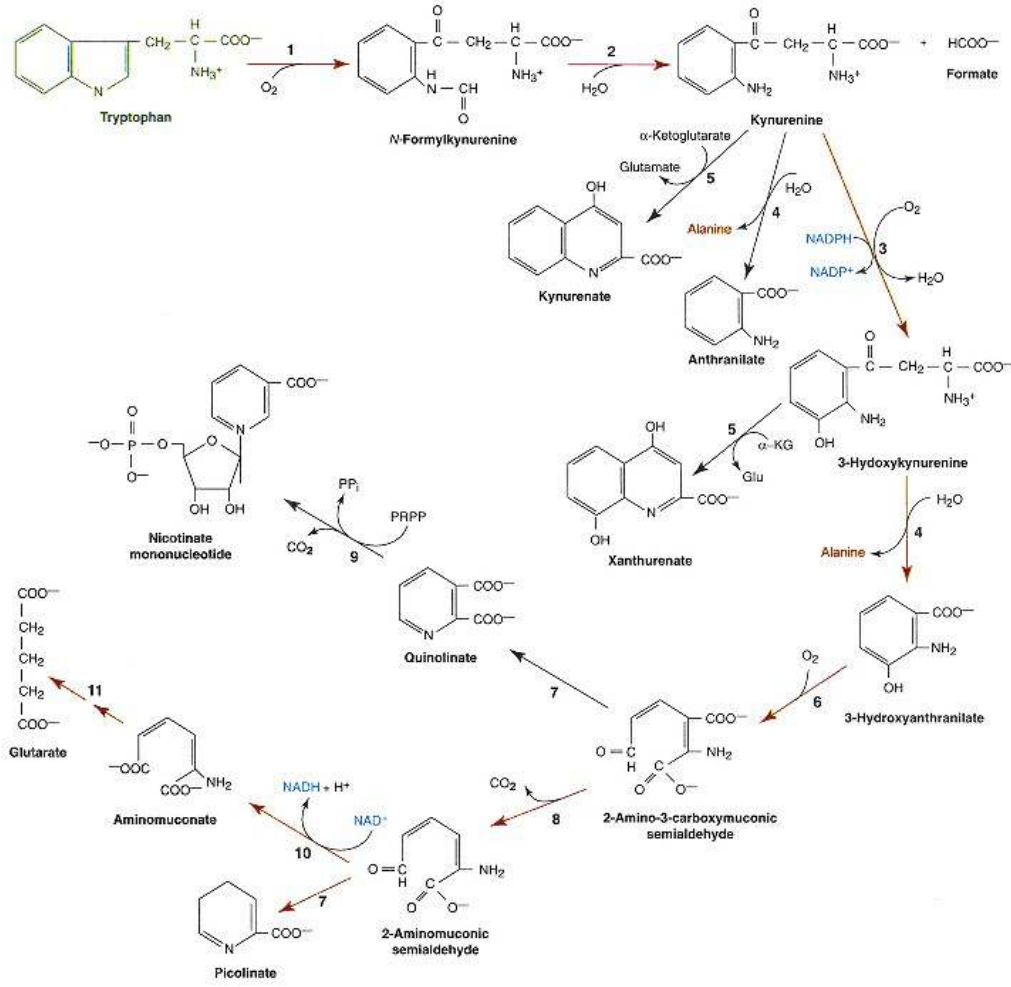

Figure 11.66
Metabolism of tryptophan.
 Major pathway is shown in red. Enzymes indicated by number are
 (1) tryptophan oxygenase,
 (2) kynurenine formamidase,
 (3) kynurenine hydroxylase,
 (4) kynureninase,
 (5) aminotransferase,
 (6) 3-hydroxyanthranilate oxidase,
 (7) spontaneous nonenzymatic reaction,
 (8) picolinate carboxylase,
 (9) quinolinate phosphoribosyltransferase,
 (10) aldehyde dehydrogenase, and
 (11) complex series of reactions.

Tryptophan Is a Precursor of NAD

Tryptophan is the precursor of approximately 50% of the body's pyridine nucleotides. The rest is obtained from the diet. The branch point leading to nicotinate mononucleotide can be seen in Figure 11.66 at the stage of amino-carboxymuconic semialdehyde. The enzyme that forms 2-aminomuconic semi-

aldehyde, **picolinate carboxylase**, from this compound has a low K_m and is easily saturated with substrate. Since picolinate carboxylase has low activity in liver, some amino-carboxymuconic semialdehyde is cyclized in a nonenzymatic reaction to quinolinic acid. Phosphoribosylpyrophosphate provides a ribonucleotide moiety and the final step is a decarboxylation leading to nicotinate mono-nucleotide. Note that the nicotinic acid ring is synthesized as a part of a nucleotide. Because **kynurenine hydroxylase** is inhibited by estrogen, women are more susceptible to **pellagra**, the disease produced by niacin deficiency (from the Italian *pelle*, skin, and *agra*, rough).

Pyridoxal Phosphate Has a Prominent Role in Tryptophan Metabolism

Many enzymes in this lengthy pathway are pyridoxal phosphate dependent. **Kynureninase** is one of them and is affected by a vitamin B₆ deficiency (Figure 11.66), resulting in excess kynurenine and xanthurenate excretion and giving urine a greenish-yellow color. This is a diagnostic symptom of vitamin B₆ deficiency.

Kynurenine Gives Rise to Neurotransmitters

Another pathway that kynurenine can follow is transamination and condensation of the side chain to form a two-ring compound, kynurenic acid. This reaction is also depicted in Figure 11.66. **Kynurenic acid**, its decarboxylated metabolite **kynuramine**, and **quinolinate** have all been shown to act as tryptophan-derived neurotransmitters, possibly as antiexcitotoxics and anticonvulsives.

Serotonin and Melatonin Are Tryptophan Derivatives

Serotonin (5-hydroxytryptamine) results from hydroxylation of tryptophan by a tetrahydrobiopterin-dependent enzyme and decarboxylation by a pyridoxal phosphate-containing enzyme (Figure 11.67a). It is a neurotransmitter in brain and causes contraction of smooth muscle of arterioles and bronchioles. It is found widely in the body and may have other physiological roles. **Melatonin**, a sleep-inducing molecule, is **N-acetyl-5-methoxytryptamine** (Figure 11.67b). The acetyltransferase needed for its synthesis is present in pineal gland and retina. Melatonin is involved in regulation of circadian rhythm, being synthesized mostly at night. It appears to function by inhibiting synthesis and secretion of other neurotransmitters such as dopamine and GABA (see p. 866).

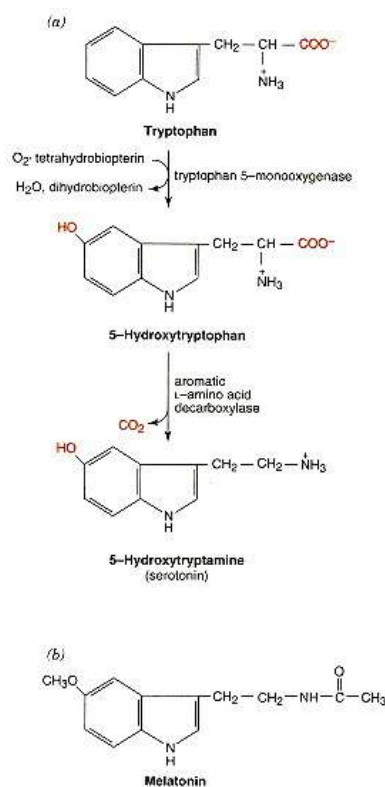

Figure 11.67

(a) Synthesis of serotonin (5-hydroxytryptamine) and
(b) structure of melatonin.

Tryptophan Induces Sleep

Ingestion of foods rich in tryptophan leads to sleepiness because serotonin is also sleep-inducing. Reducing availability of tryptophan in the brain can interfere with sleep. Tryptophan availability is reduced when other amino acids compete with it for transport through the blood-brain barrier. Elevated plasma concentrations of other amino acids, after a high-protein meal, diminish transport of tryptophan and induce wakefulness. The sleep-inducing effect of carbohydrates is due to decreased plasma amino acid levels, since carbohydrate stimulates release of insulin, and insulin causes removal of amino acids from plasma and uptake into muscle. This alleviates competition and increases the amount of tryptophan that can enter the brain. Strangely, extra serotonin appears to lead to sleepiness in females, but only calmness in males.

Branched-Chain Amino Acids

Metabolism of **branched-chain amino acids (BCAAs)**—**valine**, **isoleucine**, and **leucine**—is unusual, being initiated in muscle. NADH is formed during their metabolism, making them an excellent source of energy. BCAA aminotransferase is present at a much higher concentration in muscle than liver. Although

the three amino acids produce different products, the first steps in their metabolism are similar.

Initial Reactions of BCAA Metabolism Are Shared

BCAA aminotransferase exists in three isozymes distributed differently between tissues, sometimes found in cytosol and sometimes in mitochondria (Figure 11.68). Two handle all three BCAAs, and one is specific for leucine and methionine. Starvation induces the muscle aminotransferases but does not affect these enzymes in liver. The resulting α -keto branched-chain acids are oxidatively decarboxylated by an inner mitochondrial membrane enzyme complex similar to the pyruvate dehydrogenase complex, which produces NADH and CO_2 . When phosphorylated the dehydrogenase component of the complex has some activity, but this is greatly increased by dephosphorylation. All three α -keto branched-chain acids appear to be metabolized by the same enzyme. The more active form is found in liver in the fed state, and in muscle during starvation, reflecting the metabolism of dietary BCAAs by liver, and of muscle BCAAs to provide energy during fasting. The resulting CoA compounds are one carbon shorter than the original amino acids and are next acted on by an enzyme that resembles the first dehydrogenase found in fatty acid β -oxidation.

Pathways of Valine and Isoleucine Metabolism Are Similar

Valine and isoleucine continue down a common pathway, with addition of water across the double bond to form a hydroxylated intermediate (Figure 11.69). The hydroxyl group on the isoleucine derivative is oxidized by NAD^+ followed by thiolysis to give acetyl CoA and propionyl CoA. The valine derivative loses CoA and is oxidized by NAD^+ to methylmalonate semialdehyde, which is then converted to propionyl CoA.

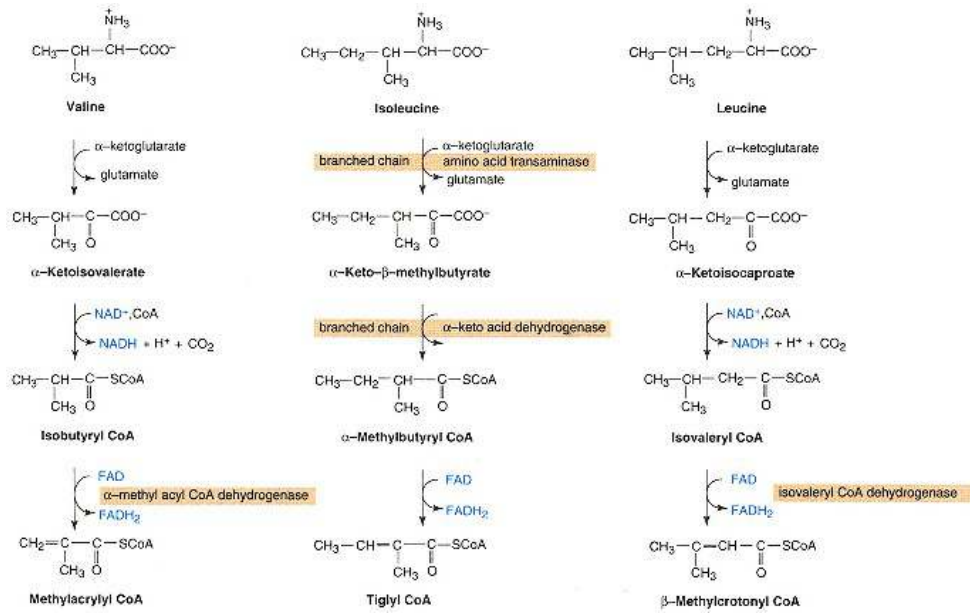

Figure 11.68
Common reactions in degradation of branched-chain amino acids.

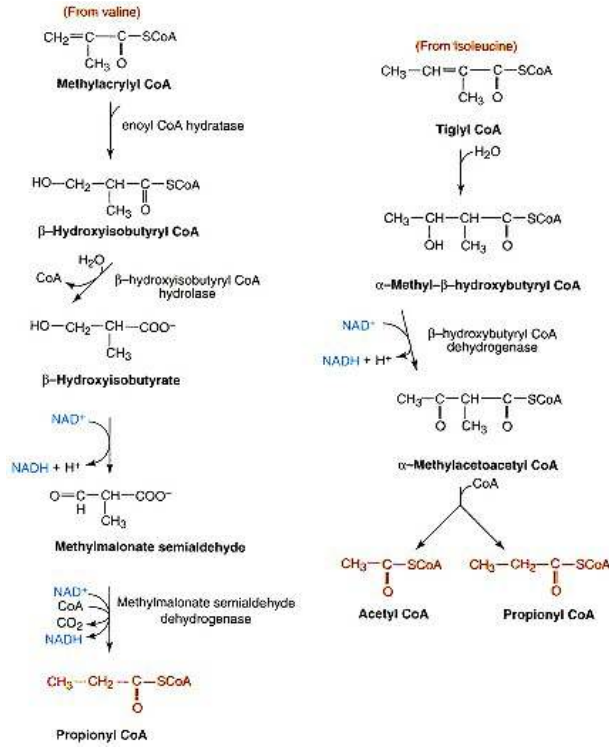

Figure 11.69
 Terminal reactions in degradation of valine and isoleucine.

The Leucine Pathway Differs from Those of the Other Two Branched-Chain Amino Acids

The position of the methyl side chain in leucine prohibits the oxidation step found in the metabolism of the other BCAAs (Figure 11.70). The double bond-containing derivative is carboxylated, hydroxylated, and cleaved to acetoacetate and acetyl CoA. One intermediate is **β-hydroxy-β-methylglutaryl CoA**, an

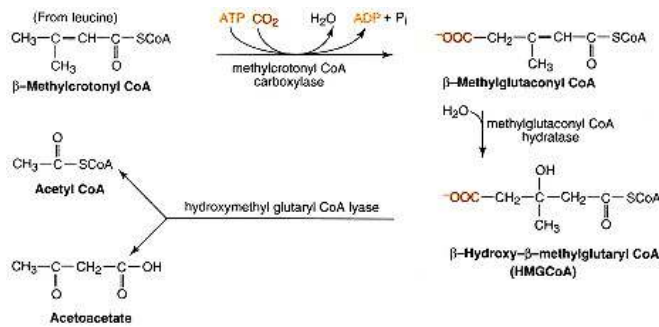

Figure 11.70
 Terminal reactions of leucine degradation.

intermediate in cytosolic sterol synthesis (Chapter 10). Since BCAA degradation occurs in mitochondria the two pools do not mix. Leucine also has a minor alternative pathway (not shown), which results in excretion of 3-hydroxyvaleric acid, and can be utilized in the case of blockage in the leucine degradative pathway (Clin. Corr. 11.10).

CLINICAL CORRELATION 11.10

Diseases of Metabolism of Branched-Chain Amino Acids

Enzyme deficiencies in catabolism of branched-chain amino acids are not common. In general, they produce acidosis in newborns or young children. Very rare instances have been reported of hypervalinemia and hyperleucine-isoleucinemia. It has been suggested that the two conditions indicate existence of specific aminotransferases for valine and for leucine and isoleucine. Alternatively, mutation could alter the specificity of a single enzyme. The most common abnormality is deficiency of branched-chain keto acid dehydrogenase complex activity. There are several variations, but all patients excrete the branched-chain α -keto acids and corresponding hydroxy acids and other side products; an unidentified product imparts characteristic odor associated with the name maple syrup urine disease. Some cases respond to high doses of thiamine. A large percentage show serious mental retardation, ketoacidosis, and short life span. Dietary treatment to reduce the branched-chain ketoacidemia is effective in some cases. Some cases have been reported of deficiency of enzymes in later reactions of branched-chain amino acids. These include a blockage of oxidation of isovaleryl CoA with accumulation of isovalerate (which gives urine a sweaty feet smell), β -methylcrotonyl CoA carboxylase deficiency (in which urine smells like that of a cat), deficiency of β -hydroxy- β -methylglutaryl CoA lyase, and deficiency of β -ketothiolase that splits α -methylacetoacetyl CoA (with no defect in acetoacetate cleavage). In the latter condition, development is normal and symptoms appear to be related only to episodes of ketoacidosis.

Zhang, B., Edenberg, H. J., Crabb, D. W., and Harris, R. A. Evidence for both a regulatory and structural mutation in a family with maple syrup urine disease. *J. Clin. Invest.* 83:1425, 1989.

Propionyl CoA Is Metabolized to Succinyl CoA

Propionyl CoA is an end product of isoleucine, valine, and methionine metabolism, odd-chain fatty acid oxidation, and degradation of the side chain of cholesterol. The first step in the conversion of the 3-carbon propionyl CoA to the 4-carbon succinyl CoA is initiated by **propionyl-CoA carboxylase**, which is biotin dependent (Figure 11.71; see 11.11). This gives D-methylmalonyl CoA, an isomerase that converts to a mixture of D- and L-methylmalonyl CoA. **Methylmalonyl mutase**, which requires 5 -deoxyadenosylcobalamin (a derivative of vitamin B₁₂) converts the L-isomer to succinyl CoA. This is the second enzyme known to be dependent on vitamin B₁₂ (see p. 473). The reaction is very unusual, removing a methyl side chain and inserting it as a methylene group into the backbone of the compound.

Lysine

Lysine is the other entirely ketogenic amino acid. The carbons enter intermediary metabolism as acetoacetyl CoA. Lysine has an ϵ - and an α -amino group.

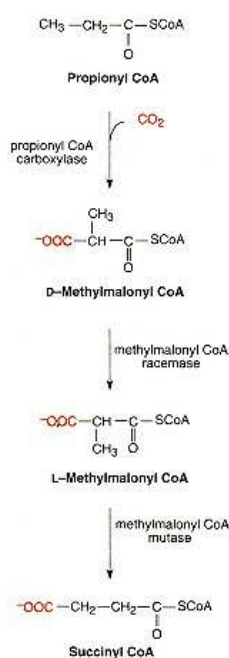

Figure 11.71
Interconversion of propionyl CoA, methylmalonyl CoA, and succinyl CoA.

The mutase requires 5 -deoxyadenosylcobalamin for activity

CLINICAL CORRELATION 11.11

Diseases of Propionate and Methylmalonate Metabolism

Deficiencies of the three enzymes shown in Figure 11.71 contribute to ketoacidosis. Propionate is formed in the degradation of valine, isoleucine, methionine, threonine, the side chain of cholesterol, and odd-chain fatty acids. The amino acids appear to be the main precursors since decreasing or eliminating dietary protein immediately minimizes acidosis. A defect in propionyl-CoA carboxylase results in accumulation of propionate, which is diverted to alternative pathways, including incorporation into fatty acids for an acetyl group forming odd-chain fatty acids. The extent of these reactions is very limited. In one case large amounts of biotin were reported to produce beneficial effects, suggesting that more than one defect decreases propionyl-CoA carboxylase activity. Possibilities are a lack of intestinal biotinidase that liberates biotin from ingested food for absorption or a lack of biotin holocarboxylase that incorporates biotin into biotin-dependent enzymes. Children have been found with acidosis caused by high levels of methylmalonate, which is normally undetectable in blood. Enzymes analyzed from liver taken at autopsy or from cultured fibroblasts have shown that some cases were due to deficiency of methylmalonyl-CoA mutase. One group was unable to convert methylmalonyl CoA to succinyl CoA under any conditions, but another group carried out the conversion when 5 -adenosylcobalamin was added. Clearly, those with an active site defect in the enzyme cannot metabolize methylmalonate, but those with defects in handling vitamin B₁₂, respond to massive doses of the vitamin. Other cases of methylmalonic aciduria suffer from a more fundamental inability to use vitamin B₁₂, that leads to deficiency in methylcobalamin (coenzyme of methionine salvage) and in 5 -adenosylcobalamin deficiency (coenzyme of methylmalonyl CoA isomerization).

Mahoney, M. J., and Bick, D. Recent advances in the inherited methylmalonic acidemias. *Acta Paediatr. Scand.* 76:689, 1987.

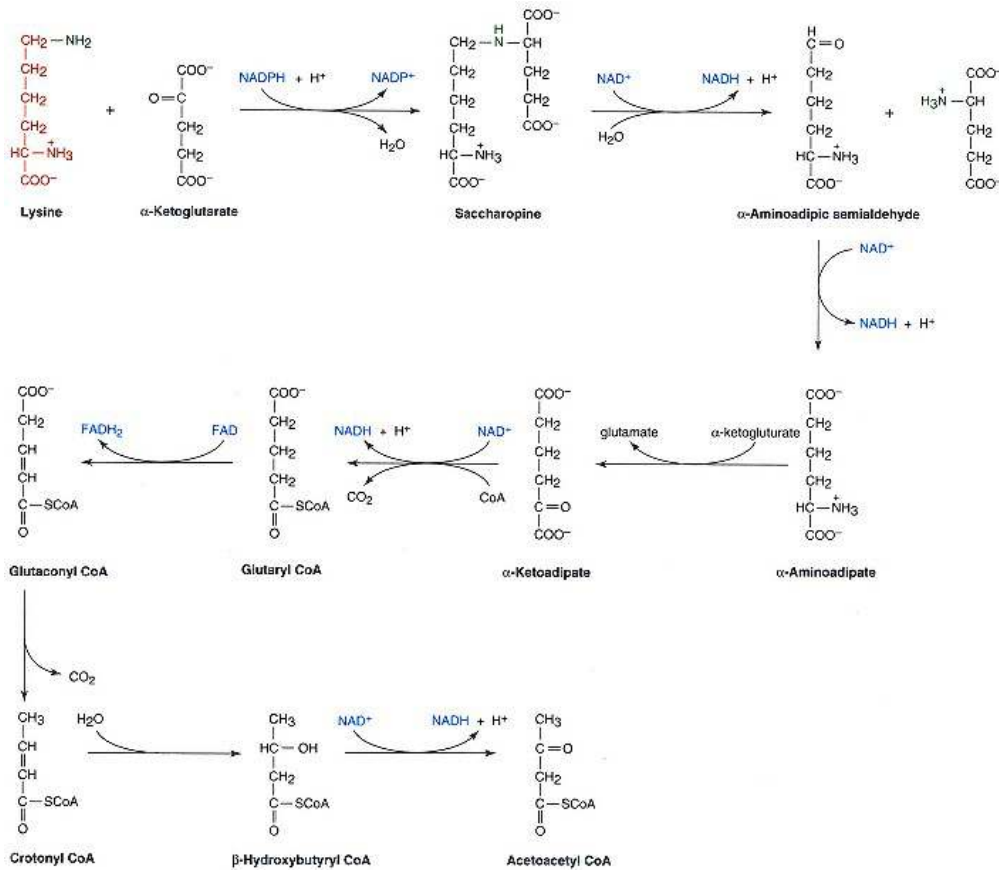
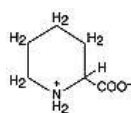

Figure 11.72
Principal pathway of lysine degradation.

The initial transamination of the ϵ -amino group requires α -ketoglutarate as acceptor and cosubstrate (Figure 11.72). Instead of the pyridoxal phosphate–Schiff base mechanism, an intermediate called **saccharopine** is formed, which is then cleaved to glutamate and a semialdehyde compound. The usual Schiff base electronic rearrangement mechanism is replaced by an oxidation and a reduction, but the products are effectively the same. The semialdehyde is then oxidized to a dicarboxylic amino acid, and a transamination of the α -amino group occurs in a pyridoxal-dependent manner. Further reactions lead to acetoacetyl CoA.



Pipercolate

Figure 11.73
Minor product of
lysine metabolism.

A minor pathway starts with removal of the α -amino group and goes via the cyclic compound **pipercolate** (Figure 11.73) to join the major pathway at the level of the semialdehyde intermediate. This does not replace the major pathway even in a deficiency of enzymes in the early part of the pathway (see Clin. Corr. 11.12).

Carnitine Is Derived from Lysine

Medium- and long-chain fatty acids are transported into mitochondria for β -oxidation as **carnitine** conjugates (see p. 382). Carnitine is synthesized not from free lysine but rather from lysine residues in certain proteins. The first step is trimethylation of the ϵ -amino group of the lysine side chain, with AdoMet as the methyl donor (Figure 11.74). Free trimethyllysine is obtained from hydrolysis of the protein and is metabolized in four steps to carnitine.

Histidine

The first reaction catalyzed by **histidase** (Clin. Corr. 11.13) removes free ammonia and leaves a compound with a double bond called urocanate (Figure 11.75). Two other reactions lead to **formiminoglutamate (FIGLU)**. The formimino group is then transferred to tetrahydrofolate.

Urinary Formiminoglutamate Is Diagnostic of Folate Deficiency

The formimino group of formiminoglutamate must be transferred to tetrahydrofolate before the final product, glutamate, can be produced. When there is

CLINICAL CORRELATION 11.12

Diseases Involving Lysine and Ornithine

Lysine

Two metabolic disorders of lysine are recognized. α -Amino adipic semialdehyde synthase is deficient in a small number of patients who excrete lysine and smaller amounts of saccharopine. This has led to the discovery that the enzyme has both lysine- α -ketoglutarate reductase and saccharopine dehydrogenase activities. Single proteins with multiple enzymatic activities are also found in pyrimidine synthesis and fatty acid synthesis. It is thought that hyperlysinemia is benign. More serious is familial lysinuric protein intolerance due to failure to transport dibasic amino acids across intestinal mucosa and renal tubular epithelium. Plasma lysine, arginine, and ornithine are decreased to one-third or one-half of normal. Patients develop marked hyperammonemia after a meal containing protein. This is thought to arise from deficiency of the urea cycle intermediates ornithine and arginine in liver, limiting the capacity of the cycle. Consistent with this view, oral supplementation with citrulline prevents hyperammonemia. Other features are thin hair, muscle wasting, and osteoporosis, which may reflect protein malnutrition due to lysine and arginine deficiency.

Ornithine

Elevated ornithine levels are generally due to deficiency of ornithine δ -aminotransferase. A well-defined clinical entity, gyrate atrophy of the choroid and retina, characterized by progressive loss of vision leading to blindness by the fourth decade, is caused by deficiency of this mitochondrial enzyme. The mechanism of changes in the eye is unknown. Progression of the disease may be slowed by dietary restriction in arginine and/or pyridoxine therapy, which reduces ornithine in body fluids.

O'Donnell, J.J., Sandman, R. P., and Martin, S. R. Gyrate atrophy of the retina: inborn error of L-ornithine: 2-oxoacid aminotransferase. *Science* 200:200, 1978; Rajantil, J., Simell, O., and Perheentupa, J. Lysinuric protein intolerance. Basolateral transport defect in renal tubuli. *J. Clin. Invest.* 67:1078, 1981.

CLINICAL CORRELATION 11.13

Histidinemia

Histidinemia is due to histidase deficiency. A convenient assay for this enzyme uses skin, which produces urocanate as a constituent of sweat; urocanate and other enzymes of histidine catabolism found in liver do not occur in skin. A finding that urocanate is absent in sweat can only be interpreted as a lack of synthesis, and not as accelerated disappearance by further metabolism. Histidase deficiency can be confirmed by enzyme assay in skin biopsies. Incidence of the disorder is high, about 1 in 10,000 newborns screened. Most reported cases of histidinemia have shown normal mental development. Restriction of dietary histidine normalizes the biochemical abnormalities but is not usually required.

Scriver, C. R., and Levy, H. L. Histidinemia: reconciling retrospective and prospective findings. *J. Inherit. Metab. Dis.* 6:51, 1983.

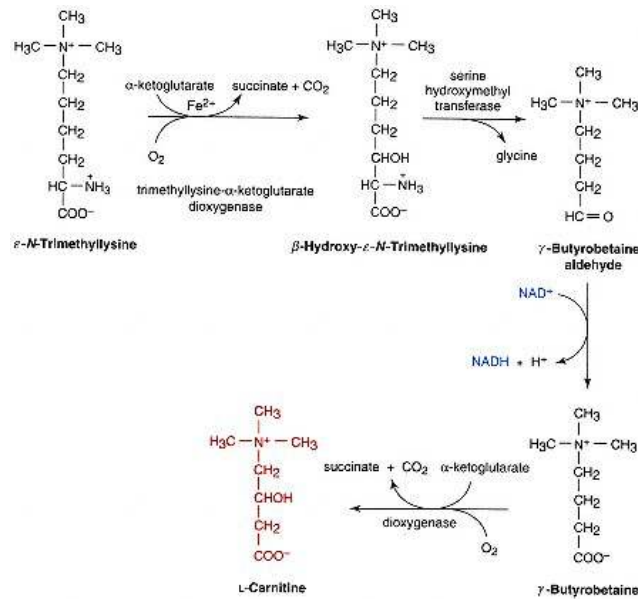

Figure 11.74
Biosynthesis of carnitine.

insufficient tetrahydrofolate available, this reaction decreases and FIGLU is excreted in urine. This is a diagnostic sign of folate deficiency if it happens after a test dose of histidine is ingested (see Clin. Corr. 11.14).

Histamine, Carnosine, and Anserine Are Produced from Histidine

Histamine (Figure 11.76), released from cells as part of an allergic response, is produced from histidine by **histidine decarboxylase**. Histamine has many

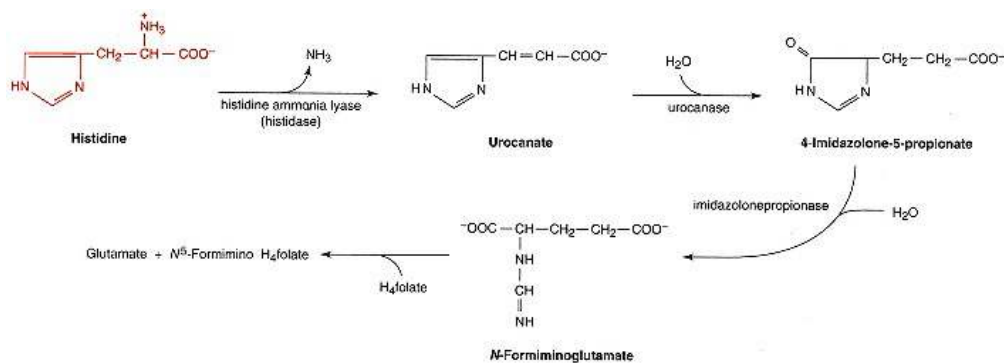

Figure 11.75
Degradation of histidine.

CLINICAL CORRELATION 11.14

Diseases of Folate Metabolism

A significant fraction of absorbed folic acid must be reduced to function as a coenzyme. Symptoms of folate deficiency may be due to deficiency of dihydrofolate reductase. Parenteral administration of *N*⁵-formyltetrahydrofolate, the most stable of the reduced folates, is effective in these cases. In some cases of central nervous system abnormality attributed to deficiency of methylene folate reductase there is homocystinuria. Decreased enzyme activity lowers the *N*⁵-methyltetrahydrofolate formed so that the source of methyl groups for the salvage of homocysteine is limiting. Large amounts of folic acid, betaine, and methionine reversed the biochemical abnormalities and, in at least one case, the neurological disorder. Patients with widely divergent presentations had shown deficiencies in transfer of the formimino group from formiminoglutamate to tetrahydrofolate. They excreted varying amounts of FIGLU; some responded to large doses of folate, but others did not. The mechanism whereby a deficiency of formiminotransferase produces pathological changes is unclear. It is not sure whether this deficiency causes a disease state. One patient showed symptoms of folate deficiency and had tetrahydrofolate methyltransferase deficiency. The associated anemia did not respond to vitamin B₁₂ but showed some improvement with folate. It was suggested that the patient formed inadequate *N*⁵-methyltetrahydrofolate to promote remethylation of homocysteine. This left the coenzyme "trapped" in the methylated form and unavailable for use in other reactions.

physiological roles, including dilation and constriction of certain blood vessels. An overreaction to histamine can lead to asthma and other allergic reactions. **Carnosine** (β -alanylhistidine) and **anserine** (β -alanylmethylhistidine) are dipeptides (Figure 11.77) found in muscle. Their function is unknown.

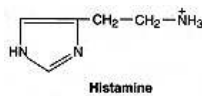

Figure 11.76
Histamine.

Creatine

Storage of "high-energy" phosphate, particularly in cardiac and skeletal muscle, occurs by transfer of the phosphate group from ATP to **creatine** (Figure 11.78). Creatine is synthesized by transfer of the guanidinium group of arginine to glycine, and subsequent addition of a methyl group from AdoMet. The amount of creatine in the body is related to muscle mass, and a certain percentage of this undergoes turnover each day. About 1–2% of preexisting creatine phosphate is cyclized nonenzymatically to **creatinine** (Figure 11.79) and excreted in urine, and new creatine is synthesized to replace it. The amount of creatinine excreted by an individual is therefore constant from day to day. When a 24-hour urine sample is requested, the amount of creatinine in the sample can be used to determine whether the sample truly represents a whole day's urinary output.

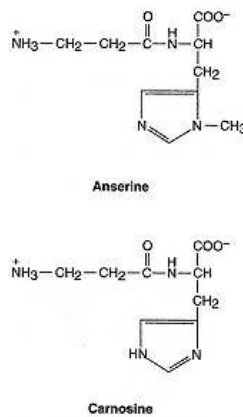
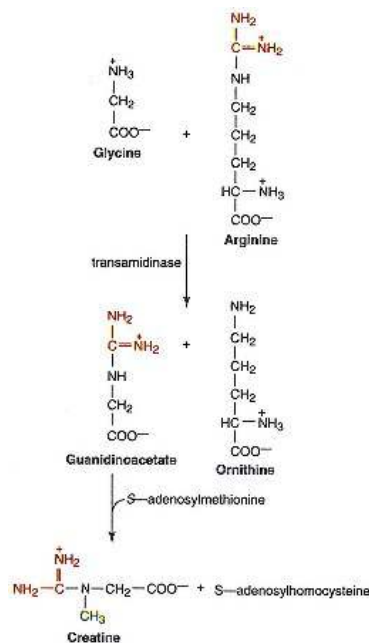

Figure 11.77
Anserine and carnosine.



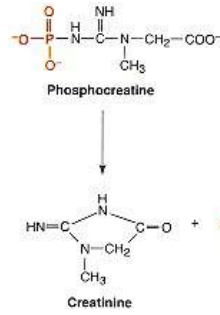

Figure 11.79
Spontaneous reaction forming creatinine.

Glutathione

Glutathione, the tripeptide γ -glutamylcysteinylglycine, has several important functions. It is a reductant, conjugated to drugs to make them more water soluble, involved in transport of amino acids across cell membranes, part of some leukotriene structures (see p. 438), a cofactor for some enzymatic reactions, and an aid in the rearrangement of protein disulfide bonds.

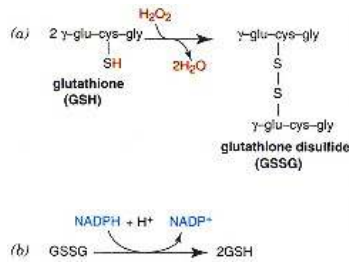

Figure 11.80
(a) Scavenging of peroxide by glutathione peroxidase and
(b) regeneration of reduced glutathione by glutathione reductase.

Glutathione as reductant is very important in maintaining stability of erythrocyte membranes. Its sulfhydryl group can be used to reduce peroxides formed during oxygen transport (see p. 1026). The resulting oxidized form of GSH consists of two molecules joined by a disulfide bond. This is reduced to two molecules of GSH at the expense of NADPH (Figure 11.80). The usual steady-state ratio of GSH to GSSG in erythrocytes is 100:1.

Conjugation of drugs by glutathione, often after a preliminary reaction catalyzed by cytochrome P450 (Chapter 23), renders them more polar for excretion (Figure 11.81).

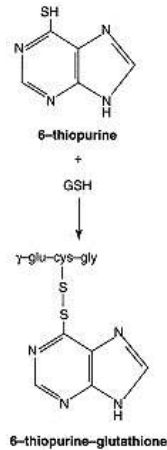

Figure 11.81
Conjugation of a drug by glutathione transferase.

Glutathione Is Synthesized from Three Amino Acids

Glutathione is synthesized by formation of the dipeptide γ -glutamylcysteine and the subsequent addition of glycine. Both reactions require activation of carboxyl groups by ATP (Figure 11.82). Synthesis of glutathione is largely regulated by cysteine availability.

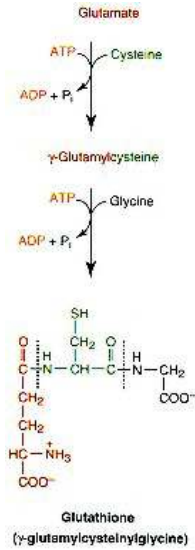

Figure 11.82
Synthesis of glutathione.

The γ -Glutamyl Cycle Transports Amino Acids

There are several mechanisms for transport of amino acids across cell membranes. Many are symport or antiport mechanisms (see p. 200) and are coupled to sodium transport. The γ -glutamyl cycle is an example of "group transfer" transport. It is more energy-requiring than other mechanisms, but is rapid and has high capacity, and functions in the kidney and some other tissues. It is particularly important in renal epithelial cells.

The enzyme γ -glutamyl transpeptidase is located in the cell membrane. It shuttles GSH to the cell surface to interact with an amino acid. γ -Glutamyl amino acid is transported into the cell, and the complex is hydrolyzed to liberate the amino acid (Figure 11.83). Glutamate is released as **5-oxoproline**, and cysteinylglycine is cleaved to its component amino acids. To regenerate GSH glutamate is reformed from oxoproline in an ATP-requiring reaction, and GSH is resynthesized from its three component parts. Three ATPs are used in the regeneration of glutathione, one in formation of glutamate from oxoproline and two in formation of the peptide bonds.

Glutathione Concentration Affects the Response to Toxins

When the body encounters toxic conditions such as peroxide formation, ionizing radiation, alkylating agents, or other reactive intermediates, it is beneficial to increase the level of GSH. Cysteine and methionine have been administered as GSH precursors, but they have the disadvantage of being precursors of an energy-expensive pathway to GSH. A more promising approach is administration of a soluble diester of GSH, such as γ -(α -ethyl)glutamylcysteinylethylglycinate.

Very premature infants have a very low concentration of cysteine because of low cystathionase activity in liver. This keeps the GSH concentration low and makes them more susceptible to oxidative damage, especially from hydro-peroxides formed in the eye after hyperbaric oxygen treatment. Under certain circumstances, such as rendering tumor cells more sensitive to radiation or parasites more sensitive to drugs, it is desirable to lower GSH levels. This can be achieved by the glutamate analog **buthionine sulfoximine** (Figure 11.84) as a competitive inhibitor of GSH synthesis.

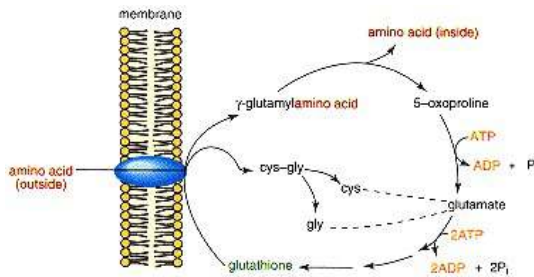

Figure 11.83
 γ -Glutamyl cycle for transporting amino acids.

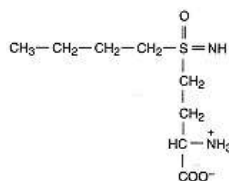

Figure 11.84
Buthionine sulfoximine.

Bibliography

General

Meister, A. *Biochemistry of the Amino Acids*, 2nd ed. New York: Academic Press, 1965.

Pyridoxal Phosphate

Dolphin, D., Poulson, R., and Avramovic, O. (Eds.). *Vitamin B₆ Pyridoxal Phosphate*. New York: Wiley, 1986.

Glutamate and Glutamine

Bode, B. L., Kaminski, D. L., Souba, W. W., and Li, A. P. Glutamine transport in human hepatocytes and transformed liver cells. *Hepatology* 21: 511, 1995.

Fisher, H. F. Glutamate dehydrogenase. *Methods Enzymol.* 113:16, 1985.

Haussinger, D. Nitrogen metabolism in liver: structural and functional organization and physiological relevance. *Biochem. J.* 267:281, 1990.

Urea Cycle

Holmes, F. L. Hans Krebs and the discovery of the ornithine cycle. *Fed. Proc.* 39:216, 1980.

Jungas, R. L., Halperin, M. L., and Brosnan, J. T. Quantitative analysis of amino acid oxidation and related gluconeogenesis in humans. *Physiol. Rev.* 72:419, 1992.

Branched-Chain Amino Acids

Shander, P., Wahren, J., Paoletti, R., Bernardi, R., Rinetti, M. *Branched Chain Amino Acids*. New York: Raven Press, 1992.

Serine

Snell, K. The duality of pathways for serine biosynthesis is a fallacy. *Trends Biochem. Sci.* 11:241, 1986.

Arginine

Reyes, A. A., Karl, I. E., and Klahr, S. Editorial review: role of arginine in health and renal disease. *Am. J. Physiol.* 267:F331, 1994.

Sulfur Amino Acids

Lee, B. J., Worland, P. J., Davis, J. N., Stadtman, T. C., and Hatfield, D. L. Identification of a selenocysteyl-tRNA^{Ser} in mammalian cells that recognizes the nonsense codon, UGA. *J. Biol. Chem.* 264:9724, 1989.

Stepanuk, M. H. Metabolism of sulfur-containing amino acids. *Annu. Rev. Nutr.* 6:179, 1986.

Wright, C. E., Tallan, H. H., Lin, Y. Y., and Gaull, G. E. Taurine: biological update. *Annu. Rev. Biochem.* 55:427, 1986.

Polyamines

Perin, A., Scalabrino, G., Sessa, A., and Ferioloini, M. E. *Perspectives in Polyamine Research*. Milan: Wichtig Editore, 1988.

Tabor, C. W., and Tabor, H. Polyamines. *Annu. Rev. Biochem.* 53:749, 1984.

Folates and Pterins

Blakley, R. L., and Benkovic, S. J. *Folate and Pterins*. New York: Wiley, Vol. 1, 1984; Vol. 2, 1985.

Quinoproteins

Davidson, V. L., (Ed.). *Principles and Applications of Quinoproteins*. New York: Marcel Dekker, 1993.

Carnitine

Bieber, L. L. Carnitine. *Annu. Rev. Biochem.* 57:261, 1988.

Glutathione

Taniguchi, N., Higashi, T., Sakamoto, Y., and Meister, A. *Glutathione Centennial: Molecular Perspectives and Clinical Implications*. New York: Academic Press, 1989.

Tryptophan

Stone, T. W. *Quinolinic Acid and the Kynurenines*. Boca Raton, FL: CRC Press, 1989.

Schwarcz, R. Metabolism and function of brain kynurenines. *Biochem. Soc. Trans.* 21:77, 1993.

Disorders of Amino Acid Metabolism

Rosenberg, L. E., and Scriver, C. R. Disorders of amino acid metabolism. In: P. K. Bondy and L. E. Rosenberg (Eds.), *Metabolic Control and Disease*, 8th ed Philadelphia: Saunders, 1980.

Scriver, C. R., Beaudet, A. L., Sly, W. S., and Valle, D. *The Metabolic and Molecular Bases of Inherited Disease*, 7th ed. New York: McGraw-Hill, 1994.

Wellner, D., and Meister, A. A survey of inborn errors of amino acid metabolism and transport. *Annu. Rev. Biochem.* 50:911, 1980.

Questions

C. N. Angstadt and J. Baggott

1. Amino acids considered nonessential for humans are:

- A. those not incorporated into protein.
- B. not necessary in the diet if sufficient amounts of precursors are present.
- C. the same for adults as for children.
- D. the ones made in specific proteins by posttranslational modifications.
- E. generally not provided by the ordinary diet.

2. Aminotransferases:

- A. usually require α -ketoglutarate or glutamine as one of the reacting pair.
- B. catalyze reactions that result in a net use or production of amino acids.
- C. catalyze irreversible reactions.
- D. require pyridoxal phosphate as an essential cofactor for the reaction.
- E. are not able to catalyze transamination reactions with essential amino acids.

3. The production of ammonia in the reaction catalyzed by glutamate dehydrogenase:

- A. requires the participation of NADH or NADPH.
- B. proceeds through a Schiff base intermediate.
- C. may be reversed to consume ammonia if it is present in excess.
- D. is favored by high levels of ATP or GTP.
- E. would be inhibited when gluconeogenesis is active.

4. The amide nitrogen of glutamine:

- A. represents a nontoxic transport form of ammonia.
- B. is a major source of ammonia for urinary excretion.
- C. is used in the synthesis of asparagine, purines, and pyrimidines.
- D. can be recovered as ammonia by the action of glutaminase.
- E. all of the above are correct.

5. In the formation of urea from ammonia by the urea cycle, all of the following are correct EXCEPT:
- aspartate supplies one of the nitrogens found in urea.
 - part of the large negative free-energy change of the process may be attributed to the hydrolysis of pyrophosphate.
 - the rate of the cycle is independent of diet.
 - fumarate is produced.
 - genetic deficiency of any one of the enzymes can lead to hyperammonemia.
6. Carbamoyl phosphate synthetase I:
- is a flavoprotein.
 - is controlled primarily by feedback inhibition.
 - is unresponsive to changes in arginine.
 - requires acetylglutamate as an allosteric effector.
 - requires ATP as an allosteric effector.
7. All of the following are correct about ornithine EXCEPT it:
- may be formed from or converted to glutamic semialdehyde.
 - can be converted to proline.
 - plays a major role in the urea cycle.
 - is a precursor of putrescine, a polyamine.
 - is in equilibrium with spermidine.
8. Serine:
- is in equilibrium with threonine via a reaction catalyzed by a hydroxymethyltransferase.
 - may enter intermediary metabolism either as 3-phosphoglycerate or as pyruvate.
 - can be converted to selenoserine for incorporation into proteins.
 - is a prosthetic group for *S*-adenosylmethionine decarboxylase.
 - all of the above are correct.
9. In folic acid-dependent carriage of a one-carbon group:
- the formation of the methyl group of thymine involves a direct transfer from methyl THF.
 - the first entry of carbons into the THF pool is via methylene THF.
 - carbons are fixed at the oxidation level at which they enter the pool.
 - the only acceptor for the methyl form is homocysteine.
 - carbons are always carried on nitrogen 10 of the pteridine ring.
10. An inability to generate tetrahydrobiopterin might be expected to:
- inhibit the normal degradative pathway of phenylalanine.
 - lead to albinism.
 - directly prevent formation of melatonin.
 - reduce the body's ability to transfer one-carbon fragments.
 - have little or no effect on the production of catecholamines.
11. Both tyrosine aminotransferase and tryptophan oxygenase are enzymes that can be induced by adrenal glucocorticoids. This is reasonable because:
- tyrosine and tryptophan are precursors of physiologic amines.
 - glucocorticoids work by inducing enzymes.
 - tryptophan is the precursor of nicotinic acid needed for NAD⁺ synthesis.
 - tyrosine is the precursor of catecholamines in the adrenal gland.
 - these two enzymes initiate the major catabolic pathways in the liver of tyrosine and tryptophan.
12. *S*-Adenosylmethionine:
- contains a positively charged sulfur (sulfonium) that facilitates the transfer of substituents to suitable acceptors.
 - yields α -ketobutyrate in the reaction in which the methyl is transferred.
 - donates a methyl group in a freely reversible reaction.
 - generates H₂S by transsulfuration.
 - provides the carbons for the formation of cysteine.
13. In humans, sulfur of cysteine may participate in all of the following EXCEPT:
- the conversion of cyanide to less toxic thiocyanate.
 - the formation of thiosulfate.
 - the formation of taurine.
 - the donation of the sulfur for methionine formation.
 - the formation of PAPS.
14. All of the following are true about the branched-chain amino acids EXCEPT they:
- are essential in the diet.
 - differ in that one is glucogenic, one is ketogenic, and one is classified as both.
 - are catabolized in a manner that bears a resemblance to β -oxidation of fatty acids.
 - are oxidized by a dehydrogenase complex to branched-chain acyl CoAs one carbon shorter than the parent compound.
 - are metabolized initially in the liver.
15. Lysine as a nutrient:
- may be replaced by its α -keto acid analog.
 - produces pyruvate and acetoacetyl CoA in its catabolic pathway.
 - is methylated by *S*-adenosylmethionine.
 - is the only one of the common amino acids that is a precursor of carnitine.
 - all of the above are correct.
16. Histidine:
- unlike most amino acids, is not converted to an α -keto acid when the amino group is removed.
 - is a contributor to the tetrahydrofolate one-carbon pool.
 - decarboxylation produces a physiologically active amine.
 - forms a peptide with β -alanine.
 - all of the above are correct.
17. Glutathione does all of the following EXCEPT:
- participate in the transport of amino acids across some cell membranes.
 - scavenge peroxides and free radicals.
 - form sulfur conjugates for detoxification of compounds.
 - convert hemoglobin to methemoglobin.
 - act as a cofactor for some enzymes.

Answers

1. B A: All of the 20 common amino acids are incorporated into protein. B and E: Although most of our supply of nonessential amino acids comes from the diet, we can make them if necessary, given the precursors. C: Arginine is not believed to be required for adults (pp. 446–447).
2. D A: Most mammalian aminotransferases use glutamate or α -ketoglutarate. B: One amino acid is converted into another amino acid; there is neither net gain nor net loss. C: The reactions are freely reversible. E: Only lysine and threonine do not have aminotransferases (pp. 448–449).
3. C This is an important mechanism for reducing toxic ammonia concentrations. A: This would favor ammonia consumption. B: The cofactor is a pyridine nucleotide not pyridoxal phosphate. D: These are inhibitory. E: Since part of the role is to provide amino acid carbon chains for gluconeogenesis, this would be active (p. 450).
4. E It is in the form of the amide nitrogen of glutamine that much of amino acid nitrogen is made available in a nontoxic form (pp. 450–452).
5. C Rate must fluctuate to accommodate the amount of ammonia to be removed. A, B, and D: One of the nitrogen atoms is supplied as aspartate, with its carbon atoms being released as fumarate. This reaction is physiologically irreversible because of the hydrolysis of pyrophosphate. E: Since this is the main pathway for disposal of ammonia, any defect leads to hyperammonemia (pp. 454–456).
6. D B, C, and D: The primary control is by the allosteric effector, *N*-acetylglutamate. Synthesis of the effector, and therefore activity of CPSI, is increased in the presence of arginine. E: ATP is a substrate (p. 455).
7. E Spermidine is formed by adding propylamine to putrescine. A and B: Both amino acids give rise to glutamic semialdehyde and are formed from it. C: It is both a substrate and product of the cycle. D: This is a decarboxylation (p. 458).
8. B It is also synthesized from 3-phosphoglycerate. A: Threonine is an essential amino acid. C: It is converted to selenocysteine after forming a Ser-tRNA. D: It is *converted* to the prosthetic group (pyruvate) for that enzyme (p. 459).
9. D This forms methionine, which would become a general methyl donor. A: Methylene THF is reduced during the process of transfer to dUMP to form the thymine nucleotide. B: This is true for serine but not for other donors. C: An important aspect of the pool is interconvertibility of its forms. E: They can also be carried on nitrogen 5 or between nitrogens 5 and 10 (pp. 459–463).
10. A Tetrahydrobiopterin is a necessary cofactor for phenylalanine, tyrosine, and tryptophan hydroxylases. The first catalyzes the major pathway of phenylalanine catabolism. B: Albinism stems from a deficiency of tyrosinase, which, while giving the same product as tyrosine hydroxylase, is not a tetrahydrobiopterin-requiring enzyme. C: It would reduce the formation of the precursor, serotonin, but not melatonin itself. D: One-carbon fragments are transferred from either *S*-adenosylmethionine or the THF one-carbon pool. E: Catecholamine formation, catalyzed by the second enzyme, would also be deficient (pp. 464–467).
11. E Although all the statements are true, only E offers a suitable rationale. Tyrosine and tryptophan both yield a glucogenic fragment (fumarate and alanine) upon catabolism. Glucocorticoids are secreted in response to low blood glucose or stress (pp. 465 and 474).
12. A The reactive, positively charged sulfur reverts to a neutral thioether when the methyl group is transferred to an acceptor. B: The product, *S*-adenosylhomocysteine, is hydrolyzed to homocysteine. C: Transmethylations from AdoMet are irreversible. D: Transsulfuration refers to the combined action of cystathionine synthase and cystathionase transferring methionine's sulfur to serine to yield cysteine. E: Methionine provides only the sulfur; carbons are from serine (pp. 469–472).
13. D Methionine is the source of sulfur for cysteine (via homocysteine), but the reverse is not true in humans. A and B: Transamination to β -mercaptopyruvate with subsequent formation of thiosulfate and/or conversion of cystine to thio-cysteine allows transfer of the sulfur to detoxify cyanide. C: Taurine is deaminated cysteine. E: SO_4^{2-} , the most oxidized form of sulfur found physiologically, is either excreted or activated as PAPS for use in detoxifying phenolic compounds or in biosynthesis (pp. 470 and 473).
14. E BCAA aminotransferase, the first enzyme, is much higher in muscle than in liver. B, C, and D: Although their catabolism is similar, the end products are different because of the differences in the branching. After transamination, the α -keto acids are oxidized by a dehydrogenase complex in a fashion similar to pyruvate dehydrogenase. The similarity to β -oxidation comes in steps like oxidation to an α,β -unsaturated CoA, hydration of the double bond, and oxidation of a hydroxyl to a carbonyl (pp. 476 and 479).
15. D A: Lysine does not participate in transamination probably in part because the α -keto acid exists as a cyclic Schiff base. B: This is one of two purely ketogenic amino acids. C and D: Free lysine is not methylated, but lysyl residues in a protein are methylated in a posttranslational modification. Intermediates of carnitine synthesis are derived from trimethyllysine liberated by proteolysis (pp. 479–481).
16. E A: Elimination of ammonia from histidine leaves a double bond (urocanate) unlike both transamination and oxidative deamination reactions. B: A portion of the ring is released as formimino THF. C and D: Histamine; carnosine (pp. 481–483).
17. D Most of the functions of glutathione listed are dependent on the sulfhydryl group (–SH). A major role of glutathione in red blood cells is reduction of methemoglobin. Glutathione reductase helps to maintain the ratio of GSH/GSSG at about 100 : 1 (p. 484).

Chapter 12— Purine And Pyrimidine Nucleotide Metabolism

Joseph G. Cory

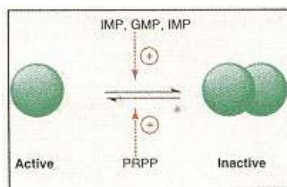

12.1 Overview	490
12.2 Metabolic Functions of Nucleotides	490
Distributions of Nucleotides Vary with Cell Type	491
12.3 Chemistry of Nucleotides	492
Properties of Nucleotides	493
12.4 Metabolism of Purine Nucleotides	493
Purine Nucleotides Are Synthesized by a Stepwise Buildup of the Ring to Form IMP	494
IMP Is the Common Precursor for AMP and GMP	494
Purine Nucleotide Synthesis Is Highly Regulated	497
Purine Bases and Nucleosides Can Be Salvaged to Reform Nucleotides	498
Purine Nucleotides Can Be Interconverted to Maintain the Appropriate Balance of Adenine and Guanine Nucleotides	500
GTP Is Precursor of Tetrahydrobiopterin	500
End Product of Purine Degradation in Humans Is Uric Acid	501
Formation of Uric Acid	502
12.5 Metabolism of Pyrimidine Nucleotides	503
Pyrimidine Nucleotides Are Synthesized by a Stepwise Series of Reactions to Form UMP	504
Pyrimidine Nucleotide Synthesis in Humans Is Regulated at the Level of Carbamoyl Phosphate Synthetase II	506
Pyrimidine Bases Are Salvaged to Reform Nucleotides	506
12.6 Deoxyribonucleotide Formation	507
Deoxyribonucleotides Are Formed by Reduction of Ribonucleoside Diphosphates	507
Deoxythymidylate Synthesis Requires N^5, N^{10} -Methylene H_4 Folate	508
Pyrimidine Interconversions with Emphasis on Deoxyribopyrimidine Nucleosides and Nucleotides	509
Pyrimidine Nucleotides Are Degraded to α -Amino Acids	509
12.7 Nucleoside and Nucleotide Kinases	511
12.8 Nucleotide-Metabolizing Enzymes As a Function of the Cell Cycle and Rate of Cell Division	511
Enzymes of Purine and Pyrimidine Nucleotide Synthesis Are Elevated during S Phase	512
12.9 Nucleotide Coenzyme Synthesis	514
12.10 Synthesis and Utilization of 5-Phosphoribosyl-1-Pyrophosphate	516
12.11 Compounds That Interfere with Cellular Purine and Pyrimidine Nucleotide Metabolism: Chemotherapeutic Agents	517
Antimetabolites Are Structural Analogs of Bases or Nucleosides	517
Antifolates Inhibit Formation of Tetrahydrofolate	518
Glutamine Antagonists Inhibit Enzymes That Utilize Glutamine As Nitrogen Donors	519
Other Agents Inhibit Cell Growth by Interfering with Nucleotide Metabolism	520
Purine and Pyrimidine Analogs As Antiviral Agents	520
Biochemical Basis for Development of Drug Resistance	520
Bibliography	521
Questions and Answers	521
Clinical Correlations	
12.1 Gout	498
12.2 Lesch–Nyhan Syndrome	499
12.3 Immunodeficiency Diseases Associated with Defects in Purine Nucleoside Degradation	503
12.4 Hereditary Orotic Aciduria	505

12.1— Overview

The material in this chapter is limited to mammalian cells and where possible to nucleotide metabolism in humans. There are major differences between nucleotide metabolism in bacteria and mammalian cells and even some differences between humans and other mammals. Purine and pyrimidine nucleotides participate in many critical cellular functions. The metabolic roles of the nucleotides range from serving as the monomeric precursors of RNA and DNA to serving as second messengers. The sources of the purine and pyrimidine nucleotides are via *de novo* synthetic pathways and salvage of exogenous and endogenous nucleobases and nucleosides. Amino acids, CO₂, and ribose 5-phosphate (from the hexose monophosphate shunt) serve as sources for carbon, nitrogen, and oxygen atoms of purines and pyrimidine nucleotides.

The intracellular concentrations of nucleotides are finely regulated by allosterically modulated enzymes in the pathways in which nucleotide end products control key steps in the pathways. 2-Deoxyribonucleotides required for DNA replication are generated directly from ribonucleotides and these reactions are also carefully regulated by nucleotides acting as positive and negative effectors. In addition to the regulation of nucleotide metabolism via allosteric regulation, concentrations of key enzymes in the metabolic pathway are altered during the cell cycle with many of the increases in enzyme activity occurring during late G1/early S phase just preceding DNA replication.

Defects in the metabolic pathways for *de novo* synthesis or salvage of nucleotides result in clinical diseases or syndromes. Furthermore, defects in degradation of nucleotides also lead to clinical problems. These include gout (defect in *de novo* purine nucleotide synthesis), Lesch–Nyhan syndrome (defect in purine nucleobase salvage), orotic aciduria (defect in *de novo* pyrimidine nucleotide synthesis), and immunodeficiency diseases (defects in purine nucleoside degradation). Because nucleotide synthesis is required for DNA replication and RNA synthesis in dividing cells, drugs that block *de novo* pathways of nucleotide synthesis have been used successfully as antitumor and antiviral agents.

12.2— Metabolic Functions of Nucleotides

Nucleotides and their derivatives play critical and diverse roles in cellular metabolism. Many different nucleotides are present in mammalian cells. Some, such as ATP, are present in the millimolar range while others, such as cyclic AMP, are orders of magnitude lower in concentration. The functions of nucleotides include the following:

1. **Role in Energy Metabolism:** As seen in earlier chapters, ATP is the principal form of chemical energy available to cells. ATP is generated in cells via either oxidative or substrate-level phosphorylation. ATP drives reactions as a phosphorylating agent and is involved in muscle contraction, active transport, and maintenance of ion gradients. ATP also serves as phosphate donor for generation of other nucleoside 5'-triphosphates.
2. **Monomeric Units of Nucleic Acids:** RNA and DNA consist of sequences of nucleotides. Nucleoside 5'-triphosphates are substrates for reactions catalyzed by RNA and DNA polymerases.
3. **Physiological Mediators:** Nucleosides and nucleotides serve as physiological mediators of key metabolic processes. Adenosine is important in control of coronary blood flow; ADP is critical in platelet aggregation and hence blood coagulation; cAMP and cGMP act as second messengers; and GTP is required for capping of mRNA, signal transduction through GTP-binding proteins, and in microtubule formation.

4. **Precursor Function:** GTP is the precursor for formation of the cofactor, tetrahydrobiopterin, required for hydroxylation reactions and nitric oxide generation.

5. **Components of Coenzymes:** The coenzymes NAD^+ , NADP^+ , FAD and their reduced forms and coenzyme A all contain as part of their structures a 5'-AMP moiety.

6. **Activated Intermediates:** Nucleotides also serve as carriers of "activated" intermediates required for a variety of reactions. UDP-glucose is a key intermediate in synthesis of glycogen and glycoproteins. GDP-mannose, GDP-fucose, UDP-galactose, and CMP-sialic acid are all key intermediates in reactions in which sugar moieties are transferred for synthesis of glycoproteins. CTP is utilized to generate CDP-choline, CDP-ethanolamine, and CDP-diacylglycerols, which are involved in phospholipid metabolism. Other activated intermediates include *S*-adenosylmethionine (SAM) and 3'-phosphoadenosine 5'-phosphosulfate (PAPS). *S*-Adenosylmethionine is a methyl donor in reactions involving methylation of sugar and base moieties of RNA and DNA and in formation of compounds such as phosphatidylcholine from phosphatidylethanolamine and carnitine from lysine. *S*-Adenosylmethionine also provides aminopropyl groups for synthesis of spermine from ornithine. PAPS is used as the sulfate donor to generate sulfated biomolecules such as proteoglycans and sulfatides.

7. **Allosteric Effectors:** Many of the regulated steps of metabolic pathways are controlled by intracellular concentrations of nucleotides. Many examples have already been discussed in previous chapters, and the roles of nucleotides in regulation of mammalian nucleotide metabolism will be discussed in this chapter.

Distributions of Nucleotides Vary with Cell Type

The principal purine and pyrimidine compounds found in cells are the 5'-nucleotide derivatives. ATP is the nucleotide found in the highest concentration in cells. The distributions of nucleotides in cells vary with cell type. In red blood cells, adenine nucleotides far exceed the concentrations of guanine, cytosine, and uridine nucleotides; in other tissues, such as liver, there is a complete spectrum of nucleotides and their derivatives, which include NAD^+ , NADH , UDP-glucose, and UDP-glucuronic acid. In normally functioning cells, nucleoside 5'-triphosphates predominate, whereas in hypoxic cells the concentrations of nucleoside 5'-monophosphates and nucleoside 5'-diphosphates are greatly increased. Free nucleobases, nucleosides, nucleoside 2'- and 3'-monophosphates, and "modified" bases represent degradation products of endogenous or exogenous nucleotides or nucleic acids.

The concentrations of **ribonucleotides** in cells are in great excess over the concentrations of **2'-deoxyribonucleotides**. For example, the concentration of ATP in Ehrlich tumor cells is 3600 pmol per 10^6 cells compared to dATP concentration of 4 pmol per 10^6 cells. However, at the time of DNA replication the concentrations of dATP and other deoxyribonucleoside 5'-triphosphates are markedly increased to meet the substrate requirements for DNA synthesis.

In normal cells, the total concentrations of nucleotides are essentially constant. Thus the total concentration of AMP plus ADP plus ATP remains constant, but there can be major changes in the individual concentration such that the ratio of $\text{ATP}/(\text{ATP} + \text{ADP} + \text{AMP})$ is altered depending on the energy state of the cell. The same is true for NAD^+ and NADH . The total concentration of NAD^+ plus NADH is normally fixed within rather narrow concentration limits. Consequently, when it is stated that the NADH level is increased, it follows that the concentration of NAD^+ is correspondingly decreased in that cell. The basis for this "fixed" concentration of nucleotides is that *de novo* synthesis and salvage pathways for nucleotides, nucleosides, and nucleobases are very rigidly controlled under normal conditions.

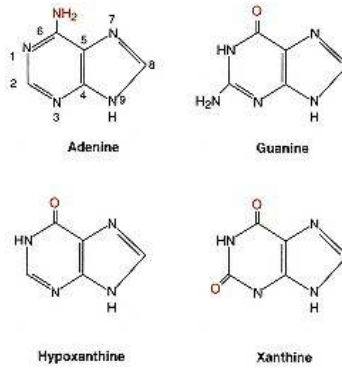

Figure 12.1
Purine bases.

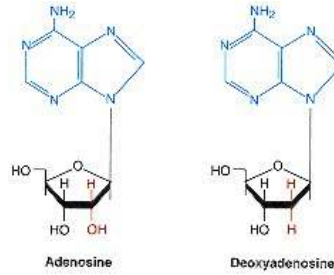

Figure 12.2
Adenosine and deoxyadenosine.

12.3— Chemistry of Nucleotides

The major purine derivatives in cells are those of **adenine** and **guanine**. Other purine bases encountered are hypoxanthine and xanthine (Figure 12.1). Nucleoside derivatives of these molecules will contain either ribose or 2-deoxyribose linked to the purine ring through a β -*N*-glycosidic bond at N-9. Ribonucleosides contain ribose, while deoxyribonucleosides contain deoxyribose as the sugar moiety (Figure 12.2). Nucleotides are **phosphate esters** of purine nucleosides (Figure 12.3). 3 - Nucleotides such as adenosine 3 -monophosphate (3 -AMP) may occur in cells as a result of nucleic acid degradation. In normally functioning cells, tri- and diphosphates are found to a greater extent than monophosphates, nucleosides, or free bases.

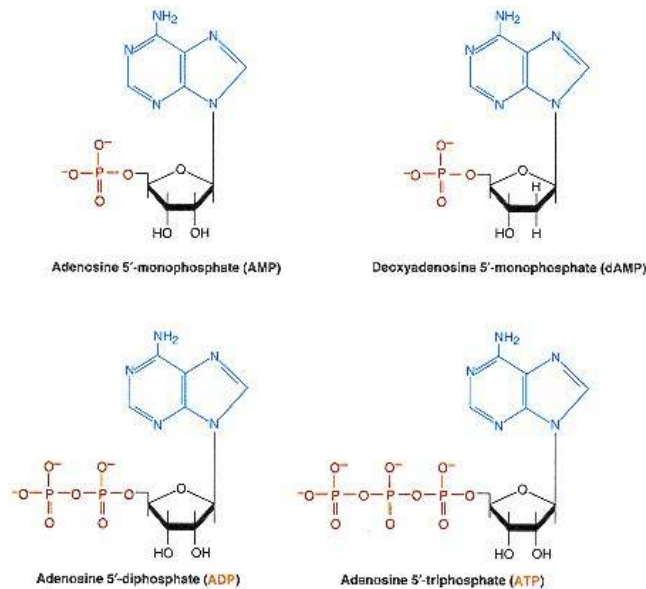

Figure 12.3
Adenosine nucleotides.

The pyrimidine nucleotides found in highest concentrations in cells are those containing **uracil** and **cytosine**. The structures of the bases are shown in Figure 12.4. Uracil and cytosine nucleotides are the major pyrimidine components of RNA; cytosine and thymine are the major pyrimidine components of DNA. As with purine derivatives, the pyrimidine nucleosides or nucleotides contain either ribose or 2-deoxyribose. The sugar moiety is linked to the pyrimidine in a β -*N*-glycosidic bond at N-1. Nucleosides of pyrimidines are uridine, cytidine, and thymidine (Figure 12.5). **Phosphate esters** of pyrimidine nucleosides are UMP, CMP, and TMP. In cells the major pyrimidine derivatives are tri- and diphosphates (Figure 12.6).

See the Appendix for a summary of the nomenclature and chemistry of the purines and pyrimidines.



Figure 12.4
Pyrimidine bases.

Properties of Nucleotides

Cellular components containing either purine or pyrimidine bases can be easily detected because of their strong absorption of UV light. Purine bases, nucleosides, and nucleotides have stronger absorptions than pyrimidines and their derivatives. The wavelength of light at which maximum absorption occurs varies with the particular base component, but in most cases the UV maximum is close to 260 nm. The UV spectrum for each derivative responds differently to changes in pH. The UV absorptions provide the basis for sensitive methods in assaying these compounds. For example, deamination of adenine nucleosides or nucleotides to the corresponding hypoxanthine derivatives causes a marked shift in λ_{max} from 265 to 250 nm, which is easily determined. Because of the high molar extinction coefficients of the purine and pyrimidine bases and their high concentrations in nucleic acids, the absorbance at 260 nm can be used to quantitate the amount of nucleic acid in RNA and DNA preparations.

The *N*-glycosidic bond of nucleosides and nucleotides is stable to alkali. However, stability of this bond to acid hydrolysis differs markedly. The *N*-glycosidic bond of purine nucleosides and nucleotides is easily hydrolyzed by dilute acid at elevated temperatures (e.g., 60°C) to yield free purine base and sugar or sugar phosphate. On the other hand, the *N*-glycosidic bond of uracil, cytosine, and thymine nucleosides and nucleotides is very stable to acid treatment. Strong conditions, such as perchloric acid (60%) and 100°C, releases free pyrimidine but with complete destruction of the sugar. The *N*-glycosidic bond of dihydrouracil nucleoside and dihydrouracil nucleotide is labile in mild acid.

Because of the highly polar phosphate group, purine and pyrimidine nucleotides are much more soluble in aqueous solutions than are their nucleosides and free bases. In general, nucleosides are more soluble than free bases.

Purine and pyrimidine bases and their nucleoside and nucleotide derivatives can be easily separated by a variety of techniques. These methods include paper chromatography; thin-layer chromatography (TLC), utilizing plates with cellulose or ion-exchange resins, electrophoresis; and ion-exchange column chromatography. With high-performance liquid chromatography (HPLC) nanomole quantities of these components are easily and quickly separated and detected.

12.4—

Metabolism of Purine Nucleotides

The purine ring is synthesized *de novo* in mammalian cells utilizing amino acids as carbon and nitrogen donors and also CO₂ as a carbon donor. The *de novo* pathway for purine nucleotide synthesis leading to **inosine 5'-monophosphate (IMP)** consists of ten metabolic steps. Hydrolysis of ATP is required to drive several reactions in this pathway. Overall, the *de novo* pathway for purine nucleotide synthesis is expensive in terms of moles of ATP utilized per mole of IMP synthesized.



Figure 12.5
Pyrimidine nucleosides.

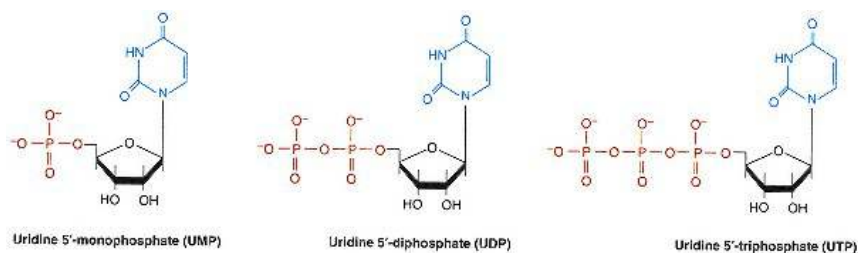

Figure 12.6
Uracil nucleotides.

Purine Nucleotides Are Synthesized by a Stepwise Buildup of the Ring to Form IMP

All enzymes involved in synthesis of purine nucleotides are found in the cytosol of the cell. However, not all cells (e.g., red cells) are capable of *de novo* purine nucleotide synthesis. In the *de novo* pathway, a stepwise series of reactions leads to synthesis of IMP, which in turn serves as the precursor for both **adenosine 5'-monophosphate (AMP)** and **guanosine 5'-monophosphate (GMP)**. Since IMP serves as the common precursor for AMP and GMP and this pathway is highly regulated by AMP and GMP, IMP is not normally found to any extent in cells.

Formation of IMP is shown in Figure 12.7. Several points should be emphasized about this pathway: phosphoribosylpyrophosphate (PRPP) is synthesized from ribose 5-phosphate generated by the hexose monophosphate pathway; the equivalent of 6 moles of ATP are utilized per mole of IMP synthesized; formation of 5-phosphoribosylamine (the first step) is the committed step. In formation of **5-phosphoribosylamine**, the N–C bond is formed that will ultimately be the *N*-glycosidic bond of the purine nucleotide; there are no known regulated steps between 5-phosphoribosylamine and IMP. **Tetrahydrofolate** serves as a " C_1 " carrier (***N*¹⁰-formyl H₄folate**, Figure 12.8) in this pathway.

The enzyme activities catalyzing several steps in the pathway reside on separate domains of **multifunctional proteins**. The activities of 5-phosphoribosylglycinamide synthetase, 5-phosphoribosylglycinamide transformylase, and 5-phosphoribosylaminoimidazole synthetase form part of a trifunctional protein. 5-Phosphoribosylaminoimidazole carboxylase and 5-phosphoribosyl-4-(*N*-succinocarboxamide)-5-aminoimidazole synthetase activities are on a bifunctional protein. 5-Phosphoribosyl-4-carboxamide-5-aminoimidazole transformylase and IMP cyclohydrolase activities are present on another bifunctional protein.

To summarize, *de novo* synthesis of purine nucleotides requires amino acids as carbon and nitrogen donors, CO₂ as a carbon source, and " C_1 units" transferred via H₄folate. The contributions of these sources to the purine ring are shown in Figure 12.9. Several amino acids including serine, glycine, tryptophan, and histidine can yield " C_1 units" to H₄folate (Chapter 11) and therefore they can contribute to C-2 and C-8 of the ring. 5-Phosphoribosyl-5-aminoimidazole carboxylase, which catalyzes the reaction in which CO₂ is used to introduce C-6 of the ring, is not a biotin-dependent carboxylase.

IMP Is the Common Precursor for AMP and GMP

IMP, the first ribonucleotide formed in the *de novo* pathway, serves as the common precursor for AMP and GMP synthesis (Figure 12.10). AMP and GMP are converted to ATP and GTP, respectively, utilizing nucleoside 5-monophos-

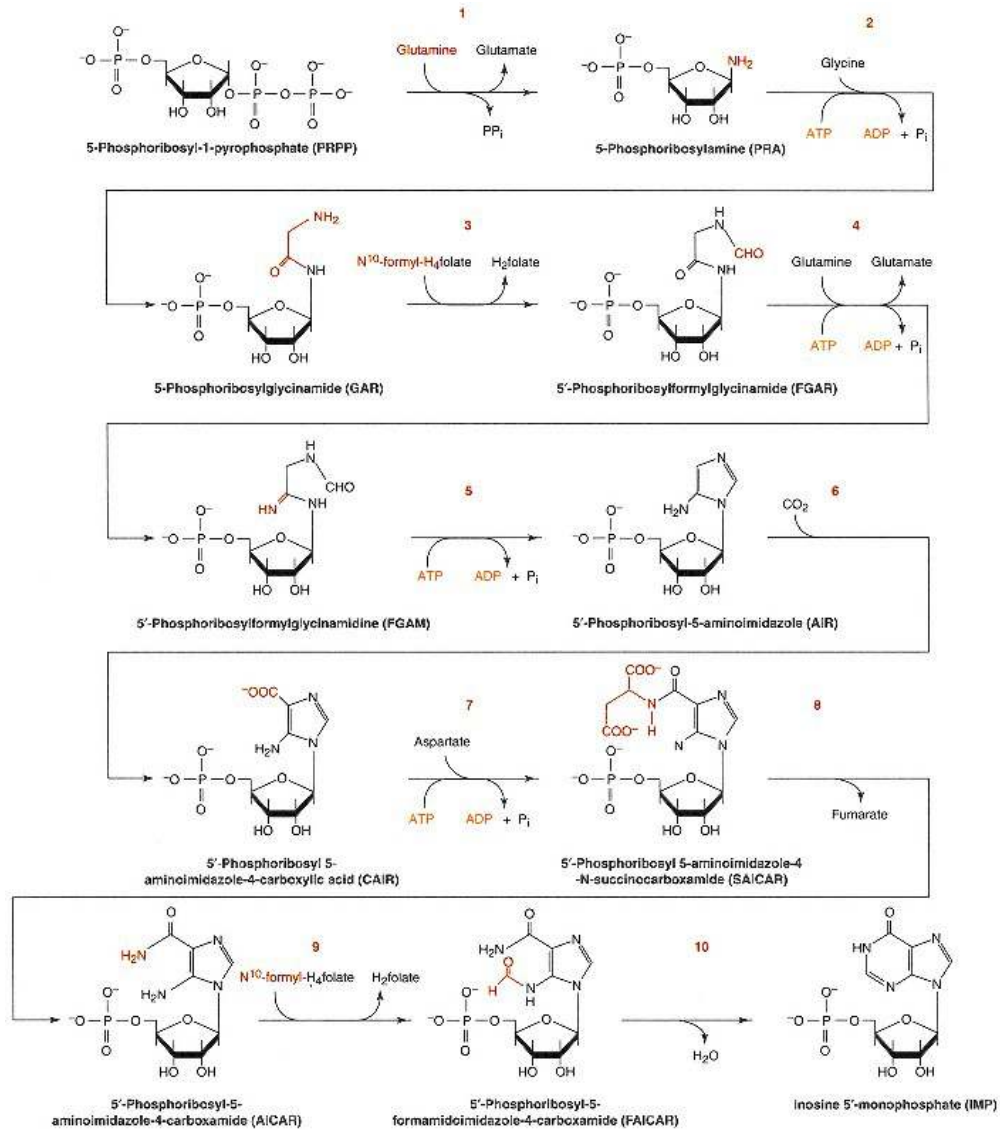

Figure 12.7

***De novo* synthesis of purine ribonucleotides.**

The enzymes catalyzing the reactions are:

- ① glutamine PRPP amidotransferase;
- ② GAR synthetase;
- ③ GAR transformylase;
- ④ FGAM synthetase;
- ⑤ AIR synthetase;
- ⑥ AIR carboxylase;
- ⑦ SAICAR synthetase;
- ⑧ adenylosuccinate lyase;
- ⑨ AICAR transformylase; and
- ⑩ IMP cyclodihydrolyase.

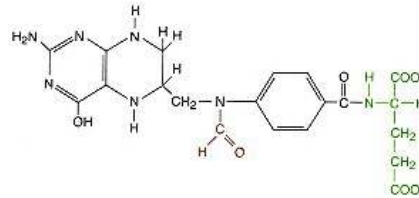

Figure 12.8
Structure of N^{10} -formyl H_4 folate.

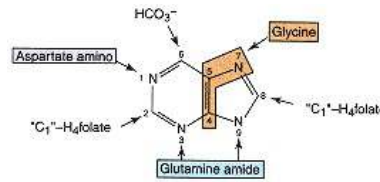

Figure 12.9
Sources of carbon and nitrogen atoms in the purine ring.
C-4, C-5, and N-7 are from glycine;
N-3 and N-9 from glutamine; C-2 and C-8 from
"C₁'"- H_4 folate; N-1 from aspartate; and C-6 from CO_2 .

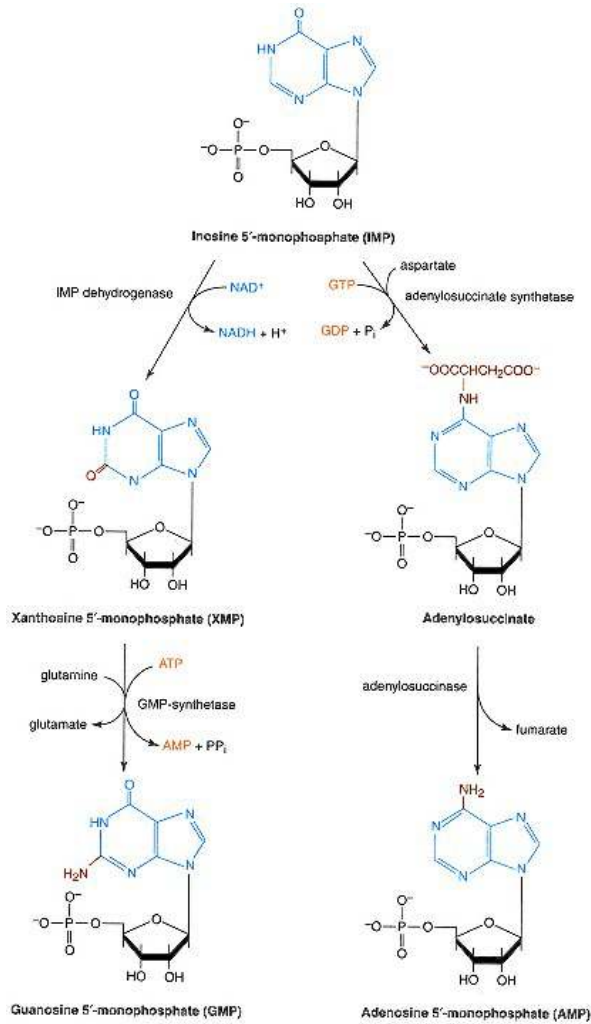

Figure 12.10
Formation of AMP and GMP from IMP branch point.

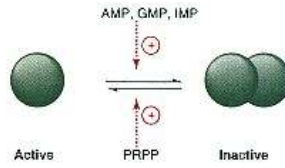

Figure 12.11
Effects of allosteric modulators on molecular forms of glutamine PRPP amido-transferase.

phate kinases and **nucleoside 5'-diphosphate kinases**. Conversion of IMP to AMP and GMP, from this branch point, does not occur randomly. Formation of GMP from IMP requires ATP as the energy source, whereas formation of AMP from IMP requires GTP as the energy source. This can be thought of as a reciprocal relationship. That is, when there is sufficient ATP in the cell, GMP will be synthesized and when there is sufficient GTP, AMP will be synthesized.

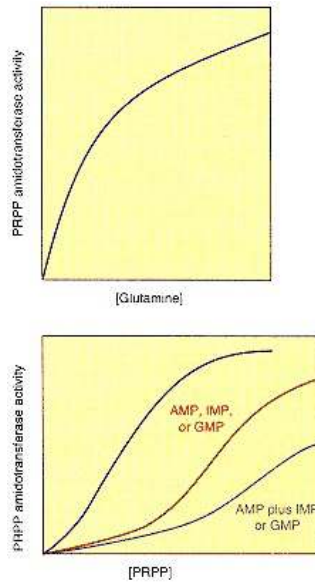

Figure 12.12
Glutamine PRPP amidotransferase activity as a function of glutamine or PRPP concentrations.

Purine Nucleotide Synthesis Is Highly Regulated

The committed step of a metabolic pathway is generally the site of metabolic regulation. In the *de novo* pathway of purine nucleotide synthesis, formation of 5-phosphoribosylamine from glutamine and **5-phosphoribosyl-1-pyrophosphate** is the committed step in IMP formation. The enzyme catalyzing this reaction, **glutamine PRPP amidotransferase**, is rate-limiting and is regulated allosterically by the end products of the pathway—IMP, GMP, and AMP. These nucleotides serve as negative effectors. On the other hand, PRPP is a positive effector. Glutamine PRPP amidotransferase is a monomer of 135 kDa that is enzymatically active. In the presence of IMP, AMP, or GMP, the enzyme forms a dimer that is much less active. The presence of PRPP favors the active monomeric form of the enzyme (Figure 12.11).

The enzyme from human tissues has distinct nucleotide-binding sites. One site specifically binds oxypurine nucleotides (IMP and GMP) while the other site specifically binds aminopurine nucleotides (AMP). When AMP and GMP or IMP are simultaneously present, the enzyme activity is synergistically inhibited. Glutamine PRPP amidotransferase displays hyperbolic kinetics with respect to glutamine as the substrate and sigmoidal kinetics with respect to PRPP (Figure 12.12). Since the intracellular concentration of glutamine is close to its K_m and the concentration varies relatively little, the glutamine concentration has little effect in regulating IMP synthesis. The intracellular concentration of PRPP, however, varies widely and can be 10 to 100 times less than the K_m for PRPP. As a result, the concentration of PRPP plays an important role in regulating synthesis of purine nucleotides.

Between the formation of 5-phosphoribosylamine and IMP, there are no known regulated steps. However, there is regulation at the branch point of IMP to AMP and IMP to GMP. From IMP to GMP, **IMP dehydrogenase** is the rate-limiting enzyme and it is regulated by GMP acting as a competitive inhibitor. **Adenylosuccinate synthetase** is the rate-limiting enzyme in conversion of IMP to AMP with AMP acting as a competitive inhibitor.

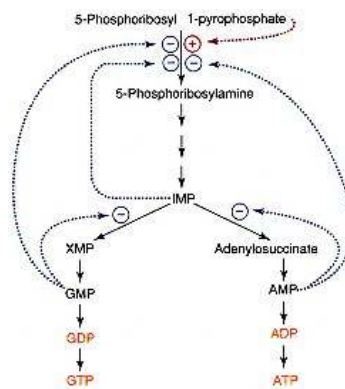

Figure 12.13
Regulation of purine nucleotide synthesis.
The dashed lines represent sites of active ⊕ or inhibition ⊖.

There must be other as yet unknown mechanisms that regulate the ATP/GTP ratio within relatively narrow limits. In most cells the total cellular concentration of adenine nucleotides (ATP plus ADP plus AMP) is four to six times that of guanine nucleotides (GTP plus GDP plus GMP). The overall regulation of purine nucleotide synthesis is summarized in Figure 12.13. Defects in the metabolic pathway that lead to loss of regulation of purine nucleotide synthesis result in overproduction of purine nucleotides and the end product, uric acid.

This results in a relatively common clinical condition known as gout (see Clin. Corr. 12.1).

Purine Bases and Nucleosides Can Be Salvaged to Reform Nucleotides

The efficiency of normal metabolism is shown by the presence of two distinct "**salvage pathways.**" One pathway utilizes the bases, hypoxanthine, guanine, and adenine as substrates while the other pathway utilizes preformed nucleosides as the substrates. In each pathway there is specificity with respect to the base or nucleoside being "salvaged." The "salvage" of bases requires the activity of **phosphoribosyl transferases**. There are two distinct phosphoribosyl transferases. **Hypoxanthine–guanine phosphoribosyltransferase** (HGPRTase) catalyzes the reactions

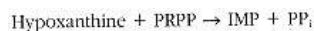

and



and **adenine phosphoribosyltransferase** (APRTase) catalyzes



CLINICAL CORRELATION 12.1

Gout

Gout is characterized by elevated uric acid levels in blood and urine due to a variety of metabolic abnormalities that lead to overproduction of purine nucleotides via the *de novo* pathway. Many, if not all, of the clinical symptoms associated with elevated levels of uric acid arise because of the very poor solubility of uric acid in the aqueous environment. Sodium urate crystals deposit in joints of the extremities and in renal interstitial tissue, and these events tend to trigger the sequelae. Hyperuricemia from overproduction of uric acid via the *de novo* pathway can be distinguished from hyperuricemia that results from kidney disease or excessive cell death (e.g., increased degradation of nucleic acids from radiation therapy). Feeding of [¹⁵N]glycine to a patient who is an overproducer will result in uric acid excreted in urine that is enriched in ¹⁵N at the N-7 of uric acid while in a patient who is not an overproducer, there will be no enrichment of ¹⁵N in uric acid from these patients.

Studies of "gouty" patients have shown that multiple and heterogeneous defects are the cause of overproduction of uric acid. In some cases, biochemical defects have not been defined. Examples of biochemical defects that result in increased purine nucleotide synthesis include the following:

1. Increased PRPP synthetase activity: Increased PRPP synthetase activity results in increased intracellular levels of PRPP. As discussed in the section on regulation of purine nucleotide synthesis, PRPP acts as a positive effector of glutamine–PRPP amidotransferase, leading to increased flux through the *de novo* pathway since activity of the rate-limiting step is markedly increased.

2. Partial HGPRTase activity: Partial decrease in HGPRTase activity has two fallouts with respect to the *de novo* pathway for purine nucleotide synthesis. First, since there is decreased salvage of hypoxanthine and guanine, PRPP is not consumed by the HGPRTase reaction and PRPP can activate glutamine–PRPP amidotransferase activity. Second, with decreased salvage of hypoxanthine and guanine, IMP and GMP are not formed via this pathway so that regulation of the PRPP amidotransferase step by IMP and GMP as negative effectors is compromised.

3. Glucose 6-phosphatase deficiency: In patients who have glucose 6-phosphatase deficiency (von Gierke's disease, type I glycogen storage disease) there is frequently hyperuricemia and gout as well. Loss of glucose 6-phosphatase activity results in more glucose 6-phosphate being shunted to the hexose monophosphate shunt. As a result of increased hexose monophosphate shunt activity, more ribose 5-phosphate is generated and the intracellular level of PRPP is increased. PRPP is a positive effector of PRPP amidotransferase.

These examples show that factors that increase the rate-limiting step in *de novo* synthesis of purine nucleotide synthesis lead to increased synthesis and degradation to uric acid.

There are different approaches to the treatment of gout that include colchicine, antihyperuricemic drugs, and allopurinol. Allopurinol and its metabolite, alloxanthine, are effective inhibitors of xanthine oxidase and will cause a decrease in uric acid levels. In "overproducers" who do not have a severe deficiency of HGPRTase activity, allopurinol treatment inhibits xanthine oxidase, thereby increasing the concentrations of hypoxanthine and xanthine. These purine bases are then salvaged to form IMP and XMP. These reactions consume PRPP and generate inhibitors of PRPP amidotransferase. The overall effect is that allopurinol treatment decreases both uric acid formation and *de novo* synthesis of purine nucleotides.

Becker, M. A., and Roessler, B. J. Hyperuricemia and gout. In: C. R. Scriver, A. L. Beaudet, W. S. Sly, and D. Valle (Eds.), *The Metabolic and Molecular Bases of Inherited Disease*, 7th ed., Vol. II, Chap. 49. New York: McGraw-Hill, 1995, pp. 1655–1677.

These two enzymes do not overlap in substrate specificity. The phosphoribosyl-transferase reactions are regulated by the end products of the reactions. IMP and GMP are competitive inhibitors, with respect to PRPP, of HGPRTase while AMP is a competitive inhibitor, with respect to PRPP, of APRTase. In this way, salvage of purine bases is regulated.

The hypoxanthine and guanine for salvage arise from degradation of endogenous or exogenous purine nucleotides. On the other hand, the source of adenine utilized in the APRTase reaction appears to be mainly from synthesis of polyamines (see p. 473). For each molecule of **spermine** synthesized, two molecules of **5'-methylthioadenosine** are generated that are degraded to **5-methylthioribose-1-phosphate** and adenine via the **5'-methylthioadenosine phosphorylase**-catalyzed reaction. The adenine base is salvaged through the APRTase reaction.

Generation of AMP and GMP through these phosphoribosyltransferase reactions effectively inhibits the *de novo* pathway at the PRPP amidotransferase step. First, PRPP is consumed, decreasing the rate of formation of 5-phosphoribosylamine; and second, AMP and GMP serve as feedback inhibitors at this step.

HGPRTase activity is markedly depressed in the **Lesch–Nyhan syndrome** (see Clin. Corr. 12.2), which is characterized clinically by hyperuricemia, mental retardation, and self-mutilation.

CLINICAL CORRELATION 12.2

Lesch–Nyhan Syndrome

The Lesch–Nyhan syndrome is characterized clinically by hyperuricemia, excessive uric acid production, and neurological problems, which may include spasticity, mental retardation, and self-mutilation. This disorder is associated with a very severe or complete deficiency of HGPRTase activity. The gene for HGPRTase is on the X chromosome, hence the deficiency is virtually limited to males. In a study of the available patients, it was observed that if HGPRTase activity was less than 2% of normal, mental retardation was present, and if the activity was less than 0.2% of normal, the self-mutilation aspect was expressed. This defect also leads to excretion of hypoxanthine and xanthine.

There are more than a hundred disease-related mutations defined in the HGPRTase gene from Lesch–Nyhan patients. These have led to the loss of HGPRTase protein, loss of HGPRTase activity, " K_m mutants," HGPRTase protein with a short half-life, and so on.

The role of HGPRTase is to catalyze reactions in which hypoxanthine and guanine are converted to nucleotides. The hyperuricemia and excessive uric acid production that occur in patients with the Lesch–Nyhan syndrome are easily explained by the lack of HGPRTase activity. Hypoxanthine and guanine are not salvaged, leading to increased intracellular pools of PRPP and decreased levels of IMP or GMP. Both of these factors promote *de novo* synthesis of purine nucleotides without regard for proper regulation of this pathway.

It is not understood why a severe defect in this salvage pathway leads to neurological problems. Adenine phosphoribosyltransferase activity in these patients is normal or elevated. With this salvage enzyme, presumably the cellular needs for purine nucleotides could be met by conversion of AMP to GMP via IMP if the cell's *de novo* pathway were not functioning. The normal tissue distribution of HGPRTase activity perhaps could explain the neurological symptoms. The brain (frontal lobe, basal ganglia, and cerebellum) has 10–20 times the enzyme activity found in liver, spleen, or kidney and from 4 to 8 times that found in erythrocytes. Individuals who have primary gout with excessive uric acid formation and hyperuricemia do not display neurological problems. It is argued that products of purine degradation (hypoxanthine, xanthine, and uric acid) cannot be toxic to the central nervous system (CNS). However, it is possible that these metabolites are toxic to the developing CNS or that lack of this enzyme leads to an imbalance in the concentrations of purine nucleotides at critical times during development.

If IMP dehydrogenase activity in brain were extremely low, lack of HGPRTase could lead to decreased levels of intracellular GTP due to decreased salvage of guanine. Since GTP is a precursor of tetrahydrobiopterin, a required cofactor in the biosynthesis of neurotransmitters, and is required in other functions such as signal transduction via G-proteins and protein synthesis, low levels of GTP during development could be the triggering factor in the observed neurological manifestations.

Treatment of Lesch–Nyhan patients with allopurinol will decrease the amount of uric acid formed, relieving some of the problems caused by sodium urate deposits. However, since the Lesch–Nyhan patient has a marked reduction in HGPRTase activity, hypoxanthine and guanine are not salvaged, PRPP is not consumed, and consequently *de novo* synthesis of purine nucleotides is not shut down. There is no treatment for the neurological problems. These patients usually die from kidney failure, resulting from high sodium urate deposits.

Rossiter, B. J. F., and Caskey, C. T. Hypoxanthine-guanine phosphoribosyl-transferase deficiency: Lesch–Nyhan syndrome and gout. In: C. R. Scriver, A. L. Beaudet, W. S. Sly, and D. Valle (Eds.), *The Metabolic and Molecular Bases of Inherited Disease*, 7th ed., Vol II, Chap. 50. New York: McGraw Hill, 1995, pp. 1679–1706.

Overall, these salvage reactions not only conserve energy but also permit cells to form nucleotides from the bases. The erythrocyte, for example, does not have glutamine PRPP amidotransferase and hence cannot synthesize 5-phosphoribosylamine, the first unique metabolite in the pathway of purine nucleotide synthesis. As a consequence, red cells must depend on purine phosphoribosyltransferases and 5-phosphotransferase to replenish their nucleotide pools.

Purine Nucleotides Can Be Interconverted to Maintain the Appropriate Balance of Adenine and Guanine Nucleotides

De novo synthesis of purine nucleotides is under very fine control, executed at the committed step catalyzed by **glutamine PRPP amidotransferase** and at the branch point of IMP to AMP and IMP to GMP. Additional enzymes present in mammalian cells allow for interconversions of adenine and guanine nucleotides to maintain the appropriate balance of cellular concentrations of these purine nucleotides. These interconversions occur by indirect steps. There is no direct one-step pathway for conversion of GMP to AMP or AMP to GMP. In each case, AMP or GMP is metabolized to IMP (Figure 12.14). These reactions are catalyzed by separate enzymes, each of which is under separate controls. Reductive deamination of GMP to IMP is catalyzed by **GMP reductase**. GTP activates this step while XMP is a strong competitive inhibitor of the reaction. GTP, while not required by the enzyme, increases enzyme activity by lowering the K_m with respect to GMP and by increasing V_{max} .

AMP deaminase (5-AMP aminohydrolase) catalyzes deamination of AMP to IMP and is activated by K^+ and ATP and inhibited by P_i , GDP, and GTP. In the absence of K^+ , the v versus $[AMP]$ curve is sigmoidal. The presence of K^+ is not required for maximum activity; rather K^+ is a positive allosteric effector reducing the apparent K_m for AMP.

The net effect of these reactions is that cells can interconvert adenine and guanine nucleotides to meet cellular needs, while maintaining control over these reactions.

GTP Is Precursor of Tetrahydrobiopterin

GTP is the direct precursor for **tetrahydrobiopterin** synthesis (Figure 12.15). Reactions from GTP to tetrahydrobiopterin are catalyzed by **GTP cyclohydrolase I**, **6-pyruvoyl-tetrahydropterin synthase**, and **sepiapterin reductase**, with GTP cyclohydrolase I being rate-limiting. Many cell types can synthesize tetrahydrobiopterin. Tetrahydrobiopterin is a required cofactor in hydroxylation reactions involving phenylalanine, tyrosine, and tryptophan (see p. 476) and is involved in the generation of nitric oxide. Inhibitors of IMP dehydrogenase cause a marked reduction in cellular levels of tetrahydrobiopterin, demonstrating the importance of GTP as the precursor of tetrahydrobiopterin and of IMP dehydrogenase as the rate-limiting enzyme in GTP formation.

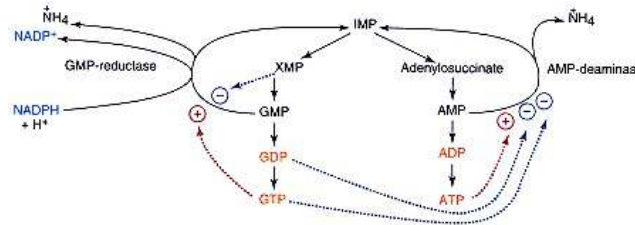

Figure 12.14
Interconversions of purine nucleotides.
The dashed lines represent sites of regulation; ⊖ inhibition.

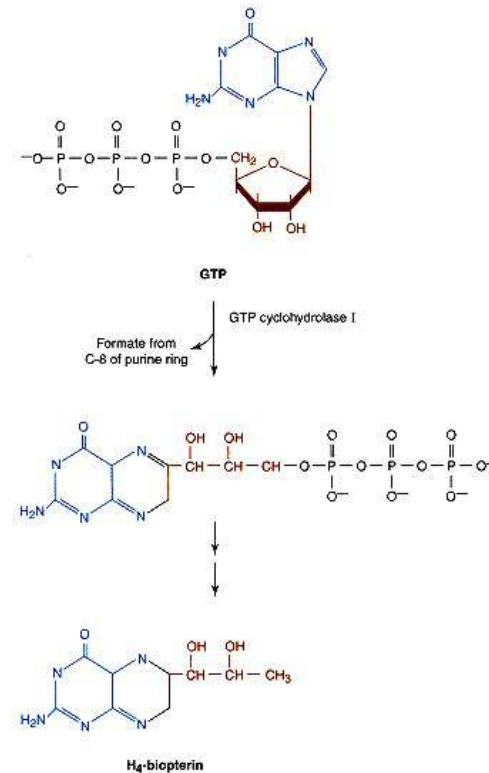
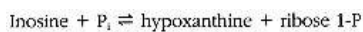

Figure 12.15
Synthesis of tetrahydrobiopterin from GTP.

End Product of Purine Degradation in Humans Is Uric Acid

The degradation of purine nucleotides, nucleosides, and bases funnel through a common pathway leading to formation of uric acid (Figure 12.16). The enzymes involved in degradation of nucleic acids and nucleotides and nucleosides vary in specificity. **Nucleases** show specificity toward either RNA or DNA and also toward the bases and position of cleavage site at the 3',5'-phosphodiester bonds. **Nucleotidases** range from those with relatively high specificity, such as 5'-AMP nucleotidase, to those with broad specificity, such as the acid and alkaline phosphatases, which will hydrolyze any of the 3' - or 5' -nucleotides. **AMP deaminase** is specific for AMP. **Adenosine deaminase** is less specific, since not only adenosine but also 2'-deoxyadenosine and many other 6-amino-purine nucleosides are deaminated by this enzyme.

Purine nucleoside phosphorylase catalyzes the reversible reactions



or

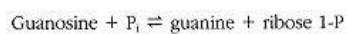

or

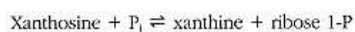

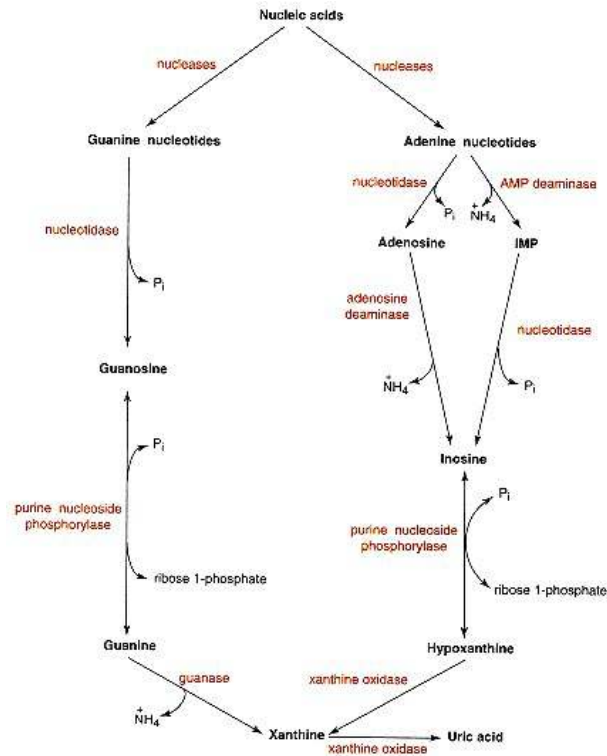
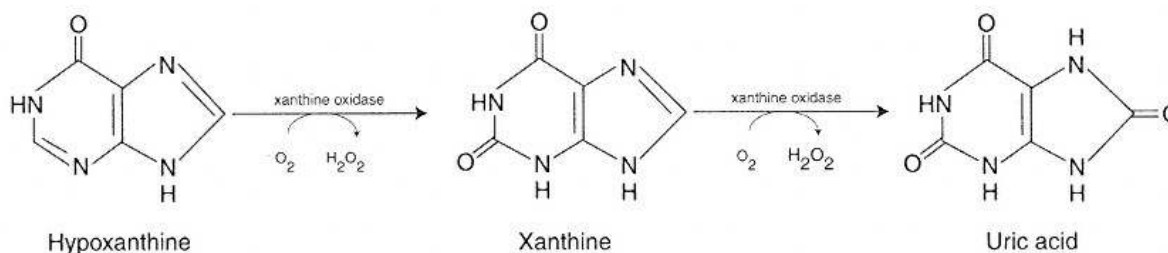

Figure 12.16
Degradation of purine nucleotides.

Deoxyinosine and deoxyguanosine are also excellent substrates for purine nucleoside phosphorylase. This is important for removal of deoxyguanosine to prevent uncontrolled accumulation of dGTP, which is toxic to cells at high concentrations. While the equilibrium constants for reactions catalyzed by purine nucleoside phosphorylase favor the direction of nucleoside synthesis, cellular concentrations of free purine base and ribose 1-phosphate are too low to support nucleoside synthesis under normal conditions. The main function of the enzyme is the degradative rather than synthetic pathway. Deficiencies in adenosine deaminase and purine nucleoside phosphorylase have been correlated with disease states in humans. Adenosine deaminase deficiency is associated with **severe combined immunodeficiency**, and purine nucleoside phosphorylase deficiency with a defective **T-cell immunity** but normal B-cell immunity (see Clin. Corr. 12.3).

Formation of Uric Acid

As seen in Figure 12.16, adenine nucleotides end up as hypoxanthine while guanine nucleotides are metabolized to xanthine. These purines are metabolized by **xanthine oxidase** to form **uric acid**, a unique end product of purine nucleotide degradation in humans. The reactions are as follows:



Xanthine oxidase is an enzyme that contains FAD, Fe, and Mo and requires molecular oxygen as a substrate. Since uric acid is not very soluble in aqueous medium, there are clinical conditions in which elevated levels of uric acid result in deposition of sodium urate crystals primarily in joints (see Clin. Corr. 12.1).

12.5—

Metabolism of Pyrimidine Nucleotides

The pyrimidine ring is synthesized *de novo* in mammalian cells utilizing amino acids as carbon and nitrogen donors and CO₂ as a carbon donor. *De novo* synthesis of pyrimidine nucleotide leads to **uridine 5'-monophosphate (UMP)** in six metabolic steps. ATP hydrolysis (or equivalent) is required to drive several steps in the pathway.

CLINICAL CORRELATION 12.3

Immunodeficiency Diseases Associated with Defects in Purine Nucleoside Degradation

Two distinct immunodeficiency diseases are associated with defects in adenosine deaminase (ADA) and purine nucleoside phosphorylase (PNP), respectively. These enzymes are involved in the degradative pathways leading to formation of uric acid. Substrates for adenosine deaminase are adenosine and deoxyadenosine, while substrates for purine nucleoside phosphorylase are inosine, guanosine, deoxyinosine, and deoxyguanosine. A deficiency in ADA is associated with a severe combined immunodeficiency involving both T-cell and B-cell functions. PNP deficiency is associated with an immunodeficiency involving T-cell functions with the sparing of effects on B-cell function. In neither case is the mechanism(s) by which the lack of these enzymes leads to immune dysfunction known. However, in ADA-deficient patients, intracellular concentrations of dATP and S-adenosylhomocysteine are greatly increased. Several hypotheses have been put forth to explain the biochemical consequences of a lack of ADA: (1) high levels of dATP inhibit ribonucleotide reductase activity and as a consequence inhibit DNA synthesis; (2) deoxyadenosine inactivates S-adenosyl homocysteine hydrolase, leading to decreased S-adenosylmethionine required for methylation of bases in RNA and DNA; and (3) increased levels of adenosine result in increased cAMP levels. It is possible that each of these mechanisms contributes to the overall effect of immune dysfunction. There is not, however, a suitable explanation for the specificity of the effects on only T cells and B cells.

Treatment of children with ADA deficiency have included blood transfusions, bone marrow transplantation, enzyme replacement therapy with ADA-polyethylene glycol (ADA-PEG), and, most recently, gene therapy. Each of these treatments has disadvantages. Blood transfusions produce problems of "iron overload" and safety of the source. Bone marrow transplantation, while curative, requires a suitably matched donor. Enzyme replacement therapy with ADA-PEG has been the most successful to date, but the treatment requires constant monitoring of ADA levels and frequent injections of ADA-PEG, and there is considerable cost involved for the ADA-PEG. Gene therapy presents the hope for the future. While it has not been unequivocally established that gene therapy is curative, there are strong indications in early gene therapy trials that the ADA gene has been successfully transfected into stem cells of ADA-deficient children.

Cournoyer, D., and Caskey, C. T. Gene therapy of the immune system. *Annu. Rev. Immunol.* 11:297, 1993; Hershfield, M. S. PEG-ADA: an alternative to haploidentical bone marrow transplantation and an adjunct to gene therapy for adenosine deaminase deficiency. *Hum. Mutat.* 5:107, 1995; Hershfield, M. S., and Mitchell, B. S. Immunodeficiency diseases caused by adenosine deaminase deficiency and purine nucleoside phosphorylase deficiency. In: C. R. Scriver, A. L. Beaudet, W. S. Sly, and D. Valle (Eds.), *The Metabolic and Molecular Bases of Inherited Disease*, 7th ed., Vol. II, Chap. 52. New York: McGraw-Hill, 1995, pp. 1725-1768; Hoogerbrugge, P. M., von Beusechem, V. W., Kaptein, L. C., Einerhard, M. P., and Valerio, D. Gene therapy for adenosine deaminase deficiency. *Br. Med. Bull.* 51:72, 1995; Markert, M. L. Molecular basis for adenosine deaminase deficiency. *Immunodeficiency* 5:141, 1994; and Markert, M. L. Purine nucleoside phosphorylase deficiency. *Immunodeficiency Rev.* 3:45, 1991.

Pyrimidine Nucleotides Are Synthesized by a Stepwise Series of Reactions to Form UMP

In contrast to *de novo* purine nucleotide synthesis, all enzymes for *de novo* synthesis of pyrimidine nucleotides are not found in the cytosol of the cell. Reactions leading to formation of UMP are shown in Figure 12.17. The following

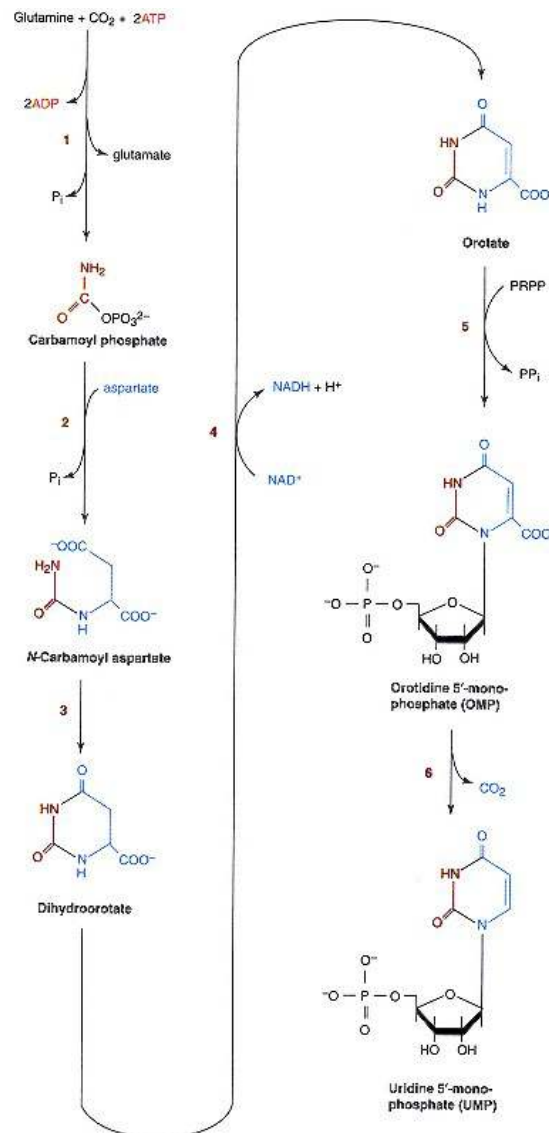

Figure 12.17

De novo synthesis of pyrimidine nucleotides.

Enzyme activities catalyzing the reactions are

- ① carbamoyl phosphate synthetase II,
- ② aspartate carbamoyl-transferase,
- ③ dihydroorotase,
- ④ dihydroorotate dehydrogenase,
- ⑤ orotate phosphoribosyltransferase, and
- ⑥ OMP decarboxylase. The activities of ③ are on a trifunctional protein (CAD); the activities of ⑥ are on a bifunctional protein (UMP synthase).

CLINICAL CORRELATION 12.4

Hereditary Orotic Aciduria

Hereditary orotic aciduria results from a defect in *de novo* synthesis of pyrimidine nucleotides. This genetic disease is characterized by severe anemia, growth retardation, and high levels of orotic acid excretion. The biochemical basis for this orotic aciduria is a defect in one or both of the activities (orotate phosphoribosyltransferase or orotidine decarboxylase) associated with UMP synthase, the bifunctional protein. It is a very rare disease (only 15 patients are known) but the understanding of the metabolic basis for this disease has led to successful treatment of the disorder. Patients are fed uridine, which leads not only to reversal of the hematologic problem but also to decreased formation of orotic acid. Uridine is taken up by cells and converted by uridine phosphotransferase to UMP that is converted to UDP and then to UTP. UTP formed from exogenous uridine, in turn, inhibits carbamoyl phosphate synthetase II, the major regulated step in the *de novo* pathway. As a result, orotic acid via the *de novo* pathway is markedly decreased to essentially normal levels. UTP is also a substrate for CTP synthesis. In effect, then, exogenous uridine bypasses the defective UMP synthase and supplies cells with UTP and CTP required for nucleic acid synthesis and other cellular functions. The success of treatment of hereditary orotic aciduria with uridine provides *in vivo* data regarding the importance of the carbamoyl phosphate synthase step as the site of regulation of pyrimidine nucleotide synthesis in humans.

Webster, D. R., Becroft, D. M. O., and Suttle, D. P. Hereditary orotic aciduria and other disorders of pyrimidine metabolism. In: C. R. Scriver, A. L. Beaudet, W. S. Sly, and D. Valle (Eds.), *The Metabolic and Molecular Bases of Inherited Disease*, 7th ed., Vol. II, Chap. 55. New York: McGraw-Hill, 1995, pp. 1799–1837.

important aspects of the pathway should be noted. The pyrimidine ring is formed first and then ribose 5-phosphate is added via PRPP. The enzyme catalyzing formation of carbamoyl phosphate, **carbamoyl phosphate synthetase II**, is cytosolic and is distinctly different from **carbamoyl phosphate synthetase I** found in the mitochondria as part of the urea cycle. Synthesis of *N*-carbamoylaspartate is the committed step in pyrimidine nucleotide synthesis but formation of cytosolic carbamoyl phosphate is the regulated step. Formation of **orotate** from dihydroorotate is catalyzed by a mitochondrial enzyme. Other enzymes of the pathway are found in the cytosol on multifunctional proteins. The enzyme activities of carbamoyl phosphate synthetase II, aspartate carbamoyl-transferase, and dihydroorotase are found on a trifunctional protein (CAD), and orotate phosphoribosyltransferase and OMP decarboxylase activities are found on a bifunctional protein, defined as UMP synthase. A defect in this bifunctional protein that affects either phosphoribosyltransferase activity or decarboxylase activity leads to a rare clinical condition known as hereditary orotic aciduria (see Clin. Corr. 12.4).



Figure 12.18
Formation of UTP from UMP.

This series of reactions produces UMP. Other major pyrimidine nucleotides found in cells are cytidine nucleotides, which are formed from UTP; UMP is converted to UTP by **nucleotide diphosphokinase** (Figure 12.18). **CTP synthetase** catalyzes formation of CTP from UTP with glutamine being the amino group donor (Figure 12.19). CTP synthetase displays homotropic sigmoidal-

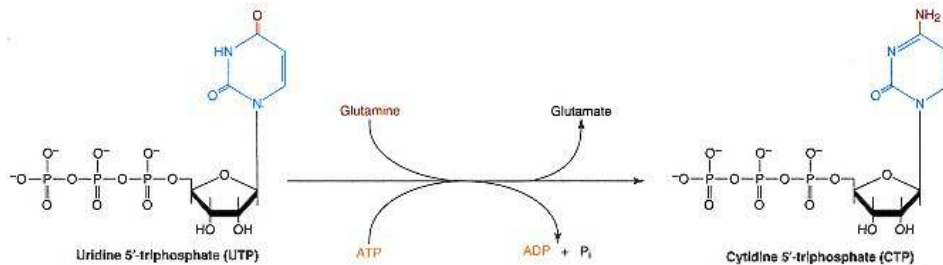

Figure 12.19 Formation of CTP from UTP catalyzed by CTP synthetase.

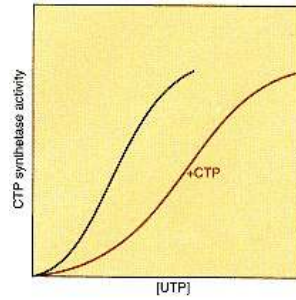

Figure 12.20
Regulation of CTP synthetase.

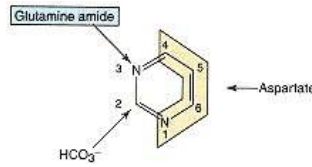

Figure 12.21
Sources of carbon and nitrogen atoms in pyrimidines.
C-4, C-5, and C-6, and N-1 are from aspartate; N-3 is from glutamine; and C-2 from CO₂.

dal kinetics; CTP, the product, is a negative effector of the reaction as shown in Figure 12.20.

To summarize, *de novo* synthesis of pyrimidine nucleotides requires aspartate and glutamine as carbon and nitrogen donors and CO₂ as a carbon donor (Figure 12.21). Five of the six reactions in the pathway take place in the cytosol of the cell, while the other reaction occurs in the mitochondria. The enzyme activities involved with the cytosolic reactions reside on multifunctional proteins. UTP is the direct precursor of CTP.

Pyrimidine Nucleotide Synthesis in Humans Is Regulated at the Level of Carbamoyl Phosphate Synthetase II

Regulation of pyrimidine nucleotide synthesis in mammalian cells occurs at the carbamoyl phosphate synthetase II step. As mentioned earlier, carbamoyl phosphate synthetase II is a cytosolic enzyme and distinct from carbamoyl phosphate synthetase I, which is mitochondrial, utilizes ammonia as the amino donor, and is activated by *N*-acetylglutamate. Carbamoyl phosphate synthetase II is inhibited by UTP, an end product of the pathway, and is activated by PRPP. *K_i* for UTP and *K_a* for PRPP are in the range of values that would allow intracellular levels of UTP and PRPP to have an effect on the control of pyrimidine nucleotide synthesis. Carbamoyl phosphate synthetase II is the only source of carbamoyl phosphate in extrahepatic tissues. However, in liver, under stressed conditions in which there is excess ammonia, carbamoyl phosphate synthetase I can generate carbamoyl phosphate in mitochondria, which ends up in the cytosol and serves as a substrate for pyrimidine nucleotide synthesis. This pathway serves to detoxify excess ammonia. Elevated levels of orotic acid are excreted as a result of ammonia toxicity in humans. This points to carbamoyl phosphate synthetase II as being the major regulated activity in pyrimidine nucleotide metabolism.

UMP does not inhibit carbamoyl phosphate synthetase II activity but does compete with OMP to inhibit the **OMP decarboxylase** (Figure 12.22). As discussed earlier, conversion of UTP to CTP is also regulated so that cells can maintain a balance between uridine and cytidine nucleotides.

Pyrimidine Bases Are Salvaged to Reform Nucleotides

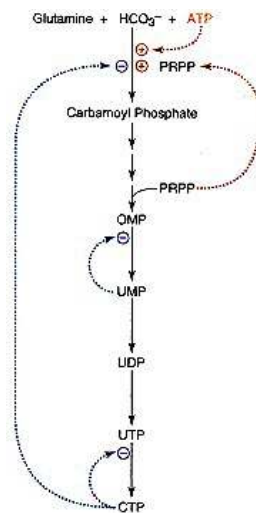
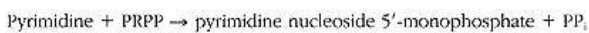

Figure 12.22
Regulation of pyrimidine nucleotide synthesis.
Solid arrows represent enzyme catalyzed reactions and dashed arrows represent activation

Pyrimidines are "salvaged" by conversion to the nucleotide level by reactions involving **pyrimidine phosphoribosyltransferase**. The general reaction is



The enzyme from human erythrocytes can utilize orotate, uracil, and thymine as substrates but not cytosine. These salvage pathways divert the pyrimidine base from the degradative pathway to the nucleotide level for cellular utilization. As a pyrimidine base becomes available to cells, there are competing

reactions that will either result in degradation and excretion or reutilization of the bases. For example, when normal liver is presented with uracil, it is rapidly degraded to β -alanine, whereas proliferating tumor cells would convert uracil to UMP. This is the result of the availability of PRPP, enzyme levels, and metabolic state of the animal.

12.6— Deoxyribonucleotide Formation

As indicated previously, the concentrations of **deoxyribonucleotides** are extremely low in nonproliferating cells. Only at the time of DNA replication (S phase) does the deoxyribonucleotide pool increase to support the required DNA synthesis.

Deoxyribonucleotides Are Formed by Reduction of Ribonucleoside Diphosphates

Nucleoside 5'-diphosphate reductase (ribonucleotide reductase) catalyzes the reaction in which 2'-deoxyribonucleotides are synthesized from the corresponding ribonucleoside 5'-diphosphate. The reaction is controlled not only by the amount of enzyme present in cells but also by a very finely regulated allosteric control mechanism. The reaction can be summarized as shown in Figure 12.23. Reduction of a particular substrate requires the presence of a specific nucleoside 5'-triphosphate as a positive effector. For example, reduction of CDP or UDP requires ATP as the positive effector, while reduction of ADP and GDP require the presence of dGTP and dTTP, respectively. A small molecular weight protein, **thioredoxin** or **glutaredoxin**, is involved in reduction at the 2' position through oxidation of its sulfhydryl groups. To complete the catalytic cycle, NADPH is used to regenerate free sulfhydryl groups on the protein. **Thioredoxin reductase**, a flavoprotein, is required if thioredoxin is involved; glutathione and **glutathione reductase** are involved if glutaredoxin is the protein.

Mammalian ribonucleotide reductase consists of two nonidentical protein subunits (heterodimer), neither of which alone has enzymatic activity. The larger subunit has at least two different effector-binding sites. The smaller subunit contains a nonheme iron and a stable tyrosyl free radical. The two subunits make up the active site of the enzyme. The two subunits are encoded by different genes on separate chromosomes. The mRNAs for these subunits, and consequently the proteins, are differentially expressed as cells transit the cell cycle.

As mentioned earlier, the activity of ribonucleotide reductase is under allosteric control. While reduction of each substrate requires the presence of a specific positive effector, the products serve as potent negative effectors of the enzyme. DeoxyATP is a potent inhibitor of the reduction of all four substrates: CDP, UDP, GDP, and ADP; dGTP inhibits reduction of CDP, UDP, and GDP; dTTP inhibits reduction of CDP, UDP, and ADP. From this it is seen that dGTP

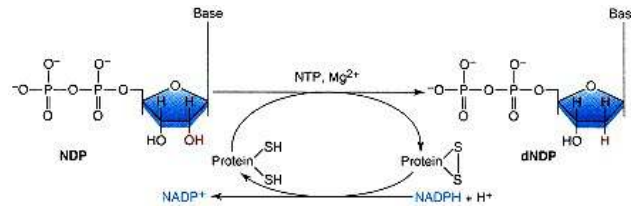

Figure 12.23
De novo synthesis of 2'-deoxyribonucleotides from ribonucleotides. This reaction is catalyzed by ribonucleotide reductase.

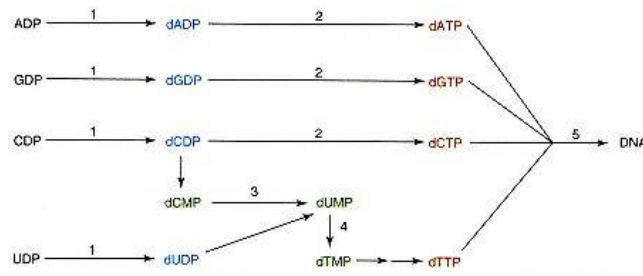

Figure 12.24
Role of ribonucleotide reductase in DNA synthesis.
 The enzymes catalyzing the reactions are
 (1) ribonucleotide reductase,
 (2) nucleoside 5'-diphosphate kinase,
 (3) deoxycytidylate deaminase,
 (4) thymidylate synthase, and
 (5) DNA polymerase.

and dTTP can serve as either positive or negative effectors of ribonucleotide reductase. Effective inhibition of ribonucleotide reductase by dATP, dGTP, or dTTP explains the toxicity of deoxyadenosine, deoxyguanosine, and thymidine to a variety of mammalian cells.

Ribonucleotide reductase is uniquely responsible for catalyzing the rate-limiting reactions by which 2'-deoxyribonucleoside 5'-triphosphates are synthesized *de novo* for DNA replication as summarized in Figure 12.24. Effective inhibitors of ribonucleotide reductase are potent inhibitors of DNA synthesis and hence of cell replication.

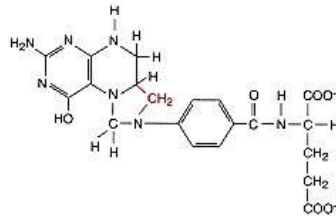
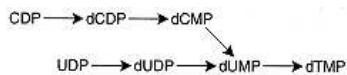

Figure 12.25
 Structure of N^5,N^{10} -methylene H_4 folate.

Deoxythymidylate Synthesis Requires N^5,N^{10} -Methylene H_4 Folate

Deoxythymidylate (dTMP) is formed from 2'-deoxyuridine 5'-monophosphate (dUMP) in a reaction that is unique. **Thymidylate synthase** catalyzes the reaction in which a one-carbon unit from N^5,N^{10} -methylene H_4 folate (Figure 12.25) is transferred to dUMP and simultaneously reduced to a methyl group. The reaction is presented in Figure 12.26. In this reaction, N^5,N^{10} -methylene H_4 folate serves as the one-carbon donor and as a reducing agent. This is the only reaction in which H_4 folate, acting as a one-carbon carrier, is oxidized to H_2 folate. There are no known regulatory mechanisms for this reaction.

The substrate for this reaction can come from two different pathways as shown below:



In both pathways deoxyribonucleotides, dCDP or dUDP, are generated by ribonucleotide reductase. In one pathway, dUMP is generated from dUDP while in the other pathway, dCMP is deaminated to dUMP. From labeling studies it

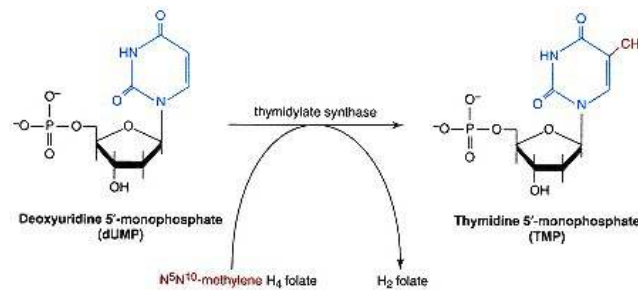

Figure 12.26
 Synthesis of deoxythymidine nucleotide.

appears that the major pathway for formation of dUMP involves deamination of dCMP by **dCMP deaminase**, an enzyme that is subject to allosteric regulation by dCTP (positive) and dTTP (negative) (Figure 12.27).

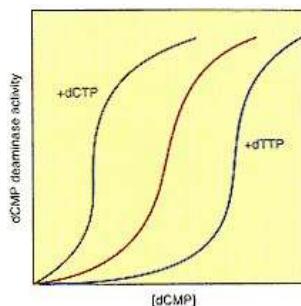

Figure 12.27
Regulation of dCMP deaminase.

Pyrimidine Interconversions with Emphasis on Deoxyribopyrimidine Nucleosides and Nucleotides

As shown in Section 12.4, there are metabolic pathways for interconversions of purine nucleotides and these pathways are regulated to maintain an appropriate balance of adenine and guanine nucleotides. Pathways also exist for interconversion of pyrimidine nucleotides and these pathways are of particular importance for pyrimidine deoxyribonucleosides and deoxyribonucleotide as summarized in Figure 12.28. Note that dCTP and dTTP are major positive and negative effectors of the interconversions and salvage of deoxyribonucleosides.

Pyrimidine Nucleotides Are Degraded to β -Amino Acids

Turnover of nucleic acids results in release of pyrimidine nucleotides and purine nucleotides (discussed previously). Degradation of pyrimidine nucleotides follows the pathways shown in Figure 12.29. In these degradative pathways the pyrimidine nucleotides are converted to nucleosides by nonspecific phosphatases. Cytidine and deoxycytidine are deaminated to uridine and deoxyuridine by pyrimidine **nucleoside deaminase**. **Uridine phosphorylase** catalyzes phosphorolysis of uridine, deoxyuridine, and thymidine resulting in formation of uracil and thymine as pyrimidine base products.

Uracil and thymine are then further degraded by analogous reactions, although the final products are different as shown in Figure 12.30. Uracil is degraded to β -alanine, NH_4^+ , and CO_2 . None of these products is unique to uracil degradation, and consequently the turnover of cytosine or uracil nucleotides cannot be estimated from the end products of this pathway. Thymine degradation proceeds to **β -aminoisobutyric acid**, NH_4^+ , and CO_2 . β -Aminoisobutyric acid is excreted in urine of humans and originates exclusively from degradation of thymine. Thus it is possible to estimate the turnover of DNA or thymidine nucleotides by measurement of β -aminoisobutyric acid excretion. Increased levels of β -aminoisobutyric acid are excreted in cancer patients undergoing chemotherapy or radiation therapy in which large numbers of cells are killed and DNA is degraded.

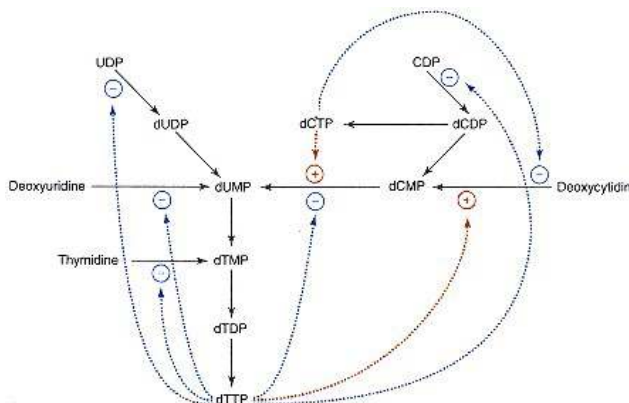

Figure 12.28
Interconversions of pyrimidine nucleotides with emphasis on deoxyribonucleotide metabolism.
The solid arrows indicate enzyme-catalyzed reactions; the dashed lines represent sites of activation \ominus .

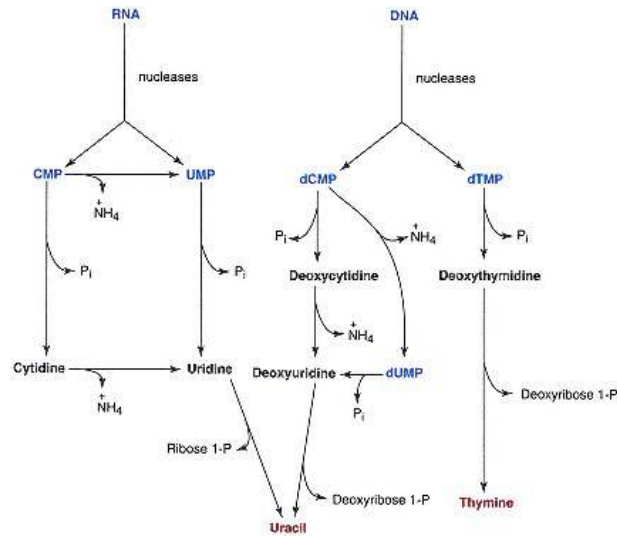

Figure 12.29
Pathways for degradation of pyrimidine nucleotides.

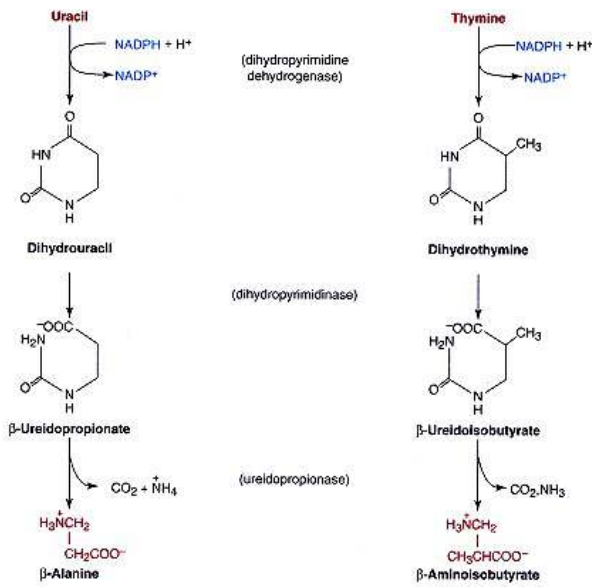

Figure 12.30
Degradation of uracil and thymine to end products.

Enzymes catalyzing degradation of uracil and thymine (**dihydropyrimidine dehydrogenase**, **dihydropyrimidinase**, and **uriedopropionase**) do not show a preference for either uracil or thymine or their degradative intermediates.

12.7—

Nucleoside and Nucleotide Kinases

As shown in Figures 12.7 and 12.17, *de novo* synthesis of both purines and pyrimidine nucleotides yields nucleoside 5'-monophosphates. Cells contain specific nucleoside kinases that utilize nucleosides from endogenous or exogenous sources to form nucleoside 5'-monophosphates. This is particularly important in a cell such as the red cell that cannot form nucleotides *de novo*.

In addition to nucleoside kinases, there are nucleotide kinases that convert a nucleoside 5'-monophosphate to nucleoside 5'-diphosphate and nucleoside 5'-diphosphates to nucleoside 5'-triphosphates. These are important reactions since most reactions in which nucleotides function require nucleoside 5'-triphosphate (primarily) or nucleoside 5'-diphosphate.

Nucleoside kinases show a high level of specificity with respect to the base and sugar moieties. There is also substrate specificity in nucleotide kinases. On the other hand, mammalian cells contain, in high concentration, nucleoside diphosphate kinase, which is relatively nonspecific for either phosphate donor or phosphate acceptor in terms of purine or pyrimidine base or the sugar. This reaction is as follows:

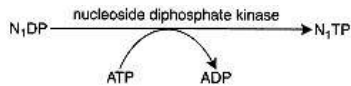

Since ATP is present in the highest concentration and most readily regenerated on a net basis via glycolysis or oxidative phosphorylation, ATP is probably the major donor for these reactions.

12.8—

Nucleotide-Metabolizing Enzymes As a Function of the Cell Cycle and Rate of Cell Division

For cell division to occur, essentially all of the components of cells must double. The term **cell cycle** describes the events that lead from formation of a daughter cell, as a result of mitosis, to completion of processes needed for its own division into two daughter cells. The cell cycle is represented in Figure 12.31. The phases of the cell cycle have been defined as mitosis (M), gap 1 (G1), synthesis (S) and gap 2 (G2). Some cells will enter G0, a state in which cells are viable and functional but are in a nonproliferative or quiescent phase. The total period of the cell cycle will vary with the particular cell type. In most mammalian cell types, times for the cell cycle phases of M, S, and G2 are relatively constant, while time periods for the G1 phase vary widely, causing cells to have long or short doubling times. There are many "factors" that will cause cells to leave the G0 state and reenter the cell cycle. In preparation for **DNA replication** (S phase), there are considerable increases in synthesis of enzymes involved in nucleotide metabolism, especially during late G1/early S. While protein and RNA synthesis occur throughout G1, S, and G2 phases of the cell cycle, DNA replication occurs only during S phase.

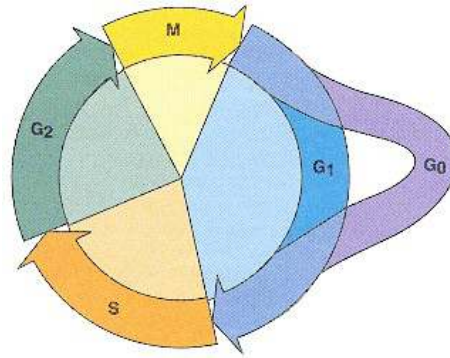

Figure 12.31

Diagrammatic representation of the cell cycle.

For a mammalian cell with a doubling time of 24 h, G1 would last ~12 h; S, 7 h; G2, 4 h; and M, 1 h. Cells would enter the G0 state if they became quiescent or nonproliferative.

Enzymes of Purine and Pyrimidine Nucleotide Synthesis Are Elevated during S Phase

Strict regulation of nucleotide synthesis requires that certain mechanisms must be available to the cell to meet the requirements for ribonucleotide and deoxyribonucleotide precursors at the time of increased RNA synthesis and DNA replication. To meet these needs, cells respond by increasing levels of specific enzymes involved with nucleotide formation during very specific periods of the cell cycle.

Enzymes involved in purine nucleotide synthesis and interconversions that are elevated during the S phase of the cell cycle are PRPP amidotransferase and IMP dehydrogenase. Adenylosuccinate synthetase and adenylosuccinase do not appear to increase. Enzymes involved in pyrimidine nucleotide synthesis that are elevated during the S phase of the cell cycle include aspartate carbamoyl-transferase, dihydroorotase, dihydroorotate dehydrogenase, orotate phosphoribosyltransferase, and CTP synthetase. Many enzymes involved in synthesis and interconversions of deoxyribonucleotides are also elevated during the S phase of the cell cycle. Included in these enzymes are ribonucleotide reductase, thymidine kinase, dCMP deaminase, thymidylate synthase, and TMP kinase. The importance of increased levels of enzyme activities during late G1/early S phase to DNA replication is worthy of further discussion with a specific example.

As discussed previously, the deoxyribonucleotide pool is extremely small in "resting" cells (less than 1 μM). As a result of the increase in ribonucleotide reductase, deoxyribonucleotides reach levels of 10–20 μM during DNA synthesis. However, this concentration would sustain DNA synthesis for only minutes, while complete DNA replication would require hours. Consequently, levels of ribonucleotide reductase activity not only must increase but must be sustained during S phase in order to provide the necessary substrates for DNA synthesis.

If we look at a population of cells (i.e., tissue) rather than individual cells going through the cell cycle, we observe that rapidly growing tissues such as regenerating liver, embryonic tissues, intestinal mucosal cells, and erythropoietic cells are geared toward DNA replication and RNA synthesis. These tissues will show elevated levels of those key enzymes involved with purine and pyrimidine nucleotide synthesis and interconversions and complementary decreases in levels of enzymes that catalyze reactions in which these precursors are degraded. These changes reflect the proportion of cells in that tissue that are in S phase.

There is an ordered pattern of biochemical changes that occur in tumor cells. Utilizing a series of liver, colon, and kidney tumors of varying growth rates, it has been possible to define these biochemical changes (1) **transformation-linked** (meaning that all tumors regardless of growth rate show certain increased and certain decreased enzyme levels), (2) **progression-linked** (alterations that correlate with growth rate of tumors), and (3) **coincidental alterations** (not connected to the malignant state). As very limited examples, levels of ribonucleotide reductase, thymidylate synthase, and IMP dehydrogenase increase as a function of tumor growth rate. PRPP amidotransferase, UDP kinase, and uridine kinase are examples of enzymes whose activity is increased in all tumors, whether they are slow-growing or the most rapidly growing tumors.

Alterations in gene expression in tumor cells are not only quantitative changes in enzyme levels but also qualitative changes (isozyme shifts). While some enzymes are increased in both fast-growing normal tissue (e.g., embryonic and regenerating liver) and tumors, the total quantitative and qualitative patterns for normal and tumor tissue can be distinguished.

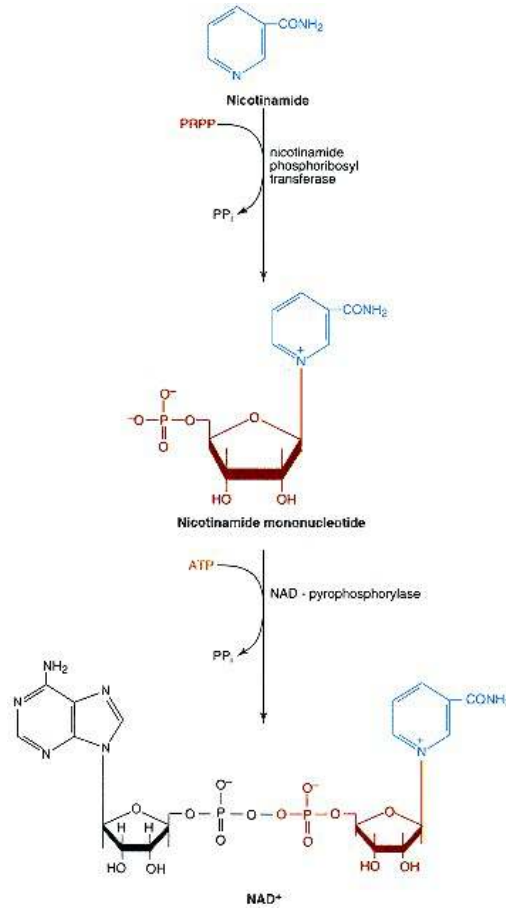

Figure 12.32
Pathway for NAD⁺ synthesis.

12.9—

Nucleotide Coenzyme Synthesis

Nicotinamide adenine dinucleotide (NAD⁺), flavin adenine nucleotide (FAD), and coenzyme A (CoA) serve as important coenzymes in intermediary metabolism. These coenzymes are synthesized by a variety of mammalian cell types. Figures 12.32 (p. 513), 12.33, and 12.34 present the biosynthetic pathways for each. NAD⁺ synthesis requires niacin, FAD synthesis requires riboflavin, and CoA requires pantothenic acid. NAD can be synthesized by three different pathways starting from tryptophan (see p. 475), nicotinate, or nicotinamide. When tryptophan is in excess of the amount needed for protein synthesis and serotonin synthesis, it is used for NAD⁺ synthesis. This situation is not likely in most normal diets and, consequently, niacin is required in the diet.

Each of these coenzymes has an AMP moiety as part of the molecule.

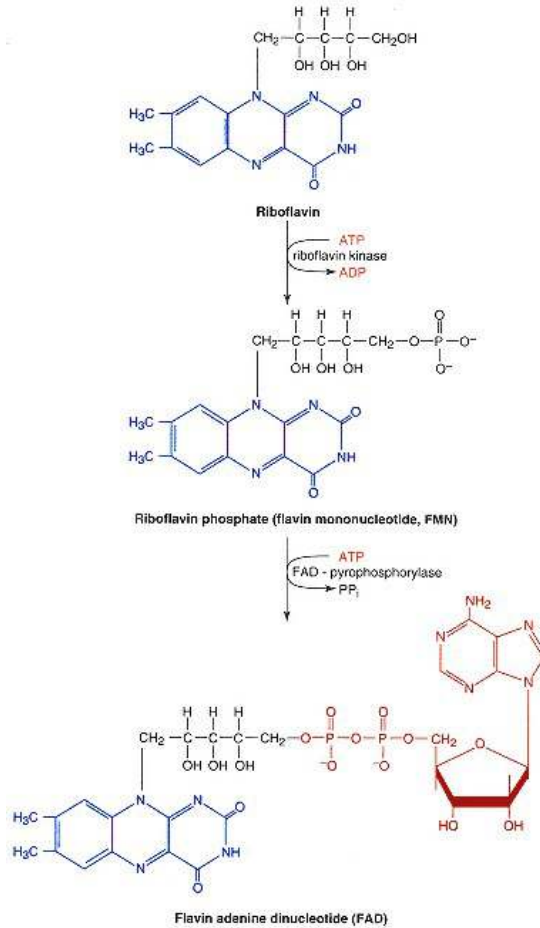

Figure 12.33
Synthesis of FAD.

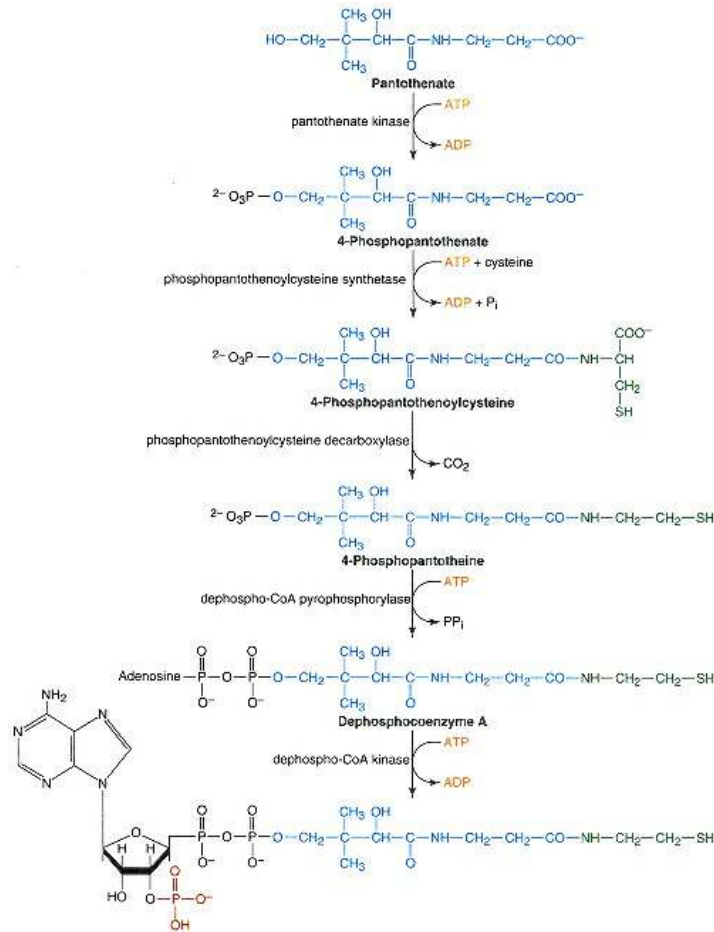

Figure 12.34
Synthesis of CoA.

However, the AMP is not directly involved in the functional part of the molecule since electron transfer in NAD^+ or FAD occurs via the niacin or riboflavin rings, respectively, and activation of acyl groups occurs through the $-\text{SH}$ group of CoA. Synthesis of NAD^+ by any of the three pathways requires utilization of PRPP as the ribose 5-phosphate donor. Nicotinamide adenine dinucleotide phosphate (NADP^+) is synthesized from NAD^+ . NAD^+ is used not only as a cofactor in oxidation–reduction reactions but also as a substrate in ADP-ribosylation reactions (e.g., DNA repair and pertussis toxin poisoning). These reactions lead to the turnover of NAD^+ . The end product of NAD^+ degradation is 2-pyridone-5-carboxamide, which is excreted in urine. Synthesis of nucleotide coenzymes is regulated such that there are essentially "fixed" concentrations of these coenzymes in the cell. When the statement is made that a certain

metabolic condition is favored when the concentration of NAD^+ is low, it means that the concentration of NADH is correspondingly high.

12.10—

Synthesis and Utilization of 5-Phosphoribosyl-1-Pyrophosphate

5-Phosphoribosyl-1-pyrophosphate (PRPP) is a key molecule in *de novo* synthesis of purine and pyrimidine nucleotides, salvage of purine and pyrimidine bases, and synthesis of NAD^+ . PRPP synthetase catalyzes the reaction presented in Figure 12.35. Ribose 5-phosphate used in this reaction is generated from glucose 6-phosphate metabolism via the **hexose monophosphate shunt** or from ribose 1-phosphate (generated by phosphorolysis of nucleotides) via a phosphoribomutase reaction.

The enzyme has an absolute requirement for inorganic phosphate and is strongly regulated. The v versus $[\text{P}_i]$ curve for PRPP synthetase activity is sigmoidal rather than hyperbolic, meaning that at the normal cellular concentration of P_i , the enzyme activity is depressed. The enzyme activity is further regulated by ADP, 2,3-bisphosphoglycerate, and other nucleotides. ADP serves as a competitive inhibitor of PRPP synthetase with respect to ATP; 2,3-bisphosphoglycerate is a competitive inhibitor with respect to ribose 5-phosphate; and nucleotides serve as noncompetitive inhibitors with respect to both substrates. 2,3-Bisphosphoglycerate may be important in regulating PRPP synthetase activity in red cells.

Levels of PRPP are low in "resting" or confluent cells but increase rapidly at the time of rapid cell division. Increased flux of glucose 6-phosphate through the hexose monophosphate shunt can result in increased cellular levels of PRPP and increased production of purine and pyrimidine nucleotides. PRPP is important not only because it serves as a substrate in the glutamine PRPP amidotransferase reaction and the phosphoribosyltransferase reactions, but also because it serves as a positive effector of the major regulated steps in purine and pyrimidine nucleotide synthesis, namely, PRPP amidotransferase and carbamoyl phosphate synthetase II.

Reactions and pathways in which PRPP is required are as follows:

1. *De novo* purine nucleotide synthesis

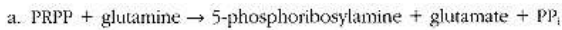

2. Salvage of purine bases

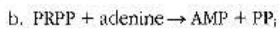
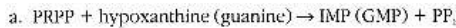

3. *De novo* pyrimidine nucleotide synthesis

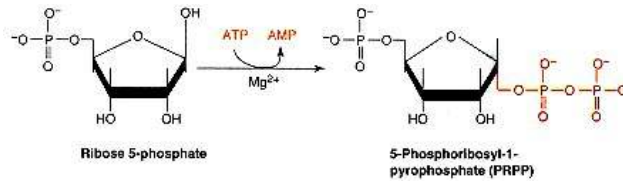
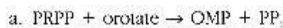
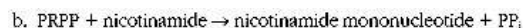

Figure 12.35
Synthesis of PRPP.

4. Salvage of pyrimidine bases

5. NAD^+ synthesis

12.11—

Compounds That Interfere with Cellular Purine and Pyrimidine Nucleotide Metabolism: Chemotherapeutic Agents

De novo synthesis of purine and pyrimidine nucleotides is critical to normal cell replication, maintenance, and function. Regulation of these pathways is important since disease states arise from defects in the regulatory enzymes. Many compounds have been synthesized or isolated as natural products from plants, bacteria, or fungi that are structural analogs of the bases or nucleosides used in metabolic reactions. These compounds are relatively specific inhibitors of enzymes involved in nucleotide synthesis or interconversions and have proved to be useful in therapy of diverse clinical problems. They are generally classified as antimetabolites, antifolates, glutamine antagonists, and other compounds.

Antimetabolites Are Structural Analogs of Bases or Nucleosides

Antimetabolites, generally, are structural analogs of purine and pyrimidine bases or nucleosides that interfere with very specific metabolic sites. They include **6-mercaptopurine** and **6-thioguanine** for treatment of acute leukemia, **azathioprine** for immunosuppression in patients with organ transplants, **allopurinol** for treatment of gout and hyperuricemia, and **acyclovir** for treatment of herpesvirus infection. The detailed understanding of purine nucleotide metabolism aided in the development of these drugs. Conversely, study of the mechanism of action of these drugs has led to a better understanding of normal nucleotide metabolism in humans.

Only a few of these will be discussed to show (1) the importance of *de novo* pathways in normal cell metabolism, (2) that regulation of these pathways occurs *in vivo*, (3) the concept of the requirement for metabolic activation of the drugs, and (4) that inactivation of these compounds can greatly influence their usefulness.

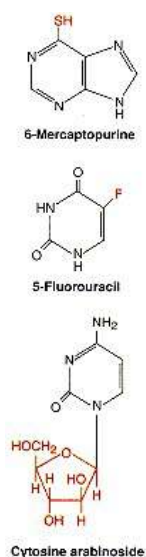

Figure 12.36
Structures of
6-mercaptopurine,
5-fluorouracil,
and cytosine
arabinoside.

6-Mercaptopurine (6-MP) (Figure 12.36) is a useful antitumor drug in humans. The cytotoxic activity of this agent is related to formation of 6-mercaptopurine ribonucleotide by the tumor cell. Utilizing PRPP and HGPRTase, 6-mercaptopurine ribonucleoside 5'-monophosphate accumulates in cells and is a negative effector of PRPP amidotransferase, the committed step in the *de novo* pathway. This nucleotide also acts as an inhibitor of the conversion of IMP to GMP at the IMP dehydrogenase step and IMP to AMP at the adenylosuccinate synthetase step. Since 6-mercaptopurine is a substrate for xanthine oxidase and is oxidized to 6-thiouric acid, allopurinol is generally administered to inhibit degradation of 6-MP and to potentiate the antitumor properties of 6-MP.

5-Fluorouracil (Fura) (Figure 12.36) is a pyrimidine analog of uracil. 5-Fluorouracil is, of itself, not the active species. It must be converted by cellular enzymes to the active metabolites 5-fluorouridine 5'-triphosphate (FUTP) and

5-fluoro-2'-deoxyuridine 5'-monophosphate (FdUMP). FUTP is efficiently incorporated into RNA and once incorporated into RNA inhibits maturation of 45S precursor rRNA into the 28S and 18S species and alters splicing of pre-mRNA into functional mRNA. FdUMP is a potent and specific inhibitor of thymidylate synthase. In the presence of H_4 folate, FdUMP, and thymidylate synthase, a ternary complex is formed that results in covalent bonding of FdUMP to thymidylate synthase. This results in inhibition of dTMP synthesis and leads, in effect, to what is called a "thymineless death" for cells.

Cytosine arabinoside (araC) (Figure 12.36) is used in treatment of several forms of human cancer. AraC must be metabolized by cellular enzymes to cytosine arabinoside 5'-triphosphate (araCTP) to exert its cytotoxic effects. AraCTP competes with dCTP in the DNA polymerase reaction and araCMP is incorporated into DNA. This results in inhibition of synthesis of the growing DNA strand. Clinically, the efficacy of araC as an antileukemic drug correlates with the concentration of araCTP that is achieved in the tumor cell, which in turn determines the level of araCMP incorporated into DNA. Formation of araCMP via deoxycytidine kinase appears to be the rate-limiting step in activation to araCTP.

Antifolates Inhibit Formation of Tetrahydrofolate

Antifolates interfere with formation of H_4 folate from H_2 folate or folate by inhibition of H_2 folate reductase. **Methotrexate (MTX)**, a close structural analog of folic acid, is used as an antitumor agent in treatment of human cancers. The comparison of the two structures is seen in Figure 12.37. Differences are at C-4 where an amino group replaces a hydroxyl group and at N-10 where a methyl group replaces a hydrogen atom. The mode of action of MTX is specific; it inhibits H_2 folate reductase with a K_i in the range of 0.1 nM. The reactions inhibited are shown in Figure 12.38.

MTX at very low concentrations is cytotoxic to mammalian cells in culture. The effects can be prevented by addition of thymidine and hypoxanthine to the culture medium. Reversal of the MTX effects by thymidine and hypoxanthine indicates that MTX causes depletion of thymidine and purine nucleotides in cells. Figure 12.39 shows the relationship between H_4 folate, *de novo* purine

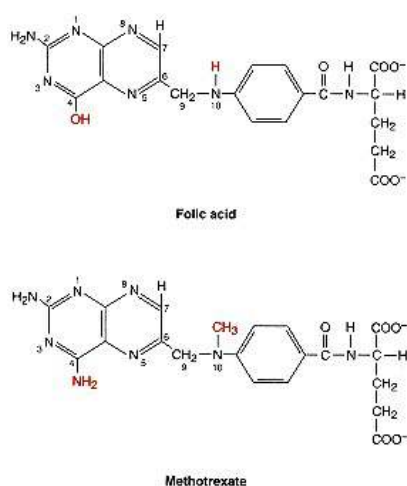

Figure 12.37
Comparison of the structures of folic acid and methotrexate.

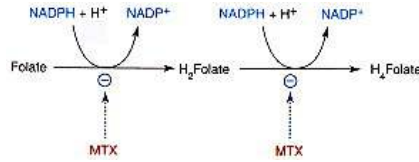

Figure 12.38
Sites of inhibition of methotrexate.

nucleotide synthesis, and dTMP formation. It is important to note that in the thymidylate synthase reaction, H₂folate is generated and unless it can readily be reduced back to H₄folate via dihydrofolate reductase, cells would not be capable of *de novo* synthesis of purine nucleotides or thymidylate synthesis due to depletion of H₄folate pools.

In treatment of human leukemias, normal cells can be rescued from the toxic effects of "high-dose MTX" by N⁵-formyl-H₄folate (**leucovorin**). This increases the clinical efficacy of MTX treatment.

Glutamine Antagonists Inhibit Enzymes that Utilize Glutamine as Nitrogen Donors

Many reactions in mammalian cells utilize glutamine as the amino group donor. This is different from bacterial cells that primarily utilize ammonia as the amino donor in a similar reaction. These amidation reactions are critical in *de novo* synthesis of purine nucleotide (N-3 and N-9), synthesis of GMP from IMP, formation of cytosolic carbamoyl phosphate, synthesis of CTP from UTP, and synthesis of NAD⁺.

Compounds that inhibit these reactions are referred to as glutamine antagonists. **Azaserine** (*O*-diazooacetyl-L-serine) and **6-diazo-5-oxo-L-norleucine** (DON) (Figure 12.40), which were first isolated from cultures of *Streptomyces*, are very effective inhibitors of enzymes that utilize glutamine as the amino donor. Since azaserine and DON inactivate the enzymes involved, addition of glutamine alone will not reverse the effects of either of these two drugs. It would necessitate that many metabolites such as guanine, cytosine, hypoxanthine (or adenine), and nicotinamide be provided to bypass the many sites blocked by these glutamine antagonists. As expected from the fact that so many key steps

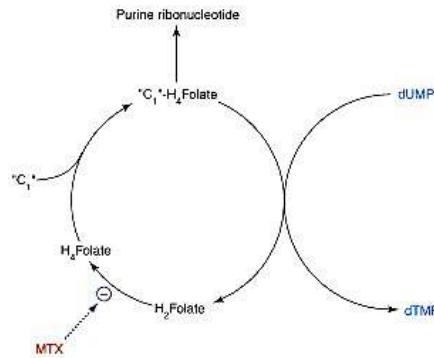

Figure 12.39
Relationships between H₂folate, *de novo* purine nucleotide synthesis, and dTMP synthesis.

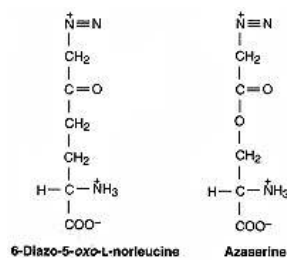

Figure 12.40
Structure of glutamine antagonists.

are inhibited by DON and azaserine, these agents are extremely toxic and not of clinical use.

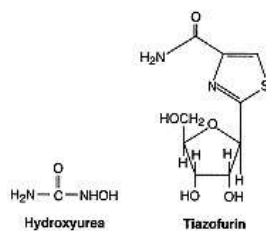

Figure 12.41
Structure of hydroxyurea
and tiazofurin.

Other Agents Inhibit Cell Growth by Interfering with Nucleotide Metabolism

Tumor cells treated with **hydroxyurea** (Figure 12.41) show a specific inhibition of DNA synthesis with little or no inhibition of RNA or protein synthesis. Hydroxyurea is an inhibitor of ribonucleotide reductase, blocking reduction of CDP, UDP, GDP, and ADP to the corresponding 2'-deoxyribonucleoside 5'-diphosphates. Toxicity of this drug results from depletion of 2'-deoxyribonucleoside 5'-triphosphates required for DNA replication. Although hydroxyurea is specific for inhibition of ribonucleotide reductase, its clinical use is limited because of its rapid rate of clearance and the high drug concentration required for effective inhibition.

Tiazofurin (Figure 12.41) is converted by cellular enzymes to the NAD⁺ analog, **tiazofurin adenine dinucleotide** (TAD). TAD inhibits IMP dehydrogenase, the rate-limiting enzyme in GTP synthesis, with a K_m of 0.1 μ M. As a result of IMP dehydrogenase inhibition, the concentration of GTP is markedly depressed.

These clinically useful drugs serve as examples in which knowledge of basic biochemical pathways and mechanisms leads to generation of effective drugs. An important point regarding many of the antimetabolites used as drugs is that they must be activated to the nucleotide level by cellular enzymes to exert their cytotoxic effects.

Purine and Pyrimidine Analogs As Antiviral Agents

Herpesvirus (HSV) and **human immunodeficiency virus** (HIV) infections (AIDS) present major clinical problems. Two antimetabolites have been identified that can be used in the control/treatment (but not cure) of HSV and HIV infections. These drugs—**acyclovir** (acycloguanosine), a purine analog, and **3'-azido-3'-deoxythymidine** (AZT), a pyrimidine analog (Figure 12.42)—require metabolism to phosphorylated compounds to yield the active drug. Acycloguanosine is activated to the monophosphate by a specific HSV-thymidine kinase, encoded by the HSV genome, which can catalyze phosphorylation of acycloguanosine. The host cellular thymidine kinase cannot utilize acyclovir as a substrate. Acycloguanosine monophosphate is then phosphorylated by the cellular enzymes to the di- and triphosphate forms. Acycloguanosine triphosphate serves as a substrate for the HSV-specific DNA polymerase and is incorporated into the growing viral DNA chain causing chain termination. The specificity of acycloguanosine and its high therapeutic index therefore reside in the fact that only HSV-infected cells can form the acycloguanosine monophosphate.

AZT is phosphorylated by cellular kinases to AZT triphosphate, which blocks HIV replication by inhibiting HIV-DNA polymerase (an RNA-dependent polymerase). The selectivity of AZT for HIV-infected versus uninfected cells occurs because DNA polymerase from HIV is at least 100-fold more sensitive to AZT triphosphate than is host cell DNA-dependent DNA polymerase.

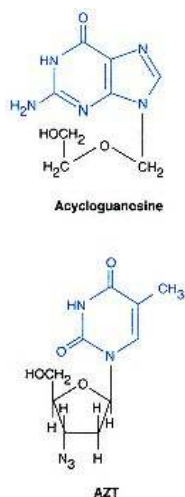

Figure 12.42
Structure of the
antiviral agents,
acyclovir and AZT.

These two antiviral agents demonstrate the diversity of responses required for selectivity. In one case, enzyme activity encoded by the viral genome is mandatory for activation of the drug (acycloguanosine); in the second example, although cellular enzymes activate the drug (AZT), the viral gene product (HIV-DNA polymerase) is the selective target.

Biochemical Basis for Development of Drug Resistance

Failure of chemotherapy in treatment of human cancer is often related to development of tumor cell populations that are resistant to the cytotoxic effects of

the particular drug. Tumors represent a very heterogeneous population of cells and in many instances drug-resistant cells are present. Upon therapy, drug-sensitive cells are killed off and a resistant cell population becomes enriched. In some cases, drug treatment causes genetic alterations that result in the drug-resistant phenotype. Resistance to drugs can be categorized as "specific drug resistance" or "multidrug resistance."

Biochemical and molecular mechanisms that account for drug resistance have been determined for many drugs. For example, resistance to methotrexate can develop as a result of several different alterations. These include a defect or loss of the transporter for N^5 -formyl- H_4 folate and N^5 -methyl- H_4 folate, which results in decreased cellular uptake of MTX; amplification of the dihydrofolate reductase gene, which results in a marked increase in cellular dihydrofolate reductase, the target enzyme; alterations in the dihydrofolate reductase gene that result in a "mutant" dihydrofolate reductase that is less sensitive to inhibition by MTX; and decreased levels of folylpolyglutamate synthetase, which results in lower levels of polyglutamylated MTX, the "trapped" form of MTX. A MTX-resistant population could have any one or a combination of these alterations. The net result of any of these resistance mechanisms is to decrease the ability of MTX to inhibit dihydrofolate reductase at clinically achievable MTX concentrations. Other specific drug resistance mechanisms could be described for compounds such as cytosine arabinoside, 5-fluorouracil, and hydroxyurea.

In multiple drug resistance, the drug-resistant population is cross-resistant to a series of seemingly unrelated antitumor agents. These compounds include drugs such as the vinca alkaloids, adriamycin, actinomycin D, and etoposide. All of these drugs are natural products or derived from natural products and they are not chemically related in structure. They have different mechanisms of action as antitumor agents but appear to act on some nuclear event.

Multidrug-resistant tumor cells express high levels (compared to the drug-sensitive tumor cell phenotype) of a protein called MDR1 (P-glycoprotein) or another protein called MRP (multidrug resistance protein). These proteins are membrane bound, have a mass around 170 kDa, but are distinctly separate proteins. These proteins function as "pumps" to efflux drugs from cells. As a result of increased efflux of drugs, caused by the ATP-dependent efflux proteins, the cellular concentration of drug is decreased below its cytotoxic concentration.

Development of drug-resistant tumor cells presents major clinical problems. Study of the mechanisms of drug resistance has greatly aided in our understanding of cancer cells.

Bibliography

Arner, E. S. J., and Eriksson, S. Mammalian deoxyribonucleoside kinases. *Pharmacol. Ther.* 67: 155, 1995.

Cory, J. G. Role of ribonucleotide reductase in cell division. In: J. G. Cory and A. H. Cory (Eds.), *Inhibitors of Ribonucleoside Diphosphate Reductase Activity*, International Encyclopedia of Pharmacology and Therapeutics. New York: Pergamon, 1989, p. 1.

Elion, G. B. The purine path to chemotherapy. *Science* 244:41, 1989.

Scriver, C. R., Beaudet, A. L., Sly, W. S., and Valle, D. (Eds.). *The Metabolic and Molecular Bases of Inherited Disease*, 7th ed. Vol. II, Chaps. 49–55. New York: McGraw-Hill, 1995.

Weber, G. Biochemical strategy of cancer cells and the design of chemotherapy: G.H.A. Clowes Memorial Lecture. *Cancer Res.* 43:3466, 1983.

Zalkin, H., and Dixon, J. E. De novo purine nucleotide biosynthesis. *Prog. Nucleic Acid Res.* 42:259, 1992.

Questions

C. N. Angstadt and J. Baggott

1. Nucleotides serve all of the following roles EXCEPT:

- A. monomeric units of nucleic acids.
- B. physiological mediators.
- C. sources of chemical energy.
- D. structural components of membranes.
- E. structural components of coenzymes.

Refer to the following figure for Questions 2–4.

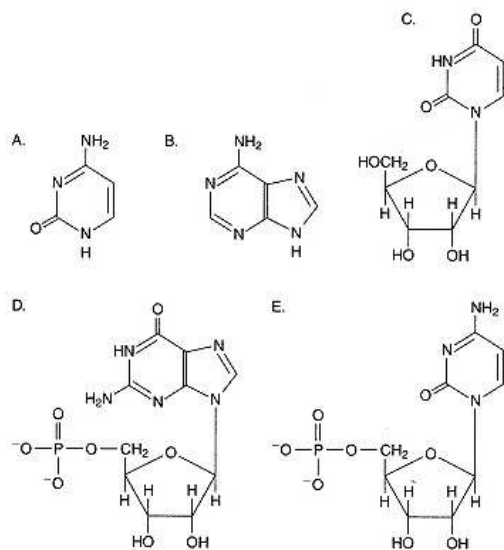

- Identify adenine.
- Identify a pyrimidine nucleoside.
- Identify CMP.
- The amide nitrogen of glutamine is a source of nitrogen for the:
 - de novo* synthesis of purine nucleotides.
 - de novo* synthesis of pyrimidine nucleotides.
 - synthesis of GMP from IMP.
 - all of the above.
 - none of the above.
- The enzyme catalyzing the rate-limiting step of the *de novo* synthesis of purine nucleotides:
 - is a multifunctional protein.
 - uses PRPP as a substrate.
 - requires AMP for activity.
 - is controlled primarily by substrate availability.
 - shows sigmoidal kinetics with respect to both of its substrates.
- The two purine nucleotides found in RNA:
 - are formed in a branched pathway from a common intermediate.
 - are formed in a sequential pathway.
 - must come from exogenous sources.
 - are formed by oxidation of the deoxy forms.
 - are synthesized from nonpurine precursors by totally separate pathways.
- Which of the following is/are aspects of the overall regulation of *de novo* purine nucleotide synthesis?
 - AMP, GMP, and IMP cause a shift of PRPP amidotransferase from a small form to a large form.
 - PRPP levels in the cell can be severalfold less than the K_m of PRPP amidotransferase for PRPP.
 - GMP is a competitive inhibitor of IMP dehydrogenase.
 - All of the above are correct.
 - None of the above is correct.
- The type of enzyme known as a phosphoribosyltransferase is involved in all of the following EXCEPT:
 - salvage of pyrimidine bases.
 - the *de novo* synthesis of pyrimidine nucleotides.
 - the *de novo* synthesis of purine nucleotides.
 - salvage of purine bases.
- Uric acid is:
 - formed from xanthine in the presence of O_2 .
 - a degradation product of cytidine.
 - deficient in the condition known as gout.
 - a competitive inhibitor of xanthine oxidase.
 - oxidized, in humans, before it is excreted in urine.
- In nucleic acid degradation, all of the following are correct EXCEPT:
 - there are nucleases that are specific for either DNA or RNA.
 - nucleotidases convert nucleotides to nucleosides.
 - the conversion of a nucleoside to a free base is an example of hydrolysis.
 - because of the presence of deaminases, hypoxanthine rather than adenine is formed.
 - a deficiency of adenosine deaminase leads to an immunodeficiency.
- In the *de novo* synthesis of pyrimidine nucleotides:
 - reactions take place exclusively in the cytosol.
 - a free base is formed as an intermediate.
 - PRPP is required in the rate-limiting step.
 - UMP and CMP are formed from a common intermediate.
 - UMP inhibition of OMP decarboxylase is the major control of the process.
- Deoxyribonucleotides:
 - cannot be synthesized so they must be supplied preformed in the diet.
 - are synthesized *de novo* using dPRPP.
 - are synthesized from ribonucleotides by an enzyme system involving thioredoxin.
 - are synthesized from ribonucleotides by nucleotide kinases.
 - can be formed only by salvaging free bases.
- β -Aminoisobutyrate:
 - is an intermediate in the degradation of both uracil and thymine.
 - in the urine can be used to estimate the turnover of DNA.
 - arises from uracil by cleavage of the pyrimidine ring.
 - is in equilibrium with β -alanine.
 - is the end product common to the degradation of both uracil and thymine.

15. The conversion of nucleoside 5'-monophosphates to nucleoside 5'-triphosphates:
- is catalyzed by nucleoside kinases.
 - is a direct equilibrium reaction.
 - utilizes a relatively specific nucleotide kinase and a relatively nonspecific nucleoside diphosphate kinase.
 - generally uses GTP as a phosphate donor.
 - occurs only during the S phase of the cell cycle.
16. If a cell were unable to synthesize PRPP, which of the following processes would likely be directly impaired?
- FAD synthesis
 - NAD synthesis
 - coenzyme A synthesis
 - ribose 5-phosphate synthesis
 - dTMP synthesis
17. Which of the following antitumor agents works by impairing *de novo* purine synthesis?
- acyclovir (acycloguanosine)
 - 5-fluorouracil (antimetabolite)
 - methotrexate (antifolate)
 - hydroxyurea
 - allopurinol

Answers

- D Both cAMP and cGMP are physiological mediators. NAD, FAD, and CoA all contain AMP as part of their structures (pp. 490–491).
- B Adenine is the free purine (A is a pyrimidine.)
- C A nucleoside contains a base plus sugar but no phosphate.
- E CMP is a pyrimidine nucleotide. (D is a purine nucleotide; pp. 492–493).
- D Nitrogen atoms 3 and 9 of purine nucleotides (p. 495, Fig. 12.7) and N-3 of pyrimidine nucleotides (p. 504, Fig. 12.17) are supplied by glutamine in *de novo* synthesis. The 2-amino group of GMP also comes from this source.
- B The rate-limiting step of purine nucleotide synthesis is the amido transfer between glutamine and PRPP (p. 494). A: There are several multifunctional proteins in the pathway but this is not one. C: It is inhibited by AMP. D: This is a typical allosteric enzyme. Know the things that control it. E: As expected for an allosteric enzyme, it does show sigmoidal kinetics but only with respect to PRPP. The kinetics for glutamine are hyperbolic.
- A GMP and AMP are both formed from the first purine nucleotide, IMP, in a branched pathway (p. 494). B: The pyrimidine nucleotides UMP and CTP are formed in a sequential pathway from orotic acid (p. 505). D: Deoxy forms are formed by reduction of the ribose forms.
- D A is the mechanism of inhibition since the large form of the enzyme is inactive (p. 497). B: PRPP amidotransferase shows sigmoidal kinetics with respect to PRPP so large shifts in concentration of PRPP have the potential for altering velocity (p. 497). C plays a major role in controlling the branched pathway of IMP to GMP or AMP (p. 497).
- C In purine nucleotide synthesis, the purine ring is built up stepwise on ribose-5-phosphate and not transferred to it (p. 497). A, B, and D: Phosphoribosyltransferases are important salvage enzymes for both purines and pyrimidines (pp. 506–507) and are also part of the synthesis of pyrimidines since OPRT catalyzes the conversion of orotate to OMP (pp. 503–504).
- A The xanthine oxidase reaction produces uric acid. B and E: Uric acid is an end product of purines, not pyrimidines. C: Gout is characterized by excess uric acid (p. 502, Fig. 12.16).
- C The product is ribose 1-phosphate rather than the free sugar, a phosphorolysis. A: They can also show specificity toward the bases and positions of cleavage. B: A straight hydrolysis. D: AMP deaminase and adenosine deaminase remove the 6-NH₂ as NH₃. The IMP or inosine formed is eventually converted to hypoxanthine (p. 502, Fig. 12.16). E: This is called severe combined immunodeficiency (pp. 501–502).
- B This is in contrast to purine *de novo* synthesis. A: One enzyme is mitochondrial. C: PRPP is required to convert orotate to OMP but this is not rate-limiting. D: OMP to UMP to CTP is a sequential process. E: This does occur but the rate-limiting step is that catalyzed by CPS II (pp. 502–506).
- C Deoxyribonucleotides are synthesized from the ribonucleoside diphosphates by nucleoside diphosphate reductase that uses thioredoxin as the direct hydrogen-electron donor (p. 507). A, B, and E: There is a synthetic mechanism as just described but it is not a *de novo* pathway. D: Nucleotide kinases are enzymes that add phosphate to a base or nucleotide.
- B This compound originates exclusively from thymine, which is found primarily in DNA. A and E: It is an end product of degradation but only of thymine. C and D: β -Alanine arises from cleavage of the uracil ring (p. 509).
- C These two enzymes are important in interconverting the nucleotide forms. A: These convert nucleosides to nucleoside monophosphates. B: Two steps are required. D: ATP is present in highest concentration and is the phosphate donor. E: Occurs during the S phase but this is a general reaction for the cell (pp. 509–510).
- D PRPP is formed from ribose 5-phosphate in an irreversible reaction. E: dTMP is formed directly from dUMP, which doesn't have to be made *de novo* (p. 507).
- C Antifolates reduce the concentration of THF compounds that are necessary for two steps of purine synthesis. A: This is an antiviral agent that inhibits DNA synthesis. B: 5-Fluorouracil is a pyrimidine analog not a purine analog. D: Hydroxyurea inhibits the reduction of ribonucleotides to deoxyribonucleotides so it is not involved in *de novo* purine synthesis. E: Allopurinol potentiates the effect of 6-mercaptopurine but is not an inhibitor of purine synthesis (pp. 517–520).

Chapter 13— Metabolic Interrelationships

Robert A. Harris and David W. Crabb

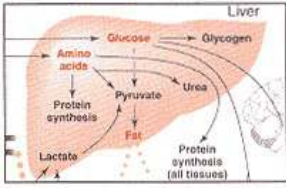

13.1 Overview	526
13.2 Starve–Feed Cycle	528
In the Well-Fed State the Diet Supplies the Energy Requirements	528
In the Early Fasting State Hepatic Glycogenolysis Is an Important Source of Blood Glucose	529
The Fasting State Requires Gluconeogenesis from Amino Acids and Glycerol	530
In the Early Refed State, Fat Is Metabolized Normally, but Normal Glucose Metabolism Is Slowly Reestablished	533
Other Important Interorgan Metabolic Interactions	534
Energy Requirements, Reserves, and Caloric Homeostasis	536
Glucose Homeostasis Has Five Phases	538
13.3 Mechanisms Involved in Switching the Metabolism of Liver between the Well-Fed State and the Starved State	539
Substrate Availability Controls Many Metabolic Pathways	540
Negative and Positive Allosteric Effectors Regulate Key Enzymes	540
Covalent Modification Regulates Key Enzymes	541
Changes in Levels of Key Enzymes Are a Longer Term Adaptive Mechanism	545
13.4 Metabolic Interrelationships of Tissues in Various Nutritional and Hormonal States	547
Staying in the Well-Fed State Results in Obesity and Insulin Resistance	547
Noninsulin-Dependent Diabetes Mellitus	548
Insulin-Dependent Diabetes Mellitus	550
Aerobic and Anaerobic Exercise Use Different Fuels	551
Changes in Pregnancy Are Related to Fetal Requirements and Hormonal Changes	552
Lactation Requires Synthesis of Lactose, Triacylglycerol, and Protein	552
Stress and Injury Lead to Metabolic Changes	553
Liver Disease Causes Major Metabolic Derangements	554
In Renal Disease Nitrogenous Wastes Accumulate	555
Oxidation of Ethanol in Liver Alters the NAD ⁺ /NADH Ratio	555
In Acid-Base Regulation, Glutamine Plays a Pivotal Role	556
The Colon Salvages Energy from the Diet	559
Bibliography	559
Questions and Answers	560
Clinical Correlations	
13.1 Obesity	526
13.2 Protein Malnutrition	527
13.3 Starvation	527
13.4 Reye's Syndrome	533
13.5 Hyperglycemic, Hyperosmolar Coma	537
13.6 Hyperglycemia and Protein Glycation	538
13.7 Noninsulin-Dependent Diabetes Mellitus	549
13.8 Insulin-Dependent Diabetes Mellitus	550
13.9 Complications of Diabetes and the Polyol Pathway	551
13.10 Cancer Cachexia	553

13.1— Overview

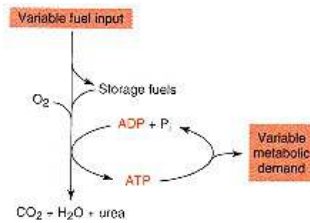

Figure 13.1
Humans are able to use a variable fuel input to meet a variable metabolic demand.

In this chapter the interdependence of metabolic processes of the major tissues of the body will be stressed. Not all of the major metabolic pathways operate in every tissue at any given time. Given the nutritional and hormonal status of a patient, we need to be able to say qualitatively which major metabolic pathways of the body are functional and how these pathways relate to one another.

The metabolic processes with which we are concerned are glycogenesis, glycogenolysis, gluconeogenesis, glycolysis, fatty acid synthesis, lipogenesis, lipolysis, fatty acid oxidation, glutaminolysis, tricarboxylic acid cycle activity, ketogenesis, amino acid oxidation, protein synthesis, proteolysis, and urea synthesis. It is important to know (1) which tissues are most active in these various processes, (2) when these processes are most or least active, and (3) how these processes are controlled and coordinated in different metabolic states.

The best way to gain an understanding of the relationships of the pathways to one another is to become familiar with the changes in metabolism that occur during the **starve–feed cycle**. As shown in Figure 13.1, the starve–feed cycle allows a variable fuel and nitrogen consumption to meet a variable metabolic and anabolic demand. Feed refers to the intake of meals (the variable fuel input) after which we store the fuel (in the form of glycogen and fat) to be used to meet our metabolic demand while we fast. Note the participation of an **ATP cycle** within the starve–feed cycle (Figure 13.1). Adenosine triphosphate

CLINICAL CORRELATION 13.1

Obesity

Obesity is the most common nutritional problem in the United States. It can reduce life span because it is a risk factor in development of diabetes mellitus, hypertension, endometrial carcinoma, osteoarthritis, gallstones, and cardiovascular diseases. Obesity is easy to explain—an obese person has eaten more than he/she required. The accumulation of massive amounts of body fat is not otherwise possible. For unknown reasons, the neural control of caloric intake to balance energy expenditure is abnormal. Rarely, obesity is secondary to a correctable disorder, such as hypothyroidism or Cushing's syndrome. The latter is the result of increased secretion of glucocorticoids, which cause fat deposition in the face and trunk, with wasting of the limbs, and glucose intolerance. These effects are due to increased protein breakdown in muscle and conversion of the amino acids to glucose and fat. Less commonly, tumors, vascular accidents, or maldevelopment of the nervous system hunger control centers in the hypothalamus cause obesity.

Genetic models of obesity in rodents have led to breakthroughs in our understanding of the control of body mass. The obese (*ob/ob*) mouse was discovered in the 1950s, and the defective gene cloned in 1994. This *ob* gene encodes a 146 amino acid secreted protein (alternatively called OB protein or leptin, for its slimming effect) that is produced in adipocytes and detectable in blood. The *ob/ob* mice have a nonsense mutation in the gene and produce no OB protein. Injection of the OB protein into *ob/ob* mice causes increased energy expenditure and reduced eating, with marked weight loss. This effect on appetite is mimicked by intracerebroventricular injection. The OB protein also reduced appetite and weight of normal mice. Obese humans do not generally have defective *ob* genes but, like normal mice, may still respond to OB protein used as an anti-obesity drug.

In the most common type of obesity, the number of adipocytes of the body does not increase, they just get large as they become engorged with triacylglycerols. If obesity develops before puberty, however, an increase in the number of adipocytes can also occur. In the latter case, both hyperplasia (increase in cell number) and hypertrophy (increase in cell size) are contributing factors to the magnitude of the obesity. Obesity in men tends to be centered on the abdomen and mesenteric fat, while in women it is more likely to be on the hips. The male pattern, characterized by a high waist to hip circumference ratio, is more predictive of premature coronary heart disease.

The only effective treatment of obesity is reduction in the ingestion or increase in the use of calories. Practically speaking, this means dieting, since even vigorous exercise such as running only consumes 10 kcal/min of exercise. Thus an hour-long run (perhaps 5–6 miles) uses the energy present in about two candy bars. However, exercise programs can be useful to help motivate individuals to remain on their diets. Unfortunately, the body compensates for decreased energy intake with reduced formation of triiodothyronine and a corresponding decrease in the basal metabolic rate. Thus there is a biochemical basis for the universal complaint that it is far easier to gain than to lose weight. Furthermore, about 95% of people who are able to lose a significant amount of weight regain it within one year.

Bray, G. D. Effect of caloric restriction on energy expenditure in obese patients. *Lancet* 2:397, 1969; Bray, G. D. The overweight patient. *Adv. Intern. Med.* 21:267, 1976; and Baringer, M. Obese protein slims mice. *Science* 269:475, 1995.

CLINICAL CORRELATION 13.2**Protein Malnutrition**

Protein malnutrition is the most important and widespread nutritional problem among young children in the world today. The clinical syndrome, called kwashiorkor, occurs mainly in children 1–3 years of age and is precipitated by weaning an infant from breast milk onto a starchy, protein-poor diet. The name originated in Ghana, meaning "the sickness of the older child when the next baby is born." It is a consequence of feeding the child a diet adequate in calories but deficient in protein. It may become clinically manifest when protein requirements are increased by infection, for example, malaria, helminth infestation, or gastroenteritis. The syndrome is characterized by poor growth, low plasma protein and amino acid levels, muscle wasting, edema, diarrhea, and increased susceptibility to infection. The presence of subcutaneous fat clearly differentiates it from simple starvation. The maintenance of fat stores is due to the high carbohydrate intake and resulting high insulin levels. In fact, the high insulin level interferes with the adaptations described for starvation. Fat is not mobilized as an energy source, ketogenesis does not take place, and there is no transfer of amino acids from the skeletal muscle to the visceral organs, that is, the liver, kidneys, heart, and immune cells. The lack of dietary amino acids results in diminished protein synthesis in all tissues. The liver becomes enlarged and infiltrated with fat, reflecting the need for hepatic protein synthesis for the formation and release of lipoproteins. In addition, protein malnutrition impairs the function of the gut, resulting in malabsorption of calories, protein, and vitamins, which accelerates the disease. The consequences of the disease depend somewhat on when in development the deficiency occurs. Children with low weight for height are called "wasted" but can make a good recovery when properly fed. Those with low height for weight are called "stunted" and never regain full height or cognitive potential.

Protein–calorie malnutrition is also a problem for the elderly when they become sick. Both the energy requirements and food intake of well elderly decline with age. On a lower calorie diet, there is the risk that insufficient intake of protein and of certain nutrients such as iron, calcium, and vitamins will be lower than needed. Deficiencies in these nutrients may accelerate loss of lean body mass and strength (leading to falls), anemia, loss of bone strength, and rarely, vitamin deficiency states.

Bistrrian, B. R., Blackburn, G. L., Vitale, J., and Cochran, D. Prevalence of malnutrition in general medical patients. *JAMA* 235:1567, 1976; Chase, H. P., Kumar, V., Caldwell, R. T., and O'Brien, D. Kwashiorkor in the United States. *Pediatrics* 66:972, 1980; and Schlienger, J. L., Pradignac, A., and Grunenberger, F. Nutrition of the elderly a challenge between facts and needs. *Horm. Res.* 43:46, 1995.

is the energy-transferring agent in the starve–feed cycle, being like money to the cell.

Humans have the capacity to consume food at a rate far greater than their basal caloric requirements, which allows them to survive from meal to meal. We thus store calories as glycogen and fat and utilize them as needed. Unfortunately, an almost unlimited capacity to consume food is matched by an almost unlimited capacity to store it as fat. **Obesity** is the consequence of excess food consumption and is the commonest form of malnutrition in affluent countries (see Clin. Corr. 13.1), whereas other forms of malnutrition are more prevalent in developing countries (see Clin. Corr. 13.2 and 13.3). The regulation of food

CLINICAL CORRELATION 13.3**Starvation**

Starvation leads to the development of a syndrome known as marasmus. Marasmus is a word of Greek origin meaning "to waste." Although not restricted to any age group, it is most common in children under 1 year of age. In developing countries early weaning of infants from breast milk is a common cause of marasmus. This may result from pregnancies in rapid succession, the desire of the mother to return to work, or the use of overdiluted artificial formulas (to make the expensive formulas last longer). This practice leads to insufficient intake of calories. Likewise, diarrhea and malabsorption can develop if safe water and sterile procedures are not used.

In contrast to kwashiorkor (see Clin. Corr. 13.2), subcutaneous fat, hepatomegaly, and fatty liver are absent in marasmus because fat is mobilized as an energy source and muscle temporarily provides amino acids to the liver for the synthesis of glucose and hepatic proteins. Low insulin levels allow the liver to oxidize fatty acids and to produce ketone bodies for other tissues. Ultimately, energy and protein reserves are exhausted, and the child starves to death. The immediate cause of death is often pneumonia, which occurs because the child is too weak to cough. Adults can suffer from marasmus as a result of diseases that prevent swallowing (cancer of the throat or esophagus) or interfere with access to food (strokes or dementia).

Waterlow, J. C. Childhood malnutrition—the global problem. *Proc. Nutr. Soc.* 38:1, 1979; and Uvin, P. The state of world hunger. *Nutr. Rev.* 52:151, 1994.

consumption is complex and not well understood. Recent observations suggest that the product of the **leptin gene** (*ob* in mice) expressed in adipocytes is secreted into the blood and regulates energy expenditure and appetite through the hypothalamus (see Clin. Corr. 13.1). The tight control needed is indicated by the calculation that eating two extra pats of butter (~100 cal) per day over caloric expenditures results in a 10-lb weight gain per year. A weight gain of 10 lb may not sound excessive, but multiplied by 10 years it equals obesity!

13.2— Starve–Feed Cycle

In the Well-Fed State the Diet Supplies the Energy Requirements

Figure 13.2 shows the fate of glucose, amino acids, and fat obtained from food. Glucose passes from the intestinal epithelial cells to the liver by way of the portal vein. Amino acids are partially metabolized in the gut before being released into portal blood. Fat, contained in **chylomicrons**, is secreted by the intestinal epithelial cells into lymphatics, which drain the intestine. The lymphatics lead to the thoracic duct, which, by way of the subclavian vein, delivers chylomicrons to the blood at a site of rapid blood flow. This rapidly distributes the chylomicrons and prevents their coalescence.

Liver is the first tissue to have the opportunity to use dietary glucose. Glucose can be converted into glycogen by glycogenesis, into pyruvate and lactate by glycolysis, or can be used in the pentose phosphate pathway for the

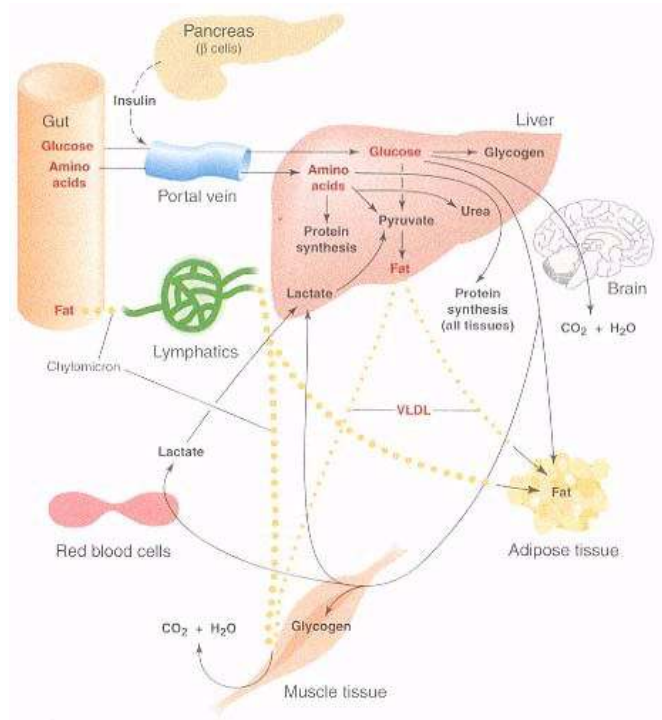

Figure 13.2
Disposition of glucose, amino acids, and fat by various tissues in the well-fed state.

generation of NADPH for synthetic processes. Pyruvate can be oxidized to acetyl CoA, which, in turn, can be converted into fat or oxidized to CO_2 and water by the TCA cycle. Much of the glucose coming from the intestine passes through the liver to reach other organs, including brain and testis, which are almost solely dependent on glucose for the production of ATP, red blood cells and renal medulla, which can only convert glucose to lactate and pyruvate, and the adipose tissue, which converts it into fat. Muscle also has good capacity to use glucose, converting it to glycogen or using it in the glycolytic and the TCA cycle pathways. A number of tissues produce lactate and pyruvate from circulating glucose, which are taken up by the liver and converted to fat. In the very well-fed state, the liver uses glucose and does not engage in gluconeogenesis. Thus the **Cori cycle** (the conversion of glucose to lactate in the peripheral tissues followed by conversion of lactate back to glucose in liver) is interrupted in the well-fed state.

Dietary protein is hydrolyzed in the intestine, the cells of which use some amino acids as an energy source. Most dietary amino acids are transported into the portal blood, but the intestinal cells metabolize aspartate, asparagine, glutamate, and glutamine and release alanine, lactate, citrulline, and proline into portal blood. Liver then has the opportunity to remove absorbed amino acids from the blood (Figure 13.2). The liver lets most of each amino acid pass through, unless the concentration of the amino acid is unusually high. This is especially important for the essential amino acids, needed by all tissues of the body for protein synthesis. Liver catabolizes amino acids, but the K_m values for amino acids of many of the enzymes involved are high, allowing the amino acids to be present in excess before significant catabolism can occur. In contrast, the tRNA-charging enzymes that generate **aminoacyl-tRNAs** have much lower K_m values for amino acids. This ensures that as long as all the amino acids are present, protein synthesis occurs as needed for growth and protein turnover. Excess amino acids can be oxidized completely to CO_2 , urea, and water, or the intermediates generated can be used as substrates for lipogenesis. Amino acids that escape the liver are used for protein synthesis or energy in other tissues.

Glucose, lactate, pyruvate, and amino acids can support hepatic **lipogenesis** (Figure 13.2). Fat formed from these substrates is released from the liver in the form of very low density lipoproteins (VLDLs). Dietary fat is delivered to the bloodstream as **chylomicrons**. Both chylomicrons and **VLDLs** circulate in the blood until they are acted on by an extracellular enzyme attached to the endothelial cells in the lumen of the capillaries. This enzyme, **lipoprotein lipase**, is particularly abundant in the capillaries in adipose tissue. It acts on both the VLDLs and chylomicrons, liberating fatty acids by hydrolysis of the triacylglycerols. The fatty acids are then taken up by the adipocytes, reesterified with glycerol 3-phosphate to form triacylglycerols, and stored as fat droplets. Glycerol 3-phosphate is generated from glucose, using the first half of the glycolytic pathway to generate dihydroxyacetone phosphate, which is reduced to glycerol 3-phosphate by glycerol-3-phosphate dehydrogenase.

The β cells of the pancreas are very responsive to the influx of glucose and amino acids in the fed state. The β cells release insulin during and after eating, which is essential for the metabolism of these nutrients by liver, muscle, and adipose tissue. The role of insulin in the starve–feed cycle is discussed in more detail in Section 13.3.

In the Early Fasting State Hepatic Glycogenolysis Is an Important Source of Blood Glucose

Hepatic glycogenolysis is very important for maintenance of blood glucose during early fasting (Figure 13.3). Lipogenesis is curtailed, and lactate, pyruvate, and amino acids used by that pathway are diverted into formation of glucose, completing the Cori cycle. The **alanine cycle**, in which carbon and nitrogen

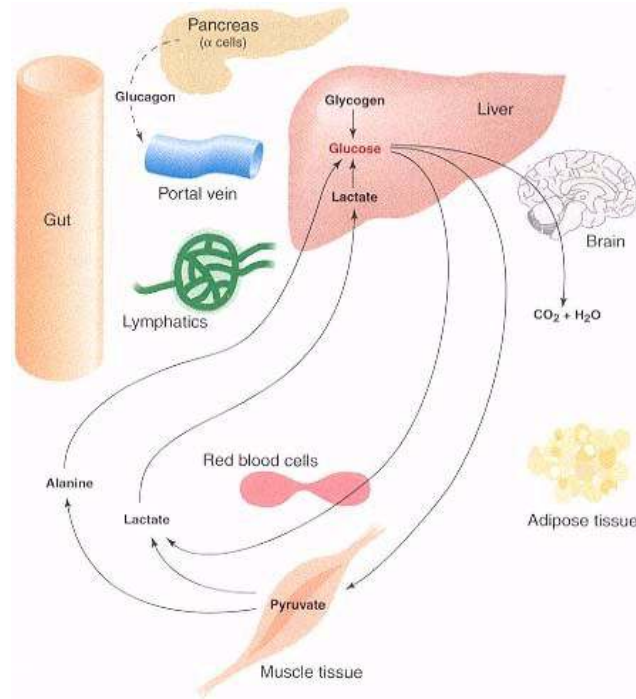

Figure 13.3
Metabolic interrelationships of major tissues in the early fasting state.

return to the liver in the form of alanine, also becomes important. Catabolism of amino acids for energy is greatly diminished in early fasting because less is available.

The Fasting State Requires Gluconeogenesis from Amino Acids and Glycerol

No fuel enters from the gut and little glycogen is left in the liver in the fasting state (Figure 13.4). Tissues that require glucose are dependent on hepatic **gluconeogenesis**, primarily from lactate, glycerol, and alanine. The Cori and alanine cycles play important roles but do not provide carbon for net synthesis of glucose. Glucose formed from lactate and alanine by the liver merely replaces that which was converted to lactate and alanine by peripheral tissues. In effect, these cycles transfer energy from fatty acid oxidation in the liver to peripheral tissues that cannot oxidize fat. The brain oxidizes glucose completely to CO_2 and water. Hence net glucose synthesis from some other source of carbon is mandatory in fasting. Fatty acids cannot be used for the synthesis of glucose, because acetyl CoA obtained by fatty acid catabolism cannot be converted to glucose. Glycerol, a by-product of lipolysis in adipose tissue, is an important substrate for glucose synthesis. However, protein, especially from skeletal muscle, supplies most of the carbon needed for net glucose synthesis. Proteins are hydrolyzed within muscle cells and most amino acids are partially metabolized within muscle cells. Only two amino acids—alanine and glutamine—are re-

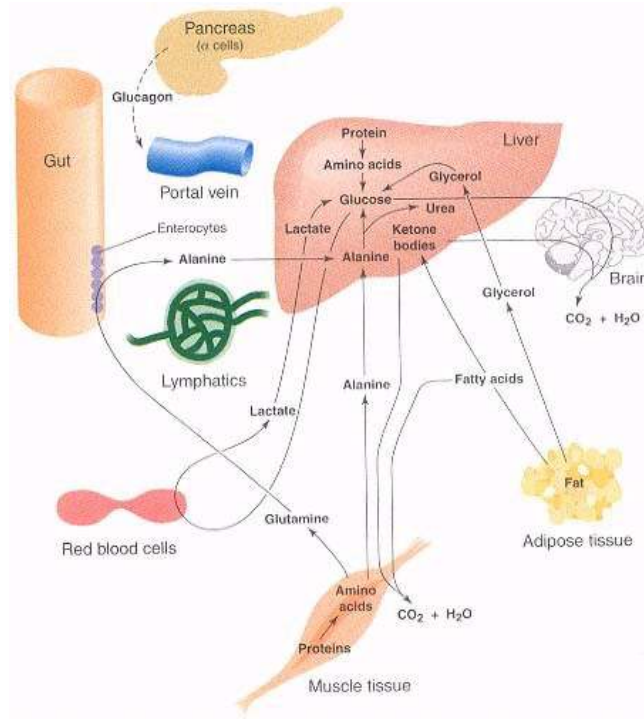

Figure 13.4

Metabolic interrelationships of major tissues in the fasting state.

leased in large amounts. The others are metabolized to give intermediates (pyruvate and α -ketoglutarate), which can yield alanine and glutamine. Branched-chain amino acids are a major source of nitrogen for the production of alanine and glutamine. Branched-chain α -keto acids produced from the branched-chain amino acids by transamination are partially released into the blood for uptake by the liver, which synthesizes glucose from the keto acid of valine, ketone bodies from the keto acid of leucine, and both glucose and ketone bodies from the keto acid of isoleucine.

Much of the glutamine released from muscle is converted into alanine by the intestinal epithelium. Glutamine is partially oxidized in **enterocytes** to supply energy and precursor molecules for synthesis of pyrimidines and purines, with the carbon and amino groups left over being released back into the bloodstream in part as alanine and NH_4^+ . This pathway, sometimes called **glutaminolysis** because glutamine is only partially oxidized, involves formation of malate from glutamine via the TCA cycle and the conversion of malate to pyruvate by malic enzyme (Figure 13.5a). Pyruvate then transaminates with glutamate to give alanine, which is released from the cells.

Glutaminolysis is also used by cells of the immune system (lymphocytes and macrophages) to meet a large portion of their energy needs (Figure 13.5b). Aspartate rather than alanine is the major end product of glutaminolysis in **lymphocytes**. Enterocytes and lymphocytes use glutamine as their major fuel source as a way to ensure a continuous supply of the precursor molecules

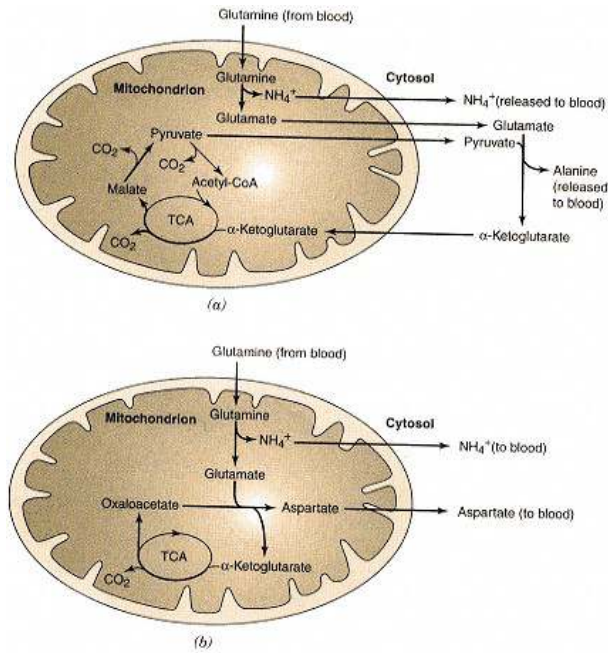

Figure 13.5
Glutamine catabolism by rapidly dividing cells.

(a) Enterocytes.
 (b) Lymphocytes.

Redrawn from Duée, P.-H., Darcy-Vrillon, B., Blachier, F., and Morel, M.-T. Fuel selection in intestinal cells. *Proc. Nutr. Soc.* 54:83, 1995.

(glutamine and aspartate) required for synthesis of purines and pyrimidines, which these rapidly dividing cells need for the synthesis of RNA and DNA.

Synthesis of glucose in the liver during fasting is closely linked to synthesis of urea. Most amino acids can give up the amino nitrogen by transamination with α -ketoglutarate, forming glutamate and a new α -keto acid, which can be utilized for glucose synthesis. Glutamate provides both nitrogenous compounds required for urea synthesis: ammonia from oxidative deamination by glutamate dehydrogenase, and aspartate from transamination of oxaloacetate by aspartate aminotransferase. An additional important source of ammonia and precursors of ornithine such as citrulline is the gut mucosa (described in more detail in Section 13.4).

Adipose tissue is also very important in the fasting state. Because of low blood insulin levels during fasting, **lipolysis** is greatly activated in this tissue. This raises the blood level of fatty acids, which are used in preference to glucose by many tissues. In heart and muscle, the oxidation of fatty acids inhibits glycolysis and pyruvate oxidation. In liver, fatty acid oxidation provides most of the ATP needed for gluconeogenesis. Very little acetyl CoA generated by fatty acid oxidation in liver is oxidized completely. The acetyl CoA is converted instead into **ketone bodies** by liver mitochondria. Ketone bodies (acetoacetate and β -hydroxybutyrate) are released into the blood and are a source of energy for many tissues. Like fatty acids, ketone bodies are preferred by many tissues over glucose. Fatty acids are not oxidized by the brain because fatty acids cannot cross the blood–brain barrier. Ketone bodies can penetrate, however, and are oxidized. Once their blood concentration is high enough, ketone bodies function as an alternative fuel for the brain. They are unable, however, to completely replace the need for glucose by the brain. Ketone bodies may also suppress proteolysis and branched-chain amino acid oxidation in muscle and

decrease alanine release. This both decreases muscle wasting and reduces the amount of glucose synthesized in liver. As long as ketone body levels are maintained at a high level by hepatic fatty acid oxidation, there is less need for glucose, less need for gluconeogenic amino acids, and less need for breaking down precious muscle tissue.

CLINICAL CORRELATION 13.4

Reye's Syndrome

Reye's syndrome is a devastating but now rare illness of children that is characterized by evidence of brain dysfunction and edema (irritability, lethargy, and coma) and liver dysfunction (elevated plasma free fatty acids, fatty liver, hypoglycemia, hyperammonemia, and accumulation of short-chain organic acids). It appears that hepatic mitochondria are specifically damaged, which impairs fatty acid oxidation and synthesis of carbamoyl phosphate and ornithine (for ammonia detoxification) and oxaloacetate (for gluconeogenesis). On the other hand, the accumulation of organic acids has suggested that the oxidation of these compounds is defective and that the CoA esters of some of these acids may inhibit specific enzymes, such as carbamoyl phosphate synthetase I, pyruvate dehydrogenase, pyruvate carboxylase, and the adenine nucleotide transporter, all present in mitochondria. The issue has not yet been resolved. The use of aspirin by children with varicella was linked to the development of Reye's syndrome, and parents have been urged not to give aspirin to children with viral infections. The incidence of the syndrome subsequently decreased. The therapy for Reye's syndrome consists of measures to reduce brain edema and the provision of glucose intravenously. Glucose administration prevents hypoglycemia and elicits a rise in insulin levels that may (1) inhibit lipolysis in adipose cells and (2) reduce proteolysis in muscles and the release of amino acids, which (3) reduces the deamination of amino acids to ammonia.

Reye, R. D. K., Morgan, G., and Baval, J. Encephalopathy and fatty degeneration of the viscera, a disease entity in childhood. *Lancet* 2:749, 1963; and Treem, W. R. Inherited and acquired syndromes of hyperammonemia and encephalopathy in children. *Semin. Liver Dis.* 14:236, 1994.

The interrelationships among liver, muscle, and adipose tissue in supplying glucose for the brain are shown in Figure 13.4. Liver synthesizes the glucose, muscle and gut supply the substrate (alanine), and adipose tissue supplies the ATP (via fatty acid oxidation in the liver) needed for hepatic gluconeogenesis. These relationships are disrupted in Reye's syndrome (see Clin. Corr. 13.4) and by alcohol (see Clin. Corr. 7.10). This tissue cooperation is dependent on the appropriate blood hormone levels. Glucose levels are lower in fasting, reducing the secretion of insulin but favoring release of **glucagon** from the pancreas and **epinephrine** from the adrenal medulla. In addition, fasting reduces formation of **triiodothyronine**, the active form of thyroid hormone, from **thyroxine**. This reduces the daily basal energy requirements by as much as 25%. This response is useful for survival but makes weight loss more difficult than weight gain (see Clin. Corr. 13.1).

In the Early Refed State, Fat Is Metabolized Normally, but Normal Glucose Metabolism Is Slowly Reestablished

Figure 13.6 shows what happens soon after fuel is absorbed from the gut. Fat is metabolized as described above for the well-fed state. In contrast, glucose

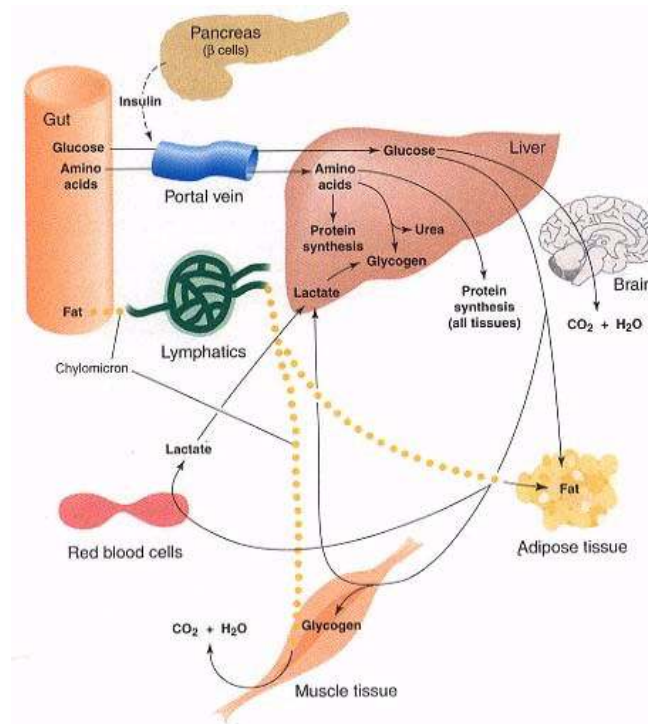
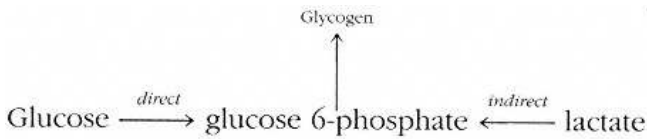

Figure 13.6
Metabolic interrelationships of major tissues in the early refed state.

is poorly extracted by the liver during this period of the starve–feed cycle. In fact, the liver remains in the gluconeogenic mode for a few hours after feeding. Rather than providing blood glucose, however, hepatic gluconeogenesis provides glucose 6-phosphate for glycogenesis. This means that liver glycogen is not replenished after a fast by direct synthesis from blood glucose. Rather, glucose is catabolized in peripheral tissues to lactate, which is converted in the liver to glycogen by the indirect pathway of glycogen synthesis (i.e., gluconeogenesis):



Gluconeogenesis from specific amino acids entering from the gut also plays an important role in reestablishing normal liver glycogen levels by the indirect pathway. After the rate of gluconeogenesis declines, glycolysis becomes the predominant means of glucose disposal in the liver, and liver glycogen is sustained by the direct pathway of synthesis from blood glucose.

Other Important Interorgan Metabolic Interactions

An important pathway exists in the intestinal epithelium for the conversion of glutamine to **citrulline** (Figure 13.7). One of the enzymes (ATP-dependent glutamate reductase) necessary for this conversion is expressed only in enterocytes. Citrulline produced in the gut is metabolized by the kidney to arginine, which can be converted to creatine or released into the blood. The liver uses blood arginine to generate ornithine, which expands the capacity of the urea cycle during periods of increased protein intake. Although perhaps not immedi-

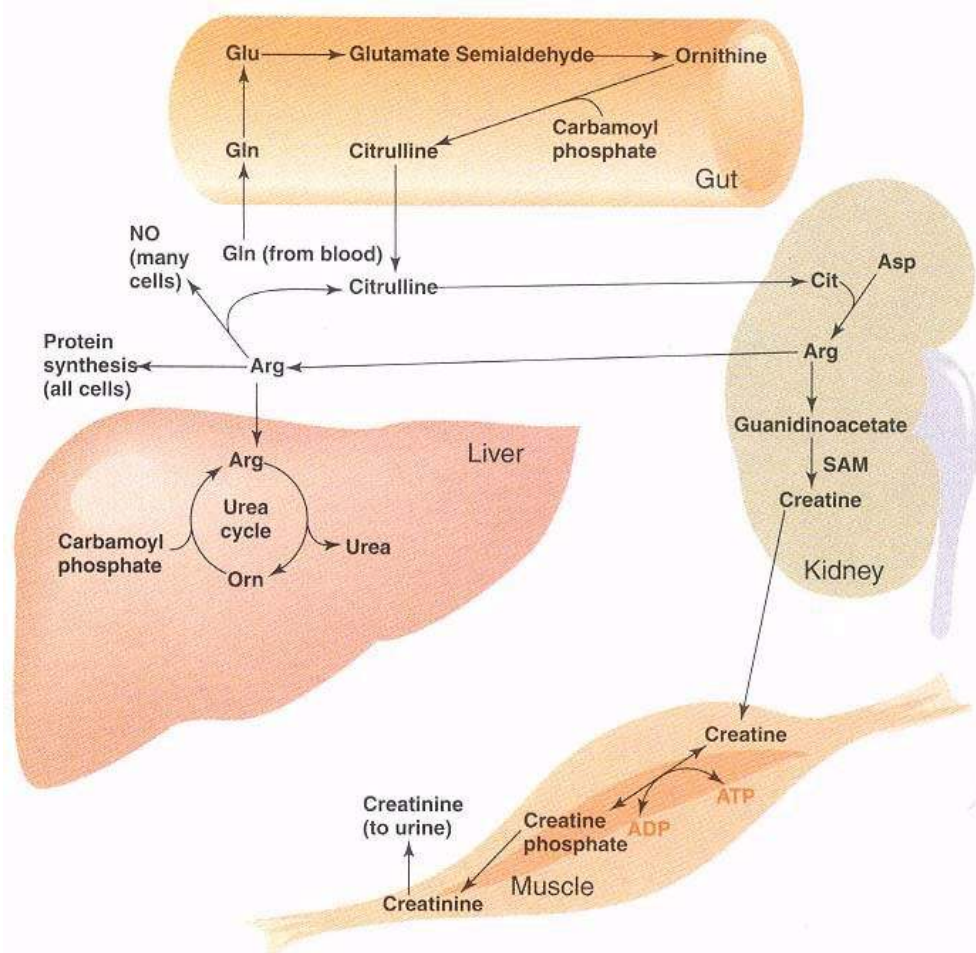
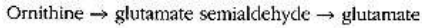

Figure 13.7

Gut and kidney function together in synthesis of arginine from glutamine.

Abbreviations: Cit, citrulline; Arg, arginine; Asp, aspartate; Gln, glutamine; Glu, glutamate; NO, nitric oxide; Orn, ornithine; SAM, S-adenosylmethionine.

ately obvious, this pathway is of great importance for urea cycle activity in the liver. The liver contains an enzyme system that irreversibly converts ornithine into glutamate:



Depletion of ornithine by these reactions inhibits urea synthesis in the liver for want of ornithine, the intermediate of the urea cycle that must recycle. Replenishment of ornithine is necessary and completely dependent on a source of blood arginine. Thus urea synthesis in the liver is dependent on citrulline synthesis by the gut and arginine synthesis by the kidney. Arginine is also used by many cells for the production of **nitric oxide (NO)** (Figure 13.7), an activator of guanylate cyclase that produces cGMP, an important second messenger (see p. 995).

Citrulline participates in another interesting interorgan shuttle. The arginine generated from citrulline in the kidney can be metabolized further to **creatine** (Figure 13.7). The first enzyme in this pathway is glycine transaminidase (GTA), which generates guanidinoacetate from arginine and glycine (see p. 483). GTA is found predominantly in renal cortex, pancreas, and liver. After methylation in a reaction that requires **S-adenosylmethionine (SAM)**, creatine is formed. This is quantitatively the most important use of **SAM** in the body. One to two grams of creatine are synthesized per day. Creatine then circulates to other tissues, especially muscle, where it serves as a high-energy reservoir when phosphorylated to creatine phosphate. Creatine phosphate undergoes nonenzymatic conversion to **creatinine**. Creatinine is released to the bloodstream and removed from the body by renal filtration. Excretion of creatinine is thus used both as a measure of muscle mass and of renal function.

Two other compounds related to amino acids participate in interorgan shuttles. **Glutathione (GSH)** is a tripeptide that is important in detoxification of endogenously generated peroxides and exogenous chemical compounds (see p. 484). Liver plays a major role in the synthesis of GSH from glutamate, cysteine, and glycine (Figure 13.8). Synthesis is limited by the availability of cysteine. Cystine present in plasma is not taken up well by liver, which utilizes dietary methionine to form cysteine via the cystathionine pathway (see p. 469). Hepatic GSH is released both to the bloodstream and to the bile. Kidney removes a substantial amount of plasma GSH. Enterocytes may be able to take up biliary-excreted GSH from the intestinal lumen. Release to plasma is the same in fed

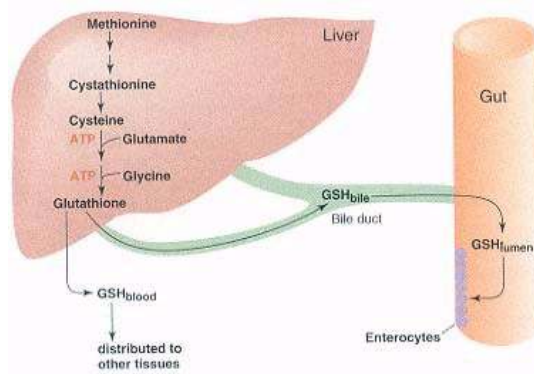

Figure 13.8
Liver provides glutathione for other tissues.

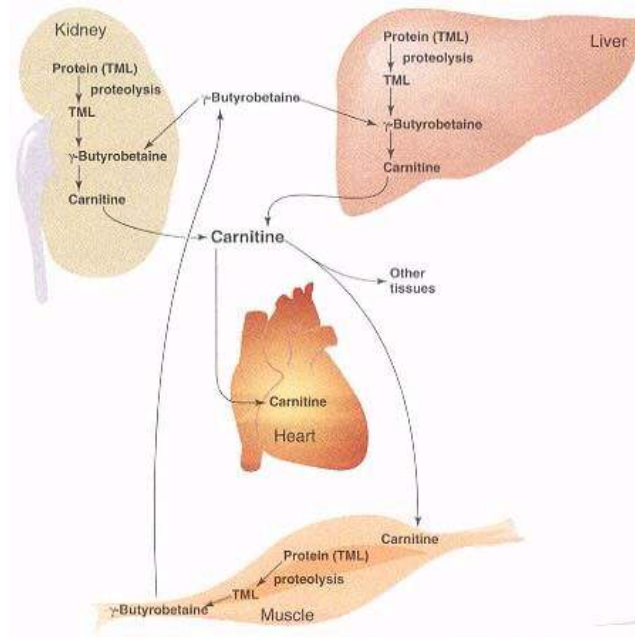

Figure 13.9

Kidney and liver provide carnitine for other tissues.

Abbreviations: Protein (TML), trimethyllysyl residues in protein molecules; TML, free trimethyllysine.

and fasting states, providing a stable source of this compound and its constituent amino acids, especially cysteine, for most tissues of the body.

Carnitine is derived from lysyl residues on various proteins, which are *N*-methylated utilizing SAM to form trimethyllysyl residues (Figure 13.9). Free **trimethyllysine** is released when the proteins are degraded. It is hydroxylated and then cleaved, releasing glycine and γ -butyrobetaine aldehyde. The latter is oxidized to γ -butyrobetaine and then hydroxylated to form carnitine. Both hydroxylation steps require **vitamin C** as a cofactor. Kidney and to a lesser extent liver are the only tissues that can carry out the complete pathway, and thus they supply other tissues, especially muscle and heart, with the carnitine needed for fatty acid oxidation. Skeletal muscle can form γ -butyrobetaine but must release it for its final conversion to carnitine by liver or kidney.

Energy Requirements, Reserves, and Caloric Homeostasis

The average person leading a sedentary life consumes 200–300 g of carbohydrate, 70–100 g of protein, and 60–90 g of fat daily. This meets a daily energy requirement of 1600–2400 kcal. As shown in Table 13.1, the **energy reserves** of an average-sized person are considerable. These reserves are called upon between meals and overnight to maintain blood glucose. Although the ability to mobilize glycogen rapidly is indeed very important, our glycogen reserves are minuscule with respect to our fat reserves (Table 13.1). Fat stores are only called upon during more prolonged fasting. The fat stores of obese subjects can weigh as much as 80 kg, adding another 585,000 kcal to their energy reserves. Protein is listed in Table 13.1 as an energy reserve because it can be used to provide amino acids for oxidation. On the other hand, protein is not inert like stored fat and glycogen. Proteins make up the muscles that allow us

TABLE 13.1 The Energy Reserves of Humans^a

Stored Fuel	Tissue	Fuel Reserves	
		(g)	(kcal)
Glycogen	Liver	70	280
Glycogen	Muscle	120	480
Glucose	Body fluids	20	80
Fat	Adipose	15,000	135,000
Protein	Muscle	6,000	24,000

^a Data are for a normal subject weighing 70 kg. Carbohydrate supplies 4 kcal g⁻¹; fat, 9 kcal g⁻¹; protein, 4 kcal g⁻¹.

to move and breathe and the enzymes that carry out metabolism. Hence it is not as dispensable as fat and glycogen and is given up by the body more reluctantly.

The constant availability of fuels in the blood is termed **caloric homeostasis**, which, as illustrated in Table 13.2, means that regardless of whether a person is well-fed, fasting, or starving to death, the blood level of fuels that supply a comparable amount of ATP when metabolized does not fall below certain limits. Note that blood glucose concentrations are controlled within very tight limits, whereas fatty acid and ketone body concentrations in the blood can vary by one or two orders of magnitude, respectively. Glucose is carefully regulated because of the absolute need of the brain for this substrate. If the blood glucose level falls too low (<2.0 mM), coma and death will follow shortly unless the glucose concentration is restored. On the other hand, **hyperglycemia** must be avoided because glucose will be lost in the urine, resulting in dehydration and sometimes hyperglycemic, hyperosmolar coma (see Clin. Corr. 13.5). Chronic hyperglycemia results in glycation of a number of proteins, which contributes to the complications of **diabetes** (see Clin. Corr. 13.6). The changes

CLINICAL CORRELATION 13.5

Hyperglycemic, Hyperosmolar Coma

Type II diabetic patients sometimes develop a condition called hyperglycemic, hyperosmolar coma. This is particularly common in the elderly and can even occur in individuals under severe metabolic stress who were not recognized as having diabetes beforehand. Hyperglycemia, perhaps worsened by failure to take insulin or hypoglycemic drugs, an infection, or a coincidental medical problem such as a heart attack, leads to urinary losses of water, glucose, and electrolytes (sodium, chloride, and potassium). This osmotic diuresis reduces the circulating blood volume, a stress that results in the release of hormones that worsen insulin resistance and hyperglycemia. In addition, elderly patients may be less able to sense thirst or to obtain fluids. Over the course of several days these patients can become extremely hyperglycemic (glucose >1000 mg dL⁻¹), dehydrated, and comatose. Ketoacidosis does not develop in these patients, possibly because free fatty acids are not always elevated or because adequate insulin concentrations exist in the portal blood to inhibit ketogenesis (although it is not high enough to inhibit gluconeogenesis). Therapy is aimed at restoring water and electrolyte balance and correcting the hyperglycemia with insulin. The mortality of this syndrome is considerably higher than that of diabetic ketoacidosis.

Arief, A. I., and Carroll, H. J. Nonketotic hyperosmolar coma with hyperglycemia. Clinical features, pathophysiology, renal function, acid-base balance, plasma-cerebrospinal fluid equilibria, and the effects of therapy in 37 cases. *Medicine* 51:73, 1972; and Cruz-Caudillo, J. C., and Sabatini, S. Diabetic hyperosmolar syndrome. *Nephron* 69:201, 1995.

TABLE 13.2 Substrate and Hormone Levels in Blood of Well-Fed, Fasting, and Starving Human^a

Hormone or Substrate (units)	Very Well Fed	Postabsorptive 12 h	Fasted 3 days	Starved 5 weeks
Insulin ($\mu\text{U mL}^{-1}$)	40	15	8	6
Glucagon (pg mL^{-1})	80	100	150	120
Insulin/glucagon ratio ($\mu\text{U pg}^{-1}$)	0.50	0.15	0.05	0.05
Glucose (mM)	6.1	4.8	3.8	3.6
Fatty acids (mM)	0.14	0.6	1.2	1.4
Acetoacetate (mM)	0.04	0.05	0.4	1.3
β -Hydroxybutyrate (mM)	0.03	0.10	1.4	6.0
Lactate (mM)	2.5	0.7	0.7	0.6
Pyruvate (mM)	0.25	0.06	0.04	0.03
Alanine (mM)	0.8	0.3	0.3	0.1
ATP equivalent (mM)	313	290	380	537

Source: From Ruderman, N. B., Aoki, T. T., and Cahill, G. F. Jr. Gluconeogenesis and its disorders in man. In: R. W. Hanson and M. A. Mehlerman (Eds.), *Gluconeogenesis, Its Regulation in Mammalian Species*. New York: Wiley, 1976, p. 515.

^aData are for normal-weight subjects except for the 5-week starvation values, which are from obese subjects undergoing therapeutic starvation. ATP equivalents were calculated on the basis of the ATP yield expected on complete oxidation of each substrate to CO₂ and H₂O: 38 molecules of ATP for each molecule of glucose; 144 for the average fatty acid (oleate), 23 for acetoacetate; 26 for β -hydroxybutyrate; 18 for lactate, 15 for pyruvate, and 13 (corrected for urea formation) for alanine.

CLINICAL CORRELATION 13.6**Hyperglycemia and Protein Glycation**

Glycation of enzymes is known to cause changes in their activity, solubility, and susceptibility to degradation. In the case of hemoglobin A, glycation occurs by a nonenzymatic reaction between glucose and the amino-terminal valine of the β chain. A Schiff base forms between glucose and valine, followed by a rearrangement of the molecule to give a 1-deoxyfructose molecule attached to the valine. The reaction is favored by high glucose levels and the resulting protein, called hemoglobin A_{1c}, is a good index of how high a person's average blood glucose concentration has been over the previous several weeks. The concentration of this modified protein increases in an uncontrolled diabetic and is low in patients who control their glucose level closely.

It has been proposed that glycation of proteins may contribute to the medical complications caused by diabetes, for example, coronary heart disease, retinopathy, nephropathy, cataracts, and neuropathy. Increased glycation of lens proteins may contribute to the development of diabetic cataracts. Collagen, laminin, vitronectin, and other matrix proteins can become glycated and undergo alterations in biological properties, such as self-assembly and binding of other matrix molecules. Glycated proteins and lipoproteins can also be recognized by receptors present on macrophages, which are intimately involved in the formation of atherosclerotic plaques. It is likely that these phenomena favor the accelerated atherosclerosis that occurs in diabetics. The compound aminoguanidine inhibits the formation of the glycation products and is being tested for its ability to prevent diabetic complications.

Brownlee, M. Glycation products and the pathogenesis of diabetic complications. *Diabetes Care* 15: 1835, 1992; Vlassara, H. Receptor-mediated interactions with advanced glycosylation end products with cellular components within diabetic tissues. *Diabetes* 41(Suppl 2):52, 1992; and Lyons, T. J. Glycation and oxidation: a role in the pathogenesis of atherosclerosis. *Am. J. Cardiol.* 71:26B, 1993.

in insulin/glucagon ratio shown in Table 13.2 are crucial to the maintenance of caloric homeostasis. Simply stated, well-fed individuals have high insulin/glucagon ratios that favor storage of glycogen and fat, while starving individuals have low insulin/glucagon ratios that stimulate lipolysis, proteolysis, and gluconeogenesis.

Glucose Homeostasis Has Five Phases

Figure 13.10 shows the work of Cahill and his colleagues with obese patients undergoing long-term starvation for weight loss. It illustrates the effects of starvation on those processes that are used to maintain **glucose homeostasis**. For convenience, the time period involved has been divided into five phases. Phase I is the well-fed state in which glucose is provided by dietary carbohydrate. Once this supply is exhausted, hepatic glycogenolysis maintains blood glucose levels during phase II. As this supply of glucose starts to dwindle, hepatic gluconeogenesis from lactate, glycerol, and alanine becomes increasingly important until, in phase III, it is the major source of blood glucose. These changes occur within 20 or so hours of fasting, depending on how well fed the individual was prior to the fast, how much hepatic glycogen was present, and the sort of physical activity occurring during the fast. Several days of fasting move one into phase IV, where the dependence on gluconeogenesis actually decreases. As discussed above, ketone bodies have accumulated to high enough concentrations for them to enter the brain and meet some of its energy needs. Renal gluconeogenesis also becomes significant in this phase. Phase V occurs after very prolonged starvation of extremely obese individuals and is characterized by even less dependence on gluconeogenesis. The energy needs of almost every tissue are met to a large extent by either fatty acid or ketone body oxidation in this phase.

As long as ketone body concentrations are high, proteolysis will be somewhat restricted, and conservation of muscle proteins and enzymes will occur. This continues until practically all of the fat is gone as a consequence of starvation. After all of it is gone, the body has to use muscle protein. Before it is gone—you are gone (see Clin. Corr. 13.3).

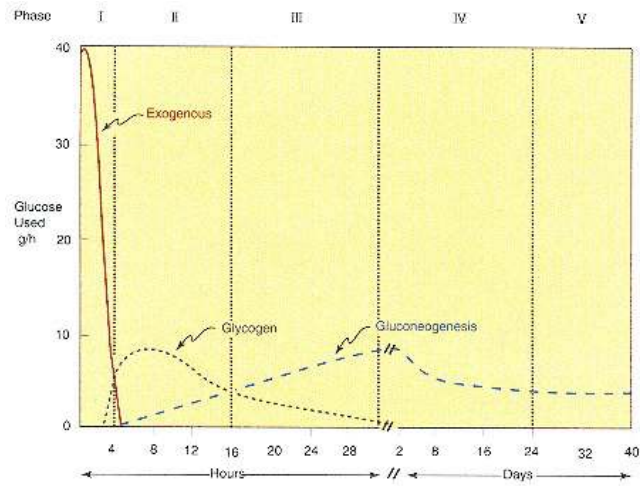

Phase	ORIGIN OF BLOOD GLUCOSE	TISSUES USING GLUCOSE	MAJOR FUEL OF BRAIN
I	Exogenous	All	Glucose
II	Glycogen Hepatic gluconeogenesis	All except liver. Muscle and adipose tissue at diminished rates	Glucose
III	Hepatic gluconeogenesis Glycogen	All except liver. Muscle and adipose tissue at rates intermediate between II and IV	Glucose
IV	Gluconeogenesis, hepatic and renal	Brain, RBCs, renal medulla. Small amount by muscle	Glucose, ketone bodies
V	Gluconeogenesis, hepatic and renal	Brain at a diminished rate, RBCs, renal medulla	Ketone bodies, glucose

Figure 13.10

The five phases of glucose homeostasis in humans.

Reprinted with permission from Ruderman, N. B., Aoki, T. T., and Cahill, G. F. Jr. Gluconeogenesis and its disorders in man. In: R. W. Hanson and M. A. Mehlman (Eds.), *Gluconeogenesis, Its Regulation in Mammalian Species*. New York: Wiley, 1976, p. 515.

13.3—

Mechanisms Involved in Switching the Metabolism of Liver between the Well-Fed State and the Starved State

The liver of a well-fed person is actively engaged in processes that favor the synthesis of glycogen and fat; such a liver is glycogenic, glycolytic, and lipogenic. The liver of the fasting person is quite a different organ; it is glycogenolytic, gluconeogenic, ketogenic, and proteolytic. The strategy is to store calories when food is available, but then to mobilize these stores when the rest of the body

is in need. The liver is switched between these metabolic extremes by a variety of regulatory mechanisms: substrate supply, allosteric effectors, covalent modification, and induction–repression of enzymes.

Substrate Availability Controls Many Metabolic Pathways

Because of other, more sophisticated levels of control, the importance of **substrate supply** is often ignored. However, the concentration of fatty acids in blood entering the liver is clearly a major determinant of the rate of ketogenesis. Excess fat is not synthesized unless one consumes excessive amounts of substrates that can be used for lipogenesis. Glucose synthesis by the liver is also restricted by the rate at which gluconeogenic substrates flow to the liver. Delivery of excess amino acids to the liver of the diabetic, because of accelerated and uncontrolled proteolysis, increases the rate of gluconeogenesis and exacerbates the hyperglycemia characteristic of diabetes. In addition, high glucose levels increase the rate of synthesis of sorbitol, which may contribute to diabetic complications. On the other hand, failure to supply the liver adequately with glucogenic substrate (mainly alanine) explains some types of hypoglycemia, such as that observed during pregnancy or advanced starvation.

Another pathway regulated by substrate supply is **urea synthesis**. Amino acid metabolism in the intestine provides a substantial fraction of the ammonia used by the liver for urea production. As discussed above, the intestine also releases citrulline, metabolic precursor of ornithine. A larger ornithine pool permits increased urea synthesis after a high protein meal.

We can conclude that substrate supply is a major determinant of the rate at which virtually every metabolic process of the body operates. However, variations in substrate supply are not sufficient to account for the marked changes in metabolism that must occur in the starve–feed cycle, and finer tuning of the pathways is required.

Negative and Positive Allosteric Effectors Regulate Key Enzymes

Figures 13.11 and 13.12 summarize the effects of negative and positive **allosteric effectors** important in the well-fed and starved states, respectively. As shown in Figure 13.11, glucose inactivates glycogen phosphorylase and activates glycogen synthase (indirectly; see Chapter 7, p. 326), thereby preventing degradation and promoting synthesis of glycogen; fructose 2,6-bisphosphate stimulates 6-phosphofructo-1-kinase and inhibits fructose 1,6-bisphosphatase, thereby stimulating glycolysis and inhibiting gluconeogenesis; fructose 1,6-bisphosphate activates pyruvate kinase, thereby stimulating glycolysis; pyruvate activates pyruvate dehydrogenase (indirectly by inhibition of pyruvate dehydrogenase kinase; see Chapter 6, p. 228); citrate activates acetyl-CoA carboxylase, thereby stimulating fatty acid synthesis; and malonyl CoA inhibits carnitine palmitoyl-transferase I, thereby inhibiting fatty acid oxidation.

As shown in Figure 13.12, acetyl CoA stimulates gluconeogenesis in the fasted state by activating pyruvate carboxylase and inhibiting pyruvate dehydrogenase (a direct allosteric effect and also by stimulation of pyruvate dehydrogenase kinase; see Chapter 7, p. 308); long-chain acyl CoA esters inhibit acetyl-CoA carboxylase, which lowers the level of malonyl CoA and permits greater carnitine palmitoyltransferase I activity and fatty acid oxidation rates; fructose 6-phosphate acts through a regulatory protein to inhibit glucokinase; citrate, which can be increased because of fatty acid oxidation, inhibits 6-phosphofructo-1-kinase as well as 6-phosphofructo-2-kinase (not shown); and NADH produced by fatty acid oxidation inhibits TCA cycle activity.

Although not shown in Figure 13.12, **cAMP** is an important allosteric effector. Its concentration in liver is increased in the starved state. Cyclic AMP is a positive effector of cAMP-dependent protein kinase (also called **protein**

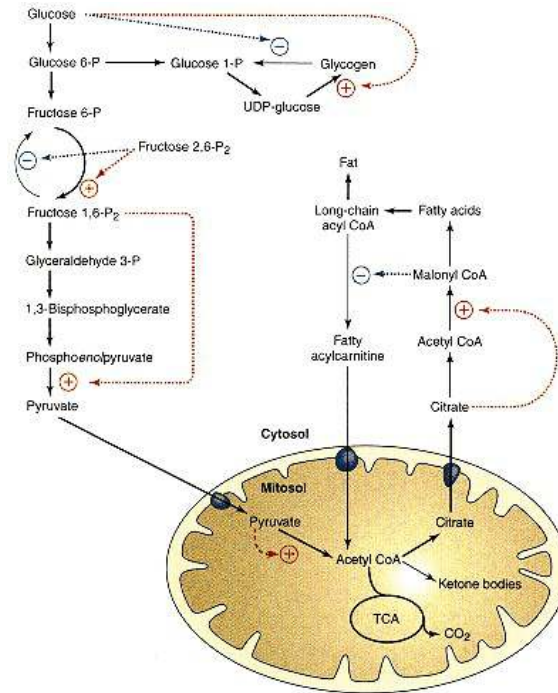
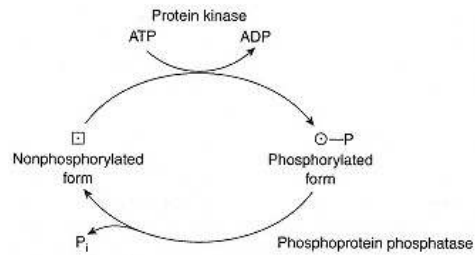

Figure 13.11
Control of hepatic metabolism in the well-fed state by allosteric effectors.

kinase A), which, in turn, is responsible for changing the kinetic properties of several regulatory enzymes by covalent modification, as summarized next.

Covalent Modification Regulates Key Enzymes

Figures 13.13 and 13.14 point out the interconvertible enzymes that play important roles in switching the liver between the well-fed and starved states. The regulation of enzymes by **covalent modification** has been discussed in Chapter 7. Recall that O-P represent interconvertible forms of an enzyme in the nonphosphorylated and phosphorylated states, respectively.



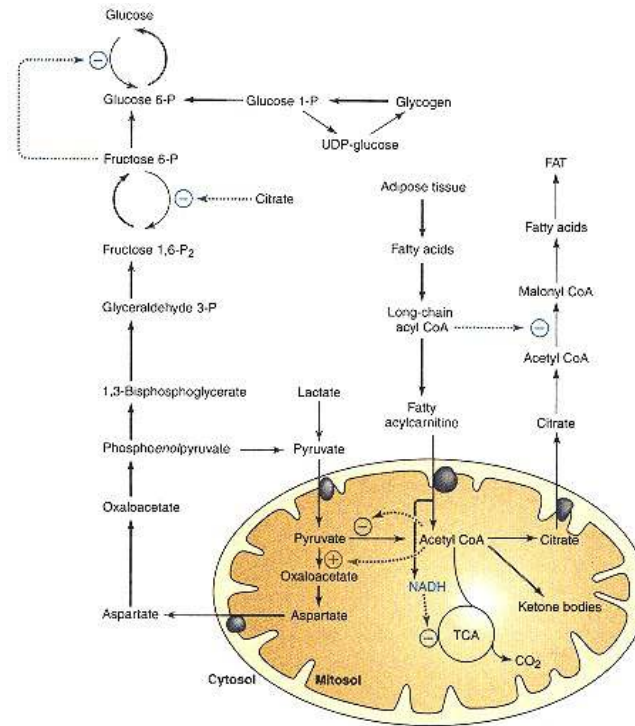

Figure 13.12
Control of hepatic metabolism in the fasting state by allosteric effectors.

The important points are as follows: (1) enzymes subject to covalent modification undergo phosphorylation on one or more serine residues by a protein kinase; (2) the phosphorylated enzyme can be returned to the dephosphorylated state by phosphoprotein phosphatase; (3) phosphorylation of the enzyme changes its conformation and its catalytic activity; (4) some enzymes are active only in the dephosphorylated state, others only in the phosphorylated state; (5) cAMP is the messenger that signals the phosphorylation of many, but not all, of the enzymes subject to covalent modification; (6) cAMP acts by activating protein kinase A; (7) cAMP also indirectly promotes phosphorylation of interconvertible enzymes by signaling inactivation of phosphoprotein phosphatase; (8) glucagon and β -adrenergic agonists (epinephrine) increase cAMP levels by activating adenylate cyclase; (9) insulin (see Chapter 20, p. 879) opposes the action of glucagon and epinephrine, in part by lowering cAMP and in part by mechanisms independent of cAMP; and (10) the action of insulin in general promotes dephosphorylation of interconvertible enzymes.

Hepatic enzymes subject to covalent modification are dephosphorylated in well-fed animals (Figure 13.13). Although not shown, phosphorylase kinase is also dephosphorylated in this state. Insulin/glucagon ratios are high in blood, and cAMP levels are low in liver. This results in low activity of protein kinase A and high activity of **phosphoprotein phosphatase**. Glycogen synthase, glycogen phosphorylase (via phosphorylase kinase), 6-phosphofructo-2-kinase/fructose 2,6-bisphosphatase (bifunctional enzyme), pyruvate kinase, and

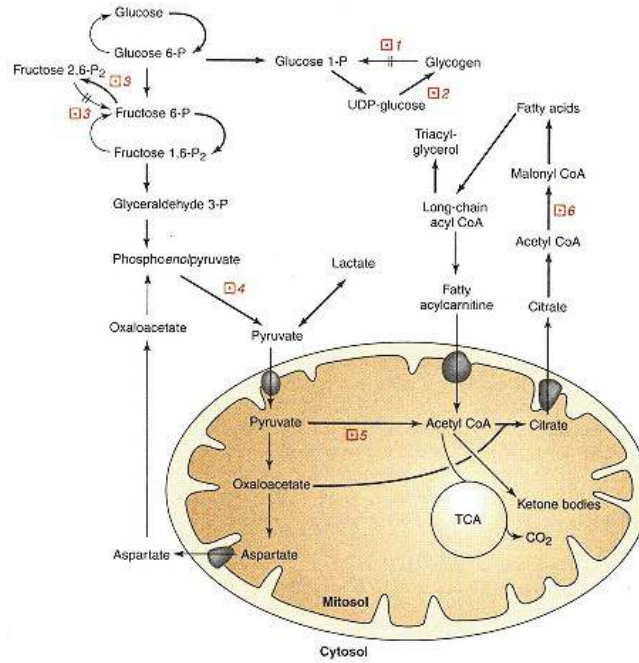

Figure 13.13
Activity and state of phosphorylation of enzymes subject to covalent modification in the lipogenic liver.

The dephosphorylated mode is indicated by the symbol □. Interconvertible enzymes are numbered as follows:
 1, glycogen phosphorylase;
 2, glycogen synthase;
 3, 6-phosphofructo-2-kinase/fructose 2,6-bisphosphatase (bifunctional enzyme);
 4, pyruvate kinase;
 5, pyruvate dehydrogenase; and
 6, acetyl-CoA carboxylase.

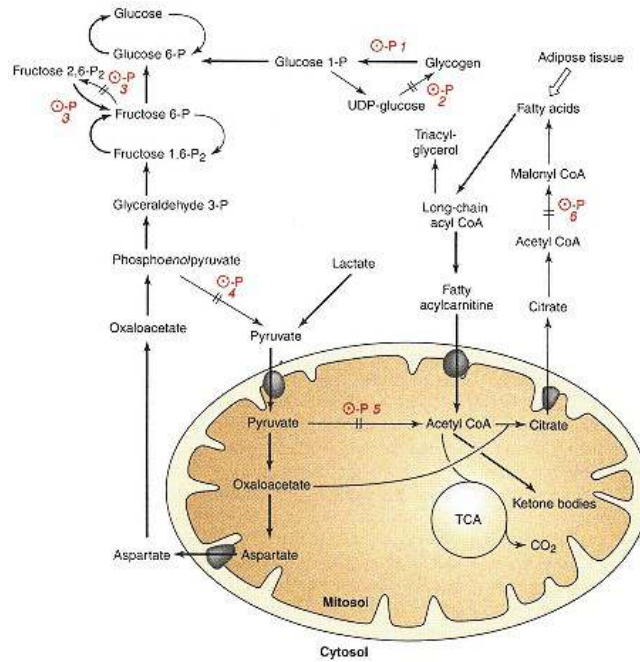

Figure 13.14
Activity and state of phosphorylation of enzymes subject to covalent modification in the gluconeogenic liver.

Phosphorylated mode is indicated by the symbol ⊖-P. Numbers refer to the same enzymes as in Figure 13.13.

acetyl-CoA carboxylase are phosphorylated by protein kinase A. However, not all interconvertible enzymes are subject to phosphorylation by protein kinase A. No link to protein kinase A for the pyruvate dehydrogenase complex has been established. Only three of the interconvertible enzymes—**glycogen phosphorylase**, phosphorylase kinase, and the **fructose 2,6-bisphosphatase** of the bifunctional enzyme—are inactive when dephosphorylated. All of the other identified interconvertible enzymes are active. Glycogenesis, glycolysis, and lipogenesis are greatly favored when these enzymes are dephosphorylated. On the other hand, the opposing pathways—glycogenolysis, gluconeogenesis, and ketogenesis—are inhibited.

As shown in Figure 13.14 (p. 543), the hepatic enzymes subject to covalent modification are in the phosphorylated mode in the liver of the fasting animal. Insulin is low but glucagon is high in the blood, resulting in an increase in hepatic cAMP levels. This activates protein kinase A and inactivates phosphoprotein phosphatase. The net effect is a greater degree of phosphorylation of interconvertible enzymes than in the well-fed state. In the starved state, three interconvertible enzymes—glycogen phosphorylase, phosphorylase kinase, and the fructose 2,6-bisphosphatase of the bifunctional enzyme—are in the active catalytic state. All the other interconvertible enzymes are inactive in the phosphorylated mode. As a result, glycogenesis, glycolysis, and lipogenesis are shut down almost completely, and glycogenolysis, gluconeogenesis, and ketogenesis predominate.

Two additional hepatic enzymes, **phenylalanine hydroxylase** and **branched-chain α -keto acid dehydrogenase**, are also controlled by phosphorylation/dephosphorylation. These enzymes catalyze rate-limiting steps in the disposal of phenylalanine and the branched-chain amino acids (leucine, isoleucine, and valine), respectively. These enzymes are not included in Figures 13.13 and 13.14 because of special features of their control by covalent modification. Phenylalanine hydroxylase, a cytosolic enzyme, is active in the phosphorylated state, and phosphorylation is stimulated by glucagon via protein kinase A. Branched-chain α -keto acid dehydrogenase, a mitochondrial enzyme, is active in the dephosphorylated state, and its activity is regulated by branched-chain α -keto acid dehydrogenase kinase and a phosphoprotein phosphatase. Phenylalanine acts as a positive allosteric effector for the phosphorylation and activation of phenylalanine hydroxylase by cAMP-dependent protein kinase. Branched-chain α -keto acids activate branched-chain α -keto acid dehydrogenase indirectly by inhibiting branched-chain α -keto acid dehydrogenase kinase. Covalent modification of these enzymes provides a very sensitive means for control of the degradation of phenylalanine and the branched-chain amino acids. The clinical experience with phenylketonuria (see Clin. Corr. 11.5) and maple syrup urine disease (see Clin. Corr. 11.10) emphasizes the importance of regulating blood and tissue levels of these amino acids. Of note, the artificial sweetener **aspartame** (NutraSweet®) is *N*-aspartylphenylalanine methyl ester. The amount in a liter of sweetened drinks may approach the amount of phenylalanine normally obtained from the daily diet. This is of no harm to normal individuals but is a threat to **phenylketonuria** patients on a low phenylalanine diet. Phenylalanine and the branched-chain amino acids cannot be synthesized in humans, making them essential amino acids that must be available continuously for protein synthesis. Thus the activities of phenylalanine hydroxylase and branched-chain α -keto acid dehydrogenase must be carefully controlled to prevent depletion of body stores. Therefore the tissue requirement for these amino acids supersedes the phase of the starve–feed cycle in establishing the phosphorylation and activity state of these interconvertible enzymes.

Adipose tissue responds almost as dramatically as liver to the starve–feed cycle because it also contains enzymes subject to covalent modification. Pyruvate kinase, pyruvate dehydrogenase, acetyl-CoA carboxylase, and hormone-

sensitive lipase (not found in liver) are all in the dephosphorylated mode in the adipose tissue of the well-fed person. As in liver, the first three enzymes are active when dephosphorylated. **Hormone-sensitive lipase** is inactive when dephosphorylated. A high insulin level in the blood and a low cAMP concentration in adipose tissue are important determinants of the phosphorylation state of these enzymes, which favors lipogenesis in the well-fed state. During fasting, as a consequence of the decrease in the insulin level and an increase in epinephrine, adipocytes quickly shut down lipogenesis and activate lipolysis. This is accomplished in large part by the phosphorylation of the enzymes described above. In this manner, adipose tissue is transformed from a fat storage tissue into a source of fatty acids for oxidation in other tissues and glycerol for gluconeogenesis in the liver.

Conservation of glucose as well as three-carbon compounds that can readily be converted to glucose (lactate, alanine, and pyruvate) by the liver is crucial for survival in the starved state. Certain cells, particularly those of the central nervous system, are absolutely dependent on a continuous supply of glucose. Tissues that can use alternative fuels invariably shut down their use of glucose and three-carbon precursors. This is referred to as the glucose–fatty acid cycle in recognition that increased availability of fatty acids for oxidation spares glucose in the starved state. Inactivation of the pyruvate dehydrogenase complex by phosphorylation is an important feature of the **glucose–fatty acid cycle**. This occurs in skeletal muscle, heart, and kidney, but not in the central nervous system, when the alternative fuels (fatty acids and ketone bodies) of the starved state become abundant. Activation of pyruvate dehydrogenase kinase by products of the catabolism of the alternative fuels (acetyl CoA and NADH) is responsible for the greater degree of phosphorylation and therefore lower activity of the pyruvate dehydrogenase complex.

Covalent modification, like allosteric effectors and substrate supply, is a short-term regulatory mechanism, operating on a minute-to-minute basis. On a longer time scale, enzyme activities are controlled at the level of expression.

Changes in Levels of Key Enzymes Are a Longer Term Adaptive Mechanism

The adaptive change in enzyme levels is a mechanism of regulation involving changes in the rate of synthesis or degradation of key enzymes. Whereas allosteric effectors and covalent modification affect either the K_m or V_{max} of an enzyme, this mode of regulation involves the actual quantity of an enzyme in a tissue. Because of the influence of hormonal and nutritional factors, there are more or fewer enzyme molecules present in the tissue. For example, when a person is maintained in a well-fed or overfed condition, the liver improves its capacity to synthesize fat. This can be explained in part by increased substrate supply, appropriate changes in allosteric effectors (Figure 13.11), and the conversion of the interconvertible enzymes into the dephosphorylated form (Figure 13.13). This is not the entire story, however, because the liver also has more of those enzyme molecules that play a key role in fat synthesis (see Figure 13.15). A whole battery of enzymes is induced, including glucokinase, 6-phospho-1-fructokinase, and pyruvate kinase for faster rates of glycolysis; glucose-6-phosphate dehydrogenase, 6-phosphogluconate dehydrogenase, and malic enzyme to provide greater quantities of NADPH for reductive synthesis; and citrate cleavage enzyme, acetyl-CoA carboxylase, fatty acid synthase, and Δ^9 -desaturase for more rapid rates of fatty acid synthesis. All of these enzymes are present at higher levels in the well-fed state because of an increase in the blood of the insulin/glucagon ratio and glucose. While these enzymes are induced, there is a decrease in the enzymes that favor glucose synthesis. **Phosphoenolpyruvate carboxykinase**, fructose 1,6-bisphosphatase, **glucose 6-phosphatase**, and

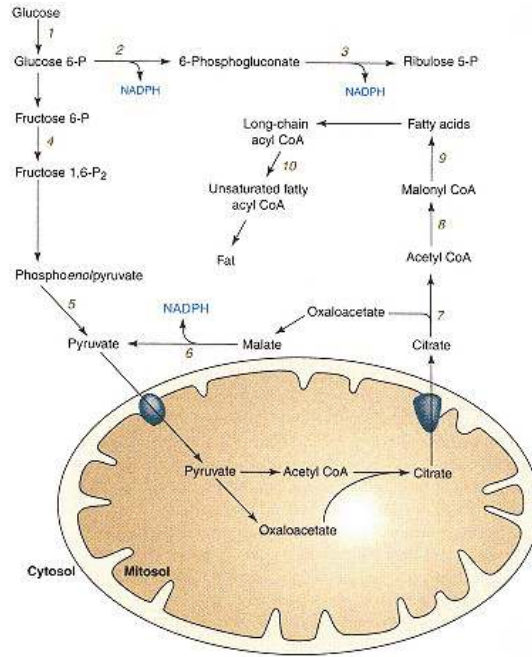

Figure 13.15
Enzymes induced in the liver of the well-fed individual.

Inducible enzymes are numbered as follows:

- 1, glucokinase;
- 2, glucose-6-phosphate dehydrogenase;
- 3, 6-phosphogluconate dehydrogenase;
- 4, 6-phosphofructo-1-kinase;
- 5, pyruvate kinase,
- 6, malic enzyme;
- 7, citrate cleavage enzyme;
- 8, acetyl-CoA carboxylase;
- 9, fatty acid synthase; and
- 10, Δ^9 -desaturase.

some aminotransferases are decreased in amount; that is, their synthesis is reduced or degradation increased in response to increased circulating glucose and insulin.

In fasting, the enzyme pattern of the liver changes dramatically (Figure 13.16). The enzymes involved in lipogenesis decrease in quantity, possibly because their synthesis is decreased or degradation of these proteins is increased. At the same time a number of enzymes (glucose 6-phosphatase, fructose 1,6-bisphosphatase, phosphoenolpyruvate carboxykinase, and various amino-transferases) favoring gluconeogenesis are induced, making the liver much more effective in synthesizing glucose. In addition, the enzymes of the urea cycle and other amino acid-metabolizing enzymes such as liver **glutaminase**, tyrosine aminotransferase, serine dehydratase, proline oxidase, and histidase are induced, possibly by the presence of higher blood glucagon levels. This permits the disposal of nitrogen, as urea, from the amino acids used in gluconeogenesis.

These adaptive changes are clearly important in the starve–feed cycle, greatly affecting the capacity of the liver for its various metabolic processes. The adaptive changes also influence the effectiveness of the short-term regulatory mechanisms. For example, long-term starvation or uncontrolled diabetes decreases the level of acetyl-CoA carboxylase. Taking away long-chain acyl CoA esters that inhibit this enzyme, increasing the level of citrate that activates this enzyme, or creating conditions that activate this interconvertible enzyme by dephosphorylation will not have any effect when the enzyme is virtually absent. Another example is afforded by the **glucose intolerance** of starvation. A chronically starved person cannot effectively utilize a load of glucose because of the absence of the key enzymes needed for glucose metabolism. A glucose

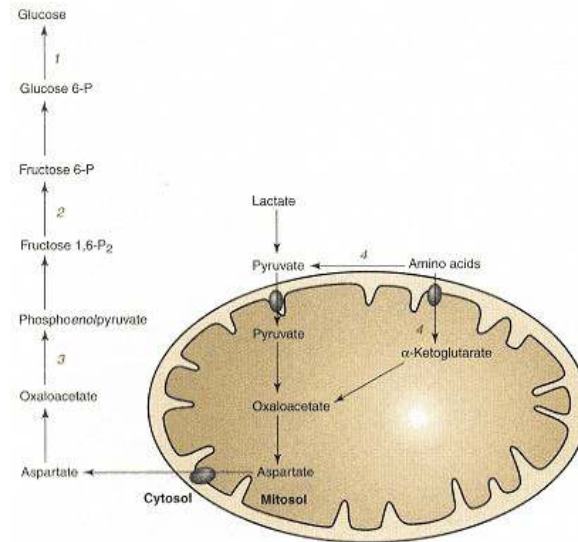

Figure 13.16
Enzymes induced in the liver of an individual during fasting.

Inducible enzymes are numbered as follows:
 1, glucose 6-phosphatase;
 2, fructose 1,6-bisphosphatase;
 3, phosphoenolpyruvate carboxykinase; and
 4, various aminotransferases.

load, however, will set into motion the induction of the required enzymes and the reestablishment of short-term regulatory mechanisms.

13.4—

Metabolic Interrelationships of Tissues in Various Nutritional and Hormonal States

Many changes that occur in various nutritional and hormonal states are variations on the starve–feed cycle and are completely predictable from what we have learned about the cycle. Some examples are given in Figure 13.17. Others are so obvious that a diagram is unnecessary; for example, in rapid growth of a child, amino acids are directed away from catabolism and into protein synthesis. However, the changes that occur in some physiologically important situations are rather subtle and poorly understood. An example of the latter is **aging**, which seems to lead to a decreased "sensitivity" of the major tissues of the body to hormones. The important consequence is a decreased ability of the tissues to respond normally during the starve–feed cycle. Whether this is a contributing factor to or a consequence of the aging process is unknown.

Staying in the Well-Fed State Results in Obesity and Insulin Resistance

Figure 13.17*a* illustrates the metabolic interrelationships prevailing in an obese person. Most of the body fat of the human is either provided by the diet or synthesized in the liver and transported to the adipose tissue for storage. Obesity is caused by a person staying in such a well-fed state that stored fat does not get used up during the fasting phase of the cycle. The body then has no option other than to accumulate fat (see Clin. Corr. 13.1).

Obesity always causes some degree of **insulin resistance**. Insulin resistance is a poorly understood phenomenon in which the tissues fail to respond to insulin. The number or affinity of insulin receptors is reduced in some patients; others have normal insulin binding, but abnormal postreceptor responses, such

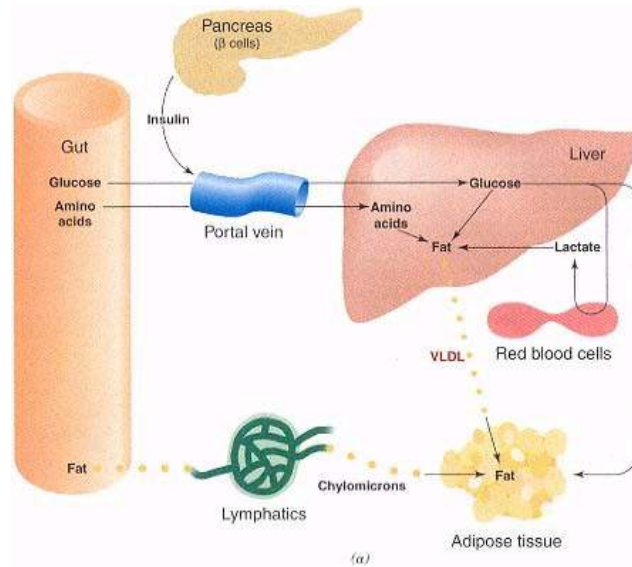

Figure 13.17
Metabolic interrelationships of tissues in various nutritional, hormonal, and disease states.
 (a) Obesity.

as the activation of glucose transport. As a general rule, the greater the quantity of body fat, the greater the resistance of normally insulin-sensitive cells to the action of insulin. Current research suggests that high expression of **tumor necrosis factor- α (TNF- α)** in the fat cells of obese individuals contributes to insulin resistance. As a consequence, plasma insulin levels are greatly elevated in the blood of an obese individual. As long as the β cells of the pancreas produce enough insulin to overcome the insulin resistance, an obese individual will have relatively normal blood levels of glucose and lipoproteins. The insulin resistance of obesity can lead, however, to the development of noninsulin-dependent diabetes, as discussed next.

Noninsulin-Dependent Diabetes Mellitus

Figure 13.17b shows the metabolic interrelationships characteristic of a person with **noninsulin-dependent diabetes**. In contrast to insulin-dependent diabetes, insulin is not absent in noninsulin-dependent diabetes (see Clin. Corr. 13.7). Indeed, high levels of insulin may be observed in this form of diabetes, and the problem is primarily resistance to the action of insulin as discussed above for obese individuals. It therefore follows that the majority of patients with noninsulin-dependent diabetes mellitus are obese. Although the insulin levels of noninsulin-dependent diabetic patients may and often are high, they are not as high as those of a nondiabetic but similarly obese person. The pancreases of these diabetic patients do not produce enough insulin to overcome the insulin resistance induced by their obesity. Hence this form of diabetes is also a form of β -cell failure; exogenous insulin will reduce the hyperglycemia and very often must be administered to control blood glucose levels of noninsulin-dependent diabetic patients. Hyperglycemia results mainly because of poor uptake of glucose by peripheral tissues, especially muscle. In contrast to insulin-dependent diabetes, ketoacidosis does not develop because the adipocytes

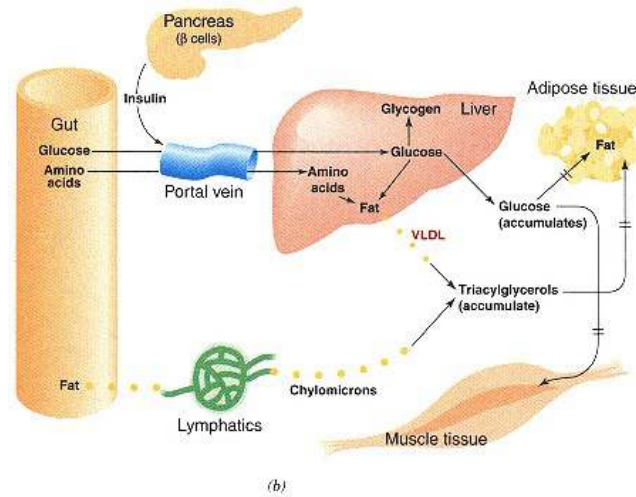

Figure 13.17
(continued)

(b) Noninsulin-dependent diabetes mellitus.

remain sensitive to the effect of insulin on lipolysis. Hypertriglyceridemia is characteristic of noninsulin-dependent diabetes but usually results from an increase in VLDLs without **hyperchylomicronemia**. This is most likely explained by rapid rates of *de novo* hepatic synthesis of fatty acids and VLDLs rather than increased delivery of fatty acids from the adipose tissue.

CLINICAL CORRELATION 13.7

Noninsulin-Dependent Diabetes Mellitus

Noninsulin-dependent diabetes mellitus (NIDDM) accounts for 80–90% of the diagnosed cases of diabetes and is also called maturity-onset diabetes to differentiate it from insulin-dependent, juvenile diabetes. It usually occurs in middle-aged obese people. Noninsulin-dependent diabetes is characterized by hyperglycemia, often with hypertriglyceridemia. The ketoacidosis characteristic of the insulin-dependent disease is not observed. Increased levels of VLDL are probably the result of increased hepatic triacylglycerol synthesis stimulated by hyperglycemia and hyperinsulinemia. Insulin is present at normal to elevated levels in this form of the disease. Obesity often precedes the development of insulin-independent diabetes and appears to be the major contributing factor. Obese patients are usually hyperinsulinemic. Very recent data implicate increased levels of expression of tumor necrosis factor- α (TNF- α) in adipocytes of obese individuals as a cause of the resistance. The greater the adipose tissue mass, the greater the production of TNF- α , which acts to impair insulin receptor function. An inverse relationship between insulin levels and the number of insulin receptors has been established. The higher the basal level of insulin, the fewer receptors present on the plasma membranes. In addition, there are defects within insulin-responsive cells at sites beyond the receptor. An example is the ability of insulin to recruit glucose transporters from intracellular sites to the plasma membrane. As a consequence, insulin levels remain high, but glucose levels are poorly controlled because of the lack of normal responsiveness to insulin. Although the insulin level is high, it is not as high as in a person who is obese but not diabetic. In other words, there is a relative deficiency in the insulin supply from the β cells. Therefore, this disease is caused not only by insulin resistance but also by impaired β -cell function resulting in relative insulin deficiency. Diet alone can often control the disease in the obese diabetic. If the patient can be motivated to lose weight, insulin receptors will increase in number, and the postreceptor abnormalities will improve, which will increase both tissue sensitivity to insulin and glucose tolerance. The noninsulin-dependent diabetic tends not to develop ketoacidosis but nevertheless develops many of the same complications as the insulin-dependent diabetic, that is, nerve, eye, kidney, and coronary artery disease.

Olefsky, J. M., and Kolterman, O. G. Mechanisms of insulin resistance in obesity and non-insulin dependent (type II) diabetes. *Am. J. Med.* 70:151, 1981; Flier, J. S. The adipocyte: storage depot or node on the energy information superhighway? *Cell*80:15, 1995; and Ruderman, N. B., Williamson, J. R., and Brownlee, M. Glucose and diabetic vascular disease. *FASEB J.* 6:2905, 1992.

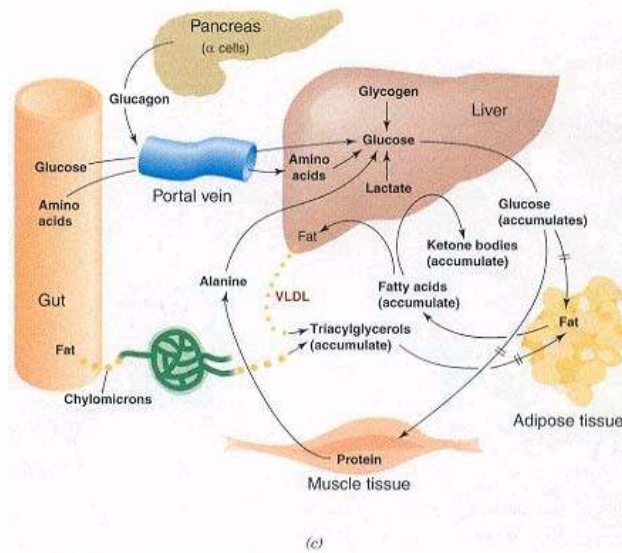

Figure 13.17
(continued)

(c) Insulin-dependent diabetes mellitus.

CLINICAL CORRELATION 13.8

Insulin-Dependent Diabetes Mellitus

Insulin-dependent diabetes mellitus (IDDM) was once called juvenile-onset diabetes because it usually appears in childhood or in the teens, but it is not limited to these patients. Insulin is absent in this disease because of defective or absent β cells in the pancreas. The β cells are destroyed by an autoimmune process. Untreated, IDDM is characterized by hyperglycemia, hyperlipoproteinemia (chylomicrons and VLDLs), and episodes of severe ketoacidosis. Far from being a disease of defects in carbohydrate metabolism alone, diabetes causes abnormalities in fat and protein metabolism in such patients as well. The hyperglycemia results in part from the inability of the insulin-dependent tissues to take up plasma glucose and in part by accelerated hepatic gluconeogenesis from amino acids derived from muscle protein. The ketoacidosis results from increased lipolysis in the adipose tissue and accelerated fatty acid oxidation in the liver. Hyperchylomicronemia is the result of low lipoprotein lipase activity in adipose tissue capillaries, an enzyme dependent on insulin for its synthesis.

Although insulin does not cure the diabetes, its use markedly alters the clinical course of the disease. The injected insulin promotes glucose uptake by tissues and inhibits gluconeogenesis, lipolysis, and proteolysis. The patient has the difficult job of trying to adjust the insulin dose to a variable dietary intake and variable physical activity, the other major determinant of glucose disposal by muscle. Tight control demands the use of several injections of insulin per day and close blood sugar monitoring by the patient. Tight control of blood sugar has now been proved to reduce the microvascular complications of diabetes (renal and retinal diseases).

National Diabetes Data Group. Classification and diagnosis of diabetes mellitus and other categories of glucose intolerance. *Diabetes* 28:1039, 1977; Atkinson, M. A., and Maclaren, N. K. The pathogenesis of insulin dependent diabetes mellitus. *N. Engl. J. Med.* 331:1428, 1991; and Clark, C. M., and Lee, D. A. Prevention and treatment of the complications of diabetes mellitus. *N. Engl. J. Med.* 332:1210, 1994.

Insulin-Dependent Diabetes Mellitus

Figure 13.17c shows the metabolic interrelationships that exist in **insulin-dependent diabetes mellitus** (see Clin. Corr. 13.8 and 13.9). In contrast to noninsulin-dependent diabetes, there is a complete absence of insulin production by the pancreas in this disease. Because of defective β -cell production of insulin, blood levels of insulin do not increase in response to elevated blood glucose levels. Even when dietary glucose is being delivered from the gut, the insulin/glucagon ratio cannot increase, and the liver remains gluconeogenic and ketogenic. Since it is impossible to switch to the processes of glycolysis, glycogenesis, and lipogenesis, the liver cannot properly buffer blood glucose levels. Indeed, since hepatic gluconeogenesis is continuous, the liver contributes to hyperglycemia in the well-fed state. Failure of some tissues, especially muscle, to take up glucose in the absence of insulin contributes further to the hyperglycemia. Accelerated gluconeogenesis, fueled by substrate made available by tissue protein degradation, maintains the hyperglycemia even in the starved state.

The absence of insulin in patients with insulin-dependent diabetes mellitus results in uncontrolled rates of lipolysis in adipose tissue. This increases blood levels of fatty acids and results in accelerated ketone body production by the liver. If ketone bodies are not used as rapidly as they are formed, diabetic ketoacidosis develops due to accumulation of ketone bodies and hydrogen ions. Not all the fatty acid taken up by liver can be handled by the pathway of fatty acid oxidation and ketogenesis. The excess is esterified and directed into VLDL synthesis. **Hypertriglyceridemia** results because VLDLs are synthesized and released by the liver more rapidly than these particles can be cleared from the blood by lipoprotein lipase. The quantity of this enzyme is dependent on the blood insulin level. The defect in lipoprotein lipase also results in hyperchylomicronemia, since lipoprotein lipase is required for chylomicron catabolism in adipose tissue. In summary, in diabetes every tissue continues to play the catabolic role that it was designed to play in starvation, in spite of

delivery of adequate or even excess fuel from the gut. This results in a gross elevation of all fuels in the blood with severe wasting of body tissues and ultimately death unless insulin is administered.

CLINICAL CORRELATION 13.9

Complications of Diabetes and the Polyol Pathway

Diabetes is complicated by several disorders that may share a common pathogenesis. The lens, peripheral nerve, renal papillae, Schwann cells, glomerulus, and possibly retinal capillaries contain two enzymes that constitute the polyol pathway (the term polyol refers to polyhydroxy sugars). The first is aldose reductase, an NADPH-requiring enzyme. It reduces glucose to form sorbitol. Sorbitol is further metabolized by sorbitol dehydrogenase, an NAD⁺-requiring enzyme that oxidizes sorbitol to fructose. Aldose reductase has a high K_m for glucose; therefore this pathway is only quantitatively important during hyperglycemia. It is known that in diabetic animals the sorbitol content of lens, nerve, and glomerulus is elevated. Sorbitol accumulation may damage these tissues by causing them to swell. There are now inhibitors of the reductase that prevent the accumulation of sorbitol in these tissues and thus retard the onset of these complications. This is a very controversial area because differences in potency of the inhibitors, experimental designs, length of trials, and the numbers of patients enrolled have resulted in different studies reaching different conclusions. We cannot as yet confidently recommend these drugs to prevent diabetic complications.

Gabbay, K. H. Hyperglycemia, polyol metabolism, and the complications of diabetes mellitus. *Annu. Rev. Med.* 26:521, 1975; Frank, R. N. The aldose reductase controversy. *Diabetes* 43:169, 1994; and Clark, C. M., and Lee, D. A. Prevention and treatment of the complications of diabetes mellitus. *N. Engl. J. Med.* 332:1210, 1994.

Aerobic and Anaerobic Exercise Use Different Fuels

It is important to differentiate between two distinct types of **exercise**—aerobic and anaerobic. Aerobic exercise is exemplified by long-distance running, anaerobic exercise by sprinting or weight lifting. During anaerobic exercise there is really very little interorgan cooperation. The blood vessels within the muscles are compressed during peak contraction, thus their cells are isolated from the rest of the body. Muscle largely relies on its own stored glycogen and **phosphocreatine**. Phosphocreatine serves as a source of high-energy phosphate for ATP synthesis (Figure 13.7) until glycogenolysis and glycolysis are stimulated. Glycolysis becomes the primary source of ATP for want of oxygen. Aerobic exercise is metabolically more interesting (Figure 13.17*d*). For moderate exercise, much of the energy is derived from glycolysis of muscle glycogen. This biochemical fact is the basis for **carbohydrate loading**. Muscle glycogen content can be increased by exhaustive exercise that depletes glycogen, followed by rest and a high-carbohydrate diet. There is also stimulation of branched-chain amino acid oxidation, ammonium production, and alanine release from the exercising muscle. However, a well-fed individual does not store enough glucose and glycogen to provide the energy needed for running long distances. The **respiratory quotient**, the ratio of carbon dioxide exhaled to oxygen consumed, falls during distance running. This indicates the progressive switch from glycogen to fatty acid oxidation during a race. Lipolysis gradually increases as glucose stores are exhausted, and, as in the fasted state, muscles oxidize fatty acids in preference to glucose as the former become available.

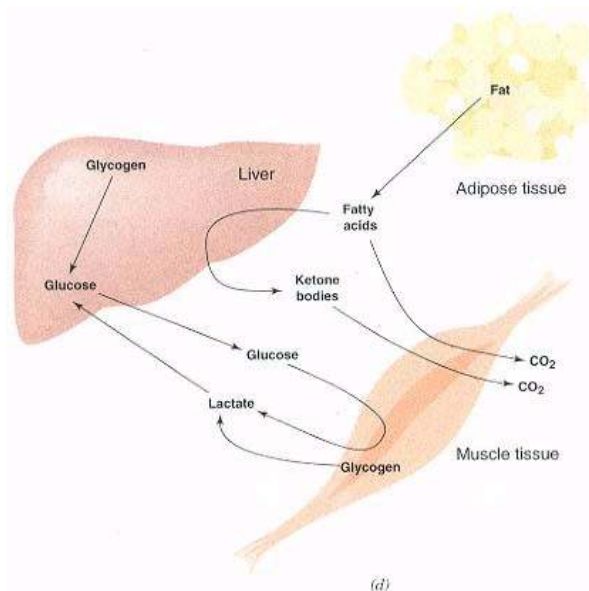

Figure 13.17
(continued)
(d) Exercise.

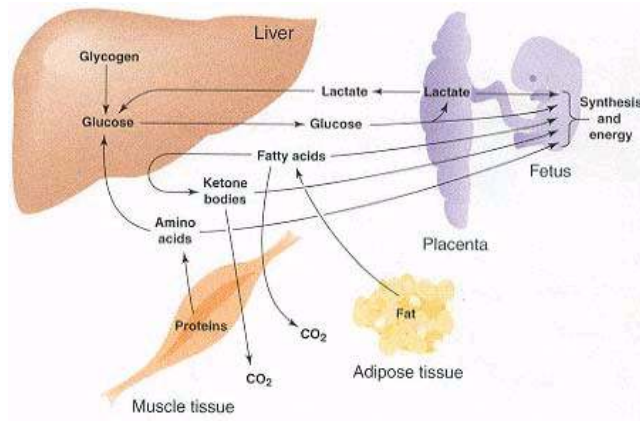

Figure 13.17
(continued)
(e) Pregnancy.

Unlike fasting, there is little increase in blood ketone body concentration. This may reflect a balance between hepatic ketone body synthesis and muscle ketone body oxidation.

Changes in Pregnancy Are Related to Fetal Requirements and Hormonal Changes

The **fetus** can be considered as another nutrient-requiring tissue (Figure 13.17e). It mainly uses glucose for energy but may also use amino acids, lactate, fatty acids, and ketone bodies. Lactate produced in the **placenta** by glycolysis goes in two directions. Part of it is directed to the fetus where it serves as a fuel, with the rest returning to the maternal circulation to establish a Cori cycle with the liver. Maternal LDL cholesterol is an important precursor of placental steroids (estradiol and progesterone). During **pregnancy**, the starve–feed cycle is perturbed. The placenta secretes a polypeptide hormone, **placental lactogen**, and two steroid hormones, estradiol and progesterone. Placental lactogen stimulates lipolysis in adipose tissue, and the steroid hormones induce an insulin-resistant state. Thus, in the postprandial state, pregnant women enter the starved state more rapidly than do nonpregnant women. This results from increased consumption of glucose and amino acids by the fetus. Plasma glucose, amino acids, and insulin levels fall rapidly, and glucagon and placental lactogen levels rise and stimulate lipolysis and ketogenesis. The consumption of glucose and amino acids by the fetus may be great enough to cause maternal hypoglycemia. On the other hand, in the fed state pregnant women have increased levels of insulin and glucose and demonstrate resistance to exogenous insulin. These swings of plasma hormones and fuels are even more exaggerated in pregnant diabetic women and make control of their blood glucose difficult.

Lactation Requires Synthesis of Lactose, Triacylglycerol, and Protein

In late pregnancy placental hormones induce lipoprotein lipase in the mammary gland and promote the development of milk-secreting cells and ducts. During **lactation** (see Figure 13.17f) the breast utilizes glucose for **lactose** and triacylglycerol synthesis, as well as its major energy source. Amino acids are taken

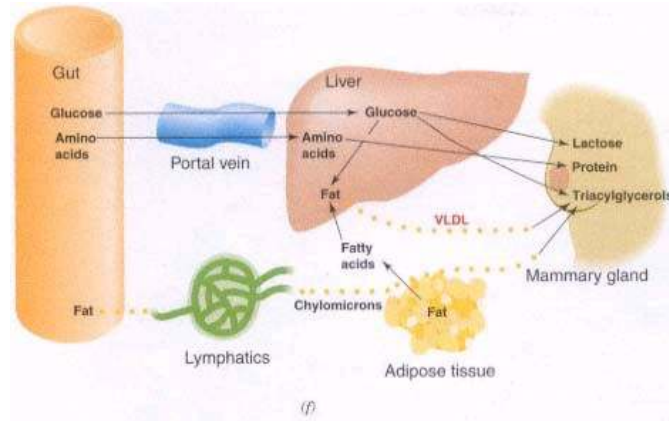

Figure 13.17
(continued)
(f) Lactation.

up for protein synthesis, and chylomicrons and VLDLs are utilized as sources of fatty acids for triacylglycerol synthesis. If these compounds are not supplied by the diet, proteolysis, gluconeogenesis, and lipolysis must supply them, resulting eventually in maternal malnutrition and poor quality milk. The lactating breast also secretes a hormone with some similarity to parathyroid hormone (see Chapter 20). This hormone probably is important for the absorption of calcium and phosphorus from the gut and bone.

Stress and Injury Lead to Metabolic Changes

Physiological stresses include **injury, surgery, renal failure, burns, and infections** (Figure 13.17g). Characteristically, blood cortisol, glucagon, **catecholamines**, and **growth hormone** levels increase. The patient is resistant to insulin. Basal metabolic rate, blood glucose, and free fatty acid levels are elevated. However, ketogenesis is not accelerated as in fasting. For incompletely understood reasons, the intracellular muscle glutamine pool is reduced, resulting in reduced protein synthesis and increased protein breakdown. It can be very difficult to reverse this protein breakdown, although now it is common to replace amino acids, glucose, and fat by infusing solutions of these nutrients intravenously. However, these solutions lack glutamine, tyrosine, and cysteine because of stability and solubility constraints. Supplementation of these amino acids, perhaps by the use of more stable dipeptides, may help to reverse the catabolic state better than can be accomplished at present.

It has been proposed that the negative nitrogen balance of injured or infected patients is mediated by monocyte and lymphocyte proteins, such as **interleukin-1**, interleukin-6, and **TNF- α** (see Clin. Corr. 13.10). These cytokines are responsible for causing fever as well as a number of other metabolic changes. Interleukin-1 activates proteolysis in skeletal muscle. **Interleukin-6** stimulates the synthesis of a number of hepatic proteins called **acute phase reactants** by the liver. Acute phase reactants include fibrinogen, complement proteins, some clotting factors, and α_2 -macroglobulin, which are presumed to play a role in defense against injury and infection. **TNF- α** suppresses adipocyte fat synthesis, prevents uptake of circulating fat by inhibiting lipoprotein lipase, stimulates lipolysis, inhibits release of insulin, and promotes insulin resistance. These cytokines appear responsible for much of the wasting seen in chronic infections.

CLINICAL CORRELATION 13.10

Cancer Cachexia

Unexplained weight loss may be a sign of malignancy, and weight loss is common in advanced cancer. Decreased appetite and food intake contribute to but do not entirely account for the weight loss. The weight loss is largely from skeletal muscle and adipose tissue, with relative sparing of visceral protein (i.e., liver, kidney, and heart). Although tumors commonly exhibit high rates of glycolysis and release lactate, the energy requirement of the tumor probably does not explain weight loss because weight loss can occur with even small tumors. In addition, the presence of another energy-requiring growth, the fetus in a pregnant woman, does not normally lead to weight loss. Several endocrine abnormalities have been recognized in cancer patients. They tend to be insulin-resistant, have higher cortisol levels, and have a higher basal metabolic rate compared with controls matched for weight loss. Two other phenomena may contribute to the metabolic disturbances. Some tumors synthesize and secrete biologically active peptides such as ACTH, nerve growth factor, and insulin-like growth factors, which could modify the endocrine regulation of energy metabolism. It is also possible that the host response to a tumor, by analogy to chronic infection, includes release of interleukin-1 (IL-1), interleukin-6 (IL-6), and tumor necrosis factor- α (TNF- α) by cells of the immune system. TNF- α is also called cachexin because it produces wasting. TNF- α and IL-1 may act in a paracrine fashion, as plasma levels are not elevated. They do induce the synthesis of IL-6, which has been detected in cachectic patients' sera at increased levels. These cytokines stimulate fever, proteolysis, lipolysis, and the synthesis of acute phase reactants by the liver.

Beutler, B., and Cerami, A. Tumor necrosis, cachexia, shock, and inflammation: a common mediator. *Annu. Rev. Biochem.* 57:1505, 1988; and Tracey, K. J., and Cerami, A. Tumor necrosis factor: a pleiotropic cytokine and therapeutic target. *Annu. Rev. Med.* 45:491, 1994.

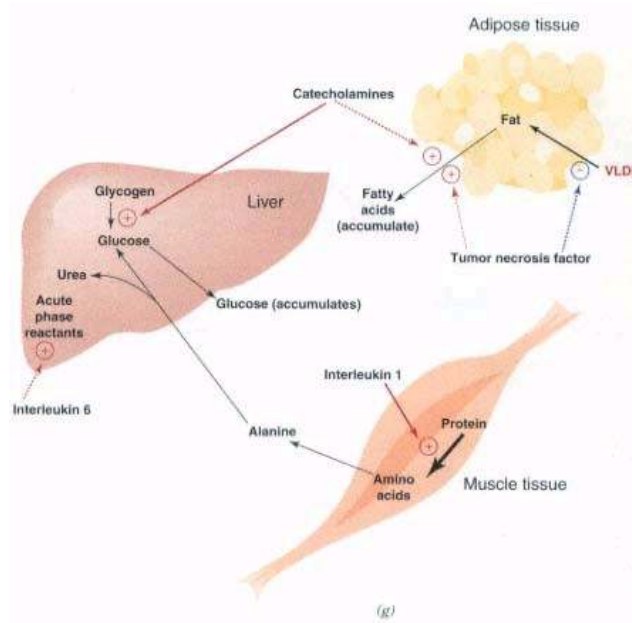

Figure 13.17
(continued)
(g) Stress.

Liver Disease Causes Major Metabolic Derangements

Since the liver is central to the body's metabolic interrelationships, advanced **liver disease** can be associated with major metabolic derangements (Figure 13.17*b*). The most important abnormalities are those in the metabolism of amino acids. The liver is the only organ capable of urea synthesis. In patients with **cirrhosis**, the liver is unable to convert ammonia into urea and glutamine rapidly enough, and the blood ammonia level rises. Part of this problem is due to abnormalities of blood flow in the cirrhotic liver, which interfere with the intercellular **glutamine cycle** (see p. 558). Ammonia arises from several enzyme reactions, such as glutaminase, glutamate dehydrogenase, and adenosine deaminase, during metabolism of amino acids by intestine and liver, and from intestinal lumen, where bacteria split urea into ammonia and carbon dioxide. Ammonia is very toxic to the central nervous system and is a major reason for the coma that sometimes occurs in patients in liver failure.

In advanced liver disease, aromatic amino acids accumulate in the blood to higher levels than branched-chain amino acids, apparently because of defective hepatic catabolism of the aromatic amino acids. This is important because aromatic amino acids and branched-chain amino acids are transported into the brain by the same carrier system. An elevated ratio of aromatic amino acids to branched-chain amino acids in liver disease results in increased brain uptake of aromatic amino acids. Increased synthesis of **neurotransmitters** such as **serotonin** in the brain as a consequence of increased availability of aromatic amino acids has been suggested to be responsible for some of the neurological abnormalities characteristic of liver disease. The liver is also a major source of insulin-like growth factor-I (IGF-I). Cirrhotics suffer muscle wasting because of deficient IGF-I synthesis in response to growth hormone. Finally, in outright

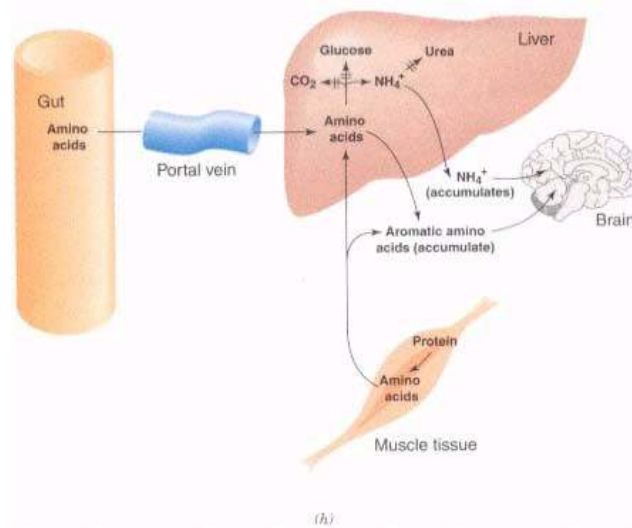

Figure 13.17
(continued)
(h) Liver disease.

liver failure, patients sometimes die of hypoglycemia because the liver is unable to maintain the blood glucose level by gluconeogenesis.

In Renal Disease Nitrogenous Wastes Accumulate

In chronic renal disease, there are many abnormalities of nitrogen metabolism. Levels of amino acids normally metabolized by kidney (glutamine, glycine, proline, and citrulline) increase. Nitrogen end products (e.g., urea, uric acid, and creatinine) also accumulate (Figure 13.17*i*). This accumulation is worsened by high dietary protein intake or accelerated proteolysis. The facts that gut bacteria can split urea into ammonia and that liver uses ammonia and α -keto acids to form nonessential amino acids have been used to control the level of nitrogenous wastes in renal patients. Patients are given a diet high in carbohydrate, and the amino acid intake is limited as much as possible to essential amino acids. Under these circumstances, the liver synthesizes nonessential amino acids from TCA cycle intermediates. This type of diet therapy may extend the time before the patient requires dialysis.

Oxidation of Ethanol in Liver Alters the $NAD^+/NADH$ Ratio

The liver is primarily responsible for the first two steps of the **ethanol** catabolism:

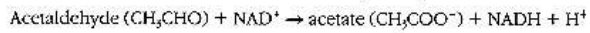

The first step, catalyzed by **alcohol dehydrogenases** in the cytosol, generates NADH; the second step, catalyzed by **aldehyde dehydrogenase**, also generates NADH but occurs largely in the mitochondrial matrix space. Liver disposes of NADH generated by these reactions by the only pathway it has available—the mitochondrial electron transport chain. Intake of even moderate amounts of

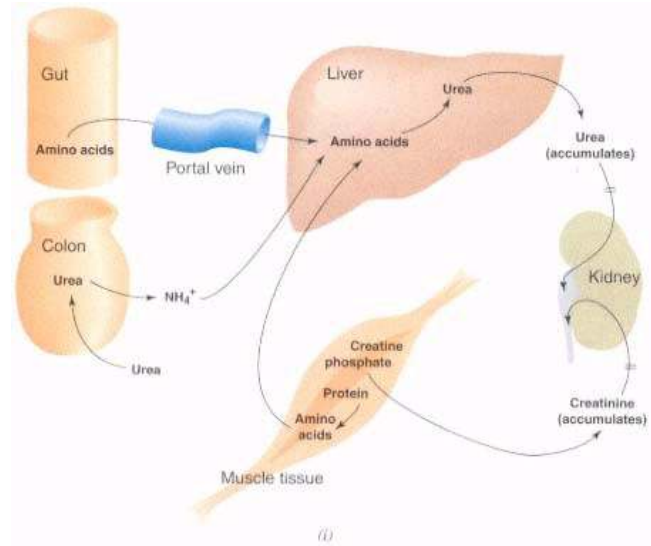

Figure 13.17
(continued)
(i) Kidney failure.

ethanol generates too much NADH. Many enzymes, for example, several involved in gluconeogenesis and fatty acid oxidation, are sensitive to product inhibition by NADH. Thus, during alcohol metabolism, these pathways are inhibited (Figure 13.17j), and fasting hypoglycemia and the accumulation of hepatic triacylglycerols (fatty liver) are consequences of alcohol ingestion. Lactate can accumulate as a consequence of inhibition of lactate gluconeogenesis and can result in metabolic acidosis.

Liver mitochondria have a limited capacity to oxidize acetate to CO_2 , because the activation of acetate to acetyl CoA requires GTP, a product of the succinyl CoA synthetase reaction. The TCA cycle, and therefore GTP synthesis, are inhibited by high NADH levels during ethanol oxidation. Much of the acetate made from ethanol escapes the liver to the blood. Virtually every other cell with mitochondria can oxidize it to CO_2 by way of the TCA cycle.

Acetaldehyde, the intermediate in the formation of acetate from ethanol, can also escape from the liver. Acetaldehyde is a reactive compound that readily forms covalent bonds with functional groups of biologically important compounds. Formation of acetaldehyde adducts with proteins in tissues and blood of animals and humans drinking alcohol has been demonstrated. Such adducts may provide a marker for past drinking activity of an individual, just as hemoglobin A_{1c} has proved useful as an index of blood glucose control in diabetic patients.

In Acid-Base Regulation, Glutamine Plays a Pivotal Role

Regulation of acid–base balance, like that of nitrogen excretion, is shared by the liver and kidney (Figure 13.17k). Metabolism of proteins generates excess hydrogen ions. For example:

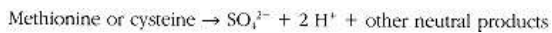

The kidney helps regulate blood pH by excreting hydrogen ions, which is necessary for the reabsorption of bicarbonate and the titration of phosphate

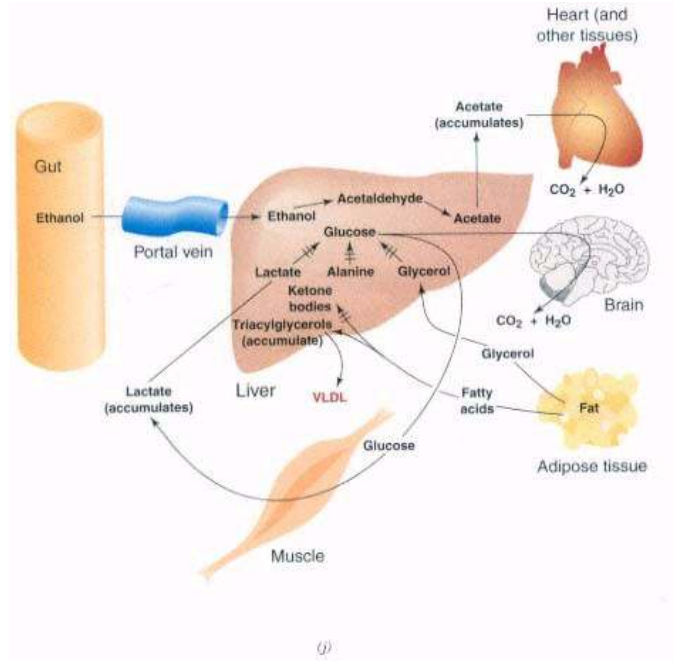

Figure 13.17
(continued)
(j) Ethanol ingestion.

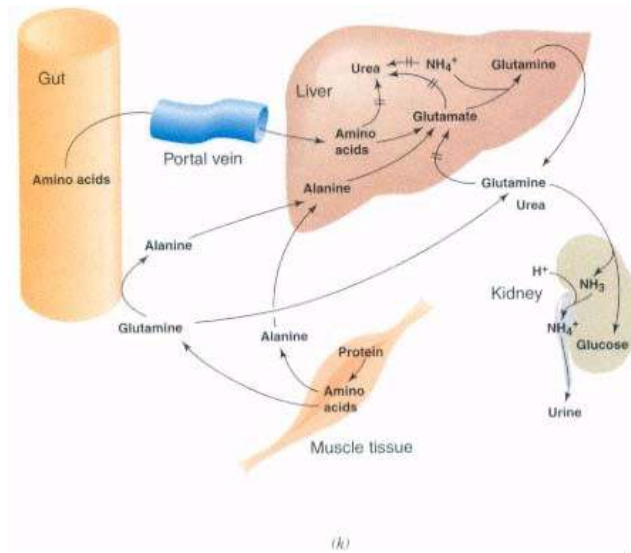

Figure 13.17
(continued)
(k) Acidosis.

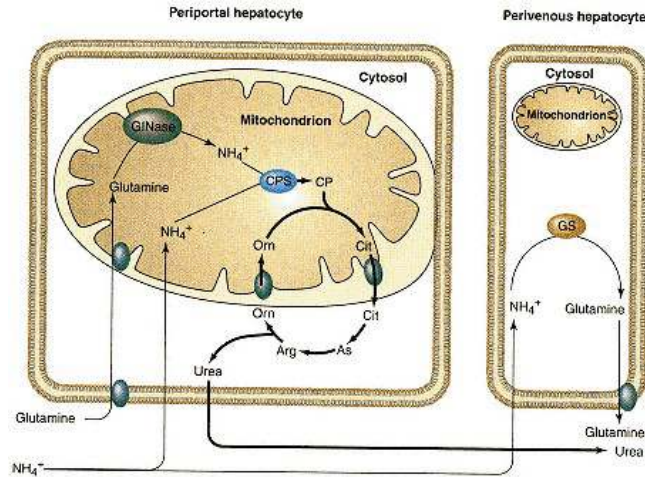

Figure 13.18
Intercellular glutamine cycle of the liver.
 Abbreviations: Glnase, glutaminase; GS, glutamine synthetase; CPS, carbamoyl phosphate synthetase I; CP, carbamoyl phosphate; Cit, citrulline; AS, argininosuccinate; Arg, arginine; Orn, ornithine.
 Redrawn from Häussinger, D. Glutamine metabolism in the liver: overview and current concepts. *Metabolism* 38(Suppl. 1):14, 1989.

and ammonia in the tubular filtrate (see Chapter 25, p. 1045). Glutamine is the precursor of renal ammonia production. In chronic metabolic **acidosis**, the activities of renal glutaminase, glutamate dehydrogenase, phosphoenolpyruvate carboxykinase, and the mitochondrial glutamine transporter increase and correlate with increased urinary excretion of ammonium ions and increased renal gluconeogenesis from amino acids. Liver participates by synthesizing less urea, which makes more glutamine available for the kidney. In **alkalosis**, urea synthesis increases in the liver, and gluconeogenesis and ammonium ion excretion by the kidney decrease.

An intercellular glutamine cycle enables the liver to play a central role in the regulation of blood pH. The liver is composed of two types of hepatocytes involved in glutamine metabolism: **periportal hepatocytes** near the hepatic arteriole and portal venule and **perivenous hepatocytes** located near the central venule (Figure 13.18). Blood enters the liver by the hepatic artery and

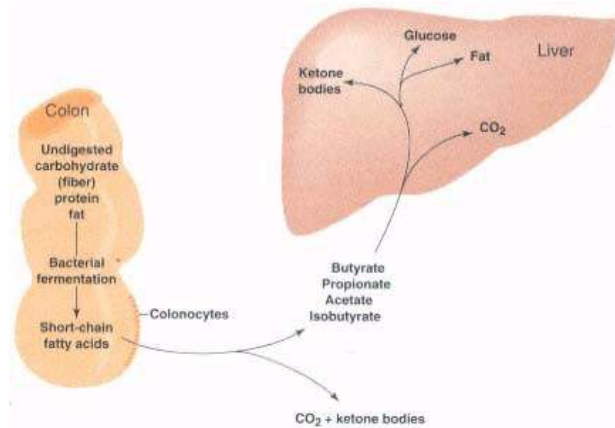

Figure 13.19
 Bacterial fermentation generates fuel for colonocytes.

portal vein and leaves by way of the central vein. Glutaminase and urea cycle enzymes are concentrated in the periportal hepatocytes, while glutamine synthetase is found exclusively in perivenous hepatocytes (see p. 450). During alkalosis, glutamine enters the periportal cells and is hydrolyzed to contribute ammonium ion for urea synthesis. The bulk of glutamine and ammonium nitrogen entering the liver leaves the liver as urea. The perivenous cellular location of glutamine synthetase is important because some ammonium ions escape conversion to urea. This enzyme traps much of this toxic compound in the form of glutamine. Thus glutamine is released from the liver and circulates back to the liver where it reenters the glutamine cycle in the periportal hepatocytes. Thus, in liver, both donation of ammonium ion by glutamine for urea synthesis and the synthesis of glutamine are important in maintaining low blood ammonium levels. In acidosis, glutaminase of the periportal hepatocytes (unlike the renal glutaminase isozyme) is less active and much of the blood glutamine escapes hydrolysis in the liver. Likewise, carbamoyl phosphate synthetase of periportal hepatocytes is less active in acidosis, permitting perivenous cells to convert more ammonium ion to glutamine, which is then available for metabolism by the kidney to yield hydrogen ions that need to be eliminated in the urine.

The Colon Salvages Energy from the Diet

Unlike the small intestine, which uses glutamine for its major energy source, the **colon** utilizes short-chain fatty acids: **butyrate, propionate, isobutyrate**, and acetate (Figure 13.19). It obtains most of these fatty acids from the lumen of the colon, where bacteria produce them by fermentation of unabsorbed dietary components. These short-chain fatty acids would otherwise be lost in stool, so their use by cells of the colon (colonocytes) represents a way of gaining as much energy from dietary sources as possible. If produced in excess of the needs of the colon, short-chain fatty acids pass into the portal blood for use by the liver. Interestingly, colonocytes can produce ketone bodies from butyrate, presumably releasing them into the portal blood for use as fuel by extrahepatic tissues. When surgery is performed that bypasses the colon (e.g., an ileostomy), some patients develop a form of colitis called diversion **colitis**. In some cases, providing enemas containing the short-chain fatty acids has healed the colitis.

Bibliography

- Amiel, S. A. Organ fuel selection: brain. *Proc. Nutr. Soc.* 54:151, 1995.
- Brownlee, M., Vlassara, H., and Cerami, A. Nonenzymatic glycosylation and the pathogenesis of diabetes complications. *Ann. Intern. Med.* 101:527, 1984.
- Cahill, G. F. Jr. Diabetes mellitus: a brief overview. *Johns Hopkins Med. J.* 143:155, 1978.
- Calder, P. C. Fuel utilization by cells of the immune system. *Proc. Nutr. Soc.* 54:65, 1995.
- Cerami, A., and Koenig, R. H. Hemoglobin A_{1c} as a model for the development of the sequelae of diabetes mellitus. *Trends Biochem. Sci.* 3:73, 1978.
- Cohen, P., and Cohen, P. T. W. Protein phosphatases come of age. A review. *J. Biol. Chem.* 264:21435, 1989.
- Crabb, D. W., and Lumeng, L. Metabolism of alcohol and the pathophysiology of alcoholic liver disease. In G. Gitnick (Ed.), *Principles and Practice of Gastroenterology and Hepatology*. New York: Elsevier, 1988, p. 1163.
- Curthoys, N. P., and Watford, M. Regulation of glutaminase activity and glutamine metabolism. *Annu. Rev. Nutr.* 15:133, 1995.
- DeLeve, L. D., and Kaplowitz, N. Glutathione metabolism and its role in hepatotoxicity. *Pharmacol. Ther.* 52:287, 1991.
- Denton, R. M., and Pogson, C. I. *Metabolic Regulation*. New York: Wiley, 1976.
- Duée, P.-H., Darcy-Vrillon, B., Blachier, F., and Morel, M.-T. Fuel selection in intestinal cells. *Proc. Nutr. Soc.* 54:83, 1995.
- Elia, M. General integration and regulation of metabolism at the organ level. *Proc. Nutr. Soc.* 54:213, 1995.
- Foster, D. W. Banting lecture 1984. From glycogen to ketones and back. *Diabetes* 33:1188, 1984.
- Foster, D. W. Diabetes mellitus. In: C. R. Scriver, A. L. Beaudet, W. S. Sly, and D. Valle. (Eds), *The Metabolic Basis of Inherited Disease*. New York: McGraw-Hill, 1989.
- Frayn, K. N., Humphreys, S. M., and Coppack, S. W. Fuel selection in white adipose tissue. *Proc. Nutr. Soc.* 54:177, 1995.
- Fulop, M. Alcoholism, ketoacidosis, and lactic acidosis. *Diabetes Metab. Rev.* 5:365, 1989.
- Geelen, M. J. H., Harris, R. A., Beynen, A. C., and McCune, S. A. Short-term hormonal control of hepatic lipogenesis. *Diabetes* 29:1006, 1980.
- Goldberg, A. L., Baracos, V., Rodemann, P., Waxman, L., and Dinarello, C. Control of protein degradation in muscle by prostaglandins, calcium, and leukocytic pyrogen (interleukin 1). *Fed. Proc.* 43:1301, 1984.
- Harris, R. A., Popov, K. M., and Zhao, Y. Nutritional control of the protein kinases responsible for the phosphorylation of the α -ketoacid dehydrogenase complexes. *J. Nutr.* 125:1758S, 1995.
- Haussinger, D. Glutamine metabolism in the liver: overview and current concepts. *Metabolism* 38(Suppl. 1):14, 1989.
- Henriksson, J. Muscle fuel selection: effect of exercise and training. *Proc. Nutr. Soc.* 54:125, 1995.

- Hers, H. G., and Hue, L. Gluconeogenesis and related aspects of glycolysis. *Annu. Rev. Biochem.* 52:617, 1983.
- Ingebritsen, T. S., and Cohen, P. Protein phosphatases: properties and role in cellular regulation. *Science* 221:331, 1983.
- Katz, J., and McGarry, J. D. The glucose paradox. Is glucose a substrate for liver metabolism? *J. Clin. Invest.* 74:1901, 1984.
- Krebs, H. A. Some aspects of the regulation of fuel supply in omnivorous animals. *Adv. Enzyme Regul.* 10:387, 1972.
- Krebs, H. A., Williamson, D. H., Bates, M. W., Page, M. A., and Hawkins, R. A. The role of ketone bodies in caloric homeostasis. *Adv. Enzyme Regul.* 9:387, 1971.
- Kurkland, I. J., and Pilkis, S. J. Indirect and direct routes of hepatic glycogen synthesis. *FASEB J.* 3:2277, 1989.
- Lamer, J. *Intermediary Metabolism and Its Regulation*. Englewood Cliffs, NJ: Prentice Hall, 1971.
- MacDonald, I. A., and Webber, J. Feeding, fasting and starvation: factors affecting fuel utilization. *Proc. Nutr. Soc.* 54:267, 1995.
- McGarry, J. D., Woeltje, K. F., Kuwajima, M., and Foster, D. W. Regulation of ketogenesis and the renaissance of carnitine palmitoyltransferase. *Diabetes Metab. Rev.* 5:271, 1989.
- Newsholme, E. A., and Leech, A. R. *Biochemistry for the Medical Sciences*. New York: Wiley, 1983.
- Newsholme, E. A., and Start, C. *Regulation in Metabolism*. New York: Wiley, 1973.
- Nosadini, R., Avogaro, A., Doria, A., Fioretto, P., Trevisan, R., and Morocutti, A. Ketone body metabolism: a physiological and clinical overview. *Diabetes Metab. Rev.* 5:299, 1989.
- Pedersen, O. The impact of obesity on the pathogenesis of non-insulin-dependent diabetes mellitus: a review of current hypotheses. *Diabetes Metab. Rev.* 5:495, 1989.
- Pedersen, O., and Beck-Nielsen, H. Insulin resistance and insulin-dependent diabetes mellitus. *Diabetes Care* 10:516, 1987.
- Pilkis, S. J., Ed-Maghrabi, M. R., and Claus, T. H. Hormonal regulation of hepatic gluconeogenesis and glycolysis. *Annu. Rev. Biochem.* 57:755, 1988.
- Randle, P. J. Metabolic fuel selection: general integration at the whole-body level. *Proc. Nutr. Soc.* 54:317, 1995.
- Shulman, G. I., and Landau, B. R. Pathways of glycogen repletion. *Physiol. Rev.* 72:1019, 1992.
- Sugden, M. C., Holness, M. J., and Palmer, T. N. Fuel selection and carbon flux during the starved-to-fed transition. A review article. *Biochem. J.* 263:313, 1989.
- Toth, B., Bollen, M., and Stalmans, W. Acute regulation of hepatic phosphatases by glucagon, insulin, and glucose. *J. Biol. Chem.* 263:14061, 1988.
- Ulwin, P. The state of world hunger. *Nutr. Rev.* 52:151, 1994.
- Williamson, D. H., and Lund, P. Substrate selection and oxygen uptake by the lactating mammary gland. *Proc. Nutr. Soc.* 54:165, 1995.

Questions

C. N. Angstadt and J. Baggott

Refer to the following for Questions 1 and 2

- A. well-fed state
- B. early fasting state
- C. fasting state
- D. early refed state

1. Hepatic glycogenolysis is a primary source of blood glucose during this period.
2. Ketone bodies supply a significant portion of the brain's fuel.
3. The fact that the K_m of aminotransferases for amino acids is much higher than that of aminoacyl-tRNA synthetases means that:
 - A. at low amino acid concentrations, protein synthesis will take precedence over amino acid catabolism.
 - B. the liver cannot accumulate amino acids.
 - C. amino acids will undergo transamination as rapidly as they are delivered to the liver.
 - D. any amino acids in excess of immediate needs for energy must be converted to protein.
 - E. amino acids can be catabolized only if they are present in the diet.
4. Branched-chain amino acids:
 - A. are normally completely catabolized by muscle to CO_2 and H_2O .
 - B. can be catabolized by liver but not muscle.
 - C. are the main dietary amino acids metabolized by intestine.
 - D. are in high concentration in blood following the breakdown of muscle protein.
 - E. are a major source of nitrogen for alanine and glutamine produced in muscle.
5. In the early refed state:
 - A. the fatty acid concentration of blood rises.
 - B. liver no longer carries out gluconeogenesis.
 - C. liver replenishes its glycogen by synthesis of glucose-6-phosphate from lactate.
 - D. glucose being fed is converted directly to glycogen by the liver.
 - E. amino acids cannot be used.
6. All of the following statements about interorgan interactions are correct EXCEPT:
 - A. ornithine for the urea cycle is synthesized from glutamate in the kidney.
 - B. citrulline leads to the formation of arginine in both liver and kidney.
 - C. kidney uses arginine in the synthesis of creatine for use by muscle.
 - D. arginine synthesized by the kidney is the source of nitric oxide for many cells.
 - E. creatinine cleared by the kidney is generated from creatine phosphate in muscle.
7. Carnitine:
 - A. is formed in all cells for their own use.
 - B. is synthesized from free lysine.
 - C. formation requires that lysyl residues in protein be methylated by *S*-adenosylmethionine.
 - D. formation is inhibited by vitamin C.
 - E. is cleaved to γ -butyrobetaine.
8. The largest energy reserve (in terms of kilocalories) in humans is:
 - A. blood glucose.
 - B. liver glycogen.
 - C. muscle glycogen.
 - D. adipose tissue triacylglycerol.
 - E. muscle protein.

9. All of the following represent control of a metabolic process by substrate availability EXCEPT:

- A. increased urea synthesis after a high-protein meal.
- B. rate of ketogenesis.
- C. hypoglycemia of advanced starvation.
- D. response of glycolysis to fructose 2,6-bisphosphate.
- E. sorbitol synthesis.

10. Which of the following would favor gluconeogenesis in the fasted state?

- A. fructose 1,6-bisphosphate stimulation of pyruvate kinase
- B. acetyl CoA activation of pyruvate carboxylase
- C. citrate activation of acetyl-CoA carboxylase
- D. malonyl CoA inhibition of carnitine palmitoyltransferase I
- E. fructose 2,6-bisphosphate stimulation of 6-phosphofructo-1-kinase

11. Conversion of a nonphosphorylated enzyme to a phosphorylated one:

- A. always activates the enzyme.
- B. is always catalyzed by a cAMP-dependent protein kinase.
- C. is signaled in the liver by insulin.
- D. is more likely to occur in the fasted than in the well-fed.
- E. usually occurs at threonine residues of the protein.

12. Adipose tissue responds to low insulin/glucagon ratio by:

- A. dephosphorylating the interconvertible enzymes.
- B. stimulating the deposition of fat.
- C. increasing the amount of pyruvate kinase.
- D. stimulating hormone-sensitive lipase.
- E. stimulating phenylalanine hydroxylase.

13. Changing the level of enzyme activity by changing the number of enzyme molecules:

- A. is considerably slower than allosteric or covalent modification methods.
- B. may involve enzyme induction.
- C. may override the effectiveness of allosteric control.
- D. may be caused by hormonal influences or by changing the nutritional state.
- E. all of the above are correct.

14. Muscle metabolism during exercise:

- A. is the same in both aerobic and anaerobic exercise.
- B. shifts from primarily glucose to primarily fatty acids as fuel during aerobic exercise.
- C. uses largely glycogen and phosphocreatine in the aerobic state.
- D. causes a sharp rise in blood ketone body concentration.
- E. uses only phosphocreatine in the anaerobic state.

15. In noninsulin-dependent diabetes mellitus:

- A. hypertriglyceridemia does not occur.
- B. ketoacidosis in the untreated state is always present.
- C. results because the β cells of the pancreas can no longer make insulin.
- D. may be accompanied by high levels of insulin in the blood.
- E. results in severe weight loss.

16. The elevated liver concentration of NADH produced by ingestion of ethanol:

- A. is restricted to the mitochondria.
- B. may lead to an acidosis by inhibiting gluconeogenesis from lactate.
- C. leads to "fatty liver" by stimulating fatty acid synthesis.
- D. increases the conversion of acetate to acetyl CoA.
- E. arises solely from the conversion of ethanol to acetaldehyde.

17. Glutaminase:

- A. in renal cells is unaffected by blood pH.
- B. in liver is confined to perivenous hepatocytes.
- C. activity is low in liver during alkalosis.
- D. activity is more active in both liver and kidney in acidosis.
- E. in renal cells increases in acidosis.

Answers

1. B The response of glycogenolysis to fasting is rapid, and during this period there is still glycogen present. In fasting, the glycogen is depleted and in the other two states, glycogenesis would occur (p. 529).
2. C If ketone body concentration in blood is high, ketone bodies can cross the blood-brain barrier and they are a good fuel. High ketone body concentrations do not occur in the other states (p. 532).
3. A A high K_m means that a reaction will proceed slowly at low concentration, whereas a low K_m means the reaction can be rapid under the same circumstances. Protein synthesis requires only that all amino acids be present. Unless amino acids are in high enough concentration, the liver does not catabolize them (p. 529).
4. E A and B: Muscle has high levels of the aminotransferases for branched-chain amino acids, whereas liver has high levels of enzymes for the catabolism of the branched-chain α -keto acids. C: Intestine metabolizes several dietary amino acids but not these. D and E: When branched-chain amino acids are derived from muscle protein, transamination transfers the nitrogen to alanine or glutamine, which are transported to the liver and kidney (p. 531).
5. C This is the indirect pathway. A, B, and D: Fat metabolism is normal but glucose metabolism is not normal yet. E: Amino acids are also used for gluconeogenesis (p. 534).
6. A This is a pathway of intestinal epithelium (p. 534). B: This is part of the urea cycle in liver but arginine from kidney is an important source of arginine for liver. C: The reaction requires *S*-adenosylmethionine. E: Creatinine is thus a measure of both muscle mass and renal function (pp. 535–536).

7. C These trimethyllysines are released when protein is hydrolyzed. A: Only liver and kidney have the complete synthetic pathway. D: There are two hydroxylations that require this vitamin. E: This is a precursor (p. 536).
8. D The caloric content of adipose tissue fat is more than five times as great as that of muscle protein and almost 200 times as great as that of the combined carbohydrates (Table 13.1). A: Blood glucose must be maintained but is a relatively minor reserve. B and C: Glycogen is a rapidly mobilizable reserve of energy but not a large one. E: Protein can be used for energy, but that is not its primary role.
9. D Fructose 2,6-bisphosphate is an allosteric effector (activates the kinase and inhibits the phosphatase) of the enzyme controlling glycolysis. A: After a high-protein meal, the intestine produces ammonia and precursors of ornithine for urea synthesis. B: Ketogenesis is dependent on the availability of fatty acids. C: This represents lack of gluconeogenic substrates. E: This leads to complications in diabetes (p. 540).
10. B Pyruvate carboxylase is a key gluconeogenic enzyme. A and E: Stimulation of these enzymes stimulates glycolysis, opposing gluconeogenesis. C and D: Malonyl CoA inhibits transport of fatty acids into mitochondria for β -oxidation, a necessary source of energy for gluconeogenesis (p. 540).
11. D In the well-fed state, insulin/glucagon ratio is high and cAMP levels are low. A: Some enzymes are active when phosphorylated; for others the reverse is true. B: This is the most common, though not only, mechanism of phosphorylation. C: Insulin does not signal the phosphorylation of the enzymes involved. E: The most common site for phosphorylation is serine (pp. 541–544).
12. D A: Low insulin/glucagon ratio means high cAMP and, thus, high activity of cAMP-dependent protein kinase and protein phosphorylation. B and D: Phosphorylation activates hormone-sensitive lipase to mobilize fat. C: cAMP works by stimulating covalent modification of enzymes. E: This is a liver enzyme (pp. 544–545).
13. E A: Adaptive changes are examples of long-term control. B and D: Both hormonal and nutritional effects are involved in inducing certain enzymes and/or altering their rate of degradation. C: If there is little or no enzyme because of adaptive changes, allosteric control is irrelevant. This is important to keep in mind in refeeding a starved person (pp. 545–546).
14. B This is indicated by the drop in the respiratory quotient. A: Anaerobically exercised muscle uses glucose almost exclusively; aerobically exercised muscle uses fatty acids and ketone bodies. D: Ketone bodies are good aerobic substrates so the blood concentration does not increase greatly. E: Phosphocreatine is only a short-term source of ATP (p. 551).
15. D A: Hypertriglyceridemia is characteristic. B: Ketoacidosis is common only in the insulin-dependent type. C and D: The problem is insulin resistance, not failure to produce insulin. E: Most patients are obese because adipocytes remain sensitive to insulin (pp. 548 and 550).
16. B Failure to oxidize lactate to pyruvate because of the unfavorable NAD^+/NADH ratio leads to lactate accumulation. A and E: The oxidation of ethanol, which also produces NADH, is cytosolic. Acetaldehyde oxidation is mitochondrial. C: "Fatty liver" is a consequence of inhibition of fatty acid oxidation by high NADH. D: Acetate activation requires GTP from the TCA cycle. Why is this cycle inhibited (pp. 555–556)?
17. E A and E: Glutamine in kidney is the primary source of ammonia for excretion of protons. B: This is the site of glutamine synthesis. C: This is when urea is formed. D: The liver activity of liver glutaminase during acidosis permits glutamine to escape liver for the kidney's use (pp. 556–559).

**Chapter 14—
DNA I:
Structure and Conformation**

Stelios Aktipis

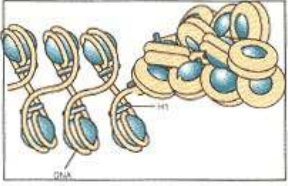

14.1 Overview	564
DNA Can Transform Cells	564
DNA's Information Capacity Is Enormous	565
14.2 Structure of DNA	565
Nucleotides Joined by Phosphodiester Bonds Form Polynucleotides	566
Nucleases Hydrolyze Phosphodiester Bonds	568
Periodicity Leads to Secondary Structure of DNA	568
Forces That Determine Polynucleotide Conformation	569
DNA Double Helix	570
Many Factors Stabilize DNA Structure	575
Denaturation	577
Renaturation	580
Hybridization	582
DNA Probes	583
Heteroduplexes	583
14.3 Types of DNA Structure	584
Size of DNA Is Highly Variable	584
Techniques for Determining DNA Size	585
DNA May Be Linear or Circular	586
Double-Stranded Circles	586
Single-Stranded DNA	587
Circular DNA Is a Superhelix	587
Geometric Description of Superhelical DNA	589
Topoisomerases	592
Alternative DNA Conformations	595
DNA Bending	595
Cruciform DNA	595
Triple-Stranded DNA	596
Four-Stranded DNA	599
Slipped DNA	601
Nucleoproteins of Eukaryotes Contain Histones and Nonhistone Proteins	601
Nucleosomes and Polynucleosomes	605
Polynucleosome Packing into Higher Structures	606
Nucleoproteins of Prokaryotes Are Similar to Those of Eukaryotes	609
14.4 DNA Structure and Function	609
Restriction Endonucleases and Palindromes	609
Most Prokaryotic DNA Codes for Specific Proteins	611
Only a Small Percentage of Eukaryotic DNA Codes for Structural Genes	613
Repeated Sequences	614
Single-Copy DNA	615
Moderately Reiterated DNA	615
Highly Reiterated DNA	616
Inverted Repeat DNA	616
Mitochondrial DNA	617
Bibliography	618
Questions and Answers	618
Clinical Correlations	
14.1 DNA Vaccines	565
14.2 Diagnostic Use of Probes in Medicine	583
14.3 Topoisomerases in Treatment of Cancer	594
14.4 Hereditary Persistence of Fetal Hemoglobin	600
14.5 Therapeutic Potential of Triplex DNA Formation	600
14.6 Expansion of DNA Triple Repeats and Human Disease	602
14.7 Mutations of Mitochondrial DNA: Aging and Degenerative Diseases	617

14.1— Overview

One of the striking aspects of natural order is the sense of unity that exists between members of successive generations in each species. An almost totally stable bank of information must always be preserved and passed from one generation to the next if individual species are to maintain their identities relatively unchanged over millions of years. It is well established that this bank of genetic information takes the form of a macromolecule, deoxyribonucleic acid (DNA), which serves as the carrier of genetic information in both prokaryotes and eukaryotes. DNA exhibits a rare purity of function by being one of the few macromolecules known to perform, with only minor exceptions, the same basic functions across species barriers.

Properties of cells are to a large extent determined by their constituent proteins. Many proteins are indispensable structural components of cells. Other proteins, such as enzymes and certain hormones, are functional and determine many of the biochemical properties of the cell. As a result, factors that control which proteins a cell may synthesize, at what quantities, and with which sequence are the same factors that primarily determine function and destiny of every living cell.

DNA is the macromolecule that ultimately controls every aspect of cellular function, primarily through protein synthesis. DNA exercises this control as suggested by the sequence

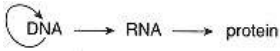

Flow of biological information is clearly from one class of nucleic acid to another, from DNA to RNA, with only minor exceptions, and from there to protein. For this transfer of information to occur faithfully, each preceding macromolecule serves as a structure-specifying template for the synthesis of the subsequent member in the sequence.

In addition to regulating cellular expression, DNA plays an exclusive role in heredity. This role is suggested by a circular arrow engulfing DNA, which depicts DNA as a replicon, a molecule that can undergo self-replication. Replication permits DNA to make copies of itself as a cell divides and bestows them to daughter cells, which can thus inherit every property and characteristic of the original cell. Thus DNA ultimately determines the properties of a living cell by regulating expression of biological information, primarily by control of protein synthesis, and transfers biological information from one generation to the next; that is, it transmits genetic information.

DNA Can Transform Cells

These universally accepted principles were rejected outright not long ago. In fact, prior to the 1950s the general view was that nucleic acids are substances of somewhat limited cellular importance. The first convincing suggestion that DNA is the genetic material was made during the mid-1940s. The experiment involved transformation of a type of pneumococcus, surrounded by a polysaccharide capsule and referred to as S form because of its property of forming colonies with smooth-looking cellular perimeters, to a mutant without capsule, called R form, which forms colonies with rough-looking outlines. These two forms are genetically distinct and cannot interconvert spontaneously. **Transformation** experiments demonstrated that an extract of pure DNA from S form, when incorporated into R form of pneumococcus, conveyed to R form the specific property of synthesizing the characteristic polysaccharide capsule. Furthermore, bacteria transformed from R form to S form maintained the property

of synthesizing capsule over succeeding generations. It was thus demonstrated that DNA was the **transforming agent**, as well as the material responsible for transmitting genetic information from one generation to the next. Almost three-quarters of a century elapsed from the time nucleic acids were discovered until their important biological role was generally recognized. Clinical Correlation 14.1 describes current studies in transforming mammalian cells with DNA.

DNA's Information Capacity Is Enormous

A striking characteristic of DNA is its ability to encode an enormous quantity of biological information. An undifferentiated mammalian fetal cell contains only a few picograms (10^{-12} g) of DNA. Yet this minute amount of material is sufficient to direct synthesis of as many as 100,000 distinct proteins that will determine the form and biochemical behavior of a large variety of differentiated tissues in adult animals.

The compactness of information storage in DNA is unique. Even sophisticated memory elements of contemporary computers appear pitifully inadequate by comparison. How does DNA achieve such a supreme **coding effectiveness**? Answers must obviously be sought in the nature of its chemical structure. It turns out that this structure is not only consistent with the unique efficiency of DNA as a "memory bank" but also provides the basis for understanding how DNA eventually "translates" this information into proteins.

CLINICAL CORRELATION 14.1

DNA Vaccines

Traditional procedures of vaccination have used purified components of an infectious organism, dead or attenuated intact cells or viruses, to provide individuals with active immunity by eliciting production of specific antibodies. Many have been successful in providing protection against diseases such as polio, smallpox, whooping cough, typhoid fever, and diphtheria.

A prototype DNA vaccine has been developed. It consists of a naked DNA that encodes the nucleoprotein of the influenza virus. This gene is the same or very similar in many strains of this virus and should afford protection against all or most of them. Naked DNA, that is, DNA freed of all its naturally associated proteins, is used. It enters cells and can be expressed without need of a complex virus system. Results of its use in mice and nonhuman primates have been very encouraging. Naked-DNA vaccines appear to stimulate cell-mediated immunity and an antibody response.

McDonnell, W. M., and Askari, F. K. DNA vaccines. *N. Engl. J. Med.* 334:42, 1996.

14.2—

Structure of DNA

DNA is a polynucleotide produced by polymerization of deoxyribonucleotides. The structure of nucleotides and their constituent purine and pyrimidine bases are presented in Chapter 12.

The **base composition of DNA** varies considerably among species, particularly prokaryotes, which have a range of 25–75% in adenine–thymine content. This range narrows with evolution, reaching limiting values of about 45–53% in mammals.

DNA contains various **methylated bases**. These methylated derivatives are present in all prokaryotic DNA molecules examined to date but are absent in certain eukaryotes such as yeast and insects. As a rule these bases are generated by action of methylases, Dam and Dem, following synthesis of DNA. Methyl groups are transferred from *S*-adenosylmethionine. **Dam methylase** selects adenine residues on GATC sequences for methylation. **Dem methylase** acts on cytosine residues on opposite strands in the sequence

```
C C A G G
| | | | |
G G T C C
```

Such methylated sites are recognized by proteins involved in DNA functions such as recombination and initiation of DNA synthesis.

A base may be methylated prior to incorporation into DNA, as in transformation of cytosine to **5-hydroxycytosine**. **Glycosylated 5-hydroxycytosine** is found as a constituent of T-even phages of *Escherichia coli*. Other unusual base changes include the presence of uracil, a constituent of RNA, in certain *Bacillus subtilis* phages, instead of thymine. Structures of some of these bases are shown in Figure 14.1.

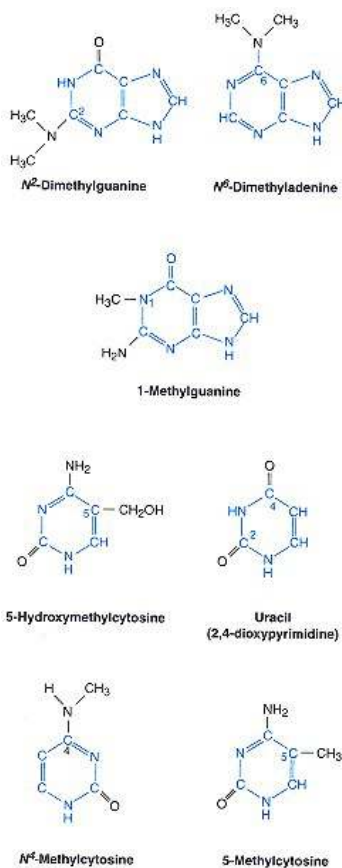

Figure 14.1
Structures of some less common
bases occurring in DNA.

Nucleotides Joined by Phosphodiester Bonds Form Polynucleotides

Polynucleotides are formed by joining of nucleotides by **phosphodiester bonds**. The phosphodiester bond is the formal analog of the peptide bond in proteins. It joins by esterification of two of the three OH groups of phosphoric acid, two adjoining nucleotide residues. Deoxyribose contains two free OH groups on the C-3 and C-5 atoms that can participate in formation of a phosphodiester bond. Indeed, the nucleotide residues in DNA are joined by **3',5'-phosphodiester bonds**, as shown in Figure 14.2.

Many polynucleotides are linear polymers. The last nucleotide residues at opposite ends of the polynucleotide chain serve as the two terminals of the chain. It is apparent that these terminals are not structurally equivalent, since one of the nucleotides must terminate at a 3 -OH group and the other at a 5 -OH group. These ends of the polynucleotides are referred to as 3 and 5 termini, and they may be viewed as corresponding to the amino and carboxyl termini in proteins. Polynucleotides also exist as cyclic structures, which contain

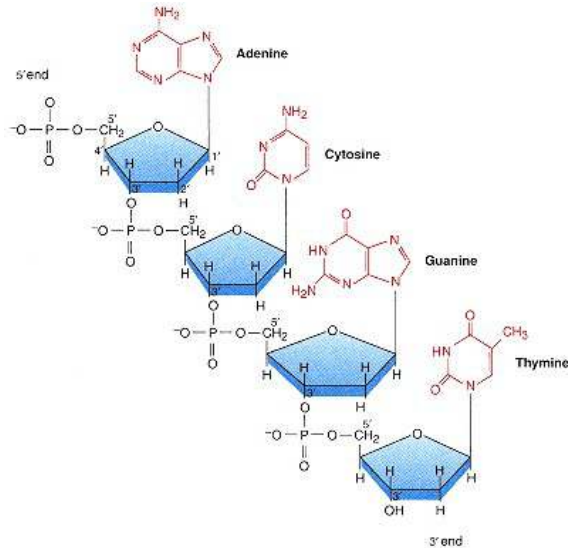

Figure 14.2
Structure of a DNA polynucleotide segment.
 Shown is a tetranucleotide. Generally, polymers containing less than 30–40 nucleotides are referred to as oligonucleotides.

no free terminals. Esterification between the 3'-OH terminus of a polynucleotide with its own 5'-phosphate terminus can produce a cyclic polynucleotide.

Long polymers of nucleotides joined by phosphodiester bonds are called polynucleotides. **Oligonucleotides** are shorter nucleotide-containing polymers. According to formal rules of nomenclature, however, polynucleotides are named by using roots derived from the names of corresponding nucleotides, and using the ending *yl*. Polynucleotide sequences are always read in the 5' → 3' direction, unless specified otherwise. For example, the polynucleotide segment in Figure 14.2, in which the 5' terminal is on the left of each nucleotide residue, should be named from left to right as

...deoxyadenylyl, deoxycytidylyl, deoxyguanylyl, deoxythymidylyl...

However, use of complete chemical names is cumbersome and abbreviations are generally preferred. For example, the oligonucleotide shown in Figure 14.2 is usually referred to as dAdCdGdT, and a polynucleotide containing only one kind of nucleotide, for example, dA, may be written as poly(dA). Oligo- and polynucleotide structures are also written out in shorthand, as shown in Figure 14.3.

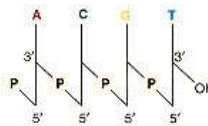

Figure 14.3
Shorthand form for structure of oligonucleotides.

The convention used in writing the structure of an oligo- or polynucleotide is a perpendicular bar representing the deoxyribose moiety, with the 5'-OH position of the sugar located at the bottom of the bar and the 3'-OH at a midway position. Bars joining the 3' and 5' positions represent the 3',5'-phosphodiester bond, and the P on the left side of the perpendicular bar represents a 5'-phosphate ester. A 3'-phosphate ester is represented by placing the phosphate group on the right side of the bar and the base by its initial.

The specific sequence of bases along a polynucleotide chain determines its biological properties. Although the structure of the nucleic acid bases had been known for many years, the polymeric structure initially proposed for DNA was one of the classical errors in the history of biochemistry. Experimental data obtained from partially degraded samples of DNA, and several misconceptions, led to the erroneous conclusion that DNA consisted of repeating tetranucleotide units. Each tetranucleotide supposedly contained equimolar quantities of the four common bases. These impressions persisted to some degree until the late 1940s and early 1950s, when they were clearly shown to be in error. In the interim, however, these misconceptions were responsible for setting back acceptance of the concept that DNA of chromosomes carried genetic information. The monotonous structure of repeating tetranucleotides appeared to lack the

versatility to encode for the enormous number of messages necessary to convey hereditary traits. Instead proteins, which can be ordered in an almost unlimited number of amino acid sequences, were favored as the most suitable candidates for a hereditary function. Transformation experiments carried out in the mid-1940s, and the finding that DNA consists of polynucleotide and not tetranucleotide chains, were responsible for general acceptance of the hereditary role of DNA that followed.

Nucleases Hydrolyze Phosphodiester Bonds

The nature of the linkage between nucleotides to form polynucleotides was elucidated primarily by use of exonucleases, enzymes that hydrolyze these polymers in a selective manner. Exonucleases cleave the last nucleotide residue at either of the two terminals of an oligonucleotide. Oligonucleotides can thus be degraded by stepwise removal of individual nucleotides or small oligonucleotides from either the 5' or 3' terminus. **Nucleases** sever bonds in one of two nonequivalent positions indicated in Figure 14.4 as proximal (p) or distal (d) to the base, which occupies the 3' end of the bond. For example, treatment of an oligodeoxyribonucleotide with snake venom diesterase, an enzyme obtained from snake venom, yields deoxyribonucleoside 5'-phosphates. In contrast, treatment with a diesterase isolated from animal spleen produces deoxyribonucleoside 3'-phosphates.

Other nucleases that cleave phosphodiester bonds located in the interior of polynucleotides are designated as endonucleases and behave similarly. For instance, DNase I cleaves only p linkages, while DNase II cleaves d linkages. Points of cleavage along an oligonucleotide chain are indicated by arrows in Figure 14.4. Some endonucleases have been particularly useful in development of methodologies for sequencing of DNA polynucleotides and have provided the basis for development of recombinant DNA techniques.

Many nucleases do not exhibit any specificity with respect to the base adjacent to the linkage that is hydrolyzed. Others, however, act very discriminately only next to specific types of bases or even specific bases. **Restriction endonucleases** act only on sequences of bases specifically recognized by each restriction enzyme. Nucleases also exhibit specificities with respect to overall structure of polynucleotides. For instance, some nucleases act on both single- or double-stranded polynucleotides, whereas others discriminate between these two structures. In addition, some nucleases exclusively designated as **phosphodiesterases** will act on either DNA or RNA, whereas other nucleases will limit their activity to only one type of polynucleotide. Nucleases listed in Table 14.1 illustrate some of the properties of these enzymes.

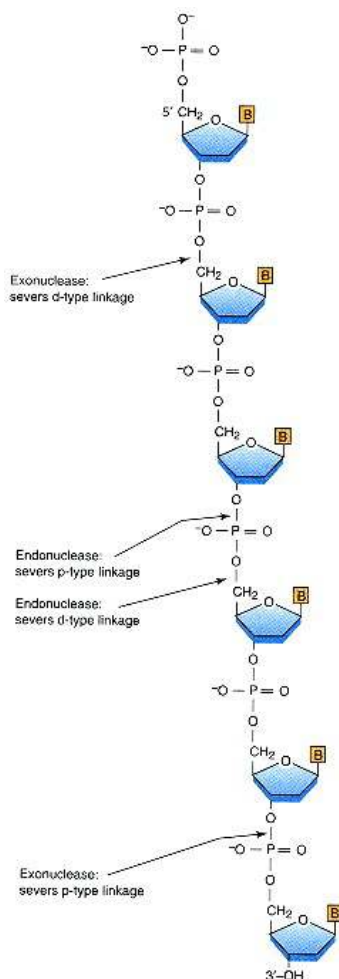

Figure 14.4

Specificities of nucleases.

Exonucleases remove nucleotide residues from either terminal of a polynucleotide, depending on their specificity. Endonucleases hydrolyze interior phosphodiester bonds. Both endo- and exonucleases hydrolyze either d- or p-type linkages (see text for explanation of d- and p-type linkages).

Periodicity Leads to Secondary Structure of DNA

Polypeptide chains of protein are often arranged in space so as to form periodic structures. For instance, in the α -helix each residue is related to the next by a translation of 1.5 Å along the helix axis and a rotation of 100° . This places 3.6 amino acid residues in each complete turn of the polypeptide helix. The property of **periodicity** is also encountered with polynucleotides, which usually occur in the form of **helices**. Such preponderance of helical conformations among macromolecules is not surprising. Formation of helices tends to accommodate effects of intramolecular forces, which in a helix can be distributed at regular intervals. The alternative, that is, a hypothetical extended linear conformation, would place successive base pairs at 0.68 nm apart and allow water molecules to be inserted between hydrophobic base pairs. Clearly such an arrangement would be thermodynamically unfavorable. The precise geometry of the polynucleotide helices varies, but the helical structure invariably results from stacking

TABLE 14.1 Specificities of Various Types of Nucleases

<i>Enzyme</i>	<i>Substrate</i>	<i>Specificity^a</i>
EXONUCLEASES		
Snake venom phosphodiesterase	DNA or RNA single-stranded only	Cleaves all p-type linkages, starting with a free 3'-OH group and moving toward the 5' terminal; releases nucleoside 5'-phosphates; has no base specificity
Bovine spleen phosphodiesterase	DNA or RNA single-stranded only	Cleaves all d-type linkages, starting at the free 5'-OH and proceeding to the 3' terminal; releases nucleoside 3'-phosphates; has no base specificity
ENDONUCLEASES		
Bovine pancreas deoxyribonuclease (DNase I)	DNA single- or double-stranded	Cleaves all p-type linkages but prefers those between purine and pyrimidine bases
Calf thymus deoxyribonuclease (DNase II)	DNA single- or double-stranded	Cleaves all d-type linkages randomly

^a See text for explanation of d- and p-type linkages.

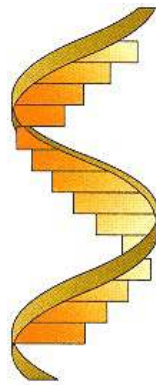

Figure 14.5
Conformation of a hypothetical, perfectly helical, single-stranded polynucleotide.
 The helical band represents the phosphate backbone of the polynucleotide. Bases are shown in a side view as solid blocks in tight contact with their neighbors, above and below each base. Surfaces of the rings are in contact with each other and are not visible in the perspective.

of bases along the helix axis. In many instances stacking produces helices in which bases are more or less perpendicularly oriented along the helix and touch one another. This arrangement leaves no free space between two successive neighboring bases (Figure 14.5). Such stacked single-stranded helices, however, are not commonly encountered in cells. Rather, polynucleotide helices tend to associate with one another to form double helices.

Forces That Determine Polynucleotide Conformation

The hydrophobic properties of the bases are, to a large extent, responsible for forcing polynucleotides to adopt helical conformations. Molecular models of bases reveal that the edges of the rings contain polar groups (i.e., amino and OH groups) that interact with other polar groups or surrounding water molecules. The faces of the rings, however, are unable to participate in such interactions and tend to avoid any contact with water. Instead they tend to interact with one another, producing a **stacked conformation**. The stability of this arrangement is further reinforced by an interchange between electrons that circulate in π orbitals located above and below the plane of each ring.

Clearly then, single-stranded polynucleotide helices are stabilized by **hydrophobic** and **dipole-induced dipole interactions** involving the π orbitals of bases, which collectively produce base stacking. The stability of helical structures is somewhat decreased by potential repulsion among charged phosphate residues of the polynucleotide backbone. These repulsive forces introduce a certain degree of rigidity to the structure of polynucleotides. Under physiological conditions, that is, at neutral pH and relatively high concentrations of salts, the charges on the phosphate residues are partially shielded by the cations present, such as Mg^{2+} , and the structure can be viewed as a fairly flexible coil. Under more extreme conditions stacking of bases is disrupted and the helix collapses. A collapsed helix is commonly described as a **random coil**. Conversion between a stacked helix and an unstacked conformation is depicted in Figure 14.6.

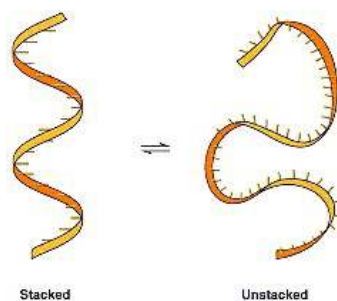

Figure 14.6
Stacked and unstacked conformations of a polynucleotide.
 Stacking of bases decreases flexibility of a polynucleotide and tends to produce a more extended, often helical, structure.

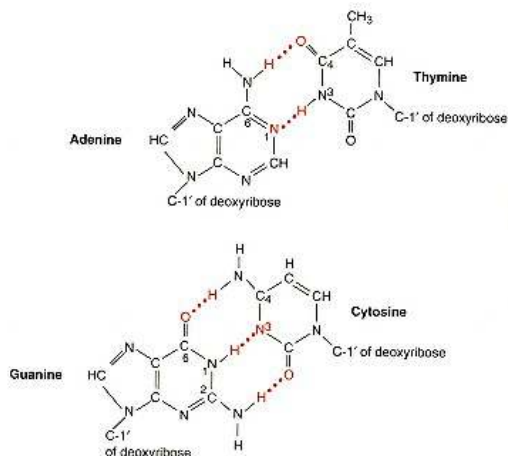

Figure 14.7
Formation of hydrogen bonds between complementary bases
in double-stranded DNA.

Interaction between polynucleotide strands is a highly selective process. Complementarity depends not only on the geometric factors that allow the proper fitting between the complementary bases of the two strands, but also on the electronic specificity of interaction between complementary bases. Thus specificity of interaction between purines and pyrimidines has also been noted both in solution and in the crystal form, and it is expressed in terms of strong hydrogen bonding between monomers of adenine and uracil or monomers of guanine and cytosine.

DNA Double Helix

Although some forms of cellular DNA exist as **single-stranded structures**, the most widespread DNA structure is the **double helix**. The double helix can be visualized as resulting from interwinding of two right-handed helical polynucleotide strands around a common axis. The two strands achieve contact through hydrogen bonds, which are formed at the hydrophilic edges of their bases. These bonds extend between purine residues in one strand and pyrimidine residues in the other, so that the two types of resulting pairs are always adenine–thymine and guanine–cytosine. A direct consequence of these hydrogen-bonding specificities is that double-stranded DNA contains equal amounts of purines and pyrimidines. Examination of space-filling models clearly indicates structural compatibility of these bases in forming linear hydrogen bonds.

This relationship between bases in the double helix is described as **complementarity**. Bases are complementary because every base of one strand is matched by a complementary hydrogen-bonding base on the other strand. For instance, for each adenine projecting toward the common axis of the double helix, a thymine must be projected from the opposite chain so as to fill exactly the space between strands by hydrogen bonding with adenine. Neither cytosine nor guanine fits precisely in the available space across from adenine in a manner that allows formation of hydrogen bonds across strands. These **hydrogen-bonding specificities** (Figure 14.7) ensure that the entire base sequence of one strand is complementary to that of the other strand.

The double helix exists in various geometries designated as **DNA A, B, and C**. Formation of these different **conformations** depends on the base composition of DNA and on physical conditions. These forms share certain common characteristics. Specifically, the phosphate backbones are always located on the outside of the helix. Also, because diesters of phosphoric acid are fully ionized at neutral pH, the exterior of the helix is negatively charged. Bases are well packed in the interior of the helix, where their faces are protected from contact with water. In this environment the strength of hydrogen bonds that connect bases can be maximized. Interwinding of two strands produces a structure having two helical grooves that separate the winding phosphate backbone ridge.

However, the precise **geometry of the double helix** varies among the

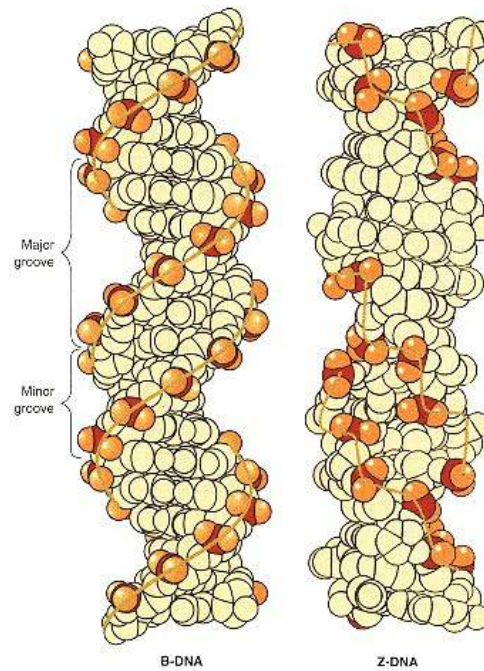

Figure 14.8

Space-filling molecular models of B- and Z-DNA.

The double helix is referred to as the Watson and Crick model, although this structure has been substantially refined since it was proposed. B-DNA may be the most typical form occurring in cells. Z-DNA may be present in cells as small stretches, consisting of alternating purines and pyrimidines, incorporated between long stretches of B-DNA. The zigzag nature of the Z-DNA backbone is illustrated by the heavy lines that connect phosphate residues along the chain.

Redrawn based on figure from Rich, A. *J. Biomol. Struct. Dyn.* 1:1, 1983.

different forms. The original X-ray data obtained with highly oriented DNA fibers suggested occurrence of a form, later designated as B, which appears to be that commonly found in solution and *in vivo* (Figure 14.8). A characteristic of this form is that one of its grooves is wider (**major groove**) than the other (**minor groove**). Disparity in width between these two grooves results from the characteristic geometry of base pairs (bp). Glycosidic bonds between sugars and bases of each base pair are not arranged directly opposite to one another. Instead the edge of the helix, that is more than 180° from glycosidic bond to glycosidic bond, is the edge that forms part of the major groove. Clearly, the opposite edge corresponds to the minor groove. The nucleotide sequence of a polynucleotides can be discerned without dissociating the double helix by looking inside these grooves. As each of the four bases has its own orientation with respect to the rest of the helix, each base always shows the same atoms through the grooves. C-6, N-7, and C-8 of the purine rings and C-4, C-5, and C-6 of the pyrimidine rings line up in the major groove. The minor groove is paved with C-2 and N-3 of the purine and C-2 of the pyrimidine rings. Forms A and C differ from B in the pitch of the base pairs relative to the helix axis as shown in Figure 14.9, as well as in other geometric parameters of the double helix, including conformation of sugar residues, which is one of the more flexible components of the DNA molecule. Alternative forms of the double helix are the result of **conformational variations** of the sugar-phosphate groups that form the backbone of constituent polynucleotides (Figure 14.10). The conformation of the furanose ring of sugar residues exists in nonplanar (puckered) forms. This ring may be visualized in the form of an envelope with four carbon atoms at the corner of the envelope. Oxygen is positioned at the

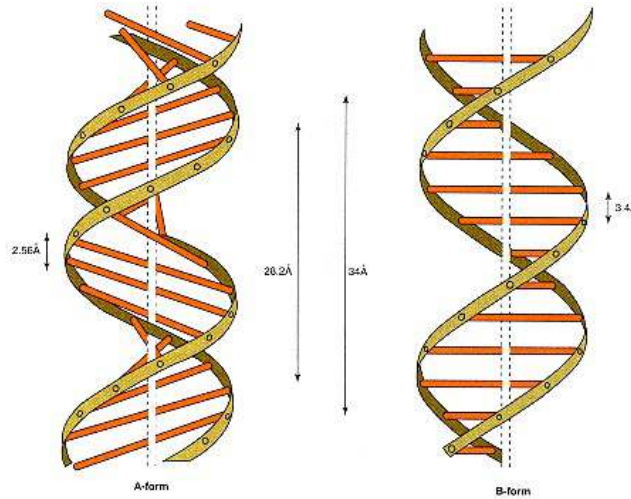

Figure 14.9
Various geometries of DNA double helix.

Depending on conditions, the double helix can acquire various forms of distinct geometries. In the B form of DNA the centers of the bases are about 34 Å apart and produce a complete turn of a helix with a pitch of 34 Å. Such an arrangement results in a complete turn of the helix for every 10 bp. The diameter of the helix is 20 Å. Form C (not shown) is very similar to the B structure, with a pitch of 33 Å and 9 bp per turn. Form A, which is obtained from form B when the relative humidity of the fiber is reduced to 75%, differs from B in that the base pairs are not perpendicular to the helical axis but are tilted. This tilt results in a pitch of 28.2 Å and a shortening of the helix by the packing of 11 pairs per helical turn.

Redrawn based on figure from Guschelbauer, W. *Nucleic Acid Structure*. Berlin: Springer-Verlag, 1976.

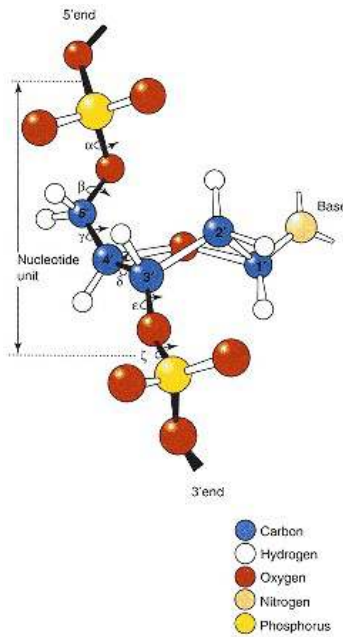

Figure 14.10
Structure of ribose-phosphate backbone of polynucleotides.

The polynucleotide backbone has six degrees of freedom on rotation along the bonds identified by Greek letters α to δ . However, steric hindrance and electrostatic repulsion between the oxygen atoms of the phosphate residue restrict the number of conformational variants that can be generated by rotation along some of these bonds. Rotation is particularly limited, but still possible, around the C-5-O bond (δ bond) and the C-3-C-4 bond (γ bond).

top of the envelope flap and therefore may bend out of the envelope body. The main body of the envelope may also be twisted. Twisting the C-2 and the C-3 atoms relative to the other atoms produces two distinct forms. C-2 twists up from the plane and results in the C-2 **endo** form. As a rule, atoms that are positioned on the same side of the plane as C-5 have by definition the **endo conformation**. The C-2 **endo** and C-3 **endo** are the most common conformers found in nucleic acids, while free nucleotides in solution are characterized by a rapid equilibrium between these conformers. Another variation in nucleic acid conformations arises from rotations about the C-1 *-N*-glycosidic bond that is responsible for variants known as **syn** and **anti** forms (see Figure 14.11). **Anti** conformations are the predominant forms in nucleic acids, while in free nucleotides in solution **syn-anti** equilibrium depends on the nature of the base. Generally, purine nucleotides are characterized by a rapid **syn-anti** equilibrium while pyrimidines usually adopt **anti** conformations.

Finally, conformational variations in DNA may result from relative orientations of the planes of the bases between strands. Differences in orientation between planes of H-bonded bases may produce double helix variants with different base **tilt**, **roll**, **twist**, or **propeller twist**. For example, DNA forms A and B differ drastically in base **tilt** and deviations of **tilt** and **roll** angles, occurring in phage tracts of adenine residues, are responsible for extensive bending of the double helix axis over certain functionally important regions of DNA. Under conditions of low salt concentration and humidity, the thin B-DNA double helix shifts to a conformation characterized by a thicker helix. In this conformation nucleotides move off center toward the major edge of each base pair, generating A-DNA, which has a narrower and deeper major groove and a wider and shallower minor groove than B-DNA. The parameters for these different DNA conformations, listed in Table 14.2, have been determined of DNA by X-ray diffraction methods. While the numbers provide very accurate information about molecular geometry and dimensions of crystalline samples, they give only average dimensions for monomeric units present in a noncrystalline macromolecule. Therefore these parameters are listed as such and the listing does not imply that the same geometry characterizes each and every individual base pair in DNA. Rather, depending on base sequence, considerable local variation in conformation of individual nucleotides may occur. Such varia-

TABLE 14.2 Structural Features of A-, B-, and Z-DNA

Features	A-DNA	B-DNA	Z-DNA
Helix rotation	Right-handed	Right-handed	Left-handed
Base pair per turn (crystal)	10.7	9.7	12
Base pair per turn (fiber)	11	10	—
Base pair per turn (solution)	—	10.5	—
Pitch per turn of helix	24.6 Å	33.2 Å	45.6 Å
Proportions	Short-end broad	Longer and thinner	Elongated and thin
Helix packing diameter	25.5 Å	23.7 Å	18.4 Å
Rise per base pair (crystal)	2.3 Å	3.3 Å	3.7
Rise per base pair (fiber)	2.6	3.4 Å	—
Base pair tilt	+19°	-1.2° (but varies)	-9°
Propeller twist	+18°	+16°	0°
Helix axis rotation	Major groove	Through base pairs	Minor groove
Sugar ring conformation (crystal)	C-3 <i>endo</i>	Variable	Alternating
Sugar ring conformation (fiber)	C-3 <i>endo</i>	C-2 <i>endo</i>	—
Glycosyl bond conformation	anti	anti	anti at C, syn at G

tions may be important in regulation of gene expression, since they influence the extent of DNA binding with various types of regulatory proteins.

A form of DNA, which was discovered more recently, has geometric characteristics radically different from those of conventional forms. In this DNA, called **Z-DNA**, the polynucleotide phosphodiester backbone assumes a "zigzag" arrangement rather than the smooth conformation that characterizes other double-stranded forms. The Z-DNA structure is longer and much thinner than that of B-DNA and completes one turn in 12 bp rather than the 10 bp in a B-DNA turn. It forms a single groove as opposed to two grooves that characterize B-DNA. Therefore the conformation of Z-DNA may be viewed as the result of the major groove of B-DNA having "popped out" in order to form the outer convex surface of Z-DNA. This change places the stacked bases on the outer part of Z-DNA rather than in their conventional positions in the interior of the double helix. Another highly unusual property of the Z structure is that it consists of left-handed rather than right-handed helices, which characterize conventional forms. These major structural differences between B-DNA and Z-DNA (Figure 14.8) are partly the result of different conformations in nucleotide residues between the two forms. Specifically, in B- and A-DNA sugars and bases are arranged in the extended **anti** conformation. In contrast, in Z-DNA some nucleotides rotate into **syn** conformation, which places the sugar and base on the same side of the glycosidic bond (Figure 14.11). DNA sequences that consist of alternating GC nucleotides are the most prone to acquire Z conformation, which places glycosidic bonds of each G in syn, with C residues maintaining the anti conformation. The zigzag arrangement of the phosphate backbone reflects sudden turns of the backbone, as it follows the alternating arrangement of syn and anti geometries.

The **biological function of Z-DNA** is not known with certainty. Some evidence exists suggesting that Z-DNA influences gene expression and regulation. Apparently small stretches of DNA approximately 12–24 bp long with the potential of forming Z-DNA are more commonly found at the 5' end of genes, that is, in regions that regulate transcriptional activities. These stretches consist of alternating purines and pyrimidines that favor formation of the Z conformation. Z-DNA may have a role in genetic recombination. Sites of genetic recombination in eukaryotic cells appear to be associated with DNA regions with the potential of Z-DNA formation. The Z form of DNA is stabilized by the presence of cations or polyamines and by methylation of either guanine residues in C-8 and N-7 positions or cytosine residues in C-5 position. Sequences that are not strictly alternating pu-pyr may also acquire the Z conformation as a result of methylation. For instance, the hexanucleotide m^5GATm^5CG , which contains two internal adjacent pairs of pu and py, forms Z-DNA. This outcome is not surprising because in Z-DNA hydrophobic methyl groups do not protrude unfavorably into the aqueous environment surrounding the double helix, as is the case with B-DNA. On this basis it might be expected that *in vivo* methylation of cytosine also induces a B → Z transition in cellular DNA. The suggestion that Z-DNA may have a role in gene regulation is supported by modification in methylation patterns that accompany the process of gene expression.

An important structural characteristic of double-stranded DNA is that its strands are **antiparallel**. Polynucleotides are asymmetric structures with an intrinsic sense of **polarity** built into them (Figure 14.12). The two strands are aligned in opposite directions; if two adjacent bases in the same strand, for example, thymine and cytosine, are connected in the 5' → 3' direction, their complementary bases adenine and guanine will be linked in the 3' → 5' direction (directions are defined by linking the 3' and 5' positions within the same nucleotide). This antiparallel alignment produces a stable association between strands to the exclusion of the alternate parallel arrangement.

The double-stranded structure of DNA was proposed in 1953, partly based on previously available X-ray diffraction studies suggesting that the structures

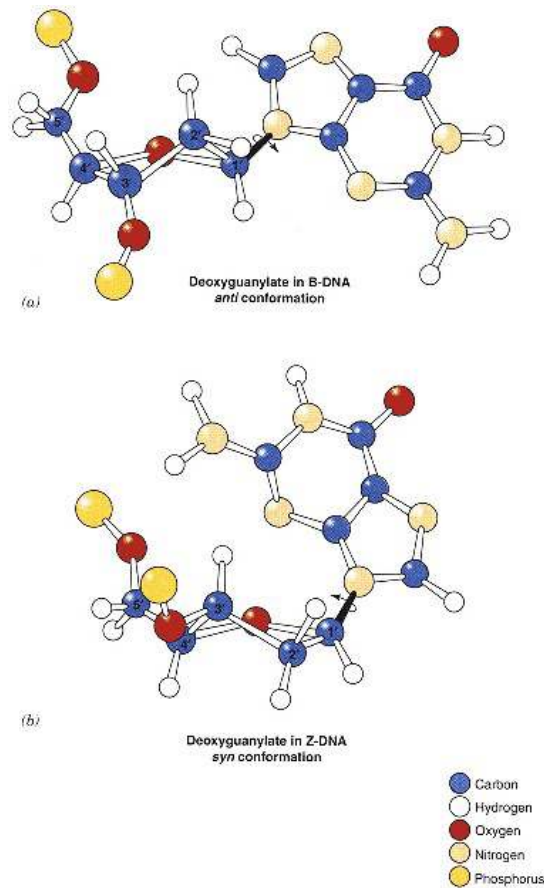

Figure 14.11
Conformational variants of nucleotides.

Rotation of the base plane around the C-1–N-9 glycosyl bond gives rise to two distinct nucleotide conformations, the so-called anti and syn conformations. The anti conformation is characteristic of B-DNA. In Z-DNA the glycosyl bond rotates as shown to give the syn conformation. The B → Z DNA transformation is also accompanied by a change in the conformation of the ribose ring from the C-2' endo to C-3' endo conformation.

of DNA from various sources exhibited remarkable similarities. These studies also suggested that DNA had a helical structure containing two or more polynucleotides. Evidence of central importance to the proposal was the clarification of the quantitative base composition of DNA, indicating the molar equivalence between purines and pyrimidines essential for the complementarity between the two strands.

Many Factors Stabilize DNA Structure

Factors that stabilize single-stranded polynucleotides—that is, **hydrophobic interactions** and **van der Waals forces**—are also instrumental in stabilizing the double helix. Van der Waals interactions generate attractive forces among atoms that are optimally situated, that is, neither too close nor too far apart

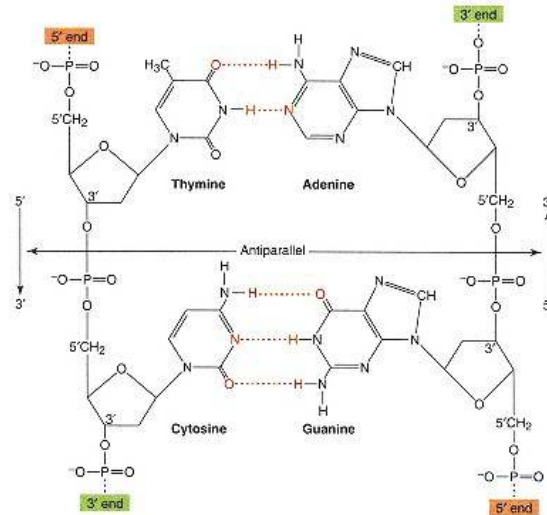

Figure 14.12

Antiparallel nature of DNA strands.

Note the opposite direction of the strands of a double-stranded DNA. The geometry of the helices does not prevent a parallel alignment, but such an arrangement is not found in DNA.

relative to one another, within a molecular structure. These forces are the result of **dipole–dipole interactions** and **London dispersion interactions** (transient dipole interactions) between adjacent bases. Hydrophobic interactions are also very important in stabilizing polynucleotide structures and especially the double helix. The separation between the hydrophobic core of the stacked bases and the hydrophilic exterior of the charged sugar–phosphate groups is even more striking in the double helix than with single-stranded helices. This explains the preponderance of the DNA double helix. The stacking tendency of single-stranded polynucleotides may be viewed as resulting from a tendency of the bases to avoid contact with water. The double-stranded helix is a more favorable arrangement, permitting the phosphate backbone to be highly solvated by water while the bases are essentially removed from the aqueous environment.

Collectively, hydrophobic and van der Waals forces are referred to as **stacking interactions** because they produce the stacked arrangement of the bases typical of the double helix. Stacking interactions are estimated to generate 4–15 kcal mol⁻¹ for each adjacent pair of stacked bases.

Additional stabilization of both single-stranded DNA as well as the double helix results from extensive networks of **cooperative hydrogen bonding**. Typically, hydrogen bonds are relatively weak (3–7 kcal mol⁻¹) and are even weaker in DNA (2–3 kcal mol⁻¹) because of geometric constraints within the double helix. Cumulatively, however, H bonds provide substantial energies of stabilization for the double helix although the stabilization is less than what is provided by stacking interactions. However, hydrogen bonding, in contrast to stacking forces, does not confer to any significant degree preferential stabilization to the double helix relative to its constituent single-stranded polynucleotides, which can form equally effective hydrogen bonds with water molecules in an aqueous environment.

Hydrogen bonds have important biochemical consequences for the functions in which the double helix participates. In contrast to stacking forces, hydrogen bonds are highly directional and are able to provide a discriminatory function for choosing between correct and incorrect base pairs. Because of

TABLE 14.3 Effects of Various Reagents on the Stability of the Double Helix^a

Reagent	Adenine Solubility × 10⁻³ (in 1 M reagent)	Molarity Producing 50% Denaturation
Ethylurea	22.5	0.60
Propionamide	22.5	0.62
Ethanol	17.7	1.2
Urea	17.7	1.0
Methanol	15.9	3.5
Formamide	15.4	1.9

Source: Data from Levine, L., Gordon, J., and Jencks, W. P. *Biochemistry* 2:168, 1963.

^a The destabilizing effect of the reagents listed below on the double helix is independent of the ability of these reagents to break hydrogen bonds. Rather, the destabilizing effect is determined by the solubility of adenine. Similar results would be expected if the solubilities of the other bases were examined.

their directionality, hydrogen bonds tend to orient the bases in a way that favors stacking. Therefore the contribution of hydrogen bonds is essential for the stability of the double helix.

The relative importance of hydrogen bonding and stacking forces in stabilizing the double helix was not always appreciated. The effects of various reagents on the stability of the double helix have suggested that the destabilizing effect of a reagent is not related to the ability of the reagent to break hydrogen bonds. Rather, the stability of the double helix is determined by the solubility of the free bases in the reagent, the stability decreasing as the solubility increases. Some of these findings, summarized in Table 14.3, emphasize the importance of hydrophobic forces in maintaining the structure of double-stranded DNA.

A direct consequence of the conclusion that the relative stability of the double helix versus the single-stranded DNA depends almost exclusively on stacking forces is that differences in the stabilities of various segments of the double helix reflect variabilities in the stacking energies of different base sequences. Indeed, a large degree of variability exists among the stacking energies of various pairs of stacked bases as shown in Table 14.4. As a rule, stacking interaction involving dimers of G-C base pairs are stronger than interactions between stacked dimers of A-T base pairs.

Ionic forces also have an effect on the stability and conformation of the double helix. At physiological pH, the electrostatic intrastrand repulsion between negatively charged phosphates is potentially destabilizing and it forces the double helix into a relatively rigid rod-like conformation. In addition, this repulsion tends to separate the complementary strands. In distilled water, DNA strands will separate at room temperature; near the physiological salt concentration, cations, particularly Mg²⁺ (in addition to other charged groups, e.g., the basic side chains of proteins), shield the phosphate groups and decrease repulsive forces. Therefore the flexibility of the double helix is partially restored and its stability is enhanced.

Denaturation

The double helix is disrupted during almost every important biological transformation in which DNA participates, including DNA replication, transcription, repair, and recombination. Therefore the forces that hold the two strands together are adequate for providing stability and yet weak enough to allow facile

TABLE 14.4 Base Pair Stacking Energies

Dinucleotide Base Pairs	Stacking Energies (kcal mol⁻¹ per stacked pair)^a
(GC) · (GC)	-14.59
(AC) · (GT)	-10.51
(TC) · (GA)	- 9.81
(CG) · (CG)	- 9.69
(GG) · (CC)	- 8.26
(AT) · (AT)	- 6.57
(TG) · (CA)	- 6.57
(AG) · (CT)	- 6.78
(AA) · (TT)	- 5.37
(TA) · (TA)	- 3.82

^a Data from Ornstein, R. L., Reim, R., Breen, D. L., and Mc Elroy, R. D. *Biopolymers* 17:2341, 1978.

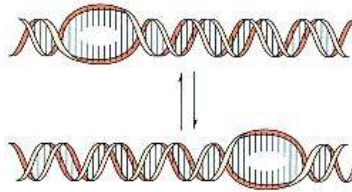

Figure 14.13
"Zipper" model for DNA double helix.
 DNA contains short sections of
 open-strandedness that can "move" up
 and down the helix.

strand separation. In fact, the double helix is stabilized relative to the single strands by about 1 kcal per base pair. Therefore a relatively minor perturbation can produce disruption in double strandedness, provided that only a short section of the DNA is involved. As soon as the relatively few base pairs have separated, they close up again and release free energy, and then the adjacent base pairs unwind. In this manner minor disruptions of double strandedness can be propagated along the length of the double helix. Thus, at any particular moment, the large majority of the bases of the double helix remain hydrogen bonded, but all bases can pass through the single-stranded state, a few at a time. This **dynamic state** of the double helix is characterized by the movement of an "open-stranded" portion up and down the length of the helix, as indicated in Figure 14.13. The "dynamic" nature of this structure is an essential prerequisite for the biological functions of DNA as it undergoes repair or recombination.

Separation of DNA strands can be studied by increasing the temperature in solution. At relatively low temperatures a few base pairs will be disrupted, creating one or more "open-stranded bubbles." These "bubbles" form initially in sections that contain relatively higher proportions of adenine and thymine pairs because of the lower stacking energies of dimers of such pairs. As the temperature is raised, the size of the "bubbles" increases and eventually the thermal motion of the polynucleotides overcomes the forces that stabilize the double helix. This transformation is depicted in Figure 14.14. At even higher temperatures the strands separate physically and acquire a random-coil conformation (Figure 14.15). The process is most appropriately described as a **helix-to-coil transition**, but it is commonly called **denaturation**. This is accompanied by a number of physical changes, including a buoyant density increase, reduction in viscosity, change in ability to rotate polarized light, and changes in absorbancy.

Changes in absorbance are frequently used to follow the process of denaturation experimentally. DNA absorbs in the UV region due to the heterocyclic aromatic nature of its purine and pyrimidine constituents. Although each base has a unique absorption spectrum, all bases exhibit maxima at or near 260 nm. This property is responsible for the absorption of DNA at 260 nm. However,

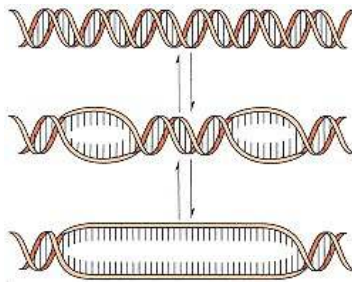

Figure 14.14
Structure of double-stranded DNA at increasing temperatures.
 Disruptions of the double-stranded structure appear first in regions of relatively high adenine–thymine content. The size of these "bubbles" increases with increasing temperatures, leading to extensive disruptions in the structure of the double helix at elevated temperatures.

this absorbancy can be as much as 40% lower than that expected from adding up the absorbancy of each of the base components of DNA. This property of DNA, referred to as **hypochromic effect**, results from the stacking of the bases along the DNA helices. In this arrangement, interactions between the π electrons of neighboring bases produce a decrease in absorbancy. However, as the ordered structure of the double helix is disrupted at increasing temperatures, stacking interactions are gradually decreased. Therefore a totally disordered polynucleotide approaches an absorbance not very different from the sum of the absorbancies of its purine and pyrimidine constituents.

Slow heating of double-stranded DNA in solution is accompanied by a gradual change in absorbancy as the strands separate. However, since the interactions between the two strands are cooperative, the transition from double-stranded to random-coil conformation occurs over a narrow range of temperatures, as indicated in Figure 14.16. Before the rise of the **melting curve**, DNA is double stranded. In the rising section of the curve an increasing number of base pairs are interrupted as the temperature rises. Strand separation occurs at a critical temperature corresponding to the upper plateau of the curve. However, if the temperature is decreased before the complete separation of the strands, the native structure is completely restored.

The **midpoint temperature**, T_m , of this process, under standard conditions of concentration and ionic strength, is characteristic of the base content of each DNA. The higher the guanine–cytosine content, the higher the transition temperature between the double-stranded helix and the single strands. This difference in T_m values is attributed to the increased stability of guanine–cytosine pairs, as a result of the higher stacking interactions between dimers of G–C pairs relative to the dimers of A–T pairs.

Rapid cooling of a heated DNA solution normally produces denatured DNA, a structure that results from the reformation of some hydrogen bonds either between the separate strands or between different sections of the same strand. The latter must contain complementary base sequences. By and large denatured DNA is a disordered structure containing substantial amounts of **random-coil** and single-stranded regions.

DNA can also be denatured at a pH above 11.3 as the charge on several substituents on the rings of the bases is changed, preventing these groups from participating in hydrogen bonding. **Alkaline denaturation** is often used as an experimental tool in preference to heat denaturation to prevent breakage of phosphodiester bonds that can occur to some degree at high temperatures or low pH. Denaturation can also be induced at low ionic strengths, because of enhanced interstrand repulsion between negatively charged phosphates, as well as by various denaturing reagents, that is, compounds that weaken or break

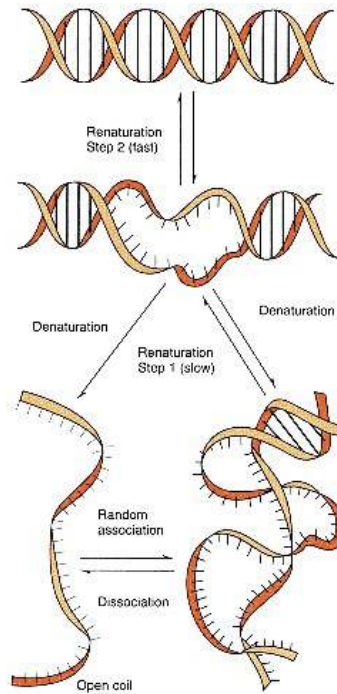

Figure 14.15
Denaturation of DNA.

At high temperatures the double-stranded structure of DNA is completely disrupted, with the eventual separation of the strands and the formation of single-stranded open coils. Denaturation also occurs at extreme pH ranges or at extreme ionic strengths.

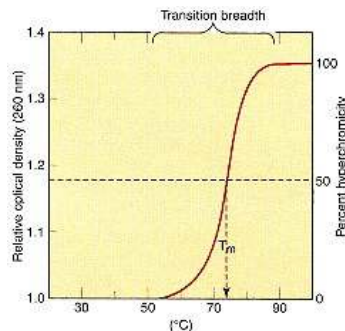

Figure 14.16

Temperature–optical density profile for DNA.

When DNA is heated, the optical density increases with rising temperature. A graph in which optical density versus temperature is plotted is called a "melting curve." Relative optical density is the ratio of the optical density at the temperature indicated to that at 25°C. The temperature at which one-half of the maximum optical density is reached is the midpoint temperature (T_m).

Redrawn based on figure from Freifelder, D. *The DNA Molecule: Structure and Properties*. San Francisco: Freeman, 1978.

hydrogen bonds. A complete denaturation curve similar to that shown in Figure 14.16 can be obtained at a relatively low constant temperature, for instance, room temperature, by variation of the concentration of an added denaturant.

Renaturation

Complementary DNA strands, separated by denaturation, can reform a double helix if appropriately treated. This is called **renaturation** or **reannealing**. If denaturation is not complete and only a few bases remain hydrogen bonded between the two strands, the helix-to-coil transition is rapidly reversible. **Annealing** is possible even after the complementary strands have been completely separated. Under these conditions the renaturation process depends on the meeting of complementary DNA strands in an exact manner that can lead to the reformation of the original structure, and it is a slow, concentration-dependent process. As a rule, maintaining DNA at 10–15°C below its T_m , under conditions of moderate ionic strength (0.15 M), provides the maximum opportunity for renaturation. At lower salt concentrations, the charged phosphate groups repel one another and prevent the strands from associating. As renaturation begins, some of the hydrogen bonds formed are extended between short tracts of polynucleotides that might have been distant in the original native structure. Renaturation is facilitated by the presence of short sequences, consisting of four to six base pairs, reiterated many times within every DNA strand. A large number of much longer nucleotide sequences are repeated many times within the eukaryotic genome. Such sequences provide sites for initial base pairing that produces a partially hydrogen-bonded double helix. These randomly base-paired structures are short-lived because the bases that surround the short complementary segments cannot pair and lead to the formation of a stable fully hydrogen-bonded structure. However, once the correct bases begin to pair by chance, the double helix over the entire DNA molecule is rapidly reformed. Renaturation is a two-step process. The first step determines the rate of association, involves the chance meeting of two complementary sequences on different strands, and is therefore a second-order reaction. The rate of renaturation is thus proportional to the product of the concentrations of the two homologous dissociated strands and is expressed as $dt/dc = -kc^2$, where k is the rate constant for the association. Integration of this equation gives $C/C_0 = 1/(1 + kC_0t)$, where C is the concentration of single-stranded DNA expressed as moles of nucleotide per liter at time t , and C_0 is the concentration of DNA at time zero. A plot of C/C_0 (which is proportional to DNA that is single stranded or of the DNA fraction that is reassociated) versus C_0t can be constructed (Figure 14.17), and a $C_0t_{0.5}$ (**Cot-a-half**) value, which corresponds to $C/C_0 = 0.5$ can be determined. The $C_0t_{0.5}$ value is proportional to the complexity of the genome. **Complexity** is equal to the molecular mass of the genome provided that the genome consists of unique nucleotide sequences. For example, both the complexity and molecular mass of a hypothetical genome consisting of three unique nucleotide sequences that may be represented as N_1 , N_2 , and N_3 is equal to the sum $N_1 + N_2 + N_3$. However, in eukaryotic genomes, which contain both unique as well as reiterated sequences, the complexity of the genome is significantly lower than the molecular mass. If, for instance, a eukaryotic genome contains 10^5 copies of sequence N_3 , 10^3 copies of sequence N_2 , and 1 copy of sequence N_1 , the complexity will still be $N_1 + N_2 + N_3$ but the molecular mass will be equal to $10^5N_3 + 10^3N_2 + N_1$. Thus complexity may be defined as the minimum length of DNA that contains a single complete copy of all the single and **reiterated sequences** that are represented within the genome.

The C_0t curves of eukaryotic genomes with reiterated DNA segments show several kinetic components, each representing those parts that have similar reiteration frequencies (Figure 14.18). Highly reiterated sequences will reassociate the fastest; unique sequences are the slowest. Thus C_0t curves provide information on **genome complexity**, on the number of **repetitive classes**,

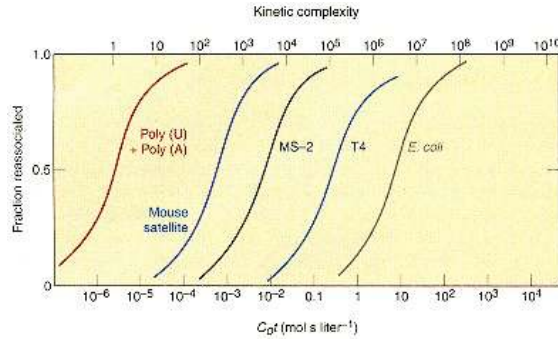
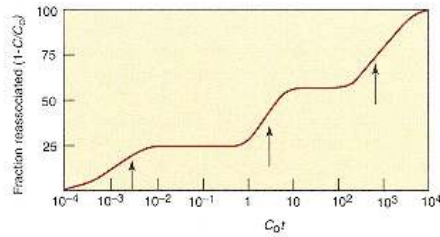

Figure 14.17

Reassociation kinetics for DNA isolated from various sources.

Each DNA is first fragmented to segments of approximately 400 nucleotides. The denatured segments are subsequently allowed to renature. The fraction of each poly-nucleotide reassociated, calculated from changes in hypochromicity, is plotted against the total concentration of nucleotides multiplied by the renaturation time (C_0t). The top scale shows the kinetic complexity of each DNA sample. Whenever a DNA contains reiterated sequences, these sequences are present in the fragments at higher concentrations than they would have been if a unique sequence had been fragmented. As a result, renaturation of fragments, obtained from DNAs containing reiterated sequences, proceeds more rapidly the higher the degree of repetition. This is exemplified by the rates of renaturation of fragments obtained from the synthetic double-stranded polynucleotide poly(A)-poly(U) and mouse satellite DNA, a DNA that contains many repeated sequences. For a homogeneous DNA, which contains a distribution of different extents of reiterated sequences, kinetic complexity can be defined as the minimum length of DNA needed to contain a whole single copy of the reiterated sequence.

Based on figure in Britten, R. J., and Kohne, D. E. *Science* 161:529, 1968.



	Fast Component	Intermediate Component	Slow Component
Percent of genome	25	30	45
$C_0t_{1/2}$	0.0013	1.9	630
Complexity, bp	340	6.0×10^5	3.0×10^8
Repetition frequency	500,000	350	1

Figure 14.18

Reassociation kinetics of eukaryotic DNA.

This idealized $C_0t_{1/2}$ plot represents a eukaryotic DNA that consists of three distinct components with three different C_0t values. The percentage to which each one of these components is present in the DNA can be read from the ordinate (fraction-reassociated axis) of the z figure. Repetition frequencies and complexities are calculated based on the principles discussed in the text. In practice, the experimental separation of different DNA components is not as pronounced and their identification not as clear-cut as shown in this hypothetical example.

and on the proportion of the total genome represented by those classes. Since most genes occur only once within a genome, separation of DNA into different repetitive classes facilitates the search for individual genes by narrowing the search within the single copy component of DNA.

Hybridization

Self-association of complementary polynucleotide strands has provided the basis for development of the technique of **hybridization**. This depends on the association between two polynucleotide chains, which may be of the same or of different origin or length, provided that a base complementarity exists between these chains. Hybridization can take place not only between DNA chains but also between complementary RNA chains as well as DNA–RNA combinations.

Appropriate techniques have been developed for measuring the maximum amount of polynucleotide that can be hybridized as well as the rates of hybridization. These techniques are important basic tools of contemporary molecular biology and are being used for the following: (1) determining whether or not a certain sequence occurs more than once in the DNA of a particular organism, (2) demonstrating a genetic or evolutionary relatedness between different organisms, (3) determining the number of genes transcribed in a particular mRNA (clearly DNA–RNA hybridizations are needed for accomplishing the last goal), and (4) determining the location of any given DNA sequence by annealing with a complementary polynucleotide, called a **probe**, that is appropriately tagged for easy detection of the hybrid.

DNA to be tested for hybridization is denatured. The resulting single strands are immobilized by binding to a suitable polymer, which is then used to pack a chromatography column. DNA formed in the presence of labeled precursors, usually tritiated thymidine, is allowed to run through the column that contains the bound, unlabeled DNA. The rate at which radioactivity is retained by the column equals the rate of annealing between complementary strands.

Determination of the maximum amount of DNA that can be hybridized can establish homologies between DNA of different species since the base sequences in each organism are unique. On this basis annealing can be used to compare the degree to which DNAs isolated from different species are related to one another. The observed homologies serve as indexes of **evolutionary relatedness** and have been particularly useful for defining phylogenies in prokaryotes. Hybridization studies between DNA and RNA have, in addition, provided very useful information about the biological role of DNA, particularly the mechanism of transcription.

Hybridization techniques using membrane filters, usually made of nitrocellulose, have found increasing application. In general, hybridization can be quantitated by either measuring the amount of hybrid in equilibrium or the rate of hybrid formation under conditions in which one nucleic acid is present in large excess. The approach used for the latter determination is analogous to the C_0t procedure and when it is used for DNA–RNA hybridization and RNA is present in excess it is referred to as the **R_0t method**, or the **D_0t method** when DNA is in excess.

A variant of filter hybridization, known as the **Southern transfer**, can be used for identifying the location of specific genes (see p. 774). Since a gene sequence represents a very small percentage of total DNA, the gene must be separated from the remaining DNA and the DNA detected by using appropriate probes. Another variation of hybridization known as ***in situ* hybridization** uses intact DNA molecules within metaphase chromosomes. The chromosomes are spread on slides and subjected to denaturation and then exposed to a probe labeled with a fluorescent molecule. The DNA sequence of interest is located by observation with a fluorescence microscope.

DNA Probes

Probes are short single-stranded RNA or DNA oligonucleotides that are complementary to specific sequences of interest in genomic DNA. Under proper conditions probes interact only with a segment of interest, indicating whether the segment is present in a particular sample of DNA. Probes synthesized by chemical means may appear to be limited by the degree to which the desired genomic nucleotide sequence is known, but in fact this approach has much wider applicability. As an example, if the protein product of a gene is known, the nucleotide sequence of the desired gene can be approximated by using a mixture of different synthetic oligonucleotides that represent alternate mRNA sequences that, because of degeneracy of the code, can encode for the same protein. One of these oligonucleotide sequences is therefore complementary to the desired gene. When the gene of interest is transcribed to mRNA molecules that are abundant and easily purified, mRNA can be used. Probes need to be at least 15 nucleotides long because shorter sequences may occur randomly along genomic DNA. To achieve easy detection, probes are labeled by the incorporation of ^{32}P or are identified by the use of biotin-containing nucleotides that are incorporated into the probe and serve as fluorescent labels. Probes are useful for definitive and rapid diagnosis of genetic disorders, infectious disease, and cancer as described briefly in Clin. Corr. 14.2.

Heteroduplexes

Hybridization is the basis for a technique that has permitted construction of precise physical maps of DNA genes. This technique depends on direct visualization under the electron microscope of single-stranded loops in the structures of artificially formed double-stranded DNA molecules known as **heteroduplexes** constructed by hybridization of two complementary DNA strands. One strand is selected on the basis that, as the result of a known mutation, it misses the

CLINICAL CORRELATION 14.2

Diagnostic Use of Probes in Medicine

A probe is a molecule with a strong affinity for a specific target, which can easily be detected after its interaction with the target. The specificity of DNA probes is based on interaction between complementary polynucleotide strands. Probes can be obtained by amplification of naturally occurring DNA sequences or by chemical synthesis. Use of DNA-based techniques is becoming increasingly important in laboratory diagnosis of many genetic diseases and certain types of cancers. The method is used selectively in diagnosis of bacterial infections for bacteria that are slow growing or difficult to identify by conventional culture-base methods, such as bacteria causing Lyme disease (*Borrelia burgdorferi*), certain types of syphilis (*Treponema pallidum*), or pneumonia (*Chlamydia pneumoniae*). In addition, DNA probes are indispensable for identification of bacteria that are extremely difficult or impossible to grow in culture, such as organisms responsible for Leprosy (*Mycobacterium leprae*) and Whipple's disease (*Tropheryma whippellii*). DNA-based techniques also have the potential to provide faster, more versatile, and less expensive diagnostic applications for detection of more common bacterial infections. Hybridization procedures generally begin with amplification of target DNA (bacterial DNA) by cloning or more commonly by a technique known as the polymerase chain reaction (PCR). The probe hybridized with target DNA is typically detected by the Southern blot technique.

Probes are very useful for identification of mutant alleles responsible for genetic diseases, especially if the mutations are stable and few in number. Some genetic disorders are due to mutations in a single gene and in some instances appear to correlate well with a particular phenotype or symptom. Detection of mutations can be of diagnostic value. One approach used for direct identification of mutations involves hybridization with an allele-specific probe (ASP). Examples of diseases diagnosed by probes are sickle cell anemia, hemoglobin C disease, and phenylketonuria. The first two are the result of a single base change in genes coding for β -globin. By using three different probes, corresponding to the sequence of normal and two mutated hemoglobins, the presence of mutated β -globin genes can be detected. Similarly, a probe can identify a mutation in the phenylalanine 4-monooxygenase gene that is responsible for phenylketonuria. Many other genetic diseases, including cystic fibrosis, Gaucher's disease, β -thalassemia, and Tay-Sachs disease, can be diagnosed using DNA-based techniques.

Keller, G. H., and Manak, M. M. *DNA Probes*. New York: Stockton Press, 1993.

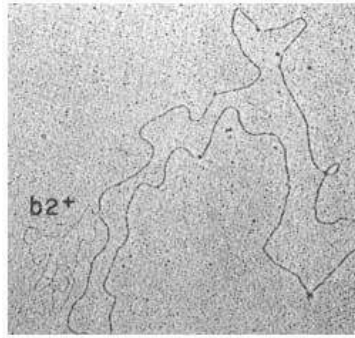

Figure 14.19
Heteroduplex formation in bacteriophage.
 Electron micrograph of a heteroduplex DNA molecule constructed from complementary strands of bacteriophage and a bacteriophage deletion mutant (bacteriophage b2). In b2 a segment of DNA has been deleted, producing, at the site of deletion, a loop labeled b2+. Reprinted with permission from Westmoreland, B. C., Szybalski, W., and Ris, H. *Science* 163:1343, 1969. Copyright © 1969 by the American Association for the Advancement of Science.

gene being mapped. As shown in Figure 14.19, the complementary strands of the heteroduplex pair perfectly throughout the length of the molecule except that across from the position of the missing gene in the mutant strand the complementary strand forms a visible loop. The position of the loop identifies the location of the deleted gene.

14.3— Types of DNA Structure

Only the essential features common to all DNAs have been presented so far. The specific structural features of DNA vary, depending on the origin and function of each DNA molecule. Molecules of DNA differ in size, conformation, and topology.

Size of DNA Is Highly Variable

The length of DNA varies from a few thousand base pairs for DNA of the small viruses, to millions for chromosomal DNA of bacteria, and to billions for the chromosomal DNA of animals. DNA size can be expressed as number of base pairs, molecular mass, the length of the strands, and even the actual mass of DNA. The units used in these expressions, however, can easily be interconverted, since a DNA of mol wt 1×10^6 contains approximately 1500 bp and is 0.5 nm long. DNA mass can be converted to molecular mass by division with the average molecular mass of a DNA nucleotide pair.

The amount of DNA per cell increases as the complexity of the cellular function increases (Table 14.5). Although mammalian cells contain some of the

TABLE 14.5 DNA Cell Content of Some Species

Type of Cell	Organism	DNA per Cell (pg) ^a
Phage	T4	2.4×10^{-4}
Bacterium	<i>E. coli</i>	4.4×10^{-3}
Fungus	<i>N. crassa</i>	1.7×10^{-2}
Avian erythrocyte	Chicken	2.5
Mammalian leukocyte	Human	3.4

Source: From Lewin, B. *Gene Expression*, Vol. 2, 2nd ed. New York: Wiley, 1980, p. 958.

^a pg, picograms.

highest amounts of DNA per cell, some amphibian, fish, and plant cells may contain even higher amounts. In fact, lung fish cells contain more than 40 times the amount of DNA in human cells, but such extraordinary amounts of DNA reflect a **reiteration of nucleotide sequences** within the DNA macromolecule and do not represent an actual increase in the size of DNA in terms of unique sequences, that is, **DNA complexity**. The size of the DNA of higher cells is very large indeed. The DNA contained within a single human cell is packaged in the form of 46 chromatin fibers or chromosomes. In its most condensed state, that is, during metaphase, the largest of these chromosomes is about 10 μm . If the DNA packaged within this chromosome were stretched out in the conventional B-DNA form, it would be over 8 cm long, that is, 8000 times longer than it is when packed within the chromosome. This suggests that the polynucleotides are exquisitely packed in order to fit within the minute dimensions of the cell nucleus.

Because of their extraordinary length, relative to the total mass, DNA molecules are extremely sensitive to shearing forces that develop during ordinary laboratory manipulations. Even careful pipetting may shear a DNA molecule. During the process of isolation it is difficult to prevent with absolute confidence the disruption of some phosphodiester bonds by contaminating endonucleases (nicking). For these reasons the precise size of DNA of higher species could not be determined until special handling techniques were developed, both for the isolation of DNA and the measurement of its molecular mass.

Techniques for Determining DNA Size

Classical methods for determining size in proteins proved to be unsuitable for measuring the molecular mass of even relatively small DNAs. Custom-tailored methods were devised. **Equilibrium centrifugation** in a density gradient (usually a concentrated cesium chloride solution), **electron microscopy**, and **electrophoresis** in agarose gels are among the principal methods providing reliable information about the molecular masses of DNAs. Electron microscopy provides a measure of the length of DNA strands. Molecular masses can be calculated from known values of the mass per unit length. The DNA can be visualized under the electron microscope if it is first coated with protein and a metal film. Determination of molecular masses by electrophoresis depends on the molecular sieving effect of porous agarose gels. Over a limited range of molecular masses the mobility of DNA is directly proportional to the logarithm of the molecule's weight.

To determine the molecular mass of DNA by equilibrium centrifugation a small portion of a DNA solution to be analyzed is layered on top of a gradient in a centrifuge tube. Upon centrifugation, the molecules of DNA sediment to equilibrium through the gradient. Under these conditions a homogeneous high molecular mass DNA will form a Gaussian band centered at a position in the gradient that corresponds to the density of the DNA. Molecules with different densities are resolved into a series of bands that sediment independently of one another, as shown in Figure 14.20. A relationship can be demonstrated between the width of the bands at equilibrium and the molecular masses.

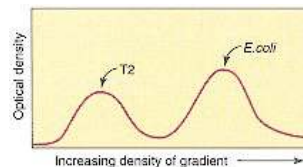

Figure 14.20
Equilibrium gradient centrifugation of DNA.
 The DNA macromolecules travel into the increasingly dense regions of the gradient driven by centrifugal forces. The macromolecules equilibrate as soon as they reach an area of the gradient of density equal to their own. For example, bacteriophage T2 DNA and *E. coli* DNA can be resolved into two distinct bands. The width of the bands at equilibrium is related to the molecular weight of DNA.

Labeling of the terminals of DNA has been used successfully for determining molecular masses. DNA is treated with the enzyme alkaline phosphatase, which converts the 5'-phosphate nucleotide terminals of double-stranded DNA to the corresponding OH groups. These terminals are then esterified, using [γ - ^{32}P]ATP with the enzyme polynucleotide kinase. The free 5' terminus of each polynucleotide chain becomes labeled as shown in Figure 14.21. The labeled DNA is then analyzed by **zonal centrifugation** and detected from both its absorbancy at 260 nm and ^{32}P content (Figure 14.22). The molecular mass is calculated from the ratio of the amount of ^{32}P to the absorbancy, both measured at the coinciding peaks of the bands.

Gel electrophoresis (see page 773) has replaced electron microscopy and

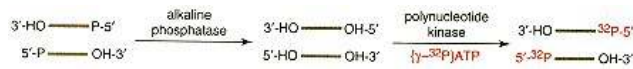

Figure 14.21
End-group labeling procedure.

The 5' terminals on the opposite ends of DNA are labeled with ^{32}P by treatment with alkaline phosphatase and esterification of the resulting 5'-hydroxyl groups with ATP.

centrifugation-based methods for the routine determination of DNA molecular weights. The above methods have permitted determination of DNA molecular masses with an accuracy of at least 10%, but the usefulness of each method is limited within certain molecular mass ranges. Electrophoresis is most suitable between 7.5×10^5 and 1.5×10^7 . Electron microscopy is useful for up to 2×10^8 molecular mass. The most versatile method is equilibrium centrifugation, the range of which extends between 2×10^5 and 10^9 .

DNA May Be Linear or Circular

DNAs of several small viruses are linear double-stranded helices of equal size. Some DNAs have naturally occurring interior single-stranded breaks. The breaks found in natural bacteriophage molecules result mostly from broken phosphodiester bonds, although occasionally a deoxyribonucleoside may be missing. DNA of coliphage T5 consists of one intact strand and a complementary strand, which is really four well-defined complementary fragments ordered perfectly along the intact strand. A similar regularity in the points of strand breaks is noted, for example, in *Pseudomonas aeruginosa* phage B3, but generally interior breaks seem to be randomly distributed. The double helix structure is maintained because the breaks in one strand are generally in different locations from breaks in the complementary strand.

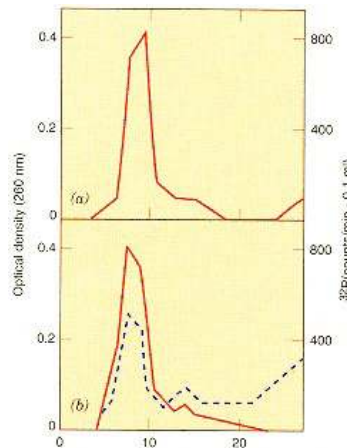

Figure 14.22
Zonal centrifugation profiles of denatured T7 DNA treated by the end-group labeling procedure.

Sedimentation is from right to left.

(a) Untreated DNA.

(b) DNA treated by the end-group labeling procedure. Zonal centrifugation is performed on a sucrose density gradient and should be distinguished from density gradient centrifugation. The latter is an equilibrium centrifugation with the macromolecules reaching equilibrium at regions within the tube at which their density equals the density of the environment. With zonal centrifugation the macromolecules move continuously until they reach the bottom of the tube or until the centrifuge is stopped.

The molecular mass is calculated from the ratio of ^{32}P (dotted line) to optical density (solid line) at the peak of the curve. Redrawn from Richardson, C. C. *J. Mol. Biol.* 15:49, 1966.

Double-Stranded Circles

Most naturally occurring DNAs exist in circular form. In some instances **circular DNA** exists as **interlocked circles** or **catenates**. Provided that suitable precautions are taken to avoid shearing the DNA, the circular form can be isolated intact and observed by electron microscopy. The circular structure results from the circularization of a linear DNA by formation of a phosphodiester bond between the 3' and 5' terminals of a linear polynucleotide. Circular structures present many advantages for chromosomal DNA, protecting it from the action of exonucleases and facilitating the process of DNA replication.

The circular nature of small phage ϕX174 DNA was suspected from studies showing that no ends were available for reactions with exonucleases. Sedimentation studies also revealed that endonuclease cleavage yielded one rather than two polynucleotides. These suspicions were later confirmed by direct observation with electron microscopy.

After the circular nature of the DNA chromosome of *E. coli* was demonstrated, it became apparent that many other DNAs (e.g., those of mitochondria, chloroplasts, bacterial plasmids, and mammalian viruses) also existed as closed circles. Obviously, the strands of a circular DNA cannot be irreversibly separated by denaturation because they exist as intertwined closed circles. The absence of 3' or 5' termini provides an evolutionary advantage because it endows the circular DNA with complete resistance toward exonucleases, which ensures the longevity of DNA.

DNA of some bacteriophages exists in a linear double-stranded form that circularizes when it enters the host cell. The linear DNA of bacteriophage λ of *E. coli*, for instance, has single-stranded 5' terminals consisting of 20 nucleotides each. These have complementary sequences, so that an open circle structure

can be formed when the linear molecule acquires a circular shape, which allows the overlap of these complementary sequences. Subsequently, the enzyme DNA ligase, which forms phosphodiester bonds between properly aligned polynucleotides, joins the 3- and 5-terminal residues of each strand and forms a covalently closed circle (Figure 14.23).

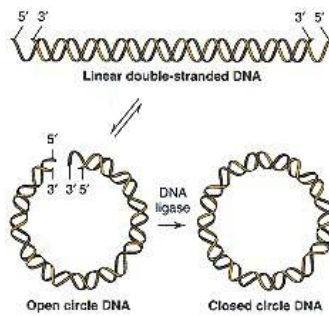

Figure 14.23

Circularization of λ DNA.

The DNA of bacteriophage λ exists in both linear and circular forms, which are interconvertible. The circularization of λ DNA is possible because of the complementary nature of the single-stranded 5' terminals of the linear form.

Single-Stranded DNA

With the exception of a few small bacteriophages (e.g., ϕ X174 and G4) that can acquire a single-stranded form, most circular and linear DNAs exist as double-stranded helices. The single-stranded nature of the nonreplicative form of ϕ X174 DNA was suspected when it was discovered that the base composition of this DNA did not conform to the base equivalence rules; that is, A did not equal T and G did not equal C.

Circular DNA Is a Superhelix

Double-stranded circular DNA, with few exceptions, has an intriguing **topology**. The circular structure contains twists, referred to as **supercoils**, which are visualized by electron microscopy. In principle, linear DNA could be converted to a circular molecule. Circular DNA may be formed by bringing together, and joining by a phosphodiester bond, the free terminals of linear DNA. If no other manipulations are introduced, the resulting circular DNA will be **relaxed**; that is, it will have a thermodynamically favored structure of the linear double helix (B-DNA), which accommodates one complete turn of the helix for approximately 10 base pairs. However, if before sealing the circle, one DNA terminus is held steady while the other terminus is rotated in a direction that unwinds the double helix, the resulting structure will be strained. This strained structure, which is characterized by a deficit of turns, is known as **negative superhelical DNA** (Figure 14.24). Negatively supercoiled DNA is underwound in that it has fewer helical turns than what the molecule would accommodate as a linear or as a relaxed structure. The underwinding results in participation of more base pairs per helical turn, which produces a decrease in the angle of twist between adjacent base pairs. Therefore underwinding generates **torsional tension**. Torsional strain increases the standard free energy of DNA by about 10 kcal mol⁻¹ per each supercoil that is introduced into the structure. The strain produced by this deficit of turns is accommodated by the disruption of hydrogen bonds

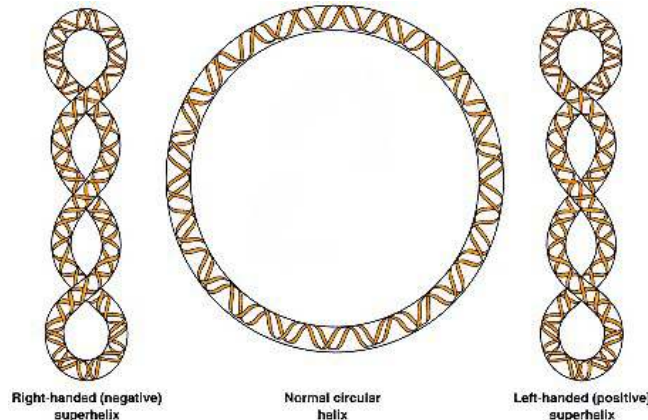

Figure 14.24

Relaxed and supercoiled DNA.

Relaxed DNA can be converted to either right- or left-handed superhelical DNA. Right-handed DNA (negatively supercoiled DNA) is the form normally present in cells. Left-handed DNA may also be transiently generated as DNA is subjected to enzymatically catalyzed transformations (replication, recombination, etc.) and it is also present stably in certain bacterial species. The distinctly different patterns of folding for right- and left-handed DNA are apparent in this representation of the two types of superhelices.

Redrawn from Darnell, J., Lodish, H., and Baltimore, D. *Molecular Cell Biology*. New York: Freeman, 1986.

and the opening of the double helix over a small region of the macromolecular structure. The resulting structure may be viewed as consisting of a small-stranded loop along with regions of regularly spaced double helical turns with a geometry similar to relaxed B-DNA. If, however, hydrogen bonds are not disrupted, the circular DNA will twist in a direction opposite to the one in which it was rotated initially in order to relieve the strain induced by the unwinding. Thus the rotational strain that was introduced before the circularization of DNA can be accommodated either by the disruption of H bonding or by the formation of tertiary structures with visible supercoils (Figure 14.25). These two representations of the negative superhelix should be viewed as two manifestations of the same underlying phenomenon. In general, a dynamically imposed compromise, determined by the environment and the status of circular DNA, is reached between hydrogen-bond disruption and supertwisting. In practice, this means that supercoiled DNA may consist of twisted structures with enhanced tendency to generate regions with disrupted hydrogen bonding (bubbles).

In a circular DNA that is initially relaxed, the transient strand unwinding would tend to introduce compensating supertwists. However, if DNA is superhelical to begin with, the density of the superhelix will obviously tend to fluctuate with the "breathing" of the helix. All naturally occurring DNA molecules contain a deficit of helical turns; that is, they exist as negative superhelices with a superhelical density that remains remarkably constant among different DNAs. Normally one negative twist is found for every 20 turns of the helix.

If one of the terminals of the linear polynucleotides is rotated in the direction of **overwinding** rather than **unwinding** the double helix, the resulting DNA will contain positive superhelices. While negatively superhelical DNA can accommodate unwinding stress either by unwinding (accompanied by the interruption of hydrogen bonds) or by formation of negative superhelices, the only available option for overwound DNA is to accommodate the stress by acquiring positive superhelices. Positive supercoils can be generated by specialized enzymes, the **topoisomerases**, and may be present transiently **in vivo** but are rarely present in cellular DNA.

Positive and negative supercoils can, in principle, coexist transiently within the same DNA molecule. Yet the DNA molecule, in an overall sense, may be viewed as relaxed because it may return to a relaxed state without the breaking of phosphodiester bonds. A rubber band, which in its normal unstrained form

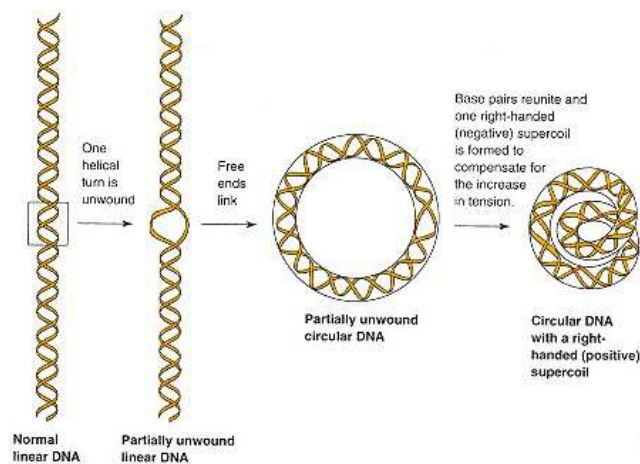

Figure 14.25

Right-handed (negative) DNA supercoiling.

Right-handed supercoils (negatively supercoiled DNA) are formed if relaxed DNA is partially unwound. Unwinding may lead to a disruption of hydrogen bonds or alternatively produce negative supercoils. The negative supercoils are formed to compensate for the increase in tension that is generated when disrupted base pairs are reformed.

Redrawn from Darnell, J., Lodish, H., and Baltimore, D. *Molecular Cell Biology*. New York: Freeman, W. H. 1986.

might be visualized as a circular relaxed structure (without supercoils), can be used as such a model (Figure 14.26). Grasping this band firmly at opposite sides and twisting one side of the band generates a structure characterized by two topological domains, with twisting of opposite handedness, that are clearly visible when the two sides are pulled apart. If the opposite sides are brought back close together, each domain becomes supertwisted; that is, each domain generates a supercoil. This requires an input of energy since the supertwisted state does not represent the low-energy state of the rubber band. When the band is released from the grasping that restrains rotation, it may return to its original relaxed configuration. During these manipulations, the physical structure of the band has remained intact. A difference between the rubber band model and cellular DNA is that the latter exists almost exclusively in supercoiled form. Cellular DNA can be described on the basis of the linking number of DNA, L , an integer number defined as the number of times one strand appears to cross over the other when the DNA structure is projected onto a flat surface (Figure 14.27). Examination of Figure 14.27a further indicates that the linking number of relaxed DNA (B-DNA), L_0 , can be defined as

$$L_0 = \frac{N}{10.5}$$

where N is the number of base pairs and 10.5 refers to the **average helical repeat**, that is, the number of base pairs per one complete turn of the helix.

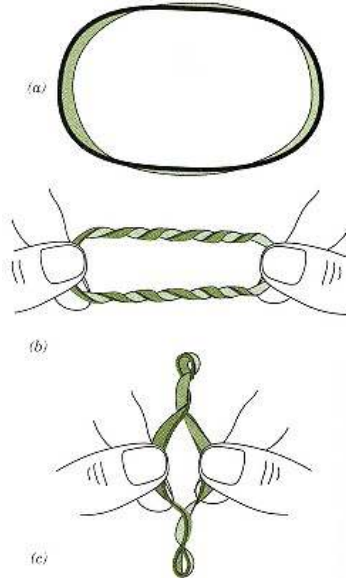

Figure 14.26 Superhelical model for DNA.

A rubber band represents the topological properties of double-stranded circular DNA. The relaxed form of the band, shown in (a), has been twisted to generate two distinct domains, separated by the pair of "thumb-forefinger anchors," as shown in (b). Left-handed (counterclockwise) turns have been introduced into the upper section of the band, with compensating right-handed (clockwise) turns present into the bottom section. When the "anchors" are brought into close proximity with each other as shown in (c), the upper section that contained the left-handed turns forms a right-handed superhelix. The bottom section produces a left-handed superhelix. Clearly, superhelicity is not the property of a DNA molecule as a whole but rather a property of specific DNA domains.

Redrawn from Sinden, R. R., and Wells, R. D. DNA structure, mutations, and human genetic disease. *Curr. Opin. Biotech.* 3:612, 1992.

Geometric Description of Superhelical DNA

Conformations acquired by interlocking rings of a closed circular DNA can formally be characterized by three parameters: **linking number, L , number of helical turns or twist, T , and number of supercoils or writhing number, W** . These parameters are related by the equation $L = T + W$. The nature of T and W is self-explanatory.

Two important conclusions can be reached from consideration of these definitions and from examination of Figure 14.28. First, it is apparent that for

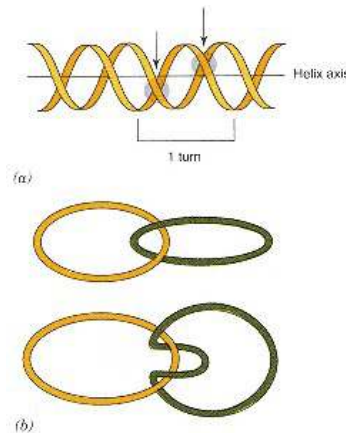

Figure 14.27 Determination of the linking number L in superhelical DNA.

- (a) Side view of a schematic representation of the double helix. Note that the strands cross twice for each turn of the helix.
- (b) DNA circles interwound once and twice. Note that each pair of crossings is equivalent to one interwind.

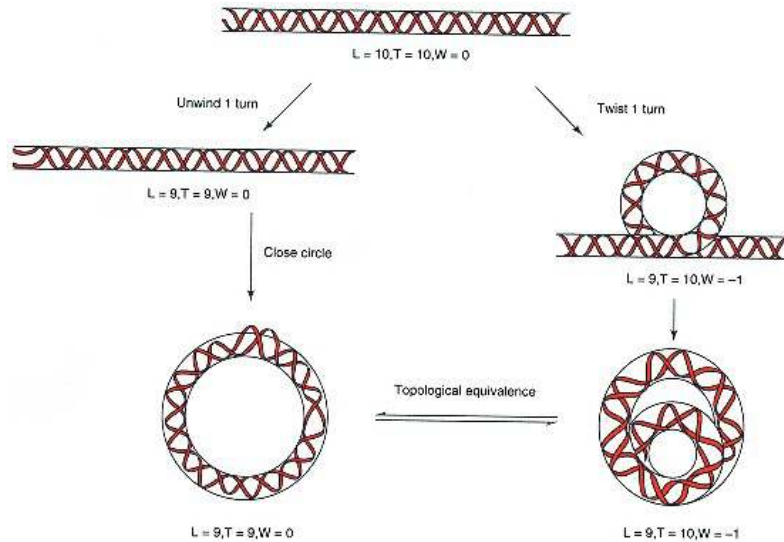

Figure 14.28

Various types of DNA superhelices.

An accurate representation of superhelical DNA structures can be made, using the number of helical turns or twists, T , and the number of supercoils or writing number, W , along with a third parameter the linking number, L , as defined in the text. The figure shows ways of introducing one supercoil into a DNA segment of 10 duplex turns and the parameters of the resulting superhelices.

Redrawn with permission from Cantor, C. R., and Schimmel, P. R., *Biophysical Chemistry, Part III*. San Francisco: Freeman, 1980. Copyright © 1980.

every relaxed DNA the linking number L and the number of helical turns T are identical. However, as will be apparent shortly, the reverse is not true. Second, DNAs with a specific linking number can acquire various different topological conformations. Different types of supertwists (T) may be formed. However, all conformations with the same linking number are interconvertible without breaking any covalent bonds. Therefore linking number is a constant for any covalently closed circular DNA.

Various forms of supercoiled DNAs can be described using L , T , and W numbers. The mental exercise shown in Figure 14.28 illustrates how these numbers apply. It should be recalled that the turns of the typical double helix are right handed. Therefore, if a hypothetical linear DNA duplex that is 10 turns long ($L = 10$ and $T = 10$) is unwound by, say, one turn, the resulting structure will have the following characteristics: $L = 9$ and $T = 9$. A potentially equivalent structure can be formed if instead ends of the same hypothetical DNA are secured so that they cannot rotate and the molecule is looped in a counterclockwise manner. Since in this case untwisting is not permitted to occur, the number of helical turns remains unchanged; that is, $T = 10$. However, as a result of "looping" operations, linking number is now reduced by 1; that is, $L = 9$. The structure resulting from this deliberate introduction of a loop is visibly superhelical. Furthermore, application of the equation that relates values of L , T , and W indicates that W must be equal to -1 ; that is, the structure is a negative superhelix with one supertwist.

The two structures described above— $L = 9, T = 9, W = 0$ and $L = 9, T = 10, W = -1$ —obviously have the same linking number and are therefore interconvertible without the disruption of any phosphodiester bonds. The potential equivalence of these two types of structure becomes more apparent when ends of polynucleotides in each structure are joined into a circle without strands being allowed to rotate. Circularization produces an **interwound** circular structure (a number 8-shaped structure referred to as a **plectonemic coil**) or a doughnut-shaped superhelical arrangement referred to as a **toroidal turn**, both of which are freely interconvertible. An interwound turn, shown in Figure 14.29, can be produced by unfolding a toroidal turn along an axis that is distinct from the supercoil axis.

In summary, if the termini of a linear DNA molecule are covalently attached, a "relaxed" covalent circle results. However, if one end of the double helix is maintained in a fixed and stationary position while the other end is rotated in either direction prior to closing the circle, the resulting structure will twist in the opposite direction so as to generate a supertwisted helical structure. For each additional complete turn of the helix, DNA will acquire one more superhelical twist in the opposite direction of rotation in order to relieve intensifying strain. As a result, topologically equivalent structures, such as those shown in Figure 14.28, will be created. A real superhelical DNA exists as an equilibrium among these forms and many other intermediate arrangements in space that have the same linking number but different numbers of helical turns and supertwists. Although linking number is a constant and an integer, the number of twists can change in positive and negative increments, which are compensated by negative and positive changes in the writhing number. DNA supercoils are distributed in part as mixtures of interwound (plectonemic) and toroidal coils and as decreases in twist angle of the double helix. The interwound form is by far the more predominant structure for supercoiled DNA. In solution about 70% of the deficiency in linking numbers may be distributed as writhe change and 30% as changes in twist.

Although the closed circular form of DNA is an ideal candidate for acquiring a superhelical structure, any segment of double-stranded DNA that is in some way immobilized at both of its terminals qualifies for superhelicity. This property therefore is not the exclusive province of circular DNA. Rather, any appropriately anchored linear DNA molecule can acquire a superhelical conformation. The DNA of animal cells, for instance, normally associated with nuclear proteins, falls into this category. Animal DNA can acquire a superhelical form because its association with nuclear proteins creates numerous closed topological domains. A topological domain is defined as a DNA segment contained in a manner that restrains rotation of the double helix. In addition, circular DNAs of most bacterial phages, animal viruses, bacterial plasmids, and cell organelles, such as mitochondria and chloroplasts, contain superhelical DNAs. Existence

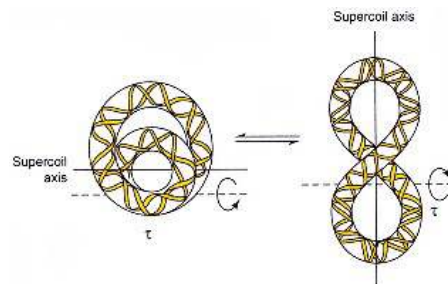

Figure 14.29

Equilibrium between two equivalent supercoiled forms of DNA.

The forms shown are freely interconvertible by unfolding the doughnut-shaped toroidal form along an axis parallel to the supercoil axis or by folding the number 8-shaped interwound form along an axis perpendicular to the supercoil axis. The two forms have the same W , T , and L numbers.

Redrawn with permission from Cantor, C. R., and Schimmel, P. R. *Biophysical Chemistry, Part III*. San Francisco: Freeman, 1980. Copyright © 1980.

of negative superhelicity appears to be an important factor, promoting packaging of DNA within the confines of the cell because supercoils facilitate formation of compact structures. For instance, while the length of DNA in each human chromosome is of the order of centimeters, condensed mitotic chromosomes that contain this DNA are only a few nanometers long. Negative superhelicity may also be instrumental in facilitating the process of localized DNA strand separation during DNA repair, synthesis, and recombination.

Topoisomerases

Specific enzymes known as **topoisomerases** appear to regulate the formation of superhelices. These enzymes change the linking number, L , of DNA. Topoisomerases act by catalyzing the concerted breakage and rejoining of DNA strands, which produces a DNA that is more or less superhelical than the original DNA. Topoisomerases are classified into type I, which break only one strand, and type II, which break both strands of DNA simultaneously. **Topoisomerases I** act by making a transient single-strand break in a supercoiled DNA duplex, which changes the linking number by increments of 1 and results in relaxation of the supercoiled DNA (Figure 14.30). **Topoisomerases II** act by binding to a DNA molecule in a manner that generates two supercoiled loops, as shown in step 1 of Figure 14.31. Since one of these loops is positive and the other negative, and there is no disruption of phosphodiester bonds, the overall linking number of the DNA remains unchanged. In subsequent steps, however, the enzyme nicks both strands and passes one DNA segment through this break before resealing it. This manipulation inverts the sign of the positive supercoil, resulting in the introduction of two negative supercoils in each catalytic step and the changing of the linking number in increments of 2. This reaction occurs at the expense of ATP; that is, topoisomerases II are ATPases. Several well-studied topoisomerases are listed in Table 14.6.

Although all type II topoisomerases can change the linking number of DNA, their individual properties vary considerably. A subset of type II topoisomerases (the **gyrases**—isolated from bacteria) are the only enzymes that introduce negative supercoils into relaxed DNA. Analogous eukaryotic topoisomerases have not been found. Apparently eukaryotes use alternative approaches for the

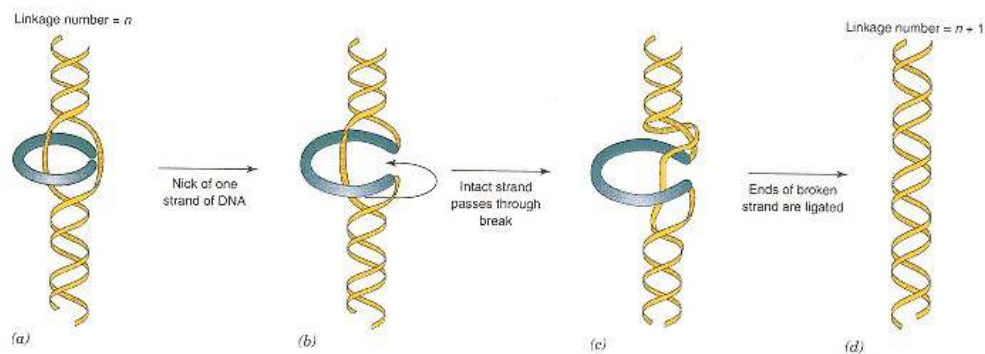

Figure 14.30
Mechanism of action of topoisomerases I.

Topoisomerases I can

- (a) relax DNA by (a) first binding to it and locally separating the complementary polynucleotide strands; subsequently
 - (b) nick one of the strands;
 - (c) bind to the newly generated termini and prevent these termini from rotating freely; and
 - (d) ligate the intact strand through the gap generated by the nick, close the gap by restoring the phosphodiester bond, and give rise to a relaxed structure.
- Redrawn from Dean, F., et al. *Cold Spring Harbor Symp. Quant. Biol.* 47:773, 1982.

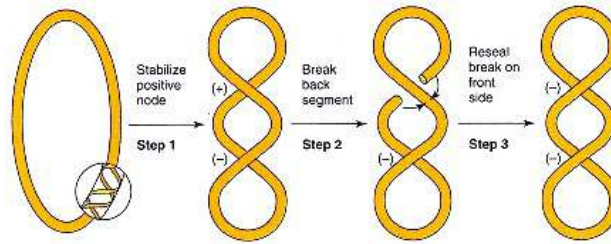

Figure 14.31
Mechanism of action of topoisomerases II.

Topoisomerases II (and gyrase) change the linking number of DNA by binding to a DNA molecule and passing one DNA segment through a reversible break formed at a different segment of the same DNA molecule. The mechanism of action of gyrase is illustrated above using as an example the conversion of a relaxed DNA molecule to a molecule that contains first two supercoils, one positive and one negative (step 1). Passage of a DNA segment through the positive supercoil shown on the right most part of the figure (step 3) changes the linking number, producing a molecule that contains two negative supercoils.

Redrawn with permission from Brown, P. O., and Cozzarelli, N. R. *Science* 206:1081, 1979.

Copyright © 1979 by the American Association for the Advancement of Science.

introduction of negative supercoils into DNA. The wrapping of DNA around chromosomal proteins followed by the action of eukaryotic topoisomerases that relax DNA may be used by eukaryotes for the generation of negative supercoiling. Bacterial type III topoisomerases are a class of topoisomerases with type I topoisomerase properties; that is, they can relax supercoils without the requirement of an energy source, such as ATP hydrolysis. These topoisomerases may specialize in the resolution of circular DNA products (catenates) that are generated just prior to the completion of DNA replication. An unusual class of topoisomerases, **reverse gyrases**, have been isolated from various species of archaebacteria. Remarkably, these gyrases introduce **positive supercoils** into DNA. Positive supercoiling may protect DNA from the denaturing conditions of high temperature and acidity under which these bacteria "exist."

TABLE 14.6 Properties of DNA Topoisomerases

Enzyme	Type ^a	ΔL	Activities
<i>E. coli</i> topoisomerase I (<i>top A</i>) ^b	I	Increase L $L = 1$	Relaxes negatively supercoiled DNA
Eukaryotic topoisomerase I from yeast (<i>top I</i>)	I	Increase or decrease L $L = \pm 1$	Relaxes either positively or negatively supercoiled DNA
<i>E. coli</i> topoisomerase II or DNA gyrase (<i>gyrA</i> , <i>gyrB</i>)	II	Increase or decrease L $L = \pm 2$	Introduces negative supercoiling to DNA; relaxes either positively or negatively supercoiled DNA
<i>E. coli</i> topoisomerase IV (<i>parC</i> , <i>parE</i>)	II	Increase L $L = +2$	DNA relaxing activity; it cannot introduce negative supercoils
Eukaryotic topoisomerase II from yeast (<i>top 2</i>)	II	Increase or decrease L $L = \pm 2$	Relaxes positively or negatively supercoiled DNA
<i>E. coli</i> topoisomerase III (<i>top B</i>)	I	Increase L $L = +1$	Relaxes negatively supercoiled DNA; decatenation activity
Eukaryotic topoisomerase III (<i>top 3</i>)	I	Increase L $L = +1$	Specific activity on DNA with single-stranded heteroduplex

^a Type I topoisomerases use Mg^{2+} as cofactor but do not use ATP. Type II topoisomerases require Mg^{2+} plus ATP.

^b The name of the gene coding for the topoisomerase is shown in parentheses.

Apparently, the energy released by ATP hydrolysis is used for restoring topoisomerase II conformation, after the enzyme has catalyzed the formation of 1 mol equiv of product. The reaction is inhibited by the antibiotics **nalidixic acid** and **novobiocin**. Derivatives of nalidixic acid are used clinically in the treatment of infections caused by bacteria resistant to other more commonly used antibiotics. Various compounds that inhibit topoisomerases are also effective antitumor agents (see Clin. Corr. 14.3).

During the reaction, topoisomerases remain bound to DNA by a covalent bond between a tyrosyl residue and a phosphoryl group at the incision site (a 5-phosphotyrosine bond). This enzyme–polynucleotide bond conserves the energy of the interrupted phosphodiester bond for the subsequent repair of the nick. The cleavage sites do not consist of unique nucleotide sequences, although certain sequences are preferentially found at cleavage sites. Gyrase, isolated from *E. coli*, is a tetrameric protein consisting of two A subunits and two B subunits. It adds negative supercoils to DNA at a rate of about 100 per minute. Topoisomerases regulate the level of supercoiling. In *E. coli* DNA such regulation requires the involvement of both gyrase and topoisomerase I activities. The balance between these two opposing enzymic activities keeps DNA at a precisely regulated cellular level of superhelicity. The ATP to ADP ratio may play a role in this process, since this ratio influences the activity of gyrase.

Other biological reactions involving DNA require participation of topoisomerases. For example, topoisomerase IV, a type II topoisomerase, may be essential for separating two circular chromosomes that become entangled by **catenation** toward the end of replication. Also, topoisomerases are involved in relaxing

CLINICAL CORRELATION 14.3

Topoisomerases in Treatment of Cancer

Topoisomerases are emerging as important targets of both antimicrobial and antineoplastic agents including camptothecin, anthracycline, and amino-acridine. These agents share a common principal mechanism of action by interfering with the enzyme-catalyzed rejoining of DNA strands, in effect inhibiting only one of the two substeps in the mechanism of action of topoisomerases. Therefore topoisomerase drugs do not act by inhibiting the overall activity of the enzyme, as is the case with most enzyme-targeting drugs. Instead, they convert topoisomerases into "DNA-breaking agents." The DNA degradation that follows leads to cell death.

Both topoisomerases I and II can be targeted with therapeutic results. Camptothecin and its derivatives modify the function of topoisomerase I. An excellent correlation has been noted between antitumor activity of various camptothecin derivatives on murine leukemia and their interference with topoisomerase activity. Camptothecins may cause potentially lethal lesions in cells in the form of drug-stabilized covalent DNA cleavage complexes. Subsequent DNA replication may be a prerequisite for cell toxicity. Increased levels of topoisomerase I found in advanced stages of colon cancer and several other human malignancies may contribute to the therapeutic efficacy of 9-amino-20(*RS*) and 10,11-methylenedioxy-20(*RS*), two camptothecin derivatives. In clinical trials these camptothecins appear to induce long-term remissions from single-agent treatment of colon cancer xenografts.

Studies with two other potent antineoplastic agents—an acridine derivative, 4 (9-acridinylamino)methanesulfon-*m*-anisidide (m-AMSA), and epipodophyllotoxin topoiside—that act selectively on topoisomerases II indicate that these clinically useful drugs stabilize covalent topoisomerase II–DNA cleavage complexes by interfering with the enzyme-mediated DNA religation reaction. Indirect evidence also suggests that these drugs may stimulate formation of these complexes. Contrary to observations regarding the importance of DNA replication in the expression of the cytotoxic effect of drugs that target topoisomerase I, topoisomerase II-mediated DNA breaks can exert their cytotoxic effect in the absence of ongoing DNA synthesis. Instead, the lethal lesions induced by topoisomerase II-targeted drugs may be dependent on recombinations and mutations at sites of formation of drug-induced topoisomerase II–DNA complexes. Many anticancer agents including anthracyclines (including adriamycin and doxorubicin), synthetic intercalators, ellipticines, and podophyllotoxins exert their therapeutic effects on topoisomerases II. Hematologic neoplasms, such as lymphoid and nonlymphoid leukemias, high-grade non-Hodgkin's lymphomas, and Hodgkin's disease, are treated mostly with combinations of one or more topoisomerase II inhibitors with or without additional cytotoxic agents.

Potmesil, M., and Kohn, K. W. (Eds.). *DNA Topoisomerases in Cancer*. New York: Oxford University Press, 1991; and Ellis, A. L., Nowak, B., Plunkett, W., and Zwelling, L. A. Quantification of topoisomerase–DNA complexes in leukemia cells from patients undergoing therapy with a topoisomerase directed agent. *Cancer Chemother. Pharmacol.* 34:249, 1994.

the superhelical tension generated by the separation of DNA strands during the process of transcription.

Separation of superhelical DNA from the relaxed or linear forms can be achieved by gel electrophoresis or by equilibrium centrifugation. With the latter method separation is achieved because the density of supercoiled DNA differs from that of the relaxed forms.

Alternative DNA Conformations

Conformational variants of DNA—that is, A-, B-, and Z-DNA—are associated mainly with variation in the conformation of the nucleotide constituents of DNA. It is now recognized that DNA is not a straight, stable, monotonous, and uniform structure. Instead, DNA forms unusual structures such as **cruciforms** or **triple-stranded** arrangements and bends as it interacts with certain proteins. Such variations in DNA conformation appear to be an important recurring theme in the process of molecular recognition of DNA by proteins and enzymes. Variations in DNA structure or conformation are favored by specific motifs in the sequence of DNA referred to as **defined, ordered sequence DNA** and are abbreviated as **dos DNA**. They include such DNA elements as **inverted repeats, mirror repeats, direct repeats, homopurine–homopyrimidine sequences, phased A tracts, and G-rich regions**. AT-rich sequences prone to easy strand separation exist near the origins of DNA replication. The human genome is rich in homopurine–homopyrimidine sequences and alternating purine–pyrimidine tracts. DNA bending, slipped DNA, cruciform formation, triplex DNA, and **quadruplex** arrangements are among the structures reviewed in this section.

DNA Bending

DNA sequences with runs of 4 to 6 A bases phased by 10-bp spacers produce bend conformations. **DNA bending** appears to be a fundamental element in the interaction between DNA sequences and proteins that catalyze central processes, such as replication, transcription, and site-specific recombination. Bending induced by interactions of DNA with enzymes and other proteins, such as histones, does not require the exacting nucleotide sequence conditions that are needed for bending of protein-free DNA. Bending also occurs because of photochemical damage and serves as a recognition signal for the initiation of DNA repair. Contrary to the bending effect generated by phased A tracts, the presence of poly A tracts without spacers or the presence of certain arrangements of polypurine–polypyrimidine tracts may generate a DNA, known as **anisomorphic DNA**, that is less flexible than usual.

Cruciform DNA

Dos DNA is generally present within noncoding DNA regions and it consists of various symmetry elements, including **inverted repeats**, completely **symmetrical inverted repeats**, known as *palindromes* (see p. 610), **mirror repeats**, and **direct repeats** as shown in Figure 14.32. Base pairing can be disrupted and conformational variants of DNA such as **junctions, cruciforms, triplex, and quadruplex DNA** and **slipped mispaired** structures can be formed within the **dos** sequences.

The biological function of cruciforms has not been generally established. Inverted repeats are quite widespread within the human genome and are often found near putative control regions of genes or at origins of DNA replication. It is therefore speculated that inverted repeats may function as molecular switches for replication and transcription. In fact, in a few instances there is evidence to support the involvement of cruciforms in the control of replication and transcription. The disruption of H bonds between the complementary strands and the formation of intrastrand H bonds within the region of the inverted

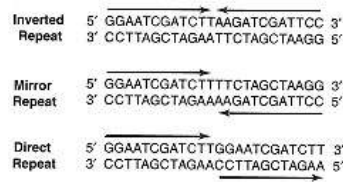

Figure 14.32
Symmetry elements of DNA sequences.

Three types of symmetry elements for double-stranded DNA sequences are shown. Arrows illustrate the special relationship of these elements in each one of these sequences. In inverted repeats, also referred to as palindromes, each single DNA strand is self-complementary within the inverted region that contains the symmetry elements. A mirror repeat is characterized by the presence of identical base pairs equidistant from a center of symmetry within the DNA segment. Direct repeats are regions of DNA in which a particular sequence is repeated. The repeats need not be adjacent to one another.

repeat produce a cruciform structure (Figure 14.33). The loops generated by cruciform formation require the unstacking of 3–4 unpaired bases at the end of the "hairpin" and therefore cruciform formation requires the expenditure of cellular energy.

Triple-Stranded DNA

Many sequences in the human genome, especially in regions involved in gene regulation, have the potential to form triple-stranded DNA structures. Such

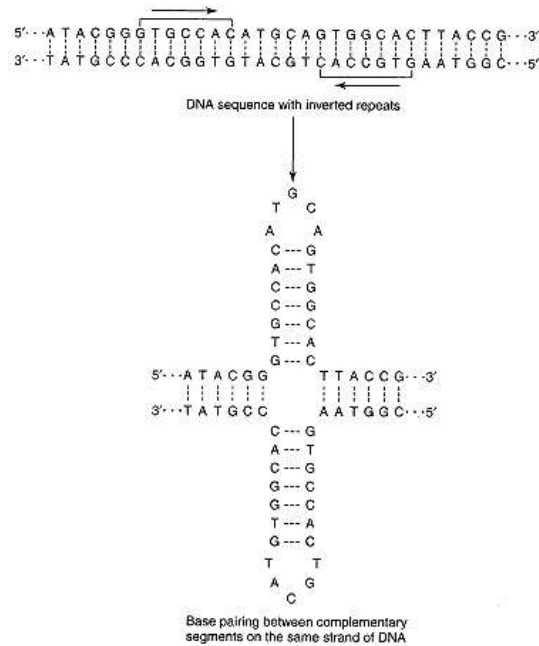

Figure 14.33
Formation of cruciform structures in DNA.

The existence of inverted repeats in double-stranded DNA is a necessary but not a sufficient condition for the formation of cruciform structures. In relaxed DNA, cruciforms are not likely to form because the linear DNA accommodates more hydrogen-bonded stacked base pairs than the cruciform structure, making the formation of the latter thermodynamically unfavored. Unwinding is followed by intrastrand hydrogen bond formation between the two symmetrical parts of the repeat to produce the cruciform structure. Formation of cruciform structures is not favored over DNA regions that consist of mirror repeats because such cruciforms would be constructed from parallel rather than antiparallel DNA strands. Instead, certain mirror repeats tend to form triple helices.

structures can be formed either within the same DNA structure (i.e., intramolecularly) or between DNA and a distinct or second polynucleotide (i.e., intermolecularly). In either case, **triple-stranded DNA** structures are formed, with few exceptions, in DNA regions characterized by the presence of a continuous string of purine bases, that is, **homopurine–homopyrimidine regions**. Such regions occur with frequencies much higher than expected from probability considerations alone. Polypurine tracts over 25 nucleotides long constitute as much as 0.5% of some eukaryotic genomes. Polypurine–polypyrimidine regions appear to have a multiplicity of potential biological roles, including possible effects in transcription control, in the initiation of replication, as replication terminators, as enhancers of stability at the ends of chromosomes (telomeres), and as initiators of genetic recombination.

Triple-stranded DNA is generated by the hydrogen bonding of a third strand into the major groove of B-DNA (Figure 14.34). Since base pairs are already formed in the B-DNA, the third strand forms hydrogen bonds with another surface of the double helix through so-called **Hoogsteen pairs**. The options available for the formation of a triple-stranded structure are limited to only four triplet bases—TAT, CGC, GGC, and AAT. The structure of two of these triplets is shown in Figure 14.35. Since pyrimidine does not have two H-bonding surfaces with more than one H bond, it follows that the central strand of the triplex must always be purine rich. Therefore, in practice, intermolecular triple-stranded DNA can only form within homopurine–homopyrimidine regions of DNA. Just as is the case for the Watson–Crick base pairs, formed between strands in double-stranded DNA, a polypurine–polypyrimidine region defines a unique third strand pairing sequence. Consequently, the sequence of a third strand can be designed so that it can form Hoogsteen base pairs with any specific polypurine–polypyrimidine region of DNA.

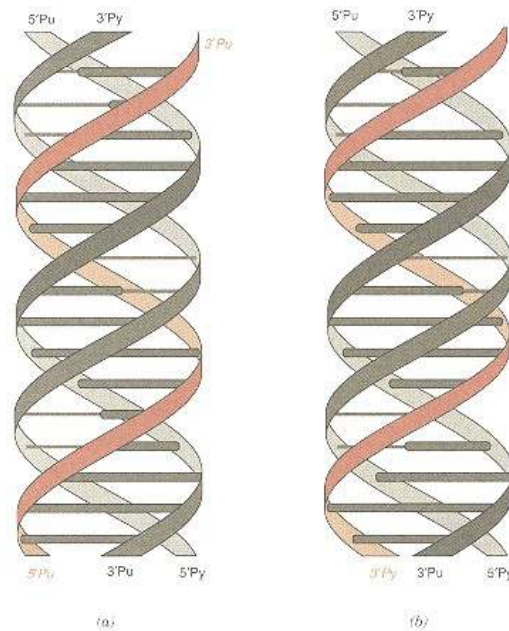

Figure 14.34

Structure of intermolecular triple helices.

Triple helices can form among

(a) two polypurine strands and one polypyrimidine strand as exemplified by the polyG–polyG–polyC triplet or

(b) among two polypyrimidine and one polypurine strand as in the case of the polyT–polyA–polyT triplet. In

(a), held together partially by Hoogsteen base pairing, the polypurine strand is antiparallel to the polypurine strand of the original DNA duplex. In (b), which is characterized by reverse Hoogsteen base pairing, the polypyrimidine third strand is parallel to the polypurine strand. Brackets enclose strands held together by Watson–Crick hydrogen bonding.

Redrawn based on figure in Sinden, R. R. *DNA Structure and Function*. New York: Academic Press, 1994.

Intramolecular triple helices can be formed by disruption of H bonds, over regions of DNA characterized by the presence of polypurine strands, and refolding as illustrated in Figure 14.36 to generate a triple-stranded region and a single-stranded loop. This arrangement involves disruption of base stacking interaction in the unpaired region and therefore it is not the most thermodynamically stable structure that can be formed by the double-stranded polypurine–polypyrimidine DNA segment. Yet, intramolecular triple helices are detected in cellular DNA. Apparently DNA supercoiling provides the energy to drive the unwinding of DNA that is necessary for the formation of the triple helix. Triplestrand formation produces a relaxation of negative supercoils. In addition to the general requirement that a string of purines be present, structural considerations for the formation of hydrogen bonds dictate that the polypurine–polypyrimidine region must contain **mirror repeat symmetry** for the triplex to form. A mirror repeat is a region such as AGGGGA that has the same base sequence when read, from a central point, in either direction within one of the DNA strands. There are two possible pairs of alternative structures that can form from different foldings of the polypurine–polypyrimidine region in the triple helix. One of the pairs is characterized by a pyrimidine–purine–pyrimidine arrangement in which half of the pyrimidine strand is paired as the third strand and the complementary strand remains unpaired. The other pair of possible alternative structures is characterized by the less commonly occurring purine–purine–pyrimidine arrangement.

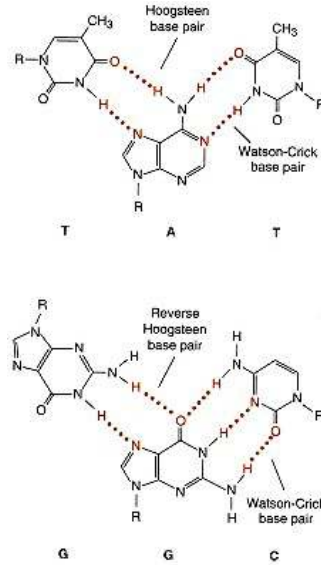

Figure 14.35

Base pairing in DNA triplexes.

Two examples of the type of hydrogen bonding involving the formation of triple-stranded DNA helices are shown, one for the polyG–polyG–polyC and one for the polyT–polyA–polyT triple helix. For the T–A–T triplex the purine (A) participates in a Watson–Crick base pairing to T and in an alternative type of base pairing (Hoogsteen base pairing) to a second T. In the G–G–C triplex, the purine (G) forms a Watson–Crick base pairing with C and a Hoogsteen base pairing with G. In this base pairing scheme the ribose groups of the two purines are in trans orientation, generating a so-called reverse Hoogsteen base pair. The relative orientation (polarity) of the three strands shown in Figure 14.36 depends on whether two of the participating polynucleotides form regular or reverse Hoogsteen base pairs.

A distinct type of intermolecular triple-stranded helix is formed by enzymatic catalysis, as an intermediate during general recombination. These intermediates are atypical triple helices in that they are not limited to polypurine–polypyrimidine regions but instead involve DNA strands of identical, or nearly identical, nucleotide sequences. These helices are unwound structures in which

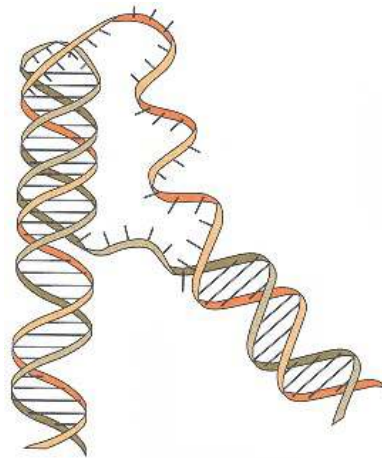

Figure 14.36

Intramolecular triple helices.

Polypurine–polypyrimidine regions of DNA with a mirror repeat symmetry can form an intramolecular triple helix in which the third strand lays in the major groove, whereas its complementary strand acquires a single-stranded conformation.

Redrawn based on figure in Sinden, R. R. *DNA Structure and Function*. New York: Academic Press, 1994.

the third strand binds on the major groove side of a double helix in a manner parallel to its identical strand.

Long polypurine–polypyrimidine sequences can form another variant DNA structure, the **nodule DNA**, that consists of a pair of two intermolecular triplex regions, as illustrated in Figure 14.37. Its biological significance has not been determined.

The role of DNA triplex formation in a hereditary affliction known as persistence of fetal hemoglobin is briefly reviewed in Clin. Corr. 14.4. The therapeutic potential of oligonucleotides capable of forming triplex DNA with segments of DNA having Hoogsteen base pairing potential is discussed in Clin. Corr. 14.5.

Four-Stranded DNA

Four-stranded DNA (quadruplex) can form as both parallel and antiparallel structures. Parallel structures may form during DNA recombination (see p. 661). A parallel four-stranded DNA may be found in an immunoglobulin heavy chain gene. The immunoglobulin genes undergo a type of recombination (specific recombination) that is responsible for the extensive diversity that characterizes antibody formation. The sequences that participate in this alternative type of DNA structure are repeated motifs high in guanine content such as GGGAGCTGGG. A base pairing scheme for parallel four-stranded DNA, referred to as a **G-quartet DNA**, is shown in Figure 14.38. In this scheme all four DNA strands are arranged in a parallel orientation and are associated to one another through Hoogsteen base pairs. The glycosidic bonds in all nucleotides are in the **anti** configuration.

Parallel and antiparallel four-stranded DNA structures form at **telomeres**. These contain repetitive simple oligonucleotide sequences (such as G_4T_2) that are usually purine rich in one of the strands. This strand is longer and overhangs the complementary strand. The repetitive sequences make the formation of four-stranded DNA possible. One such four-stranded antiparallel structure forms when the single strand overhanging the telomere end is folded back into a hairpin structure with guanines binding to one another by Hoogsteen base pairing. Two folded double-helical regions can then interact to form four-

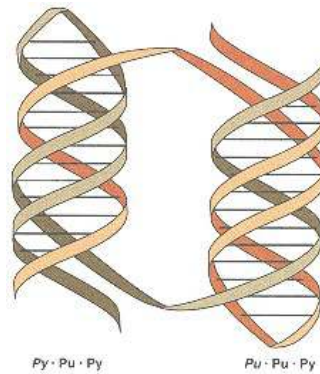

Figure 14.37
Nodule DNA. Nodule DNA consisting of a combination of a Py-Pu-Py triple helix and a Pu-Pu-Py triplex can be formed within a long polypurine–polypyrimidine tract. The Py-Pu-Py structure can contribute its displaced single Pu strand to the other half of the Pu-Py region, forming the Pu-Pu-Py triplex structure. Redrawn based on figure in Sinden, R. R. *DNA Structure and Function*. New York: Academic Press, 1994.

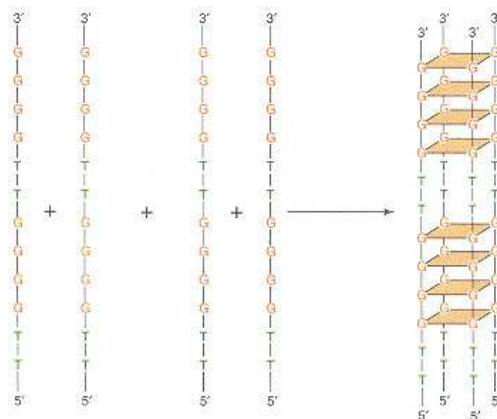

Figure 14.38
Parallel quadruplex DNA. Quadruplex structures in which all four strands are parallel can form from four single-strand tracts of polyguanine. These quadruplexes, referred to as G-quartets, are associated by Hoogsteen base pairs. Redrawn based on figure in Sinden, R. R. *DNA Structure and Function*. New York: Academic Press, 1994.

CLINICAL CORRELATION 14.4

Hereditary Persistence of Fetal Hemoglobin

Hereditary persistence of fetal hemoglobin (HPFH) is a group of conditions in which fetal hemoglobin synthesis is not turned off with development but continues into adulthood. The homozygous form of the disease is extremely uncommon, being characterized by red blood cell changes similar to those found in heterozygous β -thalassemia. HPFH, in either the homozygous or heterozygous state, is associated with mild clinical or hematologic abnormalities. Mild musculoskeletal pains may occur infrequently but HPFH patients are generally asymptomatic.

The disease is the result of failure in control of transcription from human $G\gamma$ - and $A\gamma$ -globin genes. Affected chromosomes fail to switch from γ - to β -chain synthesis. Expression of these genes appears to be affected substantially by formation of an intramolecular DNA triplex structure located about 200 bp upstream from the initiation site for transcription of genes, specifically between positions -194 and -215.

Hemoglobin genes of patients contain mutations in positions -195, -196, -198, and -202. Mutations at -202 involve changes from C to G and C to T, at -198 from T to C, at -196 from C to T, and at -195 from C to G. These mutations influence the stability of the intramolecular DNA triple helix.

In general, the presence of polypurine-polypyrimidine sequences sufficiently long to form intramolecular triple helices tends to repress transcription, while short polypurine-polypyrimidine segments that are unable to induce triple helix formation have no effect on transcription. In the case of HPFH, a remarkable correspondence is noted between base changes that destabilize formation of the triple helix and presence of the genetic disease.

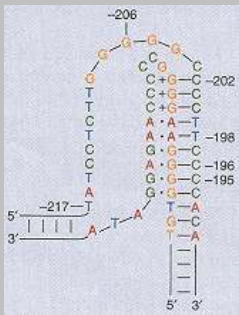

Ulrich, M. J., Gray, W. J., and Ley, T. J. An intramolecular DNA triplex is disrupted by point mutations associated with hereditary persistence of fetal hemoglobin. *J. Biol. Chem.* 267:18649, 1992; and Bacolla, A., Ulrich, M. J., Larson, J. E., Ley, T. J., and Wells, R. D. An intramolecular triplex in the human gamma-globin 5'-flanking region is altered by point mutations associated with hereditary persistence of fetal hemoglobin. *J. Biol. Chem.* 270:24556, 1995.

CLINICAL CORRELATION 14.5

Therapeutic Potential of Triplex DNA Formation

Control regions of genes often contain polypurine-polypyrimidine regions. Binding of a single third strand of DNA, complementary to the polypurine strand, may under certain conditions prevent binding of regulatory proteins, such as transcription factors, and thus affect gene expression. Alternatively, triplex formation may influence regulation of gene expression by affecting the level of DNA supercoiling in the topological domain in which the triple helix forms, as shown in the figure below.

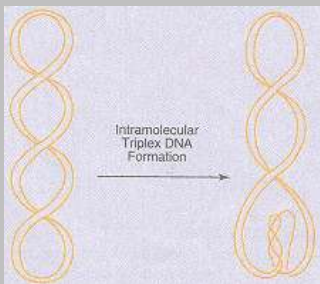

For instance, a polypurine-polypyrimidine region, which can form a triplex, is present upstream of the human *c-myc* oncogene. This region, which interacts with transcription factors, can form an intermolecular triplex with an oligonucleotide designed to provide base complementary with the polypurine-polypyrimidine region. Formation of triplex DNA results in inhibition of *c-myc* transcription *in vitro*. The above example suggests that formation of intermolecular complexes has the potential to regulate expression of specific proteins that may play important roles in health and development of disease. The great individuality inherent in the sequence of unique oligonucleotide segments provides the potential to design specific therapeutic oligonucleotides for turning certain genes off and on.

The specificity of DNA triplexes also provides another approach for the potential control of expression of certain genes. Oligonucleotide sequences that are targeted to specific regions of a eukaryotic or viral genome can be coupled with artificial nucleases or covalent modifiers of DNA. Such targeting produces endonucleolytic cutting or covalent modification of the DNA at specific sites. This approach has therapeutic potential for gene regulation and killing of virus-infected cells or other abnormal cells.

Kinniburgh, A. J. A cis-acting transcription element of the *c-myc* gene can assume an H-DNA conformation. *Nucleic Acids Res.* 17:7771, 1989; and Pei, D., Corey, D. R., and Schultz, P. G. Site specific cleavage of duplex DNA by a semisynthetic nuclease via triple-helix formation. *Proc. Natl. Acad. Sci. USA* 87:9858, 1990.

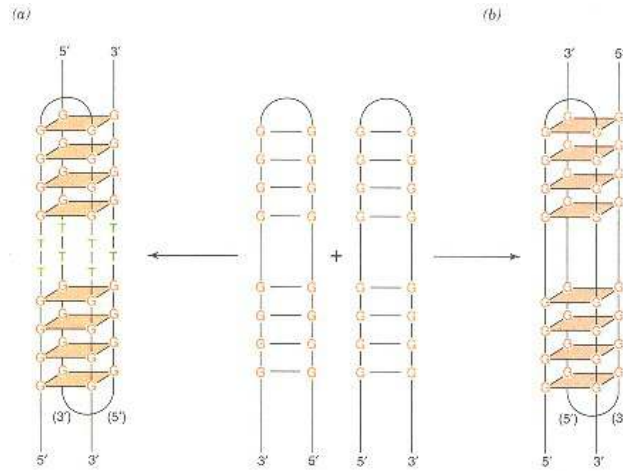

Figure 14.39
Antiparallel quadruplex DNA.
 Several quadruplexes both of the antiparallel
 (a) and parallel
 (b) type can form at telomeres as these terminal regions are guanine-rich.
 Redrawn based on figure in Sinden,
 R. R. *DNA Structure and Function*. New York: Academic Press, 1994.

stranded structures held together by Hoogsteen base pairs between guanines. A number of alternative four-stranded structures can form and their existence has been confirmed by X-ray diffraction and NMR spectroscopy. An example of an antiparallel quadruplex DNA is shown in Figure 14.39.

Slipped DNA

DNA regions with direct repeat symmetry can form structures known as **slipped, mispaired DNA (SMP-DNA)**. Their formation involves the unwinding of the double helix and realignment and subsequent pairing of one copy of the direct repeat with an adjacent copy on the other strand. This realignment generates a single-stranded loop (Figure 14.40). Two isomeric structures of a SMP-DNA are possible. One generates a loop consisting of the 5' direct repeat in both strands and the other produces loops of the 3' direct repeat. Although SMP-DNA has not yet been identified, genetic evidence suggests that this type of DNA is undoubtedly involved in spontaneous frameshift mutagenesis that is manifested as base addition or deletion occurring within runs of single bases. A mechanism that explains these mutations is shown in Figure 14.41. First, a homopolymeric sequence in one strand (template strand) unpairs from a newly synthesized complementary strand and reforms hydrogen bonds with a different set of bases, resulting in the formation of an extrahelical base on either the template strand or progeny strand. Continued replication produces a deletion when the progeny strand slips forward or a duplication when the strand slips backward. Deletions and duplications of DNA segments, longer than a single base, occur during DNA replication between direct repeats, which can form slipped-looped structures. Duplication of certain simple triplet repeats that are implicated as the basis of several human genetic diseases (see Clin. Corr. 14.6) may also occur by this mechanism.

Nucleoproteins of Eukaryotes Contain Histones and Nonhistone Proteins

DNA in eukaryotic cells is associated with various types of protein to form **chromatin**. In resting (nondividing) cells, chromatin is amorphous and dispersed within the nucleus. Just prior to cell division (mitosis), chromatin becomes organized into compact structures (fibers) called **chromosomes**. The

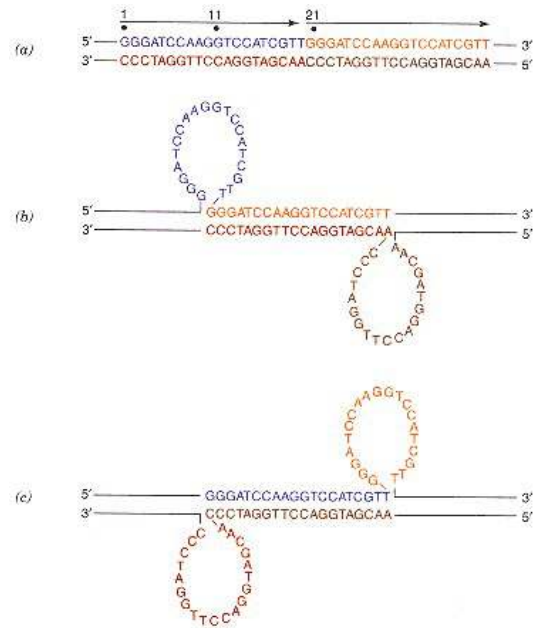

Figure 14.40
Slipped, mispaired DNA.

The presence of two adjacent tandem repeats (a) can give rise to either one of two isomers of slipped, mispaired DNA. In one of these isomers (b) the second copy of the direct repeat in the top strand pairs with the first copy of the repeat on the bottom strand. Pairing of the first copy of the direct repeat in the top strand with the second copy of the direct repeat in the bottom strand produces the second isomer (c). A pair of single-stranded loops is generated in both isomers.

CLINICAL CORRELATION 14.6

Expansion of DNA Triple Repeats and Human Disease

The presence of reiterated DNA sequences, consisting of three base pairs, has been noted in a number of human genetic diseases including fragile X syndrome, myotonic dystrophy, X-linked spinal and bulbar muscular atrophy (Kennedy syndrome), spinocerebellar ataxia, colon cancer, and more recently Huntington's disease. These diseases are associated with expansion of certain triplet nucleotide repeats that appear to be overrepresented in the human genome. For example, fragile X syndrome is characterized by expansion of a GCC triplet and spinocerebellar ataxia type I with expansion of a CAG triplet. Diseases associated with expansion of triplets are characterized by an increase in severity of the disease with successive generation, which is known as anticipation. For example, anticipation in fragile X syndrome, a leading cause of mental retardation, is associated with a major expansion of the CGG triplet. Normally, about 30 copies of this triplet are present on the 5' side of a gene associated with the disease, the *FMR-1* gene. The site of the repeat is expanded to as many as 300 copies in males that carry fragile X gene mutations but have no symptoms of the disease. Offspring of male carriers who express the disease can have a remarkable expansion of the triplet repeat, up to thousands of copies.

The disease develops when normal expression of *FMR-1* gene is turned off. Methylation of CpG dinucleotides present in CGG triplets appears to be associated with shutting off of the *FMR-1* gene. It appears that triplet expansion is the result of slipped mispairing during DNA synthesis. Because of the massive amplification that characterizes the diseases associated with triplet expansion, repeated or multiple slippage would have to be involved to explain the high degree of expansion. What promotes repeated slippage is not known but it may be that expansion is associated with a repeated dissociation of the enzyme DNA polymerase from the DNA template. This may allow DNA breathing and repeated slippage of DNA strands that are obviously required for the observed extensive expansion of the triplets. For slippage to occur, a single-stranded break needs to be generated within the tandem repeat during replication, which can lead to addition (or deletion) of a few copies of the tandem repeat. For modest size repeats, that is, repeats of less than about 80 copies, at least one such break is expected to be generated. When a larger number of repeats are present, it is possible that two single-stranded breaks are generated during replications. The strand segment flanked by these single-stranded breaks is not anchored by a unique sequence at either end and therefore it is free to slide during synthesis, leading to triplet amplification.

Behn-Krappa, A., and Doerfler, W. Enzymatic amplification of synthetic oligodeoxyribonucleotides: implications for triplet repeat expansions in the human genome. *Hum. Mutat.* 23:19, 1994.

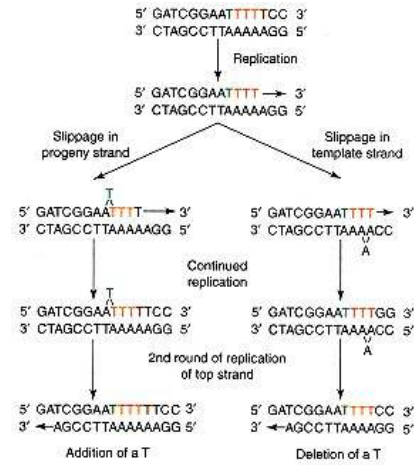

Figure 14.41

Frameshift mutagenesis by DNA slippage.

DNA replication within a run of a single base can produce a single base frameshift. In the example shown here, a run of five A's is replicated and, depending on whether a slippage occurs in the progeny strand or the template strand, a T may be added or deleted from the DNA.

division of genetic information into numerous independent domains, that is, chromosomes, may be necessitated by the enormous length of the genome of most eukaryotes. Each chromosome is characterized by the presence of a **centromere**, which functions as a site for attachment to proteins that link the chromosome to the mitotic spindle. Sister chromatids are connected at the centromere. **Telomeres** define the termini of linear chromosomes. A third element that characterizes chromosomes is the presence of a sequence required for the initiation of DNA replication (**origin of replication**). The number of chromosomes observed is species specific with human cells containing 46 chromosomes (chromatids) organized into 23 pairs. The average DNA length of each one of these chromosomes is 1.3×10^8 nucleotide pairs or approximately 5 cm. It is believed that each human chromosome consists of a single intact DNA molecule varying in size from 263×10^6 base pairs for chromosome 1 to less than 50×10^6 bp for chromosome 23. If the DNA of all 46 chromosomes were lined up in the B-DNA conformation, it would be more than 2 m long.

The chromosomal organization that makes it possible for DNA to fit within a cell nucleus with a diameter of approximately $5 \mu\text{m}$ requires a "condensation ratio" of more than five orders of magnitude. During metaphase the DNA molecule is very tightly wound. For example, human chromosome 16 is $2.5 \mu\text{m}$ long, whereas the DNA molecule is 3.7 cm in each of the two chromatids, giving a condensation ratio of $1.5 \times 10^4:1$. The parceling of DNA in 46 chromosomes provides for a further increase in the condensation ratio to $10^5:1$. This remarkable degree of condensation of cellular DNA is shown in Figure 14.42. The early stages of DNA packing that lead to formation of 30-nm fibers have been extensively studied. The latter stages, in which looped domains of the 30-nm fiber are organized into scaffolds and chromatid coils, are based on indirect evidence and are more speculative. At each stage of packing, shown in this model, DNA is condensed severalfold. The cumulative effect of the successive folding stages provides the large condensation ratio necessary for the **packing of DNA** within the nucleus. The first stage of organization is the formation of a "**beads-on-a-string**" structure consisting of DNA associated with a class of highly basic proteins known as **histones**. These bind tightly to DNA, forming very stable complexes. The "beads-on-a-string" arrangement is seen in chromatin treated under conditions of low ionic strength and examined

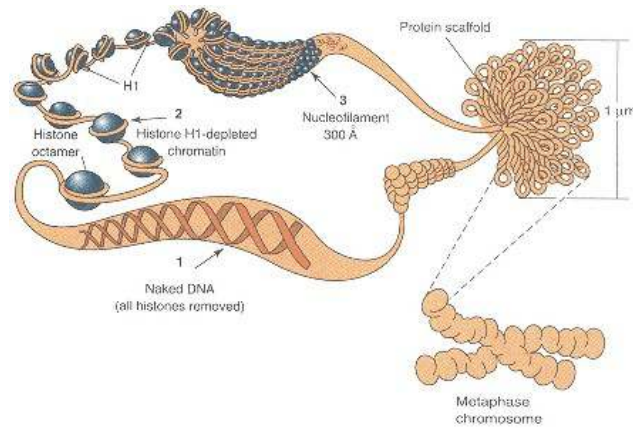

Figure 14.42

Organization of polynucleosomes into chromosomes. A speculative drawing showing the condensation of polynucleosomes into the 30-nm fiber and the subsequent packaging of this fiber into a twisted, looped structure attached to a protein scaffold within the chromosome.

under the electron microscope. The "string" is free DNA and the "beads" are coiled around histones.

Histones, regardless of their source, consist of five types of polypeptides of different size and composition (Table 14.7). The most "conserved" histones are H4 and H3, which differ very little even between extremely diverse species; histones H4 from peas and cows are very similar, differing by only two amino acids, although these species diverged more than a billion years ago. The H2A and H2B histones are less highly conserved but still exhibit substantial evolutionary stability, especially within their nonbasic portions. H1 histones are quite distinct from the inner histones. They are larger, more basic, and by far the most tissue-specific and species-specific histones. Vertebrates contain an additional histone, H5, which has a function similar to H1. As a result of their unusually high content of the basic amino acids lysine and arginine, histones are highly polycationic and interact with the polyanionic phosphate backbone of DNA so as to produce uncharged nucleoproteins. All five histones are characterized by a central nonpolar domain, which forms a globular structure, and N-terminal and C-terminal regions that contain most of the basic amino acids. The basic N-terminal regions of H2A, H2B, H3, and H4 comprising 20–25% of the histone octamer are the major, but not the exclusive, sites of interaction with DNA. Nonpolar domains and C-terminal regions of histones H1, H2A, and H2B are involved in subunit and DNA and histone interactions.

A heterogeneous group of proteins with high species, and even organ, specificity is also present in chromatin. These proteins, grouped together as

Table 14.7 Structure of the Five Types of Histones^a

Name	Structure ^b	Residues	Molecular Weight
H4	N ●	102	11,300
H3	N ● C	135	15,300
H2A	N ● C	129	14,000
H2B	N ● C	125	13,800
H1	~N ● C	~216	~21,000

nonhistone proteins, consist of several hundred members, most of which are present in trace amounts. Many nonhistone proteins are associated with various chromosome functions, such as replication, gene expression, and chromosome organization.

Nucleosomes and Polynucleosomes

Histones interacting with DNA form the periodic "beads-on-a-string" structure, called a **polynucleosome**, in which an elementary unit, a nucleosome, is regularly repeated. Each **nucleosome** is a disk-shaped structure about 11 nm in diameter and 6 nm in height that consists of a DNA segment and a histone cluster composed of two molecules each of H2A, H2B, H3, and H4 histones. The clusters are organized as tetramers consisting of $(H3)_2$ - $(H4)_2$ with an H2A-H2B dimer stacked on each face in the disk. The DNA is wrapped around the octamer as a negative toroidal superhelix at a pitch of about 30 Å with the central $(H3)_2$ - $(H4)_2$ core interacting with the central 70–80 bp of the DNA wrap. Histones are in contact with the minor groove of DNA and leave the major groove available for interaction with the proteins that regulate gene expression and other DNA functions. Two distinct structures of nucleosomes can be distinguished: the **nucleosome core** and the **chromatosome**, as presented in Figure 14.43. The chromatosome constitutes the most elementary structural unit of nucleoproteins. These two structures are obtained by the digestion of polynucleosomes with nucleases (DNases) that, depending on conditions, can re-

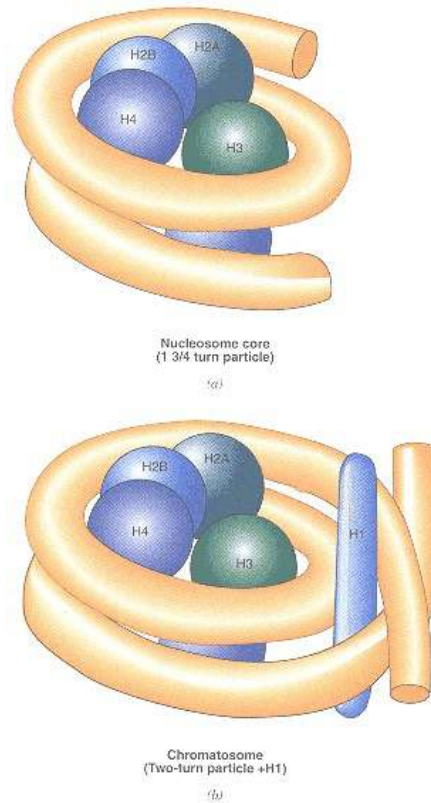

Figure 14.43

Postulated structures for the nucleosome and chromatosome.

The nucleosome consists of approximately 146 bp of DNA corresponding to 1 3/4 superhelical turns wound around a histone octamer. The chromatosome (two-turn particle) consists of about 166 bp of DNA (two superhelical turns). The H1 subunit is retained by this particle and may be associated with it, as shown. Chromatosomes containing less than 166 bp do not bind the H1 subunit.

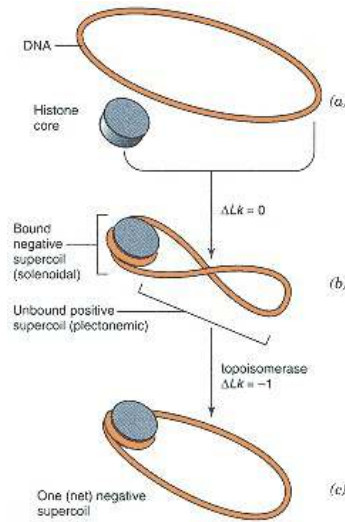

Figure 14.44
Generation of negative supercoiling in eukaryotic DNA.

The binding of a histone octamer to a relaxed, closed-domain DNA forces the DNA to wrap around the octamer, generating a negative supercoil. In the absence of any strand breaks, the domain remains intact and a compensating positive supercoil must be generated elsewhere within the domain. The action of a eukaryotic type I topoisomerase subsequently relaxes the positive supercoil, leaving the closed domain with one net negative supercoil.

move most or all DNA that is not tightly bound with histones. Nucleosomes obtained by nuclease digestion can be crystallized and studied by X-ray diffraction.

The structure of nucleosomes explains the puzzling finding that eukaryotic cells lack topoisomerases that can underwind DNA. It appears that negative superhelicity is, instead, introduced into eukaryotic cells as a result of DNA forming a toroidal wrapping around the histone core of nucleosomes (Figure 14.44). Such wrapping requires the removal of approximately one helical turn in DNA. Initially relaxed DNA subjected to such wrapping will generate a negative toroidal supercoil within the region bound around the histone core and a compensating positive supercoil elsewhere in the molecule, so as to maintain a constant linking number. Subsequent relaxation of the positive supercoil by eukaryotic topoisomerases leaves one net negative supercoil within the nucleosomal region.

Polynucleosomes consist of numerous nucleosomes joined by "linker" DNA, the size of which differs among cell types. Usually the nucleosome core is used as the elementary unit for describing the polynucleosome, in which case linker DNA size varies anywhere from about 20 to 90 bp. (Linker sequences would of course be proportionally smaller if the chromatosome were to be used as the elementary unit for the polynucleosome.) Since in addition to the linker sequence approximately 146 ± 1 bp are wrapped around the nucleosome core, the polynucleosome has a minimum nucleosome repeat frequency of about 168 ± 2 bp. Repeat frequencies for nucleosomes are found to depend on both the organism and the organ from which the cell is isolated and, as a rule, they appear to be relatively long in transcriptionally inactive cells. For example, chick erythrocytes have a repeat frequency of 212 bp. Active cells, such as yeast cells that have a frequency of 165 bp, generally have shorter linker sequences.

Periodicity of distribution of nucleosomes along the polynucleosome structure has been determined by controlled digestion with a nuclease that preferentially attacks linker DNA. The digestion pattern suggests the presence of nucleo-protein segments, which on the average contain about 200 bp of DNA or multiples of 200 that result from incomplete digestion. The relationship between size of segments and expected number of nucleosomes associated with them has been confirmed by electron microscopy. With the exception of a small amount of eukaryotic DNA, which is located in mitochondria and chloroplasts and which occurs in the form of small superhelices generally free of protein, all eukaryotic DNA is associated with histones.

Although nucleosomes are periodically positioned along the polynucleosome, their distribution is not random with respect to the base sequence of DNA. DNA does not bend uniformly but rather bends gently and then more sharply around the histone octamers. This suggests that DNA binding is sequence dependent and that **nucleosome positioning** may be influenced by the nucleotide sequence of DNA. In fact, nucleosomes tend to associate preferentially with certain DNA regions. DNA tracts that resist binding, such as long A tracts or G-C repeats, are not usually associated with nucleosomes. In contrast, certain bend DNA regions, for instance, periodically phased A tracts, associate strongly with histones. The majority of nucleosome core particles can relocate over a cluster of positions along the DNA separated by about 10 bp. The resulting mobility of these coil particles probably allows DNA polymerases and other enzymes to gain access to specific DNA sequences. The organization of DNA into nucleosomes appears to have fundamental consequences for transcription and DNA repair.

Polynucleosome Packing into Higher Structures

The wrapping of DNA around histones to form nucleosomes results in a tenfold reduction in the apparent lengths of DNA and the formation of the so-called

10-nm fiber (which is actually 11 nm wide), corresponding to the diameter of the nucleosomes. In chromosomes isolated by very gentle methods, both 10-nm fibers and thicker 30-nm fibers (in fact, 34 nm wide) can be seen in electron micrographs. The relationship between 30-nm fibers and 10-nm fibers has been further confirmed experimentally by the observation that 30-nm fibers can be dissociated into 10-nm fibers by treatment at low ionic strength. The 30-nm fibers appear to form by condensation of 10-nm fibers into a **solenoid arrangement** involving six to seven chromatosomes per solenoid turn (Figure 14.45). **Chromatosomes** are nucleosomes that contain a molecule of H1 histone. This histone is a protein consisting of three different domains that may bind DNA at the ends of the turn and at the point where DNA enters and exits the nucleosome at a ratio of one H1 per nucleosome. Adjacent H1 molecules may also bind to one another cooperatively, bringing the nucleosomes closer together in 30-nm fibers. The formation of the polynucleosome and its subsequent condensation into the 30-nm fibers provides for DNA a compaction ratio that may be as high as two orders of magnitude. The 30-nm fibers form only over selected regions of DNA that are characterized by the absence of binding with other sequence-specific (nonhistone) DNA-binding proteins. The presence of DNA-binding proteins and the effects on formation of 30-nm fibers may depend on the transcriptional status of the regions of DNA involved.

How polynucleosomes are organized into higher structures is not fully understood. Models as to the higher levels of packing of 30-nm fibers are based on indirect evidence obtained from studies of two specialized types of chromosomes—the **lampbrush chromosomes** of vertebrate oocytes and the **polytene chromosomes** of fruitfly giant secretory cells. These chromosomes are exceptional in that they maintain precisely defined higher-order structures in interphase, that is, when cells are in a resting (nondividing) state. The structural features of interphase lampbrush chromosomes have led, by extrapolation, to the proposal that chromosomes in general are organized as a series of looped, condensed domains of 30-nm fibers of variable size for different organisms. It

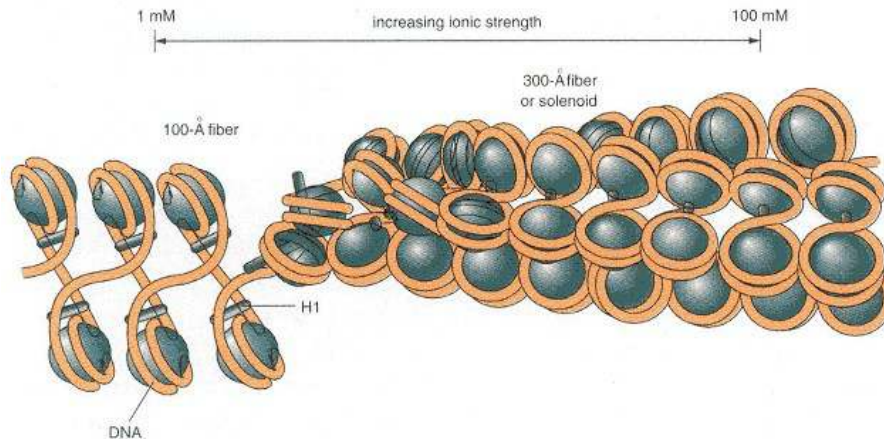

Figure 14.45

Nucleofilament structure.

Nucleofilament has the "string of beads" appearance, which corresponds to an extended polynucleosome chain. H1 histone is attached to the "linker" regions between nucleosomes, but in the resulting structure H1 molecules, associated to adjacent nucleosomes, are located close to one another. Furthermore, at higher salt concentrations, polynucleosomes can be transformed into the higher order structure of the 300-Å fiber. It has been proposed that at higher ionic strengths the nucleofilament forms a very compact helical structure or a helical solenoid, as illustrated in the upper part of the figure. H1 histones appear to interact strongly with one another in this structure. In fact, the organization of the 10-nm (100-Å) nucleofilament into the 30-nm (300-Å) coil or solenoid requires, and may be dependent on, the presence of H1.

Adapted from Kornberg, R. D., and Klug, A. *The Nucleosome*. San Diego, CA: Academic Press, 1989.

is estimated that these loops may contain anywhere from 5000 to 120,000 bp with an average of about 20,000. Thus the haploid human genome of 3×10^9 bp would correspond to about 60,000 loops, which is close to the estimated number of genes of 70,000 to 100,000. It appears likely that each loop contains one or a few linked genes. The domains are bound to a nuclear scaffold consisting of H1 histone and several nonhistone proteins, including two major **scaffold proteins Sc1** (a topoisomerase II) and **Sc2**. The loops are fixed at their bases and therefore they can accumulate supercoils. Specific AT-rich regions of DNA known as **SARs (scaffold attachment regions)** are preferentially associated with the scaffold. SARs also contain topoisomerase II binding sites. The presence of type II topoisomerase at the base of closed topological domains, which define the scaffold loops, suggests that supercoiling and supercoiling changes within these domains are biologically important functions. Formation of looped domains may account for as much as an additional 200-fold condensation in the length of DNA and an overall packing ratio of more than four orders of magnitude. Each loop can be coiled and then supercoiled into $0.4 \mu\text{m}$ of a 30-nm fiber. Since the thickness of a sister chromatid is about $1 \mu\text{m}$ in diameter, packing of the 20-nm fiber into a chromatid would require just one more order of folding.

The next level of chromosomal organization may therefore involve the packing of loops as suggested in Figure 14.45. The packing may be achieved by arranging the loops of the 30-nm fiber in the form of tightly stacked helical coils. It is speculated that chromatids of metaphase chromosomes consist of helically packed loops of 30-nm fibers. Packing changes, and therefore the transition between the various forms of chromatin, appear to be partially controlled by the covalent modification of core histones. Histones H3 and H4 can undergo cell-cycle-dependent reversible acetylation on the ϵ -amino group of lysine by two different enzymes, a **histone acetylase** and a **histone deacylase**. Acetylation appears to affect the negative superhelical tension within domains and, in certain instances, the binding of transcription factors. The hydroxyl group of the N-terminal serine residue in histone H4 is subject to phosphorylation catalyzed by a kinase. Acetylation and phosphorylation change the charge of the N-terminal region of histone H4 from +5 to -2. The overall negative charge of the core histones causes histones to bind less tightly to DNA and promotes the unraveling of 30-nm fibers and the decondensation of chromatin. Finally, phosphorylation of terminal H1 correlates with chromosome condensation into metaphase chromosome. This may result from a modulation of affinity between phosphorylated–dephosphorylated H1 with the histone octamer. The change from compact to decondensed chromatin is also promoted by the binding of proteins, known as **HMG proteins (high-mobility-group proteins)**, which interact preferentially with the transcriptionally active decondensed form of chromatin, that is, the 10-nm fiber.

Control of eukaryotic transcription and replication apparently involves both histone and nonhistone protein. While dissociation of histones from chromosomal DNA may be a prerequisite for transcription, nonhistone proteins provide more finely tuned transcription controls. Whatever the details of control may be, chromosomal regions actively synthesizing RNA are least condensed, in distinction from the more compacted, inactive regions. **Active genes** must be packaged in a way that makes them accessible to regulatory proteins. At the same time permanently **repressed genes** must remain inaccessible. Packaging may also determine the accessibility of DNA to DNA-damaging agents. Finally, nonhistone proteins control gene expression during differentiation and development and may serve as sites for the binding of hormones and other regulatory molecules.

Viral DNA is almost always complexed with protein, where the function of the protein is generally one of "packaging." In essence the protein protects the DNA from mechanical damage or digestion by endonucleases.

Nucleoproteins of Prokaryotes Are Similar to Those of Eukaryotes

In prokaryotic cells DNA is generally organized as a single chromosome that is a double-stranded circular supercoil. Some bacteria contain more than one chromosome and, in some, chromosomes may have linear structures. Prokaryotes lack histones. Instead, an abundant histone-like protein, the **HU protein**, is apparently responsible for the formation of a "beaded" structure seen in prokaryotes. HU (molecular mass 18 kDa) exists as a heterodimer of two nearly identical subunits (HU-1 and HU-2). Upon binding to DNA, HU changes the shape and the supercoiling of the double helix. The binding of HU to DNA *in vitro*, compacts DNA and restrains supercoils in a concentration-dependent manner and up to an equimolar ratio. This means that the interaction of DNA with HU at an equimolar ratio prevents topoisomerases from relaxing negatively supercoiled DNA in the DNA–HU complex. It also means that HU can introduce restrained supercoils in relaxed DNA. Higher concentrations of HU do not result in the restraining of additional supercoils. From the effects of HU on DNA supercoiling and other evidence, it appears that HU bends DNA sharply into a tight circle. In addition, another abundant small histone-like protein, referred to as **H-NS**, may be involved in chromosomal organization either directly or indirectly through interaction with the HU proteins.

Bacterial chromosomes are organized into compacted structures, called **nucleoids**, by interaction of HU and H-NS proteins and participation of various cations, **polyamines** (such as spermine, spermidine, putrescine, and cadaverine), RNA, and nonhistone proteins. In the case of *E. coli* the nucleoid consists of a single supercoiled DNA molecule organized into about 40 loops, each consisting of approximately 100 kb of DNA, that merge into a scaffold rich in protein and RNA (Figure 14.46). In prokaryotic scaffolds, the loops are maintained by interactions between DNA and RNA rather than DNA–protein interactions only, as is the case with eukaryotes. The genome of *E. coli* consists of about 4.5×10^6 bp, which, if they were straightened as a linear B-DNA, would be 1.5 mm long and therefore 80 times larger than the diameter of the *E. coli* cell. As a result of a nucleoid formation, which has a diameter of only $2 \mu\text{m}$, the *E. coli* genome can easily be fitted within the constraints of the cell. Although the nucleoid, in analogy with the chromatin of eukaryotes, is organized in the form of looped domains, the organization of domains within larger compacted structures (chromosomes) that characterize eukaryotes is absent from prokaryotes. Bacterial chromosomes are dynamic structures formed with histone-like proteins, which bind and dissociate fairly rapidly. This may reflect the need for rapid DNA synthesis, cell division, and transcription that characterize bacterial cells. In contrast, histones bind much more stably with eukaryotic DNA and may dissociate only over areas of the genome that are engaged in DNA synthesis, repair, recombination, or transcription.

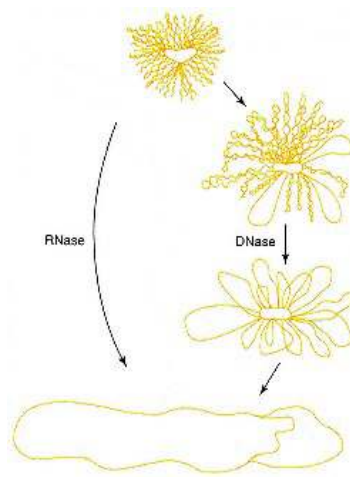

Figure 14.46
Schematic depiction of the folded chromosome of *E. coli*.

This chromosome contains about 50 loops of supercoiled DNA organized by a central RNA scaffold. DNase relaxes the structure progressively by opening individual loops, one at a time. RNase completely unfolds the chromosome in a single step.
Redrawn from Worcel, A., and Burgi, E. *J. Mol. Biol.* 71:127, 1972.

14.4— DNA Structure and Function

Overall base composition characterizes DNA only in a very general manner. A more specific property, which characterizes any DNA in a unique way, is the nucleotide sequence. Direct determination of nucleotide sequences in DNA remained an intimidating undertaking until the discovery of the restriction endonucleases.

Restriction Endonucleases and Palindromes

Restriction endonucleases cleave DNA chains at a specific sequence, making possible the sectioning of large DNA molecules into small segments. These highly specific bacterial enzymes act by making two cuts, one in each strand

TABLE 14.8 Examples of Sites of Cleavage of DNA by Restriction Enzymes of Various Specificities^a

Enzyme	Microorganism	Specific Sequence	Number of Cleavage Sites for Two Commonly Used Substrates	
			ϕX174	pBR 322
EcoRI	<i>E. coli</i>	-G AATT-C- -C-TTAA G-	25	9
HaeIII	<i>Haemophilus aegyptius</i>	-GG CC- -CC GG-	11	22
HpaII	<i>Haemophilus parainfluenzae</i>	-C CG-G- -G-GC C-	5	26
HindIII	<i>Haemophilus influenzae</i> Rd.	-A AGCT-T- -T-TCGA A-	0	1

^a Cleavage takes place within palindromes. The cleavage sites are indicated by arrows.

of double-stranded DNA of an invading phage, generating 3'-OH and 5'-P termini. This fragmentation exposes phage DNA to eventual degradation by bacterial exonucleases. The terminology for these endonucleases originates from the bacterial sources from which they are isolated. The first three letters of the name is an abbreviation of the species from which the enzyme is isolated. The next letter (or letters) designates the strain of the source and the Roman numeral simply refers to the order in which the enzyme was discovered from the strain. Many hundreds of restriction endonucleases have been isolated in pure form and the list of new restriction enzymes is growing daily. With few exceptions, these enzymes have been found to recognize sequences four to six nucleotides long. These sequences are completely **symmetrical inverted repeats**, known as **palindromes**, as illustrated by the examples listed in Table 14.8. The order of the bases is the same when the two strands of the palindrome are read in opposite directions. For example, in the case of the restriction enzyme EcoRI, isolated from *E. coli*, the order of the bases is GAATTC when read from the 5' terminus of either of the strands.

Restriction endonucleases are classified into three categories. Types I and III make cuts in the vicinity of the recognition site in an unpredictable manner. Type II specifically cleaves DNA within the recognition sequence. The cuts made by type II enzymes are indicated in Table 14.8 by arrows. Examples of products generated are shown in Figure 14.47.

These enzymes recognize specific sequences that occur along large DNAs with relatively low frequencies and fragment DNA very selectively. For example, a typical bacterial DNA, which may contain about 3×10^6 bp, will be cleaved into a few hundred fragments. A small virus or plasmid may have few or

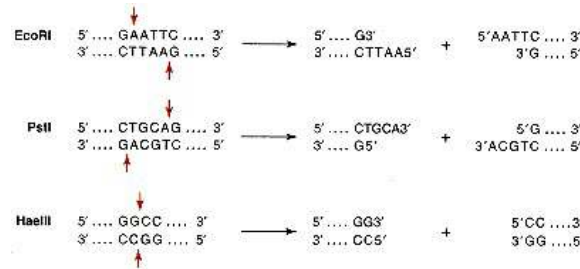

Figure 14.47
Types of products generated by type II restriction endonucleases.
 Enzymes exemplified by EcoRI and PstI nick on both sides of the center of symmetry of the palindrome, generating single-stranded stubs. Commonly used enzymes generate 5' ends, although some produce stubs with 3' ends as shown for PstI. Other restriction nucleases cut across the center of symmetry of the recognition sequence, producing flush or blunt ends, as exemplified by HaeIII.

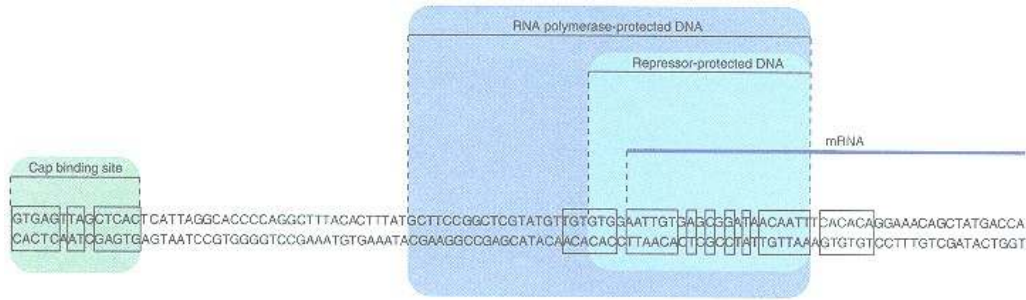

Figure 14.48

Nucleotide sequence of part of the DNA segment that controls synthesis of the enzyme β -galactosidase in *E. coli* (the *lac* operon).

The binding regions of the cap protein, which acts as an activator of transcription, and of the lac repressor protein, an inhibitor of transcription, are indicated. Also shown is the region of RNA polymerase interaction.

Two palindromic sequences are indicated by boxes.

Redrawn from Cantor, C. R., and Schimmel, P. R. *Biophysical Chemistry, Part I*. San Francisco: Freeman, 1980.
Copyright © 1980.

no cutting sites at all for a particular restriction endonuclease. The practical significance of this selectivity of restriction enzymes is that a particular enzyme generates a unique family of fragments for any given DNA molecule. This unique fragmentation pattern is called a **restriction digest**.

The availability of restriction enzymes for sectioning large DNA sequences and the development of new gel electrophoresis techniques for separating DNA segments have made the determination of sequences a simple matter. These sequencing techniques are described in Chapter 18.

Early attempts to determine DNA sequences were limited to small DNA fragments that could easily be separated from the remaining DNA. Sequences that bind selectively with various functional proteins, for example, RNA polymerase and the repressor proteins, were among the first to be determined. The binding protein protects the DNA section over which it is bound from the action of a nuclease and the protected DNA is recovered after digestion and removal of the protein. These studies indicated that many functional proteins and enzymes interact with DNA over regions of palindromic sequence (Figure 14.48).

Palindromes in DNA also serve as recognition sites for **methylases** that modify the host DNA by introducing methyl groups into two bases of the palindrome. Once methylated, these palindromes cannot be recognized by the corresponding restriction enzymes, and the DNA of the host is protected from cleavage.

Contemporary sequencing methods have made possible determination of the complete nucleotide sequences of the DNA of viruses and small bacteria and the partial sequence of many eukaryotic genomes. An ambitious current goal of DNA sequencing is the determination of the sequence of the entire human genome, which consists of almost 3×10^9 bp, and that of several other mammalian organisms.

Most Prokaryotic DNA Codes for Specific Proteins

In prokaryotes a large percentage of total chromosomal DNA codes for specific proteins. Bacterial genomes vary from about 500 kb to over 10,000 kb. More than one-half of the *E. coli* genome has been sequenced. This genome consists of about 4600 kb of DNA and contains as many as 3000 genes. The products

of about one-half of *E. coli* genes have already been identified. It is possible that some of the remaining "genes" do not code for expressible functional proteins. Eighty genes code for tRNA molecules.

In an overall sense, *E. coli* DNA is densely packed with sequence information; there is little repetition of information in the genome. As much as 1% of the *E. coli* genome is composed of multiple copies of short repetitive sequences known as **repeated extragenic palindromic elements (REP elements)**. REP elements are present at sites of DNA interaction with functional proteins as exemplified by the presence of such elements in the region of initiation of DNA synthesis (referred to as **OriC**). At **OriC**, **REP** elements with a consensus sequence of 34 nucleotides serve as sites for the binding of topoisomerase II, and REP elements with the sequence GCTGGTGG (**Chi** sites) bind the enzyme **RecBCD**, initiating DNA recombination. **Chi** sites are regularly spaced at intervals separated by about 4 kb.

Genetic information is even more densely organized in smaller organisms, such as bacteriophages, where the primary sequence of DNA reveals that structural genes—nucleotide sequences coding for protein—do not always have distinct physical locations. Rather, they frequently overlap with one another, as illustrated by the partial sequence of bacteriophage ϕ X174 shown in Figure 14.49. It is believed that this type of overlap provides for the efficient and

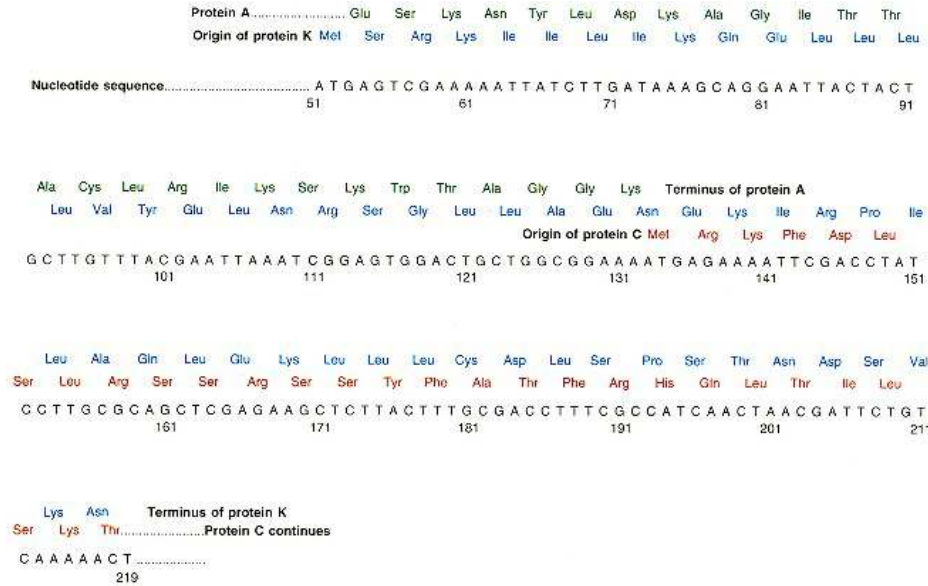

Figure 14.49

Partial nucleotide sequences of contiguous and overlapping genes of bacteriophage ϕ X174.

The complete nucleotide sequence of ϕ X174 is known. Only the sequence starting with nucleotide 51 and continuing to nucleotide 219 is shown in this figure. This sequence codes for the complete sequence of one of the proteins of ϕ X174, protein K. A part of the same sequence, nucleotide 51 to nucleotide 133, codes for part of the nucleotide sequence of another protein, protein A. The sequence coding for protein K, which starts with nucleotide 133, also codes for part of a third protein, protein C. Similar overlaps are noted between other genes of ϕ X174. Adapted with permission from Smith, M. Am. Sci. 67:61, 1979. *Journal of Sigma Xi*, The Scientific Research Society.

economic utilization of the limited DNA present in these organisms. This arrangement of genes may also be a factor in controlling the sequence in which genes are expressed.

Only a Small Percentage of Eukaryotic DNA Codes for Structural Genes

Eukaryotes have a much larger genome than prokaryotes, from about 1.5×10^7 bp for yeast to about 3.5×10^9 bp for the haploid human genome. The latter contains sufficient DNA to code for nearly 3×10^6 genes. It is estimated, however, that the human genome codes for no more than $70\text{--}100 \times 10^3$ genes. As a result, genetic information in the form of genes need not be as densely packed in eukaryotes as in bacteria. A typical mammalian DNA, with only 20 times as many genes as that of *E. coli*, contains 500 times more DNA than *E. coli*. Clearly then, structural genes—that is, genes coding for specific proteins—and sequences used to control gene expression cannot account for the entire DNA content of eukaryotic cells. In fact, only 10% of DNA present in a mammalian cell may suffice for all of its genes that are present. Some of the remaining DNA, such as DNA found in centromeres and telomeres, has well-defined function, but the majority of this uncoding DNA has been referred to as "junk" because no specific function could be assigned to it. However, there is increasing evidence that junk DNA may have a vital role in the regulation of gene expression during development.

Nucleotide sequences indicate that eukaryotic genes not only do not overlap but are instead spaced on the average 40 kb apart. However, some eukaryotic genes may be closer together in regions containing genes that are expressed in a tightly coordinated manner (gene families). As a rule eukaryotic genes are, in addition, interrupted by **intervening nucleotide sequences (IVSs)**, called **introns**, as shown in Figure 14.50. The nucleotide sequences in the gene that are expressed, either in the final RNA product (mature RNA) or as a protein, are termed **exons** (see p. 703). The **intervening genomic sequences (the introns)**, which are expressed in the initial RNA transcript and are considered part of the gene, are removed during the processing of the transcript. The remainder of the message, namely, the **exons**, is then ligated. This tailoring of the original transcript is referred to as **splicing**. The sequence and size of introns vary greatly among species, but generally these intervening segments are very large and, cumulatively, they may be five to ten times the length of the parts of the structural genes they separate. Most genes are interrupted by introns at least once, whereas others are interrupted repeatedly. Some genes, however, such as the gene for human interferon- α , contain no introns.

Introns are common in genes of vertebrates and flowering plants but occur infrequently in the genes of other species. The biological role of introns is not clear. Their presence in eukaryotes may represent a stage in the evolution of the gene, in that introns are rare in prokaryotes and much less common in lower eukaryotes, such as yeasts. It has been speculated that introns in eukaryo-

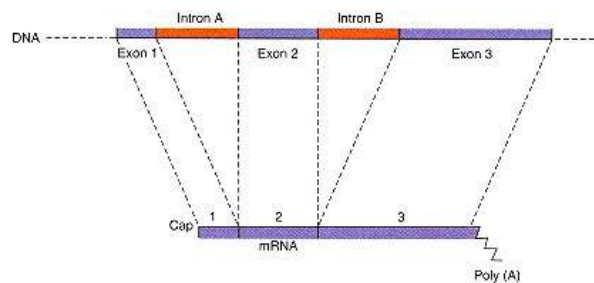

Figure 14.50
Schematic presentation of a eukaryotic gene.

The top horizontal line represents a part of the DNA genome of a eukaryote; the bottom line represents the mRNA produced by it. In this hypothetical example the DNA consists of two introns and three exons. The intron sequences are transcribed as hnRNA (precursor mRNA) but are not present in mature mRNA. Redrawn from Crick, F. *Science* 204:264, 1979.

Copyright © 1979 by the American Association for the Advancement of Science.

tic genes have arisen relatively recently in evolution as a result of migration of certain **mobile DNA elements (transposons)** from other parts of the genome and their insertion into protein-coding genes. These inserts subsequently lost, by mutation, their transposon-like character and therefore their mobility. Some repetitive DNA, such as the DNA found near centromeres and telomeres, may have well-defined structural and/or functional roles. Other repetitive DNA may simply be characterized as a leftover of evolutionary change with no identifiable function.

Repeated Sequences

As distinct from prokaryotes, where repetition of particular DNA sequences is very limited, the DNA of eukaryotes contains nucleotide sequences that are repeated anywhere from a few times, for certain coding genes, to millions of times per genome for certain simple, relatively short, sequences. Repetition of certain types of DNA sequences can be observed directly by electron microscopy, as in rRNA genes undergoing transcription. Depending on the species, **repetitive DNA** may constitute between 3% and 80% of the total DNA. In mammalian genomes, including the human, 25–35% of the DNA is repetitive.

Sequences are classified as **single copy**, **moderately reiterated**, and **highly reiterated**. The content of single-copy DNA varies among eukaryotes, increasing initially with genome size but reaching a plateau. Repetition classes are defined experimentally from their **rates of reassociation**. Reassociation rates also define a fourth class of DNA, **inverted repeats**.

A distinction between the terms "reiterated" and "repetitive" in describing a DNA sequence needs to be made. The term reiterated is used to describe a unique DNA sequence, usually several hundred nucleotides long, present in multiple copies in a genome. An individual DNA sequence is termed repetitive if a certain, usually short, nucleotide sequence is repeated many times over the DNA sequence.

The genome size of prokaryotic DNA can be determined by fragmenting the DNA, denaturing the fragments, and allowing them to reassociate and form double-stranded molecules. The kinetics of reassociation obey a second-order equation, indicating that essentially all the sequences in the prokaryotic genomes occur as single copies. When a mouse DNA was first studied by this method, unexpected results were obtained, which led to the realization that eukaryotic DNAs contain reiterated sequences. It was assumed that since the mammalian genome is about three orders of magnitude larger than the *E. coli* genome, the rates of reassociation of denatured mammalian DNA would be exceedingly slow. Instead, it turned out that a fraction of the mouse DNA, the highly repetitive fraction, reassociated far more rapidly than DNAs of small viruses. This is reasonable, since the probability that a fragment will encounter a complementary fragment leading to reassociation is proportional to the number of similar sequences repeated in the original DNA. The more reiterated the sequence, the more rapid the reassociation. Consequently, the reassociation kinetics of eukaryotic DNAs provided the first evidence for four classes of sequences. Inverted repeats and the highly repetitive sequences reassociate extremely rapidly. The unique sequences reassociate slowly, and the moderately reiterated at intermediate rates.

Most highly reiterated sequences have a characteristic base composition different from that of the remaining DNA. These sequences can be isolated by shearing the DNA into segments of a few hundred nucleotides each and separating the fragments by density gradient centrifugation. These fragments are termed **satellite DNA** because after centrifugation they appear as satellites of the band of bulk DNA. Other highly reiterated sequences, which cannot be isolated by centrifugation, can be identified by their property of rapid reannealing. Some of the highly reiterated sequences can also be isolated by digestion of total

DNA with restriction endonucleases that cleave at specific sites within the reiterated sequence. The exact boundaries separating the various types of reiterated DNAs do not appear to have been strictly defined.

Single-Copy DNA

About one-half of the human genome is made up of unique nucleotide sequences but, as indicated previously, only a small fraction of these sequences code for specific proteins. A part of the remaining DNA contains **pseudogenes**—that is, tracts of DNA that have significant nucleotide homology to a functional gene but contain mutations that prevent gene expression. These genes, which may be present in a frequency as high as one pseudogene for every four functional genes, significantly increase the size of eukaryotic genomes without contributing to their expressible genetic content. Additional DNA sequences are committed to serve as introns and as regions that are flanking genes.

Moderately Reiterated DNA

This class of DNA includes copies of identical or closely related sequences that are reiterated from a few to a thousand times. These sequences are relatively long, varying between a hundred to many thousand nucleotides before the same polynucleotide sequence is repeated. About 20% of mouse DNA occurs in lengths up to a few hundred base pairs that are repeated more than a thousand times. About 15% of the human genome consists of moderately reiterated DNA. Normally, single-copy and moderately reiterated sequences are present on the chromosome in an orderly pattern known as the **interspersion pattern**, which consists of alternating blocks of single-copy DNA and moderately reiterated DNA. Moderately repetitive sequences are further classified as **short interspersed repeats** that are families of related, but distinct, sequences typically 100–500 bp long and **long interspersed repeats** anywhere from about 100 bp up to several thousand base pairs long. Both short and long repeats are present at 1000 or up to 100,000 copies or more per genome. Long interspersed repeats consist of sequences several thousand nucleotides long that are present at up to 1000 copies per genome. These repeats are flanked on either side of the sequence by DNA sequences that are direct repeats (Figure 14.51). One

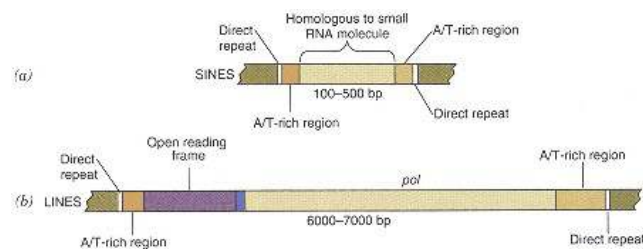

Figure 14.51
Short and long interspersed repeats in DNA.

Two types of interspersed repeats, short and long repeats, are found within eukaryotic DNA.

(a) Short interspersed repeats are sequences 100–500 bp long that are homologous to small RNA molecules such as tRNA, 5SRNA or 7SLRNA (signal recognition particle). The human version of 7SLRNA is referred to as the AU sequence and accounts for approximately 10% of human DNA.

(b) The long interspersed repeats that are present in hundreds of copies are homologous to tRNA genes and contain open reading frames with additional protein encoding sequences that resemble retroviral genes, such as the *Pol* gene. Both types of interspersed repeats contain short AT-rich sequences at the 3 terminals which are flanked by short direct repeat DNA.

example of a short interspersed repeat is the **Alu** family that constitutes a substantial portion (about 5%) of the human genome. **Alu** sequences consist of approximately 300 bp and are repeated over one-half million times. The structures of the short interspersed repeats, including the **Alu** family, are reminiscent of mobile DNA elements (transposons). The function of the **Alu** family remains to be established.

Interspersed repeats may have arisen during evolution from viruses or other transportable DNA elements that have been duplicated repeatedly and inserted into various locations within the chromosome. If this is the case, then short interspersed repeats would be nothing more than an evolutionary relic that performs no useful function for the host cell. On the assumption that this premise is correct, short interspersed repeats have been called "selfish DNA."

The interspersion pattern implicates the moderately reiterated sequences in control of transcription of structural genes since the large majority of structural genes are adjacent to reiterated sequences. A different type of moderately reiterated sequence occurs in the form of segregated tandem arrays. The two distinct types of arrangements of the moderately reiterated sequences appear to relate to different functions for these sequences. **Tandem arrays** are used for synthesis of products that must be rapidly generated in numerous copies, such as ribosomal RNA and certain proteins of specialized function. For example, in sea urchin oocyte histone, genes are amplified so that sufficient amounts of histone are available during the rapid cycles of DNA replication that follow fertilization. The genes for the five histones are arranged in tandemly repeated clusters, with each histone gene separated from its neighbor in the cluster by spacers about 400–900 nucleotides long. These spacers are AT-rich and can be separated as satellite DNA from the GC-rich DNA of the histone genes.

Single-copy and moderately repetitive sequences together normally account for more than 80% of the total nucleotide content of the eukaryotic genomes.

Highly Reiterated DNA

The remaining DNA consists of sequences constructed by the repetition, many thousand or even a million times, of a nucleotide sequence that is typically shorter than 20 nucleotides. About 10% of mouse DNA consists of 10-bp repeats that are reiterated millions of times in each cell. Because of the manner in which they are constructed, **highly reiterated DNAs** are also referred to as simple sequence DNA. Simple sequences are typically present in the DNA of most, if not all, eukaryotes. In some only one major type of simple sequence may be present. Thus in the rat the sequence 5'-GCACAC-3' is repeated every six bases. In other eukaryotes several simple sequences are repeated up to one million times. Some considerably longer repeat units for simple sequence DNA have also been identified. For instance, in the genome of the African green monkey a 172-bp segment is highly repeated and there are few sequence repetitions within the segment. Because of its characteristic composition, simple sequence DNA can often be isolated as satellite DNA. Satellite DNA found in the centromeres of higher eukaryotes consists of thousands of tandem copies of one or a few short sequences. **Satellite sequences** have been found to be only 5–10 bp long. Simple sequence (satellite) DNA is also a constituent of telomeres where it has a well-defined role in DNA replication.

Inverted Repeat DNA

Inverted repeats are a structural motif of **dos DNA**. Short inverted repeats, consisting of up to six nucleotides, such as the palindromic sequence GAATTC, occur by chance about once for every 3000 nucleotides. Such short repeats cannot form a stable "hairpin" structure formed by longer palindromic sequences. Inverted repeat sequences that are long enough to form stable "hair-

CLINICAL CORRELATION 14.7**Mutations of Mitochondrial DNA: Aging and Degenerative Diseases**

Somatic mutations, such as deletions of bases or oligonucleotide segments from mtDNA, are generated by oxygen damage during the life span of an individual. Somatic mutations in mtDNA are acquired at a much higher rate than in nuclear DNA. They are responsible for disorders associated with the process of oxidative phosphorylation and they may also be involved in aging and the development of degenerative diseases.

MtDNA mutations are the cause of Leber hereditary optic neuropathy (LHON). This disease, which is maternally inherited, is characterized by loss of vision in early adulthood, as a result of optic nerve degeneration. One mutation, an Arg to His substitution that leads to this disease, has been traced to a gene coding for NADH dehydrogenase (Complex I). The mutation results in mitochondria that are partially defective in electron transfer from NADH to ubiquinone and have a reduced capacity of ATP synthesis needed to support the active metabolic needs of neurons. LHON can also result from a single base change in the mitochondrial gene coding for cytochrome *b*. A mutation of the mitochondrial gene coding for a tRNA is responsible for myoclonic epilepsy and ragged-red-fiber disease (MERRF). This genetic disease, which is characterized by uncontrollable muscular jerking, is apparently caused by inadequate production of proteins that depend on mitochondrial transfer RNAs for their synthesis.

Deletions and rearrangements in mtDNA are noted with aging in both humans and mice. Five different mtDNA deletions have been noted with aged mice but these deletions are absent from young mice. The deletions involve a small portion (less than 0.01%) of total mtDNA. The deletion of a large portion of mtDNA (a 4977-bp segment), which is the most frequently noted DNA abnormality in patients with mitochondrial myopathies, is also noted, although to a much lesser degree, in tissues of healthy aging individuals.

The observations that mtDNA is easily mutated and poorly repaired have led to speculation that aging may be correlated with accumulation of somatic mutations in mtDNA. However, both environmental and genetic factors probably affect the aging process and aging is not likely to be explained solely as the result of defective mtDNA function.

Tanhauser, S. M., and Laipis, P. J. Multiple deletions are detectable in mtDNA of aging mice. *J. Biol. Chem.* 270:24769, 1995.

pins" are not likely to occur by chance, and therefore they should be classified as a separate class of eukaryotic sequences. Short repeats can easily be detected and quantitated on the basis of their extremely rapid rates of reassociation. In human DNA, about two million inverted repeats are present, with an average length of about 200 bp, although inverted sequences longer than 1000 bp have been detected. Some of these repeats may be separated by a spacer sequence that is not part of the inverted repeat. Most inverted repeat sequences are repeated 1000 or more times per cell.

Mitochondrial DNA

The **DNA of mitochondria (mtDNA)** is a small double-stranded circular structure of approximately 16,500 bp. In mammals, mtDNA makes up about 1% of total cellular DNA. Mitochondria contain multiple copies of DNA, usually distributed within several clusters. It is not known how this DNA is packaged but its structure probably resembles that of a bacterial chromosome rather than eukaryotic chromatin. The sequence of human mtDNA consists of 16,569 bp and contains 37 genes. Thirteen genes code for proteins that are subunits for factors essential for the maintenance of mitochondrial ATP synthesis. The remaining 24 genes code for mitochondria-specific RNAs, two ribosomal and 22 transfer RNAs.

The rate of mutation is one order of magnitude greater in the mitochondrial genome as compared to the nuclear genome. These high rates of mutation probably reflect a low fidelity of DNA replication, DNA repair, or both. Mitochondrial genes are maternally inherited because mitochondria from the sperm cells do not enter the fertilized egg. The effects of mtDNA mutations are discussed in Clin. Corr. 14.7.

Bibliography

- Bates, A. D. *DNA Topology*. Oxford, England: IRL Press, 1993.
- Binden, R. R. *DNA Structure and Function*. San Diego, CA: Academic Press, 1994.
- Borisova, O. F., Golova, Y. B., Gottikh, B. P., et al. Parallel double stranded helices and the tertiary structure of nucleic acids. *J. Biomol. Struct. Dyn.* 8:1187, 1991.
- Bouffler, S., Silver, A., and Cox, R. The role of DNA repeats and associated secondary structures in genomic instability and neoplasia. *Bioessays* 15:409, 1993.
- Bray, A. B., Lewis, J., Raff, M., Roberts, K., and Watson, J. D. *Molecular Biology of the Cell*, New York: Garland, 1994.
- Calladine, C., and Drew, H. *Understanding DNA—The Molecule and How It Works*. San Diego, CA: Academic Press, 1992.
- Clark, D. J., and Felsenfeld, G. Formation of nucleosomes on positively supercoiled DNA. *EMBO J.* 10:387, 1991.
- Clayton, D. A. Replication and transcription of vertebrate mitochondrial DNA. *Annu.-Rev. Cell Biol.* 7:453, 1991.
- Cortopassi, G., and Liu, Y. Genotypic selection of mitochondrial and oncogenic mutations in human tissue suggests mechanisms of age-related pathophysiology. *Mutat. Res.* 338:151, 1995.
- Cozzarelli, N. R., Boles, T. C., and White, J. H. Primer on the topology and geometry of DNA supercoiling. In: N. R. Cozzarelli and J. C. Wang (Eds.), *DNA Topology and Its Biological Effects*. Cold Spring Harbor, NY: Cold Spring Harbor Laboratory Press, 1990.
- De Vries, J. E., and de Waal Malefyt, R. *Therapeutic Applications of Oligonucleotides*. New York: Demos Vermande, 1995.
- Drake, J. W. Spontaneous mutation. *Annu. Rev. Genet.* 25:125, 1991.
- Drlica, K., and Riley, M. *The Bacterial Chromosome*. Washington, DC: American Society for Microbiology, 1990.
- Drlica, K., Bacterial topoisomerases and the control of DNA supercoiling. *Trends Genet.* 6:433, 1990.
- Drlica, K. Control of bacterial DNA supercoiling. *Mol. Microbiol.* 6:425, 1992.
- Getzenberg, R. H., Pienta, K. J., Ward, W. S., and Coffey, D. S. Nuclear structure and the three-dimensional organization of DNA. *J. Cell. Biochem.* 47:289, 1991.
- Han, J., Hsu, C., Zhu, Z., Longshore, J. W., and Finley, W. H. Over-representation of the disease associated (CAG) and (CGG) repeats in the human genome. *Nucleic Acids Res.* 22:1735, 1994.
- Haran, T. E., Kahn, J.D., and Crothers, D. M. Sequence elements responsible for DNA curvature. *J. Mol. Biol.* 244:135, 1994.
- Hardin, C. C., Henderson, E., Watson, T., and Prosser, J. K. Monovalent cation induced structural transitions in telomeric DNAs: G-DNA folding intermediates. *Biochemistry* 30:4460, 1991.
- Kamenetskii, F. *Unraveling DNA*. New York: VCH, 1993.
- Kim, M. G., Zhurkin, V. B., Jernigan, R. L. and Camerini-Otero, R. D. Probing the structure of a putative intermediate in homologous recombination: the third strand in the parallel DNA triplex is in contact with the major groove of the duplex. *J. Mol. Biol.* 247:874, 1995.
- Leach, D. R. Long DNA palindromes, cruciform structures, genetic instability and secondary structure repair. *Bioessays* 16:893, 1994.
- Lebowitz, J. Through the looking glass: the discovery of supercoiled DNA. *Trends Biochem. Sci.* 15:202, 1990.
- Lee, M. S., and Garrard, W. T. Positive DNA supercoiling generates a chromatin conformation characteristic of highly active genes. *Proc. Natl. Acad. Sci. USA* 88:9675, 1991.
- Lewin, B. *Genes V*. New York: Oxford University Press, 1994.
- Lindsten, J., and Pettersson, U. *Etiology of Human Disease at the DNA Level*. New York: Raven Press, 1991.
- Luzio, J. P., and Thompson, R. J. In: *Molecular Medical Biochemistry*, New York: Cambridge University Press, 1990.
- Mitas, M., Yu, A., Dill, J., Kamp, T. J., Chambers, E. J., Haworth, I. S. Hairpin properties of single-stranded DNA containing a GC-rich triplet repeat: (CTG)₁₅. *Nucleic Acids Res.* 23:1050, 1995.
- Neidle, S. *DNA Structure and Recognition*, 1st ed. Oxford, England: IRI. Press, 1994.
- Orphanides, G., and Maxwell, A. Topoisomerases. In one gate, out the other. *Curr. Biol.* 4:1006, 1994.
- Owen-Hughes, T., and Workman, J. L. Experimental analysis of chromatin function in transcription control. *Crit. Rev. Eukaryot. Gene Expr.* 4:403, 1994.
- Ozawa, T. Mitochondrial DNA mutations associated with aging and degenerative diseases. *Exp. Gerontol.* 30:269, 1995.
- Saluz, H. P., and Wiebauer, K. *DNA and Nucleoprotein Structure in Vivo*. New York: Demos Vermande, 1995.
- Soyfer, V. N., and Potaman, V. N. *Triple-Helical Nucleic Acids*. New York: Springer-Verlag, 1995.
- Therman, E., and Susman, M. In: *Human Chromosomes, Structure, Behavior and Function*, 3rd ed. New York: Springer-Verlag, 1992.
- Trinh, T. Q., and Sinden, R. R. Preferential DNA secondary structure mutagenesis in the lagging strand of replication in *E. coli*. *Nature* 352:544, 1991.
- Trinh, T. Q., and Sinden, R. R. The influence of primary and secondary DNA structure in deletion and duplication between direct repeats in *Escherichia coli*. *Genetics* 134:409, 1993.
- Turner, B. M. Histone acetylation and control of gene expression. *J. Cell. Sci.* 99:13, 1991.
- Ussery, D. W., and Sinden, R. R. Environmental influences on the in vivo level of intramolecular triplex DNA in *Escherichia coli*. *Biochemistry* 32:6206, 1993.
- Van Holde, K. E. *Chromatin*. New York: Springer-Verlag, 1989.
- Vologodskii, A. V., and Cozzarelli, N. R. Conformational and thermodynamic properties of supercoiled DNA. *Annu. Rev. Biophys. Biomol. Struct.* 23:609, 1994.
- Wang, C. I., and Taylor, J. S. Site-specific effect of thymine dimer formation on dA_n • dT_n tract bending and its biological implications. *Proc. Natl. Acad. Sci. USA* 88:9072, 1991.
- Wolfe, S. L. *Molecular and Cellular Biology*, Belmont, CA: Wadsworth, 1993.
- Wolffe, A. *Chromatin Structure and Function*. San Diego, CA: Academic Press, 1992.
- Yu, H., Eitija, R., Bloom, L. B., and Goodman, M. F. Ionization of bromouracil and fluorouracil stimulates base mispairing frequencies with guanine. *J. Biol. Chem.* 268:15935, 1993.

Questions

C. N. Angstadt and J. Baggott

1. A polynucleotide is a polymer in which:

- A. the two ends are structurally equivalent.
- B. the monomeric units are joined together by phosphodiester bonds.
- C. there are at least 20 different kinds of monomers that can be used.
- D. the monomeric units are not subject to hydrolysis.
- E. purine and pyrimidine bases are the repeating units.

2. The best definition of an endonuclease is an enzyme that hydrolyzes:

- A. a nucleotide from only the 3' end of an oligonucleotide.
- B. a nucleotide from either terminal of an oligonucleotide.
- C. a phosphodiester bond located in the interior of a polynucleotide.
- D. a bond only in a specific sequence of nucleotides.
- E. a bond that is distal (d) to the base that occupies the 5' position of the bond.

3. All of the following tend to favor a helical conformation of a single polynucleotide chain EXCEPT:

- A. hydrophobic interactions of the rings of the purine and pyrimidine bases that exclude water.
- B. interchange of electrons in the π orbitals of the purine and pyrimidine bases.
- C. charge–charge repulsion of phosphate residues of the polynucleotide backbone.
- D. hydrogen bonding between appropriate purine–pyrimidine pairs.
- E. spacing of bases in the helical conformation that excludes water.

4. In a DNA double helix:

- A. the individual strands are not helical.
- B. hydrogen bonds form between a purine and a pyrimidine base on the same strand.
- C. adenine on one strand is hydrogen-bonded to thymine on the opposite strand.
- D. phosphodiester bonds are oriented toward the interior of the helix.
- E. the outside of the helix is neutral.

5. The A helix of DNA differs from the B helix in all of the following EXCEPT:

- A. appearance of the major and minor grooves.
- B. pitch of the base pairs relative to the helix axis.
- C. thickness of the helix.
- D. tilt of the bases.
- E. polarity of the strands.

6. The Z DNA helix:

- A. has fewer base pairs per turn than the B DNA.
- B. is favored by an alternating GC sequence.
- C. tends to be found at the 3' end of genes.
- D. is inhibited by methylation of the bases.
- E. is a permanent conformation of DNA.

Use the accompanying figure to answer Questions 7 and 8.

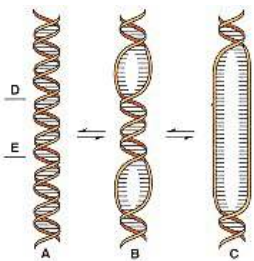

7. A, B, and C represent conformations at different temperatures. Which one represents the highest temperature?

8. Which section, D or E, has the higher content of guanine and cytosine?

Refer to the following for Questions 9–11.

- A. annealing
- B. electrophoresis
- C. equilibrium centrifugation
- D. C_0t curves

9. A technique for determining the molecular weight of large (10^5 to 10^9 Da) DNA.

10. A technique involved in locating a specific gene on DNA with a probe.

11. A technique for assessing genome complexity.

12. The superhelices that form in double-stranded circular DNA:

- A. may have fewer turns of the helix per unit length than does a linear double helix.
- B. are associated with a restricted topological domain.
- C. may exist in multiple conformations that are interconvertible without breaking covalent bonds.
- D. may be either formed or relaxed by enzymes called topoisomerases.
- E. all of the above are correct.

13. Triple-stranded DNA:

- A. generally occurs in DNA in regions that play no role in transcription.
- B. involves the formation of Hoogsteen pairs.
- C. is characterized by the presence of a string of alternating purine–pyrimidine bases.
- D. forms only intermolecularly.
- E. assumes a cruciform conformation.

Using the accompanying figure to answer Questions 14–16.

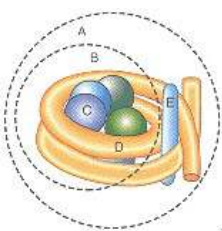

14. A chromosome.

15. DNA.

16. H1 class of histones.

17. A palindrome is a sequence of nucleotides in DNA that:

- A. is highly reiterated.
- B. is part of the introns of eukaryotic genes.
- C. is a structural gene.
- D. has local symmetry and may serve as a recognition site for various proteins.
- E. has the information necessary to confer antibiotic resistance in bacteria.

18. An interspersion pattern in DNA consists of:

- A. highly repetitive DNA sequences.
- B. the portion of DNA composed of single copy DNA.
- C. Alu sequences.
- D. alternating blocks of single copy DNA and moderately repetitive DNA.
- E. alternating blocks of short interspersed repeats and long interspersed repeats.

Answers

1. B A: The structure of a polynucleotide possesses an intrinsic sense of direction that does not depend on whether a 3'-OH or 5'-OH terminal is esterified C and E: There are only four different monomers, and the repeating unit is the base mono-phosphate (p. 566).
2. C Both A and B describe exonucleases. D does refer to an endonuclease but only to a specific type, a restriction endonuclease, and is therefore not a definition of the general type. E: Both endo- and exonucleases show specificity toward the bond hydrolyzed and so this is not a definition of an endonuclease (p. 568).
3. D This is very important in holding two different polynucleotide chains together, but it is unlikely that the proper positioning would occur within a single chain. A, B, C, and E: The exclusion of water by stacking of the bases is a strong stabilizing force that is enhanced by the interaction of π orbital electrons. The repulsive forces of the phosphate groups confer a certain rigidity to the structure (pp. 568–569).
4. C This results in complementarity of the strands. A: Single strands are right-handed helices. B: Bases in a single stand interact through the hydrophobic faces of the rings. D and E: The phosphate groups are negative and on the exterior of the helix (p. 580).
5. E The two strands are always antiparallel. A: The A helix has a narrower and deeper major groove and a wider and shallower minor groove than B. B and D: Bases in the B helix are almost perpendicular to the helix axis while those in A are tilted. C: The B helix is thinner than the A (pp. 570–573).
6. B The alternating purine-pyrimidine sequence is important. A: Z DNA is longer and thinner than the B form because it has 12 bp per turn instead of 10. C: It is more likely to be found at the 5' end, consistent with one of its proposed roles in transcriptional regulation D: Methylation favors the Z form in which the methyl is protected from water. E: B → Z transition is influenced by such things as methylation and rotation of the G to the syn conformation (p. 574).
7. C; 8. E. The figure represents the process of denaturation with the extent of disruption increasing as temperature increases. Since a guanine–cytosine pair has three hydrogen bonds and an adenine–thymine pair only has two, higher temperatures are required to disrupt regions high in G-C (Figure 14.14).
9. C Equilibrium centrifugation is a method for determining molecular weight, but it is limited to a molecular weight of 10^9 Da or less because of the effects of shear forces on large molecules (p. 586).
10. A The probe is a labeled polynucleotide with a sequence complementary to the gene of interest. Annealing of the two permits location of the gene (pp. 580 and 582).
11. D Frequency of reassociation is dependent on amounts of highly reiterated versus unique sequences (p. 580).
12. E A describes a negative superhelix. There may also be more turns per unit length in a positive superhelix. B: Once a closed system is interrupted, a superhelix can unwind. C: All conformations with the same linking number L are interconvertible without breaking covalent bonds. D: Topoisomerase I (omega protein) from *E. coli* relaxes and gyrase (topoisomerase II) can introduce or remove superhelices (depending on the conditions) (pp. 587–592).
13. B Hoogsteen pairs, like TAT or GGC, are responsible for holding the third strand in the major groove. A: They are found frequently in regions involved in gene regulation. C: The required sequence is a homopurine string. D: They can also form intramolecularly by unfolding and refolding of the DNA. E: A cruciform is an alternate conformation of DNA but does not involve a third strand (pp. 595 and 597).
14. A; 15. D; 16. E. The chromatosome, the basic structural element of nucleoprotein, contains the nucleosome core with associated H1 histones. B: The nucleosome core is a discrete particle consisting of an octamer of specific histones with a segment of DNA wrapped around it. D: The strand depicted represents DNA; the circles, histones. E: The H1 class of histones is bound to the spacer regions between nucleosomes. C: Represents one of the histones (H2A, H2B, H3, or H4), which are part of the nucleosomes (Figure 14.43).
17. D A palindrome, by definition, reads the same forward and backward. Short palindromic segments of DNA are recognized by a variety of proteins such as restriction endonucleases and CAP-binding protein. A is not likely since it would be incompatible with specific recognition B is possible but has not been shown. C is not correct since genes are thousands of base pairs in length, whereas palindromes are short segments. E also would not be likely because palindromes are too short (p. 610).
18. D A and B: These are two of several kinds of DNA but do not constitute patterns. C and E: Alu is a type of short interspersed repeat. Short and long interspersed repeats are the two classes of moderately repetitive DNA (p. 615).

**Chapter 15—
DNA II:
Repair, Synthesis, and Recombination**

Stelios Aktipis

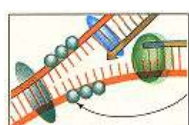

15.1 Overview	622
15.2 Formation of the Phosphodiester Bond <i>in Vivo</i>	622
DNA-Dependent DNA Polymerases of <i>E. coli</i>	622
Synthetic Activity	623
Proofreading Activity	624
Structure of Polymerases	624
Eukaryotic DNA Polymerases	625
15.3 Mutation and Repair of DNA	627
Mutations Are Stable Changes in DNA Structure	627
Chemical Modification of Bases	628
Radiation Damage	629
DNA Polymerase Errors	630
Stretching of the Double Helix	631
DNA Is Repaired Rather Than Degraded	633
Excision Repair in <i>E. coli</i>	635
Eukaryotic Excision Repair	636
Mismatch Repair	638
Mechanisms That Reverse Damage	640
Postreplication Repair	641
SOS Postreplication Repair	642
15.4 DNA Replication	642
Complementary Strands Are Basic to the Mechanism of Replication	642
Replication Is Semiconservative	643
A Primer Is Required	644
Both Strands of DNA Serve As Templates Concurrently	646
Synthesis Is Discontinuous	646
Macroscopic Synthesis Is As a Rule Bidirectional	647
Strands Must Unwind and Separate	647
<i>Escherichia coli</i> Provides Basic Model for Replication of DNA	649
Initiation and Progression of DNA Synthesis	649
Termination of DNA Synthesis	651
Rolling Circle Model for Replication	652
Eukaryotic DNA Replication	653
Role of Eukaryotic DNA Polymerases	654
Initiation of Eukaryotic DNA Replication	656
DNA Replication at the End of Linear Chromosomes	657
Prokaryotic Replication	659
Eukaryotic Replication: Telomerases	659
DNA Can Be Synthesized Using an RNA Template	660
DNA Replication, Repair, and Transcription Are Closely Coordinated	660
15.5 DNA Recombination	661
Homologous Recombination	663
Enzymes and Proteins That Catalyze Homologous Recombination	665
Site-Specific Recombination	668
Transposition	669
15.6 Sequencing of Nucleotides in DNA	671
Restriction Maps Give the Sequence of Segments of DNA	671
Bibliography	673
Questions and Answers	673
Clinical Correlations	
15.1 Mutations and the Etiology of Cancer	633
15.2 Defects in Nucleotide Excision Repair and Hereditary Diseases	638
15.3 DNA Ligase Activity and Bloom Syndrome	639
15.4 DNA Repair and Chemotherapy	639
15.5 Mismatch DNA Repair and Cancer	641
15.6 Telomerase Activity in Cancer and Aging	658
15.7 Inhibitors of Reverse Transcriptase in Treatment of AIDS	661
15.8 Immunoglobulin Genes Are Assembled by Recombination	663
15.9 Transposons and Development of Antibiotic Resistance	670
15.10 DNA Amplification and Development of Drug Resistance	671
15.11 Nucleotide Sequence of the Human Genome	672

15.1— Overview

Although the processes of DNA repair, DNA synthesis, and DNA recombination are presented in a somewhat independent and self-contained manner, in reality DNA repair, synthesis, and recombination are intimately connected and interdependent. Furthermore, these DNA-directed processes are also closely associated with other DNA-dependent operations and more specifically DNA transcription reviewed in Chapter 16. Some of these interconnections are indicated in this chapter. The first area to be examined is the enzymatic repair of randomly induced changes in the chemical structure of the DNA bases. A review of the processes of DNA synthesis and DNA recombination completes the chapter.

Both the repair of DNA and particularly the replication of DNA are very complex processes. Although key similarities in the mechanisms of DNA repair are discernible among different organisms, a considerable amount of diversity exists in terms of individual detail. The same is true regarding the process of DNA synthesis. This diversity defeats any attempt to present a simplified and universally applicable model of these processes. To resolve this difficulty the basic elements of the substeps of each process are first described and subsequently integrated for prokaryotes, using as an example the *Escherichia coli* replication system. Eukaryotic replication is treated separately and its similarities and differences with prokaryotic replication are highlighted.

15.2— Formation of the Phosphodiester Bond *in Vivo*

DNA-Dependent DNA Polymerases of *E. coli*

An apparent common denominator between the processes of DNA replication and repair is the enzymatically catalyzed synthesis of DNA polynucleotide segments, which can be assembled with preexisting polynucleotides, leading to repair or replication. Synthesis of these polynucleotide segments is catalyzed by a family of enzymes, **DNA-dependent DNA polymerases**. In the case of *E. coli*, DNA polymerase has been isolated in three distinct forms, polymerases I, II, and III as listed in Table 15.1. All DNA polymerases have a 3' → 5' exonuclease activity in addition to the synthetic activities. Polymerase I also has a 5' → 3' exonuclease activity. Generally speaking, polymerase III is involved in DNA synthesis and polymerase I is involved in both synthesis and repair. Polymerase II is also involved in DNA repair but its function is highly specialized.

TABLE 15.1 Properties of DNA Polymerases I, II, and III of *E. coli*

	<i>Pol I</i>	<i>Pol II</i>	<i>Pol III (core)</i>
Function			
Polymerization: 5' → 3'	Yes	Yes	Yes
Exonuclease: 3' → 5'	Yes	Yes	Yes
Exonuclease: 5' → 3'	Yes	No	No
Size (kDa)	103	90	(167, 130, 27.5, 10) ^a
Molecules per cell	400	—	10–20
Turnover number ^b	600	30	9000
Structural genes	<i>polA</i>	<i>polB</i>	<i>polC</i> ^c

Source: Adapted from Kornberg, A., and Baker, T. A. *DNA Replication*, 2nd ed. New York: Freeman, 1992.

^a Sizes of the α , β , and γ subunits.

^b Nucleotides polymerized at 37°C/min/molecule of enzyme.

^c Also known as *dnaE*, the gene for the large (α) subunit.

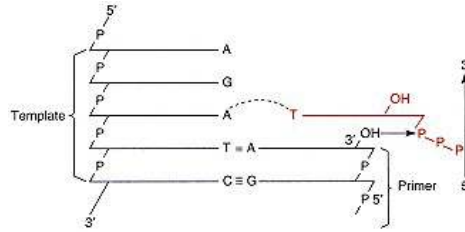

Figure 15.1

Synthetic activity of DNA polymerase.

DNA polymerase catalyzes polymerization of nucleotides in the 5' → 3' direction. A phosphodiester bond is formed between a free 3'-hydroxyl group of the strand undergoing elongation (the primer) and an incoming deoxyribonucleoside 5'-triphosphate.

Pyrophosphate is eliminated.

Redrawn based on figure in Kornberg A. *Science* 163:1410, 1969.

Copyright 1969 by the American Association for the Advancement of Science.

Synthetic Activity

Figure 15.1 shows two complementary DNA strands of unequal length in which the shorter strand has a free 3' terminus. DNA polymerase catalyzes addition of 5'-deoxynucleoside triphosphates to the 3' terminus of the short strand, called the **primer**. The term primer applies to the terminus of a molecule, in this instance the 3'-polynucleotide end, onto which additional monomeric units can be added. The free portion of the longer complementary strand is the **template** that directs the condensation of selected 5'-deoxynucleotides onto the growing primer. The template is a single strand of nucleic acid providing the specific information necessary for the synthesis of a complementary strand. DNA polymerase requires both a primer and a template in order to function.

As seen from Table 15.2, polymerase III catalyzes the elongation of a primer with a much higher degree of efficiency than polymerase I. The enhanced catalytic efficiency of polymerase III is partially attributable to the higher **processivity** of this enzyme. After a polymerase has added a nucleotide residue on the 3'-OH terminus of the primer, it may dissociate from the primer and bind at random to another partially completed polynucleotide chain, or it may remain bound to the original template until many subsequent residues are added to it. Enzymes that tend to remain bound to their substrates through many rounds of polymerization are said to be processive. Polymerase I is less processive in that it tends to dissociate from the template after incorporating only a few nucleotides. Although processivity *per se* does not determine the catalytic rate, it is apparent that an enzyme with high catalytic activity, such as polymerase III, can achieve its optimal catalytic rate only if it is also highly processive.

DNA polymerases permit selection of 5'-deoxyribonucleoside triphosphates, one at a time, with a base complementary to that present in the corre-

TABLE 15.2 Major Subunits and Subassemblies of DNA Polymerase III

Subunit	Mass (kDa)	Gene		Function
α	130 ^a	<i>dnaE</i>	}	Pol III (core) 3' → 5' exonuclease
	27.5 ^a	<i>dnaQ (mutD)</i>		
	10			, assembly?
γ	71 ^a	<i>dnaX</i>	}	γ Complex Assembly of holoenzyme on DNA Part of the γ complex (Enhances processivity; assists in replisome assembly)
	47.5 ^a	<i>dnaX</i>		
	35	<i>holA</i>		
	33	<i>holB</i>		
	15	<i>holC</i>		
	12	<i>holD</i>		
	40.6 ^a	<i>dnaN</i>		Sliding clamp, processivity

Source: Adapted from Kornberg, A., and Baker, T. A. *DNA Replication*, 2nd ed. New York: Freeman, 1992.

^a Subunits γ, δ, ε, and θ form the so-called γ complex responsible for adding β subunits to DNA.

sponding position of the template. The specificity of the polymerase reaction with respect to the template is vested in the strong association of each of the bases of the template with their normal complementary partners present in the cell as free 5'-deoxyribonucleotides. Strong binding between complementary bases is apparently achieved because the bases become confined within custom-fitted cages created by appropriate hydrophobic regions of the DNA polymerase. As a result, the reading of the template is accurate but not completely free of error. Ionized forms of the bases apparently promote **mispairing** during DNA synthesis. As an example, 5-bromodeoxyuracil pairs with guanine when present in an ionized form, as shown in Figure 15.2, instead of its normal partner, adenine. In this instance, the hydroxyl group at C-4 upon loss of a proton acquires a negative charge and changes the hydrogen-bonding properties of 5-bromouracil. Similarly, 2-aminopurine, which normally pairs with thymine in its ionized form, may mispair with cytosine. The natural bases can also undergo ionizations, giving rise to a number of alternative base pairing schemes that produce atypical base pairs leading to misincorporation of bases.

Proofreading Activity

The presence of ionized bases accounts for the incorporation into DNA of inappropriate bases at a ratio of about 1 per 10^4 to 10^5 nucleotide incorporations. Yet, the experimentally measured misincorporation of nucleotides is lower and it does not exceed an error rate of 10^{-8} . The discrepancy is accounted for by the existence of a "**proofreading**" mechanism that allows removal, by the polymerase, of erroneously introduced nucleotides. The removal is carried out by the 3' → 5' exonuclease activity that characterizes almost every known polymerase, suggesting that proofreading is essential for accurate DNA synthesis. Because of this activity, polymerases can temporarily reverse their synthetic activities and function as exonucleases. The proofreading activity is triggered when a mismatch between the template base sequence and a newly introduced nucleotide at the 3'-OH terminus of the primer occurs. However, some polymerases ensure that a very large percentage of mismatched bases are removed by inadvertently removing a substantial percentage of correctly introduced bases as well. Overall, proofreading fails to remove less than 1 in 10^3 improperly incorporated nucleotides.

Structure of Polymerases

Recall that **polymerase I** has three distinct enzyme activities, namely, a 5' → 3' synthetic activity and 3' → 5' and 5' → 3' exonuclease activities. Chemical and mutation studies of the enzyme have shown that these activities originate from three distinct active sites on the enzyme. Cleavage of polymerase I by the protease subtilisin leads to the formation of a small fragment (30-kDa mass) with 5' → 3' activity and a larger fragment (70-kDa mass), known as the **Klenow fragment**, having the synthetic activity (5' → 3' polymerization) and 3' → 5' exonuclease activity, which is required for **proofreading** during DNA synthesis. X-ray diffraction studies, on cocrystals of DNA and polymerase I, suggest that DNA makes a sharp bend between the 3' → 5' exonuclease site and the synthetic

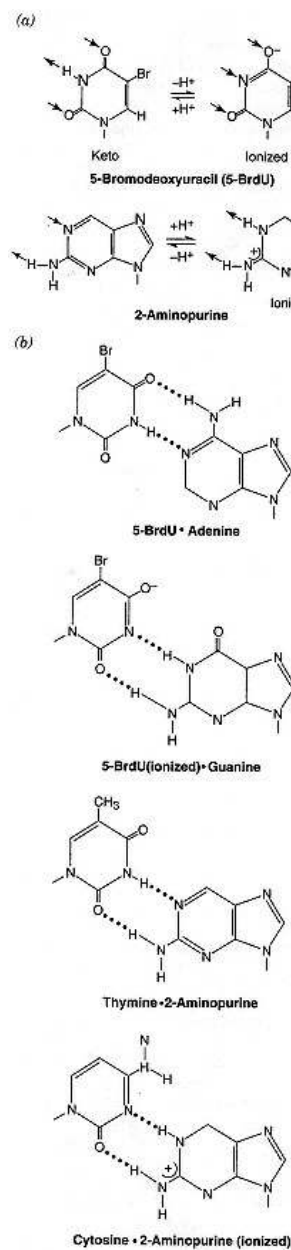

Figure 15.2

DNA base pairing of ionized forms of bases.

Ionization of 5-bromodeoxyuracil (BrdU), a base analog of T, results in dissociation of a proton from the N-3 position of the pyrimidine ring whereas ionization of 2-aminopurine (2-AP), which is a base analog of A, involves dissociation of a proton from the N-1 position of the purine ring. Normal forms of these bases are in equilibrium with small amounts of the ionized forms. The ionized form of BrdU mispairs with G instead of the normal partner of T, which is A, and ionized 2-AP mispairs with C instead of the normal partner of A, which is T.

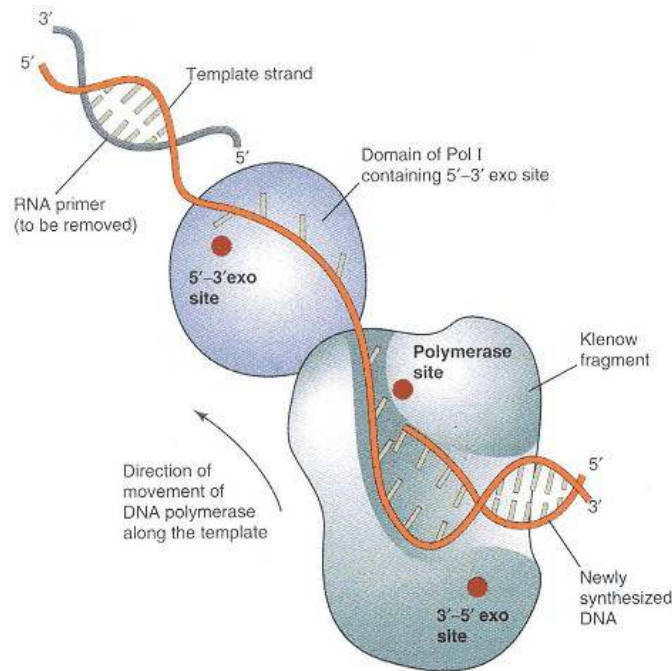

Figure 15.3
Model for the structure of DNA polymerase I-DNA complex.

Klenow fragment of DNA polymerase I includes the 5' → 3' polymerization site and the 3' → 5' proofreading site. The remaining segment of the enzyme contains the 5' → 3' exonuclease site, which is used for DNA repair and the removal of RNA primers from Okazaki segments. In this drawing the 3' growing end of a polynucleotide chain is in contact with the active site in the Klenow fragment, which is involved in elongation of the chain. The 3' end is shifted near the 3' → 5' exonuclease active site, probably by sliding of the enzyme along the DNA without dissociation from the template.

Adapted from Bease, L. S., Derbyshire, V., and Steitz, T. A. *Science* 260:352, 1993.

site located 3.5 nm away (Figure 15.3). When the polymerase active site detects a mismatch, the 3' terminus of the DNA primer is guided into the 3' → 5' exonuclease site for removal of the mismatched base and then guided back to the polymerization site for further elongation.

Polymerase III has the same 5' → 3' synthetic and 3' → 5' exonuclease activities as polymerase I except that the processivity and polymerase activity of the former are much higher than the corresponding properties of the latter. Polymerase III is a more complex enzyme than polymerase I, consisting of at least ten different protein subunits (Table 15.2). The catalytic core of the enzyme consists of subunits α , β , and γ and has a composite mass of about 167 kDa. Polymerization activity is vested in subunit α and 3' → 5' exonuclease activity in subunit β . The function of the γ subunit is not clear but it may contribute to the interaction between α and β or α with other subunits of the polymerase. The γ subunit participates in initiation of DNA synthesis. Subunits δ , ϵ , ζ , and η appear to support the processivity properties of the enzyme. Formation of a complex of γ , δ , ϵ , and ζ during initiation of DNA synthesis catalyzes ATP-dependent transfer of a pair of β subunits to the DNA template. These two β subunits form a clamp around the template that allows the multisubunit assembly to slide along the DNA without dissociation from the template. The subsequent binding of the catalytic core to the clamp of the β subunits generates a molecule of template-bound polymerase III holoenzyme that is a fully functional assembly (Figure 15.4). This sliding clamp is responsible for the remarkable degree of processivity exhibited by DNA polymerase III.

Eukaryotic DNA Polymerases

Less is known about **eukaryotic DNA polymerases**, relative to the *E. coli* polymerase. Five main types of polymerases have been isolated from mammalian cells (Table 15.3). With the exception of polymerase γ , which occurs in mitochondria, the remaining polymerases are involved in chromosomal DNA synthesis and repair. As with the three polymerases of *E. coli*, all five eukaryotic polymerases are characterized by 5' → 3' synthetic activities, but unlike the prokaryotic polymerases not all eukaryotic polymerases are vested with 3' → 5' exonuclease (proofreading) activities. Among eukaryotic polymerases only polymerase δ , which is primarily a repair enzyme like its counterpart in *E. coli*,

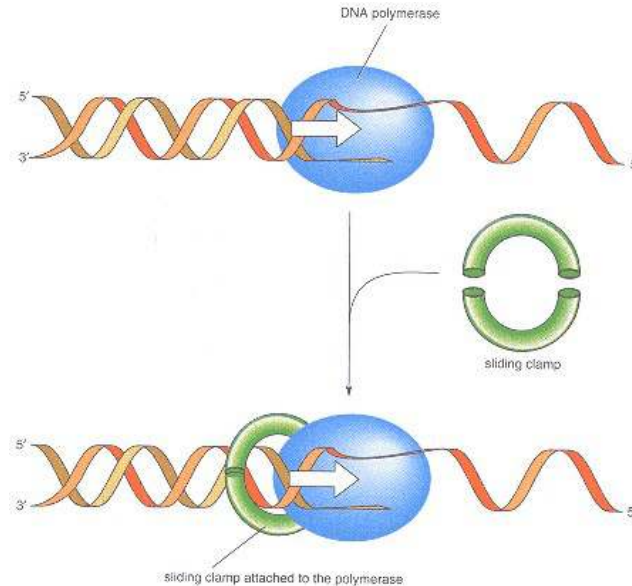

Figure 15.4

Model for the "clamp" that holds DNA polymerase III on the template.

The high processivity of DNA polymerase III is attributed to the formation of a sliding "clamp" that prevents the enzyme from dissociating from the template until DNA replication is completed. The sliding clamp is formed by the association of two β subunits of the polymerase that produces a donut-like structure having a hole with a diameter of about 3.5 nm. This hole easily accommodates B-DNA that has a diameter of no more than 2.5 nm. Upon completion of the synthesis, the two halves of the clamp dissociate and DNA polymerase is freed.

polymerase I, is vested with all three activities, namely, 5' \rightarrow 3' synthetic, 3' \rightarrow 5' exonuclease, and 5' \rightarrow 3' exonuclease activities. Polymerase β is also a repair enzyme but, since it lacks 3' \rightarrow 5' exonucleolytic activity necessary for proofreading, its fidelity is low. In analogy with polymerase III of *E. coli*, polymerases α and δ are the primary synthetic enzymes in eukaryotes and work in close association with each other. Of these two enzymes only polymerase α has a 3' \rightarrow 5' exonuclease activity that is necessary for the proofreading function. It is not clear whether polymerase δ in fact lacks 3' \rightarrow 5' activity or whether for some reason it is difficult to detect this activity *in vitro*. DNA polymerase ϵ is associated with a 37-kDa subunit, the **proliferating cell nuclear antigen (PCNA) protein**, that shows homology to the β subunit of polymerase III responsible for the high processivity of polymerase III. PCNA

TABLE 15.3 Biochemical Properties of Eukaryotic DNA Polymerases^a

Property	α	δ	ϵ	β	γ
Mass (kDa)					
Nativex	> 250	170	256	36–38	160–300
Catalytic core	165–180	125	215	36–38	125
Other subunits	70, 50, 60	48	55	None	35, 47
Activities					
3' \rightarrow 5' Exonuclease	No	Yes	Yes	No	Yes
Processivity	Low	High	High	Low	High
Fidelity	High	High	High	Low	High

Source: Adapted from Kornberg, A., and Baker, T. A. *DNA Replication*, 2nd ed. New York: Freeman, 1992.

^a With the exception of polymerase γ , which is a mitochondrial enzyme, all other polymerases are located in the cell nucleus.

endows polymerase with very high processivity and is also involved in eukaryotic DNA excision repair (see p. 636).

In an overall sense DNA polymerases operate at a high level of fidelity, which is required of their function as DNA replicating and repair enzymes. *Escherichia coli* polymerases have an overall error rate in base incorporation of 10^{-7} to 10^{-8} . The experimentally observed accuracy for DNA replication in *E. coli*, however, is substantially higher, with errors made at the rate of only one for every 10^9 to 10^{10} nucleotides incorporated. The discrepancy in these numbers is accounted for by the operation of a DNA repair system that removes mismatched bases that have escaped the scrutiny of the proofreading activity of the polymerases. This repair system, known as the **mismatch repair** system, is examined on page 638.

The necessity to maintain high fidelity in replication is probably also the reason why polymerases synthesize polynucleotides only in the 5' → 3' direction. If polynucleotide chains could be elongated in the 3' → 5' direction, the hypothetical growing 5' terminus, rather than the incoming nucleotide, would carry a triphosphate that is unsuitable for further elongation by the synthetic activity of the polymerase.

15.3—

Mutation and Repair of DNA

Mutations Are Stable Changes in DNA Structure

One of the fundamental requirements for a structure that serves as a permanent depository of genetic information is high stability. Such stability is essential, at least in those parts that code for the genetic information. The structure of the DNA bases, however, is not totally exempt from gradual change. Normally, changes occur infrequently and they affect very few bases. Chemical and irradiation-induced reactions modify the structure of some bases, disrupt phosphodiester bonds, and sever strands. Extensive chemical changes of the bases occur spontaneously. Errors also occur during replication and DNA recombination, leading to incorporation of one or more erroneous bases. In almost every instance, however, a few cycles of DNA replication are required before a modification in the structure of a base can lead to irreversible damage. In effect, DNA polymerases must use the polynucleotide initially damaged as a template for the synthesis of a complementary strand for the initial change to become permanent. As Figure 15.5 suggests, use of the damaged strand as template extends the damage from a change of a single base to a change of a complete base pair and subsequent replication perpetuates the change. Other sources of permanent modifications of DNA include changes resulting from insertion to deletion from a DNA of short or longer nucleotide sequences during the process of DNA recombination (see p. 661). Intercalation of certain planar organic ring structures can also lead to insertion of nucleotides (see p. 631). Finally, deletions may occur as a result of chemical modification of the bases.



Figure 15.5

Mutation perpetuated by replication.

Mutations introduced on a DNA strand, such as the replacement of a cytosine by a uracil resulting from deamination of cytosine, extend to both strands when the damaged strand is used as a template during replication.

In the first round of replication uracil selects adenine as complementary base. In the second round of replication uracil is replaced by thymine. Similar events occur when the other bases are altered.

Irreversible alteration of a few DNA base pairs can cause drastic changes in the organism. These changes, referred to as **mutations**, may be hidden or visible, that is, **phenotypically silent** or **expressed**. Therefore a mutation is defined as a stable change in the DNA structure of a gene, which may be expressed as a phenotypic change in the organism. Mutations may be classified into two categories: **base substitutions** and **frameshift mutations**. Base substitutions include **transitions**, substitutions of one purine–pyrimidine pair by another, and **transversions**, substitutions of a purine–pyrimidine pair by a pyrimidine–purine pair. Frameshift mutations, which are the most radical, are the result of either the insertion of a new base pair or the deletion of a base pair or a block of base pairs from the DNA base sequence of the gene. These changes are illustrated in Figure 15.6.

Chemical Modification of Bases

Irradiation and certain chemical compounds are recognized as among the main mutagens. The incorporation of erroneous bases by DNA polymerase can also lead to mutations. Other mutations occur spontaneously. Bases in DNA are sensitive to the action of numerous chemicals including nitrous acid (HNO_2), hydroxylamine (NH_2OH), and various alkylating agents such as dimethyl sulfate and *N*-methyl-*N*⁸-nitro-*N*-nitrosoguanidine. Chemical modifications of bases, brought about by these reagents, are shown in Figure 15.7.

Conversion of guanine to xanthine by nitrous acid has no effect on the hydrogen-bonding properties since xanthine, the new base, can pair with cytosine, the normal partner of guanine. However, the conversion of either adenine to hypoxanthine or the change from cytosine to uracil disrupts the normal hydrogen bonding of the double helix, because neither hypoxanthine nor uracil can form complementary pairs with the base present in the initial double helix (Figure 15.8). Subsequent replication of the DNA extends and perpetuates these base changes (Figure 15.5). Alkylating agents may affect the structure of the bases as well as disrupt phosphodiester bonds so as to lead to the fragmentation of the strands. In addition, certain alkylating agents can interact covalently with both strands, creating interstrand bridges.

DNA undergoes spontaneous changes as a result of various physical perturbations, such as thermal fluctuations or reactions with reactive forms of oxygen. Spontaneous **deamination of cytosine** in human DNA occurs at a rate of

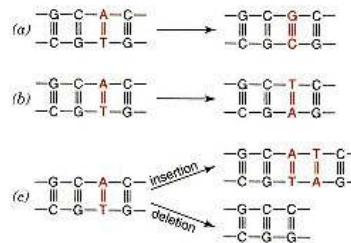

Figure 15.6
Mutations.

Mutations are classified as transition, transversion, and frameshift. Bases undergoing mutation are shown in color.

(a) Transition: A purine–pyrimidine base pair is replaced by another. This mutation occurs spontaneously or can be induced chemically by such compounds as 5-bromouracil or nitrous acid.

(b) Transversion: A purine–pyrimidine base pair is replaced by a pyrimidine–purine pair. This mutation occurs spontaneously and is common in humans. About one-half of the mutations in hemoglobin are of this type.

(c) Frameshift: This mutation results from insertion or deletion of a base pair.

Some insertions can be caused by mutagens such as acridines, proflavin, and ethidium bromide.

Deletions are often caused by deaminating agents. Alteration of bases by these agents prevents pairing.

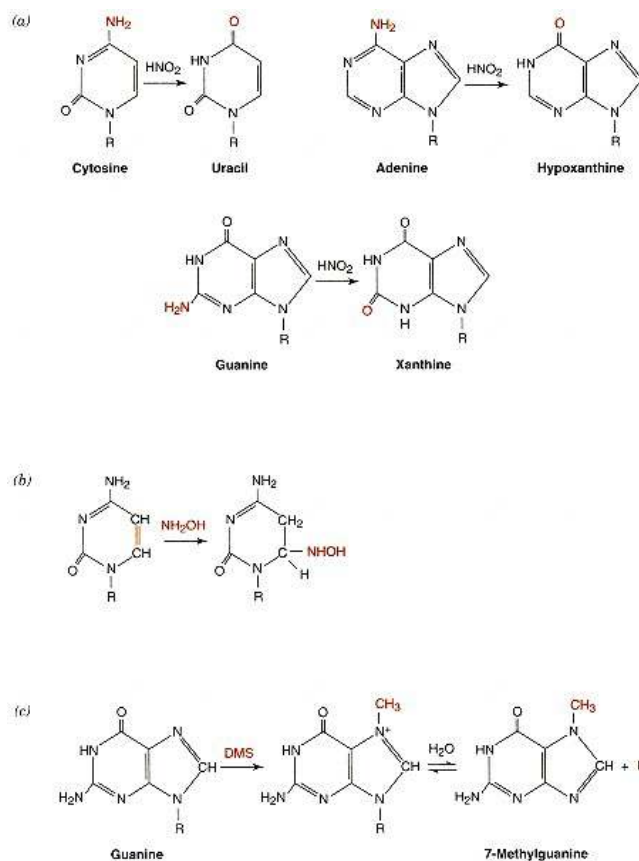

Figure 15.7

Reactions of various mutagens.

- (a) Deamination by nitrous acid (HNO_2) converts cytosine to uracil, adenine to hypoxanthine, and guanine to xanthine.
- (b) Reaction of bases with hydroxylamine (NH_2OH) as illustrated by the action of this reagent on cytosine.
- (c) Alkylations of guanine by dimethyl sulfate (DMS). Formation of a quaternary nitrogen destabilizes the deoxyriboside bond and releases deoxyribose. Among the effective agents for methylation of bases are nitrosoguanidines such as *N*-methyl-*N*⁸-nitro-*N*-nitrosoguanidine.

about 100 base pairs per genome per day and **DNA depurination** occurs at even higher rates of 5000 bases per genome per day (Figure 15.9) as a result of thermal disruption of the *N*-glycosyl bonds of the bases. Some other changes that occur in DNA (as shown in Figure 15.10) can lead to either deletion of one or more base pairs in the daughter DNA after DNA replication or to a base pair substitution.

Radiation Damage

Ultraviolet light, including sunlight, and X-ray irradiation are also effective means of producing mutations. **Radiation energy** absorbed by the DNA induces the formation of minor amounts of the **ionized forms of the bases**. These ionized forms cannot pair with the normal partners of the base, but, instead, they engage in atypical base pairing as shown in Figure 15.11. The presence of ionized base forms at the moment of DNA replication is therefore expected to increase the frequency of mutation in the newly synthesized DNA strands. UV irradiation of DNA causes formation of dimers between adjacent pyrimidine bases. Activation of the ethylene bond of these bases frequently leads to a **photochemical**

dimerization of two adjacent pyrimidines, as shown in Figure 15.12. Thymine residues are particularly susceptible to this reaction, although cytosine dimers and thymine–cytosine combinations are also produced.

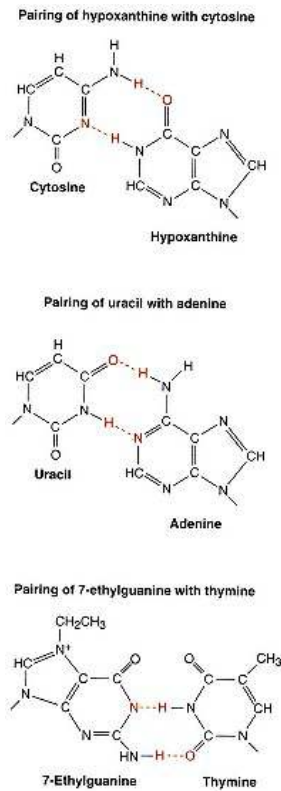

Figure 15.8
Chemical modifications that alter hydrogen-bonding properties of bases.
 Hypoxanthine, obtained by deamination of adenine, has different hydrogen-bonding properties from adenine and pairs with cytosine. Similarly, uracil obtained from cytosine has a different hydrogen-bonding specificity than cytosine and pairs with adenine. Alkylation of guanine modifies hydrogen-bonding properties of the base.

High-energy radiation (X-rays or gamma rays) brings about direct modifications in the structure of the bases. Intermediates produced by electron expulsion can be rearranged, leading to the opening of the heterocyclic rings of the bases and the disruption of phosphodiester bonds. In the presence of oxygen additional reactions take place, yielding a variety of oxidation products.

DNA Polymerase Errors

With the appropriate deoxyribonucleoside triphosphates, DNA polymerases function with a high degree of fidelity. Some mutations do occur during DNA replication, but these changes are limited by the high synthetic fidelity of DNA polymerase and the "proofreading" exonuclease properties of this enzyme. The fidelity of DNA replication is further enhanced postreplicatively by an excision repair process known as the **mismatched repair system**. This system recognizes and corrects mismatches in newly replicated DNA by detecting distortions on the outside of the helix that are produced from poor fit between paired noncomplementary bases. Clearly, accurate correction of mismatched bases requires that the mismatched repair system discriminate between preexisting

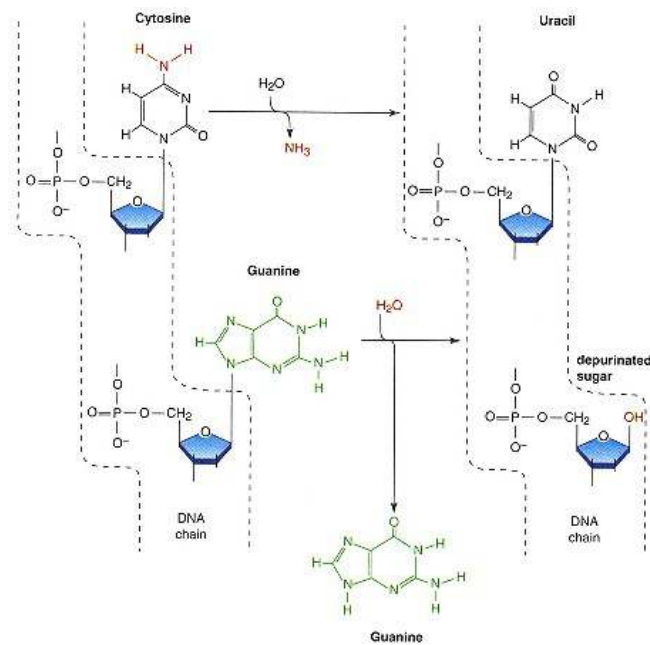

Figure 15.9
Spontaneous deamination of pyrimidines and depurination of polynucleotides.

DNA undergoes substantial structural modifications as a result of thermal perturbations that include

- (1) extensive hydrolysis of the *N*-glycosyl bonds that connect purines to the deoxyribose residue and
- (2) deamination of cytosine residues to uracil. In absence of repair mechanisms, these changes would have disastrous consequences for cell survival because of the high frequency of their occurrence.

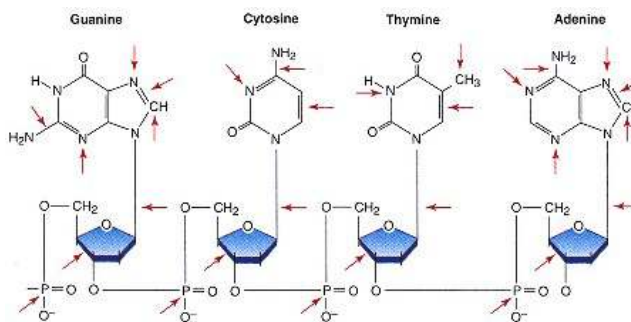

Figure 15.10

DNA sites subject to spontaneous chemical modifications.

Nucleotides are subject to various spontaneous chemical changes at sites indicated by arrows including (1) hydrolytic attack, (2) oxidative damage, and (3) methylation.

The frequency and extent of chemical change vary from site to site.

and newly synthesized DNA strands. Such discrimination is feasible because certain adenine residues in DNA, which are part of a recurring GATC sequence, are subject to methylation that occurs posttranscriptionally, but with some delay. Mismatched proofreading is carried out by a multienzyme complex that excises mismatched nucleotides only from newly synthesized strands. The complex identifies these nucleotides by searching for unmethylated adenine residues in the GATC sequences of each strand. The mechanism of mismatched repair is described later.

DNA polymerases are unable to distinguish between the normal deoxyribonucleoside triphosphate substrates and other nucleotides with very similar structures, thus leading to their incorporation and a mutation. Classic examples of such analogs are deoxyribonucleotides of 5-bromouracil (5-BrdU) and 2-aminopurine (2-AP) that have been used experimentally for the introduction of mutations. Incorporation of 5-BrdU into DNA introduces, with a high frequency, a transition mutation in which a pu-py pair is transformed to another pu-py. Specifically, 5-BrdU paired with A is changed to a C-G pair, which amounts to a TA → GC transition. The unusual pairing properties of 5-BrdU appear to relate to the higher tendency of this base to be transformed to an ionized form, relative to T for which it is a substitute. This occurs presumably because of the higher electronegative nature of the bromine atom in comparison to the corresponding methyl group in thymine.

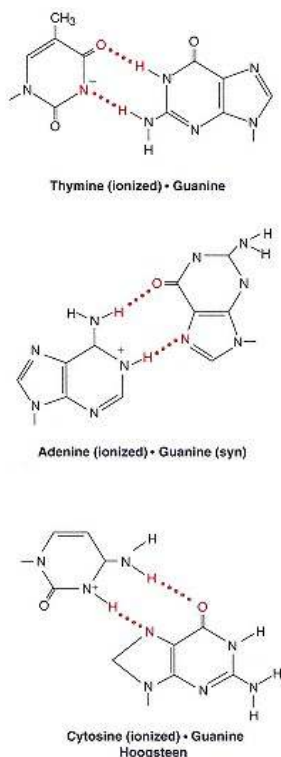

Figure 15.11

Base pairing between the ionized forms of the bases.

Adenine and cytosine are prone to protonation especially at lower pH. Also, an ionized form of thymine can be generated by loss of a proton.

Reactions that give rise to ionized forms of bases occur readily at near-neutral pH, within certain nucleotide sequence contexts. Whereas some of the ionized complexes form with Watson-Crick hydrogen bonding, as, for instance, the T (ionized)-G pair, other ionized bases form more unusual types of H bonding. For example, the A (ionized)-G(syn) base pair involves H bonding between an A in the anti position and a G in the syn configuration.

Stretching of the Double Helix

Organic compounds characterized by planar aromatic ring structures of appropriate size and geometry can be inserted between base pairs in double-stranded DNA. This process is referred to as **intercalation**. During intercalation neighboring base pairs in DNA are separated to allow for the insertion of the intercalating ring system, causing an elongation of the double helix by stretching. In effect the double helix is locally unwound into a ladder-like structure in which the base pairs are transiently arranged at 0.68 nm apart. This localized arrangement doubles the 0.34-nm distance characteristic of the double helix and generates sufficient space between base pairs for the insertion of the intercalator. In effect, intercalation disrupts the continuity of the base sequences in DNA and the reading of the DNA template by the DNA polymerase, producing a daughter strand with an additional base incorporated into DNA. The resulting mutation is referred to as a **frameshift**. Acridines, ethidium bromide, and other intercalators are known to be effective frameshift mutagens (Figure 15.13). Clinical Correlation 15.1 discusses mutations and the etiology of cancer.

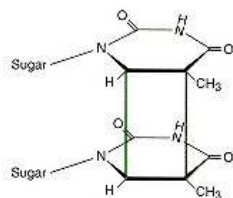
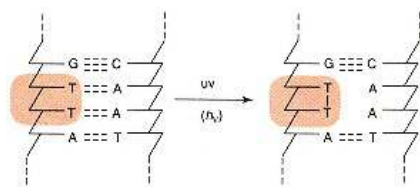
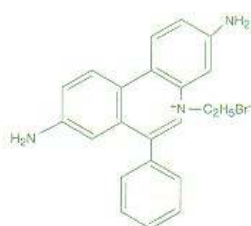

Figure 15.12

Dimerization of adjacent pyrimidines in irradiated DNA.

Thymine activated by absorption of UV light can react with a second neighboring thymine and form a thymine dimer.



(a)

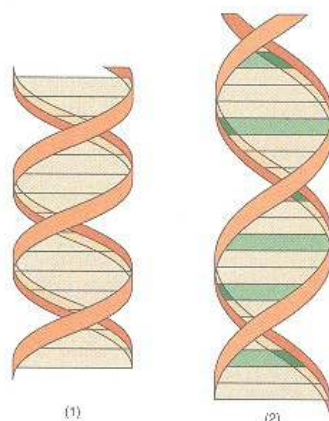

(b)

Figure 15.13

Intercalation between base pairs of the double helix.

(a) Insertion of planar ring system of intercalators between two adjacent base pairs requires stretching of the double helix

(b). During replication this stretching apparently changes the frame used by DNA polymerase for reading the sequence of nucleotides. Consequently, newly synthesized DNA is frameshifted.

(b-1) Original DNA helix;

(b-2) helix with intercalative binding of ligands.

Redrawn based on figure in Lippard, S. J.

Acct. Chem. Res. 11:211, 1978.

Copyright © 1978 by the American Chemical Society.

CLINICAL CORRELATION 15.1

Mutations and the Etiology of Cancer

Considerable progress in understanding the etiology of cancer has been achieved in recent years by the realization that long-term exposure to certain chemicals leads to various forms of malignancy. It is now suggested that the great majority of cancers are triggered by agents in the environment that modify underlying genetic predisposition factors.

Carcinogenic (cancer-causing) compounds are not only introduced into the environment by the increasing use of new chemicals in industrial applications but are also present in the form of natural products. For instance, the aflatoxins, produced by certain molds, and benz[*a*]anthracene, present in cigarette smoke and charcoal-broiled foods, are carcinogenic. Some carcinogens act directly, while others, such as benz[*a*]anthracene, must undergo prior hydroxylation by arylhydroxylases, present mainly in the liver, before their carcinogenic potential can be expressed.

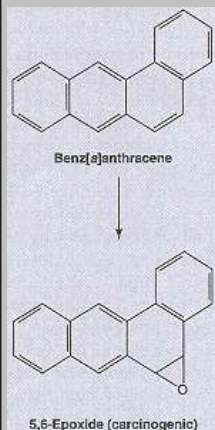

The reactivity of many carcinogenic compounds toward guanine residues results in modification of the guanine structure, usually by alkylation at the N-7 position and by cleavage of the phosphodiester bond, events that upon replication lead to permanent mutations. Chemical mutagens are generally carcinogenic and vice versa. Vulnerability of DNA to alkylating agents and other chemicals underscores the concerns expressed by many scientists about the ever-increasing exposure of our environment to new chemicals. What is of concern is that the carcinogenic potential of new chemicals released into the environment cannot be predicted with confidence even when they appear to be chemically innocuous toward DNA.

In the past, tests for carcinogenicity, that is, the ability of a substance to cause cancer, required the use of many experimental animals treated with high doses of suspected carcinogen over a long period of time. Such tests, which are time consuming as well as expensive, are the only approach still available for testing carcinogenicity directly. A much simpler and inexpensive indirect test for carcinogenicity is also available. This test, the Ames Test, is based on the premise that carcinogenicity and mutagenicity are essentially manifestations of the same underlying phenomenon—the structural modification of DNA. The test measures the rate of mutation that bacteria undergo when exposed to chemicals suspected to be carcinogens.

A major criticism of this test is that the assumption of an equivalence between mutagenicity and carcinogenicity is not always valid. Because of economic implications of labeling a chemical with widespread use as a potential carcinogen, the scrutiny often exercised in assessing the reliability of applicable tests for labeling a chemical as a carcinogen is understandable. Certain exceptions notwithstanding, the great majority of chemicals tested have shown that a good correlation exists between the tendency of a chemical to produce bacterial mutations and animal cancer. Even the direct and very costly tests for carcinogenicity have not completely escaped criticism. The reliability of such tests has been questioned because of the relatively large doses of chemicals employed, doses that are essential for shortening the long-term chemical exposure of the animals to a practically manageable period of time. Another criticism of direct tests is that they make projections from animals, usually rodents, to humans. This criticism has some merit. During the past few years it has become apparent that rodents are less efficient than humans at repairing certain types of damage in nontranscribed regions of their DNA. Damage in nontranscribed DNA regions is more slowly repaired than damage within transcribed genes, which have first priority for repair. Although damage in nontranscribed DNA regions has few immediate consequences, it appears with time that this damage leads to cancer. The relatively large doses of chemicals used for testing are likely to exceed the capacity of rodent DNA repair systems, making the extrapolation of the results obtained from rodents to humans unreliable.

The enzymes that activate carcinogens are often members of the cytochrome P450 family (Chapter 23) that can be induced by noncarcinogenic compounds such as ethanol; hence alcohol can increase the potential risk of cancer development after exposure to carcinogens.

Ames, B., Dursto, W. E., Yamasaki, E., and Lee, F. D. Carcinogens are mutagens: a simple test system combining liver homogenates for activation and bacteria for detection. *Proc. Natl. Acad. Sci. USA* 70:2281, 1973; and Culotta, E., and Koshland, D. E. Jr. DNA repair works its way to the top. *Science* 266:1926, 1994.

DNA Is Repaired Rather Than Degraded

DNA is the only macromolecule that is repaired rather than degraded. The repair processes are very efficient with fewer than 1 out of 1000 accidental changes resulting in mutations. The rest are corrected through various processes

of DNA repair. Mutation rates can be estimated using two entirely different approaches, that is, from the frequency with which new mutants arise either in populations, such as fruitflies, or in specific proteins in cells growing in tissue culture. These experiments provide estimates of mutation rates of 1 base pair change per 10^9 base pairs for each cell per each generation. On this basis, for an average-sized protein, which contains about 1000 coding base pairs, a mutation may occur once in 10^6 cell generations.

DNA repair is a high-priority process for maintaining cellular function. Germ cells must be protected against high rates of mutation to preserve the species, and somatic mutation must be controlled in order to avoid uncontrolled cell growth and disease. Unchecked accumulation of damage can lead to accumulation of nonfunctional proteins or unregulated growth characteristic of malignant cells. Commonly encountered DNA lesions are listed in Table 15.4.

There are multiple DNA repair pathways and each specializes in a certain type of damage, although some repair pathways have a wider versatility than others. Generally, repair mechanisms are applicable to both prokaryotic and eukaryotic DNA repair.

Repairs may be carried out under rare circumstances as a direct reversal of the damage or, far more commonly, by the replacement of the damaged DNA section. DNA repair depends on the existence of two complementary DNA strands except for **postreplication repair of rare lesions** and **postreplication SOS repair**. Damage or imperfection on one DNA strand can be corrected since the complementary strand provides the necessary information for accurate repairs. Postreplication repair is not a true repair mechanism but rather a stop-gap measure that allows for DNA replication to occur until damage can be repaired permanently. Postreplication repair cannot use the complementary DNA strand for repairs because this strand is also altered by the replication that precedes the repair. Postreplication repair depends, instead, on another process—DNA recombination. Recombination permits the use of homologous DNA strands, namely, DNA strands with the same or almost the same sequence as the damaged strand, for carrying out the repair of the damaged DNA section. An intriguing feature of DNA repair that has been appreciated recently is its apparent intimate coupling to other central processes in which DNA participates, such as recombination, transcription, and control of the cell cycle. Enzymes involved in DNA repair participate in DNA replication, DNA recombination, and particularly DNA transcription. DNA metabolism integrates important processes that are coordinated through the use of the same molecular tools to achieve different tasks.

TABLE 15.4 DNA Lesions that Require Repair

<i>DNA Lesion</i>	<i>Cause</i>
Missing base	Acid and heat remove purines ($\sim 10^4$ purines per day per cell in mammals)
Altered base	Ionizing radiation; alkylating agents
Incorrect base	Spontaneous deaminations: C → U, A → hypoxanthine
Deletion–insertion	Intercalating agents (e.g., acridine dyes)
Cyclobutyl dimer	UV irradiation
Strand breaks	Ionizing radiation; chemicals (bleomycin)
Cross-linking of strands	Psoralin derivatives (light-activated); mitomycin C (antibiotic)

Source: From Kornberg, A. *DNA Replication*. San Francisco: Freeman, 1980, p. 608.

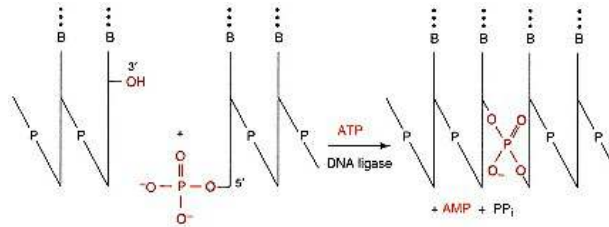

Figure 15.14
Action of DNA ligase.

The enzyme catalyzes the joining of polynucleotide strands that are part of a double-stranded DNA. A single phosphodiester bond is formed between 3-OH and 5-P ends of two strands. In *E. coli* cells, energy for formation of the bond is derived from cleavage of the pyrophosphate bond of NAD⁺. In eukaryotic cells and bacteriophage-infected cells, energy is provided by hydrolysis of the α,β -pyrophosphate bond of ATP.

Excision Repair in *E. coli*

Excision repair is catalyzed by different enzymatic systems tailored to specific types of damage. This repair mechanism is universal, occurring in all organisms investigated. The mechanisms are characterized by four sequential steps: incision, excision, resynthesis, and ligation. Incision is the recognition step and is individualized for the specific type of damage present. It is also the rate-controlling step in the process. During excision the damaged DNA section is excised, leaving a gap in the DNA strand. In the resynthesis step the gap is filled by DNA polymerase I. This enzyme functions like DNA polymerase III in that it catalyzes the stepwise addition of nucleotide triphosphates on a 3-OH generated by the preceding incision step. Polymerase I, however, differs from polymerase III in that it is less processive, tending to dissociate from the DNA after incorporation of 10–12 nucleotides. At this stage the gap is reduced to the size of a single phosphodiester bond. Because of the combined synthetic–nucleolytic action of polymerase I, the nick can move along the strand, undergoing repair until it is finally bridged during the ligation step by the action of DNA ligase (Figure 15.14). The ligation step appears to be very similar for all types of excision repair.

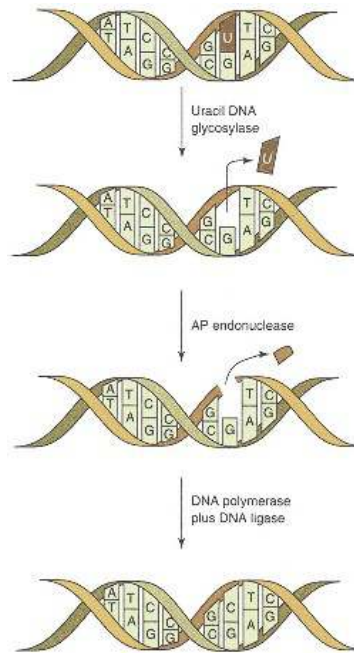

Figure 15.15

Uracil DNA glycosylase repair of DNA.

Uracil DNA glycosylase removes uracil, formed by accidental deamination of cytosine, by cutting the glycosidic bond, leaving DNA with a missing base. AP endonuclease subsequently cuts out the sugar–phosphate remnant. Repair is completed by DNA polymerase and ligase.

Base excision repair eliminates modified bases from DNA. The amino groups of cytosine, adenine, and guanine are susceptible to spontaneous elimination, and various chemicals lead to modifications in the structures of purines, including methylation and ring opening. In addition, ring opening may result from exposure to ionizing radiation. Bases that have been deaminated, methylated, or otherwise chemically modified are hydrolytically removed by enzymes referred to as **DNA glycosylases**. Removal of deaminated cytosine (i.e., uracil) by the enzyme **uracil DNA glycosylase** is illustrated in Figure 15.15. This enzyme removes the damaged cytosine, producing a deoxyribose residue with the base missing [**apurinic–apyrimidinic (AP) site**]. AP sites are also generated without the involvement of DNA glycosylases, as in the case of spontaneous hydrolysis of purines (**depurination**) that occurs at very high rates in DNA. AP sites can also result from depyrimidination but the greater stability of the purine–glycoside bond makes this reaction almost insignificant. Once an AP site has been created, the enzyme **AP endonuclease** nicks the phosphodiester backbone at the depurinated site and excises the sugar–phosphate residue. The action of DNA polymerase I and ligase on this structure leads to the restoration of the damaged strand.

A second type of excision repair referred to as **nucleotide excision repair** is activated when DNA is damaged in a way that produces a "bulky" lesion. This occurs when DNA interacts with polycyclic aromatic hydrocarbons, such as benzo[*a*]pyrenes and dialkylbenzanthracenes generated by smoking, thymine–psoralene adducts, and guanine–cisplatin adducts formed by chemotherapeutic drugs. UV light-induced dimerization of adjacent pyrimidines also causes bulky lesions. Nucleotide excision repair also corrects other lesions that do not distort the helix, such as the presence of methylated bases. Once the lesion has been located, an endonuclease activity cleaves the modified strand on both sides of

the distortion and the entire lesion is removed (Figure 15.16). Repair is initiated by recognition of the distortion of the DNA by an endonuclease system consisting of the products of three *E. coli* genes *uvrA*, *uvrB*, and *uvrC*. A tetramer consisting of two **UvrA** and two **UvrB** proteins, which is formed on DNA during a series of preincision steps, "melts" the DNA locally at the expense of ATP and locates the bulky lesion. The complex is subsequently subjected to incision at both sides of the bulky lesion. First, UvrB makes a 3' incision and then **UvrC** makes a 5' incision, leading to the release of an oligonucleotide consisting of 12 or 13 residues that includes the pyrimidine dimer. This nuclease activity, which is unique to DNA repair, has been christened **excision nuclease** or **excinuclease** to clearly distinguish it from other endonucleases. For the remainder of the repair, *E. coli* makes use of the protein **UvrD** which, acting as a **helicase**, unwinds and releases the oligonucleotide that was excised by UvrB and UvrC. The repair is completed by polymerase I and ligase.

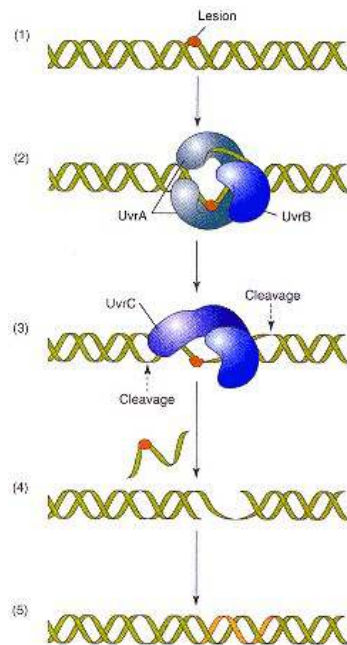

Figure 15.16

Nucleotide excision repair in *E. coli*.

Nucleotide excision repair in *E. coli* and in human DNA occurs in a series of analogous steps. Initial damage in *E. coli* is recognized by

UvrA protein, which also serves as a "molecular matchmaker" by recruiting, at the damaged site, UvrB protein. UvrA binds to the lesion, unwinds and kinks DNA. UvrA also causes a conformational change in UvrB that promotes strong binding of UvrB at the site of the lesion. Subsequent dissociation of UvrA from UvrB–DNA complex makes the complex a target for UvrC. UvrB then makes a 3' cut that is followed by a 5' incision made by UvrC. Helicase II (UvrD) releases the excised oligonucleotide 12-mer and DNA polymerase displaces UvrB and fills the excision gap prior to ligation.

Redrawn based on figure in
Moran, L. A., Scrimgeour, K. G., Horton, H.
R., Ochs, R. S., and Rawn, J. D.
Biochemistry. Englewood Cliffs, NJ:
Neil Patterson/Prentice Hall, 1994.

Eukaryotic Excision Repair

Excision repair in prokaryotes and eukaryotes is remarkably similar with the following distinctions. The exonuclease activity of human cells consists of a much larger number of proteins (16–17 different polypeptides) as apposed to the four proteins (UvrA, B, C, and D) that constitute the exonuclease activity of *E. coli*. Some of the protein constituents of human excinucleases are listed in Table 15.5. Proteins XPA to XPG have been identified as seven different **genetic complementation groups** (A to G) of patients with **xeroderma pigmentosum (XP)**, a condition characterized by UV sensitivity and corresponding deficiencies in DNA repair. The human nucleotide repair genes are therefore referred to by an XP or ERCC (excision repair component) designation. Nucleotide excision repair of human DNA begins with the binding of XPA to a dimer between XPF and ERCC1 (Figure 15.17). XPA recognizes and binds to the damaged site along with the replication protein HSSB. An intriguing aspect of human DNA repair is involvement of an additional enzymic complex con-

TABLE 15.5 Excinuclease Activity of Human DNA

Human Gene	Protein Function
<i>XPA</i>	Damage recognition protein (binds to damaged DNA)
<i>XPB (ERCC3)</i>	DNA helicase activity; subunit of transcription factor TFIIH
<i>XPC</i>	Interacts with general transcription factor TFIIH
<i>XPD (ERCC2)</i>	DNA helicase activity; subunit of transcription factor TFIIH
<i>XPF</i>	Nuclease activity
<i>XPG</i>	Nuclease activity
<i>ERCC1</i>	Part of nuclease activity (binds to XPF and to replication protein RPA)
<i>HSSB (RPA)</i>	Binds to the XPF–ERCC1 complex and together with XPA binds to the lesion site

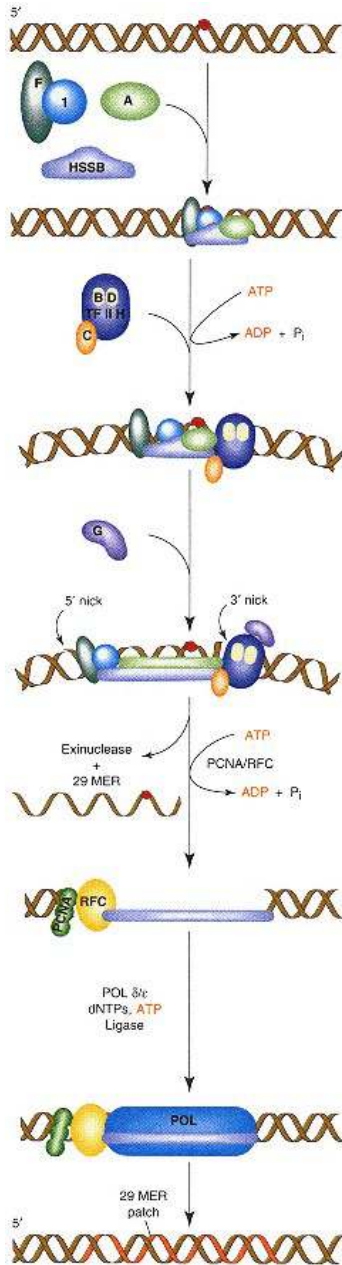

Figure 15.17

Nucleotide excision repair of human DNA.

In human DNA damage is recognized by the XPA factor (abbreviated in the figure as A) that recruits to the damaged site factors XPF and ERCC1 (abbreviated as F and 1, respectively) in the form of a dimer. XPF is an excinuclease that is recruited to the damaged site early on just as UvrB is recruited in the *E. coli* system. The replication protein (HSSB) binds to XPA and the lesion site. XPA also recruits to the damaged site the general transcription factor TFIIH, which, as it turns out, is also a repair protein since two of its protein subunits are repair factors XPB and XPD (abbreviated as B and D). In analogy with UvrA, TFIIH may be involved in kinking and unwinding of DNA at the damaged site and in recruiting XPC and XPG proteins, which are vested with helicase activity. Excinuclease cuts are made at the 3' site by XPG, whereas XPF nicks at the 5' site of the lesion, leading to the excision of a 23-mer oligonucleotide. Gap repair is carried out by polymerases and with PCNA and replication protein RFC, followed by ligation.

Redrawn based on figure in Sancar, A.

Science 266: 1954, 1994. Copyright

© 1994 American Association for the

Advancement of Science.

sisting of eight different protein subunits and known as the **general transcription factor TFIIF**. This factor is essential for transcription initiation and for nucleotide excision repair. In fact, two of the eight subunits of TFIIF are the helicases XPB and XPD that evidently not only act in excision repair but also catalyze the opening of DNA to initiate transcription. This intimate involvement of a transcription factor suggests that DNA repair and transcription are not fully separable processes and may be coupled to each other. The TFIIF factor interacts with XPC and the entire complex is recruited to the damaged site by XPA, where it is joined by the endonuclease XPG. The two recruited endonucleases, XPF and XPG, complete the excinuclease systems with the XPG making the 3' nick and the XPF, in the form of a complex with ERCC1, making the 5' nick. The major XPG incision is made at the third phosphodiester bond 3' to the lesion, whereas the XPF-ERCC1 complex incises primarily at the 25th phosphodiester bond 5' to the lesion. The role of TFIIF is presumably to unwind the double helix at the damaged site so as to enable the endonucleases XPF and XPG to activate the excinuclease system. A protein associated with polymerase β , PCNA (**proliferating cell nuclear antigen**), releases the excinuclease subunits and the excised oligomer, which is larger than the oligonucleotide released during *E. coli* repair (27–29 nucleotides versus 12–13 nucleotides in *E. coli*). The gap is filled by polymerases δ and ϵ and the DNA is ligated.

Excision repair also removes cross-links between complementary DNA strands, such as those introduced by the mustards and drugs used in cancer therapy (i.e., mitomycin D and platinum complexes). Error-free repair is not possible if the cross-link extends across directly opposing bases. Clinical Correlations 15.2 and 15.3 discuss defects in DNA repair that are associated with human disease; Clin. Corr. 15.4 examines the role of DNA repair in chemotherapy.

Mismatch Repair

Mismatch repair in both prokaryotic and eukaryotic cells deals with errors created during DNA replication. In effect, three serially operating mechanisms—base selection, exonucleolytic proofreading, and postreplicative mismatch re-

CLINICAL CORRELATION 15.2

Defects in Nucleotide Excision Repair and Hereditary Diseases

Defects in nucleotide excision repair are implicated in at least three rare hereditary disorders, xeroderma pigmentosum (XP), Cockayne's syndrome (CS), and trichothiodystrophy (TTD). XP patients exhibit sunlight-induced photodermatoses characterized by severe skin reactions that range initially from excessive freckling and skin ulcerations to the eventual development of skin cancers. Some forms are also accompanied by neurological abnormalities. The symptoms exhibited by CS and TTD patients are associated instead only with developmental abnormalities. CS syndrome is characterized by growth and mental retardation, neurological deficiencies, and photosensitivity but not an increased rate of cancer or skeletal abnormalities. TTD patients, on the other hand, have scaly skin, brittle hair, short stature, and neuroskeletal abnormalities.

Xeroderma pigmentosum is a group of closely related abnormalities in excision repair. About 80% of XP patients fall into one of seven complementation groups (different syndromes). Each group carries a mutation in a different gene and is characterized by varying levels of UV sensitivity caused by corresponding deficiencies in "excinuclease" repair activity. The remainder fall in the XPV (V for variant) group. In this variant UV irradiation produces different types of mutations compared to normal cells. During normal DNA synthesis, whenever the DNA polymerase bypasses a pyrimidine dimer in the template that has not yet been repaired, a purine (most often A) is incorporated into nascent DNA but this preference is not maintained by XPV cells. It appears that the mechanism of bypass by the DNA polymerase in XPV cells is altered possibly because of changes in one or more of the subunits of the polymerase or possibly some other protein factor that assists the polymerase to bypass the DNA lesions. The neurological abnormalities that frequently accompany XP appear to result from both abnormal gene expression and DNA deterioration caused by the accumulation of unrepaired DNA damage.

Cockayne's syndrome is associated with mutations in the *CSB/ERCC6*, *XPD*, and *XPB* genes. Trichothiodystrophy is caused by mutations in *XPB*, *XPD*, and *XPG* genes and perhaps in additional subunits of TFIIF or TFIIF-associated excision repair subunits. Obviously, different mutations in the *XPB* and *XPD* genes are responsible for each syndrome.

Tanaka, K., and Wood, R. D. Xeroderma pigmentosum and nucleotide excision repair of DNA. *TIBS* 9:83, 1994.

CLINICAL CORRELATION 15.3**DNA Ligase Activity and Bloom Syndrome**

Bloom syndrome is a rare genetic disease that is characterized by chromosomal instability. Other chromosome breakage syndromes include Fanconi's anemia (FA), ataxia telangiectasia (AT), Werner's syndrome (WS), and Gardner's syndrome (GS). Deficiencies in the effective repair of DNA lesions, which can probably be attributed to defective DNA ligation, are presumably responsible for many of these syndromes. These repair deficiencies appear to increase the tendency to develop malignancies among those affected with the syndromes.

Bloom syndrome is a prototype of somatic mutation disease. The clinical features of Bloom syndrome are small body size, a sun-sensitive skin with well-defined hyper- and hypopigmented skin lesions, and increased sensitivity to bacterial infections due to immunodeficiency. Cancer, chronic lung disease, and diabetes are common complications. Cells from Bloom syndrome patients have high rates of mutation, and the excessive number of accumulated somatic mutations are responsible for many of the clinical features of this syndrome. In patients suffering from Bloom syndrome, hypermutability is responsible for the abolition of ligase I activity needed for completing DNA repair and (perhaps) DNA recombination.

German, J. *Bloom syndrome. Dermatol. Clin.* 13(1):7, 1995.

CLINICAL CORRELATION 15.4**DNA Repair and Chemotherapy**

Many anticancer drugs cause DNA damage. For example, cisplatin, used for treatment of several forms of cancer and particularly effective against testicular tumors, forms two intrastrand adducts with DNA. The major one, the 1,2-intrastrand d(GpG) cross-link, is repaired by excision repair. DNA adducts are believed to be the primary cytotoxic lesion and cells deficient in excision repair are very sensitive to this drug. The high mobility group (HMG)-domain proteins "shield" and specifically inhibit DNA repair of this major cisplatin-DNA adduct, thus increasing the cytotoxicity of cisplatin. The types and levels of HMG-domain proteins in a given tumor may influence the responsiveness of that cancer to cisplatin chemotherapy. This information may provide a basis for the development of new platinum anticancer drugs that may have greater therapeutic potential.

Huang, J. C., Zamble, D. B., Reardon, J. T., Lippard, S. J., and Sancar, A. HMG-domain proteins specifically inhibit the repair of the major DNA adduct of the anticancer drug cisplatin by human excision nuclease. *Proc. Natl. Acad. Sci. USA* 91:10394, 1994.

pair-participate in ensuring fidelity of replication. The mismatch repair system recognizes and eliminates mispairing from newly synthesized DNA strands, improving the fidelity of the synthesis. Base selection and proofreading act more effectively against transversion than transitions, whereas mismatch repair does the opposite. DNA replication errors are difficult to recognize because mismatches consist of erroneous but unaltered base structures. The repair system relies on other signals within the helix to identify the newly synthesized strand, which by definition harbors the replication error. Such signals are provided in *E. coli* by a methylation reaction catalyzed by **Dam methylase** that modifies GATC sequences by introducing a methyl group at the *N*-6 position of adenines. Shortly after replication these GATC sequences exist in an unmethylated state that betrays the newly synthesized nature of the DNA strand and permits strand discrimination by the mismatch repair system (Figure 15.18).

The mismatch repair system in *E. coli* includes several different protein components, which repair mismatches in the vicinity of a GATC sequence according to complementary rules dictated by the base sequence of the methylated (i.e., preexisting) parental strand. Proteins that catalyze the process of mismatch repair have been named **MutS**, **MutH**, and **MutL**. Repair is initiated by binding of MutS to the mismatch followed by the addition of MutL. Formation of the MutS-MutL complex activates a latent GATC endonuclease activity, vested in the MutH protein, that nicks the unmodified strand at a hemimethylated GATC site. The strand break, which can occur on either side of the mismatch, will take place as long as the mismatched base is located within the general vicinity of the GATC site, which means within a few hundred base pairs from the GATC sequence. This nick marks the strand that will be excised. When the mismatch is located on the 5' side of the cleavage site the unmethylated strand is unwound, degraded, and replaced by new DNA synthesized in the 3' → 5' direction until the mismatch is reached and excised. This reaction requires a DNA helicase II, referred to also as the **MutU** protein, a 3' → 5' exonuclease (exonuclease I), DNA polymerase III, and finally DNA ligase to seal the repaired strand. If the mismatch is located on the 3' side of the cleavage, a series of completely analogous steps takes place, except that a 5' → 3' exonuclease (**RecJ**) replaces exonuclease I (an exonuclease with both 5' → 3' and 3' → 5' activity, exonuclease III can also substitute for RecJ in the latter repair). This unusual bidirectional excision activity of the mismatch repair system suggests that this system "keeps track" of the side on which the mispair of the GATC sequence signal is located.

Analogous mismatch repair systems have been identified in eukaryotes. Both yeast and human cells code for proteins homologous to the bacterial

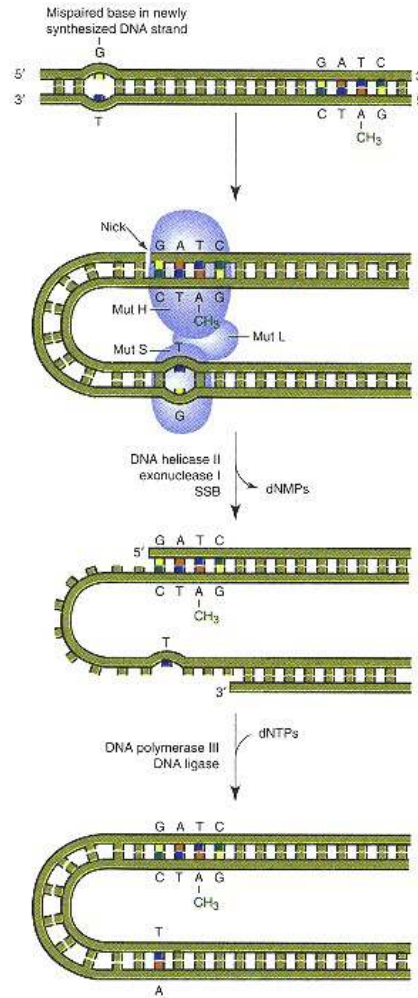

Figure 15.18
Mismatch DNA repair.

Methylation of adenine in palindromic 5'-GATC sequences serves to distinguish parental strands from newly synthesized strands that are methylated only after some delay. Methylation directs the mismatch repair system to repair mispaired bases. Methylated GATC sequences are recognized by MutH, which is also an endonuclease that cleaves the unmethylated strand on the 5' site of the G in the GATC sequence, whereas the mispaired site is recognized and bound by the MutS protein. MutL, which is a molecular matchmaker, links MutH and MutS together. The segment of the unmethylated strand, which represents newly synthesized DNA between the site cleaved by MutH and a point just past the mismatched base, is then removed by the action of helicase II, exonuclease I, and SSB protein. The gap is repaired by DNA polymerase III and ligase. A similar mechanism, but based on the presence of nicks to identify newly synthesized strands, is used by eukaryotes. The eukaryotic mismatch repair system does not use MutH and depends on MutL for the degradation of newly synthesized strands that contain base mismatches.

proteins MutS and MutL but lack the MutH protein. In eukaryotic mismatch repair the role of MutL is to scan nearby DNA for the presence of nicks. Upon finding a nick, MutL degrades the nicked strand starting at the nick site and extending just past the site of the mismatched base pair. Replication errors are thereby selectively removed. Clinical Correlation 15.5 describes the role of mismatch repair in the development of certain types of cancer.

Mechanisms That Reverse Damage

Formation of dimers can be directly reversed by the action of light. Photoreversal is catalyzed by deoxyribodipyrimidine **photolyase**, which disrupts the covalent

CLINICAL CORRELATION 15.5

Mismatch DNA Repair and Cancer

DNA is constantly being damaged. In the absence of efficient repair, this may be the cause of as much as 90% of all human cancers. The importance of defective mismatch repair in the development of certain types of human cancer has been demonstrated recently. Tumors associated with hereditary nonpolyposis colorectal cancer (HNPCC), which causes cancer predisposition and certain sporadic cancers, have been found to be prone to mutation by as much as two orders of magnitude higher than normal human cells. These high mutation rates have been found to be consistently associated with deficiencies in mismatch repair.

That loss of mismatch repair fidelity is a central step in the development of HNPCC tumors has been concluded from the finding that the majority of these tumors are attributable to defects at any one of four different human genome loci. These are the *hMSH2* gene, which codes for a protein homolog of bacterial MutS protein, and the *hMLH1*, *hPMS1*, and *hPMS2* genes, which specify three similar but distinct MutL analogs. These findings demonstrate that the primary event in the development of HNPCC tumors is the loss of critical mismatch repair activity. Inefficiencies in DNA repair presumably lead to mutations that circumvent the regulatory systems controlling cell proliferation. The link between mismatch repair and the development of colon cancer provides support for the hypothesis that cancers are initiated when cells accumulate a certain mutation load. A current emphasis in studies of cancer is the search for and study of particular genes, the mutations of which appear to lead to cancer. The new findings, which demonstrate the importance of mismatch repair defects in the development of cancers, may now expand the search from simply attempting to decipher the role of certain genes in carcinogenesis to also asking why and how some cells accumulate an excessive number of mutations.

Modrich, P. Mismatch repair, genetic stability and cancer. *Science* 266:1959, 1994.

bonds that hold together the pyrimidine molecules in the dimer. Photolyases are activated by light in the range of 300–600 nm. Photolyases are present in bacteria but are not essential for DNA repair; humans lack the enzymes.

Removal of a methyl or ethyl group from the 6 position of the enol form of a guanine residue reestablishes the normal structure of guanine. A specific protein accepts alkyl groups and becomes alkylated.

Postreplication Repair

The repair processes reviewed so far deal with damage of bases on one of the two DNA strands and use of the second complementary strand as a template for repair. Such repair occurs prior to replication of DNA that turns DNA damage into permanent mutation. For example, normal DNA replication with DNA polymerase III in *E. coli* cannot proceed past most types of DNA lesions until such lesions are first repaired. These lesions cannot be excised because excision would leave breaks in both strands that replication would perpetuate. Eventually, replication resumes past the site of the lesion with the polymerase skipping over a few of the damaged bases. After synthesis the daughter strand is found to be missing a base that would normally be present across the damaged base. The lesion itself is eventually repaired by borrowing template information from a homologous DNA strand. This type of repair is illustrated in Figure 15.19.

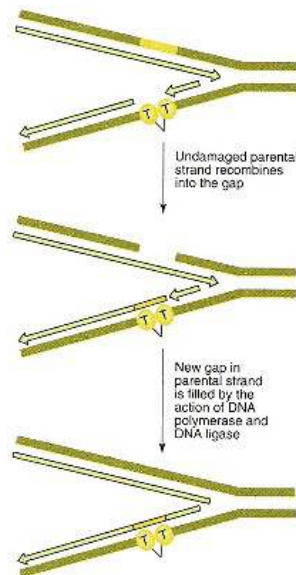

Figure 15.19

Postreplication repair.

Most DNA lesions in *E. coli* are repaired prior to replication. If an unrepaired lesion is encountered by the replication complex near the replication fork, replication is blocked at the site and resumes only beyond the unrepaired site. The gap, initially left behind in an unreplicated single-stranded segment of DNA, is eventually repaired by the process of recombination. Recombination allows the use of a complementary strand from another DNA as template.

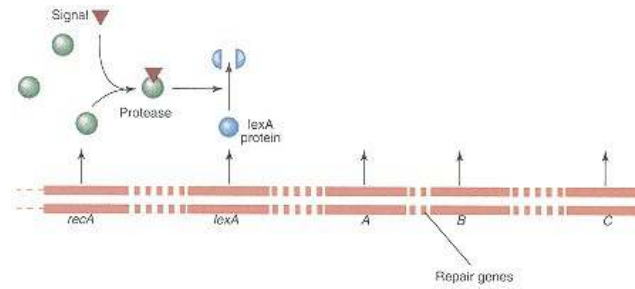

Figure 15.20
SOS DNA repair.

Under normal conditions the SOS repair proteins are not expressed.

This is because a repressor protein, LexA, binds to promoter regions and inhibits the transcription of many genes required for DNA repair and DNA recombination. LexA also inhibits its own expression and the expression of another protein with multiple enzymatic roles, RecA. DNA damage, identified by the presence of single-stranded DNA, inactivates LexA. Inactivation of LexA is the result of proteolysis by the RecA protein, which when bound to single-stranded DNA functions as a specific protease. In the absence of LexA, genes that were previously inhibited by LexA can be expressed. After the damage of DNA is repaired, LexA begins to accumulate again, repressing the expression of SOS genes.

SOS Postreplication Repair

Many of the enzymes involved in DNA repair in *E. coli*, including the ABC excinuclease system, are inducible and regulated by proteins **LexA** and **RecA** that, together with the genes coding for the inducible proteins, form the **SOS repair** system.

Under normal conditions LexA binds tightly to the control region of genes that code for repair enzymes and several other proteins and prevents the expression. Genes in the SOS response also induce the *polB* gene encoding a polymerization subunit of DNA polymerase required for error-prone translesion replication. The SOS system is activated as a result of severe DNA damage. Activation can be described as the RecA-mediated cleavage and destruction of LexA in an autoproteolytic manner (Figure 15.20). The fragmented LexA dissociates from the DNA, allowing the efficient expression of the SOS response genes. Some of the products of the SOS response assemble at the lesion to form a specialized replication system that depends on DNA polymerase II for replicating past DNA lesions, which normally block DNA polymerase III. This **translesion replication** is made possible because of the distinct properties of polymerase II.

The signal that activates RecA is the binding of RecA onto exposed single-stranded DNA or damaged double-stranded DNA, when DNA replication is stalled because of extensive DNA damage. The SOS response to heavy DNA damage is a process that converts a lesion at a replication error-prone site and allows replication to be temporarily restored over the lesion.

15.4— DNA Replication

Complementary Strands Are Basic to the Mechanism of Replication

The double-stranded structure of DNA permits each strand to serve as a template for the synthesis of a new strand identical to the other strand, as suggested in Figure 15.21. The correctness of this overall scheme of replication has solidly

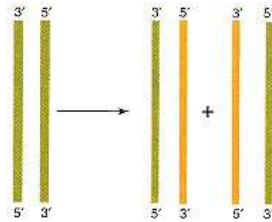

Figure 15.21

Each DNA strand serves as template for synthesis of a new complementary strand.

Replication of DNA proceeds by a mechanism in which a new DNA strand (indicated by a red line) is synthesized that matches each of the original strands (shown by green lines).

been established. Even some bacteriophages, which contain single-stranded instead of double-stranded DNA, have been shown to convert their DNA to a double-stranded form before replication. The simplicity of the basic scheme for replication conceals a rather complex set of coordinated intricate processes. A multiplicity of enzymes and protein factors participate in these processes. The enzymes involved in replication must also deal with a variety of topological problems. DNA-dependent DNA polymerase can synthesize new strands by operating only along the 5' → 3' direction, and therefore it is unable to elongate the two antiparallel strands of the helix in the same macroscopic direction. In addition, DNA polymerases are unable to start DNA synthesis in the absence of a preexisting primer and the replication cannot proceed unless the complementary strands are separated at an early stage of the synthesis. Separation requires the commitment of energy for disrupting the thermodynamically favorable double-helical arrangement and the unwinding of a highly twisted double helix at extremely rapid rates. Double-stranded DNA is normally a topologically closed domain, which, unless properly modified, will not tolerate strand unwinding to any appreciable degree. Obviously, these multiple difficulties must be dealt with before the replication of DNA can take place.

Replication Is Semiconservative

Three possibilities by which information transfer could take place during replication were initially visualized as indicated in Figure 15.22. Conservative replication could, in principle, yield a product consisting of a double helix of the original two strands and a daughter DNA consisting of completely newly synthesized chains. A second possibility, labeled dispersive, would have resulted if the nucleotides of the parental DNA were randomly scattered along the strands of the newly synthesized DNA. The synthesis of DNA eventually proved to be a **semiconservative process**. After each round of replication, the structure of parental DNA is found to preserve one of its own original strands combined with a newly synthesized complementary polynucleotide.

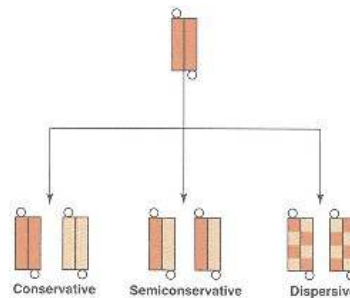

Figure 15.22

Three possible types of DNA replication.

Replication has been shown to occur exclusively according to the semiconservative model; that is, after each round of replication one of the parental strands is maintained intact, and it combines with one newly synthesized complementary strand. Circles represent the 5' terminals.

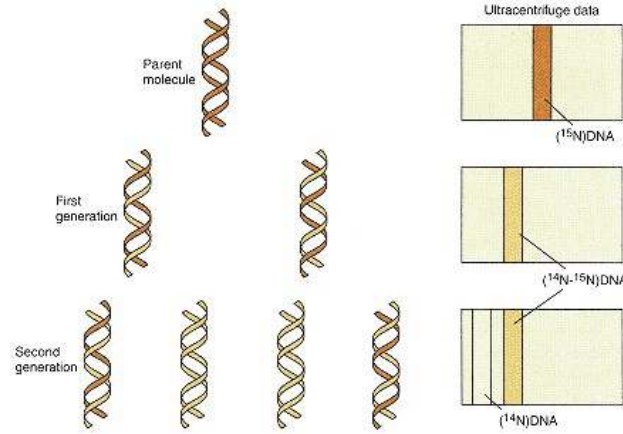

Figure 15.23

Semiconservative replication of DNA.

Schematic representation of the experiment of Meselson and Stahl that demonstrated semiconservative replication of DNA. This model of replication requires that, if the parent molecule (dark red) contains ^{15}N , each of the molecules produced during the first generation contain ^{15}N in one strand and ^{14}N in the other. Furthermore, in the second generation two molecules must contain only ^{14}N , and two molecules must contain equal amounts of ^{14}N and ^{15}N . The results of separating DNA molecules from successive generations, shown on the right, are consistent with this model.

The semiconservative nature of replication was elegantly suggested by a classic experiment that allowed the physical separation and identification of the parental and the newly synthesized strands. *Escherichia coli* was grown in a medium containing [^{15}N]-ammonium chloride as the exclusive source of nitrogen. Several cell divisions were allowed to occur, during which the naturally occurring ^{14}N in the DNA of *E. coli* was, for all practical purposes, replaced by the heavier ^{15}N isotope. The ^{14}N -containing nutrient was then added, and cells were removed at appropriate intervals. The DNA of these cells was extracted, and the ratios of ^{14}N to ^{15}N content were determined by equilibrium density gradient centrifugation. The separation between [^{14}N]DNA and [^{15}N]DNA was achieved based on the lower density of DNA, which contained the lighter isotope. In subsequent experiments, the newly synthesized DNA was thermally denatured and the individual strands were completely separated. The results, shown in Figure 15.23, demonstrated that daughter DNA molecules consisted of two strands with different densities, corresponding to the densities of single-stranded polynucleotides containing exclusively ^{14}N or ^{15}N . Conservative and dispersive replications are clearly inconsistent with these findings.

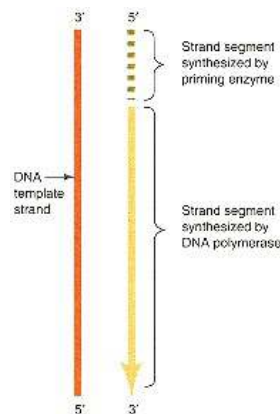

Figure 15.24

Synthesis of primer for DNA replication.

Primer (dashed line) is synthesized by primase. A primer permits new DNA (orange line) to be synthesized by DNA polymerases. The primer is excised at the completion of DNA synthesis.

A Primer Is Required

The semiconservative nature of replication requires that each strand serve as a DNA polymerase template for the synthesis of a new complementary strand. Elongation is catalyzed by polymerase III (Table 15.1), as distinguished from polymerase I, which is primarily involved in repair. Polymerase III, which is ATP-dependent, is unable to assemble the first few nucleotides of a new strand and requires a primer. In *E. coli* primers are segments 10–60 nucleotides long. With few exceptions, the primer is an oligonucleotide synthesized by other enzymes, as indicated in Figure 15.24. **Primers** are formed by **primases**, although in a few instances **RNA polymerases** are known to synthesize a primer. In some bacterial systems and phages, the priming enzyme has activity characteristic of an RNA polymerase because the ribonucleotides condense to form the primer. In other systems the primase does not discriminate between 5'-ribonucleotides and 5'-deoxyribonucleotides. As a general rule, however, primases use ribonucleotides for incorporation into primers. Some enzymes that catalyze the synthesis of primers act exclusively as primases, while others possess additional enzymatic activities. In mammalian cells primase activity is vested in **DNA polymerase α** , an enzyme that is also involved in DNA strand

elongation and in DNA repair. Once the primers have been synthesized, the DNA polymerase can move in and take over the process of synthesis. It is not clear what signal causes a switchover from primase to DNA polymerase, although it has been suggested that a specialized ribonuclease (**RNaseH**) is involved.

15.6 RNA Primers

Replicating System	RNA Oligonucleotide ^a
Bacteriophage T4	pppAC (N) ₃
Bacteriophage T7	pppACCA pppACCC
Mouse polyoma virus	pppA (N) ₉ pppG (N) ₉
Lymphoblastoid cells	pppA (N) ₈ pppG (N) ₈

^a N stands for any ribonucleotide. The primer lengths for the mouse polyoma virus and the animal cells are averages.

If DNA polymerase were the enzyme that would begin DNA synthesis by laying down the very first nucleotide complementary to the template, the efficiency of DNA synthesis would be severely reduced. Since the bases in a very short segment of a double helix have high configurational flexibility, the first nucleotide introduced into a newly synthesized DNA strand would likely be mispaired and would immediately activate the proofreading activity of DNA polymerase. The outcome would be a fruitless back-and-forth cycle of synthesis and proofreading by DNA polymerase with little net synthesis of new DNA. In contrast, primases, which have no proofreading ability, can quickly and efficiently position primers that can be elongated with DNA polymerases without appreciable backtracking. The primases ignore mismatches and produce an RNA chain long enough to allow the DNA polymerase to operate at the 3' end of a double-stranded structure that restricts newly introduced nucleotides on the basis of strict complementary rules. The mismatches introduced by the primase are irrelevant because the characteristic RNA-like structure of primers allows for their subsequent wholesale removal and replacement by DNA of an equivalent composition.

Although primers are almost invariably short RNA or RNA-like segments (Table 15.6), RNA priming is not used universally. In the "rolling circle" replication mechanism of DNA, a 3'-OH primer is generated by endonuclease digestion of parental DNA, and with **parvoviruses** a 3'-OH primer is generated by the folding back of an existing 3' terminus. A single deoxyribonucleotide can serve as primer in **adenovirus**. Such a nucleotide, with its 3'-OH terminus free, is attached to the end of a template strand through a virus-encoded specific protein (Figure 15.25).

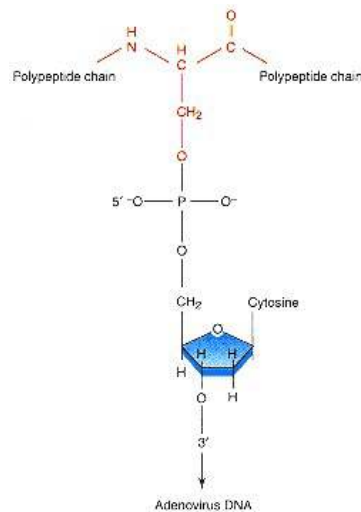

Figure 15.25
An unusual primer used in the replication of adenovirus DNA.

This primer is a single nucleotide attached, by its 5-terminal phosphate, to a serine residue of a protein. Adenovirus DNA is synthesized by extension of the 3' terminus of this nucleotide.

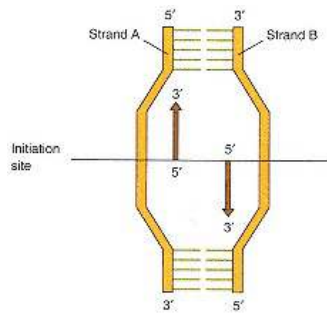

Figure 15.26

Both DNA strands serve as templates for DNA synthesis.

Each DNA strand must serve as a template for DNA synthesis. The new DNA can be synthesized only in the 5' → 3' direction.

If only a single initiation origin were considered, the result of continuous synthesis would be the formation of two new nonidentical double-stranded DNA molecules (one above and one below the initiation origin). Also, the upper part of strand A and the lower part of strand B could not have been used as templates.

In fact, the synthesis occurs both continuously and discontinuously.

Both Strands of DNA Serve As Templates Concurrently

In the preceding section, the events leading to the synthesis of DNA by DNA polymerase were examined and attention was directed to one of the two parental DNA strands used as template. In fact, synthetic events occur at both strands almost concurrently. This would appear to generate some problems of geometry. Specifically, if a single initiation site is considered, and the synthesis continued in the 5' → 3' direction until each template is completely copied, the result of the synthesis would be the creation of two new double-stranded molecules. Examination of Figure 15.26 indicates that, at least in the case of linear double-stranded DNA, neither of these two hypothetical DNA molecules would be identical to the parental DNA.

Such an outcome is not in agreement with the actual course of DNA replication. The discrepancy can be accounted for by recognizing that the microscopic synthesis of the new strands does not proceed uninterrupted. In fact, the synthesis occurs in a discontinuous fashion and in a manner that permits the assembly of the synthesized polynucleotide portions into appropriate complete DNA strands.

Synthesis Is Discontinuous

The overall process of DNA synthesis may now be considered past the immediate vicinity of initiation by examining a larger section of DNA. One of the two parts of DNA that would be generated if the macromolecule were divided at the site of chain initiation is shown in Figure 15.27. In almost every instance the synthesis is **bidirectional**, which means that the synthetic events occurring at the part of the molecule indicated by solid lines are of the same general nature as those occurring on the other site and indicated with dashed lines.

A prerequisite for the semiconservative mechanism of replication is that the two complementary strands of DNA gradually separate as the synthesis of new strands takes place. The mechanics of this separation are addressed later, but it may be apparent that as a result of separating the strands at an interior position, two topologically equivalent forks are created at the point of diversion of the two strands.

Various lines of evidence have indicated that DNA polymerase acts in a **discontinuous** manner; that is, along each DNA molecule there are numerous initiation points at which primers are formed. In eukaryotes primers may be formed at locations that are determined by nucleosome spacing. In the case of bacteriophage T7, primosomes appear to recognize TGGT and GGGT through prepriming proteins. Once a site for primer initiation has been recognized,

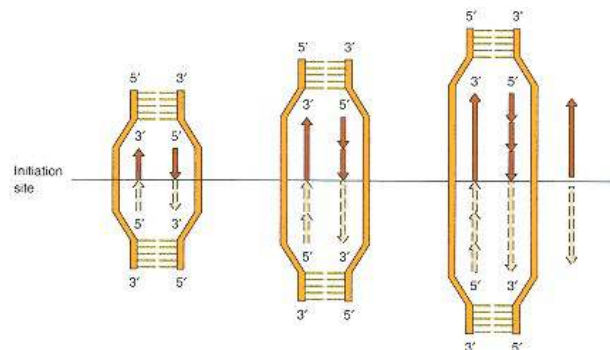

Figure 15.27

Discontinuous synthesis of DNA.

This figure emphasizes the synthetic events occurring at only one side of the initiation site (dark red line). The two complementary strands of DNA separate as the discontinuous synthesis of small DNA segments takes place on both strands located at different sites on the DNA. After excision of the primers, the excised parts are repaired, and the segments are joined together. Although segments are clearly synthesized in opposite directions on the two strands, overall macroscopic impression is that DNA grows in the single direction suggested by the solid red arrow on the right.

single-strand binding proteins (SSB), which interact with single-stranded polynucleotides, are displaced and the primase lays down a primer. After promoting primer initiation at one point, prepriming proteins move along the template strand in order to synthesize the adjacent primer. At each one of these locations, DNA polymerase III makes use of the assembled primers for the synthesis of DNA. When DNA polymerase reaches the end of the single-stranded template, it comes upon the next primer annealed to the template. The polymerase, as indicated by its very high processivity, can overcome this hurdle by sliding over the intervening double-stranded DNA–RNA hybrid and resuming replication at the 3' end of this new primer.

The segments synthesized by DNA polymerase upon each primer, known as **precursor (Okazaki) fragments** or **nascent DNA**, vary in size from about 100 to 200 deoxyribonucleotides in eukaryotes to ten times as long in bacteria. Once these segments of the new DNA are synthesized on both strands of a fork (Figure 15.27), the fork opens up further, and the same process of synthesis is repeated. Shortly after synthesis, the primer portions of the Okazaki fragments are excised by the 5'–3' exonuclease activity of DNA polymerase I, which also synthesizes short segments of DNA.

This discontinuous mechanism compensates for the inability of DNA polymerase to synthesize strands in the 3'–5' direction. By synthesizing portions of DNA strands only in the 5'–3' direction on both antiparallel strands of the parental DNA, the polymerase is able to create the illusion, when the synthesis is experimentally visualized by electron microscopy techniques, that both strands are concurrently elongated in the same macroscopic direction. In Figure 15.27 this direction is indicated by a large solid arrow. It should be noted that the first strand synthesized, often referred to as the **leading strand**, is synthesized continuously. It is the other strand, the **lagging strand**, that must be synthesized discontinuously.

Macroscopic Synthesis Is As a Rule Bidirectional

At the site of initiation of DNA synthesis two identical forks are created (Figure 15.27). Therefore two possibilities exist for the synthesis of DNA: the process may occur at only one fork and proceed in a single direction, as shown by the thick solid arrow, or alternatively it may occur at both forks and in both directions away from the starting point. The events occurring in the forks located below the starting line are simply a mirror image repetition of what occurs in the fork that is located above the line. **Bidirectional replication** is the mechanism of DNA synthesis. The only known exceptions are in a small number of phages and plasmids that replicate unidirectionally. In the case of a small linear chromosome (e.g., bacteriophage λ) each fork moves along, synthesizing new DNA, until the end of the chromosome is reached. In a circular chromosome (e.g., *E. coli*) the two forks proceed in opposite directions until they meet at a predetermined site on the other side of the chromosome, as depicted in Figure 15.28. As the two forks meet, a new copy of the parental DNA is completed and released. The average rate at which each fork moves during replication is of the order of 60,000 bases per minute at 37°C. Upon completion, new DNA is released by the action of a type II topoisomerase as illustrated in Figure 15.29.

Strands Must Unwind and Separate

Separation of the strands of the parental DNA prior to synthesis of new strands is a requirement because the bases of each template must be made accessible to the complementary deoxyribonucleotides from which the new strands are constructed. The overall process of separation consists of a number of enzymatically catalyzed, coordinated steps, including the local unwinding of the helix, and the nicking and rejoining of the strands necessary for continuation of the

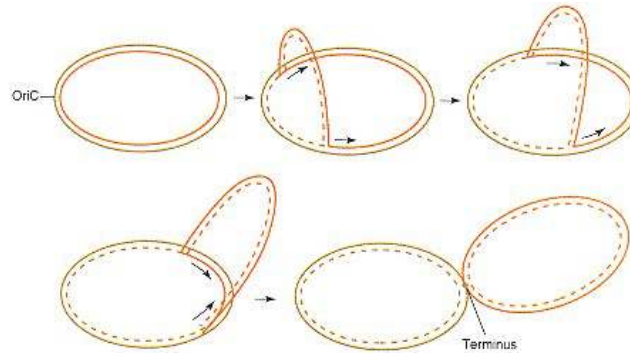

Figure 15.28
Bidirectional replication of a circular chromosome.
 Replication starts at a fixed origin and proceeds at a constant rate in opposite directions until the two replication forks meet. Newly synthesized strands are indicated by dashed lines. After DNA synthesis is complete, two newly synthesized circular DNA molecules are separated by action of topoisomerases.

unwinding process. Once the strands are unwound, they must be kept separate so that they can operate freely as templates.

Specialized proteins accomplish rapid orderly unwinding of the strands. These proteins, **helicases**, separate DNA strands in advance of the moving replication fork and just in front of DNA polymerase. In *E. coli* they are referred to as **helicase II** and **rep protein**. Helicases move unidirectionally along DNA and separate the strands in advance of replication. They destabilize the interaction between complementary base pairs at the expense of ATP.

Once the strands have been separated, the single-stranded regions are stabilized by specific proteins, the **single-strand binding (SSB) proteins**. The DNA single strands are covered by the SSB proteins because of their high affinity for single-stranded DNA. As the helicase moves in advance of the replication fork, SSB proteins go on and off the DNA, with protein molecules that are displaced from one site reassociating with another (Figure 15.30). SSB proteins do not consume ATP and do not exhibit any enzymatic activities. Their role is only to keep the strands apart long enough for the priming process to occur.

In *E. coli* DNA, it is calculated that the parental double helix must unwind at a rate of about 6000 turns per minute. These high rates would generate insurmountable difficulties if strands were to separate over an appreciable length of DNA. The large free-energy requirements of bringing about the unwinding of large regions of DNA can, however, be reduced to manageable levels by the nicking of one or both of the DNA strands near the replicating fork. Since the fork is a moving entity, the nicking must be visualized as a reversible cut-and-rejoin process, which moves along with the fork. Nicking is indispensable for a topological reason as well. Unwinding at one of the two forks requires that the parental double helix rotate in the opposite direction to that necessary for the unwinding of the opposite fork. In the absence of a nick as the unwinding at one of the forks would progress, an increasing number of positive supercoils would have to be introduced into the double helix. Once the limit of the helix to accommodate the supercoils were reached, unwinding and replication would have to cease.

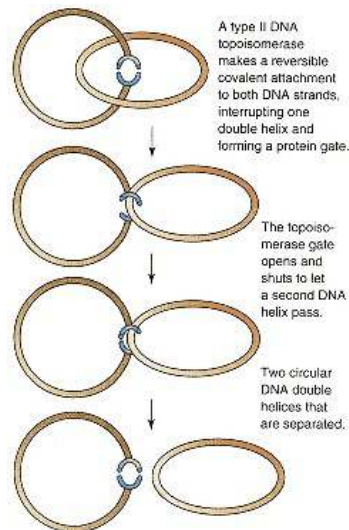

Figure 15.29
Function of topoisomerases II in separating interlocked DNA double helices.
 Topoisomerase II attaches to both strands of DNA through reversible covalent bonds, thus forming an interrupted double helix with a topoisomerase "gate." A second DNA helix can pass through the portal using an "open-and-shut-the-gate" mechanism, leading to two separated DNA molecules. After separation of the molecules topoisomerase dissociates from DNA.

These topological restraints are overcome if DNA is maintained during replication in the **negative superhelical form**. This form could serve as a "sink" for the positive supercoils that could potentially be generated during replication. In *E. coli*, this is apparently achieved by the action of **gyrase**, a **topoisomerase type II**, which induces the formation of negative supercoils

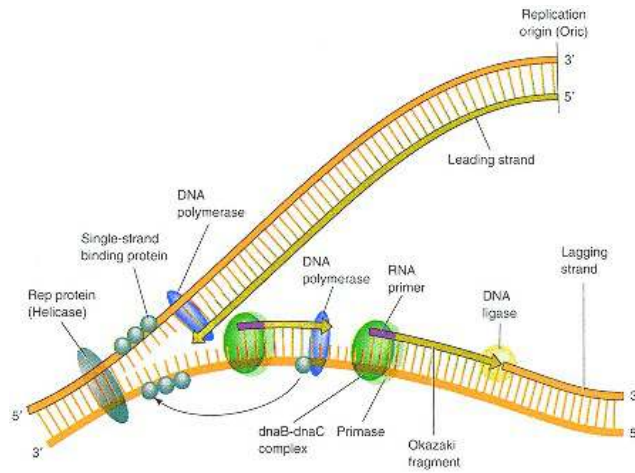

Figure 15.30
Model for DNA replication in *E. coli*.

The initial stages of replication are depicted. Primers are removed from newly synthesized segments of DNA at the lagging strand, and the segments are joined. Since replication is normally bidirectional, similar events take place concurrently at the other side of the initiation origin.

at the expense of ATP. **Topoisomerases type I** may also be involved. The superhelicity of DNA may be negatively regulated through a balance between topoisomerases of types I and II; that is, a diminishment of topoisomerase II activity may bring about a decrease in the amount of negative superhelicity that can be created, whereas an inhibition of topoisomerase I activity may increase it. During replication the linking number between parental strands decreases from a large value at the beginning of replication to zero at the end of a complete round of DNA synthesis.

TABLE 15.7 Components of the Replisome

Protein	Function
SSB	Single-strand binding
Protein i (dnaT) Protein n Protein n Protein n dnaG	Primosome assembly and function Primase (primer synthesis)
Pol III holoenzyme	Processive chain elongation
Pol I	Gap filling and primer excision
Ligase	Ligation
Gyrase	Supercoiling
gyrA	
gyrB	
rep	Helicase
Helicase II	
dnaB	Helicase
dnaA dnaC	Origin of replication

***Escherichia coli* Provides Basic Model for Replication of DNA**

Extensive studies in *E. coli* and its phages have permitted the proposal of a replication model that depends on the action of a large number of proteins, some of which are listed in Table 15.7. With the specific exceptions noted in the sections that follow, this model may also be viewed as a basic scheme for DNA replication in most other cells.

Initiation and Progression of DNA Synthesis

Synthesis of DNA begins at a specific site of the chromosome referred to as the **replication origin**, which in *E. coli* is referred to as **OriC** (Figure 15.30). Initiation of DNA synthesis involves participation of as many as 20–30 different proteins, many of which are needed to be present at the origin of replication in multiple copies. OriC must be recognized by specific proteins, and the origin must unwind to allow helicase, primase, and DNA polymerase III to have access to each DNA strand. OriC is a sequence of 245 base pairs that contains four sites (nucleotide 9-mers with a similar nucleotide sequence) at which **dnaA**, a tetramer consisting of four identical subunits, can initiate the stepwise assembly of all the proteins and enzymes necessary to carry out replication (Figure 15.31). In addition, the origin contains 11 methylation sites recognized by **Dam methylase** and three AT-rich direct tandem repeats consisting of 13 base pairs each. This final assembly is called a **replisome**.

Formation of a replisome begins with the binding of one dnaA molecule

at each one of the 9-mers, provided that these binding sites are fully methylated. The *dnaA* apparently recognizes these 9-mers on the basis of their conformation, which appears to be slightly curved with the double helix somewhat elongated relative to typical B-DNA. Several more additional *dnaA* molecules are then added via a highly cooperative process to form a nucleosome-like structure. An additional factor, **HU protein**, participates in the formation of this complex.

The *dnaA* and HU protein interact with the *OriC* in a manner that promotes the opening of the DNA strands in the AT-rich regions adjacent to the origin. Finally, *dnaA*, with the aid of ***dnaC***, adds ***dnaB*** in the complex. The *dnaB*, by virtue of its helicase activity, creates an initiation "bubble" consisting of a few hundred nucleotide pairs. The energy for the formation of the "bubble" is provided by ATP in a reaction catalyzed by topoisomerase II, and the "bubble" is stabilized by SSB proteins.

Synthesis of an RNA primer begins with the formation of a prepriming complex. The prepriming assembly consists of the *dnaB*–*dnaC* complex to which four other proteins (polypeptides n, n', n'', and i) have been added. Addition of primase, ***dnaG***, converts the prepriming complex to a **primosome**

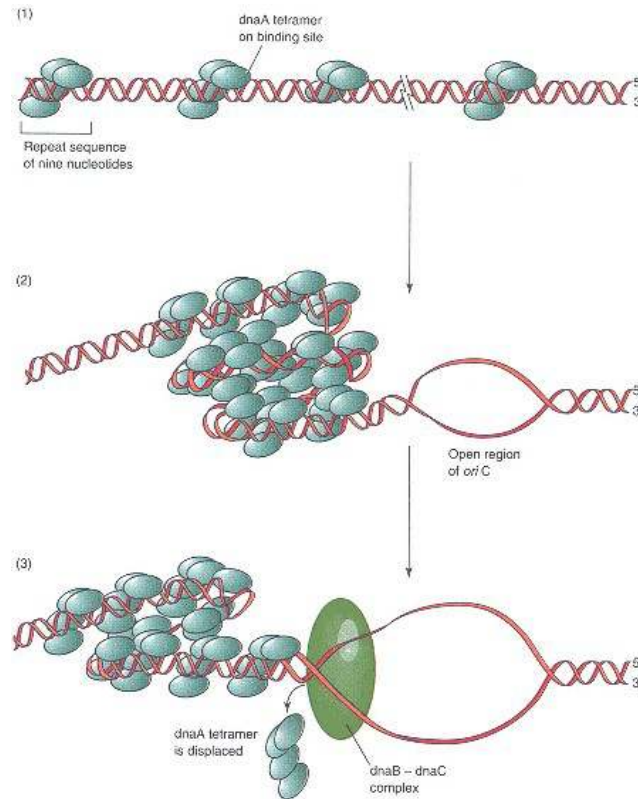

Figure 15.31
Model for initiation of replication in *E. coli*.

Step 1: Initiation of replication begins with binding of *dnaA* molecules to four sites consisting of nine-nucleotide long sequences each. These sequences are present at the origin of replication in *E. coli* (*OriC*).

Step 2: DNA-bound *dnaA* molecules subsequently coalesce and are joined by additional *dnaA* molecules to form a nucleosome-like DNA-protein complex, which promotes nearby "melting" of the double helix.

Step 3: The resulting opening of strands allows a *dnaB*–*dnaC* complex to become attached to DNA so that helicase activity of *dnaB* can further unwind the DNA. Unwinding is accompanied by a displacement of *dnaA* molecules.

Redrawn based on figure in Rawn, J. D., *Biochemistry*. Burlington, NC: Neil Patterson Publishers, 1989.

(Figure 15.32). The primosome interacts with a template, at each one of the two forks generated by the formation of a "bubble," and begins the synthesis of RNA primers on the two leading strands. Assembly of the replisome is completed by addition to the primosome of DNA polymerase III and **rep proteins**.

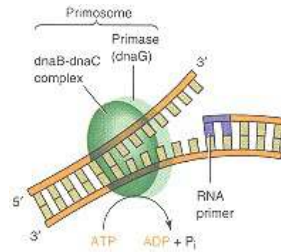

Figure 15.32
Primosome of *E. coli*.

The primosome is formed by binding of primase, together with a complex of dnaB and dnaC proteins, at specific sequences of DNA that serve as sites for formation of RNA primers.

Additional factors, described as π proteins, are specific primosomal components that are responsible for placing the primosome at the appropriate sequences. In effect, the primosome "searches" the DNA for these sequences at the expense of ATP. Once the correct destination of the primosome is reached, RNA primer synthesis is initiated.

Initiation can be regulated by either restricting the availability of dnaA-binding sites at OriC or by limiting the concentration of dnaA. **Methylation** provides a switch for the availability of dnaA-binding sites. Once replication has been initiated, the dnaA near OriC binds to the plasma membrane and becomes unavailable to Dam methylase. In addition, binding of DNA in the vicinity of OriC to the cellular membrane sequesters the *dnaA* gene, which is situated near OriC (only 40 kb away). As a result, the synthesis of dnaA protein is inhibited and its cellular concentration is lowered.

Initiation of the leading DNA strand at OriC by the primosome is more complex than the subsequent initiation of synthesis of Okazaki fragments on the lagging strand initiated by primase at sites selected by the prepriming proteins. The initiation of the leading strand does not present the cell with serious topological problems, but for continuation of synthesis helicase II and rep protein are essential. These enzymes unwind and separate the strands in each of the two forks created by the initiation event. As the helicases move in advance of each fork, two single-stranded regions are generated on parental DNA. These regions are immediately covered by single-strand binding protein that keeps the fork open and allows DNA polymerase III to take over the elongation of primers. A signal for initiation of the lagging strand, uncovered on the template by the movement of helicase, leads to the binding of primase. Primase, the action of which is triggered by the prepriming proteins, synthesizes a brief complementary segment of the strand. This segment serves as a primer for covalent extension of the strand synthesized by DNA polymerase III and for formation of Okazaki fragments. DNA polymerase III complexes are endowed with similar but somewhat distinct properties, one tailored for the continuous synthesis of the leading strand and the other for the discontinuous synthesis of the lagging strand. This polymerase assembly, which appears to combine primase activity with nonidentical twin active sites for polynucleotide synthesis, allows for concurrent replication on both strands. In this scheme, looping of the lagging strand template by 180° brings it to the same orientation as the leading strand template (Figure 15.33). Thus a primer synthesized at the lagging strand is drawn past it. When a nascent (Okazaki) fragment reaches the 5' end of the previously synthesized Okazaki fragment, the lagging strand template is released and unlooped. Removal of the primer portions at the 5' end of the Okazaki fragments by DNA polymerase I, repair by the same enzyme, and joining of the repaired fragments by DNA ligase produces intact DNA strands.

Termination of DNA Synthesis

Termination occurs near the center of a 270-kb region across from OriC, the **ter** or **τ locus**. This region incorporates five *ter* sequences, that is, loci with the core sequence GTGTGTTGT that bind the **Tus protein (terminator utilization substance)** that promotes the termination of synthesis (Figure 15.34). Tus protein is a contrahelicase in that it functions by literally interfering with the ATP-dependent and dnaB helicase-promoted unwinding of DNA rather than simply impeding the propagation of this helicase along the double helix. The organization of the *ter* region is shown in Figure 15.34. Each Tus site has directional properties (asymmetry) and it arrests only those replisomes that reach the Tus site from one specific direction. Replisomes arriving from the opposite direction apparently force the dissociation of the Tus protein and thus

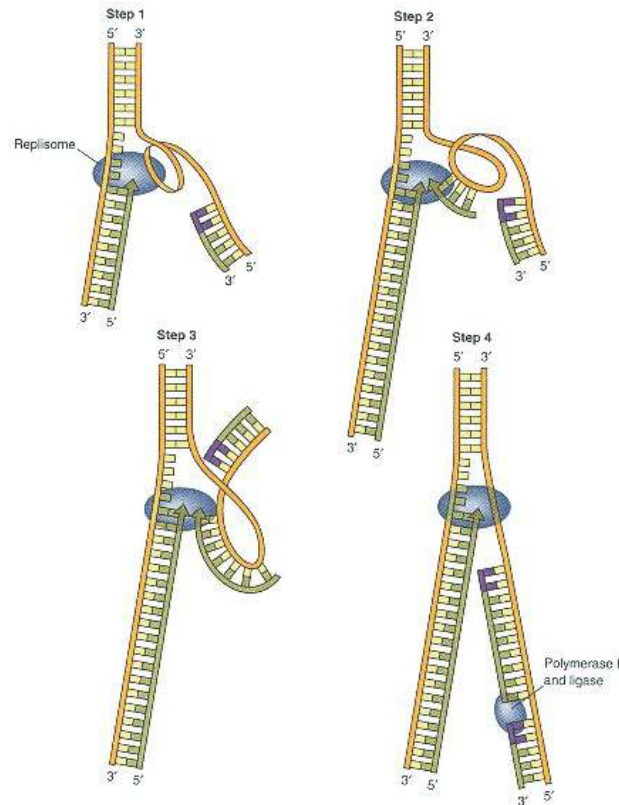

Figure 15.33
Model for the simultaneous synthesis of leading and lagging DNA strands by DNA polymerase.

Two molecules of DNA polymerase operating in concert, and in the same rather than the opposite direction, may be participating in the simultaneous synthesis of DNA on both strands. In this model the replisome consists of a DNA polymerase dimer associated with the primosome and helicases. The primer made by the primosome is extended by the replisome as the lagging-strand template is looped through it. The primer continues to be extended until the previously completed Okazaki fragment is reached, at which point the loop is relaxed. The stretch of unpaired lagging-strand template then loops back again to participate in the formation of the next Okazaki fragment.

Redrawn based on figure in Kornberg, A. *DNA Replication*.
 San Francisco: Freeman, 1992.

can proceed unimpeded past the Ter–Tus site. Because of the distribution and orientation of sites in the ter region, each replisome must first pass over all sites that are oriented the opposite way before arriving at the Tus site that is oriented in a way that causes termination. This arrangement makes it inevitable that a replisome will not dissociate from DNA until it actually collides with the replisome entering the ter region from the opposite direction. This ensures the complete replication of the chromosome and prevents overreplication. The products of replication are two **concatenated** progeny chromosomes usually interwound by as many as 30 coils. The newly synthesized DNA is untangled from the parental DNA apparently by the action of a topoisomerase II.

Rolling Circle Model for Replication

DNA synthesis directed by circular mtDNA, and in some instances by bacteria and viruses, gives rise to linear daughter DNA molecules that contain the base sequence of parental DNA repeated numerous times. These repeated linear DNAs, which are known as **concatemers**, are essential for the bacterial mating and may be involved in gene amplification. The synthesis of concatemer DNA occurs by a mechanism known as **rolling circle replication**.

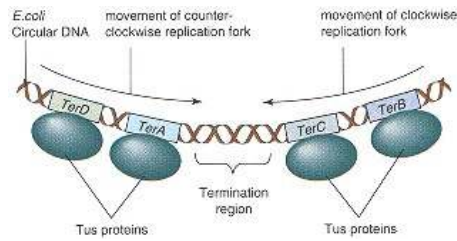

Figure 15.34

Termination of DNA replication in *E. coli*.

Termination region (*ter*) of *E. coli* incorporates five asymmetric *ter* sites. Each *ter* site can interact with Tus protein. *TerB* and *terC* are oriented in the same direction and the remaining three *ter* sites are oriented in the opposite direction. Because of the orientation of Tus-bound *ter* sites, each replisome that reaches the *ter* region must cross all the Tus-*ter* sites that are oriented the opposite way before arriving at a site that causes termination. A replisome moving in the direction shown by the arrow must first cross *terE*, *terD*, and *terA* before terminating replication at either the *terC* or *terB* site. This arrangement ensures that each replisome continues to synthesize DNA until it collides with a replisome entering the *ter* region from the opposite direction, leading to the dissociation of both replisomes from DNA.

Adapted from Hidaka, M., Kobayashi, T., and Horiuchi, T. *J. Bacteriol.* 173:381, 1991.

An example is the replication of certain circular single-stranded bacteriophages such as ϕ X174. When the virus enters a host bacterium the single-stranded genome is converted to a double-stranded DNA by action of primase and DNA polymerase III. The DNA strand complementary to the bacteriophage genome that is first synthesized [labeled the (-) strand] serves as the template for the genomic DNA [the (+) strand]. The atypical characteristic of this replication scheme is that the (+) strand is nicked at a specific site (by a phage-encoded endonuclease) so that it can serve as a primer for its own replication. The (+) strand is elongated from the 3'-hydroxyl end of the nick by DNA polymerase III by incrementally displacing segments of the (+) strand associated with the "helper" (-) strand (Figure 15.35).

A second characteristic is that the circular template does not dissociate from the complementary strand during the synthesis. Instead the replication of the leading strand goes on beyond the length of circle-generating linear concatemeric DNA. Appropriately sized DNA molecules are subsequently generated from concatemers by specific endonuclease cleavage.

Eukaryotic DNA Replication

The DNA synthesis in eukaryotes appears to be a process that is fundamentally similar to that occurring in prokaryotes. Formation of a replication fork, primer

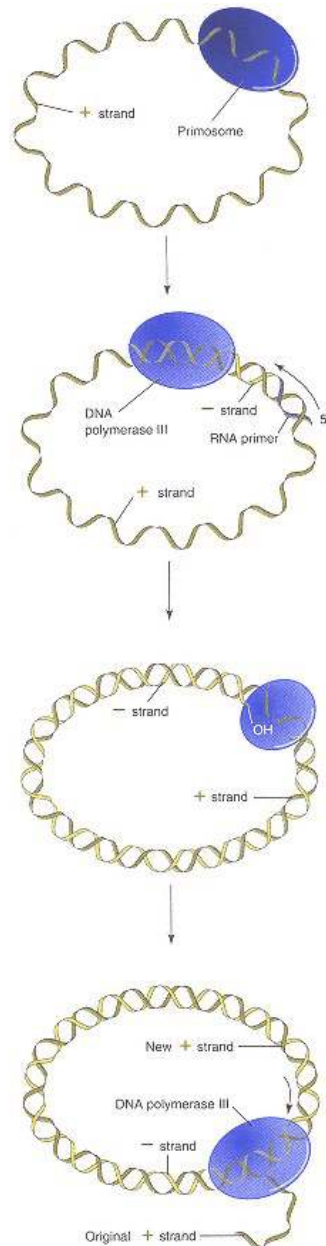

Figure 15.35

Replication by the rolling circle mechanism.

In ssDNA of certain bacteriophages, such as ϕ X174, the (+) strand is converted into dsDNA upon injection into a host bacterium.

This transformation occurs by action of primase and polymerase III upon ssDNA that synthesizes a complementary (-) strand. Replication of (+) strands begins with nicking of (+) strand so that it can serve as a primer for its own replication. The (+) strand is elongated from the 3'-hydroxyl end of the nick, as the newly synthesized strand gradually displaces from the helper-strand the original (+) strand.

Redrawn based on figure in Moran, L. A., Scrimgeour, K. G., Horton, H. R., Achs, R. S., and Rawn, S. D. *Biochemistry*. Englewood Cliffs, NJ: Neil Patterson/Prentice Hall, 1994.

synthesis, Okazaki fragments, primer removal, and gap bridging between newly synthesized DNA segments, all parallel the corresponding steps that occur in prokaryotes, but the overall process is quite a bit more complex. Replication among eukaryotes, from yeasts to humans, shares similarities.

As expected, differences are more pronounced between prokaryotes and eukaryotes. In rapidly growing prokaryotes, DNA is replicated through much of the cell cycle and cell division occurs as soon as DNA synthesis has ceased. In contrast, eukaryotic DNA synthesis (and histone synthesis) is confined to only one part of the cell cycle, specifically the synthetic (S) phase of the interphase. This phase is preceded and followed by two periods during which DNA is not synthesized (gap periods G1 and G2). Cell division occurs at a different time within the interphase, referred to as the mitotic (M) period. Beyond this characteristic limitation of eukaryotic replication to a certain period of the cell cycle, important differences in replication between prokaryotes and eukaryotes arise primarily from the larger size of eukaryotic DNA (about 10^5 – 10^6 kb content) as compared to prokaryotic DNA (about 5×10^3 kb for *E. coli*), the distinct packaging of eukaryotic DNA in the form of chromatin, and the slower rates of fork movement in eukaryotes. For DNA to become available to DNA polymerases, nucleosomes must disassemble, a step that slows the rates of fork movement. DNA polymerase movement does not exceed 30,000 base pairs per minute, which is considerably slower than the rates observed for *E. coli*. Based on the higher DNA content of animal cells, and the lower activities of DNA polymerases in comparison to bacteria, the replication cycle of eukaryotic cells could be expected to take as long as a month to complete. In fact, however, the replication cycle is completed within hours, because compensating factors are in operation. Eukaryotic cells contain a large number of DNA polymerase molecules (often in excess of 20,000) as compared to a few dozen in each *E. coli* cell. DNA polymerase initiates bidirectional synthesis but at several origins of replication located anywhere between 5 and 300 kilobase pairs (kb) apart within the chromosome, depending on species and cell type (Figure 15.36). DNA segments between two origins of replication are termed **replicons**. An average human chromosome contains as many as 100 replicons and replication may proceed simultaneously at as many as 200 forks. More origins can be found in developmentally active cells that carry out DNA synthesis at very rapid rates. During early embryogenesis the largest chromosome of *Drosophila melanogaster* contains as many as 6000 replicating forks, or one for every 10 kb.

Role of Eukaryotic DNA Polymerases

In prokaryotes synthesis is catalyzed by two similar but distinct subunits of DNA polymerase III. In eukaryotes, synthesis of the leading and lagging strands is carried out by different enzymes (Table 15.2). **DNA polymerase δ** , a polymerase of high processivity, catalyzes the synthesis of the leading strand. This enzyme consists of a large subunit that is vested with 5' \rightarrow 3' nucleotide polymerizing activity and a smaller subunit that has a 3' \rightarrow 5' proofreading exonuclease activity. The high processivity of DNA polymerase δ is attributed to the presence of an accessory factor, the **proliferating cell nuclear antigen (PCNA)**, that is found in large amounts in the nuclei of proliferating cells. PCNA (mol wt 25,000) is a multimeric protein that can act as a "clamp" to keep the enzyme from disassociating off the leading DNA strand. The "clamp" consists of three PCNA molecules, each containing two topologically identical domains that are tightly associated to form a closed ring. This suggests that in eukaryotes PCNA is the functional equivalent of the β subunit of *E. coli* polymerase III. Another accessory protein, the **replication factor C (RFC)**, also binds to polymerase δ and probably assists with association between PCNA and DNA to form the "clamp." Alternatively, RFC may be involved in setting up a link

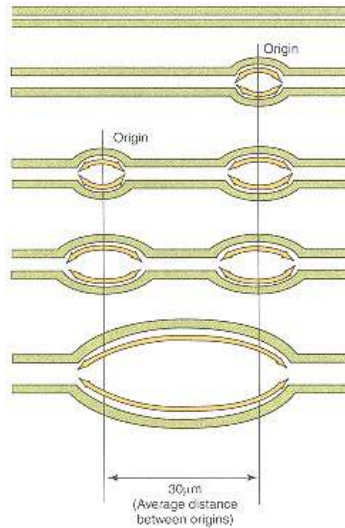

Figure 15.36

Replication of mammalian DNA.

Mammalian DNA replicates by using a very large number of replicating forks simultaneously. This mechanism accelerates the process of replication, which in mammalian systems is limited by rates of fork movement that are considerably slower than those characteristic of prokaryotes.

Redrawn based on figure in Huberman, J. A., and Riggs, A. D. *J. Mol. Biol.* 32:327, 1968.

between polymerase δ and polymerase α . Therefore the role of RFC in DNA synthesis is analogous to the roles of the γ complex and the δ subunits of *E. coli* DNA polymerase III.

Synthesis of the lagging strand is catalyzed by **DNA polymerase α** . This polymerase has similar structure and properties in all eukaryotes. The large subunit (mol wt $\sim 180,000$) of the tetrameric DNA polymerase α is vested with the usual $5' \rightarrow 3'$ nucleotide polymerizing activity. Polymerase α , isolated from some but not most sources, also has a $3' \rightarrow 5'$ exonuclease activity. Two of the other subunits of the enzyme are **primases**. The primary proofreading function in eukaryotes appears to be carried out by polymerase δ . Polymerase ϵ improves the fidelity of replication by a factor of 10^2 and contributes in limiting the rates of overall error to 10^{-9} to 10^{-12} .

The relatively low processivity of DNA polymerase α is typical for an enzyme involved in synthesis of the lagging strand that is assembled from segments of DNA that are no larger than 100–200 bp. The size of these Okazaki fragments is approximately equal to the length of DNA wrapped around a nucleosome. This observation suggests that eukaryotic DNA may be releasing one nucleosome at a time for priming of the lagging chain. The primase subunit of the enzyme synthesizes Okazaki segments as a closely coordinated priming–synthesizing activity, by laying down RNA primers containing 5–15 nucleotides that are subsequently extended by the synthetic activity of polymerase α . This polymerase catalyzes the synthesis of a polynucleotide chain at a rate of 50 nucleotides per second, which is about 1/20 the rate of *E. coli* DNA polymerase III synthesis. Looping of the lagging strand allows a combined polymerase α -polymerase δ asymmetric dimer to assemble and elongate both the leading and lagging strands in the same overall direction that corresponds to the direction of the fork movement. A third large monomeric protein, **polymerase ϵ** , is vested with a synthetic $5' \rightarrow 3'$ polymerase activity and both a $3' \rightarrow 5'$ proofreading exonuclease activity and a $5' \rightarrow 3'$ exonuclease activity. Polymer-

ase is mainly required for DNA repair and for filling the gaps between Okazaki fragments on the lagging strand.

Eukaryotic DNA synthesis requires **replication protein A (RPA)**, also known as **replication factor A (RFA)**. This protein is the functional equivalent of prokaryotic single strand binding (SSB) protein. While helicase activities are part of the prokaryotic chromosome, eukaryotic helicases do not appear to be associated with primase activity. Eukaryotic helicase activity appears to be associated with DNA polymerase .

Initiation of Eukaryotic DNA Replication

Origins of replication in eukaryotic cells have been identified in yeast (*Saccharomyces*) and are termed ARS for **autonomously replicating sequence**. ARSs are about 100–120 bp long, each of which is characterized by an AT-rich central region. The 400 or so copies of the ARS in the yeast genome have highly conserved nucleotide sequences within the central region with variations in the flanking sequences. The core sequences of ARS contain 11-bp elements known as the **ARS consensus sequence** rich in AT pairs that appear to be analogous to the AT-rich 13-mers present in the OriC of *E. coli*. The flanking elements consist of overlapping sequences that include variants of the core sequence. Protein binding to form a so-called **origin of replication complex (ORC)** promotes DNA strand unwinding over the AT-rich sequences of the ARS cores. The unwound region is stabilized by single-strand-binding protein and RPA, and is extended by helicase. Polymerases α and δ , RFC, and PCNA are thus introduced into the origin of replication and begin DNA synthesis.

Weaker binding sites identified as B1, B2, and B3 are also present near the origin. B1 and B2 serve as sites for ORC formation, while B3 is associated with a protein that promotes initiation of transcription. This observation highlights the close association between eukaryotic DNA replication and transcription. Controlled activation of variant ARS-like subgroups, consisting of ARS-like sequences with different flanking elements, may determine the order of initiation of DNA synthesis in eukaryotes. Sequences completely comparable to yeast ARS have not been identified in higher eukaryotes. In mammals it appears that initiation depends more on chromosomal context than on specific sequences. Origins of initiation may be found within a broad section of the genome that also contains a small number of "hot spots," at which initiation is favored. In spite of these differences in the origins of replication between yeast and higher eukaryotes, the rest of the replication machinery appears to be remarkably analogous. Eukaryotic genomes replicate in a definite order, and at definite times within the S phase, with some DNA regions replicating early in the S phase and other DNA regions replicating later. Genes that replicate early are found in active segments of chromosomes, and genes that replicate later are located in the inactive areas of chromosomes. This pattern of activation changes with development. Differences in the rate of replication are regulated by variations in the duration of the S phase, which can be achieved either by controlling the number of replicons activated per unit length of chromosome or by slowing down the rate of DNA unwinding and replication. Sequence elements similar to the ARS subgroups in yeast may control replicon activation in other eukaryotes through the interaction of initiating proteins with these elements. Origins that are activated simultaneously are expected to share the same DNA sequences and bind to the same control proteins.

Since eukaryotic DNA is present in packaged form as chromatin, DNA replication is sandwiched between two additional steps, namely, a carefully ordered and incomplete dissociation of the chromatin and reassociation of DNA with the histone octamers to form nucleosomes. Methylation at the 5 position of cytosine residues by a **DNA methyltransferase** appears to function by loosening up the chromatin structure and allowing DNA access of proteins and enzymes needed for DNA replication. The synthesis of new histones occurs

mainly during the S phase simultaneously with DNA replication. Histone molecules appear to rarely leave the DNA to which they are bound. Instead transcription and replication forks are apparently able to move past the parental nucleosomes as they synthesize mRNA or new DNA. One possibility is that each nucleosome dissociates into two halves, thereby permitting DNA polymerase to replicate transiently uncoiled DNA. Newly synthesized DNA inherits some parental histones, which it combines with an equal amount of new histones to complete the structure of nascent nucleosomes that are formed behind the moving replication forks.

In coordinating the synthesis of DNA the eukaryotic cell copies millions of base pairs, distributed over numerous chromosomes, with remarkable accuracy and at just the right time in the cycle of cell division. Copying starts at hundreds of different origins, some of which are triggered early in the S phase of the cell cycle while others are triggered late. Recent evidence indicates that the replication initiator, that is the ORC complex, does not act alone in controlling initiation. One or more additional proteins bind to the initiation origins late in mitosis and remain attached until the S phase begins. These proteins are known as **cyclin-dependent kinases (CDKs)** and operate in association with specific protein substrates (**cyclins**). Cyclins and CDKs may control the cell cycle; they push the cell to the S phase and initiation of DNA synthesis. Cyclin-CDK pair also prevents DNA synthesis from being initiated a second time, so that only one S phase occurs per cell cycle. Degradation of CDKs removes the signal that inhibits cell division and the cell cycle moves again to mitosis. This scheme suggests that DNA initiation depends upon the formation of a prereplication complex by adding to or removing from the ORC cyclins and CDKs in a cyclical manner. This scheme in which the same enzyme first activates DNA replication and then, once one round of DNA replication has begun, inhibits reformation of the prereplication complex provides an efficient arrangement for the coordination of the initiation of DNA synthesis.

DNA Replication at the End of Linear Chromosomes

Linear chromosomes cannot be fully replicated in the absence of additional steps that provide for the replication of their terminals. As a replisome falls off from the end of a linear chromosome, and the daughter DNA molecules separate, synthesis of DNA on the end of the lagging strand cannot be fully completed. A gap resulting from removal of a primer that was used to start replication is generated on the lagging strand (Figure 15.37). The exact size of this gap

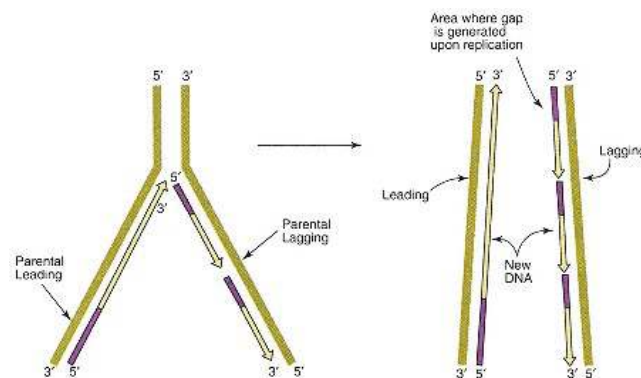

Figure 15.37

DNA replication at the ends of linear chromosomes.

In the absence of a special mechanism of replication operating at the ends of chromosomes, the completion of DNA synthesis of linear dsDNA would leave gaps at ends of newly synthesized strands. These gaps would result from removal of primers used to start replication. Upon each subsequent round of replication the gaps would be continuously expanded and accumulated because DNA polymerase requires a primer and therefore it cannot fill such gaps.

CLINICAL CORRELATION 15.6**Telomerase Activity in Cancer and Aging**

Telomerase activity maintains appropriate length of the telomere sequences of chromosomes. Surprisingly, however, telomerase activity is absent from most somatic cells. In such cells telomere repeats gradually decrease in number with aging, as repeated cell divisions produce a substantial shortening of the telomere structure. Loss of telomerase activity in protozoans, such as *Tetrahymena*, is responsible for a gradual shortening of telomeres following each cell division, throughout the life of the cell. In human cultured fibroblast cells a linear inverse relationship exists between the length of telomeres and the age of the subject from which the cells are obtained. Eventual loss of telomeres leads to chromosomal instability and cell senescence and it may be an important factor that contributes to the process of aging. Specifically, telomere length appears to serve as a mitotic clock that limits the replication potential of mammalian cells. If it is true that the shortening of telomeres may be a contributing factor to the aging process, then the natural life span of an individual may be determined by the length of its telomere DNA. However, the possibility that telomere shortening may be the result, rather than the cause, of aging cannot be excluded. In any event, many other factors are also likely to contribute to the process of aging.

Since telomere length may serve as a mitotic clock, telomerase activity may stimulate cell division. The expression of telomerase may thus provide a selective advantage that allows tumor cells to divide indefinitely. Current understanding of telomere biology is still modest but as it improves telomerase may indeed become an important potential target for cancer chemotherapy.

Allsopp, R. C., Vaziri, H., Patterson, C. et al. Telomere length predicts replicative capacity of human fibroblasts. *Proc. Natl. Acad. Sci. USA* 89:10114, 1992; and Counter, C. M., Hirte, H. W., Bacchetti, S., and Harley, C. B. Telomerase activity in human ovarian carcinoma. *Proc. Natl. Acad. Sci. USA* 91:2900, 1994.

depends on the location of the last Okazaki fragment synthesized. As a minimum, the daughter DNA synthesized would have an 8–12 base gap generated by removal of the RNA primer for the Okazaki fragment. Without intervention this gap would be continuously regenerated and accumulated during each subsequent round of replication because it cannot be filled by DNA polymerase that requires a primer. The products of DNA replication would become shorter relative to parental DNA, leading to the gradual loss of DNA at the ends of human chromosomes. Cell senescence in humans and other mammals may be related to this chromosomal shortening as described in Clin. Corr. 15.6. In human cells that carry information to daughter cells (gamete cells) and in the linear chromosomes of bacteria and viruses, however, the integrity of DNA during replication cannot be compromised. Maintenance of intact chromosomal

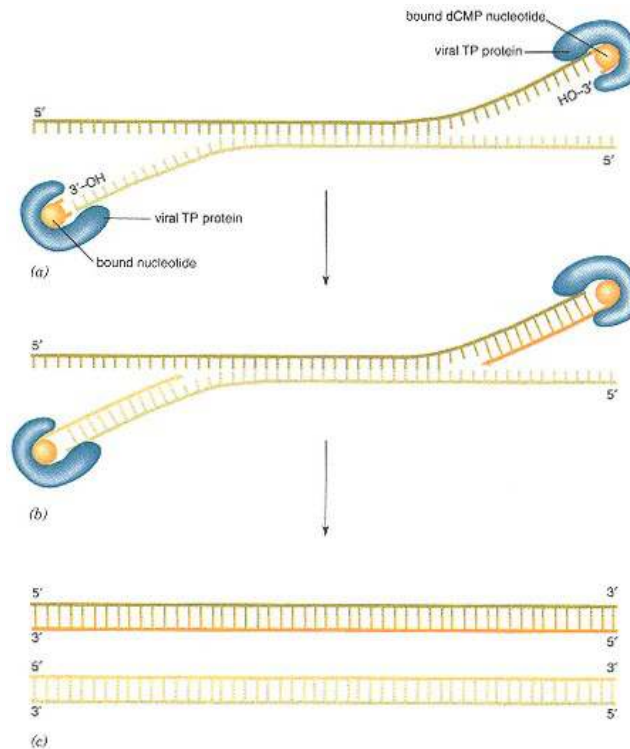
**Figure 15.38****Replication of adenovirus DNA.**

The adenovirus uses a protein as a primer, the terminal protein (TP), for synthesis of both strands of its DNA. TP, covalently associated with one dCMP, binds at the 3' end of each template chain and the dCMP residue provides a 3'-OH for DNA polymerase-catalyzed synthesis of a complementary strand. Since both strands of the viral DNA are synthesized continuously in the 5' → 3' direction, DNA synthesis is complete, leaving no gaps at the ends of the chromosome.

Redrawn based on figure in Wolfe, S. L. *Molecular and Cellular Biology*. Belmont, CA: Wadsworth, 1993.

structure requires a distinct mechanism for replication at the ends of DNA molecules.

Prokaryotic Replication

Different replication strategies have evolved to deal with the problem in viruses, plasmids, and organelle DNA. One approach is the use of a primer consisting of a protein, referred to as **terminal protein, TP**, that binds covalently to the 5' ends of viral DNA molecules via a phosphodiester bond with the hydroxyl group of a serine residue (Figure 15.38). Modified versions of TP that are distinct for different viruses also participate in replication. For instance, in the case of the mammalian adenovirus, the TP contains covalently bound dCMP. In bacteriophage $\phi 29$, the bound nucleotide is dAMP. These nucleotides pair with the terminal nucleotides at the 3' end of each strand and serve as primers for replication. A special polymerase coded by each virus recognizes the TP and copies the strands unidirectionally from their 3' to 5' ends. With the priming limited to the ends of the parental DNA strands, both strands are replicated completely as if they both are leading strands. The TP molecule is cleaved from the primer nucleotide and it is released upon completion of the synthesis. Other viruses form circular intermediates that are copied by a rolling circle mechanism. Finally, some viruses, with identical sequences at the ends of their DNA, can hybridize their terminal sequences, forming linear repeats (linear concatenates). These concatenates are cleaved postreplicatively to generate progeny virus of the proper size (Figure 15.39).

Eukaryotic Replication: Telomerases

Eukaryotes employ different strategies than prokaryotes and viruses for the replication of their chromosomal ends, known as **telomeres**. One approach that is used, albeit rarely, is the lengthening of chromosomal ends by the transposition of DNA segments known as **transposons**. This approach is apparently used for maintaining the chromosome ends in *Drosophila*. In most eukaryotes, however, telomere replication utilizes a specialized **reverse transcriptase enzyme** called **telomerase**. Telomerase activity depends on the presence of an RNA molecule that constitutes part of the telomerase structure and serves as an "internal" template. Maintenance of the chromosomal length depends on the action of telomerase on repetitive DNA sequences that constitute the telomeres of eukaryotic chromosomes (Figure 15.40). These telomeric tandem repeats can be several thousand nucleotides long and they consist of multiple copies of short G- and T-rich oligonucleotide sequences. Their size varies extensively from 20 bp in length for some protozoa to 150 kb in mouse telomers. For humans and other vertebrates the repetitive DNA is constructed with variants of the sequence TTAGGG. A short segment of single-stranded DNA ending in a 3'-OH group caps the end. Telomerase recognizes the G-rich single-strand at the 3' terminus and elongates it in the 5' \rightarrow 3' direction, by adding telomere repeats at the end of the lagging chain. The RNA of telomerase, which has a sequence of about 150 nucleotides complementary to the telomere repeats, provides a movable template that substitutes for the absence of a normal DNA template. Telomerase provides in one package all that is needed for elongation of the strand that ends in a 3' terminus, namely, both template and enzymic activity. Extension of the telomeric sequence elongates the 3' end of DNA by about 100 nucleotides. This is then used as template for synthesis of the complementary strand by DNA polymerase α . Telomerase is then repositioned to repeat the process as illustrated in Figure 15.40. In this manner telomerase and polymerase α serve to maintain chromosomal length during repeated rounds of DNA replication. Maintenance is affected by such factors as telomerase processivity and its frequency of action on telomers as well as the rate of degradation of telomeric DNA. Telomeres may grow, shrink, or stay fairly stable depending

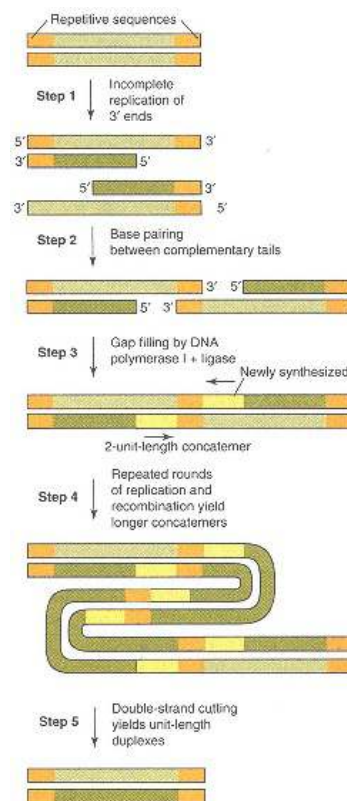

Figure 15.39

Replication of bacteriophage T7 DNA.

Bacteriophage T7 DNA has repetitive identical sequences at its chromosomal termini so that, following replication, the daughter molecules can hybridize end to end to form dimers. During subsequent rounds of replication the process is repeated until a large linear DNA, a concatemer, is formed. A specific nuclease then cleaves the large concatemer into fully replicated genome-size DNA segments.

Redrawn based on figure in Mathews, C. K. and Van Holde, K. E. *Biochemistry*. Redwood City, CA: Benjamin/Cummings, 1990.

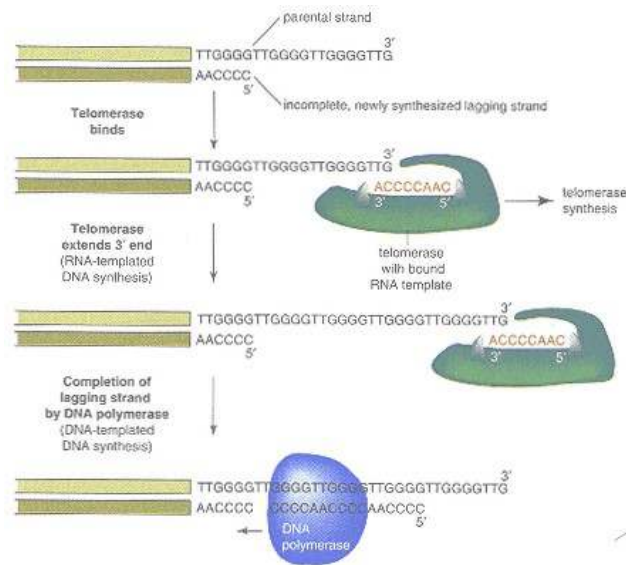

Figure 15.40
Telomere replication.

Telomerase contains an RNA template that codes for the extension of the ends of chromosomes and serves as a template for DNA polymerase. The DNA strand made on the lagging side of a replication fork of a linear chromosome is incomplete. For this strand to be completed, telomerase extends the 3' end on the complementary strand at the leading side of the fork. Telomerase first binds to a TG primer at the 3' end of this DNA strand. Binding is the result of base pairing between primer and RNA template that is part of the telomerase complex. The enzyme adds more T and G residues to the primer and repositions the RNA template so that more TG repeats can be added to the end of the primer. The extended primer is eventually recognized by DNA polymerase α , which proceeds to replicate the 5' end of the DNA using the single-stranded 3' end as template. Primase activity is vested in a subunit of DNA polymerase α .

Redrawn based on figure in Alberts, B., Bray, D., Lewis, J., Raff, M., Roberts, K., and Watson, J. D. *Molecular Biology of the Cell*. New York: Garland, 1994.

on genetic or nutritional changes. For example, the size of yeast telomeres can vary from about 200 to 400 bp depending on conditions.

DNA Can Be Synthesized Using an RNA Template

For many years it had been assumed without reservation that the only direction in which genetic information can flow is from DNA to RNA. This dogma had to be revised, however, when it was discovered that the genomes of certain viruses, such as the **retroviruses**, consist of RNA instead of DNA and that during viral infection this genomic RNA is copied into DNA. The DNA that is obtained can either be transcribed to produce more viruses or it may be incorporated into the DNA of the host. In the latter case the viral genome is replicated along the DNA of the host and often remains latent for many host chromosome generations.

Enzymes that use RNA templates for DNA synthesis are called **reverse transcriptases**. Reverse transcriptases are often virally encoded but they are not limited to viruses. Enzymes with reverse transcriptase activities are also found in uninfected cells and are involved in the formation of pseudogenes and in the replication of transposable elements (see p. 669). Reverse transcriptases are the most error-prone type of DNA polymerases because they lack 3' \rightarrow 5' exonuclease activities, thus lacking a proofreading function. Inhibitors of reverse transcriptase are used for the treatment of AIDS as described in Clin. Corr. 15.7.

DNA Replication, Repair, and Transcription Are Closely Coordinated

It has become increasingly clear that DNA replication, transcription, and repair are not separable, as most DNA lesions block both replication and transcription. Thus repair occurs with "expressed genes" as a priority, with the repair of dormant genes deferred. In addition, transcription and repair appear to cross paths at several points, with certain repair proteins participating in the activation

CLINICAL CORRELATION 15.7**Inhibitors of Reverse Transcriptase in Treatment of AIDS**

AIDS is caused by a retrovirus, the human immunodeficiency virus (HIV). Treatment of AIDS is complicated by the high mutability of this virus, which reflects the low fidelity of the HIV reverse transcriptase responsible for the synthesis of the viral genome. This transcriptase is about one order of magnitude less accurate than other transcriptases and produces one or more mutations per generation, which means that any two HIV DNA molecules are almost never exactly the same in their nucleotide sequence.

The first drug that was used with some success, and continues in use, in controlling the rate of advancement of the disease is a structural analog of deoxythymidine, known as AZT.

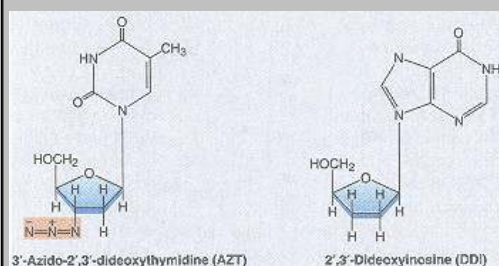

This drug is converted to the triphosphate by cell kinases and the triphosphate is incorporated into the HIV genome in place of dTTP. AZT triphosphate competes successfully with dTTP for incorporation into the viral genome because of the higher binding affinity of AZT relative to dTTP toward the HIV reverse transcriptase. Since AZT has a lower affinity for cellular DNA polymerases than dTTP, it is not incorporated into cellular DNA. Incorporation of AZT triphosphate causes a premature termination of viral DNA synthesis because it lacks a 3'-OH site that is needed as the primer for incorporation of additional nucleotides.

Other nucleotide analogs, with similar reverse transcriptase-dependent mechanisms of actions, have been included in the treatment of AIDS. These include dideoxyinosine (ddI), dideoxycytidine (ddC), and azidothymidine (ZDV). Current approaches use ZDV or combination therapies of ZDV and ddI or ZDV and ddC. Other compounds that are not nucleotide analogs, referred to as nonnucleoside reverse transcriptase inhibitors (NNRTI), and a diverse group of other agents, such as protease inhibitors and HIV immune-based therapies, are currently under investigation for treatment of AIDS. A new class of drugs that inhibit proteases essential for HIV replication, when used in combination with reverse transcriptase inhibitors, is reported to reduce viral loads in AIDS patients to undetectable levels and in many instances reverse rather than simply arrest the symptoms of the disease.

Finkelstein, D. M., and Shoenfeld, D. A. (Eds.). *AIDS Clinical Trials*. New York: Wiley-Liss, 1995.

of initiation or elongation steps of transcription. For example, subunits of the TFIIH factor, which is essential for transcription, also participate in eukaryotic nucleotide excision repair. Repair and replication appear also to be coupled at the level of the protein factor, HSSB. This protein binds single-stranded DNA with high affinity during replication but it is also a repair protein required for the formation of the preincision complex. A protein induced as a result of DNA damage, the so-called Gadd45 protein, has regulatory effects on both DNA repair and replication. Gadd45 appears to both stimulate excision repair and inhibit DNA replication.

15.5—**DNA Recombination**

DNA recombination refers to a number of distinct processes during which genetic material is rearranged by breaking and joining portions of the same DNA molecule or portions of different DNA molecules. Recombination also takes place between the DNAs of different organisms to generate a new "composite" DNA. Both prokaryotic and eukaryotic DNAs undergo recombination. Three well-characterized processes listed in Table 15.8 fall under this general description of genetic recombination. Other DNA rearrangements have been noted whose mechanism and function are not well-understood and are referred to as illegitimate; these will not be reviewed in this chapter. Recombination creates new combinations of genes on the chromosome, which increase the chance of survival of a population. This increase of **genetic diversity** offers no advantage for individuals within a population. Individual survival partially

TABLE 15.8 Characteristics of Different Types of Genetic Recombination

<i>Type</i>	<i>Sequence Homology</i>	<i>Heteroduplex Sequences</i>	<i>Proteins Involved</i>	<i>DNA Synthesis</i>
Homologous	Extensive, but the homology is DNA sequence independent	Long	RecA, RecBCD, RuvAB, RuvC, and DNA repair enzymes ^a	Some
Site-specific	Short but specific DNA sequences are required on both DNAs	Short	Recombinases	Some
Transpositional	Homology is not required; specific sequences needed on one of the DNAs	None	Transposases	Minor (only to fill gaps)

^a Several additional protein factors including RecE (exonuclease VIII), RecF, RecG, RecJ, RecN, RecOR, RecQ, RecT, SbcCD, DNA polymerase I, DNA gyrase, DNA topoisomerase I, DNA ligase, and DNA helicases participate in catalyzing homologous recombination.

depends, instead, on the operation of DNA repair. However, certain types of DNA repair depend on DNA recombination and therefore it is possible that recombination evolved as a mechanism of repair.

Homologous genetic recombination produces an exchange between a pair of distinct DNA molecules, often two slightly variant copies of the same chromosome, or two segments of DNA generated from the same DNA molecule. The main requirement for this process to occur is that the recombining DNAs are **homologous**. This means that the two DNAs share very similar base sequences over an extended region that may contain several thousand bases. An important example of homologous recombination in eukaryotes is the exchange of sections of homologous chromosomes during the early development of gametes (egg and sperm cells). In this manner slightly different versions of the same gene (alleles) can evolve during meiosis. Gene "mixing and reassortment" by general recombination is also widespread in bacteria. Homologous recombination is quite complex and involves a multistep mechanism catalyzed by a large number of different proteins. Prominent among them is the RecA protein, which also participates in SOS DNA repair.

Conservative site-specific recombination or **site-specific recombination** requires the presence of only short homologous DNA sequences. However, site-specific recombinations occur only in specific DNA sequences present in both the participating DNA molecules. The process is catalyzed by enzymes known as **recombinases**.

Transpositional site-specific recombination, or simply **transposition**, differs from conservative site-specific recombination in that it does not require a specific DNA sequence in the "target" chromosome. Transposition is catalyzed by **transposases**. Both transposases and recombinases recognize and act on specific DNA sequences. Recombination of either type is responsible for the insertion of viruses, plasmids, and **transposable elements (transposons)** into chromosomal DNA. Transposons are DNA elements that can move from location to location within a genome, in both bacteria and eukaryotes. Viruses are related to plasmids and transposons but also differ from these genetic elements in that viruses can synthesize a protein coat that allows them more host-independent existence. Plasmids and transposons are confined to replicate only within a specific cell and the progeny of that cell.

The most common recombination is the **homologous** type. **Site-specific recombination** and **transposition** are relatively rare, but important, events in that they may control replicative function in some viruses and certain aspects of development. Homologous recombination generates new combinations of genes that can lead to genetic diversity. DNA mutation and recombination are

the two principal approaches by which the cell creates variation that is required for evolution to occur. In addition, recombination events are involved in DNA repair. In those instances in which DNA damage occurs across complementary DNA sites, DNA repair can occur only through recombination. A large variety of protein structures used by the human immune system are produced by recombination as described in Clin. Corr. 15.8.

Homologous Recombination

Homologous recombination, which is accompanied by the formation of a **heteroduplex DNA** region, clearly requires breaking and rejoining of chromosomal DNA. Recombination occurs via a fairly complex multistep mechanism. A scheme that explains the outcome of recombination is shown in Figure 15.41. This scheme gives a minimal overview of recombination, in that each of the steps shown may represent more than one enzymatically catalyzed process. Numerous gene products are involved in homologous recombination.

Recombination may begin by introduction of a single-strand nick at a selected site of one of the DNA duplexes undergoing recombination. The resulting 3'-ended single-strand tail can then invade a homologous DNA duplex. Homologous DNA duplexes are chromosomes with the same linear arrangement of genes but with base sequences that may differ between the two duplexes. The variance is usually minor and may consist of no more than one different base among the millions of base pairs present in the chromosome. Single-strand invasion places the homologous DNA duplexes side by side in a process referred to as **synapsis**. Synapsis does not necessarily involve contacts between homologous sequences and further movement of the DNAs with respect to each other may be necessary until homologous sequences come into contact. This process is referred to as **homologous alignment**. **Strand invasion** is accompanied by **strand displacement** in the homologous DNA duplex resulting in the formation of a so-called **D-loop**. The "D-loop" strand that has been displaced by strand invasion is now nicked and it pairs with its complementary strand in the original duplex. The ends of exchanged strands are then ligated to form a stable **cross-stranded intermediate** known as **Holliday junction**. The junction can migrate in either direction by unwinding and rewinding of the two

CLINICAL CORRELATION 15.8

Immunoglobulin Genes Are Assembled by Recombination

Immunoglobulins (antibodies) are molecules that recognize and specifically bind to any substance that antibodies identify as foreign to the human body (see p. 88 for details). Because of the immense variety of infectious agents, including millions of microorganisms that are present in the environment, the human genome, which is equipped with only a limited pool of probably no more than 100,000 genes, does not have the capacity to directly produce an equivalent number of different antibodies necessary for specific recognition of all infectious agents. This inherent limitation in the gene-coding potential of the human genome is, however, overcome by recombination, which allows production, from a limited amount of gene-coding DNA, of an almost unlimited number of distinct antibodies.

Human immunoglobulins consist of two heavy and two light chains with each chain having a variable region, with a sequence that is characteristic for each immunoglobulin, and a chain with constant amino acid sequence (see p. 89). Recombination leads to diversity in the variable region of immunoglobulins. During the maturation of a bone marrow stem cell into a B lymphocyte, one V segment and one J segment are brought together by site-specific recombination. In the process the intervening DNA is deleted and a joint between the two regions is established by an RNA-splicing reaction that occurs following transcription. Since the V region consists of 300 segments and the J region of 4, at least 1200 different combinations can be generated by recombination.

Similar considerations apply to the light chains and the heavy chains, with the latter being assembled in as many as 5000 distinct combinations. Because individual light and individual heavy chains can subsequently be assembled in combination, at least 6×10^6 different IgG molecules can be produced. Furthermore, because some variations occur in the exact location of the V-J junction, the actual number of IgG molecules is two to three times higher than estimated above. Additional IgG diversity is produced during the process of maturation of B lymphocytes by mutational processes.

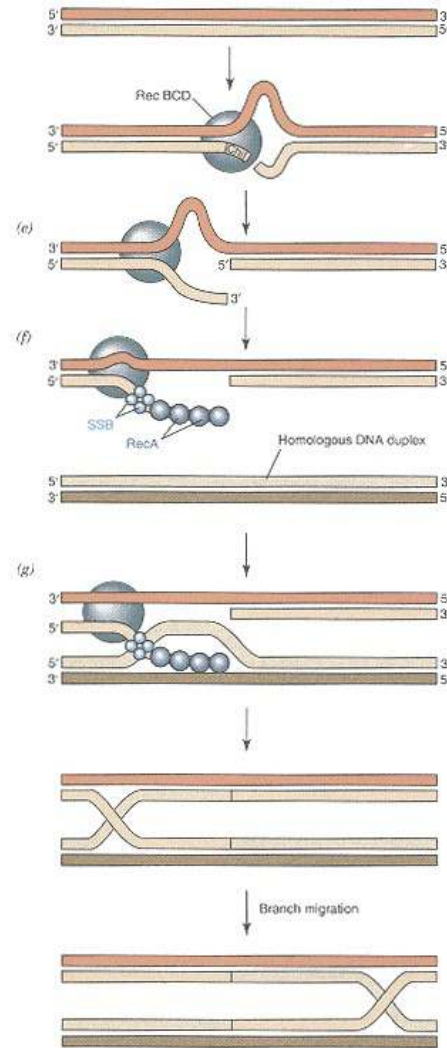

Figure 15.41

Overview of homologous recombination.

Transformations that can lead to formation of recombinant and nonre-combinant heteroduplexes, by participation of two homologous DNA molecules in homologous recombination are outlined. Each step indicated need not be the outcome of a single, enzymatically catalyzed or well-understood reaction. The sequence of steps shown is not necessarily universally applicable.

duplexes to produce a further exchange of single strands between interacting chromosomes. This process, known as **branch migration**, results in strand exchange and it produces **heteroduplex** regions of varying lengths. The resulting heteroduplex, shown in Figure 15.41, can also be presented in another form that is generated by merely pulling the ends of the heteroduplex together (Figure 15.42). A twist of this structure produces an isomeric heteroduplex, which is called the **Chi** form. In order to resolve the Chi form two additional single-strand nicks can be made, in either the horizontal direction or vertical

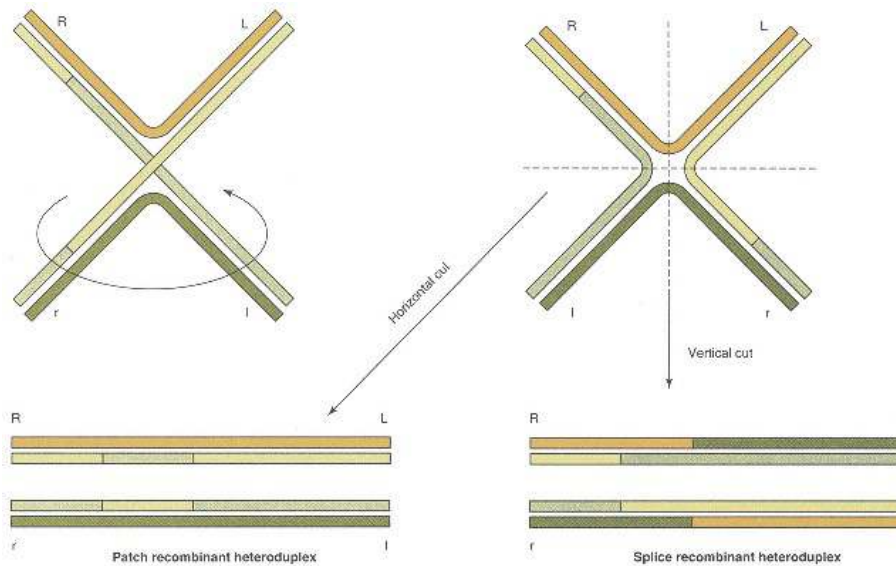

Figure 15.42
Patch and splice recombinant heteroduplexes.

direction, leading to two distinct products. Gaps present in these structures are repaired and ligated, leading to either one of the two products. The manner in which nicks are introduced in the horizontal and vertical directions is fundamentally different. In one case (horizontal direction) nicks are introduced again into the strands that were initially nicked, although at different sites, producing two duplexes in which one strand of each remains intact. These duplexes contain heteroduplex regions, generated by branch migration, that are misleadingly referred to as **Patch recombinant heteroduplexes**. These duplexes contain the same genes and in the same linear order as the initial duplexes. In vertical direction nicks, the complementary strands that previously were left intact are nicked again (though at different sites), producing two duplexes of true recombinant DNA, referred to as **splice recombinant heteroduplexes**. In these true recombinant heteroduplexes the linear order of DNA sequences contained in the original duplexes is clearly rearranged.

Support for this multistep recombination scheme has accumulated over the years based on genetic investigations, on electron microscopy of Holliday junctions, and by isolation of proteins and enzymes that can catalyze many of the transformations described in this recombination scheme.

Enzymes and Proteins That Catalyze Homologous Recombination

Homologous recombination in *E. coli* requires about 25 enzymes for recombination. A partial list includes **RecA** protein, **RecBCD** enzyme (which is the product of three distinct *E. coli* genes, *recB*, *recC*, and *recD*), **RuvAB** and **RuvC** proteins, DNA polymerase I, DNA gyrase, DNA topoisomerase I, DNA ligase, and DNA helicases (Table 15.8). Proteins homologous to RecA have also been isolated from yeast and human cells.

Homologous recombination in *E. coli* begins with RecBCD, which is a site-specific **endonuclease** and an ATP-dependent **helicase** (Figure 15.43).

RecBCD can initiate recombination by unwinding DNA and, on occasion, cleaving one strand. The enzyme binds to one end of linear DNA and travels along the helix at the expense of ATP, unwinding DNA as it moves and rewinding DNA behind it at a slower rate than unwinding. This produces a "bubble" consisting of two single-stranded loops that propagate on the DNA with the advance of the RecBCD. *Escherichia coli* DNA is characterized by the presence of about 1000 copies of the sequence 5'-GGTGGTGG-3' that, on average, occurs at intervals of 4–5 kb. These Chi sites are "**hot spots**" for recombination as they increase the frequency of recombination. When the advancing RecBCD encounters a Chi site within a "bubble," it cleaves the DNA strand that incorporates the 5'-GGTGGTGG-3' sequences 5–6 nucleotides to the 3' side of the Chi site. The helicase activity generates a 3' single-stranded tail of DNA that is progressively lengthened to several kilobases.

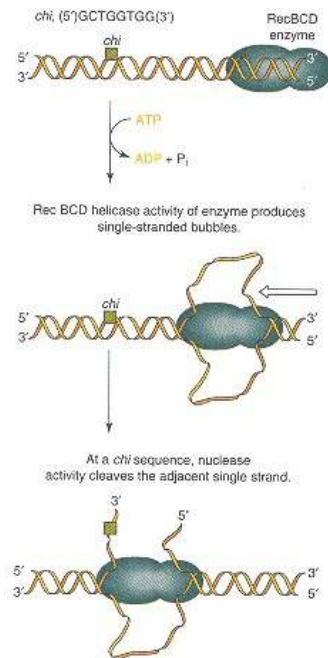

Figure 15.43

Activities of RecBCD protein.

RecBCD combines helicase and nuclease activities and appears to be involved in initiation of homologous genetic recombination in *E. coli*. RecBCD, using its helicase activity, enters the double helix and, using energy derived from ATP hydrolysis, travels along the helix until it encounters a Chi site, which consists of the sequence 5'-GCTGGTGG-3'. RecBCD introduces a cut, within the Chi site, that leads to displacement of a 3'-terminating single strand. This single strand initiates recombination by pairing with a homologous DNA double helix.

Redrawn based on figure in Liehninger, A. L., Nelson D. L., and Cox, M. M. *Principles of Biochemistry*. New York: Worth, 1993.

This growing single-stranded tail can then initiate the **strand invasion** process with the assistance of RecA, which catalyzes a multiplicity of reactions in DNA recombination (Figure 15.41). RecA interacts with single-stranded (ss) and double-stranded (ds) DNA and catalyzes **pairing of homologous DNA sequences**, **invasion of ssDNA** into the homologous double helix, formation of the **Holliday junction**, and migration of this junction (branch migration). These activities of RecA depend on the presence of a RecA site that recognizes ssDNA and promotes the cooperative binding of the protein to ssDNA. Formation of a long and relatively stiff **nucleofilament** (Figure 15.44) prevents the

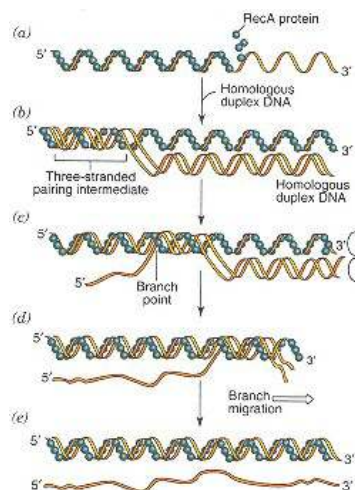

Figure 15.44

DNA strand exchange mediated by RecA.

Replacement of a complementary strand in a DNA duplex by a single-stranded DNA is catalyzed by RecA. RecA begins the exchange by coating both ssDNA and dsDNA by RecA (only coating of the single strand is shown). The coating modifies the conformation of both the single-stranded and double-stranded polynucleotides and catalyzes the invasion of the single-stranded intermediate. Switches in the base pairing between the strands, and the accompanying rotation of the DNA, move the three-stranded region from left to right as one strand of the DNA duplex is displaced by the identical, or nearly identical, invading ssDNA. Continuing branch migration leads to eventual separation of the displaced strand.

ssDNA tail from reassociating with the complementary strand within the DNA duplex, from which it originated, and prepares the single strand for invasion. In the resulting nucleofilament that binds one RecA molecule per 3 bases, the polynucleotide is positioned within a deep groove of the RecA protein. A second site on RecA recognizes and binds preferentially to dsDNA. In this nucleofilament each RecA monomer covers six nucleotides and each successive monomer binds to the opposite site of the DNA helix. For the sake of simplicity the dsDNA in Figure 15.44 is shown as free from RecA. The RecA–ssDNA and RecA–dsDNA nucleofilaments differ in their geometry from B-DNA, but both filaments represent partially unwound and unstaked helical structures that are extended lengthwise by 50% relative to B-DNA. DNA unwinding in the RecA–dsDNA nucleofilament (to about 18.6 bp per turn) exposes H-bond donors and acceptors in the major groove of the double helix, making them available for interaction with the ssDNA–RecA filament. Thus RecA contributes to the recognition of regions of homology between DNA strands. Once **homologous alignment** is established, a fairly stable **triple-stranded intermediate** can be formed (Figure 15.45). In this structure the third strand is in contact with the major groove of the duplex, aligned in a manner that permits RecA to flip the base pairing of the two identical strands.

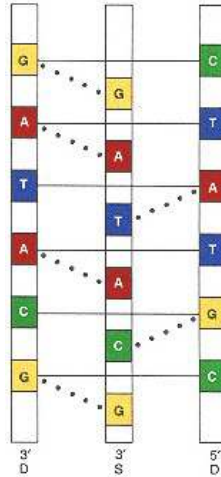

Figure 15.45
Model for the triple-stranded intermediate formed during DNA recombination.

RecA catalyzes the formation of a triple-stranded DNA intermediate as a result of the association of a dsDNA, the strands of which are marked D, and an invading ssDNA, marked S (shown in the middle).

Both dsDNA and ssDNA are present in the form of complexes with RecA. This protein catalyzes unwinding of the strands of the double helix and makes the matrix of hydrogen-bond donors and acceptors in the major groove of the double helix available for pairing with ssDNA. The ssDNA is also unwound by RecA, providing for proper alignment between dsDNA and ssDNA.

The flipping of the base pairing and the resulting invasion of the RecA–ssDNA filament involve the exchange of two identical (or nearly identical) strands between helical structures, which therefore requires an ordered rotation of two aligned strands. The polynucleotides are prepared for this exchange by "the extended" conformation generated by RecA. Strand exchange can be extended by **branch migration**, which means that progression of the exchange requires both invasion and branch migration. Branch migration may be described as a process in which an unpaired region of a single DNA strand displaces a DNA strand from a region of homologous dsDNA and moves the branching point, without appreciably increasing the total number of disrupted base pairs. Migration is achieved by RecA-catalyzed rotation of RecA-bound DNA strands involved in the exchange (Figure 15.44). The resulting "spooling" action, in which topoisomerases may be involved, moves the branch as ATP is hydrolyzed.

Branch migration also occurs at the Holliday junction that is subsequently formed. In this intermediate homologous DNA helices that were initially paired are held together by mutual exchange of two of the four strands (Figure 15.46). Stereochemistry of the intermediate is determined by the juxtaposition of the grooves and the phosphate backbones of the participating helices, and the point of exchange or actual junction can be moved back and forth along the helices. Migration of the junction can proceed in the absence of RecA. This RecA-independent migration of the junction is catalyzed by a complex of **RuvA** and **RuvB**. RuvA binds to the junction and acts as a specificity factor that targets RuvB, which is an ATPase, to the junction. The RuvAB complex promotes migration and increases the length of the heteroduplex DNA at the expense of ATP. Finally, the Holliday junction is recognized and resolved into products by the **RuvC endonuclease**, a dimer of 19-kDa subunits related to each other by a dyad axis of symmetry. The catalytic center of this **resolvase** lies at the bottom of a cleft that fits a DNA duplex. Only strands with the same polarity are cleaved and produce two types of heteroduplex molecules, one type in which only single-strand segments are exchanged (**patch recombinants**) and another type, a true recombinant, in which the ends of molecules have been exchanged (**splice recombinants**). Resolution is completed by DNA polymerase I, DNA topoisomerase I, DNA gyrase, and DNA ligase.

RecA also exhibits a highly specific protease activity that is activated by unpaired DNA strands and is directed at specific regulatory proteins. Thus RecA has unique properties for coordinating regulation of a number of cellular

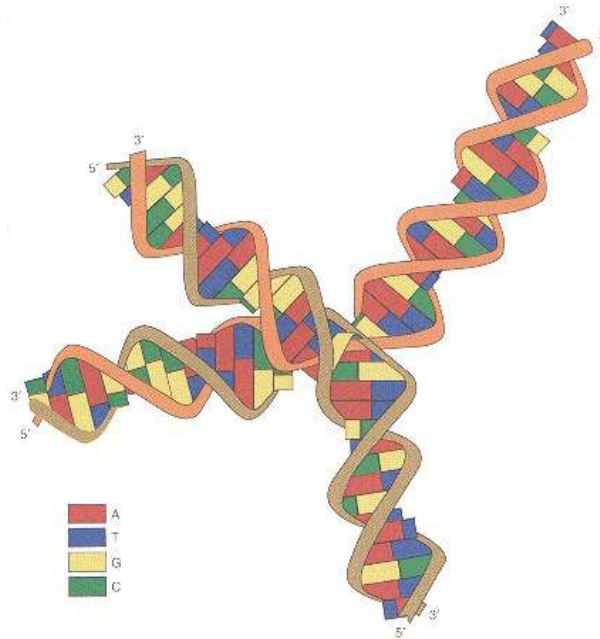

Figure 15.46

Structure of the Holliday junction.

The Holliday intermediate is a four-way junction that adopts a right-handed antiparallel X-shaped structure by pairwise coaxial stacking of the two double helices. The junction consists of fully stacked base pairs with the participating strands present as hydrogen-bonded DNA duplexes.

Redrawn based on figure in Moran, L. A., Scrimgeour, K. G., Horton, H. R., Ochs, R. S., and Rawn, J. D. *Biochemistry*. Englewood Cliffs, NJ: Neil Patterson/Prentice Hall, 1994.

functions that occur when DNA damage, or the interruption of DNA replication, leads to the production of ssDNA segments. An example is the postreplication repair of DNA damaged by UV light or other mutagens.

Site-Specific Recombination

This process separates and joins dsDNA molecules at specific sites. Site-specific recombination is limited to select regions of a genome and is driven by **recombinases** that recognize short (20–200 bp) specific sequences on both recombination sites. When recombinase binds to both recombination sites on DNA molecules it can produce an insertion of DNA. A well-studied example is provided by the integration of so-called temperate phages, such as *E. coli* bacteriophage λ , into the host chromosome of the corresponding host (Figure 15.47). The circular chromosome becomes integrated into a specific site in the *E. coli* chromosome consisting of about 20 nucleotides, the so-called attP site. Integration requires the alignment of the phage in a specific orientation with the *E. coli* chromosome. The alignment is achieved by a specific recombinase known as **integrase (Int)** and the participation of a protein known as the **integration host factor (IHF)** encoded by the bacterium. Integrase brings together the attB site of the bacterium with a corresponding specific site on the phage chromosome, which consists of 230 bp and is known as the attP site. Int generates a precise wrapping of DNA to juxtapose specific nucleotide sequences for the splicing reactions that follow. Functioning as a topoisomerase, Int unwinds the attP region and forms an Int–attP nucleoprotein. A corresponding nucleoprotein is also formed between Int and attB that brings the attP and attB

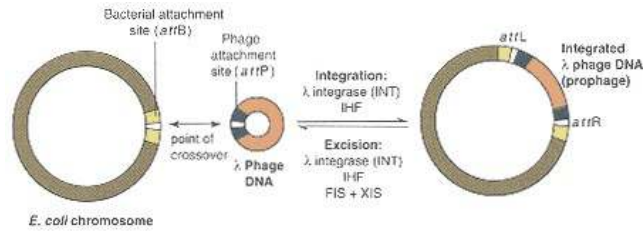

Figure 15.47

Site-specific recombination of λ phage.

Site-specific recombination is carried out by integrase. The phage chromosome undergoes recombination between the *attP* site and a corresponding site on the bacterium, *attB*. Integration of the phage chromosome generates two new attachment sites (*attR* and *attL*) that flank the integrated phage DNA. The reverse reaction, excision of the integrated phage chromosome, requires the participation of protein XIS produced by the bacteriophage and protein FIS encoded by the bacterium.

sites together. Integrase then generates a staggered cut, 7 base pairs apart within a core sequence of 15 bp, that is present in both the *attP* and *attB* sites and catalyzes the exchange of strands at the position of the cut to form a **Holliday intermediate**. To complete the exchange, cutting and rejoining must be repeated at a second point within each of the two recombination sites. Normally, limited branch migration is required prior to an *Int*-catalyzed second cleavage and strand exchange. Following ligation by *Int*, the original sequence of the recombination site is regenerated but the DNA on either side of the site is recombined. **Recombinases** often act in a reversible manner, restoring the sequences of original DNAs. **Integrase** also acts in a reversible manner so that the circular phage chromosome can be excised as conditions change. The forward and reverse steps of the integration reaction are separately regulated, with the reverse step being dependent on the presence of additional proteins: the XIS protein encoded by the phage and FIS encoded by the bacterium. Both reactions also require IHF.

Transposition

Transposition is a form of recombination catalyzed by recombinases called **transposases**. This type of recombination is best understood in bacteria but DNA of all cells, including eukaryotes such as *Drosophila*, maize, and yeast, contains segments that can move, generally with very low frequencies of 10^{-5} – 10^{-7} per cell generation, from a **donor** site to another **target** site within a chromosome. These segments are known as **transposable elements (transposons)**.

Transposition differs from homologous recombination in not requiring sequence homology between donor and target sites. Only the donor site, that is, the transposon, has specific nucleotide sequences located on both sides of the transposon that serve as binding sites for transposases. Most bacterial transposons have short repeats of about 15–25 bp at the two ends of the transposable DNA segment. In contrast, the target sites are not well defined and are not characterized by specific DNA sequences. **Heteroduplex** joints are not formed as a result of transposition.

Three classes, I, II, and III, of transposable elements are recognized. Class I transposons are called **insertion sequences (IS)** if they consist of a gene

CLINICAL CORRELATION 15.9**Transposons and Development of Antibiotic Resistance**

Genes conferring to bacteria resistance to commonly used antibiotics such as penicillin or tetracycline are usually carried on plasmids. The DNA sequences of these plasmids do not have any homology with the chromosomal DNA sequences of the host. Yet, as a result of transposition, antibiotic resistance genes can be transferred to the chromosome of bacterial hosts. The existence of genes that can move from one chromosome to another is of course of great importance in understanding the factors that produce changes in the organization of genomes. From the clinical standpoint these "transposable" genes are of critical significance for understanding how populations of antibiotic-resistant bacteria arise with use of antibiotics in the treatment of bacterial infections in humans and animals.

coding for transposase together, of course, with the repeats that normally flank the transposable element. IS elements vary in size between 800 and 1300 bp. When Class I transposons also contain an additional gene, such as a gene conferring antibiotic resistance to bacteria, they are called **composite transposons (Tn)**. Class II transposons differ from Class I in that, in addition, they code for the gene of a second enzyme, **resolvase**. Typically, **composite transposons** and Class II transposons are several thousand base pairs long. Finally, a small group of bacteriophages, such as bacteriophage Mu, that insert their chromosome into a host chromosome are classified as Class III transposable elements.

Transposition begins by a transposase-catalyzed introduction of a staggered cut at the target DNA sequence. Cuts are also made on each side of the transposon so that it can be moved onto the target site. The relocation leaves a double-stranded break at the site from which the transposon is excised. At the target site the transposon is spliced into the staggered cut as shown in Figure 15.48. Specifically, 3–12 bp at the target site are duplicated by DNA polymerase I, to form an additional short repeat at each end of the inserted transposon, and the "tailored" transposon then is ligated within the target site. In Class II and III transposition, in addition to duplication of the short repeats, the transposon itself is replicated and one copy of it remains at the donor site while the other copy is transferred to the target site. This type of transposition, referred to as **replicative transposition**, requires the enzyme resolvase and therefore does not occur in Class I transposition. Replicative transposition can reshape the structure of a chromosome beyond the simple act of relocating a transportable element from one site to another. Because this type of transposition places two homologous sequences within the same chromosome, homologous recombination between these two sequences can produce either a deletion or an insertion, depending on whether these sequences are oriented in the same or in opposite directions, as shown in Figure 15.49.

Finally, transposition may inactivate a gene by mutation if a transposon is inserted into a coding sequence and interrupts it. Alternatively, insertion by transposition of a promoter or a transcriptional activator next to a gene may activate the gene. Clinical Correlation 15.9 reviews the role of transposition and Clin. Corr. 15.10 the role of DNA amplification in the development of drug resistance.

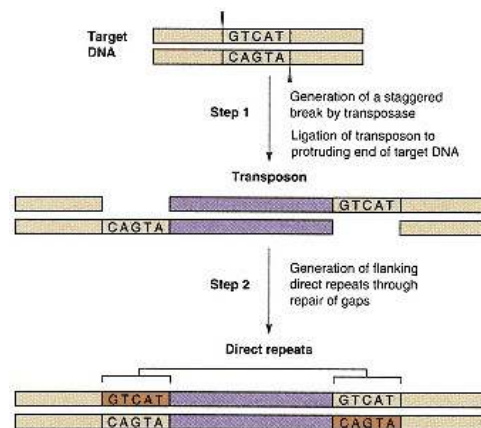
**Figure 15.48****Direct repeats at the ends of transposons.**

Transposons are inserted into gaps generated at a target sequence by introduction of a staggered cut by a transposase. Ligation of transposon to the protruding ends of target DNA leaves gaps at both sides of the transposon. Repair of these gaps is responsible for the presence of direct repeats that flank transposons.

Redrawn based on figure from Mathews, C. K. and Van Holde, K. E. *Biochemistry*. Redwood City, CA: Benjamin/Cummings, 1990.

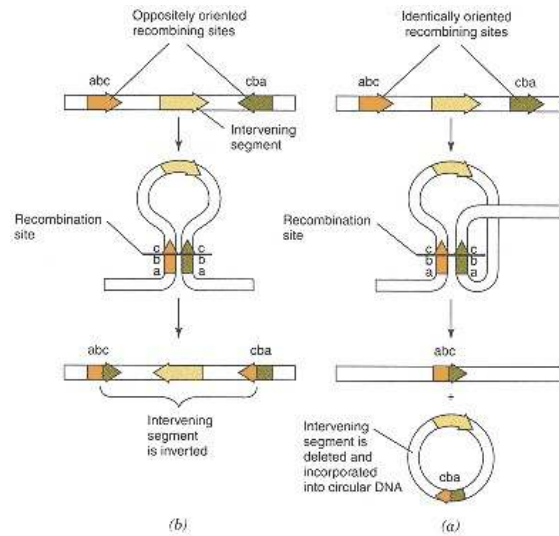

Figure 15.49

Genomic rearrangements promoted by transposons.

In replicative transposition a transposable element is replicated, with one copy of it remaining at the donor site and a new copy becoming inserted within a different location. This produces two homologous sequences within the same chromosome that can subsequently enter into homologous recombination.

- (a) When these homologous sequences are of the same polarity, recombination can yield a deletion of DNA by a process that is superficially analogous, but certainly not similar, to the reverse reaction occurring in site-specific recombination.
- (b) Inversion of DNA flanked by these transposons can result when transposable elements are present in the chromosome oriented in opposite direction.

Redrawn based on figure from Mathews, C. K. and Van Holde, K. E. *Biochemistry*. Redwood City, CA: Benjamin/Cummings, 1990.

15.6—

Sequencing of Nucleotides in DNA

Restriction Maps Give the Sequence of Segments of DNA

The sequences of many genes and adjoining DNA segments have been determined for bacteria, viruses, plants, and humans. The determination of the sequence of a large DNA molecule begins by cutting the DNA into pieces of a more manageable size with appropriate restriction endonucleases. **Restriction digests** permit the construction of a characteristic **restriction map** for each DNA. One protocol depends on the generation of partial restriction digests of end-labeled DNA. Partial digests are obtained by setting the conditions so that

CLINICAL CORRELATION 15.10

DNA Amplification and Development of Drug Resistance

An important limitation in the effectiveness of chemotoxic drugs in the treatment of cancer is the development of drug resistance. Thus cancer cells become resistant to methotrexate (see p. 520), an inhibitor of dihydrofolate reductase (DHFR). Drug resistance in cultured cells results from the specific amplification of a large DNA segment that incorporates the *DHFR* gene but the exact mechanism by which amplification occurs is not clear. It appears likely that amplification results from recombination of identically oriented homologous sequences that flank the amplified DNA. Amplification can occur by tandem duplication of DNA that contains the *DHFR* gene or alternatively the *DHFR*-containing segment can be excised (apparently by a recombination process), producing extrachromosomal DNA (minichromosomes). The two mechanisms of *DHFR* gene amplification are not mutually exclusive and, in fact, some resistant cells contain both types of amplified DNA.

Gene amplification is gradually reversed in the absence of methotrexate, first with the disappearance of the extrachromosomal copies. Chromosomally amplified genes, however, persist for several generations after removal of the drug. The amplification of genes is a general phenomenon not limited to methotrexate or the development of cell resistance toward other drugs. In fact, gene amplification and the accompanying resistance extend to areas well beyond clinical medicine, as, for instance, in agriculture with the development of pesticide-resistant insects.

CLINICAL CORRELATION 15.11**Nucleotide Sequence of the Human Genome**

The purpose of the Human Genome Project is to provide a detailed map of the human genome and establish what DNA sequences determine human phenotypic characteristics and guide human development. A corollary to this goal is to identify genes responsible for human disease so that new approaches can be developed for diagnosis, prevention, and therapy.

The human genome is believed to consist of 70,000–100,000 different genes that determine the genetic characteristics of every cell in the human individual. The human genome consists of about three billion base-paired nucleotides that are assembled in the form of 23 pairs of chromosomes. The availability of restriction endonucleases and the development of effective physical mapping procedures for DNA, combined with the increasing rapidity of contemporary nucleotide sequencing methods, have provided strong impetus for the very ambitious undertaking of determining the nucleotide sequence of the entire human genome.

Extensive physical mapping has been completed. In addition, genetic mapping seeks to locate over 500 known genetic markers on the human chromosomes. Cumulatively over 150 million base pair sequences, representing parts of the chromosome sequences of both human DNA and that of other organisms, have been determined. Also, the sequences of certain continuous stretches of DNA, ranging from one million to several million base pairs in length, are being determined. Considering that the size of different human chromosomes varies from 263 million to less than 50 million base pairs, the determination to date of a total of about 150 million base pairs represents an important accomplishment. It is conservatively estimated that complete sequencing of the genome will take more than a decade and a half.

Because of the routine nature of determining the nucleotide sequences involved, many scientists have questioned the wisdom of diverting resources from perhaps more creative scientific endeavor, to the effort required to sequence the human genome. Others have pointed out that the project is fraught with technical uncertainties. Proponents point out the great potential benefits of determining the imprint that controls the genetic properties of the human cell at the highest possible level of resolution. Presently, as many as 4000 genetic diseases have been identified and many of them, namely, those inherited in Mendelian fashion, are caused by a single mutant gene. Searching for the imprint of human disease at the level of nucleotide sequences may permit understanding of all disease states at the genomic level. Determination of the complete sequence appears to be one of the prerequisites for understanding human disease at the molecular level. There is little doubt that the sequencing of the human genome will present us with many new challenges and opportunities in medicine.

Grant Cooper, N. (Ed.). *The Human Genome Project*. Mill Valley, CA: University Science Books, 1994.

the restriction endonuclease will not recognize all sites in every DNA molecule but will instead produce a digest that includes a collection of partial fragments. Double-stranded DNA is end-labeled by treatment with alkaline phosphatase, which removes the phosphate residue at the 5' end, and then γ -labeled with [^{32}P]ATP and a polynucleotide kinase, which incorporates the ^{32}P into the two 5' termini of the DNA strands. Alternately, the ^{32}P -label can be introduced at the 3' termini by the incorporation of ^{32}P -labeled deoxyribonucleotide triphosphates using DNA polymerase. End-labeling allows for each fragment to be identified on an electrophoresis gel. The details of this procedure are presented on page 762. Thus, with a series of different site cuts, the fragments can be mapped directly relative to the labeled end. Restriction maps are used for characterization of various DNAs and for ordering of smaller DNA fragments within a particular DNA sequence. Such ordering is essential before the nucleotide sequence of large DNA molecules can be determined.

Several methods have been developed for rapid sequencing of large poly-deoxyribonucleotides. They are impressively accurate. Digests obtained using different restriction enzymes produce segments with overlapping lengths of nucleotide sequences. The accuracy of sequencing methods are increased by sequencing the complementary strand. These procedures can also be used for sequencing of RNA molecules by prior conversion of the RNA sequence to a complementary DNA by use of reverse transcriptase. Sequences up to 500 bp can be determined in a single automated operation and stretches of 10,000 bp, which correspond to the average length of a gene, are now routinely determined. Clinical Correlation 15.11 discusses the application of these procedures for obtaining the sequence of the human genome.

Bibliography

- Adams, R. L. P. *DNA Replication*. Oxford, England: Oxford University Press; New York: IRL Press, 1991.
- Alberts, B., Bray, D., Lewis, J., Raff, M., Roberts, K., and Watson, J. D. *Molecular Biology of the Cell*, 3rd ed. New York: Garland, 1994.
- Bardwell, A. J., Bardwell, L., Wang, Z., Siede, W., et al. Recent insights on DNA repair: the mechanism of damaged nucleotide excision in eukaryotes and its relationship to other cellular processes. *Ann. N.Y. Acad. Sci.* 726:281, 1994.
- Bell, S. P., and Stillman, B. ATP-dependent recognition of eukaryotic origins of DNA replication by a multiprotein complex. *Nature* 357:128, 1992.
- Bernstein, C. *Aging, Sex and DNA Repair*. San Diego, CA: Academic Press, 1991.
- Bhattacharyya, A., Murchie, A. I., von Kitzing, E., Diekmann, S., Kemper, B., and Lilley, D. M. J. A model for the interaction of DNA junctions and resolving enzymes. *J. Mol. Biol.* 221:1191, 1991.
- Binden, R. R. *DNA Structure and Function*. San Diego, CA: Academic Press, 1994.
- Blackburn, E. H. Telomerases. *Annu. Rev. Biochem.* 61:113, 1992.
- Bootsma, D., Weeda, G., Vermeulen, W., van Vuuren, H., et al. Nucleotide excision repair syndromes: molecular basis and clinical symptoms. *Philos. Trans. R. Soc. Lond. B. Biol. Sci.* 347:75, 1995.
- Calladine, C., and Drew, H. *Understanding DNA—The Molecule and How It Works*. San Diego, CA: Academic Press, 1992.
- Calsou, P., and Salles, B. Properties of damage-dependent DNA incision by nucleotide excision repair in human cell-free extracts. *Nucleic Acids Res.* 22:4937, 1994.
- Chiu, S. K., Rao, B. J., Story, R. M., and Radding, C. M. Interactions of three strands in joints made by RecA protein. *Biochemistry* 32:13146, 1993.
- Dianov, G., and Lindahl, T. Reconstitution of the DNA base excision-repair pathway. *Curr. Biol.* 4:1069, 1994.
- Duckett, D. R., Murchie, A. I., Giraud-Panis, M. J., Pohler, J. R., and Lilley, D. M. Structure of the four-way DNA junction and its interaction with proteins. *Philos. Trans. R. Soc. Lond. B Biol. Sci.* 347:27, 1995.
- Echols, H., and Goodman, M. F. Fidelity mechanisms in DNA replication *Annu. Rev. Biochem.* 60:477, 1991.
- Fangman, W. L., and Brewer, B. J. Activation of replication origins in yeast chromosomes. *Annu. Rev. Cell Biol.* 7:375, 1991.
- Friedberg, E. C., Walker, G. C., and Siede, W. *DNA Repair and Mutagenesis*. Materials Park, OH: ASM Press, 1995.
- Hanawalt, P. C. Transcription-coupled repair and human disease. *Science* 266:1957, 1994.
- Hiasa, H., and Marians, K. J. Tus prevents overreplication of oriC plasmid DNA. *J. Biol. Chem.* 269:26959, 1994.
- Horiuchi, T., Fujimura, Y., Nishitani, H., Kobayashi, T., and Hidaka, M. The DNA replication fork blocked at the Ter site may be an entrance for the RecBCD enzyme into duplex DNA. *J. Bacteriol.* 176:4656, 1994.
- Huang, J.-C., Svoboda, D. L., Reardon, J. T., and Sancar, A. Human nucleotide excision nuclease removes thymine dimers from DNA by incising the 22nd phosphodiester bond 5' and the 6th phosphodiester bond 3' to the photodimer. *Proc. Natl. Acad. Sci. USA* 89:3664, 1992.
- Joyce, C. M., and Steitz, T. A. Function and structure relationships in DNA polymerases. *Annu. Rev. Biochem.* 63:777, 1994.
- Kamenetskii, F. *Unraveling DNA*. New York: VCH Publishers, 1993.
- Kim, M. G., Zhurkin, V. B., Jernigan, R. L., and Camerini-Otero, R. D. Probing the structure of a putative intermediate in homologous recombination: the third strand in the parallel DNA triplex is in contact with the major groove of the duplex. *J. Mol. Biol.* 247:874, 1995.
- Kim, S. T., and Sancar, A. Photochemistry, photophysics, and mechanism of pyrimidine dimer repair by DNA photolyase. *Photochem. Photobiol.* 57:895, 1993.
- Kornberg, A. *DNA Replication*, 4th ed. New York: Wiley, 1992.
- Landy, A. Dynamic, structural and regulating aspects of site-specific recombination. *Annu. Rev. Biochem.* 58:913, 1989.
- Lewin, B. *Genes V*. New York: Oxford University Press, 1994.
- Lindsten, J., and Pettersson, U. *Etiology of Human Disease at the DNA Level*. New York: Raven Press, 1991.
- Luzio, J. P., and Thompson, R. J. In: *Molecular Medical Biochemistry*. New York: Cambridge University Press, 1990.
- Marians, K.J. Prokaryotic DNA replication. *Annu. Rev. Biochem.* 61:673, 1992.
- Matsunaga, T., Mu, D., Park, C.-H., Reardon, J. T., and Sancar, A. Human DNA repair excision nuclease. *J. Biol. Chem.* 270:20862, 1995.
- Modrich, P. Mismatch repair, genetic stability, and cancer. *Science* 266:1959, 1994.
- Parsons, C. A., Stasiak, A., Bennett, R. J., and West, B. C. Structure of a multisubunit complex that promotes DNA branch migration. *Nature* 374:375, 1995.
- Pederson, D. S. *Transcription Factors and DNA Replication*. Austin, TX: R. B. Landes, 1994.
- Richardson, C. C., and Lehman, I. R. *Molecular Mechanisms in DNA Replication and Recombination*. New York: Wiley, 1990.
- Sancar, A. Mechanisms of DNA excision repair. *Science* 266:1954, 1994.
- Schlotterer, C., and Tautz, D. Slippage synthesis of simple sequence DNA. *Nucleic Acids Res.* 20:211, 1992.
- Takahashi, M., and Nordien, B. Structure of RecA–DNA complex and mechanism of DNA strand exchange reaction in homologous recombination. *Adv. Biophys.* 30:1, 1994.
- Vos, J.-M. H. *DNA Repair Mechanism: Impact on Human Disease and Cancer*. New York: Demos Vermande, 1995.
- Wang, T. S. F. Eukaryotic DNA polymerases. *Annu. Rev. Biochem.* 60:513, 1991.
- Wolfe, S. L. *Molecular and Cellular Biology*. Belmont, CA: Wadsworth, 1993.
- Yang, S. S., Fliakas-Boltz, V., Bader, J. P., and Buckheit, R. W. Jr. Characteristics of a group of nonnucleoside reverse transcriptase inhibitors with structural diversity and potent anti-human immunodeficiency virus activity. *Leukemia* 9:575, 1995.

Questions

C. N. Angstadt and J. Baggott

- Which of the following statements about *E. coli* DNA polymerases is correct?
 - All polymerases have both 3' → 5' and 5' → 3' exonuclease activity.
 - The primary role of polymerase III is in DNA repair.
 - Polymerases I and III require both a primer and a template.
 - Polymerase I tends to remain bound to the template until a large number of nucleotides have been added.
 - The specificity of the polymerase reaction is inherent in the nature of polymerases.
- Proofreading activity to maintain the fidelity of DNA synthesis:
 - occurs after the synthesis has been completed.
 - is a function of the 3' → 5' exonuclease activity of the DNA polymerases.
 - requires the presence of an enzyme separate from the DNA polymerases.
 - occurs in prokaryotes but not eukaryotes.
 - is independent of the polymerase activity in prokaryotes.

3. Which of the following would result in a frameshift mutation?
- formation of ionized bases by radiation.
 - substitution of a purine–pyrimidine pair by a pyrimidine–purine pair.
 - intercalation of ethidium bromide into the nucleotide chain.
 - deamination of cytosine to uracil.
 - conversion of guanine to xanthine.
4. One way of introducing a transition mutation into DNA is by:
- using a structural analog of a base during synthesis.
 - the action of an acridine dye.
 - introducing a methyl group on the adenine of a GATC sequence.
 - blocking the proofreading action of DNA polymerase.
 - stretching the DNA helix.
5. Which of the following is (are) step(s) in excision repair mechanisms?
- excision.
 - incision.
 - ligation.
 - all of the above.
 - none of the above.
6. Base excision repair:
- is used only for bases that have been deaminated.
 - uses enzymes called DNA glycosylases to generate an abasic sugar site.
 - removes about 10–15 nucleotides.
 - requires the action of DNA polymerase III (*E. coli*).
 - recognizes a bulky lesion.
7. All of the following are true about nucleotide excision repair EXCEPT:
- it is deficient in the disease xeroderma pigmentosum.
 - it removes thymine dimers generated by UV light.
 - it involves the activity of excision nuclease, which is an endonuclease.
 - it requires polymerase I (*E. coli*) and ligase.
 - it occurs in prokaryotes but not in eukaryotes.
8. Mismatch repair:
- recognizes and removes mismatched bases during the process of replication.
 - occurs only if the mismatch is on a strand containing methylated bases.
 - in *E. coli*, recognizes mismatches within a few hundred base pairs of a GATC sequence.
 - looks for a distortion where the base structure has been altered.
 - is characterized by all of the above being correct.
9. Both strands of DNA serve as templates concurrently in:
- replication.
 - excision repair.
 - mismatch repair.
 - repair catalyzed by photolyase.
 - all of the above.
10. Replication:
- is semiconservative.
 - requires only proteins with DNA polymerase activity.
 - uses 5' → 3' polymerase activity to synthesize one strand and 3' → 5' polymerase activity to synthesize the complementary strand.
 - requires a primer in eukaryotes but not in prokaryotes.
 - must begin with an incision step.
11. The discontinuous nature of DNA synthesis:
- requires that DNA polymerase III dissociate from the template when it reaches the end of each single-stranded region.
 - is necessary only because synthesis is bidirectional from the initiation point.
 - leads to the formation of Okazaki fragments.
 - means that synthesis occurs on the second strand of DNA only after synthesis on the first strand is completed.
 - means that both 3' → 5' and 5' → 3' polymerases are used.
12. All of the following are factors in the unwinding and separation of DNA strands for replication EXCEPT:
- the tendency of negative superhelices to partially unwind.
 - destabilization of complementary base pairs by helicases.
 - the action of topoisomerases.
 - the enzymatic activity of SSB proteins.
 - energy in the form of ATP.
13. Initiation of replication in *E. coli*:
- begins with dnaA binding at the OriC site if certain bases are methylated.
 - results in the formation of several "bubbles," each consisting of a few nucleotide pairs.
 - forms a primosome, which then uses a topoisomerase to open a replication fork.
 - requires the action of helicase to initiate synthesis on the leading strands.
 - begins with the formation of the replisome, followed by the formation of the primosome to begin replication.
14. In eukaryotic DNA replication:
- only one replisome forms because there is a single origin of replication.
 - the leading and lagging strands are synthesized by the same enzyme.
 - helicase dissociates from DNA as soon as the initiation bubble forms.
 - at least one DNA polymerase has a 3' → 5' exonuclease activity.
 - the process occurs throughout the cell cycle.
15. All of the following statements about telomerase are correct EXCEPT:
- the RNA component acts as a template for the synthesis of a segment of DNA.
 - it adds telomeres to the 5' ends of the DNA strands.
 - it provides a mechanism for replicating the ends of linear chromosomes in most eukaryotes.
 - telomerase recognizes a G-rich single strand of DNA.
 - it is a reverse transcriptase.

16. Homologous recombination:
- A. occurs only between two segments from the same DNA molecule.
 - B. requires that a specific DNA sequence be present.
 - C. requires that one of the duplexes undergoing recombination be nicked in both strands.
 - D. may result in strand exchange by branch migration.
 - E. is catalyzed by transposases.

17. All of the following are true about transpositions EXCEPT:

- A. transposons move from one location to a different one within a chromosome.
- B. both the donor and target sites must be homologous.
- C. composite transposons contain an additional gene that is not present in an insertion sequence (IS).
- D. transposase introduces a staggered cut in the target DNA sequence.
- E. transposition may either activate or inactivate a gene.

Answers

1. C The primer is the initial 3' terminus of an existing strand and the template is the free portion of the complementary strand. B: Polymerase III functions in synthesis. D: Polymerase I has low processivity because it dissociates after only a few nucleotides are added. E: Specificity is a function of complementary hydrogen-bonding between the base being added and the template (pp. 622–623).
2. B This activity removes a newly added base if there is a mismatch with the template. A: This is called repair. C: The polymerases are multifunctional enzymes. D: Not all eukaryotic polymerases have 3' → 5' exonuclease activity but some do. E: The polymerase active site seems to be the one that detects the mismatch and directs the 3' terminus to the proofreading site (p. 624).
3. C Since the bases are read in groups of three, insertion of an additional base would shift the reading frame (p. 628). Intercalation stretches the DNA so when DNA is replicated an additional base is inserted near the intercalation site (p. 633). A: Ionized bases show atypical base pairing. B and D are both examples of base substitution type of mutations. E: This change probably wouldn't make any difference (p. 628).
4. A 5-Bromouracil and 2-aminopurine are used to deliberately introduce mutations for research. B and E: Intercalating agents stretch the helix, allowing the insertion of an extra base—a frameshift mutation. C: The mismatched repair system uses methylated adenine to distinguish between the old and newly synthesized strands. D: This could lead to a mutation but not necessarily a transition (p. 628).
5. D The other step in the process is resynthesis to fill in the gap left by the actions of A and B (p. 635).
6. B These catalyze the first step of the process. A: Methylated and other chemically modified bases can also be removed. C and E: These are characteristics of a different repair system. D: Polymerase I is the repair enzyme (p. 635).
7. E It is common to both systems. A: This is a genetic disease which requires more proteins than the prokaryotic system. B: Thymine dimers are only one cause of bulky lesions. C and D: The excision nuclease is a complex of proteins needed to unwind the DNA and remove the lesion. The polymerase and ligase fill in the gap (pp. 635–636).
8. C Methylated adenine in this sequence is a postreplicative event and signals the correct strand (i.e., unmethylated strand is newly synthesized). A: This is the function of proofreading; mismatch repair is postreplicative. B: Unmethylated sequences shortly after replication denote the newly synthesized strand. D: The bases are unaltered (p. 639).
9. A This allows for the synthesis of two identical DNA molecules. B and C: In both of these the damaged segment is removed so both strands are not available. D: This simply disrupts the inappropriate covalent bond of thymine dimers; no synthesis is involved (pp. 642 and 646).
10. A B and D: Replication requires a primer, usually synthesized by a primase. Ligases, helicases, and other proteins are required as well. C: Replication involves Okazaki fragments because synthesis occurs only in the 5' → 3' direction. E: Incision is the recognition step for DNA repair (p. 643).
11. C These are the segments of DNA built upon the primer. A: DNA polymerase remains bound to the template and slides over the next primer to continue synthesis. B and E: This mechanism compensates for the inability to synthesize 3' → 5' and would be necessary even if synthesis were unidirectional. D: Both strands are synthesized concurrently (pp. 646–647).
12. D SSB proteins stabilize the single strands after separation but have no enzymatic activity. A: This is especially true in regions of high AT pairs. B and E: This helps in the original unwinding at the expense of ATP. C: Topoisomerases nick and reseal one of the strands to prevent the introduction of an increasing number of positive supercoils (p. 648).
13. A Methylation seems to be a key in recognition of the OriC site. B: *Escherichia coli* forms only one bubble, a few hundred nucleotide pairs in size. C: The forks form and are stabilized before primase adds. D: The negative superhelicity favors initiation but helicase is necessary for the continuation of synthesis. E: The replisome is the final assembly and includes DNA polymerase III and rep proteins (pp. 649–651).
14. D Polymerase α shows this activity that provides proofreading during synthesis. β and β' have this for proofreading. A: There are multiple initiation sites. The DNA segments between two initiation points are called replicons (p. 654). B: In prokaryotes, the DNA polymerase III does both; in eukaryotes β synthesizes the leading strand and α the lagging strand, at least for the initiation process. C: Helicase activity is also necessary for the continuation of synthesis, that is, the opening of the forks (p. 655). E: Replication is confined to the S phase (p. 654).
15. B It is the 3' end of each strand that cannot be conventionally replicated. A and C: Telomerase both positions itself at the 3' ends of the DNA and provides the template for extending that end (p. 660, Figure 15.40). D: This is a characteristic of the 3' end. E: It is using an RNA template to synthesize DNA (p. 659).
16. D This is just one of the events in this complex process. A and B: It may occur between two distinct DNA molecules; the

requirement is that the two sequences be homologous but not that they be specific sequences. C: The nicks are usually on a single strand. E: These are the enzymes of transpositional site-specific recombination (p. 663).

17. B Only the donor site requires a specific nucleotide sequence; homology is not required. A: This is the definition. C: The IS contains the gene for transposon plus the flanking sequences; composite transposons have an additional gene—for example, one that confers antibiotic resistance in bacteria. D: This permits the transposon to be inserted. E: Insertion into the middle of a gene would inactivate it; insertion of a promoter next to a gene may activate it (pp. 670–671).

Chapter 16— RNA: Structure, Transcription, and Processing

Francis J. Schmidt

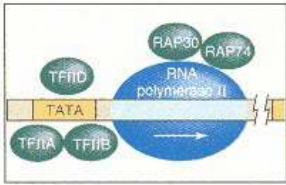

16.1 Overview	678
16.2 Structure of RNA	679
RNA Is a Polymer of Ribonucleoside 5 -Monophosphates	679
Secondary Structure of RNA Involves Intramolecular Base Pairing	680
RNA Molecules Have Tertiary Structures	680
16.3 Types of RNA	681
Transfer RNA Has Two Roles: Activating Amino Acids and Recognizing Codons in mRNA	682
Ribosomal RNA Is Part of the Protein Synthesis Apparatus	683
Messenger RNAs Carry the Information for the Primary Structure of Proteins	684
Mitochondria Contain Unique RNA Species	685
RNA in Ribonucleoprotein Particles	686
Some RNAs Have Catalytic Activity	686
RNAs Can Form Binding Sites for Other Molecules	688
16.4 Mechanisms of Transcription	689
The Initial Process of RNA Synthesis Is Transcription	689
The Template for RNA Synthesis Is DNA	690
RNA Polymerase Catalyzes the Transcription Process	690
The Steps of Transcription in Prokaryotes Have Been Determined	692
Initiation	695
Elongation	695
Termination	696
Transcription in Eukaryotes Involves Many Additional Molecular Events	696
The Nature of Active Chromatin	697
Enhancers	697
Transcription of Ribosomal RNA Genes	697
Transcription by RNA Polymerase II	698
Promoters for mRNA Synthesis	699
Transcription by RNA Polymerase III	699
16.5 Posttranscriptional Processing	699
Transfer RNA Precursors Are Modified by Cleavage, Additions, and Base Modification	700
Cleavage	700
Additions	700
Modified Nucleosides	701
Ribosomal RNA Processing Releases the Various RNAs from a Longer Precursor	702
Messenger RNA Processing Requires Maintenance of the Coding Sequence	703
Blocking of the 5' Terminus and Poly(A) Synthesis	704
Removal of Introns from mRNA Precursors	705
Mutations in Splicing Signals Cause Human Diseases	706
Alternate pre-mRNA Splicing Can Lead to Multiple Proteins Being Made from a Single DNA Coding Sequence	706
16.6 Nucleases and RNA Turnover	708
Bibliography	709
Questions and Answers	710
Clinical Correlations	
16.1 Staphylococcal Resistance to Erythromycin	683
16.2 Antibiotics and Toxins That Target RNA Polymerase	692
16.3 Fragile X Syndrome: A Chromatin Disease?	697
16.4 Involvement of Transcriptional Factors in Carcinogenesis	701
16.5 Thalassemia Due to Defects in Messenger RNA Synthesis	705
16.6 Autoimmunity in Connective Tissue Disease	706

16.1— Overview

The primary information store of a cell is its genetic complement, that is, its DNA. DNA information is exactly analogous to the master copies of a computer program or any database: It is the source of cellular information and therefore must be kept as error-free as possible. Chapter 14 has detailed some of the elaborate mechanisms that are employed to keep DNA information intact from one cell generation to the next. This chapter describes another type of information transfer that helps to ensure the integrity of genomic information. Just as a careful computer programmer makes working copies of a program or data set, a cell makes macromolecular copies of the information in DNA. These macromolecules, ribonucleic acids (RNAs), are linear polymers of ribonucleoside monophosphates. The sequence of DNA is copied exactly into RNA. The process by which RNA copies of selected DNA sequences are made is termed transcription. The primary role of RNA within the cell is its involvement in protein synthesis, that is, translation.

The overall process of information transfer in the cell is therefore given by the so-called **central dogma** of molecular biology:



TABLE 16.1 Characteristics of Cellular RNAs

Type of RNA	Abbreviation	Function	Size and Sedimentation Coefficient	Site of Synthesis	Structural Features
Messenger RNA Cytoplasmic	mRNA	Transfer of genetic information from nucleus to cytoplasm, or from gene to ribosome	Depends on size of protein 1000–10,000 nucleotides	Nucleoplasm	Blocked 5' end; poly(A) tail on 3' end; nontranslated sequences before and after coding regions; few base pairs and methylations
Mitochondrial	mt mRNA		9S–40S	Mitochondria	
Transfer RNA Cytoplasmic	tRNA	Transfer of amino acids to mRNA–ribosome complex and correct sequence insertion	65–110 nucleotides 4S	Nucleoplasm	Highly base paired; many modified nucleotides; common specific structure
Mitochondrial	mt tRNA		3.2S–4S	Mitochondria	
Ribosomal RNA Cytoplasmic	rRNA	Structural framework for ribosomes	28S, 5400 nucleotides 18S, 2100 nucleotides 5.8S, 158 nucleotides 5S, 120 nucleotides	Nucleolus Nucleolus Nucleolus Nucleoplasm	5.8S and 5S highly base paired; 28S and 18S have some base paired regions and some methylated nucleotides
Mitochondrial	mt rRNA		16S, 1650 nucleotides 12S, 1100 nucleotides	Mitochondria	
Heterogeneous nuclear RNA	hnRNA	Some are precursors to mRNA and other RNAs	Extremely variable 30S–100S	Nucleoplasm	mRNA precursors may have blocked 5' ends and 3'-poly(A) tails; many have base paired loops
Small nuclear RNA	snRNA	Structural and regulatory RNAs in chromatin	100–300 nucleotides	Nucleoplasm	
Small cytoplasmic RNA [7S(L) RNA]	scRNA	Selection of proteins for export	129 nucleotides	Cytosol and rough endoplasmic reticulum	Associated with proteins as part of signal recognition particle

RNA information is occasionally **reverse transcribed** into DNA, a process important in the life cycle of infectious retroviruses such as the human immunodeficiency virus (HIV), which causes the acquired immunodeficiency syndrome (AIDS). Reverse translation of protein sequence into nucleic acid sequence information, however, does not occur in nature.

RNA molecules are classified according to the roles they play in information transfer processes (Table 16.1). In prokaryotes, transcription and translation occur close together; in fact, ribosomes can begin translating a mRNA while it is still being synthesized. In eukaryotes, these processes are spatially separated: transcription occurs in the nucleus and translation in the cytoplasmic portions of the cell. **Messenger RNAs (mRNA)** serve as templates for the synthesis of protein; they carry information from the DNA to the cellular protein synthetic machinery. Here a number of other RNA species contribute to the synthesis of the peptide bond.

The molecules that transfer specific amino acids from soluble amino acid pools to ribosomes, and ensure the alignment of these amino acids in the proper sequence prior to peptide bond formation, are **transfer RNAs (tRNA)**. All tRNA molecules are approximately the same size and shape. The assembly site, or factory, for peptide synthesis involves ribosomes. These complex subcellular particles contain three or four **ribosomal RNA (rRNA)** molecules and 70–80 ribosomal proteins.

Protein synthesis requires a close interdependent relationship between mRNA, the informational template, tRNA, the amino acid adaptor molecule, and rRNA, part of the synthetic machinery. In order for protein synthesis to occur at the correct time in a cell's life, the syntheses of mRNA, tRNA, and rRNA must be coordinated with the cell's response to the intra- and extracellular environments.

All cellular RNA is synthesized on a DNA template and reflects a portion of the DNA base sequence. Therefore all RNA is associated with DNA at some time. Although DNA is the more prevalent genetic store of information, RNA can also carry genetic information. Genomic RNA is found in the RNA tumor viruses and the other small RNA viruses, such as poliovirus and reovirus.

16.2— Structure of RNA

RNA Is a Polymer of Ribonucleoside 5'-Monophosphates

Chemically, RNA is similar to DNA. Although RNA is one of the more stable components within a cell, it is not as stable as DNA. The presence of the adjacent 2'-hydroxyl group makes the RNA phosphodiester bond more susceptible to chemical and enzymatic hydrolysis than its DNA counterpart. Some RNAs, such as bacterial mRNA, are synthesized, used, and degraded within minutes, whereas others, such as rRNA, are more stable metabolically.

RNA is an unbranched linear polymer of ribonucleoside monophosphates. The purines found in RNA are *adenine* and *guanine*; the pyrimidines are *cytosine* and *uracil*. Except for uracil, which replaces thymine, these are the same bases found in DNA.

A, C, G, and U nucleotides are incorporated into RNA during transcription. Many RNAs also contain **modified nucleotides**, which are synthesized after transcription. Modified nucleotides are especially characteristic of stable RNA species (i.e., tRNA and rRNA); however, some methylated nucleotides are also present in eukaryotic mRNA. For the most part, the functions of the modified nucleotides in RNA have not been identified. Where known, the function of nucleotide modification seems to involve "fine tuning" rather than an indispensable role in the cell.

The 3',5'-phosphodiester bonds of RNA form a chain or backbone from

which the bases extend (Figure 16.1). Eukaryotic RNAs vary from approximately 65 nucleotides long to more than 200,000 nucleotides long. RNA sequences are complementary to the base sequences of specific portions of only one strand of DNA. Thus, unlike the base composition of DNA, molar ratios of A + U and G + C in RNA are not equal. All cellular RNA so far examined is linear and single stranded, but double-stranded RNA is present in some viral genomes.

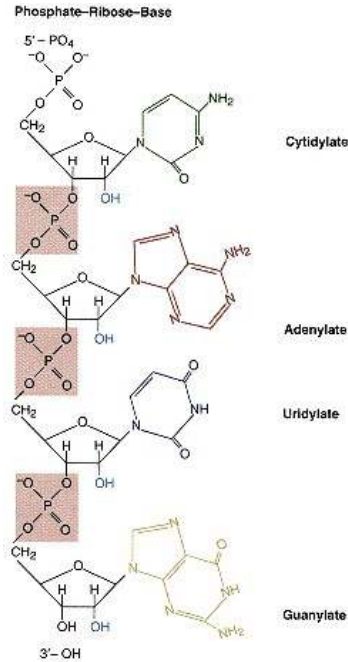

Figure 16.1
Structure of the 3',5'-phosphodiester bonds between ribonucleotides forming a single strand of RNA.

The phosphate joins the 3-OH group of one ribose with the 5-OH group of the next ribose. This linkage produces a polyribonucleotide having a sugar-phosphate "backbone." The purine and pyrimidine bases extend away from the axis of the backbone and may pair with complementary bases to form double helical base paired regions.

Secondary Structure of RNA Involves Intramolecular Base Pairing

RNA, being single stranded rather than double stranded, does not usually form an extensive double helix. Rather, the structure in an RNA molecule arises from relatively short regions of **intramolecular base pairing**. Considerable helical structure exists in RNA even in the absence of extensive base pairing, for example, in the portions of an RNA that do not form intramolecular Watson-Crick base pairs. This helical structure is due to the strong base-stacking forces between A, G, and C residues. Base stacking is more important than simple hydrogen bonding in determining inter- and intramolecular interactions. These forces act to restrict the possible conformations of an RNA molecule (Figure 16.2). **RNA helical structures** generally are of the "A type" with 11 nucleotides per turn in a double helix.

Double helical regions in RNA are often called "hairpins." There are considerable variations in the fine structural details of "**hairpin**" structures, including the length of base paired regions and the size and number of unpaired loops (Figure 16.3). Transfer RNAs are excellent examples of base stacking and hydrogen bonding in a single-stranded molecule (Figure 16.4a). About 60% of the bases are paired in four double helical stems. In addition, the unpaired regions have the capability to form base pairs with free bases in the same or other looped regions, thereby contributing to the molecule's tertiary structure. The anticodon region in tRNA is an unpaired, base-stacked, loop of seven nucleotides. The partial helix caused by base stacking in this loop binds, by specific base pairing, to a complementary codon in mRNA so that translation (peptide bond formation) can occur.

RNA Molecules Have Tertiary Structures

The actual functioning structures of RNA molecules are more complex than the base-stacked and hydrogen-bonded helices mentioned above. RNAs *in vivo* are

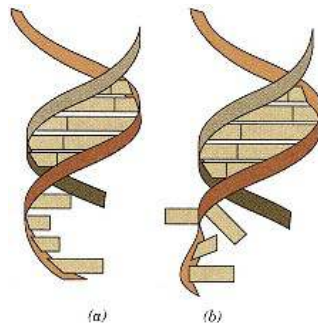

Figure 16.2
Helical structure of tRNA.

Models indicating a helical structure due to (a) base stacking in the CCA terminus of tRNA and

(b) the lack of an ordered helix when no stacking occurs in this non-base paired region.

Redrawn from Sprinzl, M., and Cramer, F. *Prog. Nucl. Res. Mol. Biol.* 22:9, 1979.

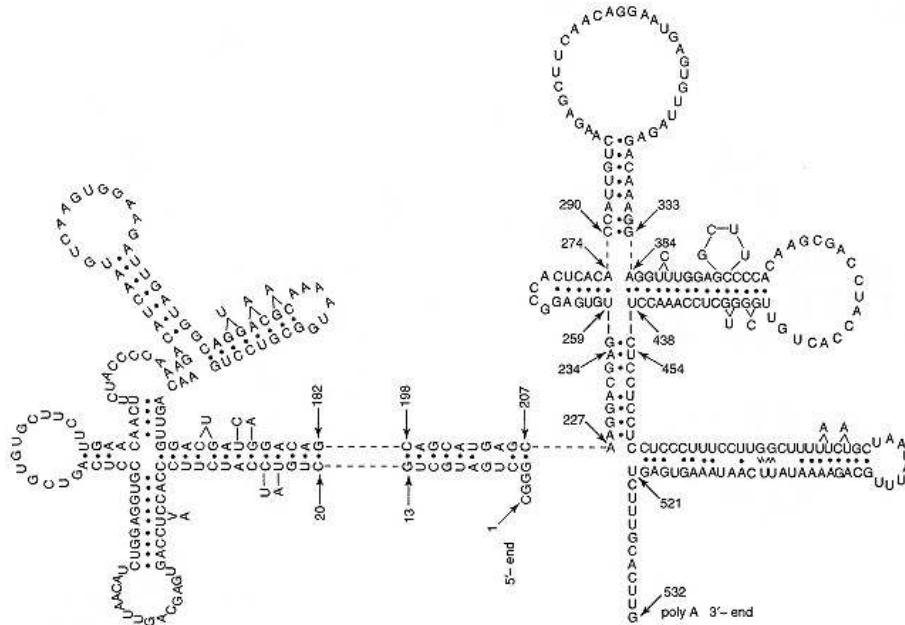

Figure 16.3

Proposed base pairing regions in the mRNA for mouse immunoglobulin light chain.

Base paired structures shown have free energies of at least -5 kcal. Note the variance in loop size and length of paired regions.

Redrawn from Hamlyn, P. H., Brownie, G. G., Cheng, C. C., Gait, M. J., and Milstein, C. *Cell* 15:1067, 1978.

dynamic molecules that undergo changes in conformation during synthesis, processing, and functioning. Proteins associated with RNA molecules often lend stability to the RNA structure; in fact, it is perhaps more correct to think of RNA–protein complexes rather than naked RNA molecules as functioning components of the cell. In addition to the secondary, base paired structure, RNA molecules also form other hydrogen bonds to form the **tertiary structure** of the molecule. Again, the structure of tRNA provides a number of examples. In solution, tRNA is folded into a compact "L-shaped" conformation (Figure 16.4b). The arms and loops are folded in specific conformations held in position not only by Watson–Crick base pairing, but also by base interactions involving more than two nucleotides. Bases can donate hydrogen atoms to bond with the phosphodiester backbone. The 2 -OH of the ribose is an important donor and acceptor of hydrogens. All these interactions contribute to the folded shape of an RNA molecule.

16.3— Types of RNA

RNA molecules are traditionally classified as transfer, ribosomal, and messenger RNAs according to their usual function; however, we now know that RNA molecules perform or facilitate a variety of other functions in a cell.

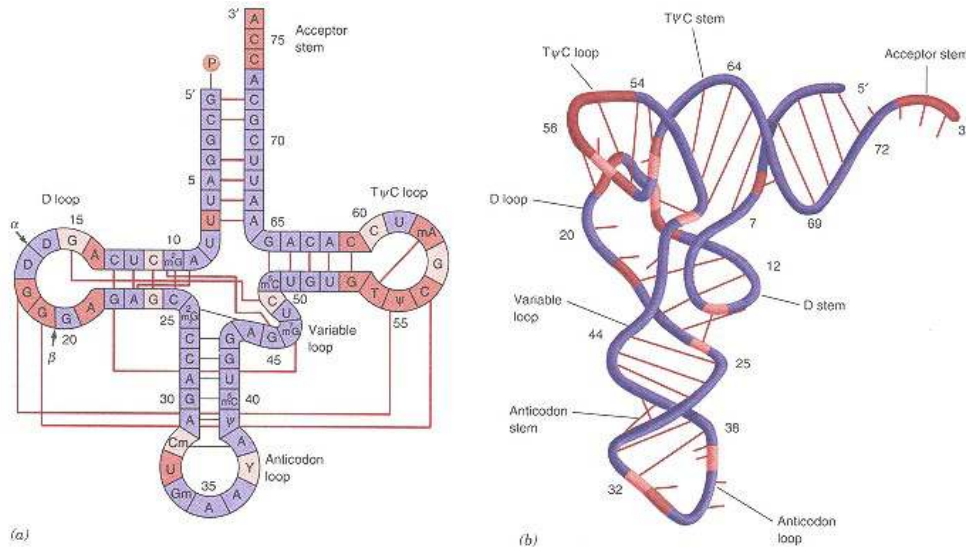

Figure 16.4
Coverleaf structure of tRNA

(a) Cloverleaf diagram of the two-dimensional structure and nucleotide sequence of yeast tRNA^{Phe}. Red lines connecting nucleotides indicate hydrogen-bonded residues. Insertion of nucleotides in the D loop occurs at positions α and β for different tRNAs.

(b) Tertiary folding of the cloverleaf structure in (a). Hydrogen bonds are indicated by cross rungs.

Redrawn with permission from Quigley, G. J., and Rich, A. *Science* 194:797, 1976.
Copyright © 1976 by the American Association for the Advancement of Science.

Transfer RNA Has Two Roles:

Activating Amino Acids and Recognizing Codons in mRNA

About 15% of the total cellular RNA is tRNA. Transfer RNA has two functions that are essential for its cellular role as an "adapter" of nucleic acid to protein information. First, tRNA molecules **activate amino acids** for protein synthesis so that formation of peptide bonds is energetically favored. The activated amino acid is transported to the polyribosome where it is transferred to the growing peptide chain (hence tRNA's name). The second function of tRNA is to recognize codons in mRNA to ensure that the correct amino acid is incorporated into the growing peptide chain. These two functions are reflected in the fact that tRNAs have two primary active sites, the 3'-OH terminal CCA, to which specific amino acids are attached enzymatically, and the **anticodon triplet**, which base pairs with mRNA codons.

Each tRNA can transfer only a single amino acid. Although there are only 20 amino acids used in protein synthesis, free-living organisms synthesize a larger set of tRNAs. For example, analysis of the recently determined genomic sequence of *Haemophilus influenzae* identified genes for 54 tRNA species. Mitochondria synthesize a much smaller number of tRNAs. Transfer RNAs that accept the same amino acid are called **isoacceptors**. A tRNA that accepts phenylalanine would be written as tRNA^{Phe}, whereas one accepting tyrosine would be written tRNA^{Tyr}.

CLINICAL CORRELATION 16.1**Staphylococcal Resistance to Erythromycin**

Bacteria exposed to antibiotics in a clinical or agricultural setting often develop resistance to the drugs. This resistance can arise from a mutation in the target cell's DNA, which gives rise to resistant descendants. An alternative and clinically more serious mode of resistance arises when plasmids coding for antibiotic resistance proliferate through the bacterial population. These plasmids may carry multiple resistance determinants and render several antibiotics useless at the same time.

Erythromycin inhibits protein synthesis by binding to the large ribosomal subunit. *Staphylococcus aureus* can become resistant to erythromycin and similar antibiotics as a result of a plasmid-borne RNA methylase that converts a single adenosine in 23S rRNA to *N*⁶-dimethyladenosine. Since the same ribosomal site binds lincomycin and clindamycin, the plasmid causes cross-resistance to these antibiotics as well. Synthesis of the methylase is induced by erythromycin.

The microorganism that produces an antibiotic must also be immune to it or else it would be inhibited by its own toxic product. The producer of erythromycin, *Streptomyces erythreus*, itself possesses an rRNA methylase that acts at the same ribosomal site as the one from *S. aureus*.

Which came first? It is likely that many of the resistance genes in target organisms evolved from those of producer organisms. In several cases, DNA sequences from resistance genes of the same specificity are conserved between producer and target organisms. We may therefore look on plasmid-borne antibiotic resistance as a case of "natural genetic engineering," whereby DNA from one organism (e.g., the *Streptomyces* producer) is appropriated and expressed in another (e.g., the *Staphylococcus* target).

Cundliffe, E. How antibiotic-producing microorganisms avoid suicide. *Annu. Rev. Microbiol.* 43:207, 1989.

Transfer RNAs range from 65 to 110 nucleotides in length, corresponding to a molecular weight range of 22,000–37,000. The sequences of all tRNA molecules (over 1000 are known) can be arranged into a common secondary structure that has the appearance of a cloverleaf. The cloverleaf structure is determined by complementary Watson–Crick base pairs forming three stem and loop or hairpin structures. The anticodon triplet sequence is at one "leaf" of the **cloverleaf** while the CCA acceptor stem is at the "stem" (see Figure 16.4). This arrangement where the two active sites of a tRNA are spatially separated is preserved in the tertiary structure of tRNA^{Phe} shown in Figure 16.4. Additional, non-Watson–Crick, hydrogen bonds form in the L-shaped molecule.

The nucleotide sequence and structure of the tRNA^{Phe} molecule depicted in Figure 16.4 show that tRNAs have several modified nucleotides. The modified nucleotides affect tRNA structure and stability but are not required for the formation or maintenance of tertiary conformation. For example, a modified base in the anticodon loop makes codon recognition more efficient but a tRNA without this modification can still be read correctly by the ribosome.

Many structural features are common to all tRNA molecules. Seven base pairs are present in the amino acid acceptor stem, which terminates with the nucleotide triplet CCA. This CCA triplet is not base paired. The dihydrouracil or "D" stem has three or four base pairs, while the anticodon and T stems have five base pairs each. Both the anticodon loop and T loop contain seven nucleotides. Differences in the number of nucleotides in different tRNAs are accounted for by the variable loop. Thus 80% of tRNAs have small variable loops of 4–5 nucleotides, while others have larger loops of 13–21 nucleotides. The positions of some nucleotides are constant in all tRNAs (see Figure 16.4a).

Ribosomal RNA Is Part of the Protein Synthesis Apparatus

Protein synthesis takes place on ribosomes. These complex assemblies are composed in eukaryotes of four RNA molecules, representing about two-thirds of the particle mass, and 82 proteins. The smaller subunit, the **40S particle**, contains one **18S RNA** and 33 proteins. The larger subunit, the **60S particle**, contains the **28S**, the **5.8S**, and the **5S rRNAs** and 49 proteins. The total assembly is called the **80S ribosome**. Prokaryotic ribosomes are somewhat smaller: the **30S subunit** contains a single **16S rRNA** and 21 proteins, while the larger subunit (**70S**) contains **5S** and **23S rRNAs** as well as 34 ribosomal proteins.

The rRNAs account for 80% of the total cellular RNA and are metabolically stable. This stability, required for repeated functioning of the ribosome, is enhanced by close association with the ribosomal proteins. The 28S (4718 nucleotides), 18S (1874 nucleotides), and 5.8S (160 nucleotides) rRNAs are synthesized in the nucleolar region of the nucleus. The 5S rRNA (120 nucleotides) is not transcribed in the nucleolus but rather from separate genes within the nucleoplasm (Figure 16.5). Processing of the rRNAs (see Section 16.5) includes cleavage to the functional size, internal base pairing, modification of particular nucleotides, and association with ribosomal proteins to form a stable tertiary conformation.

The larger rRNAs contain most of the altered nucleotides found in rRNA. These are primarily **methylations** on the 2' position of the ribose, yielding 2'-*O*-methylribose. Methylation of rRNA has been directly related to bacterial antibiotic resistance in a pathogenic species (see Clin. Corr. 16.1). A small number of *N*⁶-dimethyladenines are present in 18S rRNA. The 28S rRNA has about 45 methyl groups and the 18S rRNA has 30 methyl groups.

Biochemical studies of ribosome function indicate that rRNA molecules are more than macromolecular scaffolds for enzymatic proteins. The exact extent to which rRNA participates in protein biosynthetic reactions is the subject of current investigation. Several lines of evidence indicate that the actual formation of a peptide bond may be catalyzed by the large RNA subunit of the ribosome.

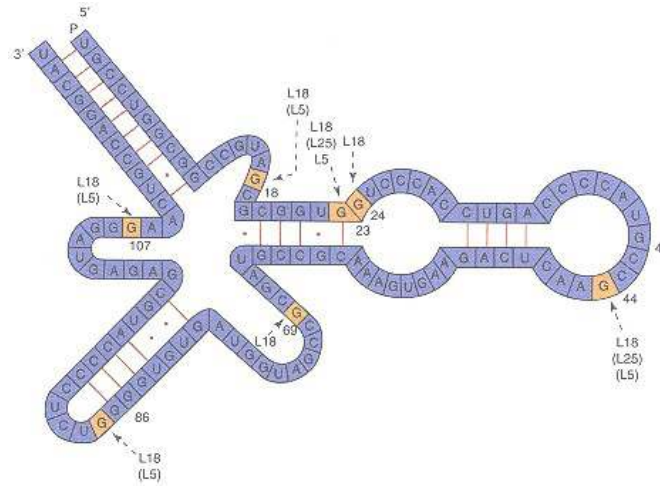

Figure 16.5
Secondary, base paired, structure proposed for 5S rRNA.
 Arrows indicate regions protected by proteins in the large ribosomal subunit.
 Combined information from Fox, G. E., and Woese, C. R.
Nature 256:505, 1975; and R. A. Garrett and P. N. Gray.

Messenger RNAs Carry the Information for the Primary Structure of Proteins

The **mRNAs** are the direct carriers of genetic information from genomes to the ribosomes. Each eukaryotic mRNA is **monocistronic**; that is, it contains information for only one polypeptide chain. In prokaryotes, mRNA species often encode more than one protein in a **polycistronic** molecule. A cell's phenotype and functional state are related directly to its mRNA content.

In the cytoplasm mRNAs have relatively short life spans. Some mRNAs are known to be synthesized and stored in an inactive or dormant state in the cytoplasm, ready for a quick protein synthetic response. An example of this is the unfertilized egg of the African clawed toad, *Xenopus laevis*. Immediately upon fertilization the egg undergoes rapid protein synthesis in the absence of transcription, indicating the presence of preformed mRNA.

Eukaryotic mRNAs have unique structural features not found in rRNA or tRNA (see Figure 16.6). Since the information within mRNA lies in the linear sequence of the nucleotides, the integrity of this sequence is extremely im-

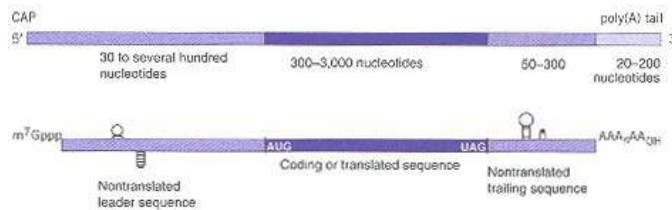

Figure 16.6
General structure for a eukaryotic mRNA.
 There is a "blocked" 5 terminus (cap) followed by the nontranslated leader containing a promoter sequence. The coding region usually begins with the initiator codon AUG and continues to the translation termination sequence UAG, UAA, or UGA. This is followed by the nontranslated trailer and a poly(A) tail on the 3 end.

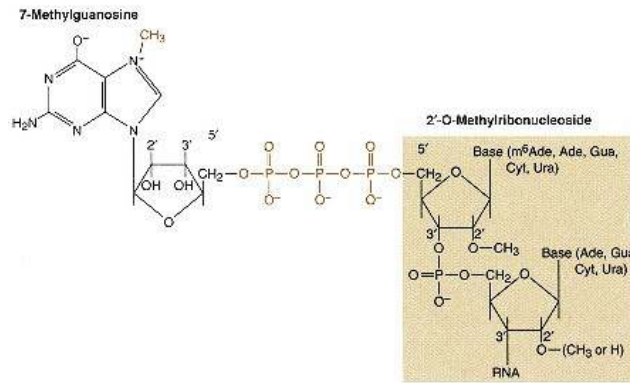

Figure 16.7

Diagram of the "cap" structure or blocked 5' terminus in mRNA.

The 7-methylguanosine is inverted to form a 5'-phosphate to 5'-phosphate linkage with the first nucleotide of the mRNA. This nucleotide is often a methylated purine.

portant. Any loss or change of nucleotides could alter the protein being translated. The translation of mRNA on the ribosomes must also begin and end at specific sequences. Structurally, starting from the 5' terminus, eukaryotic mRNA is capped with an inverted methylated base attached via **5'-phosphate–5'-phosphate bonds** rather than the usual 3',5'-phosphodiester linkages. The **cap** is attached to the first transcribed nucleotide, usually a purine, methylated on the 2'-OH of the ribose (see Figure 16.7). The cap is followed by a nontranslated or "**leader**" sequence to the 5' side of the coding region. Following the leader sequence are the **initiation sequence or codon**, most often AUG, and the translatable coding region of the molecule. At the end of the coding sequence is a **termination sequence** signaling termination of polypeptide formation and release from the ribosome. A second nontranslated or "**trailer**" sequence follows, terminated by a string of 20–200 adenine nucleotides, called a **poly(A) tail**, which makes up the 3' terminus of the mRNA.

The 5' cap has a positive effect on the initiation of message translation. In the initiation of translation of a mRNA, the cap structure is recognized by a single ribosomal protein, an initiation factor (see Chapter 17). The poly(A) sequence is correlated with the stability of the mRNA molecule; for example, **histone mRNA** molecules lack a poly(A) tail and are also present in the cell only transiently.

Mitochondria Contain Unique RNA Species

Mitochondria (mt) have their own protein-synthesizing apparatus, including ribosomes, tRNAs, and mRNAs. The mt rRNAs, 12S and 16S, are transcribed from the mitochondrial DNA (mt DNA), as are 22 specific tRNAs and 13 mRNAs, most of which encode proteins of the electron transport chain and ATP synthetase. Note that there are fewer mt tRNAs than prokaryotic or cytoplasmic tRNA species; there is only one mt tRNA species per amino acid. The mt RNAs account for 4% of the total cellular RNA. They are transcribed by a mitochondrial-specific RNA polymerase and are processed from a pair of mt RNA precursors. Each precursor is an exact copy of the entire mitochondrial genome, complementary to either the heavy (H) or light (L) strand of mt DNA. Genes for 12 tRNAs are located on the heavy mt DNA strand and 7 on the light strand. Some of the mRNAs have eukaryotic characteristics, such as 3'-poly(A) tails. A large degree of coordination exists between the nuclear and mitochondrial genomes. Most of the aminoacylating enzymes for the mt tRNAs and all of the mitochondrial ribosomal proteins are specified by nuclear genes, translated in the cytoplasm.

and transported into the mitochondria. The modified bases in mt tRNA species are synthesized by enzymes encoded in nuclear DNA.

RNA in Ribonucleoprotein Particles

Besides tRNA, rRNA, and mRNA, small, stable RNA species can be found in the nucleus, cytoplasm, and mitochondria. These small RNA species function as ribonucleoprotein particles (RNPs), with one or more protein subunits attached. Different RNP species have been implicated in RNA processing, splicing, transport, and control of translation, as well as in the recognition of proteins due to be exported. The actual roles of these species, where known, are described more fully in the discussion of specific metabolic events.

Some RNAs Have Catalytic Activity

RNA can be an enzyme. In several cases the RNA component of a ribonucleoprotein particle has been shown to be the catalytically active subunit of the enzyme. In other cases, *in vitro* catalytic reactions can be carried out by RNA in the absence of any protein. Enzymes whose RNA subunits carry out catalytic reactions are called **ribozymes**. There are four classes of ribozyme. Three of these RNA species carry out self-processing reactions while the fourth, **ribonuclease P (RNase P)**, is a true catalyst.

In the ciliated protozoan *Tetrahymena thermophila*, an intron in the rRNA precursor is removed by a multistep reaction (Figure 16.8). A guanosine nucleoside or nucleotide reacts with the intron–exon phosphodiester linkage to displace the donor exon from the intron. This reaction, a transesterification, is promoted by the folded intron itself. The free donor exon then similarly attacks the intron–exon phosphodiester bond at the acceptor end of the intron. Introns of this type (**Group I introns**) have been found in a variety of genes in fungal mitochondria and in the bacteriophage T4. Although these introns are not true enzymes *in vivo* because they only work for one reaction cycle, they can be made to carry out catalytic reactions under specialized conditions.

Group II self-splicing introns are found in the mitochondrial RNA precursors of yeasts and other fungi. The self-splicing of these introns proceeds through a lariat intermediate similar to the lariat intermediate in the splicing of nuclear mRNA precursors (see below). Since this reaction is carried out by a ribozyme the catalytic activity of the small nucleus ribonucleoproteins (snRNPs) involved in nuclear mRNA splicing may also reside in the RNA component.

A third class of **self-cleaving RNAs** is found in the genomic RNAs of several plant viruses. These RNAs self-cleave during the generation of single genomic RNA molecules from large multimeric precursors. The three-dimensional structure of the **hammerhead ribozyme**, a member of this third class, has recently been determined (Figure 16.9). Catalysis is carried out by a bound Mg^{2+} ion positioned near the bond to be cleaved in the folded ribozyme structure. The phosphate of the cleaved bond is left at the 3' hydroxyl position of the RNA product. A self-cleaving RNA is found in a small satellite virus, hepatitis delta virus, that is implicated in severe cases of human infectious hepatitis. All of the above self-processing RNAs can be made to act as true catalysts (i.e., exhibiting multiple turnover) *in vitro* and *in vivo*.

Ribonuclease P contains both a protein and an RNA component. It acts as a true enzyme in the cell, cleaving tRNA precursors to generate the mature 5' end of the tRNA molecule. RNase P recognizes constant structures associated with tRNA precursors (e.g., the acceptor stem and CCA sequence) rather than using extensive base pairing to bind the substrate RNA to the ribozyme. The product of cleavage contains a 5' phosphate in contrast to the products of hammerhead and similar RNAs. In all of these events the structure of the catalytic RNA is essential for intramolecular or enzyme catalysis.

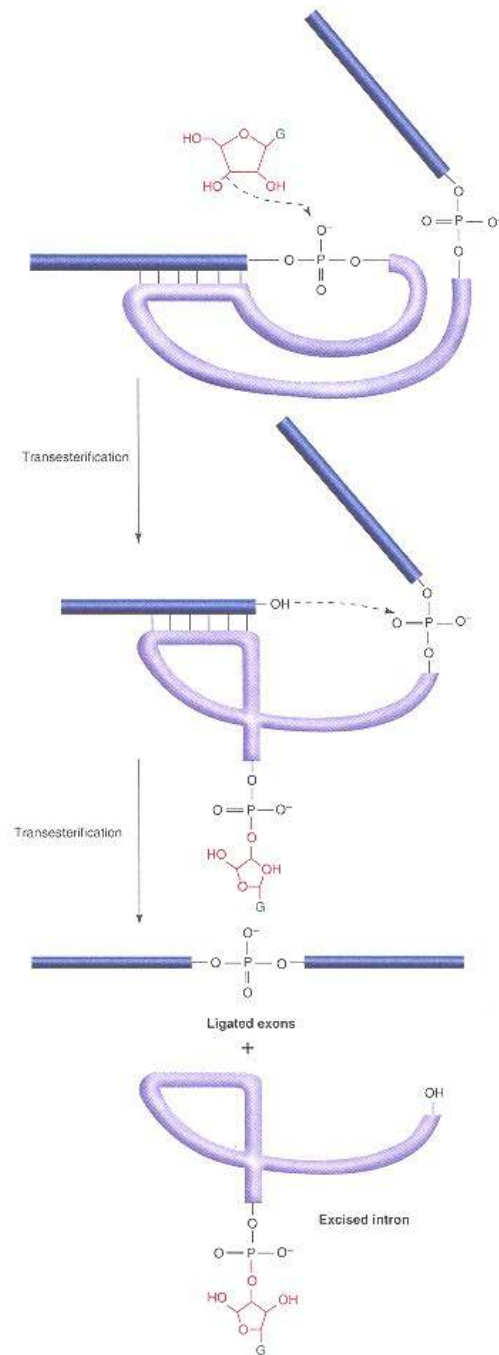

Figure 16.8

Mechanism of self-splicing of the rRNA precursor of *Tetrahymena*.

The two exons of the rRNA are denoted by dark blue. Catalytic functions reside in the intron, which is purple. This splicing function requires an added guanosine nucleoside or nucleotide.

Reproduced from Cech, T. R. *JAMA* 260:308, 1988.

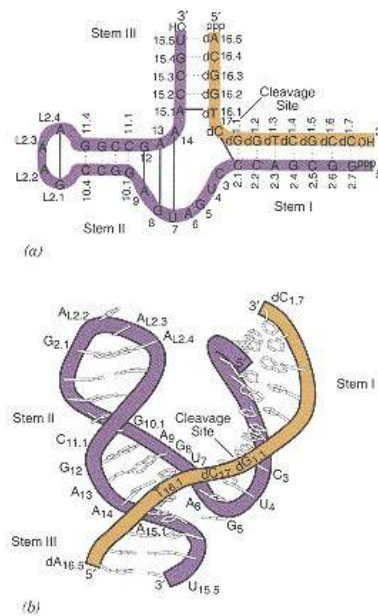

Figure 16.9

"Hammerhead" structure of viral RNA

- (a) The hammerhead structure of a self-cleaving viral RNA. This artificial molecule is formed by the base pairing of two separate RNAs. The cleavage of the RNA sequence at the site indicated by the arrow in the top strand requires its base pairing with the sequence at the bottom of the molecule. The boxed nucleotides are a consensus sequence found in self-cleaving viral RNAs.
- (b) The three-dimensional folding of the hammerhead catalytic RNA. The star indicates the position of the cleaved bond while M indicates a binding site for a metal ion. Helices II and III stack to form an apparently continuous helix while non-Watson-Crick interactions position the noncomplementary bases in the hammerhead into a "uridine turn" structure identical to that found in tRNA.

Part (a) redrawn from Sampson, J. R., Sullivan, F. X., Behlen, L. S., DiRenzo, A. B., and Uhlenbeck, O. C. *Cold Spring Harbor Symp. Quant. Biol.* 52:267, 1987;
 part (b) redrawn from Pley, H. W., Flaherty, K. M., and McKay, D. B. *Nature* 372:68 1994.

The discovery of RNA catalysis has greatly altered our concepts of biochemical evolution and the range of allowable cellular chemistry. First, we now recognize that RNA can serve as both a catalyst and a carrier of genetic information. This has raised the possibility that the earliest living organisms were based entirely on RNA and that DNA and proteins evolved later. This model is sometimes referred to as the **"RNA world."** Second, we know that many viruses, including human pathogens, use RNA genetic information; some of these RNAs have been shown to be catalytic. Thus catalytic RNA presents opportunities for the discovery of RNA-based pharmaceuticals. Third, many of the information processing events in protein synthesis and mRNA splicing require RNA components. These RNAs may also be fulfilling a catalytic function.

RNAs Can Form Binding Sites for Other Molecules

Consideration of the RNA world has led to a new type of biological chemistry based on the large number of potential sequences (4^N) that would be made if A, C, G, or U were inserted randomly in each of N positions in a nucleic acid. A set of chemically synthesized, randomized, nucleic acid molecules 25 nucleotides long would contain $4^{25} = 10^{15}$ potential members. Individual molecules within this large collection of RNAs would be expected to fold into a similarly large collection of shapes. The large number of molecular shapes implies that some member of this collection will be capable of strong, specific binding to any ligand, much as group I introns bind guanosine nucleotides specifically. Though a single molecule would be too rare to study within the original population, the RNA capable of binding can be selected and preferentially replicated *in vitro*. In one case, for example, an RNA capable of distinguishing **theophylline** from **caffeine** was selected from a complex population (see

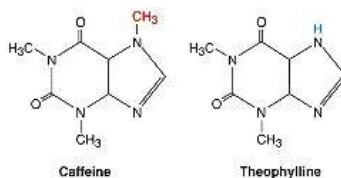

Figure 16.10

Structures of theophylline and caffeine.

Although these compounds differ only by a single methyl group, a specific synthetic RNA can bind to theophylline 10,000-fold more tightly than to caffeine.

Figure 16.10). Theophylline is used in the treatment of chronic asthma but the level must be carefully controlled to avoid side effects. The monitoring of theophylline by conventional antibody-based clinical chemistry is difficult because caffeine and theophylline differ only by a single methyl group. Therefore anti-theophylline antibodies show considerable cross-reaction with caffeine. RNA molecules have been found that bind theophylline 10,000-fold more tightly than caffeine.

Other extensions of the technology have used selection procedures to identify new, synthetic ribozymes and potential therapeutic RNAs.

16.4—

Mechanisms of Transcription

The Initial Process of RNA Synthesis Is Transcription

The process by which RNA chains are made from DNA templates is called **transcription**. All known transcription reactions take the following form:

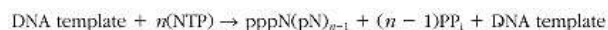

Enzymes that catalyze this reaction are designated RNA polymerases; it is important to recognize that they are absolutely template dependent. In contrast to DNA polymerases, however, **RNA polymerases** do not require a primer molecule. The energetics favoring the RNA polymerase reaction are twofold: first, the 5' α -nucleotide phosphate of the ribonucleoside triphosphate is converted from a phosphate anhydride to a phosphodiester bond with a change in free energy (ΔG) of approximately 3 kcal (12.5 kJ) mol^{-1} under standard conditions; second, the released pyrophosphate, PP_i , can be cleaved into two phosphates by pyrophosphatase so that its concentration is low and phosphodiester bond formation is more favored relative to standard conditions (see Chapter 6 for a fuller discussion of metabolic coupling).

Since a DNA template is required for RNA synthesis, eukaryotic transcription takes place in the cell nucleus or mitochondrial matrix. Within the nucleus, the *nucleolus* is the site of rRNA synthesis, whereas mRNA and tRNA are synthesized in the nucleoplasm. Prokaryotic transcription is accomplished on the cell's DNA, which is located in a relatively small region of the cell. In the case of prokaryotic plasmids, the DNA template need not be associated with the chromosome.

Structural changes occur in DNA during its transcription. In the polytene chromosomes of *Drosophila*, transcriptionally active genes are visualized in the light microscope as puffs distinct from the condensed, inactive chromatin. Furthermore, the nucleosome patterns of active genes are disrupted so that active chromatin is more accessible to, for example, DNase attack. In prokaryotes and eukaryotes, the DNA double helix is transiently opened (unwound) as the transcription complex proceeds down the DNA.

These openings and **unwindings** are a manifestation of a topological necessity. If the RNA chain were copied off DNA without this unwinding, the transcription complex and growing end of the RNA chain would have to wind around the double helix once every 10 base pairs as they travel from the beginning of the gene to its end. Such a process would wrap the newly synthesized RNA chain around the DNA double helix. Local opening and unwinding of the DNA solves this problem before it occurs by allowing transcription to proceed on a single face or side of the DNA. In addition, the opening of DNA base pairs during transcription allows Watson–Crick base pairing between template DNA and the bases in the newly synthesized RNA.

The process of transcription is divided into three parts: **initiation** refers to the recognition of an active gene starting point by RNA polymerase and the beginning of the bond formation process; **Elongation** is the actual synthesis of the RNA chain and is followed by chain **termination** and release.

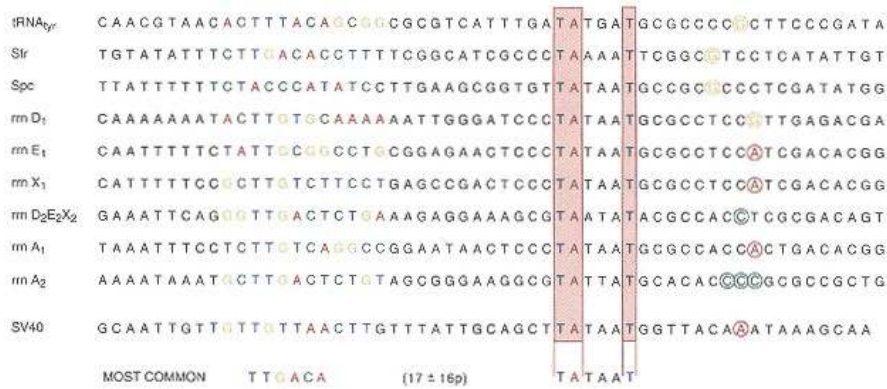

Figure 16.11

Determination of a consensus sequence for prokaryotic promoters.

A portion of the data set used for the identification of the consensus sequence for *E. coli* promoter activity. The -10 region (sometimes called the Pribnow box) is shaded in red and the -35 region nucleotides are colored.

Note that none of the individual promoters has the entire consensus sequence.

Modified from Rosenberg, M., and Court, D. *Ann. Rev. Genet.* 13:319, 1979.

The Template for RNA Synthesis Is DNA

Each cycle of transcription begins and ends with the recognition of specific sites in the DNA template. The DNA sequencing of a large number of transcription start regions, called **promoters**, has shown that certain **conserved sequences** occur in promoters with great regularity.

An example is shown in Figure 16.11. Similar considerations demonstrate that termination occurs at different conserved sequences. In addition, sites within a transcript may allow premature termination of transcription. These sites can act as molecular switches affecting the continuation of synthesis of an RNA molecule.

Conserved sequences near the transcription start are found for both prokaryotic and some eukaryotic promoters. In addition, eukaryotic transcription has been shown in some cases to be affected by **internal promoter** elements and other sequences called enhancers. **Enhancers** are gene-specific sequences that positively affect transcription. Enhancer sequences can stimulate transcription whether they are located at the beginning, in the middle, or at the end of a gene. An enhancer sequence must be on the same DNA strand as the transcribed gene (genetically in a *cis* position) but can function in either orientation. Cellular protein factors are known that specifically bind different enhancers. The most likely hypothesis is that protein factors bound to enhancers cause a structural change in the DNA template, allowing protein–protein interaction with other factors or with RNA polymerase itself. This interaction facilitates transcription.

RNA Polymerase Catalyzes the Transcription Process

RNA polymerases all synthesize RNA in the 5' → 3' direction using a DNA template; in this respect, they are similar to template-dependent DNA polymerases discussed in Chapter 15. Unlike DNA polymerases, however, RNA polymerases initiate polymerization at a promoter sequence without the need of a DNA

or RNA primer. Cellular RNA polymerases, both prokaryotic and eukaryotic, are large multisubunit enzymes whose mechanisms are only partially understood.

The most intensely studied prokaryotic RNA polymerase is that from *Escherichia coli*, which consists of five subunits having an aggregate molecular weight of over 500,000 (Table 16.2). Two α subunits, one β subunit, and one σ subunit constitute the **core enzyme**, which is capable of faithful transcription but not of specific (i.e., promoter-initiated) RNA synthesis. The addition of a fifth protein subunit, designated σ , results in the **holoenzyme** that is capable of specific RNA synthesis *in vitro* and *in vivo*. The logical conclusion, that σ is involved in the specific recognition of promoters, has been borne out by a variety of biochemical studies and is discussed below. Specific σ factors can recognize different classes of genes. For example, a specific σ factor recognizes promoters for genes that are induced as a result of heat shock. In sporulating bacteria, specific σ factors recognize genes induced during sporulation. Some bacteriophage synthesize σ factors that allow the appropriation of the cell's RNA polymerase for transcription of the viral DNA.

The common prokaryotic RNA polymerases are inhibited by the antibiotic **rifampicin** (used in treating tuberculosis), which binds to the β subunit (see Clin. Corr. 16.2). Eukaryotic nuclear RNA polymerases are inhibited differentially by the compound **α -amanitin**, which is synthesized by the poisonous mushroom *Amanita phalloides*. Three nuclear RNA polymerase classes can be distinguished by these experiments. Very low concentrations of α -amanitin inhibit the synthesis of mRNA and some small nuclear RNAs (snRNAs); higher concentrations inhibit the synthesis of tRNA and other snRNAs, whereas rRNA synthesis is not inhibited at these concentrations of drug. Messenger RNA synthesis is the function of **RNA polymerase II**. Synthesis of transfer RNA, 5sRNA, and some snRNAs are carried out by **RNA polymerase III**. Ribosomal RNA genes are transcribed by **RNA polymerase I**, which is concentrated in the nucleolus. (The numbers refer to the order of elution of the enzymes from a chromatography column.) Each enzyme is highly complex structurally (Table 16.2).

In addition, a mitochondrial RNA polymerase is responsible for the synthesis of this organelle's mRNA, tRNA, and rRNA species. This enzyme, like bacterial RNA polymerase, is inhibited by rifampicin.

TABLE 16.2 Comparative Properties of Some RNA Polymerases

	Nuclear			Mitochondrial	<i>E. coli</i>
	I (A)	II (B)	III (C)		
High MW subunits ^a	195–197	240–214	155	65	160 ()
	117–126	140	138		150 ()
Low MW subunits	61–51	41–34	89		86 ()
	49–44	29–25	70		40 ()
	29–25	27–20	53		10 ()
	19–16.5	19.5	49		
		19	41		
		16.5	32		
			29		
			19		
Variable forms	2–3 types	3–4 types	2–4 types	1	1
Specialization	Nucleolar; rRNA	mRNA	tRNA	All mtRNA	None
		Viral RNA	5S rRNA		
Inhibition by α -amanitin	Insensitive (>1 mg mL ⁻¹)	Very sensitive (10 ⁻⁹ –10 ⁻⁸ M)	Sensitive (10 ⁻⁵ –10 ⁻⁴ M)	Insensitive, but sensitive to rifampicin	Rifampicin sensitive

^a Molecular weight $\times 10^{-3}$.

CLINICAL CORRELATION 16.2**Antibiotics and Toxins That Target RNA Polymerase**

RNA polymerase is obviously an essential enzyme for life since transcription is the first step of gene expression. No RNA polymerase means no enzymes. Two natural products point out this principle; in both cases inhibition of RNA polymerase leads to death of the organism.

The "death cap" or "destroying angel" mushroom, *Amanita phalloides*, is highly poisonous and still causes several deaths each year despite widespread warnings to amateur mushroom hunters (it is reputed to taste delicious, incidentally). The most lethal toxin, α -amanitin, inhibits the largest subunit of eukaryotic RNA polymerase II, thereby inhibiting mRNA synthesis. The course of the poisoning is twofold: initial, relatively mild, gastrointestinal symptoms are followed about 48 h later by massive liver failure as essential mRNAs and their proteins are degraded but not replaced by newly synthesized molecules. The only therapy is supportive, including liver transplantation; but this latter course is clearly a desperate measure of unproven efficacy.

More benign (at least from the point of view of our own species) is the action of the antibiotic rifampicin to inhibit the RNA polymerases of a variety of bacteria, most notably in the treatment of tuberculosis. *Mycobacterium tuberculosis*, the causative agent, is insensitive to many commonly used antibiotics, but it is sensitive to rifampicin, the product of a soil streptomycetes. Since mammalian RNA polymerase is so different from the prokaryotic variety, inhibition of the latter enzyme is possible without great toxicity to the host. This consideration implies a good therapeutic index for the drug, that is, the ability to treat a disease without causing undue harm to the patient. Together with improved public health measures, antibiotic therapy with rifampicin and isoniazid (an anti-metabolite) has greatly reduced the morbidity due to tuberculosis in industrialized countries. Unfortunately, the disease is still endemic in impoverished populations in the United States and in other countries. Furthermore, in increasing numbers, immunocompromised individuals, especially AIDS patients, have active tuberculosis.

Mitchel, D. H. *Amanita* mushroom poisoning. *Annu. Rev. Med.* 31:51, 1980; Gilman, A. G., Rall, T. W., Nies, A. S., and Taylor, P. (Eds.). *The Pharmacological Basis of Therapeutics*, 8th ed. New York: Pergamon Press, 1990, pp. 129–130; DeCock, K. M., Soro, B., Colibaly, I. M., Lucas, S. B. Tuberculosis and HIV infection in sub-Saharan Africa. *JAMA* 268:1581, 1992.

The Steps of Transcription in Prokaryotes Have Been Determined

Transcription is a strand-selective process; most double helical DNA is transcribed in only one direction. This is illustrated as follows:

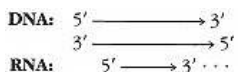

The DNA strand that serves as the template for RNA synthesis is sometimes called the sense strand because it is complementary to the RNA transcript. Conventionally, the *sense strand* is usually the "bottom" strand of a double-stranded DNA as written. The other strand, the "top" strand, has the same direction as the transcript when read in the 5' → 3' direction; this strand is sometimes (confusingly) called the *antisense strand*. When only a single DNA sequence is given in this book, the antisense strand is represented. Its sequence can be converted to the RNA transcript of a gene by simply substituting U (uracil) for T (thymine) bases. Prokaryotic transcription begins with the binding of RNA polymerase to a gene's promoter (Figures 16.11 and 16.12). RNA polymerase holoenzyme binds to one face of the DNA extending 45 bp or so upstream and 10 bp downstream from the RNA initiation site. Two short oligonucleotide sequences in this region are highly conserved. One sequence that is located about 10 bp upstream from the transcription start is the consensus sequence (sometimes called a Pribnow box):

T*A*TAAT*

The positions marked with an asterisk are the most conserved; indeed, the last T residue is always found in *E. coli* promoters.

A second consensus sequence is located upstream from the **Pribnow** or "–10" box. This "–35 sequence"

T*T*G*ACA

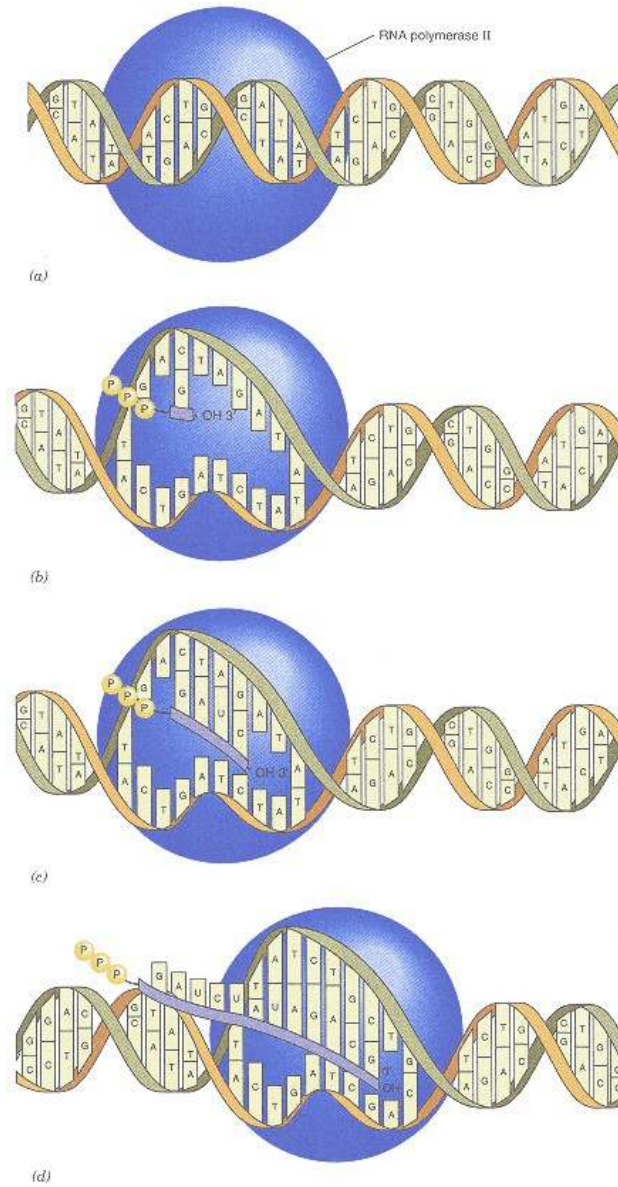

Figure 16.12

Early events in prokaryotic transcription.

- (a) Recognition: RNA polymerase (drawn smaller than scale) with "sigma" factor binds to a DNA promoter region in a "closed" conformation.
- (b) Initiation: The complex is converted to an "open" conformation and the first nucleoside triphosphate aligns with the DNA.
- (c) Bond formation: The first phosphodiester bond is formed and the "sigma" factor released.
- (d) Elongation: Synthesis of nascent RNA proceeds with movement of the RNA polymerase along the DNA. The double helix reforms.

is centered about 35 bp upstream from the transcription start; the nucleotides with asterisks are most conserved. The spacing between the -35 and -10 sequences is crucial with 17 bp being highly conserved. As shown in Figure 16.13, the TTGACA and TATAAT sequences are asymmetrical, that is, they do not have the same sequence if the complementary sequence is read. Thus the promoter sequence itself determines that transcription will proceed in only one direction. What difference do the consensus sequences make to a gene? Measurements of RNA polymerase binding affinity and initiation efficiency to

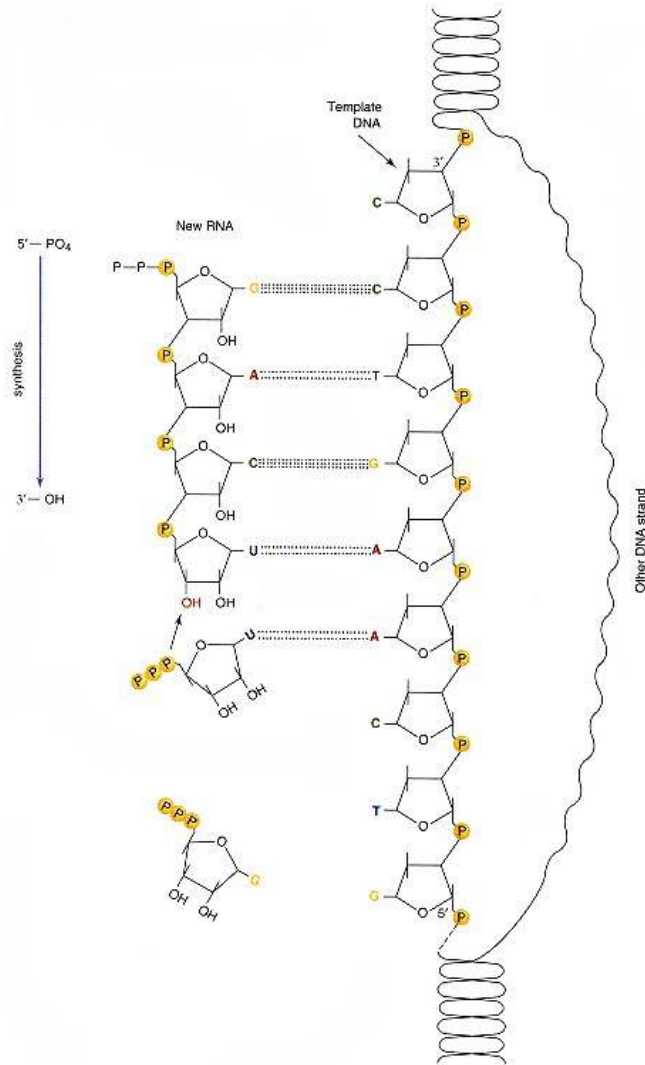

Figure 16.13

Biosynthesis of RNA showing asymmetry in transcription.

Nucleoside 5-triphosphates align with complementary bases on one DNA strand, the template. RNA polymerase catalyzes the formation of the 3,5-phosphodiester links by attaching the 5-phosphate of the incoming nucleotide to the 3-OH group of the growing nascent RNA releasing P_i . The new RNA is synthesized from its 5 end toward the 3 end.

various promoter sequences have shown that the most active promoters fit the consensus sequences most closely. Statistical measurements of promoter homology conform closely to the measured "strength" of a promoter, that is, its kinetic ability to initiate transcription with -35 purified RNA polymerase.

Bases flanking the -35 and -10 sequences, bases near the transcription start, and bases located near the -16 position are weakly conserved. In some of these weakly conserved regions, RNA polymerase may require that a particular nucleotide not be present or that local variations in DNA helical structure be present.

Promoters for *E. coli* heat shock genes have different consensus sequences at the -35 and -10 homologies. This is consistent with their being recognized by a different factor.

An RNA transcript usually starts with a purine riboside triphosphate; that is, pppG \cdots or pppA \cdots , but pyrimidine starts are also known (Figures 16.11 and 16.12). The position of transcription initiation differs slightly among various promoters but usually is from five to eight base pairs downstream from the invariant T of the Pribnow box.

Initiation

Two kinetically distinct steps are required for RNA polymerase to initiate the synthesis of an RNA transcript. In the first step, RNA polymerase holoenzyme binds to the promoter DNA to form a "**closed complex**." In the second step, the holoenzyme forms a more tightly bound "**open complex**," which is characterized by a local opening of about 10 bp of the DNA double helix. Since the consensus Pribnow box is A-T rich, it can facilitate this local unwinding. As discussed in Chapter 14, opening 10 bp of DNA is topologically equivalent to the relaxation of a single negative supercoil. As might be predicted from this observation, the activity of some promoters depends on the superhelical state of the DNA template; some promoters are more active on highly supercoiled DNA while others are more active when the superhelical density of the template is lower. The unwound DNA binds the initiating triphosphate and RNA polymerase then forms the first phosphodiester bond. The enzyme translocates to the next position (this is the rifampicin-inhibited step) and continues synthesis. At or a short time after the initial bond formation, σ factor is released and the enzyme is considered to be in an elongation mode. Other RNA polymerase molecules can now bind to the promoter so that a gene can be transcribed many times (Figure 16.14).

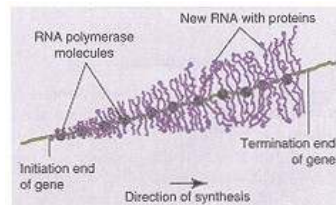

Figure 16.14
Simultaneous transcription of a gene by many RNA polymerases, depicting the increasing length of nascent RNA molecules. Courtesy of Dr. O. L. Miller, University of Virginia. Reproduced with permission from Miller, O. L., and Beatty, B. R. *J. Cell Physiol.* 74:225, 1969.

Elongation

RNA polymerase continues the binding–bond formation–translocation cycle at a rate of about 40 nucleotides per second. This rate is only an average, however, and there are many examples known for which RNA polymerase pauses or slows down at particular sequences, usually inverted repeats (palindrome sequence of nucleotides). As will be discussed below, these pauses can bring about transcription termination.

As RNA polymerase continues down the double helix, it continues to separate the two strands of the DNA template. As seen in Figure 16.12, this process allows the template (sense) strand of the DNA to base pair with the growing RNA chain. Thus a single mechanism of information transfer (Watson–Crick base pairing) serves several processes: DNA replication, DNA repair, and transcription of genetic information into RNA. (As will be seen in Chapter 17, base pairing is essential for translation as well.) The process of unwinding and restoring the DNA double helix is aided by DNA topoisomerases I and II, which are components of the transcription complex.

Changes in the transcription complex during the elongation phase can affect subsequent termination events. These changes depend on the binding of another cellular protein (nusA protein) to core RNA polymerase. Failure to

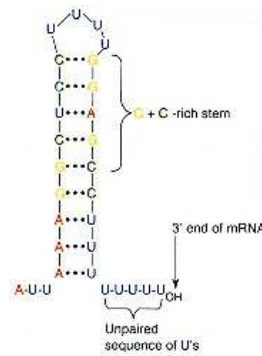

Figure 16.15
The stem-loop structure of the RNA transcript that determines rho-independent transcriptional termination.
 Note the two components of the structure: the G + C-rich stem and loop, followed by a sequence of U residues.

bind sometimes results in an increased frequency of termination and, consequently, a reduced level of gene expression.

Termination

The RNA polymerase complex also recognizes the ends of genes (Figure 16.15). Transcription termination can occur in either of two modes, depending on whether or not it is dependent on the protein factor rho. Terminators are thus classified as rho independent or rho dependent.

Rho-independent terminators are better characterized (Figure 16.15). A consensus-type sequence is involved here: a G-C rich palindrome (inverted repeat) precedes a sequence of 6–7 U residues in the RNA chain. As a result the RNA chain forms a stem and loop structure preceding the U residues. The secondary structure of the stem and loop is crucial for termination; base change mutations in the stem and loop that disrupt pairing also reduce termination. Furthermore, the most efficient terminators are the most G-C rich and therefore most stable. The terminator stem and loop stabilize prokaryotic mRNA against nucleolytic degradation.

Rho-dependent terminators are less well defined. Rho factor is a hexameric protein possessing an essential RNA-dependent ATPase activity. The sequences of rho-dependent termination sites feature regularly spaced C residues within a relatively unstructured length of the transcript. The nascent RNA is thought to wrap around rho factor while ATP hydrolysis leads to dissociation of the transcript from the template.

Prokaryotic ribosomes usually attach to the nascent mRNA while it is being transcribed. This coupling between transcription and translation is important in gene control by *attenuation*, which is discussed in Chapter 19.

Transcription in Eukaryotes Involves Many Additional Molecular Events

Eukaryotic transcription is considerably more complex than the process in prokaryotes. While the information specifying a promoter is still carried in a DNA sequence, several molecular events besides RNA polymerase binding are required for transcription initiation. First, chromatin containing the promoter sequence must be spatially accessible to the transcription machinery. Second, protein **transcription factors** distinct from RNA polymerase must bind to sequences in the promoter region for a gene to be active. Third, other sequences located some distance away from the promoter affect transcription; these sequences are termed **enhancers** and they, too, bind protein factors to stimulate transcription. Finally, recall that the eukaryotic RNA polymerase consists of three distinct enzyme forms, each specific form capable of transcribing only a

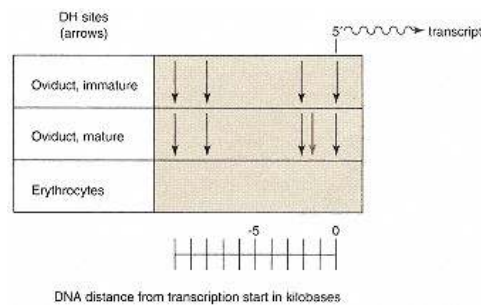

Figure 16.16
DNase-hypersensitive (DH) sites upstream of the promoter for the chick lysozyme gene, a typical eukaryotic transcriptional unit.
 Hypersensitive sites, that is, sequences around the lysozyme gene where nucleosomes are not bound to the DNA, are indicated by arrows. Note that some hypersensitive sites are found in the lysozyme promoter whether the oviduct is synthesizing or not synthesizing lysozyme; the synthesis of lysozyme is accompanied by the opening up of a new hypersensitive site in mature oviduct. In contrast, no hypersensitive sites are present in nucleated erythrocytes that never synthesize lysozyme.

Adapted from Elgin, S. C. R. *J. Biol. Chem.*
 263:1925, 1988.

CLINICAL CORRELATION 16.3

Fragile X Syndrome: A Chromatin Disease?

Fragile X syndrome is the single most common form of inherited mental retardation, affecting 1/1250 males and 1/2000 females. A variety of anatomical and neurological symptoms result from the inactivation of the FMR1 gene, located on the X chromosome. The genetics of the syndrome are complex due to the molecular mechanism of the Fragile X mutation.

The Fragile X condition results from the expansion of a trinucleotide repeat sequence, CCG, found at the 5'-untranslated region of the FMR1 gene. Normally, this repeat is present in 30 copies, although normal individuals can have up to 200 copies of the repeat. In individuals with Fragile X syndrome, the FMR1 gene contains many more copies, from 200 to thousands, of the CCG repeat. The complex genetics of the disease result from the potential of the CCG repeat sequence to expand from generation to generation.

The presence of an abnormally high number of CCG repeats induces extensive DNA methylation of the entire promoter region of FMR1. Methylated DNA is transcriptionally inactive, so FMR1 mRNA is not synthesized. The absence of FMR1 protein leads to the pathology of the disease.

FMR1 protein normally is located in the cytoplasm in all tissues of the early fetus and, later, especially in the fetal brain. Its sequence has some characteristics of an RNA-binding protein. One hypothesis is that the protein aids in the translation of brain-specific mRNAs during development.

Warren, S. L., and Nelson, D. L. Advances in molecular analysis of Fragile X syndrome. *JAMA* 271:536, 1994; and Caskey, C. T. Triple repeat mutations in human disease. *Science* 256:784, 1992.

single class of cellular RNA. By contrast, transcription in prokaryotes requires, in the simplest case, only an appropriate sequence of DNA, RNA polymerase holoenzyme, and nucleoside triphosphate substrates.

The Nature of Active Chromatin

The structural organization of eukaryotic chromosomes was discussed in Chapter 14. Although chromatin is organized into **nucleosomes** whether or not it is capable of being transcribed, an active gene has a generally "looser" configuration than does transcriptionally inactive chromatin. This difference is most striking in the promoter sequences, parts of which are not organized into nucleosomes at all (Figure 16.16). The lack of nucleosomes is manifested experimentally by the enhanced sensitivity of promoter sequences to external reagents that cleave DNA, such as the enzyme DNase I. This enhanced accessibility of promoter sequences (termed **DNase I hypersensitivity**) ensures that transcriptional factors will be able to bind to appropriate regulatory sequences. In addition, although the transcribed parts of a gene may be organized into nucleosomes, the nucleosomes are less tightly bound than those in an inactive gene. Finally, DNA may be transcriptionally inactivated by methylation (see Clin. Corr. 16.3). The overall theme is one of partially unfolded chromatin being necessary but not sufficient for transcription.

Enhancers

Enhancer sequences increase (enhance) the expression of a gene about 100-fold, hence the name. They function only when located on the same DNA molecule (chromosome) as the promoter whose activity they affect. They can function when located in either the 5' or 3' direction and as much as 1000 bp away from the relevant promoter. Protein factors bind to enhancer DNA and are necessary for enhancer function.

Transcription of Ribosomal RNA Genes

Recall that rRNA genes are located in a specialized nuclear structure, the nucleolus. There are several hundred copies of each rRNA gene in a eukaryotic cell, tandemly repeated in the DNA of a specific region of one chromosome, the **nucleolar organizer**. The repeat units contain a copy of each RNA sequence (28S, 5.8S, and 18S) and are separated from each other by **nontranscribed spacer regions**. Figure 16.17 is a diagram of this arrangement. Each repeat unit is transcribed as a unit, yielding a primary transcript containing one copy each of the 28S, 5.8S, and 18S sequences, ensuring synthesis of equimolar amounts of these three RNAs. The primary transcript is then processed by ribonucleases and modifying enzymes to the three mature rRNA species (see Section 16.5). Termination of transcription occurs within the nontranscribed spacer region before RNA polymerase I reaches the promoter of the next repeat unit.

The promoter recognized by RNA polymerase I is located within the non-transcribed spacer, from about positions -40 to +10 and from -150 to -110. A transcription factor binds to the promoter and thereby directs RNA polymerase

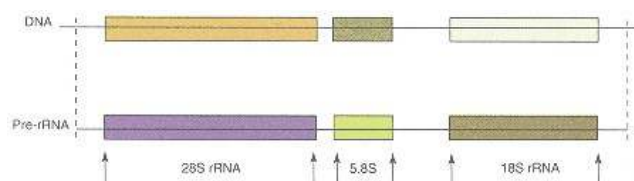

Figure 16.17

Structure of a rRNA transcription unit.

Ribosomal RNA genes are arranged with many copies one after another. Each copy is transcribed separately and each transcript is processed into three separate RNA species. Promoter and enhancer sequences are located in the nontranscribed regions of the tandemly repeated sequences.

recognition of the promoter sequence. In addition, an enhancer element is located about 250 bp upstream from the promoter in human ribosomal DNA. The size of the nontranscribed spacer varies considerably from one organism to the next, as does the position of the enhancer element.

Transcription of rRNA can be very rapid; this reflects the fact that synthesis of ribosomes is rate-limiting for cell growth. Phosphorylation of RNA polymerase I may activate especially rapid transcription of rRNA, for example, during embryonic growth or liver regeneration.

Transcription by RNA Polymerase II

RNA polymerase II is responsible for the synthesis of mRNA in the nucleus. Three common themes have emerged from research on a large number of genes (Figure 16.18). (1) The DNA sequences controlling transcription are complex; a single gene may be controlled by as many as six or eight DNA sequence elements in addition to the promoter (RNA polymerase binding region) itself. The controlling sequence elements function in combination to give a finely tuned pattern of control. (2) The effect of the controlling sequences on transcription is mediated by the binding of protein molecules to each sequence element. These transcription factors recognize the nucleotide sequence of the appropriate controlling sequence element. (3) Bound transcription factors bind with each other and with RNA polymerase to activate transcription. The DNA binding and activation activities of the factors reside in separate domains of the proteins.

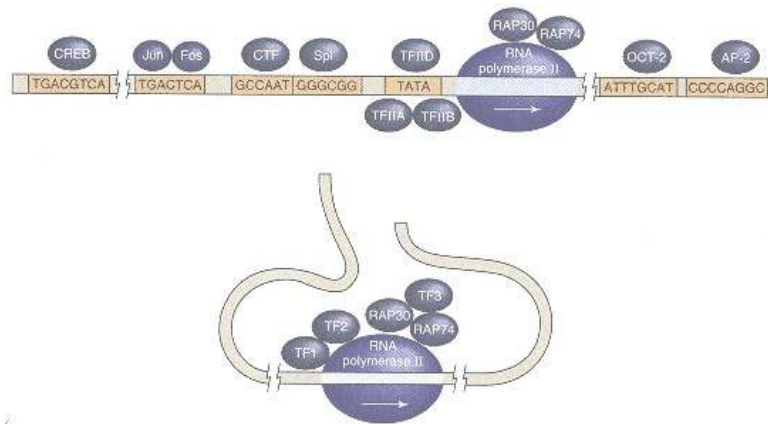

Figure 16.18

Interaction of transcription factors with promoters.

A large number of transcriptional factors interact with eukaryotic promoter regions.

(a) A hypothetical array of factors that interact with specific DNA sequences near the promoter.

This includes a factor, TFIID, which binds to the TATA box and the Jun and Fos proteins, which are proto-oncogenes (Clin. Corr. 16.4). The figure is not meant to imply that all of the DNA binding factors bind to the promoter simultaneously.

(b) One way in which the DNA binding factors are hypothesized to bind to each other and to RNA polymerase. Although this model is not completely proved, it is known that proteins that bind to distant DNA sequences make protein–protein contacts with each other.

Reprinted with permission from Mitchell, P. J., and Tjian, R. *Science* 245:371, 1989.

Promoters for mRNA Synthesis

In contrast to prokaryotic RNA polymerase which recognizes only a single promoter sequence, RNA polymerase II can initiate transcription by recognizing several classes of consensus sequences upstream from the mRNA start site. The first and most prominent of these, sometimes called the **TATA box**, has the sequence

```

      A A
TATA A
      T T
  
```

The TATA box is centered about 25 bp upstream from the transcription unit. Experiments in which it was deleted suggest that it is required for efficient transcription, although some promoters may lack it entirely.

A second region of homology is located further upstream, in which the **CAAT box** sequence

```

      T
GG CAATCT
      C
  
```

is found. This sequence is not as highly conserved as the TATA box, and some active promoters may not possess it. Other sequences, described in Figure 16.18, may also promote transcription. The CAAT and TATA boxes, as well as the other sequences shown in Figure 16.15, do not contact RNA polymerase II directly. Rather, they require the binding of specific transcription factors to function. The current model for the **activation of genes** in this manner is shown in Figure 16.18. Note how protein factors bind not only to their recognition sequences but also to each other and to RNA polymerase, itself a very large and complex enzyme. Despite the complexities of the detailed interactions, the three principles elaborated above account for the known mechanisms of all class II transcription factors. Mutated forms of several of these transcription factors function as nuclear oncogenes (see Clin. Corr. 16.4).

Transcription by RNA Polymerase III

The themes elaborated above for the transcription of class I and class II promoters hold for the transcription of 5S RNA and tRNA by RNA polymerase III. Transcription factors bind to DNA and direct the action of RNA polymerase. One unusual feature of RNA polymerase III action in the transcription of 5S RNA is the location of the factor-binding sequence; it can be located within the DNA sequence encoding the RNA. The DNA in the region that would normally be thought of as a promoter, that is, the sequence immediately 5' to the transcribed region of the gene, has no specific sequence and can be substituted by other sequences without a substantial effect on transcription. Figure 16.19 diagrams this unusual sequence arrangement. In other cases, for example, tRNA transcription, the factor-binding sequence is located more conventionally at the 5' region of the gene, that is, preceding the transcribed sequences.

16.5—

Posttranscriptional Processing

The immediate product of transcription is a **precursor RNA molecule**, called the **primary transcript**, which is modified to a mature, functional molecule. The reactions of RNA processing can include removal of extra nucleotides, base modification, addition of nucleotides, and separation of different RNA sequences by the action of specific nucleases. Finally, in eukaryotes, RNAs must be exported from the nucleus.

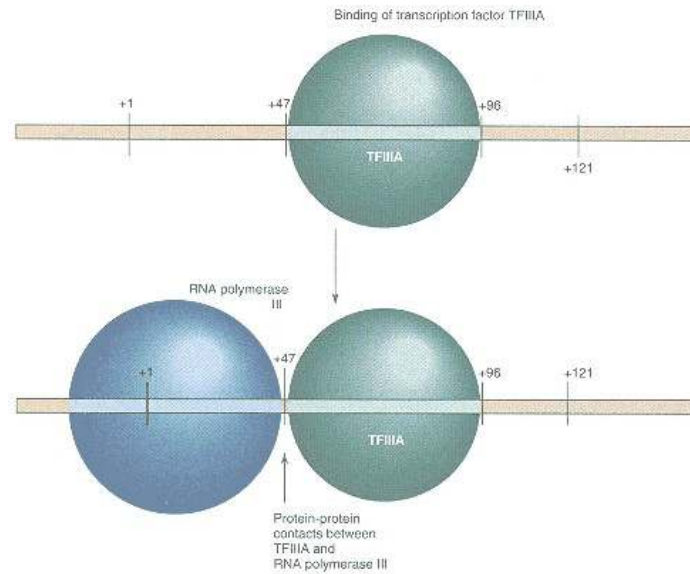

Figure 16.19

Transcription factor for a class III eukaryotic gene.

The transcription factor TFIIIA binds to a sequence located within the *Xenopus* gene for 5S rRNA. The RNA polymerase III then binds to the factor and initiates transcription of the 5S sequence. No specific sequence in the DNA is required other than the factor binding sequence.

Transfer RNA Precursors Are Modified by Cleavage, Additions, and Base Modification

Cleavage

The primary transcript of a tRNA gene contains extra nucleotide sequences both 5' and 3' to the tRNA sequence. In some cases these primary transcripts contain introns in the anticodon region of the tRNA also. Processing reactions occur in a closely defined but not necessarily rigid temporal order. First, the primary transcript is trimmed in a relatively nonspecific manner to yield a precursor molecule with shorter 5' and 3' extensions. Then ribonuclease P, a ribozyme (see above), removes the 5' extension by endonucleolytic cleavage. The 3' end is trimmed exonucleolytically, followed by synthesis of the CCA terminus. Synthesis of the modified nucleotides occurs in any order relative to the nucleolytic trimming. **Intron removal** is dictated by the secondary structure of the precursor (see Figure 16.20, p. 702) and is carried out by a soluble, two-component enzyme system; one enzyme removes the intron and the other reseals the nucleotide chain.

Additions

Each functional tRNA has the sequence CCA at its 3' terminus. In most instances this sequence is added sequentially by the enzyme **tRNA nucleotidyltransfer-**

CLINICAL CORRELATION 16.4**Involvement of Transcriptional Factors in Carcinogenesis**

The conversion of a normally well-regulated cell into a cancerous one requires a number of independent steps whose end result is a transformed cell capable of uncontrolled growth and metastasis. Insights into this process have come from recombinant DNA studies of the genes whose mutated or overexpressed products contribute to carcinogenesis. These genes are termed oncogenes. Oncogenes were first identified as products of DNA or RNA tumor viruses but normal cells have copies of these genes as well. The normal, nonmutated cellular analogs of oncogenes are termed proto-oncogenes. The products of proto-oncogenes are components of the many pathways that regulate growth and differentiation of a normal cell; mutation into an oncogenic form involves a change that makes the regulatory product less responsive to normal control.

Some proto-oncogenic products are involved in the transduction of hormonal signals or the recognition of cellular growth factors and act cytoplasmically. Other proto-oncogenes have a nuclear site of action; their gene products are often associated with the transcriptional apparatus and they are synthesized in response to growth stimuli. It is easy to visualize how the overproduction or permanent activation of such a positive transcription factor could aid the transformation of a cell to malignancy: genes normally transcribed at a low or controlled level would be overexpressed by such a deranged control mechanism.

A more subtle genetic effect predisposing to cancer is exemplified by the human tumor suppressor protein p53. This protein is the product of a dominant oncogene. A single copy of the mutant gene causes Li–Fraumeni syndrome, an inherited condition predisposing to carcinomas of the breast and adrenal cortex, sarcomas, leukemia, and brain tumors.

Somatic mutations in p53 can be identified in about half of all human cancers. Mutations represent a loss of function, affecting either the stability or DNA-binding ability of p53. Thus wild-type p53 functions as a tumor suppressor. The wild-type protein helps to control the checkpoint between the G1 and S phases of the cell cycle, activates DNA repair, and, in other circumstances, leads to programmed cell death (apoptosis). Thus the biochemical actions of p53 serve to keep cell growth regulated, maintain the information content of the genome, and, finally, eliminate damaged cells. All of these functions would counteract neoplastic transformation of a cell.

These varied roles are a function of p53's action as a transcription factor, inhibiting some genes and activating others. For example, p53 inhibits transcription of genes with TATA sequences, perhaps by binding to the complex formed between transcription factors and the TATA sequence. Alternatively, p53 is a site-specific DNA-binding protein and promotes transcription of some other genes, for example, those for DNA repair.

The three-dimensional structure of p53 has been determined. Mutations found in p53 from tumors affect the DNA-binding domain of the protein. For example, nearly 20% of all mutated residues involve mutations at two positions in p53. The crystal structure of the protein–DNA complex shows that these two amino acids, both arginines, form hydrogen bonds with DNA. Arginine 248 forms hydrogen bonds in the minor groove of the DNA helix with a thymine oxygen and with a ring nitrogen of adenine. Mutation disrupts this H-bonded network and therefore the ability of p53 to regulate transcription.

Weinberg, R. A. Oncogenes, antioncogenes, and the molecular basis of multistep carcinogenesis. *Cancer Res.* 49:3713, 1989; Cho, Y., Gorina, S., Jeffrey, P. D., and Pavletich, N. P. Crystal structure of a p53 tumor suppressor–DNA complex: understanding tumorigenic mutations. *Science* 265:346, 1994; Friend, S. p53: A glimpse at the puppet behind the shadow play. *Science* 265:334, 1994; and Harris, C. C., and Hollstein, M. Clinical implications of the p53 tumor-suppressor gene. *N. Engl. J. Med.* 329:1318, 1993.

ase. Nucleotidyltransferase uses ATP and CTP as substrates and always incorporates them into tRNA at a ratio of 2C/1A. The CCA ends are found on both cytoplasmic and mitochondrial tRNAs.

Modified Nucleosides

Transfer RNA nucleotides are the most highly modified of all nucleic acids. More than 60 different modifications to the bases and ribose, requiring well over 100 different enzymatic reactions, have been found in tRNA. Many are simple, one-step methylations, but others involve multistep synthesis. Two derivatives, **pseudouridine** and **queosine** (7–4, 5-*cis*-dihydroxy-1-cyclopenten-3-ylamino methyl-7-deazaguanosine), actually require severing of the β -glycosidic bond of the altered nucleotide. One enzyme or set of enzymes produces a single site-specific modification in more than one species of tRNA molecule. Separate enzymes or sets of enzymes produce the same modifications at more than one location in tRNA. In other words, most modification enzymes are site or nucleotide sequence specific, not tRNA specific. Most modifications are completed before the tRNA precursors have been cleaved to mature tRNA size.

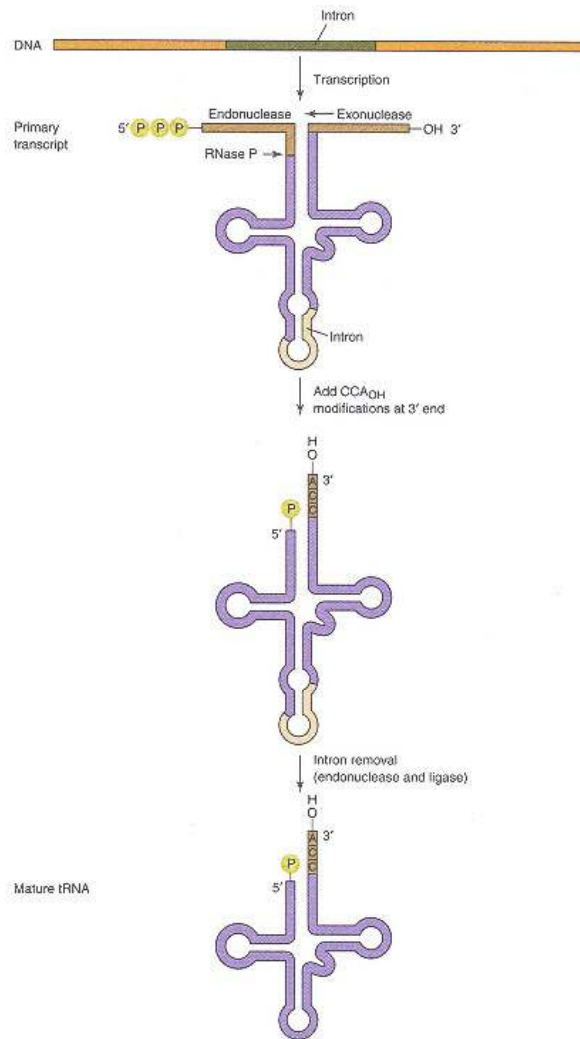

Figure 16.20
Scheme for processing a eukaryotic tRNA.
 The primary transcript is cleaved by RNase P and a 3'-exonuclease, and the terminal CCA is synthesized by tRNA nucleotidyltransferase before the intron is removed, if necessary.

Ribosomal RNA Processing Releases the Various RNAs from a Longer Precursor

The primary product of rRNA transcription is a long RNA, termed 45S RNA, which contains the sequences of 28S, 5.8S, and 18S rRNAs. Processing of 45S RNA occurs in the nucleolus. Like the processing of mRNA precursors (see below), processing of the rRNA precursors is carried out by large multisubunit ribonucleoprotein assemblies. At least three RNA species are required for processing. These all function as **small nucleolar ribonucleoprotein complexes** (snoRNPs). Processing of the rRNAs follows a sequential order (Figure 16.21).

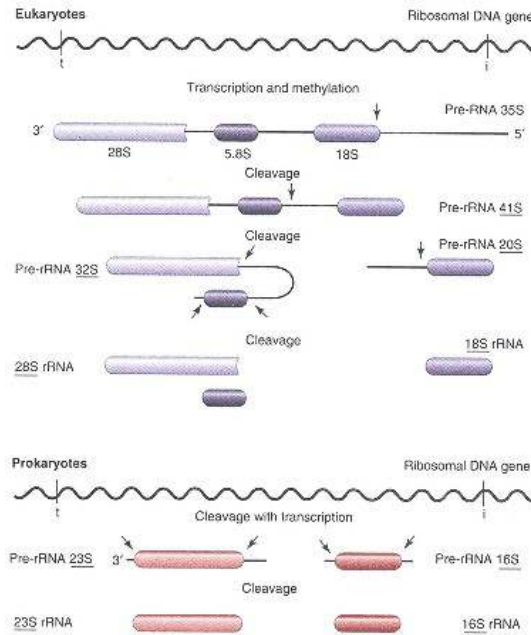

Figure 16.21
Schemes for transcription and processing of rRNAs.
 Redrawn from Perry, R. *Annu. Rev. Biochem.* 45:611, 1976.
 Copyright © 1976 by Annual Reviews, Inc.

Processing of pre-rRNA in prokaryotes also involves cleavage of high molecular weight precursors to smaller molecules (see Figure 16.21). Some of the bases are modified by methylation on the ring nitrogens of the bases rather than the ribose and by the formation of pseudouridine. The *E. coli* genome has seven rRNA transcriptional units dispersed throughout the DNA. Each contains one 16S, one 23S, and one 5S rRNA or tRNA sequence. Processing of the rRNA is coupled directly to transcription, so that cleavage of a large precursor primary transcript rapidly yields pre-16S, pre-23S, pre-5S, and pre-tRNAs. These precursors are slightly larger than the functional molecules and only require trimming for maturation.

Messenger RNA Processing Requires Maintenance of the Coding Sequence

Most eukaryotic mRNAs have distinctive structural features added in the nucleus by enzyme systems other than RNA polymerase. These include the 3'-terminal poly (A) tail, methylated internal nucleotides, and the cap 5' terminus. Cytoplasmic mRNAs are shorter than their primary transcripts, which can contain additional terminal and internal sequences. Noncoding sequences present within pre-mRNA molecules, but not present in mature mRNAs, are called **intervening sequences** or **introns**. The **expressed** or **retained sequences** are called **exons**. The general pattern for mRNA processing is depicted in Figure 16.22. Incompletely processed mRNAs make up a large part of the heterogeneous nuclear RNA (hnRNA).

Processing of eukaryotic pre-mRNA involves a number of molecular reactions, all of which must be carried out with exact fidelity. This principle is most clear in the removal of introns from an mRNA transcript. An extra nucleotide in the coding sequence of mature mRNA would cause the reading frame of

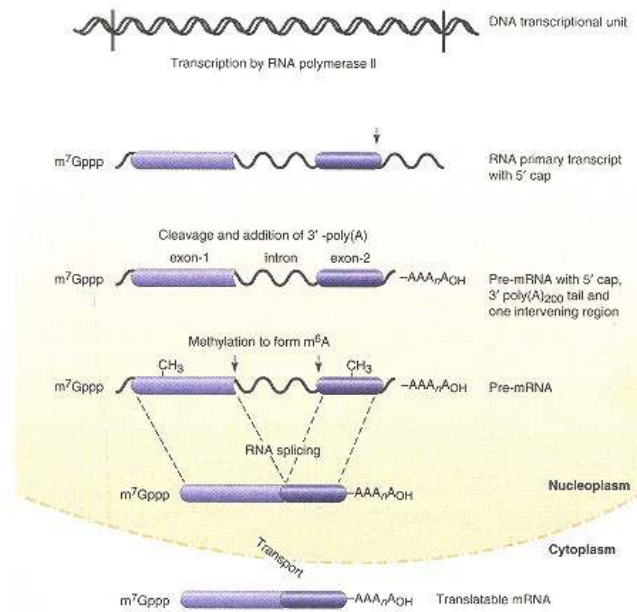

Figure 16.22

Scheme for processing mRNA.

The points for initiation and termination of transcription are indicated on the DNA. Arrows indicate cleavage points. The many proteins associated with the RNA and tertiary conformations are not shown.

that message to be shifted and the resulting protein will almost certainly be nonfunctional. Indeed, mutations in the β -globin gene that interfere with intron removal are a major cause of the genetic disease **β -thalassemia** (see Clin. Corr. 16.5). The task for the cell becomes even more daunting when seen in the light of the structure of some important human genes that consist of over 90% intron sequences. The complex reactions to remove introns are accomplished by multicomponent enzyme systems that act in the nucleus; after these reactions are completed the mRNA is exported to the cytoplasm where it interacts with ribosomes to initiate translation.

Blocking of the 5' Terminus and Poly(A) Synthesis

Addition of the **cap structures** occurs during transcription by RNA polymerase II (Figure 16.22). As the transcription complex moves along the DNA, the capping enzyme complex modifies the 5' end of the nascent mRNA. This is the only eukaryotic pre-mRNA processing event that is known to occur cotranscriptionally, that is, while RNA polymerase is still transcribing the downstream portions of the gene.

After initiation and cap synthesis, RNA polymerase continues transcribing the gene until a **polyadenylation signal sequence** is reached (Figure 16.23). This sequence, which has the consensus AAUAAA, appears in the mature mRNA but usually does not form part of its coding region. Rather, it signals cleavage of the nascent mRNA precursor about 20 or so nucleotides downstream. The poly(A) sequence is then added by a soluble polymerase to the free 3' end produced by this cleavage. Note that polyadenylation does not require a template. Somewhat paradoxically, RNA polymerase II continues transcription for as many as 1000 nucleotides beyond the point at which the transcript is released from chromatin. Nucleotides incorporated into RNA by this process are apparently turned over and never appear in any cytoplasmic RNA species.

CLINICAL CORRELATION 16.5

Thalassemia Due to Defects in Messenger RNA Synthesis

The thalassemias are genetic defects in the coordinated synthesis of α - and β -globin peptide chains; a deficiency of β chains is termed β -thalassemia while a deficiency of α chains is termed α -thalassemia. Patients suffering from either of these conditions present with anemia at about 6 months of age as HbF synthesis ceases and HbA synthesis would become predominant. The severity of symptoms leads to the classification of the disease into either thalassemia major, where a severe deficiency of globin synthesis occurs, or thalassemia minor, representing a less severe imbalance. Occasionally, an intermediate form is seen. Therapy for thalassemia major involves frequent transfusions, leading to a risk of complications from iron overload. Unless chelation therapy is successful, the deposition of iron in peripheral tissues, termed hemosiderosis, can lead to death before adulthood. Carriers of the disease usually have thalassemia minor, involving mild anemia. Ethnographically, the disease is common in persons of Mediterranean, Arabian, and East Asian descent. As is the case for sickle cell anemia (HbS) and glucose 6-phosphate dehydrogenase deficiency, the abnormality of the carriers' erythrocytes affords some protection from malaria. Maps of the regions where one or another of these diseases is frequent in the native population superimpose over the areas of the world where malaria is endemic.

α -Thalassemia is usually due to a genetic deletion, which can occur because the α -globin genes are duplicated; unequal crossing over between adjacent α alleles apparently has led to the loss of one or more loci. In contrast, β -thalassemia can result from a wide variety of mutations. Known events include mutations leading to frameshifts in the β -globin coding sequence, as well as mutations leading to premature termination of peptide synthesis. Many β -thalassemias result from mutations affecting the biosynthesis of β -globin mRNA. Genetic defects are known that affect the promoter of the gene, leading to inefficient transcription. Other mutations result in aberrant processing of the nascent transcript, either during splicing out of the two introns from the transcript or during polyadenylation of the mRNA precursor. Examples where the molecular defect illustrates a general principle of mRNA synthesis are discussed in the text.

Orkin, S. H. Disorders of hemoglobin synthesis: the thalassemias. In: G. Stamatoyannopoulos, A. W. Nienhuis, P. Leder, and P. W. Majerus (Eds.). *The Molecular Basis of Blood Diseases* Philadelphia: Saunders, 1987; and Weatherall, D. J., Clegg, J. B., Higgs, D. R., and Wood, W. G. The hemoglobinopathies. In: C. R. Scriver, A. L. Beaudet, W. S. Sly, and D. Valle (Eds.). *The Metabolic and Molecular Bases of Inherited Disease*, 7th ed. New York: McGraw-Hill, 1995.

Removal of Introns from mRNA Precursors

As pre-mRNA is extruded from the RNA polymerase complex, it is rapidly bound by **small nuclear ribonucleoproteins, snRNPs** (snurps), which carry out the dual steps of **RNA splicing**: (1) breakage of the intron at the 5' donor site and (2) joining the upstream and downstream exon sequences together. All introns begin with a GU sequence and end with AG; these are termed the donor and acceptor intron-exon junctions, respectively. Not all GU or AG sequences are spliced out of RNA, however. How does the cell know which GU sequences are in introns (and therefore must be removed) and which are destined to remain in mature mRNA? This discrimination is accomplished by the formation of base pairs between **U1 RNA** and the sequence of the mRNA precursor surrounding the donor GU sequence (see Clin. Corr. 16.6). See Figure 16.24 for an illustration of this process. Another snRNP, containing **U2 RNA**, recognizes

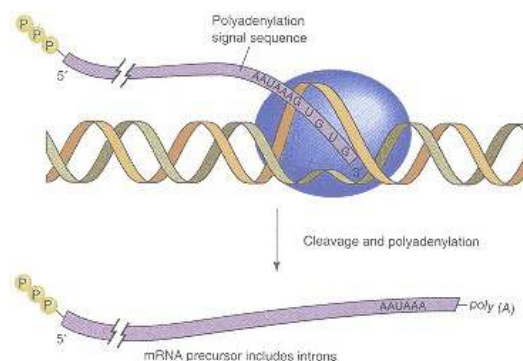

Figure 16.23

Cleavage and polyadenylation of eukaryotic mRNA precursors.

The 3' termini of eukaryotic mRNA species are derived by processing. The sequence AAUAAA in the mRNA specifies the cleavage of the mRNA precursor. The free 3'-OH end of the mRNA is a primer for poly(A) synthesis.

Adapted from Proudfoot, N. J. *Trends Biochem. Sci.* 14:105, 1989

CLINICAL CORRELATION 16.6

Autoimmunity in Connective Tissue Disease

Humoral antibodies in sera of patients with various connective tissue diseases recognize a variety of ribonucleoprotein complexes. Patients with systemic lupus erythematosus exhibit a serum antibody activity designated Sm, and those with mixed connective tissue disease exhibit an antibody designated RNP. Each antibody recognizes a distinct site on the same RNA–protein complex, U1 RNP, that is involved in mRNA processing in mammalian cells. The U1–RNP complex contains U1 RNA, a 165-nucleotide sequence highly conserved among eukaryotes, that at its 5' terminus includes a sequence complementary to intron–exon splice junctions. Addition of this antibody to *in vitro* splicing assays inhibits splicing, presumably by removal of the U1 RNP from the reaction. Sera from patients with other connective tissue diseases recognize different nuclear antigens, nucleolar proteins, and/or chromosomal centromeres. Sera of patients with myositis have been shown to recognize cytoplasmic antigens such as aminoacyl-tRNA synthetases. Although humoral antibodies have been reported to enter cells via Fc receptors, there is no evidence that this is part of the mechanism of autoimmune disease.

important sequences at the 3' acceptor end of the intron. Still other snRNP species, among them U5 and U6, then bind to the RNA precursor, forming a large complex termed a **spliceosome** (by analogy with the large ribonucleoprotein assembly involved in protein synthesis, the ribosome). The spliceosome uses ATP energy to carry out the accurate removal of the intron. First, the phosphodiester bond between the exon and the donor GU sequence is broken, leaving a free 3'-OH group at the end of the first exon and a 5' phosphate on the donor G of the intron. This pG is then used to form an unusual linkage with the 2'-OH group of an adenosine within the intron to form a branched or **lariat RNA** structure, as shown in Figure 16.25. After the lariat is formed, the second step of splicing occurs. The phosphodiester bond immediately following the AG is cleaved and the two exon sequences are ligated together. In pre-mRNAs containing a large number of introns, splicing occurs roughly in order from the 5' to the 3' end of the mRNA precursor. However, this is not a hard and fast rule as there is no singly preferred order for removal. The end result of processing is a fully functional coding mRNA, all introns removed, and ready to direct protein synthesis.

Mutations in Splicing Signals Cause Human Diseases

Messenger RNA splicing is an intricate process dependent on many molecular events. If these events are not carried out with precision, functional mRNA is not produced. This principle is illustrated in the human thalassemias, which affect the balanced synthesis of α and β -globin chains (see Clin. Corr. 16.5). Some of the mutations leading to **β -thalassemia** interfere with the splicing of β -globin mRNA precursors. For example, we know that all intron sequences begin with the dinucleotide GU. Mutation of the G in this sequence to an A means that the splicing machinery will no longer recognize this dinucleotide as a donor site. Splicing will "pass by" the correct exon–intron junction. This could lead to two results: extra sequences that would normally be spliced out will appear in the β -globin mRNA, or, alternatively, sequences could be deleted from the mRNA product (Figure 16.26). In either event, functional β -globin will be made in reduced amounts and the anemia characteristic of the disease will result.

Alternate pre-mRNA Splicing Can Lead to Multiple Proteins Being Made from a Single DNA Coding Sequence

The existence of intron sequences is paradoxical. Introns must be removed precisely so that the mRNA can accurately encode a protein. As we have seen above, a single base mutation can drastically interfere with splicing and cause a serious disease. Furthermore, the presence of intron sequences in a gene means that its overall sequence is much larger than is required to encode its

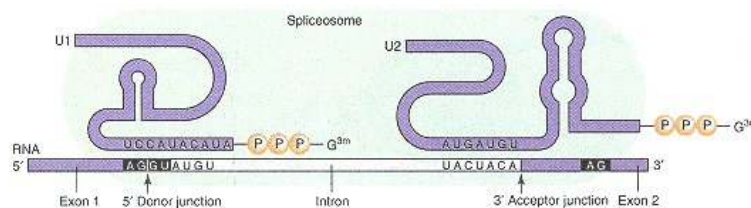

Figure 16.24

Mechanism of splice junction recognition.

The recognition of the 5' splice junction involves base pairing between the intron–exon junction and the U1 RNA snRNP. This base pairing targets the intron for removal.

Adapted from Sharp, P. A. *JAMA* 260:3035, 1988.

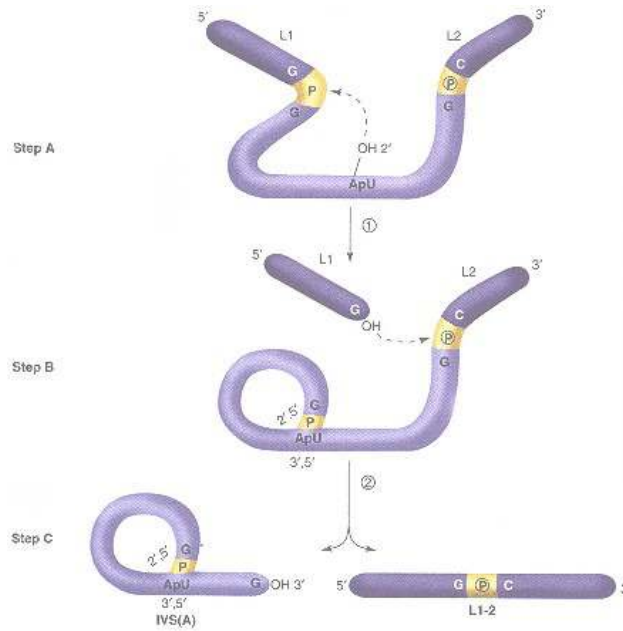

Figure 16.25

Proposed scheme for mRNA splicing to include the lariat structure.

A messenger RNA is depicted with two exons (in dark blue) and an intervening intron (in light blue). A 2-OH group of the intron sequence reacts with the 5-phosphate of the intron's 5-terminal nucleotide producing a 2-5 linkage and the lariat structure. Simultaneously, the exon 1-intron phosphodiester bond is broken, leaving a 3-OH terminus on this exon free to react with the 5-phosphate of the exon 2, displacing the intron and creating the spliced mRNA. The released intron lariat is subsequently digested by cellular nucleases.

protein product. A large gene is a target for more mutagenic events than is a small one. Indeed, common human genetic diseases like Duchenne muscular dystrophy occur in genes that encompass millions of base pairs of DNA information. Why has nature not removed introns completely over the long time scale of eukaryotic evolution? There are no clear answers to questions of this type but some introns do have beneficial effects.

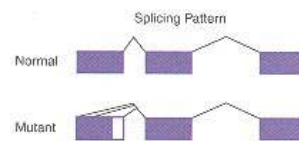

Figure 16.26

Nucleotide change at an intron-exon junction of the human β -globin gene, which leads to aberrant splicing and β -thalassemia.

This figure shows the splicing pattern of a mutated transcript containing a change of G-U to A-U at the first two nucleotides of the first intron. Loss of this invariant sequence means that the correct splice junction cannot be used; therefore transcript sequences that base pair with the U1 snRNA less well than the correct sequence junction are used as splice donors. The diagonal lines indicate the portions spliced together in mutant transcripts. Note that some of the mutant mRNA precursor molecules are spliced so that portions of the first intron (denoted as a white box) appear in the processed product. In other instances the donor junction lies within the first exon and portions of the first exon are deleted. In no case is wild-type globin mRNA produced.

Adapted from Orkin, S. H. In: G. Stamatoyannopoulos et al. (Eds.). *The Molecular Basis of Blood Diseases*. Philadelphia: Saunders, 1987.

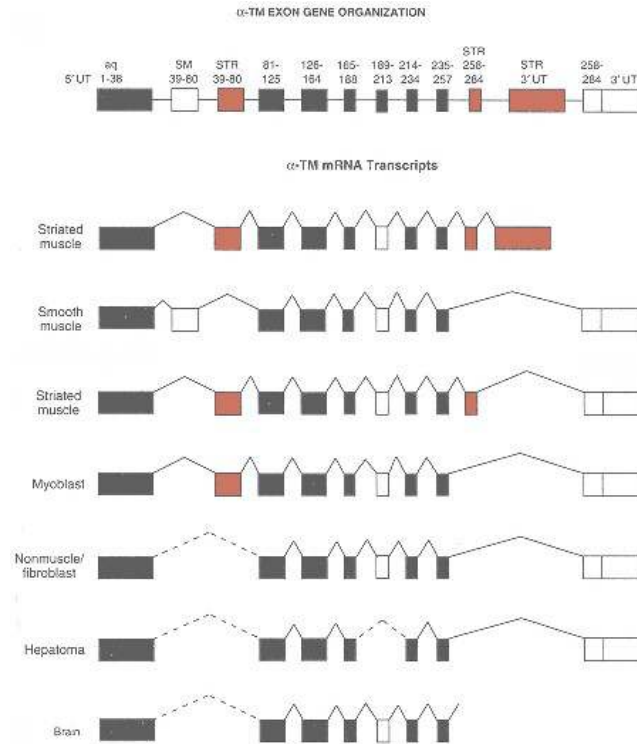

Figure 16.27
Alternate splicing of tropomyosin gene transcripts results in a family
of tissue-specific tropomyosin proteins.

Redrawn from Breitbart, R. E., Andreadis, A., and Nadal-Ginard, B. *Annu. Rev. Biochem.* 56:467, 1986.

Tropomyosin proteins are essential components of the contractile apparatus in the three types of muscle (see, p. 948) and each contractile cell type contains a specific tropomyosin type. This diversity arises from a single gene that is transcribed into a primary transcript. The transcript is then processed as diagramed in Figure 16.27. All cells containing tropomyosin make the same primary transcript but each cell type processes this transcript in a characteristic fashion. The resulting mRNA species then are translated to yield the tropomyosins characteristic of each cell type. About 40 examples are well documented of tissue-specific splicing. Thus the existence of introns supplies the organism with still another method of generating protein diversity.

16.6— Nucleases and RNA Turnover

The different roles of RNA and DNA in genetic expression are reflected in their metabolic fates. A cell's information store (DNA) must be preserved, thus the myriad DNA repair and editing systems in the nucleus. Although individual stretches of nucleotides in DNA may turn over, the molecule as a whole is metabolically inert when not replicating. The various RNA molecules, on the other hand, are individually dispensable and can be replaced by newly synthe-

sized species of the same specificity. It is therefore no surprise that RNA repair systems are not known. Instead, defective RNAs are removed from the cell by degradation into nucleotides, which then are repolymerized into new RNA species.

This principle is clearest for mRNA species, which are classified as unstable. However, even the so-called stable RNAs turn over; for example, the half-life of tRNA species in liver is on the order of 5 days. A fairly long half-life for a mammalian mRNA would be 30 h. Removal of RNAs from the cytoplasm is accomplished by cellular **ribonucleases**. Messenger RNAs are initially degraded in the cytoplasm. The rates vary for different mRNA species, raising the possibility of control by differential degradation.

Two examples of the role of RNA stability in gene control illustrate how the stability of mRNA influences gene expression. **Tubulin** is the major component of the microtubules found in many cell types as part of the cytoskeleton. When there is an excess of tubulin in the cell, the monomeric protein binds to and promotes the degradation of tubulin mRNA, thereby reducing tubulin synthesis. A second example is provided by **herpes simplex viruses** (HSV), the agent causing cold sores and some genital infections. An early event in the establishment of HSV infection is the ability of the virus to destabilize all the cellular mRNA molecules, thereby reducing the competition for free ribosomes. Thus the viral proteins are more efficiently translated.

Nucleases are of several types and specificities. The most useful distinction is between **exonucleases**, which degrade RNA from either the 5' or 3' end, and **endonucleases**, which cleave phosphodiester bonds within a molecule. The products of RNase action contain either 3' or 5' terminal phosphates, and both endo- and exonucleases can be further characterized by the position (5' or 3') at which the monophosphate created by the cleavage is located.

The structure of RNA also affects nuclease action. Most ribonucleases are less efficient on regions of highly ordered RNA structure. Thus tRNAs are preferentially cleaved in unpaired regions of the sequence. On the other hand, many RNases involved in RNA processing require a defined three-dimensional structure for enzyme activity. These enzymes are discussed more fully above in the consideration of RNA processing pathways.

Bibliography

- Bradshaw, R. A. (Ed.). Transcription. Special issue of *Trends Biochem. Sci.* 16, November, 1991.
- Breitbart, R. E., Andreadis, A., and Nadal-Ginard, B. Alternative splicing: A ubiquitous mechanism for the generation of multiple protein isoforms from single genes. *Annu. Rev. Biochem.* 56:467, 1987.
- Caskey, C.T. Triple repeat mutations in human disease. *Science* 256:784, 1992.
- Cundliffe, E. How antibiotic-producing microorganisms avoid suicide. *Annu. Rev. Microbiol.* 43:207, 1989.
- Das, A. Control of transcription by RNA-binding proteins. *Annu. Rev. Biochem.* 62:893, 1993.
- Friend, S. p53: A glimpse at the puppet behind the shadow play. *Science* 265:334, 1994.
- Gesteland, R. F., and Atkins, J. F. (Eds.). *The RNA World*. Cold Spring Harbor: Cold Spring Harbor Laboratory Press, 1993.
- Gold, L., Polisky, B., Uhlenbeck, O., and Yarus, M. Diversity of oligonucleotide functions. *Annu. Rev. Biochem.* 64:763, 1995.
- Koleske, A. J., and Young, R. A. The RNA polymerase II holoenzyme and its implications for gene regulation. *Trends Biochem. Sci.* 20:113, 1995.
- Lai, M. M. C. The molecular biology of hepatitis delta virus. *Annu. Rev. Biochem.* 64:259, 1995.
- Larson, D. E., Zahradka, P., and Sells, B. H. Control points in eucaryotic ribosome biogenesis. *Biochem. Cell. Biol.* 69:5, 1991.
- Orkin, S. H. Disorders of hemoglobin synthesis: The thalassemias. In: G. Stamatoyannopoulos, A. W. Nienhuis, P. Leder, and P. W. Majerus (Eds.), *The Molecular Basis of Blood Diseases*. Philadelphia: Saunders, 1987, pp. 106–126.
- Pace, N. R., and Brown, J. W. Evolutionary perspective on the structure and function of ribonuclease P, a ribozyme. *J. Bacteriol.* 177:1919, 1995.
- Rosenberg, M., and Court, D. Regulatory sequences involved in the promotion and termination of RNA transcription. *Annu. Rev. Genet.* 12:319, 1979.
- Soll, D., and Rajbhandary, U. L. (Eds.). *tRNA: Structure, Biosynthesis and Function*. Washington DC: American Society for Microbiology, 1994.
- Weatherall, D.J., Clegg, J.B., Higgs, D.R., and Wood, W.G. The hemoglobinopathies. In: C. R. Scriver, A. L. Beaudet, W. S. Sly, and D. Valle (Eds.), *The Metabolic and Molecular Bases of Inherited Disease*, 7th ed. New York: McGraw-Hill, 1995.
- Weinberg, R. A. Oncogenes, antioncogenes and the molecular basis of multistep carcinogenesis. *Cancer Res.* 49:3713, 1989.
- Wise, J. A. Guides to the heart of the spliceosome. *Science* 262:1978, 1993.

Questions

C. N. Angstadt and J. Baggott

1. RNA:

- A. incorporates both modified and unmodified purine and pyrimidine bases during transcription.
- B. does not exhibit any double helical structure.
- C. structures exhibit base stacking and hydrogen-bonded base pairing.
- D. usually contains about 65–100 nucleotides.
- E. does not exhibit Watson–Crick base pairing.

Refer to the following for Questions 2–4.

- A. HnRNA
- B. mRNA
- C. rRNA
- D. snRNA
- E. tRNA

2. Has the highest percentage of modified bases of any RNA.

3. Stable RNA representing the largest percentage by weight of cellular RNA.

4. Contains both a 7-methylguanosine triphosphate cap and a poly-adenylate segment.

5. Ribozymes:

- A. are any ribonucleoprotein particles.
- B. are enzymes whose catalytic function resides in RNA subunits.
- C. carry out self-processing reactions but cannot be considered true catalysts.
- D. bind to the mRNA precursor to recognize the 5'-splice site for intron removal.
- E. function only in the processing of mRNA.

6. In eukaryotic transcription:

- A. RNA polymerase does not require a template.
- B. all RNA is synthesized in the nucleolus.
- C. consensus sequences are the only known promoter elements.
- D. phosphodiester bond formation is favored, in part, because it is followed by pyrophosphate hydrolysis.
- E. RNA polymerase requires a primer.

7. An enhancer:

- A. is a consensus sequence in DNA located where RNA polymerase first binds.
- B. may be located in various places in different genes.
- C. may be located on a separate chromosome from the gene it regulates.
- D. functions by binding RNA polymerase.
- E. stimulates transcription in both prokaryotes and eukaryotes.

8. The sigma (σ) subunit of prokaryotic RNA polymerase:

- A. is part of the core enzyme.
- B. binds the antibiotic rifampicin.
- C. is inhibited by α -amanitin.
- D. must be present for transcription to occur.
- E. specifically recognizes promoter sites.

Use this schematic representation of a prokaryotic gene to answer Questions 9–11. Numbers refer to positions of base pairs relative to the beginning of transcription.

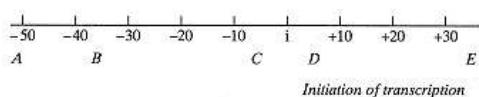

9. Sigma (σ) factor might be released from RNA polymerase.

10. An "open complex" should form in this region.

11. Events beyond this region should be catalyzed by core enzyme.

12. Termination of a prokaryotic transcript:

- A. is a random process.
- B. requires the presence of the rho subunit of the holoenzyme.
- C. does not require rho factor if the end of the gene contains a G-C rich palindrome.
- D. is most efficient if there is an A-T rich segment at the end of the gene.
- E. requires an ATPase in addition to rho factor.

13. Eukaryotic transcription:

- A. is independent of the presence of consensus sequences upstream from the start of transcription.
- B. may involve a promoter located within the region transcribed rather than upstream.
- C. requires a separate promoter region for each of the three ribosomal RNAs transcribed.
- D. requires that the entire gene be in the nucleosome form of chromatin.
- E. is affected by enhancer sequences only if they are adjacent to the promoter.

14. All of the following are correct about a primary transcript in eukaryotes EXCEPT it:

- A. is usually longer than the functional RNA.
- B. may contain nucleotide sequences that are not present in functional RNA.
- C. will contain no modified bases.
- D. usually contains information for more than one RNA molecule.
- E. contains a TATA box.

15. The processing of transfer RNA involves all of the following EXCEPT:

- A. addition of a methylated guanosine at the 5' end.
- B. cleavage of extra bases from both the 3' and 5' ends.
- C. nucleotide sequence-specific methylation of bases.
- D. addition of the sequence CCA by a nucleotidyl transferase.
- E. sometimes, removal of intron from the anticodon region.

16. Cleavage and splicing:

- A. are features of ribosomal RNA processing.
- B. always occur in the same way for a given primary transcript.
- C. remove noninformational sequences occurring anywhere within a primary transcript.
- D. are usually the first events in mRNA processing.
- E. are catalyzed by enzymes that recognize and remove specific introns.

17. In the cellular degradation of RNA:

- A. any of the nucleotides released may be recycled.
- B. regions of extensive base pairing are more susceptible to cleavage.
- C. endonucleases may cleave the molecule starting at either the 5' or 3' end.
- D. the products are nucleotides with a phosphate at either the 3' - or 5' -OH group.
- E. all species except rRNA are cleaved.

Answers

1. C Stacking stabilizes the single-stranded helix. A: Only the four bases A, G, U, and C are incorporated during transcription. B and C: Although single stranded, RNA exhibits considerable secondary and tertiary structure. D: Only tRNA would be this small; sizes can range to more than 6000 nucleotides. E: This occurs in the intrachain helical regions (pp. 679–680).
2. E Modified bases seem to be very important in the three-dimensional structure of tRNA (p. 683).
3. C Stability of rRNA is necessary for repeated functioning of ribosomes (p. 683).
4. B These are important additions during processing that yield a functional eukaryotic mRNA (p. 685, Table 16.1).
5. B A: Ribozymes are a very specific type of particle. C: One of the four classes, RNase P, catalyzes a cleavage reaction. D: This is the function of one of the snRNPs, several of which binding to mRNA result in a spliceosome. E: Ribozymes have been implicated in the processing of ribosomal and tRNAs (p. 686).
6. D This is an important mechanism for driving reactions. A and B: Transcription is directed by the genetic code, generating rRNA precursors in the nucleolus and mRNA and tRNA precursors in nucleoplasm. C: Eukaryotic transcription may have internal promoter regions as well as enhancers. E: This is a difference from DNA polymerase (p. 689).
7. B B and C: Enhancer sequences seem to work whether they are at the beginning or end of the gene, but they must be on the same DNA strand as the transcribed gene. D: They seem to function by binding proteins which themselves bind RNA polymerase (p. 697).
8. E A, D, and E: Sigma factor is required for correct initiation and dissociates from the core enzyme after the first bonds have been formed. Core enzyme can transcribe but cannot correctly initiate transcription. B and C: Rifampicin binds to the β subunit, and α -amanitin is an inhibitor of eukaryotic polymerases (p. 691).
9. D Sigma factor is released when, or a short time after, the initial bond is formed.
10. C The high A-T content of the Pribnow box is believed to facilitate initial unwinding.
11. E Elongation, which requires only the core enzyme, is well underway in this region (p. 695, Figure 16.2).
12. C A, B, and E: There is a rho-dependent as well as a rho-independent process. Rho is a separate protein from RNA polymerase and appears to possess ATPase activity (p. 696). C and D: Rho-independent termination involves secondary structure, which is stabilized by high G-C content.
13. B RNA polymerase III uses an internal promoter. A: RNA polymerase II activity involves the TATA and CAAT boxes. C: RNA polymerase I produces one transcript, which is later processed to yield three rRNAs. D: Parts of the promoter are not in a nucleosome. E: Enhancers may be as much as 1000 bp away (pp. 696–697).
14. E The TATA box is part of the promoter, which is not transcribed. A–D: Modification of bases, cleavage, and splicing are all important events in posttranscriptional processing to form functional molecules (pp. 700–707).
15. A Capping is a feature of mRNA. B: The primary transcript is longer than the functional molecule. C: The same modifications, catalyzed by a certain (set of) enzyme(s), occurs at more than one location. D: This is a posttranscriptional modification (pp. 700–701).
16. C A: Cleavage occurs, but splicing does not. B: Alternate splicing leads to different proteins from a single gene. D: Splicing occurs after other events. E: Specificity of cleavage is related to specific sequences at the intron-exon junctions, not to the sequence of the intron itself (pp. 702–707).
17. D A: Modified bases cannot be recycled. B: Although some enzymes of maturation may require an ordered structure, degradative enzymes are less efficient on an ordered structure. C: An endonuclease cleaves an interior phosphodiester bond. E: Even rRNA turns over although it is more stable than the other species (p. 709).

**Chapter 17—
Protein Synthesis:
Translation and Posttranslational Modifications**

Dohn Glitz

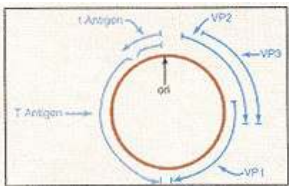

17.1 Overview	714
17.2 Components of the Translational Apparatus	714
Messenger RNA Is the Carrier of Information Present in DNA	714
Ribosomes Are Workbenches for Protein Biosynthesis	715
Transfer RNA Acts As a Bilingual Translator Molecule	717
The Genetic Code Uses a Four-Letter Alphabet of Nucleotides	718
Codons in mRNA Are Three-Letter Words	718
Punctuation	719
Codon–Anticodon Interactions Permit Reading of mRNA	719
"Breaking" the Genetic Code	720
Mutations	721
Aminoacylation of Transfer RNA Activates Amino Acids for Protein Synthesis	721
Specificity and Fidelity of Aminoacylation Reactions	722
17.3 Protein Biosynthesis	724
Translation Is Directional and Colinear with mRNA	724
Initiation of Protein Synthesis Is a Complex Process	725
Elongation Is the Stepwise Formation of Peptide Bonds	727
Termination of Polypeptide Synthesis Requires a Stop Codon	733
Translation Has Significant Energy Cost	733
Protein Synthesis in Mitochondria Differs Slightly	733
Some Antibiotics and Toxins Inhibit Protein Biosynthesis	733
17.4 Protein Maturation: Modification, Secretion, and Targeting	735
Proteins for Export Follow the Secretory Pathway	735
Glycosylation of Proteins Occurs in the Endoplasmic Reticulum and Golgi Apparatus	736
17.5 Organelle Targeting and Biogenesis	739
Sorting of Proteins Targeted for Lysosomes Occurs in the Secretory Pathway	739
Import of Proteins by Mitochondria Requires Specific Signals	742
Targeting to Other Organelles Requires Specific Signals	742
17.6 Further Posttranslational Protein Modifications	743
Insulin Biosynthesis Involves Partial Proteolysis	743
Proteolysis Leads to Zymogen Activation	743
Amino Acids Can Be Modified after Incorporation into Proteins	744
Collagen Biosynthesis Requires Many Posttranslational Modifications	746
Procollagen Formation in the Endoplasmic Reticulum and Golgi Apparatus	746
Collagen Maturation	747
17.7 Regulation of Translation	748
17.8 Protein Degradation and Turnover	750
Intracellular Digestion of Some Proteins Occurs in Lysosomes	750
Ubiquitin Is a Marker in ATP-Dependent Proteolysis	751
Bibliography	753
Questions and Answers	754
Clinical Correlations	
17.1 Missense Mutation: Hemoglobin	721
17.2 Disorders of Terminator Codons	722
17.3 Thalassemia	722
17.4 Mutation in Mitochondrial Ribosomal RNA Results in Antibiotic-Induced Deafness	734
17.5 I-Cell Disease	740
17.6 Familial Hyperproinsulinemia	743
17.7 Absence of Posttranslational Modification: Multiple Sulfatase Deficiency	746
17.8 Defects in Collagen Synthesis	749
17.9 Deletion of a Codon, Incorrect Posttranslational Modification, and Premature Protein Degradation: Cystic Fibrosis	752

17.1—

Overview

Protein biosynthesis is also called **translation** since it involves the biochemical translation of information from the four-letter language and structure of nucleic acids into the 20-letter language and structure of proteins. This process has many requirements: an informational messenger RNA molecule that is exported from the nucleus, several "bilingual" transfer RNA species that read the message, ribosomes that serve as catalytic and organizational centers, a variety of protein factors, and energy. Polypeptides are formed by the sequential addition of amino acids in the specific order determined by the information carried in the nucleotide sequence of the mRNA. The protein is often then matured or processed by a variety of modifications. These may target it to a specific intracellular location or for secretion from the cell, or they may modulate its activity or function. These complex processes are carried out with considerable speed and extreme precision. Levels of translation are regulated, both globally and for specific proteins. Finally, when a protein becomes nonfunctional or is no longer needed, it is degraded and its amino acids are catabolized or recycled into new proteins.

Cells vary in their need and ability to synthesize proteins. At one extreme, terminally differentiated red blood cells have a life span of about 120 days, have no nuclei, do not divide, and do not synthesize proteins because they lack the components of the biosynthetic apparatus. Nondividing cells need to maintain levels of enzymes and other proteins and carry out limited protein synthesis. Growing and dividing cells must synthesize much larger amounts of protein. Finally, some cells synthesize proteins for export as well as for their own use. For example, liver cells synthesize large numbers of enzymes needed for their many metabolic pathways as well as proteins for export, including serum albumin, the major protein of blood plasma or serum. Liver cells are protein factories that are particularly rich in the machinery for synthesis of proteins.

17.2—

Components of the Translational Apparatus*Messenger RNA Is the Carrier of Information Present in DNA*

Genetic information is stored and transmitted in the nucleotide sequences of DNA. Selective expression of this information requires its transcription into mRNA that carries specific and precise messages from the nuclear "data bank" to the cytoplasmic sites of protein synthesis. In eukaryotes, the messengers, mRNAs, are usually synthesized as significantly larger precursor molecules that are processed prior to export from the nucleus. Eukaryotic mRNA in the cytosol has several identifying characteristics. It is almost always **monocistronic**, that is, encoding a single polypeptide. The 5' end is capped with a specific structure consisting of 7-**methylguanosine** linked through a 5'-triphosphate bridge to the 5' end of the messenger sequence (see p. 704). A 5'-nontranslated region, which may be short or up to a few hundred nucleotides in length, separates the cap from the **translational initiation signal**, an **AUG** codon. Usually, but not always, this is the first AUG sequence encountered as the message is read 5' → 3'. Uninterrupted sequences that specify a unique polypeptide sequence follow the initiation signal until a specific translation termination signal is reached. This is followed by a 3'-untranslated sequence, usually about 100 nucleotides in length, before the mRNA is terminated by a 100- to 200-nucleotide long polyadenylate tail.

Prokaryotic mRNA differs from eukaryotic mRNA in that the 5' terminus is not capped but retains a terminal triphosphate from initiation of its synthesis by RNA polymerase. Also, most messengers are **polycistronic**, that is, encoding several polypeptides, and include more than one initiation AUG sequence. A

ribosome-positioning sequence is located about 10 nucleotides upstream of a valid AUG initiation signal. An untranslated sequence follows the termination signal, but there is no polyadenylate tail.

Ribosomes Are Workbenches for Protein Biosynthesis

Proteins are assembled on particles called ribosomes. These have two dissimilar subunits, each of which contains RNA and many proteins. With one exception, each protein is present in a single copy per ribosome, as is each RNA species. The composition of major ribosome types is shown in Table 17.1, and characteristics of their RNAs are given in Table 16.1.

Ribosome architecture has been conserved in evolution. The similarities between ribosomes and subunits from different sources are more obvious than the differences, and functional roles for each subunit are well defined. Details of ribosome structure and its relationship to function have been learned using many techniques. Overall size and shape can be determined by electron microscopy. The location of many ribosomal proteins, some elements of the RNA, and functional sites on each subunit have been determined by electron microscopy of subunits that are complexed with antibodies against a single ribosomal component. The antibody molecule serves as a physical pointer to the site on the ribosome. Further structural information has been obtained from chemical cross-linking, which identifies near neighbors within the structure, and from neutron diffraction measurements, which quantitate the distances between pairs of proteins. Ribosomes have been crystallized and X-ray structural determination is under way. Sequence comparisons and chemical, immunological, and enzymatic probes give information about RNA conformation. Correlations of structural data with functional measurements in protein synthesis have allowed development of models, such as that in Figure 17.1, that link ribosome morphology to various functions in translation. Each subunit has an RNA core, folded into a specific three-dimensional structure, upon which proteins are positioned through protein–RNA and protein–protein interactions.

Many of these experiments were possible because prokaryotic ribosomes can **self-assemble**; that is, the native structures can be reconstituted from mixtures of purified individual proteins and RNAs. Reconstitution of subunits

TABLE 17.1 Ribosome Classification and Composition

<i>Ribosome Source</i>	<i>Subunits</i>		
	<i>Monomer Size</i>	<i>Small</i>	<i>Large</i>
Eukaryotes			
Cytosol	80S	40S:	60S:
		34 proteins	50 proteins
		18S RNA	28S, 5.8S, 5S RNAs
Mitochondria			
Animals	55S–60S	30S–35S:	40–45S:
		12S RNA	16S RNA
		70–100 proteins	
Higher plants	77S–80S	40S:	60S:
		19S RNA	25S, 5S RNAs
		70–75 proteins	
Chloroplasts	70S	30S:	50S:
		20–24 proteins	34–38 proteins
		16S RNA	23S, 5S, 4.5S RNAs
Prokaryotes			
<i>Escherichia coli</i>	70S	30S:	50S:
		21 proteins	34 proteins
		16S RNA	23S, 5S RNAs

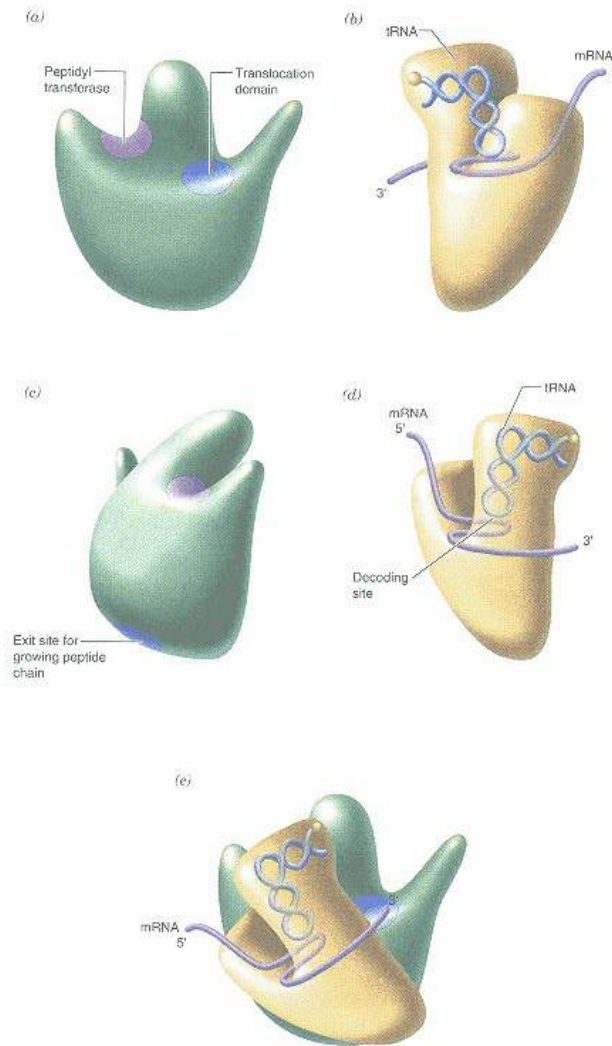

Figure 17.1

Ribosome structure and functional sites.

Top row shows the faces of each subunit that interact in the functional ribosome. In (a) the large subunit is shown; note that sites of peptide bond formation and of binding of the elongation factors are on opposite sides of the bulbous "central protuberance." The arm-like structure is somewhat flexible or mobile and is seldom visualized in complete ribosomes.

In (b) the small subunit is shown with a "platform" or ledge protruding toward the reader. mRNA and tRNA interact in a "decoding site," deep in the cleft between the platform and subunit body. The orientation of mRNA and tRNA is depicted, although their interaction in the decoding site is obscured by the platform.

In (c) the large subunit has been rotated 90° and the arm projects into the page. The exit site near the base of the subunit is where newly synthesized protein emerges from the subunit. This area of the subunit is in contact with membranes in the "bound" ribosomes of rough endoplasmic reticulum. The site of peptide bond formation, the peptidyltransferase center, is distant from the exit site; the growing peptide passes through a groove or tunnel in the ribosome to reach the exit site.

In (d) the small subunit has been rotated 90° such that the platform projects toward the dish-like face of the large subunit and the cleft is apparent.

In (e) subunits have been brought together to show their relative orientation in the ribosome. Note that tRNA bound by the small subunit is oriented so that the aminoacyl acceptor end is near the peptidyltransferase while the translocational domain (where EF-1 α and EF-2 bind) is near the decoding region and the area in which mRNA enters the complex. Drawings are based on electron microscopy of stained and unstained, frozen ribosomes. The latter technique preserves native structure and, perhaps along with X-ray crystallography, should lead to a more detailed and complete model of the ribosome.

from mixtures in which a single component is omitted or modified can show, for example, if a given protein is required for assembly of the subunit or for some specific function. An assembly map for large ribosomal subunits of *Escherichia coli* is shown in Figure 17.2. Total reconstitution of subunits from eukaryotes has not yet been achieved but the general conclusions about how ribosomes function, although determined using bacterial ribosomes, are fully applicable to eukaryotic systems.

Ribosomes are organized in two additional ways. First, several ribosomes often translate a single mRNA molecule simultaneously. Purified mRNA-linked

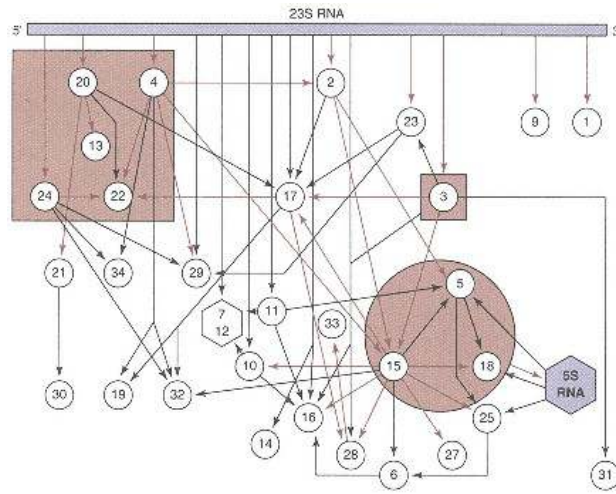

Figure 17.2

Assembly map of the large ribosomal subunit of *E. coli*.

The heavy bar at the top represents the 23S rRNA, and the individual ribosomal proteins are identified by numbers in circles. Arrows that connect components indicate their interaction. Red arrows from RNA to protein indicate that the protein binds directly and strongly to RNA, while black arrows indicate a weaker interaction. Similarly, red arrows between proteins show a strong binding dependence and black arrows show a lesser dependency. For example, protein L4 binds RNA strongly; it then strongly stimulates binding of proteins L2, L22, and L29. Protein L2 in turn stimulates binding of proteins L5 and L15. Proteins L5, L15, and L18 are essential for binding 5S RNA. Proteins within the boxes are required for a conformational transition that occurs during assembly. Diagram shows both orderly progression of the assembly process and interdependence of the components and their specific reactions with other components during the assembly of the subunit.

Adapted from M. Herold and K. Nierhaus, *J. Biol.*

Chem. 262–8826, 1987. A similar assembly map for the small subunit was elucidated earlier. (M. Nomura, *Cold Spring Harbor Symp. Quant. Biol.* 52:653, 1987.)

polysomes can be visualized by electron microscopy (Figure 17.3). Second, in eukaryotic cells some ribosomes occur free in the cytosol, but many are bound to membranes of the rough endoplasmic reticulum. In general, **free ribosomes** synthesize proteins that remain within the cell cytosol or become targeted to the nucleus, mitochondria, or some of the other organelles. **Membrane-bound ribosomes** synthesize proteins that will be secreted from the cell or sequestered and function in other cellular membranes or vesicles. In cell homogenates, membrane fragments and the bound ribosomes constitute the **microsome** fraction; detergents that disrupt membranes release these ribosomes.

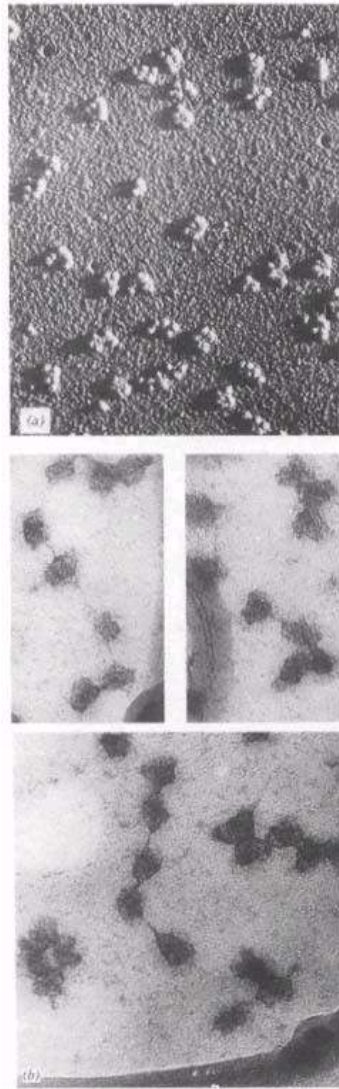

Figure 17.3

Electron micrographs of polysomes.

(a) Reticulocyte polyribosomes shadowed with platinum are seen in clusters of three to six ribosomes, a number consistent with the size of mRNA for a globin chain. (b) Uranyl acetate staining in addition to visualization at a higher magnification shows polysomes in which parts of the mRNA are visible.

Courtesy of Dr. Alex Rich, MIT.

Transfer RNA Acts As a Bilingual Translator Molecule

All tRNA molecules have several common structural characteristics including the 3'-terminal CCA sequence to which amino acids are bound, a highly conserved cloverleaf secondary structure, and an L-shaped three-dimensional structure (see p. 682). But each of the many molecular species has a unique nucleotide sequence, giving it individual characteristics that allow great specificity in inter-

actions with mRNA and with the aminoacyl-tRNA synthetase that couples one specific amino acid to it.

The Genetic Code Uses a Four-Letter Alphabet of Nucleotides

Information in the cell is stored in the form of linear sequences of nucleotides in DNA, in a manner that is analogous to the linear sequence of letters of the alphabet in the words you are now reading. The DNA language uses a simple **four-letter alphabet** that comprises the two purines, A and G (adenine and guanine), and the two pyrimidines, C and T (cytosine and thymine). In mRNA the information is encoded in a similar four-letter alphabet, but U (uracil) replaces T. The language of RNA is thus a dialect of the genetic language of DNA. Genetic information is **expressed** predominantly in the form of proteins that derive their properties from their linear sequence of amino acids and to a much lesser extent as RNA species such as tRNA and rRNA. Thus, during protein biosynthesis, the four-letter language of nucleic acids is translated into the 20-letter language of proteins. Implicit in the analogy to language is the directionality of these sequences. By convention, nucleic acid sequences are written in a 5' → 3' direction, and protein sequences from the amino terminus to the carboxy terminus. These directions in mRNA and protein correspond in both their reading and biosynthetic senses.

Codons in mRNA Are Three-Letter Words

A 1:1 correspondence of nucleotides to amino acids would only permit mRNA to encode four amino acids, while a 2:1 correspondence would encode $4^2 = 16$ amino acids. Neither is sufficient since 20 amino acids occur in most proteins. The actual three-letter **genetic code** has $4^3 = 64$ permutations or words, which is also sufficient to encode start and stop signals, equivalent to punctuation. The three-base words are called **codons** and they are customarily shown in the form of Table 17.2. Only two amino acids are designated by

TABLE 17.2 The Genetic Code^a

5' Base	U	UUU	Phe	UCU	Ser	UAU	Tyr	UGU	Cys	U	3' Base
		UUC		UCC		UAC		UGC		C	
		UUA		UCA		UAA		UGA		A	
		UUG		UCG		UAG		UGG		G	
	C	CUU	Leu	CCU	Pro	CAU	His	CGU	Arg	U	
		CUC		CCC		CAC		CGC		C	
		CUA		CGA		CAA		CGA		A	
		CUG		CCG		CAG		CGG		G	
	A	AUU	Ile	ACU	Thr	AAU	Asn	AGU	Ser	U	
		AUC		ACC		AAC		AGC		C	
		AUA		ACA		AAA		AGA		A	
		AUG		ACG		AAG		AGG		G	
	G	GUU	Val	GCU	Ala	GAU	Asp	GGU	Gly	U	
		GUC		GCC		GAC		GGC		C	
		GUA		GCA		GAA		GGA		A	
		GUG		GCG		GAG		GGG		G	

^aThe genetic code comprises 64 codons, which are permutations of four bases taken in threes. Note the importance of sequence; three bases, each used once per triplet codon, give six permutations: ACG, AGC, GAC, GCA, CAG, and CGA, for threonine, serine, aspartate, alanine, glutamine, and arginine, respectively.

TABLE 17.3 Nonuniversal Codon Usage in Mammalian Mitochondria

Codon	Usual Code	Mitochondrial Code
UGA	Termination	Tryptophan
AUA	Isoleucine	Methionine
AGA	Arginine	Termination
AGG	Arginine	Termination

single codons: methionine as AUG and tryptophan as UGG. The rest are designated by two, three, four, or six codons. Multiple codons for a single amino acid represent **degeneracy** in the code. The genetic code is nearly **universal**. The same code words are used in all living organisms, prokaryotic and eukaryotic. An exception to universality occurs in mitochondria, in which a few codons have a different meaning than in the cytosol of the same organism (Table 17.3).

Punctuation

Four codons function partly or totally as punctuation, signaling the start and stop of protein synthesis. The **start signal**, AUG, also specifies methionine. An AUG at an appropriate site and within an acceptable sequence in mRNA signifies methionine as the initial, amino-terminal residue. AUG codons elsewhere in the message specify methionine residues within the protein. Three codons, UAG, UAA, and UGA, are **stop signals**; they specify no amino acid and are known as **termination codons** or, less appropriately, as **nonsense codons**.

Codon–Anticodon Interactions Permit Reading of mRNA

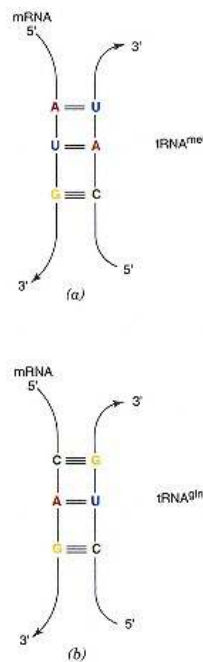

Figure 17.4
Codon–anticodon interactions. Shown are interactions between (a) the AUG (methionine) codon and its CAU anticodon and (b) the CAG (glutamine) codon and a CUG anticodon. Note that these interactions involve antiparallel pairing of mRNA with tRNA.

Translation of the codons of mRNA involves their direct interaction with complementary **anticodon sequences** in tRNA. Each tRNA species carries a unique amino acid, and each has a specific three-base anticodon sequence. Codon–anticodon base pairing is antiparallel, as shown in Figure 17.4. The anticodon is far from the amino acid–acceptor stem in both the tRNA cloverleaf and the L-shaped three-dimensional structure of all tRNA molecules. (See Chapter 16, p. 682.) Location of the anticodon and amino acid residue at opposite extremes of the molecule permits the tRNA to conceptually and physically bridge the gap between the nucleotide sequence of the ribosome-bound mRNA and the site of protein assembly on the ribosome.

Since 61 codons designate an amino acid, it might seem necessary to have 61 different tRNA species. This is **not** the case. Variances from standard base pairing are common in codon–anticodon interactions. Many amino acids can be carried by more than one tRNA species, and degenerate codons can be read by more than one tRNA (but always one carrying the correct amino acid). Much of this complexity is explained by the **"wobble" hypothesis**, which permits less stringent base pairing between the third position of a codon and the first position of its anticodon. Thus the first two positions of a codon predominate in tRNA selection and the **degenerate** (third) position is less important. A second modulator of codon–anticodon interactions is the presence of modified nucleotides at or beside the first nucleotide of the anticodon in many tRNA species. A frequent anticodon nucleotide is **inosinic acid** (I), the nucleotide of hypoxanthine, which base pairs with U, C, or A. Wobble base pairing rules are shown in Table 17.4.

TABLE 17.4 Wobble Base Pairing Rules

3' Codon Base	5' Anticodon Bases Possible
A	U or I
C	G or I
G	C or U
U	A or G or I

If the wobble rules are followed, the 61 nonpunctuation codons could be read by as few as 31 tRNA molecules, but most cells have 50 or more tRNA

species. Some codons are read more efficiently by one anticodon than another. Not all codons are used equally, some being used very rarely. Examination of many mRNA sequences has allowed construction of "codon usage" tables that show that different organisms preferentially use different codons to generate similar polypeptide sequences.

"Breaking" the Genetic Code

The genetic code (Table 17.2) was determined before methods were developed to sequence natural mRNA. These code-breaking experiments provide insight into how proteins are synthesized. Important experiments used simple artificial mRNAs or chemically synthesized trinucleotide codons.

Polynucleotide phosphorylase catalyzes the template-independent and readily reversible reaction:

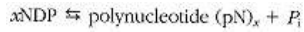

where NDP is any nucleoside 5'-diphosphate or a mixture of two or more. If the nucleoside diphosphate is UDP, a polymer of U designated poly(U) is formed. Under nonphysiological conditions protein synthesis can occur *in vitro* without the initiation components that are normally required. With poly(U) as mRNA, the "protein" polyphenylalanine is made. Similarly, poly(A) encodes polylysine and poly(C) polyproline. An mRNA with a random sequence of only U and C produces polypeptides that contain not only proline and phenylalanine, as predicted, but also serine (from UCU and UCC) and leucine (from CUU and CUC). Because of degeneracy in the code and the complexity of the products, experiments with random sequence mRNAs were difficult to interpret, and so synthetic messengers of defined sequence were transcribed from simple repeating DNA sequences by RNA polymerase. Thus poly(AU), transcribed from a repeating poly(dAT), produces only a repeating copolymer of Ile-Tyr-Ile-Tyr, read from successive triplets AUA UAU AUA UAU and so on. A synthetic poly(CUG) has possible codons CUG for Leu, UGC for Cys, and GCU for Ala, each repeating itself once the **reading frame** has been selected. Since selection of the initiation codon is random in these *in vitro* experiments, three different homopolypeptides are produced: polyleucine, polycysteine, and polyalanine. A perfect poly(CUCG) produces a polypeptide with the sequence (-Leu-Ala-Arg-Ser-) whatever the initiation point. These relationships are summarized in Table 17.5; they show codons to be triplets read in exact sequence, without overlap or omission. Other experiments used chemically synthesized trinucleotide codons as minimal messages. No proteins were made, but the binding of only one amino acid (conjugated to an appropriate tRNA) by the ribosome was stimulated by a given codon. It was thus possible to decipher the meaning of each possible codon and to identify termination codons. All of these conclusions were later verified by the determination of mRNA sequences.

TABLE 17.5 Polypeptide Products of Synthetic mRNAs*

mRNA	Codon Sequence	Products
—(AU) _n —	— $\overline{\text{AUA}}$ $\overline{\text{UAU}}$ $\overline{\text{AUA}}$ $\overline{\text{UAU}}$ —	—(Ile-Tyr) _{n/3} —
—(CUG) _n —	— $\overline{\text{CUG}}$ $\overline{\text{CUG}}$ $\overline{\text{CUG}}$ $\overline{\text{CUG}}$ —	—Leu _n —
	— $\overline{\text{UGC}}$ $\overline{\text{UGC}}$ $\overline{\text{UGC}}$ $\overline{\text{UGC}}$ —	—Cys _n —
	— $\overline{\text{GCU}}$ $\overline{\text{GCU}}$ $\overline{\text{GCU}}$ $\overline{\text{GCU}}$ —	—Ala _n —
—(CUCG) _n —	$\overline{\text{CUC}}$ $\overline{\text{GCU}}$ $\overline{\text{CGC}}$ $\overline{\text{UCG}}$	—(Leu-Ala-Arg-Ser) _{n/3} —

* The horizontal brackets accent the reading frame.

CLINICAL CORRELATION 17.1**Missense Mutation: Hemoglobin**

Clinically, the most important missense mutation known is the change from A to U in either the GAA or GAG codon for glutamate to give a GUA or GUG codon for valine in the sixth position of the β chain for hemoglobin. An estimated 1 in 10 African-Americans are carriers of this mutation, which in its homozygous state is the basis for sickle cell disease, the most common of all hemoglobinopathies (see Clin. Corr. 2.3 for the effects of this substitution on the polymerization of deoxygenated hemoglobin). The second most common hemoglobinopathy is hemoglobin C disease, in which a change from G to A in either the GAA or GAG codon for glutamate results in an AAA or AAG codon for lysine in the sixth position of the β chain. Over 600 other hemoglobin missense mutations are now known. Methods for diagnosis of these and other genetic disorders are discussed in Clin. Corr. 16.2. A recent advance in therapy of sickle cell anemia uses hydroxyurea treatment to stimulate synthesis of γ chains and thus increase fetal hemoglobin production in affected adults. This decreases the tendency of the HbS in erythrocytes to form linear multimers that result in cell shape distortion—that is, sickling—when the oxygen tension decreases.

Charache, S. et al. Effect of hydroxyurea on the frequency of painful crises in sickle cell anemia. *N. Engl. J. Med.* 332:1317–1322, 1995.

Mutations

An understanding of the genetic code and how it is read provides a basis for understanding the nature of mutations. A mutation is simply a change in a gene. **Point mutations** involve a change in a single base pair in the DNA, and thus a single base in the corresponding mRNA. Sometimes this change occurs in the third position of a degenerate codon and there is no change in the amino acid specified (e.g., UCC to UCA still codes for serine). Such **silent mutations** are only detected by gene sequence determination. They are commonly seen during comparison of genes for similar proteins, for example, hemoglobins from different species. **Missense mutations** arise from a base change that causes incorporation of a different amino acid in the encoded protein (see Clin. Corr. 17.1). Point mutations can also form or destroy a termination codon and thus change the length of a protein. Formation of a termination codon from one that encodes an amino acid (see Clin. Corr. 17.2) is often called a **nonsense mutation**; it results in premature termination and a truncated protein. Mutation of a termination codon to one for an amino acid allows the message to be "read through" until another stop codon is encountered. The result is a larger than normal protein. This phenomenon is the basis of several disorders (see Table 17.6 and Clin. Corr. 17.3).

Insertion or deletion of a single nucleotide within the coding region of a gene results in a **frameshift mutation**. The reading frame is altered at that point and subsequent codons are read in the new context until a termination codon is reached. Table 17.7 illustrates this phenomenon with the mutant hemoglobin Wayne. The significance of reading frame selection is underscored by a phenomenon in some viruses in which a single segment of DNA encodes different polypeptides that are translated using different reading frames. An example is the tumor-causing simian virus SV40 (Figure 17.5), whose small size physically limits the amount of DNA that can be packaged within it.

Aminoacylation of Transfer RNA Activates Amino Acids for Protein Synthesis

In order to be incorporated into proteins, amino acids must first be "activated" by linkage to their appropriate tRNA carriers. This is a two-step process that requires energy and is catalyzed by one of a family of aminoacyl-tRNA synthetases, each of which is specific for a single amino acid and its appropriate tRNA species. The reactions are normally written as follows:

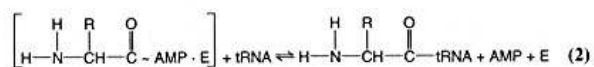
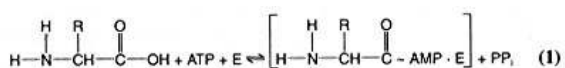

Sum:

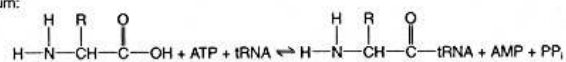

The brackets surrounding the aminoacyl-AMP-enzyme complex indicate that it is a transient, enzyme-bound intermediate. The "squiggle" (~) linkage of amino acid to AMP identifies the aminoacyl-adenylate as a high-energy intermediate, a mixed acid anhydride with carboxyl and phosphoryl components. The aminoacyl ester linkage in tRNA is lower in energy than the aminoacyl-adenylate, but still higher than that of the carboxyl group of the free amino acid. The

CLINICAL CORRELATION 17.2

Disorders of Terminator Codons

In hemoglobin McKees Rocks the UAU or UAC codon normally designating tyrosine in position 145 of the β chain has mutated to the terminator codon UAA or UAG. This results in shortening of the β chain from its normal 146 residues to 144 residues. This change gives the hemoglobin molecule an unusually high oxygen affinity since the normal C-terminal sequence involved in binding 2,3-bisphosphoglycerate is modified. The response to decreased oxygen delivery is secretion of erythropoietin by the kidney and increased red blood cell production that produces a polycythemic phenotype (see Clin. Corr. 22.2).

Another illness that results from a terminator mutation is a variety of β -thalassemia. Thalassemias are a group of disorders characterized at the molecular level by an imbalance in the stoichiometry of α - and β -globin synthesis. In β^0 -thalassemia no β -globin is synthesized. As a result, α -globin, unable to associate with β -globin to form hemoglobin, accumulates and precipitates in erythroid cells. The precipitation damages cell membranes, causing hemolytic anemia and stimulation of erythropoiesis. One variety of β^0 -thalassemia, common in Southeast Asia, results from a terminator mutation at codon 17 of the β -globin; the normal codon AAG that designates a lysyl residue at β -17 becomes the stop codon UAG. In contrast to hemoglobin McKees Rocks, in which the terminator mutation occurs late in the β -globin message, the mutation occurs so early in the mRNA that no useful β -globin sequence can be synthesized, and β -globin is absent. This leads to anemia and aggregation of unused α -globin in the red cell precursors. In addition, β -globin mRNA levels are depressed, probably because premature termination of translation leads to instability of the mRNA.

Winslow, R. M., Swenberg, M., Gross, E., et al. Hemoglobin McKees Rocks ($\alpha\beta_2^{145 \text{ Tyr} \rightarrow \text{icrta}}$). A human nonsense mutation leading to a shortened β chain. *J. Clin. Invest.* 57:772, 1976. Chang, J. C., and Kan, Y. W. β -Thalassemia: a nonsense mutation in man. *Proc. Natl. Acad. Sci. USA* 76:2886, 1979.

CLINICAL CORRELATION 17.3

Thalassemia

There are two expressed α -globin genes on each chromosome 16. Many instances of α -thalassemia arise from the deletion of two, three, or all four copies of the α -globin gene. The clinical severity increases with the number of genes deleted. In contrast, the disorders summarized in Table 17.6 are forms of α -thalassemia that arise from abnormally long α -globin molecules, which replace normal α -globin, and are present only in small amounts. These small amounts of α -globin result from a decreased rate of synthesis or more likely from an increased rate of breakdown of the abnormally elongated α -globin. The normal stop codon, UAA, for α -globin mutates to any of four sense codons with resultant placement of four different amino acids at position 142. Normal α -globin is only 141 residues in length, but the four abnormal α -globins are 172 residues in length, presumably because a triplet of nucleotides in the normally untranslated region of the mRNA becomes a terminator codon in the abnormal position 173. Elongated globin chains can also result from frameshift mutations or insertions.

Weatherall, D. J., and Clegg, J. B. The α -chain termination mutants and their relationship to the α -thalassemias. *Philos. Trans. R. Soc. Lond.* 271:411, 1975.

reactions are written to show their reversibility. In reality, **pyrophosphatases** cleave the pyrophosphate released and the equilibrium is strongly shifted toward formation of aminoacyl-tRNA. From the viewpoint of precision in translation, the amino acid, which had only its side chain (R group) to distinguish it, becomes linked to a large, complex, and easily recognized carrier.

Specificity and Fidelity of Aminoacylation Reactions

Cells contain 20 different **aminoacyl-tRNA synthetases**, each specific for one amino acid, and at most a small family of carrier tRNAs for that amino acid. In translation, codon-anticodon interactions define the amino acid to be incorporated. If an incorrect amino acid is carried by the tRNA, it will be incorporated into the protein. Correct selection of both tRNA and amino acid by the synthetase is necessary to avoid such mistakes. Accuracy of these enzymes is central to the fidelity of protein synthesis.

Aminoacyl-tRNA synthetases share a common mechanism and many are physically associated with one another in the cell. Nevertheless, they are a diverse group of proteins that may contain one, two, or four identical subunits or pairs of dissimilar subunits. Detailed studies indicate that separate structural domains are involved in aminoacyl-adenylate formation, tRNA recognition, and, if it occurs, subunit interactions. In spite of their structural diversity, each enzyme is capable of almost error-free formation of correct aminoacyl-tRNA combinations.

TABLE 17.6 "Read Through" Mutation in Termination Codons Produce Abnormally Long α -Globin Chains

Hemoglobin	α -Codon 142	Amino Acid 142	α -Globin Length (Residues)
A	UAA		141
Constant Spring	CAA	Glutamine	172
Icaria	AAA	Lysine	172
Seal Rock	GAA	Glutamate	172
Koya Dora	UCA	Serine	172

Selection and incorporation of a correct amino acid require great discrimination on the part of some synthetases. While some amino acids may be easily recognized by their bulk (e.g., tryptophan) or lack of bulk (glycine), or by positive or negative charges on the side chains (e.g., lysine and glutamate), others are much more difficult to discriminate. Recognition of valine rather than threonine or isoleucine by the valyl-tRNA synthetase is difficult since the side chains differ by either an added hydroxyl or single methylene group. The amino acid-recognition and -activation sites of each enzyme have great specificity, as is characteristic of many enzymes. Nevertheless, misrecognition does occur. An additional "**proofreading**" or "**editing**" step increases discrimination. This most often occurs through hydrolysis of the aminoacyl-adenylate intermediate, with the release of amino acid and AMP. Valyl-tRNA synthetase efficiently hydrolyzes threonyl-adenylate and it hydrolyzes isoleucyl-adenylate in the presence of bound (but not aminoacylated) tRNA^{Val}. In other cases a misacylated tRNA is recognized and deacylated. Valyl- and phenylalanyl-tRNA synthetases deacylate tRNAs that have been mischarged with threonine and tyrosine, respectively. This proofreading is analogous to editing of misincorporated nucleotides by the 3' → 5' exonuclease activity of DNA polymerases (Chapter 16). Editing is performed by many but not all aminoacyl-tRNA synthetases. The net result is an average level of misacylation of one in 10⁴ to 10⁵.

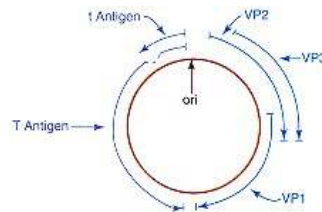

Figure 17.5

Map of genome of simian virus 40 (SV40).

DNA of SV40, shown in red, is a double-stranded circle of slightly more than 5000 base pairs that encodes all information needed by the virus for its survival and replication within a host cell. It is an example of extremely efficient use of the information-coding potential of a small genome. Proteins VP1, VP2, and VP3 are structural proteins of the virus; VP2 and VP3 are translated from different initiation points to the same carboxyl terminus. VP1 is translated in a different reading frame so that its amino-terminal section overlaps the VP2 and VP3 genes but its amino acid sequence in the overlapping segment is different from that of VP2 and VP3. Two additional proteins, the large T and small t tumor antigens, which promote transformation of infected cells, have identical amino-terminal sequences. The carboxyl-terminal segment of small t protein is encoded by a segment of mRNA that is spliced out of the large T message, and the carboxyl-terminal sequence of large T is encoded by DNA that follows termination of small t. This occurs through differential processing of a common mRNA precursor. The single site of origin of DNA replication (ori) is outside all coding regions of the genome.

Each synthetase must correctly recognize one to several tRNA species that correctly serve to carry the same amino acid, while rejecting incorrect tRNA species. Given the complexity of tRNA molecules, this should be simpler than selection of a single amino acid. However, recall the conformational similarity and common sequence elements of all tRNAs (p. 682). Different synthetases recognize different elements of tRNA structure. One logical element of tRNA recognition by the synthetase is the anticodon, specific to one amino acid. For example, in the case of tRNA^{Met}, changing the anticodon also alters recognition by the synthetase. In other instances, this is at least partly true. Sometimes the anticodon is not a determinant of synthetase-tRNA recognition. Consider, for example, suppressor mutations that "suppress" the expression of classes of chain termination (nonsense) mutations. A point mutation in a glutamine (CAG) codon produces a termination (UAG) codon, which causes the premature termination of the encoded protein. A second **suppressor mutation** in the anticodon of a tRNA^{Tyr}, in which the normal GUA anticodon is changed to CUA, allows "read through" of the termination codon. The initial mutation is suppressed as a nearly normal protein is made, with the affected glutamine replaced by tyrosine. Aminoacylation of the mutant tRNA^{Tyr} with tyrosine shows that in this case the anticodon does not determine synthetase specificity. In *E. coli* tRNA^{Ala}, the primary recognition characteristic is a G₃-U₇₀ base pair in the acceptor stem; even if no other changes in the tRNA^{Ala} occur, any variation at this position destroys its acceptor ability with alanine-tRNA^{Ala} synthetase. Incorporation of a G₃-U₇₀ base pair in tRNA^{Cys} makes it an alanine acceptor, and even the isolated

TABLE 17.7 A Frameshift Mutation Results in Production of Abnormal Hemoglobin Wayne^a

Position	137	138	139	140	141	142	143	144	145	146	147
Normal α-globin amino acid sequence	- Thr	- Ser	- Lys	- Tyr	- Arg						
Normal α-globin codon sequence	- ACP	- UC [Ⓢ] U	- AAA	- UAC	- CGU	- UAA	- GCU	- GGA	- GCC	- UCG	- GUA
Wayne α-globin codon sequence	- ACP	- UCA	- AAU	- ACC	- GUU	- AAG	- CUG	- GAG	- CCU	- CGG	- UAG
Wayne α-globin amino acid sequence	- Thr	- Ser	- Asn	- Thr	- Val	- Lys	- Leu	- Glu	- Pro	- Arg	

^aThe base deletion causing three frameshift is encircled. The stop codons are boxed.

P = A, G, U, or C.

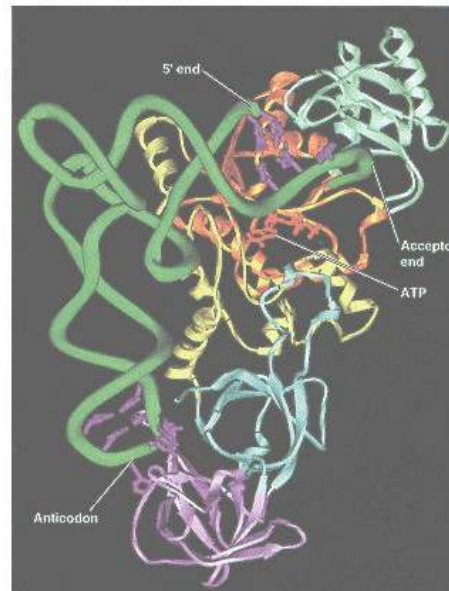

Figure 17.6

Interaction of a tRNA with its cognate aminoacyl-tRNA synthetase.

Figure shows sugar–phosphate backbone of *E. coli* glutamyl tRNA in green and the peptide backbone of the glutamine tRNA^{Gln} synthetase in multiple colors. Note the strong interactions of the synthetase with both the partially unwound acceptor stem and the anticodon loop of the tRNA, and placement of ATP, shown in red, within a few angstroms of the 3' end of tRNA. Space-filling models of the enzyme and tRNA would show both molecules to be solid objects with several sites of direct contact. Adapted from J. Perona, M. Rould, and T. Steitz, *Biochemistry* 32:8758, 1993.

acceptor stem of tRNA^{Ala} can be aminoacylated. Other tRNA identification features include additional elements of the acceptor stem and sometimes parts of the variable loop or the D-stem/loop. Usually multiple structural elements contribute to recognition, but many are not absolute determinants. The X-ray structure of the glutamyl synthetase–tRNA complex shown in Figure 17.6 shows binding at the concave tRNA surface, which is typical and compatible with the biochemical observations.

17.3—

Protein Biosynthesis

Translation Is Directional and Colinear with mRNA

In the English language words are read from left to right and not from right to left. Similarly, mRNA sequences are written 5' → 3' and in the translation process they are read in the same direction. Amino acid sequences are both written and biosynthesized from the amino-terminal residue to the carboxy terminus. This was first demonstrated by following the incorporation of radioactive amino acids into specific sites in hemoglobin as a function of time. Only full length, complete globin chains were isolated and analyzed. Completed chains that incorporated radioactive amino acids during the shortest exposures to the radioactive precursor were near to being finished at the time of the pulse and were found to have radioactive amino acids only in the carboxy-terminal segments. Longer pulses with radioactive amino acids resulted also in labeling of central segments of the protein, and the longest pulse time, still corresponding to less than that needed to synthesize a full-length polypeptide, showed radioactivity approaching the amino-terminal segments. Again, this amino- to carboxy-terminal directionality became obvious as details of translation were clarified.

The existence of stable polysomes and the directional nature of translation imply that each ribosome remains bound to an mRNA molecule and moves along the length of the mRNA until it is fully read. Comparison of mRNA sequences with sequences of the proteins they encode shows a perfect, colinear, gap-free correspondence of the mRNA coding sequence and that of the synthesized polypeptide. In fact, it is common to deduce the sequence of a protein solely from the nucleotide sequence of its mRNA or the DNA of the gene encoding it. However, the deduced sequence may differ from the genuine protein because of posttranslational events and modifications.

Initiation of Protein Synthesis Is a Complex Process

A good novel can be analyzed in terms of its beginning, its development or middle section, and its satisfactory ending. Protein biosynthesis will be described in a similar conceptual and mechanical framework: initiation of the process, elongation during which the great bulk of the protein is formed, and termination of synthesis and release of the finished polypeptide. We will then examine the posttranslational modifications that a protein may undergo.

Initiation requires bringing together a small (40S) ribosomal subunit, the mRNA, and a tRNA complex of the amino-terminal amino acid, all in a proper orientation. This is followed by association of the large (60S) subunit to form a completed initiation complex on an 80S ribosome. The ordered process is shown in Figure 17.7; it also requires a complex group of proteins, known as **initiation factors**, that participate only in initiation. They are not ribosomal proteins, although many of them bind transiently to ribosomes during initiation steps. There are many eukaryotic initiation factors and the specific functions of some remain unclear; prokaryotic protein synthesis provides a useful and less complex model for comparison.

As a first step, **eukaryotic initiation factor 2a (eIF-2a)** binds to GTP and one species of tRNA^{Met}, designated ^fMet-tRNA_i^{Met} is recognized by prokaryotic IF-2.

The second step in initiation requires 40S ribosomal subunits associated with a very complex protein, **eIF-3**. Mammalian eIF-3 includes eight different polypeptides and has a mass of 600–650 kDa. In electron micrographs eIF-3 is seen bound to the 40S subunit surface that will contact the larger 60S subunit, thus physically blocking association of 40S and 60S subunits. Hence eIF-3 is also called a ribosome **anti-association factor**, as is **eIF-6**, which binds to 60S subunits. A complex that includes eIF-2a · Met-tRNA_i^{Met} · GTP ternary complex, correctly oriented mRNA, and several protein factors.

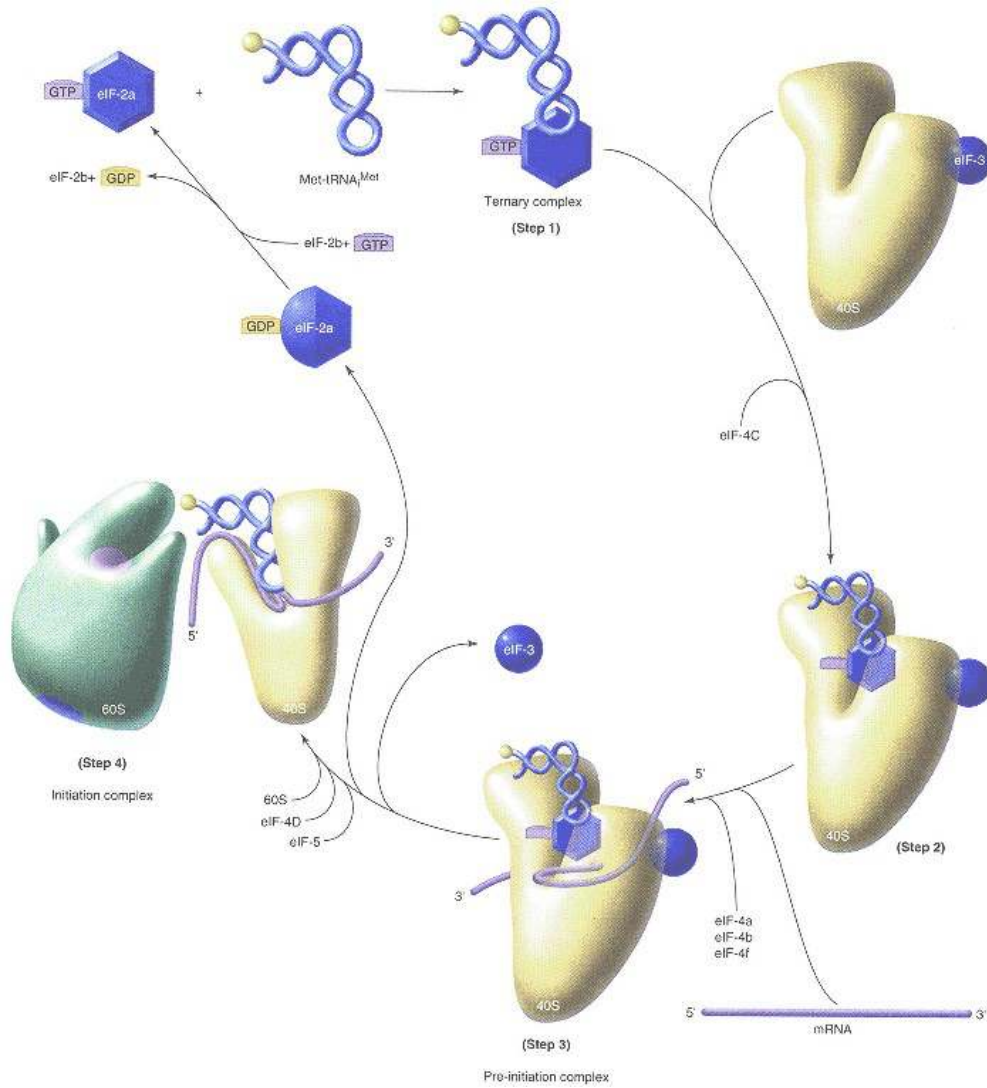

Figure 17.7

Initiation of translation in eukaryotes.

Details are given in the text. Ternary complex (step 1) first combines with small ribosomal subunit to place the initiator tRNA (step 2). Figure shows interaction with a naked mRNA molecule to form a preinitiation complex (step 3); additional small subunits later complex with the same mRNA as polysomes are formed. Formation of the initiation complex (is shown in step 4). The different shape of eIF-2a in complexes with GTP and GDP indicates that conformational change in the protein occurs upon hydrolysis of triphosphate.

Formation of the complete **initiation complex** now proceeds with involvement of a 60S subunit and an additional factor, **eIF-5**. Protein eIF-5 first interacts with the preinitiation complex; GTP is hydrolyzed to GDP and P_i , and eIF-2a \cdot GDP, eIF-3, and other factors are released. The 40S \cdot Met-tRNA^{Met} \cdot mRNA complex interacts with a 60S subunit and initiation factor eIF-4d to generate an 80S ribosome with the mRNA and initiator tRNA correctly positioned on the ribosome. The eIF-2a \cdot GDP that is released interacts with the **guanine nucleotide exchange factor** eIF-2b and GTP to regenerate eIF-2a \cdot GTP for another round of initiation.

Prokaryotes use fewer nonribosomal factors and a slightly different order of interaction. Their 30S subunits complexed with a simpler IF-3 first bind mRNA. Orientation of the mRNA relies in part on base pairing between a pyrimidine-rich sequence of eight nucleotides in 16S rRNA and a purine-rich "**Shine-Dalgarno**" sequence (named for its discoverers) about 10 nucleotides upstream of the initiator AUG codon. Complementarity between rRNA and the message-positioning sequence of an mRNA may include several mismatches but, as a first approximation, the better the complementary pairing the more efficient initiation at that AUG will be. It is interesting that eukaryotes do not utilize an mRNA-rRNA base pairing mechanism, but instead use many protein factors to position mRNA correctly. After the mRNA is bound by a 30S subunit, a ternary complex of IF-2, Met-tRNA^{Met}, and GTP is bound. A third initiation factor, IF-1, also participates in formation of the preinitiation complex. A 50S subunit is now bound; in the process, GTP is hydrolyzed to GDP and P_i , and the initiation factors are released.

Elongation Is the Stepwise Formation of Peptide Bonds

Protein synthesis now occurs by stepwise elongation to form a polypeptide chain. At each step ribosomal **peptidyltransferase** transfers the growing peptide (or in the first step the initiating methionine residue) from its carrier tRNA to the α -amino group of the amino acid residue of the aminoacyl-tRNA specified by the next codon. Efficiency and fidelity are enhanced by nonribosomal protein **elongation factors** that utilize the energy released by GTP hydrolysis to ensure selection of the proper aminoacyl-tRNA species and to move the mRNA and associated tRNAs through the decoding region of the ribosome. Elongation is illustrated in Figure 17.8.

At a given moment, up to three different tRNA molecules may be bound at specific sites that span both ribosomal subunits. The initiating methionyl-tRNA is placed in position so that its methionyl residue may be transferred (or donated) to the free α -amino group of the incoming aminoacyl-tRNA; it thus occupies the donor site, also called the **peptidyl site** or **P site** of the ribosome. The aminoacyl-tRNA specified by the next codon of the message is bound at the acceptor site, also called the **aminoacyl site** or **A site** of the ribosome. Selection of the correct aminoacyl-tRNA is enhanced by **elongation factor 1 (EF-1)**; a component of EF-1, **EF-1 α** , first forms a ternary complex with aminoacyl-tRNA and GTP. The EF-1 α \cdot aminoacyl-tRNA \cdot GTP complex binds to the ribosome and if codon-anticodon interactions are correct, the aminoacyl-tRNA is placed at the A site, GTP is hydrolyzed to GDP and P_i , and the EF-1 α \cdot GDP complex dissociates. The initiating methionyl-tRNA and the incoming amino-acyl-tRNA are now juxtaposed on the ribosome. Their anticodons are paired with successive codons of the mRNA in the **decoding region** of the small subunit, and their amino acids are beside one another at the **peptidyltransferase site** of the large subunit. Peptide bond formation now occurs.

Peptidyltransferase catalyzes the attack of the α -amino group of the aminoacyl-tRNA onto the carbonyl carbon of the methionyl-tRNA. The result is transfer of the methionine to the amino group of the aminoacyl-tRNA, which then occupies a "hybrid"

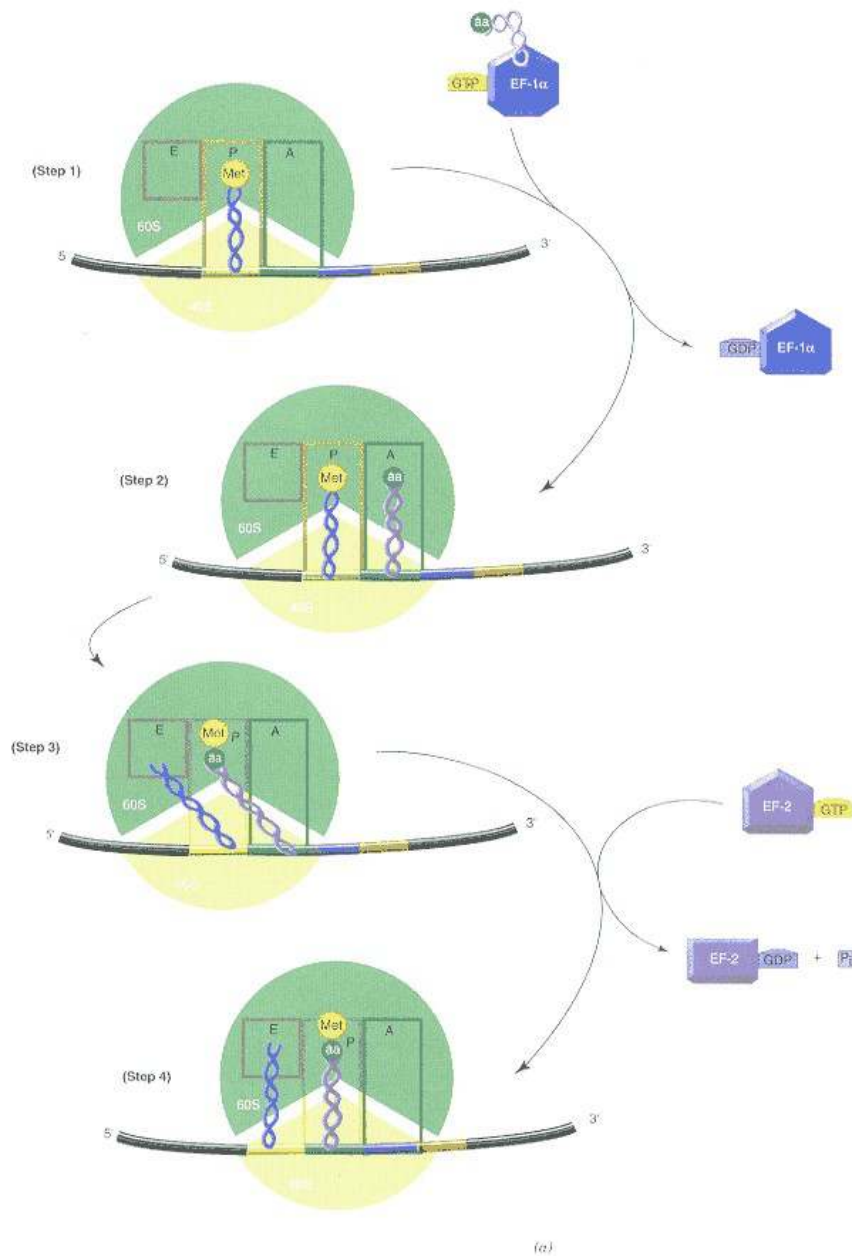
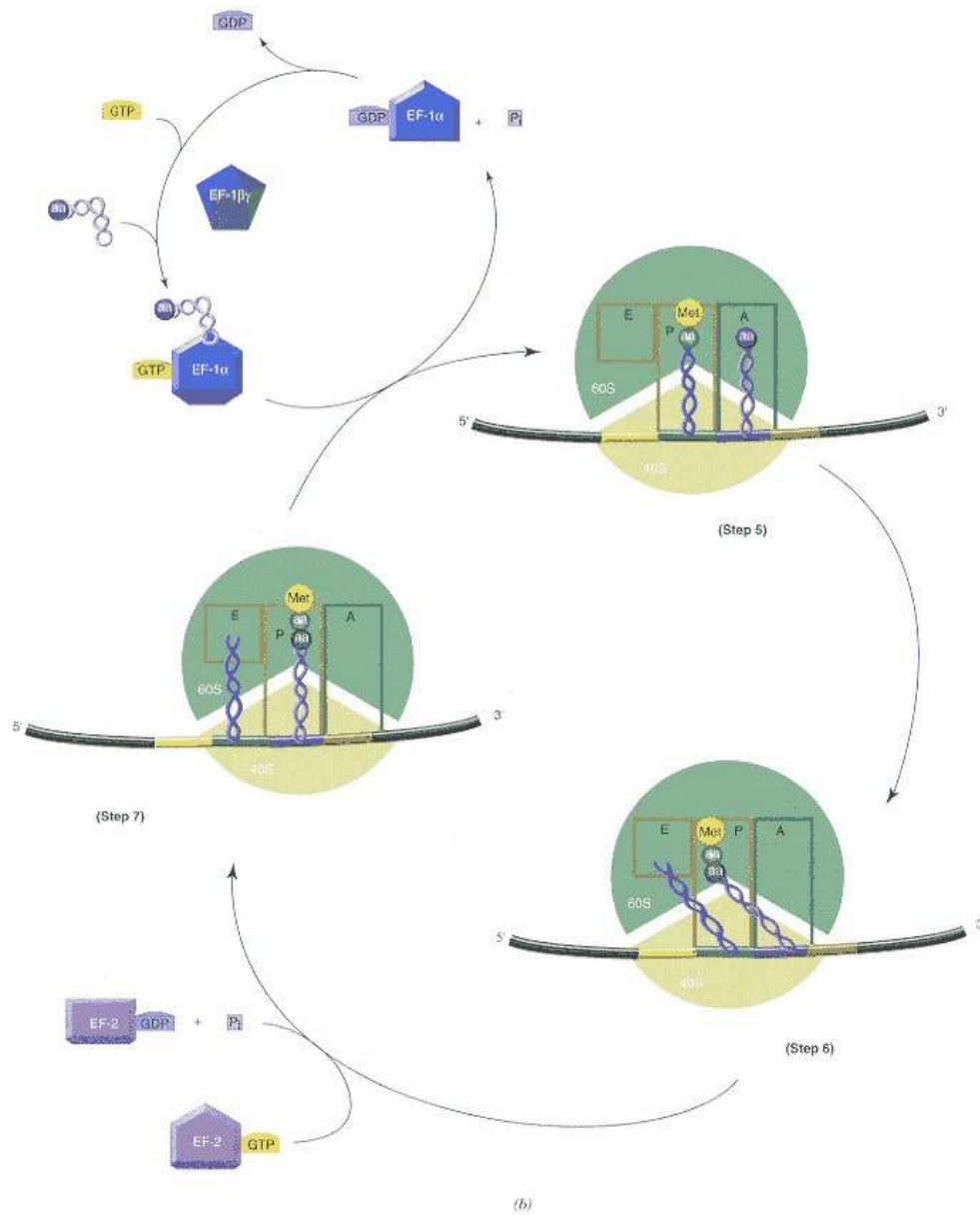

Figure 17.8
Elongation steps in eukaryotic protein synthesis.

- (a) First cycle of elongation is shown. Step 1 shows completed initiation complex with methionyl tRNA^{Met} in 80S P site. At step 2 an aminoacyl-tRNA has been placed in the ribosomal A site with participation of EF-1α. Change in shape of EF-1α shows its conformational change upon GTP hydrolysis. At step 3 the first peptide bond has been formed, new peptidyl tRNA occupies a hybrid (A/P) site on the ribosome, and the deacylated acceptor stem of the tRNA^{Met} is displaced to the E site of the large subunit. At step 4 mRNA-peptidyl tRNA complex has been fully translocated to the P site while deacylated initiator tRNA is moved to the E site.



(b) Further rounds of elongation are depicted. Binding of aminoacyl-tRNA probably causes concomitant release of deacylated tRNA from the E site, resulting in complex at step 5. Formation of the next peptide bond again results in the new peptidyl RNA occupying a hybrid A/P site on the ribosome (step 6), and translocation moves mRNA and new peptidyl tRNA in register into the P site (step 7). Additional amino acids are added by successive repetitions of the cycle. For further details see text.

position on the ribosome. The anticodon remains in the 40S A site, while the acceptor end and the attached peptide are in the 60S P site. The anticodon of the deacylated tRNA remains in the 40S P site, and its acceptor end is located in the 60S exit or **E site**.

The mRNA and the dipeptidyl-tRNA at the 40S A site must now be repositioned to permit another elongation cycle to begin. This is done by **elongation factor 2 (EF-2)**, also called **translocase**. EF-2 moves the messenger and dipeptidyl-tRNA, in codon–anticodon register, from the 40S A site to the P site. In the process, GTP is hydrolyzed to GDP plus P_i , providing energy for the movement, and the A site is fully vacated. As the dipeptidyl-tRNA is moved to the P site, the deacylated donor (methionine) tRNA is also moved to the E site, which only exists on the 60S subunit. The ribosome can now enter a new cycle. The next aminoacyl-tRNA specified by the mRNA is delivered by EF-1 α to the A site and the deacylated tRNA in the E site is probably released. Peptide transfer again occurs. Successive cycles of binding of aminoacyl-tRNA, peptide bond formation, and translocation result in the stepwise elongation of the polypeptide toward its eventual carboxyl terminus. Note that whatever the length of the growing chain, peptide bond formation always occurs through attack of the α -amino group of the incoming aminoacyl-tRNA on the peptide carboxyl-tRNA linkage; hence the geometric arrangement of the reacting molecules at the peptidyltransferase site remains constant.

Peptide bond formation does not require any additional energy source such as ATP or GTP. The energy of the methionyl (or peptidyl) ester linkage to tRNA drives the reaction toward peptide bond formation; recall that ATP is used to form each aminoacyl-tRNA and that these reactions are reversible. Isolated 60S subunits can catalyze peptidyltransferase activity, and nonribosomal factors are not involved in the reaction. Yet peptidyltransferase has never been dissociated from the large subunit or identified as a specific ribosomal protein. Reconstitution of *E. coli* peptidyltransferase activity requires only five to six different large subunit proteins and the rRNA. Omission or significant modification of the rRNA or any of these proteins causes the loss of peptidyltransferase activity, while other proteins can be deleted with little or no effect. The discovery of catalytic RNA molecules (Chapter 16) led to speculation that the primordial ribosome was an RNA particle in which peptide bond formation was catalyzed by the RNA. Experiments with very conformationally "stable" large subunit RNA from a thermophilic bacterium suggest that the rRNA may be the catalytic component of peptidyltransferase, while the proteins serve to stabilize RNA folding; however, this hypothesis remains controversial and not fully proved.

As determined with their prokaryotic equivalents, the role of GTP in the action of EF-1 α and EF-2 probably relates to conformational changes in these proteins. Crystallographic studies have shown that a large rearrangement of domains with movements of several angstroms occurs upon GTP hydrolysis in **EF-Tu**, the prokaryotic equivalent of EF-1 α . Both EF-1 α and EF-2 bind ribosomes tightly as GTP complexes, while GDP complexes dissociate from the ribosome more easily. Viewed another way, GTP stabilizes a protein conformation that confers upon EF-1 α high affinity toward aminoacyl-tRNA and the ribosome, while GDP stabilizes a conformation with lower affinity for aminoacyl-tRNA and ribosome, thus allowing tRNA delivery and factor dissociation. Restoration of the higher affinity GTP-associated conformation of EF-1 α requires participation **EF-1 β γ** (Figure 17.9). This protein displaces GDP from EF-1 α , forming an EF-1 α · EF-1 β γ complex. GTP then displaces EF-1 β γ , forming an EF-1 α · GTP complex that can successively bind an aminoacyl-tRNA and then a ribosome. Prokaryotes use a similar mechanism in which EF-Tu binds GTP and aminoacyl-tRNA and EF-Ts displaces GDP and helps recycle the carrier molecule. Prokaryotes also utilize a GTP-dependent translocase, equivalent to EF-2 but called **EF-G** or G factor.

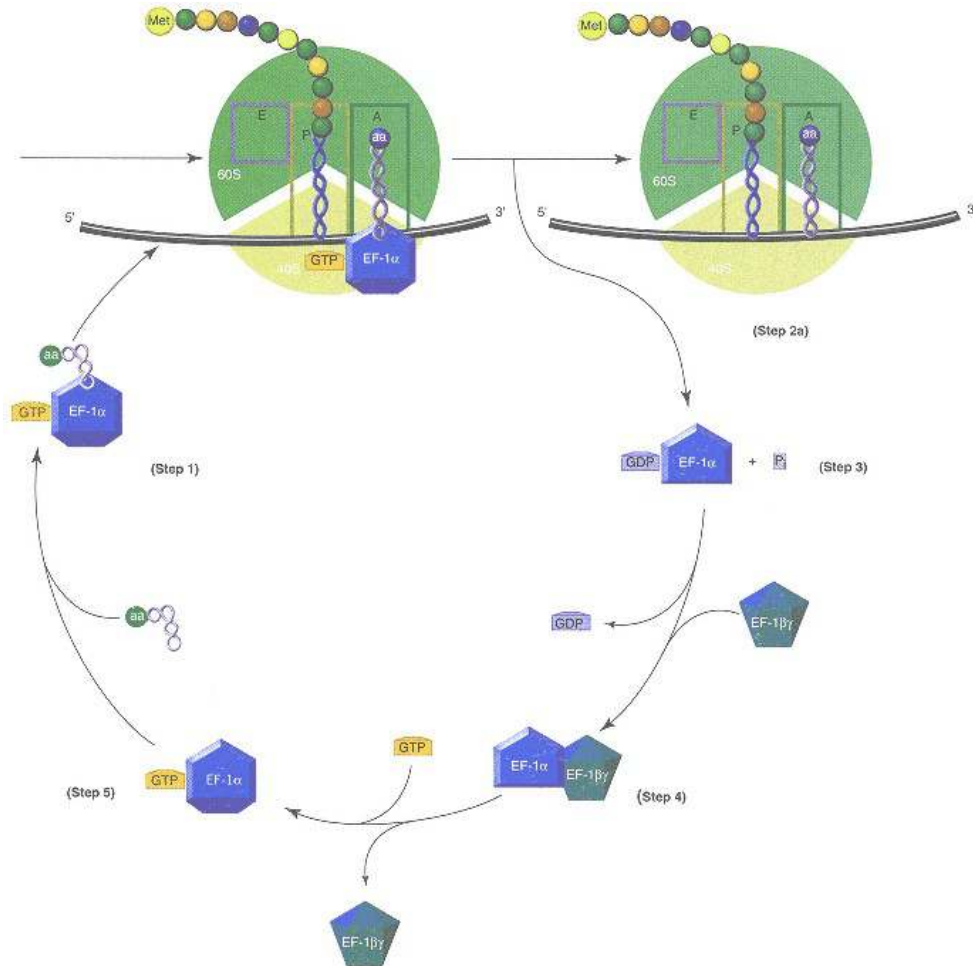

Figure 17.9

EF-1 in elongation cycle.

EF-1 α + GTP + aminoacyl-tRNA complex (step 1) binds the ribosome (step 2) and transfers aminoacyl-tRNA to the ribosome (step 2a) with concomitant hydrolysis of GTP and a change in conformation of EF-1 α (step 3) that reduces its affinity for tRNA and ribosome. The GDP is then displaced from EF-1 α by EF-1 $\beta\gamma$, resulting in the complex at step 4. Binding of GTP then displaces EF-1 $\beta\gamma$ (step 5) and allows binding of an aminoacyl-tRNA by EF-1 α in its higher affinity conformation (step 1). In prokaryotes a similar cycle exists; EF-Tu functions as the carrier of aminoacyl-tRNA and EF-Ts is guanine nucleotide exchange factor.

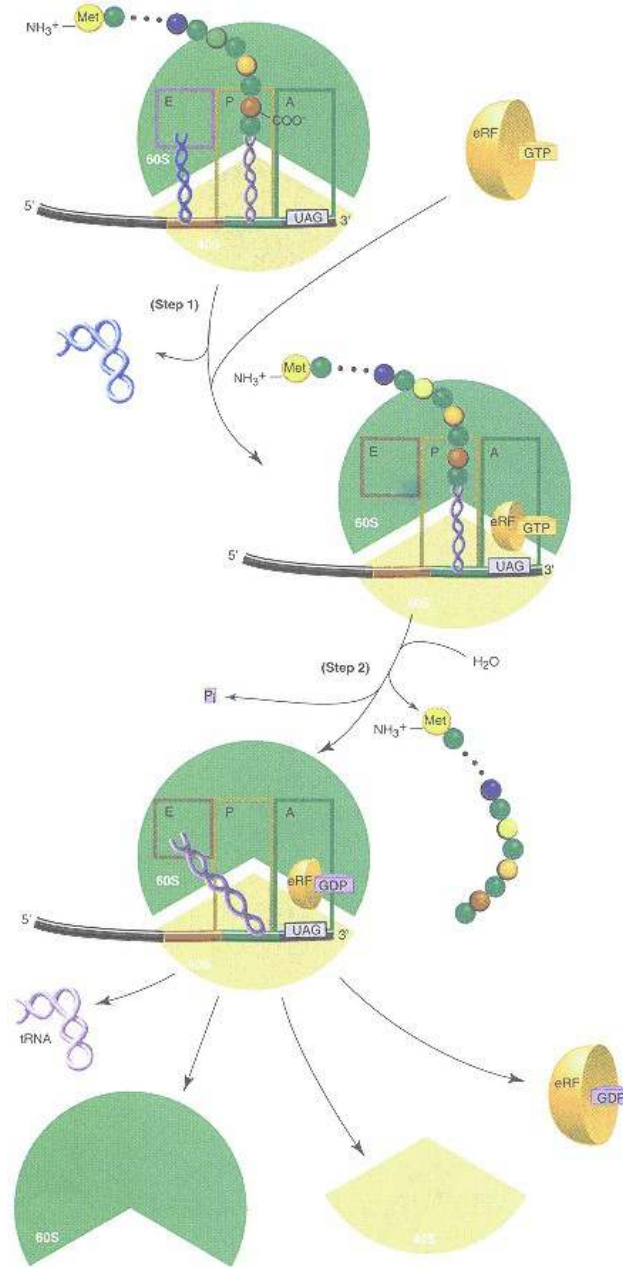

Figure 17.10

Model of termination of protein biosynthesis.

When a termination codon (UAG, UAA, or UGA) in mRNA occupies the ribosomal A site, binding of release factor–GTP complex occurs (step 1), probably with concomitant release of deacylated tRNA from the ribosomal E site. In step 2 peptidyltransferase now functions as a hydrolase; protein is released by hydrolysis of the ester bond linking it to tRNA, and acceptor end of deacylated tRNA is probably displaced. GTP is hydrolyzed to GDP and P_i, presumably altering the conformation of the release factor. Complex is now dissociated and components can enter additional rounds of protein synthesis.

Termination of Polypeptide Synthesis Requires a Stop Codon

A chain-terminating UAG, UAA, or UGA codon in the A site does not promote binding of any tRNA species. Instead, another complex nonribosomal protein, **release factor** (eRF), binds the ribosome as an eRF · GTP complex (Figure 17.10). The peptide–tRNA ester linkage is cleaved through the action of peptidyl transferase, acting here as a hydrolase, and the completed polypeptide is released from its carrier tRNA and the ribosome. Dissociation of eRF from the ribosome requires hydrolysis of the GTP and frees the ribosome to dissociate into subunits and then reenter the protein synthesis cycle at the initiation stage. In prokaryotes three release factors, RF-1, RF-2, and RF-3, carry out the termination function. The factor RF-1 acts in response to UAG or UAA codons, RF-2 acts in response to UGA or UAA codons, and RF-3 is a GTPase that activates RF-1 and RF-2.

Translation Has Significant Energy Cost

There is a considerable use of energy in synthesis of a polypeptide. Amino acid activation converts an ATP to AMP and pyrophosphate, which is normally hydrolyzed to P_i; the net cost is two high-energy phosphates. Two more high-energy bonds are hydrolyzed in the actions of EF-1 α and EF-2, for a total of four per peptide bond formed. Posttranslational modifications may add to the energy cost, and of course energy is needed for biosynthesis of the multi-use mRNA, tRNAs, ribosomes, and protein factors, but these costs are distributed among the proteins formed during their lifetime.

Protein Synthesis in Mitochondria Differs Slightly

Many characteristics of mitochondria suggest that they are descendants of aerobic prokaryotes that invaded and set up a symbiotic relationship within a eukaryotic cell. Some of their independence and prokaryotic character are retained. Human mitochondria have a circular DNA genome of 16,569 base pairs that encodes 13 proteins, 22 tRNA species, and two mitochondrion-specific rRNA species. Their independent apparatus for protein synthesis includes RNA polymerase, aminoacyl-tRNA synthetases, tRNAs, and ribosomes. Although the course of protein biosynthesis in mitochondria is like that in the cytosol, some details are different. The synthetic components, tRNAs, aminoacyl-tRNA synthetases, and ribosomes, are unique to the mitochondrion. The number of tRNA species is small and the genetic code is slightly different (see Table 17.3). Mitochondrial ribosomes are smaller and the rRNAs are shorter than those of either the eukaryotic cytosol or of prokaryotes (see Table 17.1). An initiator ^fMet-tRNA^{Met}. Most mitochondrial proteins are encoded in nuclear DNA and synthesized in the cytosol, but mitochondrial protein synthesis is clearly important (see Clin. Corr. 17.4). Cells must also coordinate protein synthesis within mitochondria with the cytosolic synthesis of proteins destined for import into mitochondria.

Some Antibiotics and Toxins Inhibit Protein Biosynthesis

Protein biosynthesis is central to the continuing life and reproduction of cells. An organism can gain a biological advantage by interfering in the ability of its competitors to synthesize proteins, and many antibiotics and toxins function in this way. Some are selective for prokaryotic rather than eukaryotic protein synthesis and so are extremely useful in clinical practice. Examples of antibiotic action are listed in Table 17.8.

Several mechanisms of interfering in ribosome subunit–tRNA interactions are utilized by different antibiotics. **Streptomycin** binds the small subunit of

CLINICAL CORRELATION 17.4**Mutation in Mitochondrial Ribosomal RNA Results in Antibiotic-Induced Deafness**

In some regions of China a significant percentage of irreversible cases of deafness has been linked to use of normally safe and effective amounts of aminoglycoside antibiotics such as streptomycin and gentamicin. The unusual sensitivity to aminoglycosides is transmitted only through women. This maternal transmission suggests a mitochondrial locus, since sperm do not contribute mitochondria to the zygote. Aminoglycosides are normally targeted to bacterial ribosomes, so the mitochondrial ribosome is a logical place to look for a mutation site.

A single A → G point mutation at nucleotide 1555 of the gene on mitochondrial DNA for the rDNA of the large subunit has been identified in three families with this susceptibility to aminoglycosides. The mutation site is in a highly conserved region of the rRNA sequence that is known to be involved in aminoglycoside binding; some mutations in the same region confer resistance to the antibiotics, and the RNA region is part of the ribosomal A site. It is hypothesized that the mutation makes the region more "prokaryote-like," increasing its affinity for aminoglycosides and the ability of the antibiotic to interfere in protein synthesis in the mitochondrion. Proteins synthesized in the mitochondrion are needed to form the enzyme complexes of the oxidative phosphorylation system, so affected cells are starved of ATP. Aminoglycosides accumulate in the cochlea, making this a particularly sensitive target and leading to sensorineural deafness.

Fischel-Ghodsian, N., Prezant, T., Bu, X., and Öztas, S. Mitochondrial ribosomal RNA gene mutation in a patient with sporadic aminoglycoside ototoxicity. *Am. J. Otolaryngol.* 14:399, 1993. Prezant, T., Agapian, J., Bohlman, M., et al. Mitochondrial ribosomal RNA mutation associated with both antibiotic-induced and non-syndromic deafness. *Nature Genetics* 4:289, 1993.

prokaryotic ribosomes, interferes with the initiation of protein synthesis, and causes misreading of mRNA. Although streptomycin does not directly bind ribosomal protein S12 of the small subunit, mutations in this protein or in the small subunit rRNA can confer resistance to or even dependence on streptomycin. Protein S12 is involved in tRNA binding, and streptomycin alters the interactions of tRNA with the ribosomal subunit and mRNA, probably by affecting subunit conformation. Other **aminoglycoside antibiotics**, such as the **neomycins** or **gentamicins**, also cause mistranslation; they interact with the small ribosomal subunit, but at sites that differ from that for streptomycin. The aminoglycoside **kasugamycin** binds small subunits and inhibits the initiation of translation. Kasugamycin sensitivity depends on base methylation that normally occurs on two adjacent adenine moieties of small subunit rRNA. **Tetracyclines** bind directly to ribosomes and interfere in aminoacyl-tRNA binding.

Other antibiotics interfere with elongation. **Puromycin** (Figure 17.11) resembles an aminoacyl-tRNA; it binds at the ribosomal A site and acts as an acceptor in the peptidyltransferase reaction. However, since it does not interact with mRNA it cannot be translocated, and since its aminoacyl derivative is not in an ester linkage to the nucleoside it cannot serve as a peptide donor. Thus puromycin prematurely terminates translation, leading to release of peptidyl-puromycin. **Chloramphenicol** directly inhibits peptidyltransferase by binding the transferase center; no transfer occurs, and peptidyl-tRNA remains associated

TABLE 17.8 Some Inhibitors of Protein Biosynthesis

<i>Inhibitor</i>	<i>Processes Affected</i>	<i>Site of Action</i>
Streptomycin	Initiation, elongation	Prokaryotes: 30S subunit
Neomycins	Translation	Prokaryotes: multiple sites
Tetracyclines	Aminoacyl-tRNA binding	30S or 40S subunits
Puromycin	Peptide transfer	70S or 80S ribosomes
Erythromycin	Translocation	Prokaryotes: 50S subunit
Fusidic acid	Translocation	Prokaryotes: EF-G
Cycloheximide	Elongation	Eukaryotes: 80S ribosomes
Ricin	Multiple	Eukaryotes: 60S subunit

with the ribosome. The translocation step is also a potential target. **Erythromycin**, a macrolide antibiotic, interferes with translocation on prokaryotic ribosomes. Eukaryotic translocation is inhibited by **diphtheria toxin**, a protein toxin produced by *Corynebacterium diphtheriae*, the toxin binds at the cell membrane and a subunit enters the cytoplasm and catalyzes the ADP-ribosylation and inactivation of EF-2, as represented in the reaction:

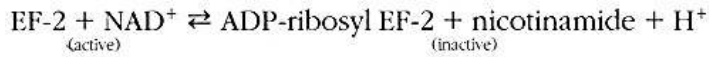

ADP-ribose is attached to EF-2 at a posttranslationally modified histidine residue known as diphthamide. Posttranslational events are discussed in the next section.

A third group of toxins attack the rRNA. **Ricin** (from castor beans) and related toxins are *N*-glycosidases that cleave a single adenine from the large subunit rRNA backbone. The ribosome is inactivated by this apparently minor damage. A fungal toxin, **α -sarcin**, cleaves large subunit rRNA at a single site and similarly inactivates the ribosome. Some *E. coli* strains make extracellular toxins that affect other bacteria. One of these, **colicin E3**, is a ribonuclease that cleaves 16S RNA near the mRNA-binding sequence and decoding region; it thus inactivates the small subunit and halts protein synthesis in competitors of the colicin-producing cell.

17.4—

Protein Maturation:

Modification, Secretion, and Targeting

Some proteins emerge from the ribosome ready to function, while others undergo a variety of **posttranslational modifications**. These alterations may result in conversion to a functional form, direction to a specific subcellular compartment, secretion from the cell, or an alteration in activity or stability. Information that determines the posttranslational fate of a protein resides in its structure: that is, the amino acid sequence and conformation of the polypeptide determine whether a protein will be a substrate for a modifying enzyme and/or identify it for direction to a subcellular or extracellular location.

Proteins for Export Follow the Secretory Pathway

Proteins destined for export are synthesized on membrane-bound ribosomes of the rough endoplasmic reticulum (ER) (Figure 17.12). A ribosome has no means of classifying the polypeptide it is about to synthesize, so initiation and elongation begin on free cytosolic ribosomes. Proteins of the secretory pathway have a hydrophobic **signal peptide**, usually at or near their amino terminus. There is no unique signal peptide sequence, but its characteristics include a positively charged N terminus, a core of 8–12 hydrophobic amino acids, and a more polar C-terminal segment that eventually serves as a cleavage site for excision of the signal peptide.

The signal peptide of 15–30 amino acids emerges from the ribosome early during polypeptide synthesis. As it appears it is bound by a cytosolic **signal recognition particle (SRP)** (see Figure 17.13). The SRP is an elongated particle made up of six different proteins plus a small (7S) RNA molecule that serves as a backbone. Binding to SRP halts protein synthesis and the ribosome moves to the ER. SRP recognizes and binds to an **SRP receptor** or "**docking protein**," localized at the cytosolic surface of the ER membrane, in a reaction that requires GTP hydrolysis and presumably involves conformational changes in the SRP and/or the receptor. The ribosome is transferred to a "**translocon**," a ribosome receptor on the membrane that serves as a passageway through the membrane. Both SRP and docking protein are freed to direct other ribosomes to the ER,

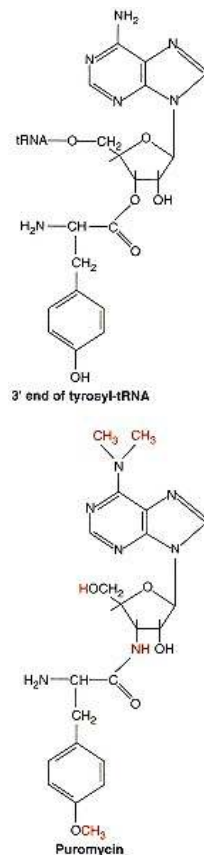

Figure 17.11
Puromycin (right) interferes with protein synthesis by functioning as an analog of aminoacyl-tRNA, here tyrosyl-tRNA (left) in peptidyltransferase reaction.

and the translational block caused by SRP binding is relieved. The hydrophobic signal sequence, probably complexed by a receptor protein, is inserted into the membrane, further anchoring the ribosome to the ER. Translation and extrusion into or through the membrane are now coupled. Translocon proteins form a pore or channel through which the growing polypeptide passes; even very hydrophilic or ionic segments are directed through the hydrophobic membrane into the ER lumen and folding into secondary and tertiary structures begins.



Figure 17.12
Rough endoplasmic reticulum of a plasma cell.
Three parallel arrows indicate three ribosomes among the many attached to the extensive membranes. Single arrow indicates a mitochondrion for comparison.
Courtesy of Dr. U. Jarlfors, University of Miami.

The completed export-destined protein within the ER lumen will probably be anchored to the membrane by the signal peptide. A cleavage site on the protein is hydrolyzed by **signal peptidase**, an integral membrane protein located at the luminal surface of the ER. The protein completes folding into a three-dimensional conformation, disulfide bonds can form, and components of multisubunit proteins may assemble. Other steps may include proteolytic processing and glycosylation that occur within the ER lumen and during transit of the protein through the Golgi apparatus and into secretory vesicles.

Glycosylation of Proteins Occurs in the Endoplasmic Reticulum and Golgi Apparatus

Glycosylation of proteins to form glycoproteins (see p. 60) is important for two reasons. Glycosylation alters the properties of proteins, changing their stability, solubility, and physical bulk. In addition, carbohydrates of glycoproteins act as recognition signals that are central to aspects of protein targeting and for cellular recognition of proteins and other cells. Glycosylation can involve addition of a few carbohydrate residues or the formation of large branched oligosaccharide chains. Sites and types of glycosylation are determined by the presence on a protein of appropriate amino acids and sequences, and by availability of enzymes and substrates to carry out the glycosylation reactions.

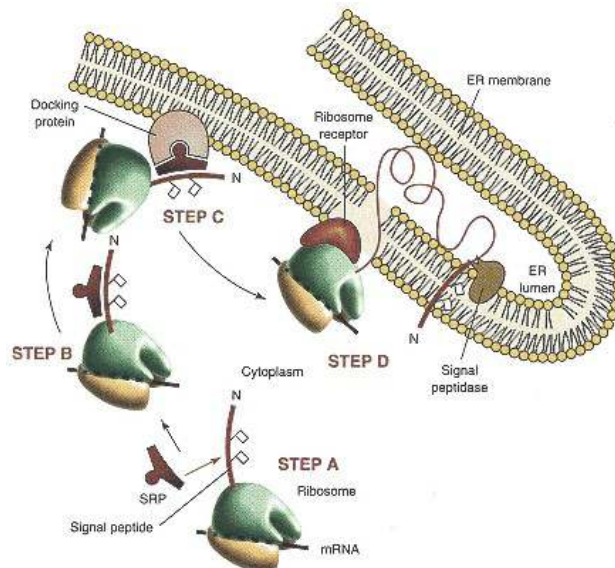

Figure 17.13
Secretory pathway: signal peptide recognition.
At step A a hydrophobic signal peptide emerges from the exit site of a free ribosome in the cytosol. Signal recognition particle (SRP) recognizes and binds the peptide and peptide elongation is temporarily halted (step B). The ribosome moves to the ER membrane where docking protein binds to SRP (step C). In step D the ribosome is transferred to a ribosome receptor or translocon, protein biosynthesis is resumed, and newly synthesized protein is extruded through the membrane into the ER lumen.

TABLE 17.9 Glycosyltransferases in Eukaryotic Cells

<i>Sugar Transferred</i>	<i>Abbreviation</i>	<i>Donors</i>	<i>Glycosyltransferase</i>
Mannose	Man	GDP-Man	Mannosyltransferase
		Dolichol-Man	
Galactose	Gal	UDP-Gal	Galactosyltransferase
Glucose	Glc	UDP-Glc	Glucosyltransferase
		Dolichol-Glc	
Fucose	Fuc	GDP-Fuc	Fucosyltransferase
<i>N</i> -Acetylgalactosamine	GalNAc	UDP-GalNAc	<i>N</i> -acetylgalactosaminyltransferase
<i>N</i> -Acetylglucosamine	GlcNAc	UDP-GlcNAc	<i>N</i> -acetylglucosaminyltransferase
<i>N</i> -Acetylneuraminic acid (or sialic acid)	NANA or NeuNAc SA	CMP-NANA	<i>N</i> -Acetylneuraminyltransferase (sialyltransferase)
		CMP-SA	

Glycosylation involves many **glycosyltransferases**, classes of which are summarized in Table 17.9. Up to 100 different enzymes each carry out a similar basic reaction in which a sugar is transferred from an activated donor substrate to an acceptor, usually another sugar residue that is part of an oligosaccharide under construction. The enzymes show three kinds of specificity: for the monosaccharide that is transferred, for structure and sequence of the acceptor molecule, and for the site and configuration of the anomeric linkage formed.

One class of glycoproteins has sugars linked through the amide nitrogen of asparagine residues in the process of ***N*-linked glycosylation**. The antibiotic **tunicamycin**, which prevents *N*-glycosylation, has been valuable in elucidating the biosynthetic pathway. Formation of *N*-linked oligosaccharides begins in the ER lumen and continues after transport of the protein to the Golgi apparatus. A specific sequence, Asn-X-Thr (or Ser) in which X may be any amino acid except proline or aspartic acid, is required for *N*-glycosylation. Not all Asn-X-Thr/Ser sequences are glycosylated because some may be unavailable due to protein conformation.

Biosynthesis of *N*-linked oligosaccharides begins with the synthesis of a lipid-linked intermediate (Figure 17.14). **Dolichol phosphate** (structure on p. 350) at the cytoplasmic surface of the ER membrane serves as glycosyl acceptor of *N*-acetylglucosamine. The GlcNAc-pyrophosphoryldolichol is an acceptor for stepwise glycosylation and formation of a branched (Man)₅(GlcNAc)₂-pyro-phosphoryldolichol on the cytosolic side of the membrane. This intermediate is then reoriented to the luminal surface of the ER membrane, and four additional mannose and then three glucose residues are sequentially added to complete the structure. The complete oligosaccharide is then transferred from its dolichol carrier to an asparagine residue of the polypeptide as it emerges into the ER lumen. Thus *N*-glycosylation is **cotranslational**, that is, occurs as the protein is being synthesized, hence it can affect protein folding.

Processing or modification of the oligosaccharide by **glycosidases** involves removal of some sugar residues from the newly transferred structure. The glucose residues, which were required for transfer of the oligosaccharide from the dolichol carrier, are sequentially removed, as is one mannose. These alterations mark the glycoprotein for transport to the Golgi apparatus where further trimming by glycosidases may occur. Additional sugars may also be added by a variety of glycosyltransferases. The resulting *N*-linked oligosaccharides are diverse, but two classes are distinguishable. Each has a common core region (GlcNAc₂Man₃) linked to asparagine and originating from the dolichol-linked intermediate. The **high-mannose** type includes mannose residues in a variety of linkages and shows less processing from the dolichol-linked intermediate. The **complex** type is more highly processed and diverse, with a larger variety of sugars and linkages. Examples of mature oligosaccharides are shown in Figure 17.15.

The second major class of glycoproteins have sugars that are bound through either serine or threonine hydroxyl groups. Such O-linked glycosylation occurs only after the protein has reached the Golgi apparatus, hence **O-glycosylation** is posttranslational and occurs only on fully folded proteins. O-linked carbohydrates always involve N-acetylgalactosamine attachment to a serine or threonine residue of the protein. There is no defined amino acid sequence in which the

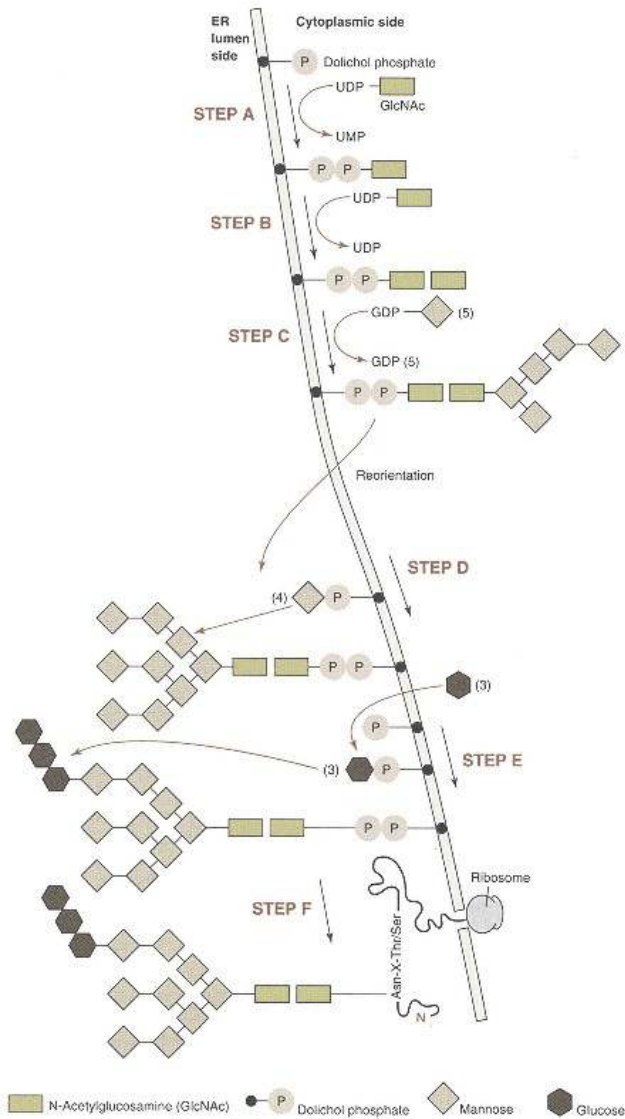

Figure 17.14

Biosynthesis of N-linked oligosaccharides at the surface of the endoplasmic reticulum.

Synthesis is initiated on the cytoplasmic face of the ER membrane by transfer of N-acetylglucosamine phosphate to a dolichol acceptor (step A) followed by formation of the first glycosidic bond upon transfer of a second residue of N-acetylglucosamine (step B). Five residues of mannose are then added sequentially (step C) from a GDP mannose carrier. At this stage lipid-linked oligosaccharide is reoriented to the luminal face of the membrane, and additional mannose (step D) and glucose (step E) residues are transferred from dolichol-linked intermediates. Dolichol sugars are generated from cytosol nucleoside diphosphate sugars. The completed oligosaccharide is finally transferred to a protein in the process of being synthesized at the membrane surface; signal peptide may have already been cleaved at this point.

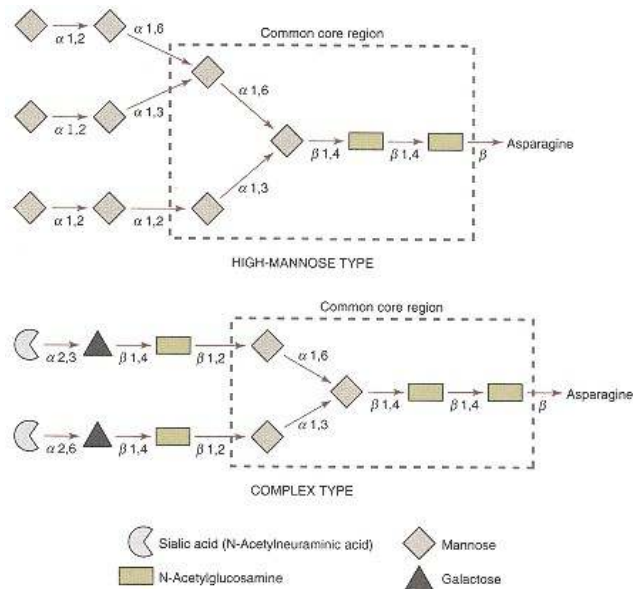

Figure 17.15
Structure of *N*-linked oligosaccharides.
 Basic structures of both types of *N*-linked oligosaccharides are shown. In each case structure is derived from that of the initial dolichol-linked oligosaccharide through action of glycosidases and glycosyltransferases. Note the variety of glycosidic linkages involved in these structures.

serine or threonine must occur, but only residues whose side chains are in an appropriate environment on the protein surface serve as acceptors for the GalNAc-transferase.

Sequential addition of sugars to the GalNAc acceptor follows, using the same glycosyltransferases that modified *N*-linked oligosaccharides in the Golgi apparatus. The structures synthesized depend on types and amounts of glycosyltransferases in a given cell. If an acceptor is a substrate for more than one transferase, the amount of each transferase controls the competition between them. Some oligosaccharides may be formed that are not acceptors for any glycosyltransferase present, hence no further growth of the chain occurs. Other structures may be excellent acceptors that continue to grow until completed by one of a number of nonacceptor termination sequences. These processes can lead to many different oligosaccharide structures on otherwise identical proteins, so heterogeneity in glycoproteins is common. Examples are shown in Figure 17.16.

17.5— Organelle Targeting and Biogenesis

Sorting of Proteins Targeted for Lysosomes Occurs in the Secretory Pathway

Protein transport from ER to Golgi apparatus occurs through carrier vesicles that bud from the ER. This transport requires GTP; inhibitors of oxidative phosphorylation cause proteins to accumulate in the ER and vesicles. Sorting of proteins for their ultimate destinations occurs in conjunction with their glycosylation and proteolytic trimming as they pass through the cis, medial, and trans elements of the Golgi apparatus.

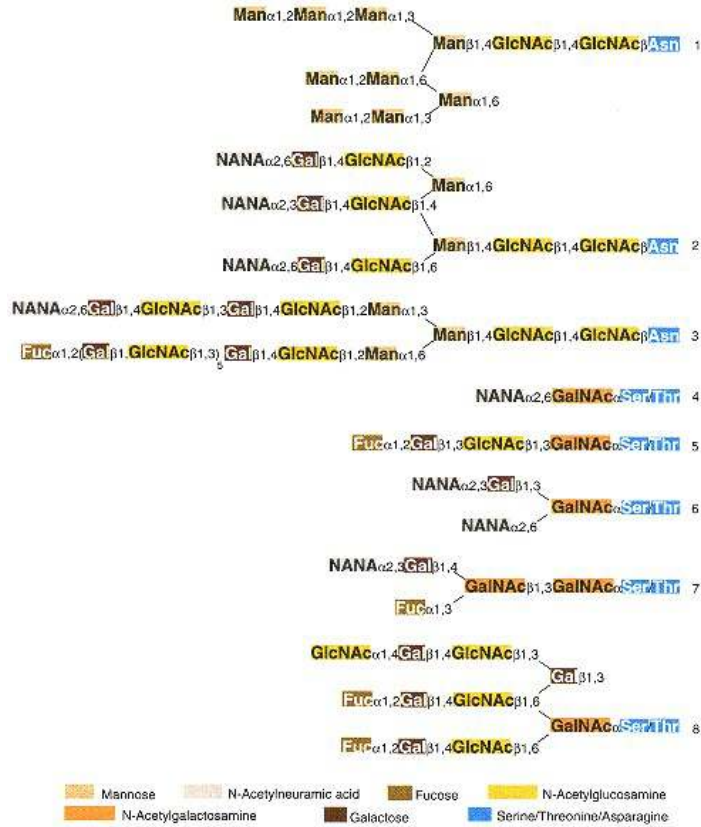

Figure 17.16

Examples of oligosaccharide structure.

Structures 1–3 are typical N-linked oligosaccharides of high-mannose (1) and complex types (2, 3); note the common core structure from the protein asparagine residue through the first branch point. Structures 4–8 are common O-linked oligosaccharides that may be quite simple or highly complex. Note that although the core structure (GalNAc-Ser/Thr) is unlike that of N-linked oligosaccharides, the termini can be quite similar (e.g., structures 2 and 6, 3, and 7). Abbreviations: Man = mannose; Gal = galactose; Fuc = fucose; GlcNAc = N-acetylglucosamine; GalNAc = N-acetylgalactosamine; NANA = N-acetylneuraminic acid (sialic acid). Adapted from J. Paulson, *Trends Biochem. Sci.* 14:272, 1989.

CLINICAL CORRELATION 17.5

I-Cell Disease

I-cell disease (mucopolidosis II) and pseudo-Hurler polydystrophy (mucopolidosis III) are related diseases that arise from defects in lysosomal enzyme targeting because of a deficiency in the enzyme that transfers N-acetylglucosamine phosphate to the high mannose-type oligosaccharides of proteins destined for the lysosome. Fibroblasts from affected individuals show dense inclusion bodies (hence I-cells) and are defective in multiple lysosomal enzymes that are found secreted into the medium. Patients have abnormally high levels of lysosomal enzymes in their sera and other body fluids. The disease is characterized by severe psychomotor retardation, many skeletal abnormalities, coarse facial features, and restricted joint movement. Symptoms are usually observable at birth and progress until death, usually by age 8. Pseudo-Hurler polydystrophy is a much milder form of the disease. Onset is usually delayed until the age of 2–4 years, the disease progresses more slowly, and patients survive into adulthood. Prenatal diagnosis of both diseases is possible, but there is as yet no definitive treatment.

For a review of lysosomal enzyme trafficking, see Kornfeld, S. *J. Clin. Invest.* 77:1, 1986. For a comprehensive review of these diseases, see Kornfeld, S., and Sly, W. S., I-cell disease and pseudo-Hurler polydystrophy. In: C. R. Scriver, A. L. Beaudet, W. S. Sly, and D. Valle (Eds.), *The Molecular and Metabolic Basis of Inherited Disease*, 7th ed. New York: McGraw-Hill, 1995, pp. 2495–2508.

The best understood sorting process is targeting of specific glycoproteins to lysosomes. In the cis Golgi some aspect of tertiary structure allows lysosomal proteins to be recognized by a glycosyltransferase that attaches N-acetylglucosamine phosphate (GlcNAc-P) to high-mannose type oligosaccharides. A glycosidase then removes the GlcNAc, forming an oligosaccharide that contains mannose 6-phosphate (Figure 17.17) that is recognized by a receptor protein responsible for compartmentation and vesicular transport of these proteins to lysosomes. Other oligosaccharide chains on the proteins may be further processed to form complex type structures, but the mannose 6-phosphate determines the lysosomal destination of these proteins. Patients with I-cell disease lack the GlcNAc-P glycosyltransferase and cannot correctly mark lysosomal enzymes for their destination. Thus the enzymes are secreted from the cell (see Clin. Corr. 17.5).

Other sorting signals are reasonably well understood. Proteins are retained in the ER lumen in response to a C-terminal KDEL (Lys-Asp-Glu-Leu) sequence, and a different sequence in an exposed C terminus signals retention in the ER membrane. Transmembrane domains have been identified that result in reten-

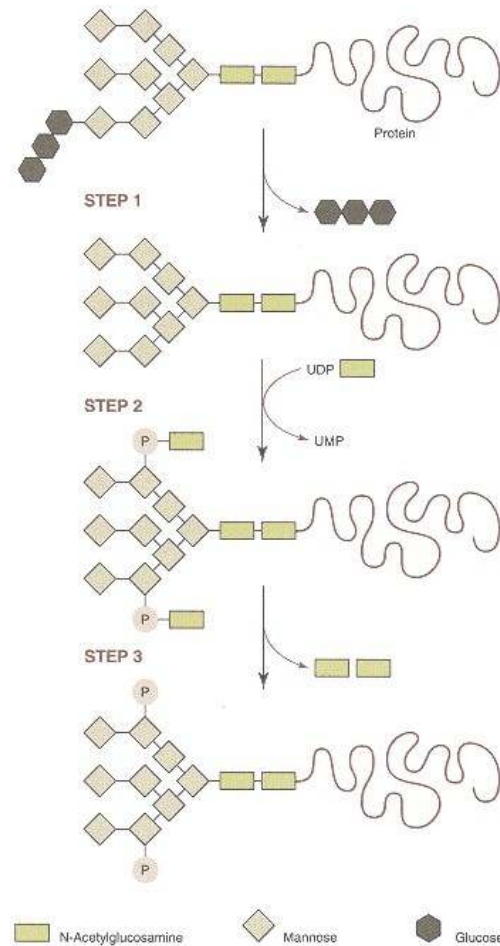

Figure 17.17

Targeting of enzymes to lysosomes.

Completed *N*-linked glycoprotein is released from ER membrane, and during transport to and through the Golgi apparatus the oligosaccharide is modified by glycosidases that remove glucose residues (step 1). Some mannose residues may also be removed. An element of protein structure is then recognized by a glycosyltransferase that transfers one or sometimes two *N*-acetylglucosamine phosphate residues to the oligosaccharide (step 2). A glycosidase removes *N*-acetylglucosamine, leaving one or two mannose 6-phosphate residues on the oligosaccharide (step 3). The protein is then recognized by a mannose 6-phosphate receptor and directed to lysosomes.

Adapted from R. Kornfeld and S. Kornfeld, *Annu. Rev. Biochem.* 54:631, 1985.

tion in the Golgi. Polypeptide-specific glycosylation and sulfation of some glycoprotein hormones in the anterior pituitary mediate their sorting into storage granules. Polysialic acid modification of a neural cell adhesion protein appears to be both specific to the protein and regulated developmentally. Many other sorting signals must still be deciphered to explain fully how the Golgi apparatus directs proteins to its own subcompartments, various storage and secretory granules, and specific elements of the plasma membrane.

The secretory pathway directs proteins to lysosomes, the plasma membrane, or outside the cell. Proteins of the ER and Golgi apparatus are targeted through partial use of the pathway. For example, localization of proteins on either side of or spanning the ER membrane can utilize the signal recogni-

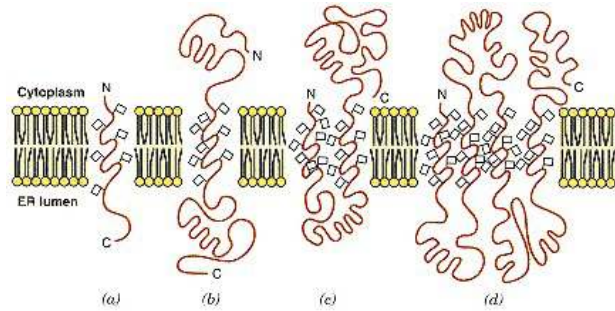

Figure 17.18

Topology of proteins at membranes of endoplasmic reticulum.

Proteins are shown in several orientations with respect to the membrane.

In (a) the protein is anchored to the luminal surface of the membrane by an uncleaved signal peptide.

In (b) the signal sequence is not near the N terminus; a domain of the protein was synthesized before emergence of signal peptide. Insertion of the internal signal sequence, followed by completion of translation, resulted in a protein with a cytoplasmic N-terminal domain, a membrane-spanning central segment, and a C-terminal domain in the ER lumen.

Diagram (c) shows a protein with the opposite orientation: an N-terminal signal sequence, which might also have been cleaved by signal peptidase, resulted in extrusion of a segment of protein into the ER lumen. A second hydrophobic anchoring sequence remained membrane associated and prevented passage of the rest of the protein through the membrane, thus allowing formation of a C-terminal cytoplasmic domain.

In (d), several internal signal and anchoring sequences allow various segments of the protein to be oriented on each side of the membrane.

tion particle in slightly different ways (Figure 17.18). If the signal sequence is downstream from the amino terminus of the protein, the amino end may not be inserted into the membrane and may remain on the cytoplasmic surface. Internal hydrophobic anchoring sequences within a protein can allow much of the sequence either to remain on the cytoplasmic surface or to be retained, anchored on the luminal surface of the ER membrane. Multiple anchoring sequences in a single polypeptide can cause it to span the membrane several times and thus be largely buried in it. Such hydrophobic sequences are separated by polar loops whose orientation is determined by positively charged flanking residues that predominate on the cytoplasmic side of the membrane.

Import of Proteins by Mitochondria Requires Specific Signals

Mitochondria provide a particularly complex targeting problem since specific proteins are located in the mitochondrial matrix, inner or outer membrane, or intermembrane space. Most of these proteins are synthesized in the cytosol on free ribosomes and imported into the mitochondrion, and most are synthesized as larger preproteins; N-terminal presequences mark the protein not only for the mitochondrion but also for a specific subcompartment. The **mitochondrial matrix targeting signal** is not a specific sequence, but rather a positively charged amphiphilic α -helix. With the aid of a protein chaperone, it is recognized by a **mitochondrial receptor** and the protein is translocated across both membranes and into the mitochondrial matrix in an energy-dependent reaction. Passage occurs at adhesion sites where the inner and outer membranes are close together. Proteases remove the matrix targeting signal but may leave other sequences that further sort the protein within the mitochondrion. For example, a clipped precursor of cytochrome- b_2 is moved back across the inner membrane in response to a hydrophobic signal sequence. Further proteolysis frees the protein in the intermembrane space. In contrast, cytochrome- c apoprotein (without heme) binds at the outer membrane and is passed into the intermembrane space. There it acquires its heme and undergoes a conformational change that prevents return to the cytosol. Outer membrane localization can utilize the matrix targeting mechanism to translocate part of the protein, but a large apolar sequence blocks full transfer and leaves a membrane-bound protein with a C-terminal domain on the surface of the mitochondrion.

Targeting to Other Organelles Requires Specific Signals

Nuclei must import many proteins involved in their own structure and for DNA replication, transcription, and ribosome biogenesis. Nuclear pores permit the

passage of small proteins, but larger proteins are targeted by nuclear localization signals that include clusters of basic amino acids. Some nuclear proteins may be retained in the nucleus by forming complexes within the organelle. Peroxisomes contain a limited array of enzymes. One targeting signal is a carboxy-terminal tripeptide, Ser-Lys-Leu (SKL). An N-terminal targeting signal also exists, and others may yet be discovered.

A different targeting problem exists for proteins that reside in more than one subcellular compartment. Sometimes gene duplication and divergence have resulted in different targeting signals on closely related mature polypeptides. **Alternative transcription initiation sites** or pre-mRNA splicing can generate different messages from a single gene. An example of the latter is seen in a calcium-calmodulin-dependent protein kinase; alternatively spliced mRNAs differ with respect to an internal segment that encodes a nuclear localization signal. Without this segment, the protein remains in the cytosol. **Alternative translation initiation sites** lead to two forms of rat liver fumarase, one of which includes a mitochondrial targeting sequence while the other does not and remains in the cytosol. A suboptimal localization signal can lead to inefficient targeting and a dual location, as is seen in the partial secretion of an inhibitor of the plasminogen activator. Finally, some proteins contain more than one targeting signal, which must compete with each other.

17.6—

Further Posttranslational Protein Modifications

Several additional maturation events may modify newly synthesized polypeptides to help generate their final, functional structures. Many of these events are very common, while others are specialized to one or a few known instances.

CLINICAL CORRELATION 17.6

Familial Hyperproinsulinemia

Familial hyperproinsulinemia, an autosomal dominant condition, results in approximately equal amounts of insulin and an abnormally processed proinsulin being released into the circulation. Although affected individuals have high levels of proinsulin in their blood, they are apparently normal in terms of glucose metabolism, being neither diabetic nor hypoglycemic. The defect was originally thought to result from a deficiency of one of the proteases that process proinsulin. Three enzymes process proinsulin: endopeptidases that cleave the Arg31–Arg32 and Lys64–Arg65 peptide bonds, and a carboxypeptidase. In several families the defect is the substitution of Arg65 by His or Leu, which prevents cleavage between the C-peptide and the A chain of insulin, resulting in secretion of a partially processed proinsulin. In one family a point mutation (His10 → Asp10) causes the hyperproinsulinemia, but how this mutation interferes with processing is not known.

Steiner, D. F., Tager, H. S., Naujo, K., Chan, S. J., and Rubenstein, A. H. Familial syndromes of hyperproinsulinemia with mild diabetes. In: C. R. Scriver, A. L. Beaudet, W. S. Sly, and D. Valle (Eds.), *The Molecular and Metabolic Basis of Inherited Disease*, 7th ed. New York: McGraw-Hill, 1995, pp. 897–904.

Insulin Biosynthesis Involves Partial Proteolysis

Partial proteolysis of proteins is a common maturation step. Sequences can be removed from either end or from within the protein. Proteolysis in the ER and Golgi apparatus helps to mature the protein hormone insulin (Figure 17.19). **Preproinsulin** encoded by mRNA is inserted into the ER lumen. Signal peptidase cleaves the signal peptide to generate **proinsulin**, which folds to form the correct disulfide linkages. Proinsulin is transported to the Golgi apparatus where it is packaged into secretory granules. An internal connecting peptide (**C peptide**) is removed by proteolysis, and mature insulin is secreted. In familial hyperproinsulinemia, processing is incomplete (see Clin. Corr. 17.6).

This pathway for insulin biosynthesis has advantages over synthesis and binding of two separate polypeptides. First, it ensures production of equal amounts of A and B chains without coordination of two translational activities. Second, proinsulin folds into a three-dimensional structure in which the cysteine residues are placed for correct disulfide bond formation. Proinsulin can be reduced and denatured but refolds correctly to form proinsulin. Renaturation of reduced and denatured insulin is less efficient, and incorrect disulfide linkages are also formed. Correct formation of insulin from separately synthesized chains might have required evolution of a helper protein or molecular chaperone.

Proteolysis Leads to Zymogen Activation

Precursor protein cleavage is a common means of enzyme activation. Digestive proteases are classic examples of this phenomenon (see p. 1059). Inactive **zymogen** precursors are packaged in storage granules and activated by proteol-

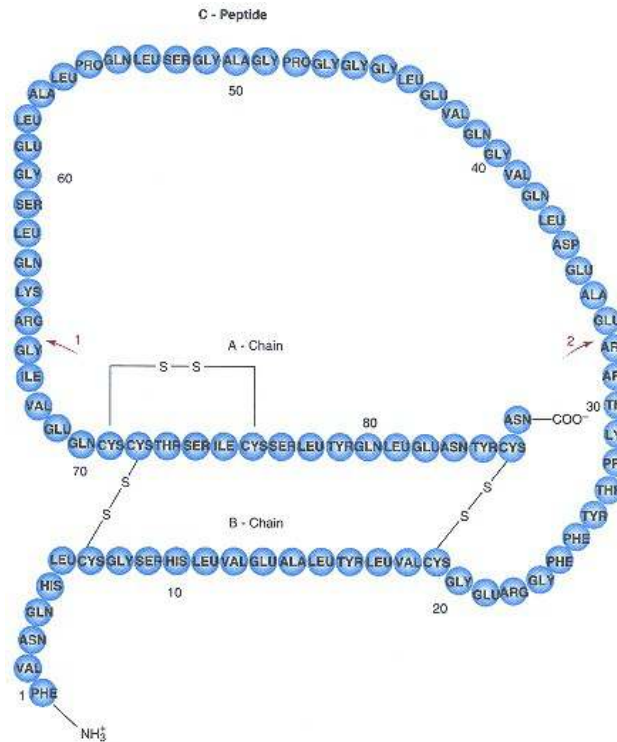

Figure 17.19

Maturation of human proinsulin.

After cleavage at two sites indicated by arrows, the arginine residues 31, 32, and lysine residue 64 are removed to produce insulin and C-peptide.

Redrawn from G. I. Bell, W. F. Swain, R. Pictet,

B. Cordell, H. M. Goodman, and W. J. Putter, *Nature* 282:525, 1979.

ysis upon secretion. Thus trypsinogen is cleaved to give an amino-terminal peptide plus trypsin, and chymotrypsinogen is cleaved to form chymotrypsin and two peptides.

Amino Acids Can Be Modified after Incorporation into Proteins

Only 20 amino acids are encoded genetically and incorporated during translation. **Posttranslational modification** of proteins, however, leads to formation of 100 or more different amino acid derivatives in proteins. Modification may be permanent or highly reversible. The amounts of modified amino acids may be small, but they often play a major functional role in proteins. Examples are listed in Table 17.10.

Protein amino termini are frequently modified. Protein synthesis is initiated using methionine, but in the majority of proteins the amino-terminal residue is not methionine; proteolysis has occurred. The amino terminus is then sometimes modified by, for example, acetylation or myristoylation. Amino-terminal glutamine residues spontaneously cyclize; one possible result is the stabilization of the protein. Amino terminal sequences are occasionally lengthened by the addition of an amino acid (see Section 17.8, Protein Degradation and Turnover).

Posttranslational disulfide bond formation is catalyzed by a **disulfide isomerase**. The cystine-containing protein is conformationally stabilized. Disulfide formation can prevent unfolding of proteins and their passage across membranes, so it also becomes a means of localization. As seen in the case of insulin, disulfide bonds can covalently link separate polypeptides and be necessary

for biological function. Cysteine modification also occurs; multiple sulfatase deficiency arises from reduced ability to carry out a posttranslational modification (see Clin. Corr 17.7).

Methylation of lysine -amino groups occurs in histone proteins and may modulate their interactions with DNA. A fraction of the H2A histone is also modified through isopeptide linkage of a small protein, ubiquitin, from its C-terminal glycine to a lysine -amino group on the histone. A role in DNA interactions is postulated. Biotin is also linked to proteins through amide linkages to lysine.

Serine and threonine hydroxyl groups are major sites of glycosylation and of reversible phosphorylation by protein kinases and protein phosphatases. A classic example of phosphorylation of a serine residue is glycogen phosphorylase, which is modified by phosphorylase kinase (see p. 322). Tyrosine kinase activity is a property of many growth factor receptors; growth factor binding stimulates cell division and the proliferation of specific cell types. Oncogenes, responsible in part for the proliferation of tumor cells, often have tyrosine kinase activity and show strong homology with normal growth factor receptors. Dozens of other examples exist; together the protein kinases and protein phosphatases control the activity of many proteins that are central to normal and abnormal cellular development.

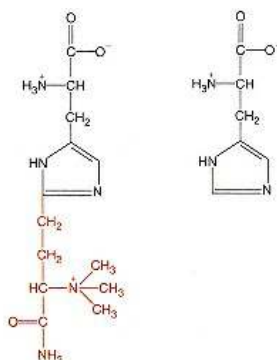

Figure 17.20
Diphthamide (left) is a posttranslational modification of a specific residue of histidine (right) in EF-2.

ADP-ribosylation of EF-2 at a modified histidine residue represents a doubling of posttranslational modifications. First, a specific EF-2 histidine residue is modified to generate the diphthamide derivative (Figure 17.20) of the functional protein. This modification is probably not absolutely required since yeast mutants that cannot make diphthamide survive. ADP-ribosylation of the diphtham-

TABLE 17.10 Modified Amino Acids in Proteins^a

<i>Amino Acid</i>	<i>Modifications Found</i>
Amino terminus	Formylation, acetylation, aminoacylation, myristoylation, glycosylation
Carboxyl terminus	Methylation, glycosyl-phosphatidylinositol anchor formation, ADP-ribosylation
Arginine	<i>N</i> -Methylation, ADP-ribosylation
Asparagine	<i>N</i> -Glycosylation, <i>N</i> -methylation, deamidation
Aspartic acid	Methylation, phosphorylation, hydroxylation
Cysteine	Cystine formation, selenocysteine formation, palmitoylation, linkage to heme, <i>S</i> -glycosylation, prenylation
Glutamic acid	Methylation, γ -carboxylation, ADP-ribosylation
Glutamine	Deamidation, cross-linking, pyroglutamate formation
Histidine	Methylation, phosphorylation, diphthamide formation, ADP-ribosylation
Lysine	<i>N</i> -acetylation, <i>N</i> -methylation, oxidation, hydroxylation, cross-linking, ubiquitination, allysine formation
Methionine	Sulfoxide formation
Phenylalanine	β -Hydroxylation and glycosylation
Proline	Hydroxylation, glycosylation
Serine	Phosphorylation, glycosylation, acetylation
Threonine	Phosphorylation, glycosylation, methylation
Tryptophan	β -Hydroxylation, dione formation
Tyrosine	Phosphorylation, iodination, adenylation, sulfonylation, hydroxylation

Source: Adapted from R. G. Krishna and F. Wold, Post-translational modification of proteins. In: A. Meister (Ed.), *Advances in Enzymology*, Vol. 67. New York: Wiley-Interscience, 1993, pp. 265–298.

^a The listing is not comprehensive and some of the modifications are very rare. Note that no derivatives of alanine, glycine, isoleucine, and valine have been identified in proteins.

CLINICAL CORRELATION 17.7**Absence of Posttranslational Modification: Multiple Sulfatase Deficiency**

A variety of biological molecules are sulfated; examples include glycosaminoglycans, steroids, and glycolipids. Ineffective sulfation of the glycosaminoglycans chondroitin sulfate and keratan sulfate of cartilage results in major skeletal deformities. Degradation of sulfated molecules depends on the activity of a group of related sulfatases, most of which are located in lysosomes. Multiple sulfatase deficiency is a rare lysosomal storage disorder that combines features of metachromatic leukodystrophy and mucopolysaccharidosis. Affected individuals develop slowly and from their second year of life lose the abilities to stand, sit, or speak; physical deformities and neurological deficiencies develop and death before age 10 is usual. Biochemically, multiple sulfatase deficiency is characterized by severe lack of all the sulfatases. In contrast, deficiencies in individual sulfatases are also known, and several distinct diseases are linked to single enzyme defects.

The molecular defect in multiple sulfatase deficiency arises from a deficiency in a posttranslational modification that is common to all sulfatase enzymes and is necessary for their enzymatic activity. In each case a cysteine residue of the enzyme is normally converted to 2-amino-3-oxopropionic acid; the $-\text{CH}_2\text{SH}$ side chain of cysteine becomes a $-\text{CHO}$ (aldehyde) group, which may itself react with amino or hydroxyl groups of the enzyme, a cofactor, and so on. Fibroblasts from individuals with multiple sulfatase deficiency catalyze this modification with significantly lowered efficiency, and the unmodified sulfatases are catalytically inactive.

Schmidt, B., Selmer, T., Ingendoh, A, and von Figura, K. A novel amino acid modification in sulfatases that is deficient in multiple sulfatase deficiency. *Cell* 82:271–278, 1995.

ide by diphtheria toxin then inhibits EF-2 activity. Other instances of physiological ADP-ribosylation not mediated by bacterial toxins are reversible.

Formation of γ -carboxyglutamate from glutamic acid residues occurs in several blood-clotting proteins including prothrombin and factors VII, IX, and X. The γ -carboxyglutamate residues chelate calcium ion, which is required for normal blood clotting (see p. 963). In each case the modification requires vitamin K and can be blocked by coumarin derivatives, which antagonize vitamin K. As a result, the rate of coagulation is greatly decreased.

Collagen Biosynthesis Requires Many Posttranslational Modifications

Collagen, the most abundant protein (or family of related proteins) in the human body, is a fibrous protein that provides the structural framework for tissues and organs. It undergoes a wide variety of posttranslational modifications that directly affect its structure and function, and defects in its modification result in serious diseases. Collagen is an excellent example of the importance of posttranslational modification.

Different species of collagen, designated types I, II, III, IV, and so on (see Table 2.11) are encoded on several chromosomes and expressed in different tissues. Their amino acid sequences differ, but their overall structural similarity suggests a common evolutionary origin. Each collagen polypeptide, designated an α chain, has a repeating sequence Gly-X-Y that is about 1000 residues long. Every third residue is glycine, about one-third of the X positions are occupied by proline and a similar number of Y positions are 4-hydroxyproline, a posttranslationally modified form of proline. Proline and hydroxyproline residues impart considerable rigidity to the structure, which exists as a polyproline type II helix (Figure 17.21; see also p. 52). A collagen molecule includes three α chains intertwined in a collagen triple helix in which the glycine residues occupy the center of the structure.

Procollagen Formation in the Endoplasmic Reticulum and Golgi Apparatus

Collagen α chain synthesis starts in the cytosol, where the amino-terminal signal sequences bind signal recognition particles. Precursor forms, designated, for example, prepro $\alpha 1(\text{I})$, are extruded into the ER lumen and the signal peptides are cleaved. Hydroxylation of proline and lysine residues occurs **cotranslationally**, before assembly of a triple helix. Prolyl 4-hydroxylase requires an $-\text{X-Pro}-$

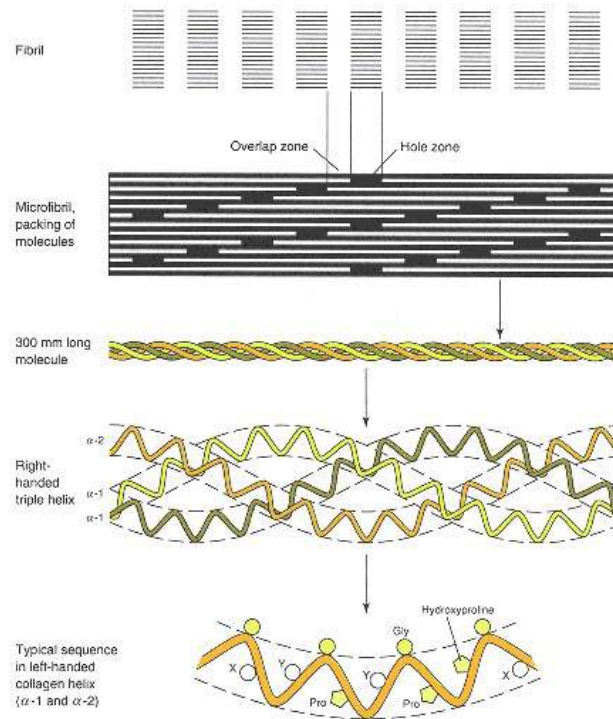

Figure 17.21

Collagen structure, illustrating the regularity of the primary sequence, the left-handed helix, the right-handed triple helix, the 300-nm molecule, and the organization of molecules in a typical fibril, within which collagen molecules are cross-linked.

Gly- sequence (hence 4-hydroxyproline is found only at Y positions in the -Gly-X-Y- sequence). Also present in the ER is a prolyl 3-hydroxylase, which modifies a smaller number of proline residues, and a lysyl hydroxylase, which modifies some of the Y-position lysine residues. These hydroxylases require Fe^{2+} and ascorbic acid, the extent of modification depending on the specific α -chain type. Proline hydroxylation stabilizes collagen and lysine hydroxylation provides sites for interchain cross-linking and for glycosylation by specific glycosyl transferases of the ER. Asparagine residues are also glycosylated at this point, eventually leading to high mannose-type oligosaccharides.

Triple helix assembly occurs after the polypeptide chains have been completed. Carboxy-terminal globular proprotein domains fold and disulfide bonds are formed. Interaction of these domains initiates winding of the triple helix from the carboxyl end toward the amino terminus. The completed triple helix, with globular proprotein domains at each end, moves to the Golgi apparatus where oligosaccharides are processed and matured. Sometimes tyrosine residues are modified by sulfation and some serines are phosphorylated. The completed procollagen is then released from the cell via secretory vesicles.

Collagen Maturation

Conversion of procollagen to collagen occurs extracellularly. The amino-terminal and carboxyl-terminal propeptides are cleaved by separate proteases that may also be type specific. Concurrently, the triple helices assemble into fibrils

TABLE 17.11 Selected Disorders in Collagen Biosynthesis and Structure

<i>Disorder</i>	<i>Collagen Defect</i>	<i>Clinical Manifestations</i>
Osteogenesis imperfecta 1	Decreased synthesis of type I	Long bone fractures prior to puberty
Osteogenesis imperfecta 2	Point mutations and exon rearrangements in triple helical regions	Perinatal lethality; malformed and soft, fragile bones
Ehlers–Danlos IV	Poor secretion, premature degradation of type III	Translucent skin, easy bruising, arterial and colon rupture
Ehlers–Danlos VI	Decreased hydroxylysine in types I and III	Hyperextensive skin, joint hypermobility
Ehlers–Danlos VII	Type I procollagen accumulation: N-terminal propeptide not cleaved	Joint hypermobility and dislocation
Cutis laxa (occipital horn syndrome)	Decreased hydroxylysine due to poor Cu distribution	Lax, soft skin; occipital horn formation in adolescents

and the collagen is stabilized by extensive cross-linking (see Figure 2.39). Lysyl oxidase converts some lysine or hydroxylysine to the reactive aldehydes, allysine, or hydroxyallysine. These residues condense with each other or with lysine or hydroxylysine residues in adjacent chains to form Schiff's base and aldol cross-links. Further and less well-characterized reactions can involve other residues including histidines and can link three α chains. Defects at many of these steps are known. Some of the best characterized are listed in Table 17.11 and described in Clin. Corr. 17.8.

17.7—

Regulation of Translation

Translation requires considerable energy, and the formation of functioning proteins has significant consequences for the cell. It is logical that the process is carefully controlled, both globally and for specific proteins. The most efficient and common mechanism of regulation is at the initiation stage.

The best understood means of overall regulation of translation involves the reversible phosphorylation of eIF-2a. Under conditions that include nutrient starvation, heat shock, and viral infection, eIF-2a is phosphorylated by a specific kinase. Phosphorylated eIF-2a \cdot GDP binds tightly to eIF-2b, the guanine nucleotide exchange factor, which is present in limiting amounts. Since eIF-2b is unavailable for nucleotide exchange, no eIF-2a \cdot GTP is available for initiation. Phosphorylation can be catalyzed by a **heme-regulated inhibitor kinase**, which, in the absence of heme, is activated by autophosphorylation. This kinase is present in many cells but is best studied in reticulocytes that synthesize hemoglobin. Deficiencies in energy supply or any heme precursor activate the kinase. A related **double-stranded RNA-dependent kinase** is autophosphorylated and activated in response to binding of ds-RNA that results from many viral infections. Production of this kinase is also induced by interferon. Initiation factor eIF-4e (a component of the cap binding protein eIF-4f) is activated by phosphorylation in response to, for example, growth factors and is inactivated by a protein phosphatase following, for example, viral infection. These effects may be greatest in the translation of mRNAs with long, highly structured leader sequences that need to be unwound to allow identification of a translational start site.

Regulation of translation of specific genes also occurs. A clear example is the regulation by iron of synthesis of the iron-binding protein, ferritin. In

CLINICAL CORRELATION 17.8**Defects in Collagen Synthesis****Ehlers–Danlos Syndrome, Type IV**

Ehlers–Danlos syndrome is a group of at least ten disorders that are clinically, genetically, and biochemically distinguishable, but that share manifestations of structural weaknesses in connective tissue. The usual problems are fragility and hyperextensibility of skin and hypermobility of the joints. The weaknesses result from defects in collagen structure. For example, type IV Ehlers–Danlos syndrome is caused by defects in type III collagen, which is particularly important in skin, arteries, and hollow organs. Characteristics include thin, translucent skin through which veins are easily seen, marked bruising, and sometimes an appearance of aging in the hands and skin. Clinical problems arise from arterial rupture, intestinal perforation, and rupture of the uterus during pregnancy or labor. Surgical repair is difficult because of tissue fragility. The basic defects in type IV Ehlers–Danlos appear to be due to changes in the primary structure of type III chains. These arise from point mutations that result in replacement of glycine residues and thus disruption of the collagen triple helix, and from exon-skipping, which shortens the polypeptide and can result in inefficient secretion and decreased thermal stability of the collagen, and in abnormal formation of type III collagen fibrils. In some cases type III collagen is accumulated in the rough ER, overmodified, and degraded very slowly.

Superti-Furga, A., Gugler, E., Gitzelmann, R., and Steinmann, B. Ehlers–Danlos syndrome type IV: a multi-exon deletion in one of the two COL 3A1 alleles affecting structure, stability, and processing of type III procollagen. *J. Biol. Chem.* 263:6226, 1988.

Osteogenesis Imperfecta

Osteogenesis imperfecta is a group of at least four clinically, genetically, and biochemically distinguishable disorders, all characterized by multiple fractures with resultant bone deformities. Several variants result from mutations producing modified α (I) chains. In the clearest example a deletion mutation causes absence of 84 amino acids in the α 1(I) chain. The shortened α 1(I) chains are synthesized, because the mutation leaves the reading frame in register. The short α 1(I) chains associate with normal α 1(I) and α 2(I) chains, thereby preventing normal collagen triple helix formation, with resultant degradation of all the chains, a phenomenon aptly named "protein suicide." Three-fourths of all the collagen molecules formed have at least one short (defective) α 1(I) chain, an amplification of the effect of a heterozygous gene defect. Other forms of osteogenesis imperfecta result from point mutations that substitute another amino acid for one of the glycines. Since glycine has to fit into the interior of the collagen triple helix, these substitutions destabilize that helix.

Barsh, G. S., Roush, C. L., Bonadio, J., Byers, P. H., and Gelinas, R. E. Intron mediated recombination causes an α (I) collagen deletion in a lethal form of osteogenesis imperfecta. *Proc. Natl. Acad. Sci. USA* 82:2870, 1985.

Scurvy and Hydroxyproline Synthesis

Scurvy results from dietary deficiency of ascorbic acid. Most animals can synthesize ascorbic acid from glucose but humans have lost this enzymatic mechanism. Among other problems, ascorbic acid deficiency causes decreased hydroxyproline synthesis because prolyl hydroxylase requires ascorbic acid. The hydroxyproline provides additional hydrogen-bonding atoms that stabilize the collagen triple helix. Collagen containing insufficient hydroxyproline loses temperature stability, becoming less stable than normal collagen at body temperature. The resultant clinical manifestations are distinctive and understandable: suppression of the orderly growth process of bone in children, poor wound healing, and increased capillary fragility with resultant hemorrhage, particularly in the skin. Severe ascorbic acid deficiency leads secondarily to a decreased rate of procollagen synthesis.

Crandon, J. H., Lund, C. C., and Dill, D. B. Experimental human scurvy. *N. Engl. J. Med.* 223:353, 1940.

Deficiency of Lysyl Hydroxylase

In type VI Ehlers–Danlos syndrome lysyl hydroxylase is deficient. As a result type I and III collagens in skin are synthesized with decreased hydroxylysine content, and subsequent cross-linking of collagen fibrils is less stable. Some cross-linking between lysine and allysine occurs but these are not as stable and do not mature as readily as do hydroxylysine-containing cross-links. In addition, carbohydrates add to the hydroxylysine residues but the function of this carbohydrate is unknown. The clinical features include marked hyperextensibility of the skin and joints, poor wound healing, and musculoskeletal deformities. Some patients with this form of Ehlers–Danlos syndrome have a mutant form of lysyl hydroxylase with a higher Michaelis constant for ascorbic acid than the normal enzyme. Accordingly, they respond to high doses of ascorbic acid.

Pinnell, S. R., Krane, S. M., Kenzora, J. E., and Glimcher, M. J. A heritable disorder of connective tissue: hydroxylysine-deficient collagen disease. *N. Engl. J. Med.* 286:1013, 1972.

Ehlers–Danlos Syndrome, Type VII

In Ehlers–Danlos syndrome, type VII, skin bruises easily and is hyperextensible, but the major manifestations are dislocations of major joints, such as hips and knees. Laxity of ligaments is caused by incomplete removal of the amino-terminal propeptide of the procollagen chains. One variant of the disease results from deficiency of procollagen *N*-protease. A similar deficiency occurs in the autosomal recessive disease called dermatosparaxis of cattle, sheep, and cats, in which skin fragility is so extreme as to be lethal. In other variants the pro α 1(I) and pro α 2(I) chains lack amino acids at the cleavage site because of skipping of one exon in the genes. This prevents normal cleavage by procollagen *N*-protease.

Cole, W. G., Chan, W., Chambers, G. W., Walker, I. D., and Bateman, J. F. Deletion of 24 amino acids from the pro α (I) chain of type I procollagen in a patient with the Ehlers–Danlos syndrome type VII. *J. Biol. Chem.* 261:5496, 1986.

Occipital Horn Syndrome

In type IX Ehlers–Danlos syndrome and in Menke's (kinky-hair) syndrome there is thought to be a deficiency in lysyl oxidase activity. In type IX Ehlers–Danlos syndrome there are consequent cross-linking defects manifested in lax, soft skin and in the appearance during adolescence of bony occipital horns. Copper-deficient animals have deficient cross-linking of elastin and collagen, apparently because of the requirement for cuprous ion by lysyl oxidase.

(continued)

In Menke's (kinky-hair) syndrome there is a defect in intracellular copper transport that results in low activity of lysyl oxidase, and in occipital horn syndrome there is also a defect in intracellular copper distribution. A woman taking high doses of the copper-chelating drug, *d*-penicillamine, gave birth to an infant with an acquired Ehlers–Danlos-like syndrome, which subsequently cleared. Side effects of *d*-penicillamine therapy include poor wound healing and hyperextensible skin.

Peltonen, L., Kuivaniemi, H., Palotie, A., et al. Alterations of copper and collagen metabolism in the Menkes syndrome and a new subtype of Ehlers–Danlos syndrome. *Biochemistry* 22:6156, 1983. For a detailed overview of collagen disorders see: Byers, P. H. Disorders of collagen biosynthesis and structure. In: C. R. Scriver, A. L. Beaudet, W. S. Sly, and D. Valle (Eds.) *The Metabolic and Molecular Basis of Inherited Disease*, Vol. III, 7th ed. New York: McGraw-Hill, 1995, pp. 4029–4077.

the absence of iron, a repressor protein binds to the **iron-responsive element** (IRE), a stem-loop structure in the 5' leader sequence of ferritin mRNA. This mRNA is sequestered for future use. δ -Aminolevulinic acid synthase, an enzyme of heme biosynthesis, is also regulated by a 5' -IRE in its mRNA. In contrast, more ferritin receptor mRNA is needed if iron is limited; it has IREs in its 3' -nontranslated region. Binding of the repressor protein stabilizes the mRNA and prolongs its useful lifetime. Many growth-regulated mRNAs, including those for ribosomal proteins, have a polypyrimidine tract in their leader sequence. A polypyrimidine-binding protein helps regulate their translation.

17.8—

Protein Degradation and Turnover

Proteins have finite lifetimes. They are subject to environmental damage such as oxidation, proteolysis, conformational denaturation, or other irreversible modifications. Equally important, cells need to change their protein complements in order to respond to different needs and situations. Specific proteins have very different lifetimes. Cells of the eye lens are not replaced and their proteins are not recycled. Hemoglobin in red blood cells lasts the life of these cells, about 120 days. Other proteins have lifetimes measured in days, hours, or even minutes. Some blood-clotting proteins survive for only a few days, so hemophiliacs are only protected for a short period by transfusions or injections of required factors. Diabetics require insulin injections regularly since the hormone is metabolized. Metabolic enzymes vary quantitatively depending on need; for example, urea cycle enzyme levels change in response to diet. Most amino acids produced by protein degradation are recycled to synthesize new proteins but some degradation products will be excreted. In either case, proteolysis first reduces the proteins in question to peptides and eventually amino acids. Several proteolytic systems accomplish this end.

Intracellular Digestion of Some Proteins Occurs in Lysosomes

Digestive proteases such as pepsin, trypsin, chymotrypsin, and elastase hydrolyze dietary protein and have no part in intracellular protein turnover within an organism (see Chapter 25). Intracellular digestion of proteins from the extracellular environment occurs within **lysosomes**. Material that is impermeable to the plasma membrane is imported by endocytosis. In **pinocytosis** large particles, molecular aggregates, or other molecules present in the extracellular fluid are ingested by engulfment. Macrophages ingest bacteria and dead cells by this mechanism. **Receptor-mediated endocytosis** uses cell surface receptors to bind specific molecules. Endocytosis occurs at pits in the cell surface that are coated internally with the multisubunit protein clathrin. Uptake is by invagination of the plasma membrane and the receptors to form intracellular coated vesicles. One fate of such vesicles is fusion with a lysosome and degradation of the contents. Some intracellular protein turnover may also occur within

lysosomes, and under some conditions significant amounts of cellular material can be mobilized via lysosomes. For example, serum starvation of fibroblasts in culture or starvation of rats leads to the lysosomal degradation of a subpopulation of cellular proteins. Recognition of a specific peptide sequence is involved, indicating that the lifetime of a protein is ultimately encoded in its sequence. This concept will be more apparent in the next section on ubiquitin-dependent proteolysis.

Although lysosomal degradation of cellular proteins occurs, it is not the main route of protein turnover. Calcium-dependent proteases, also called calpains, are present in most cells. Activators and inhibitors of these enzymes are also present, and calpains are logical candidates for enzymes involved in protein turnover. However, their role in these processes is not quantitatively established. Golgi and ER proteases degrade peptide fragments that arise during maturation of proteins in the secretory pathway. They could also be involved in turnover of ER proteins. **Apoptosis**, programmed cell death, requires several proteases. It is likely that other uncharacterized mechanisms exist in both the cytosol and in the mitochondrion.

Ubiquitin Is a Marker in ATP-Dependent Proteolysis

One well-described proteolytic pathway requires ATP hydrolysis and the participation of **ubiquitin**, a highly conserved protein containing 76 amino acids. One function of ubiquitin is to mark proteins for degradation. Ubiquitin has other roles; as an example, linkage of ubiquitin to histones H2A and H2B is unrelated to turnover since the proteins are stable, but modification may affect chromatin structure or transcription.

The ubiquitin-dependent proteolytic cycle is shown in Figure 17.22. Ubiquitin is activated by enzyme E1 to form a thioester; ATP is required and a transient AMP-ubiquitin complex is involved. The ubiquitin is then passed to enzyme E2, and finally via one of a group of E3 enzymes it is coupled to a targeted protein. Linkage of ubiquitin is through isopeptide bonds between ϵ -amino groups of lysine residues of the protein and the carboxyl-terminal glycine residues of ubiquitin. Several ubiquitin molecules may be attached to the protein and to each other. ATP-dependent proteases then degrade the tagged protein and free the ubiquitin for further degradation cycles.

Ubiquitin-dependent proteolysis plays a major role in the regulation of cellular events. **Cyclins** are involved in control of progress through the cell cycle. The ubiquitin-dependent destruction of a cyclin allows cells to pass from the M phase into G1. Other proteins known to be degraded by ubiquitin-dependent proteolysis include transcription factors, the p53 tumor suppressor and other oncoproteins, a protein kinase, and immune system and other cell surface receptors.

Damaged or mutant proteins are rapidly degraded via the ubiquitin pathway. In **cystic fibrosis** a mutation that results in deletion of one amino acid greatly alters the stability of a protein (see Clin. Corr. 17.9), but it is not always clear how native proteins are identified for degradation. Selectivity occurs at the level of the E3 enzyme, but most specific recognition signals are obscure. One determinant is simply the identity of the amino-terminal amino acid. Otherwise identical β -galactosidase proteins with different amino-terminal residues are degraded at widely differing rates. Amino termini may be modified to alter the lifetime of the protein, and some residues serve as aminoacyl acceptors for a destabilizing residue from an aminoacyl-tRNA. Internal sequences and conformation are also likely to be important; destabilizing PEST sequences (rich in Pro, Glu, Ser, and Thr) have been identified in several short-lived proteins.

The ATP-dependent degradation of ubiquitin-marked proteins occurs in a 26S organelle called the **proteasome**. Proteasomes are dumbbell-shaped complexes of about 25 polypeptides; a proteolytically active 20S cylindrical

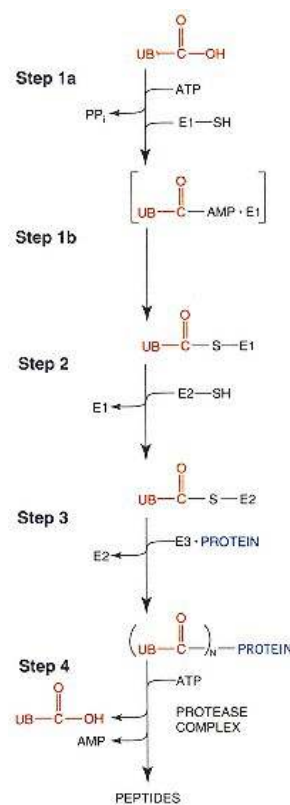

Figure 17.22

ATP and ubiquitin-dependent protein degradation.

Ubiquitin is first activated in a two-step reaction involving formation of a transient mixed anhydride of AMP and the carboxy terminus of ubiquitin (step 1a), followed by generation of a thioester with enzyme E1 (step 1b). Enzyme E2 can now form a thioester with ubiquitin (step 2) and serve as a donor in E3-catalyzed transfer of ubiquitin to a targeted protein (step 3). Several ubiquitin molecules are usually attached to different lysine residues of a targeted protein at this stage. Ubiquitylated protein is now degraded by ATP-dependent proteolysis (step 4); ubiquitin is not degraded and can reenter the process at step 1.



Figure 17.23
Model of proteasome.

A 20S central segment is made up of four stacked heptameric rings of two types. The core is hollow and includes 12–15 different polypeptides; several proteases with different specificities are localized within the rings. V-shaped segments at each end cap the cylinder and are responsible for ATP-dependent substrate recognition, unfolding, and translocation into the proteolytic core. Upper cap structure is also in contact with the central segment but it is shown displaced from it in order to illustrate the hollow core of the cylinder.

Adapted from D. Rubin and D. Finley, *Curr. Biol.* 5:854, 1995; and J.-M. Peters, *Trends Biochem. Sci.* 19:377, 1994.

core is capped at each end by V-shaped complexes that bestow ATP dependence (Figure 17.23). It is speculated that the cap structure is involved in recognizing and unfolding polypeptides and transporting them to the proteolytic core. The complex *E. coli* proteases Lon and Clp and similar enzymes in other microorganisms (and in mitochondria) also require ATP hydrolysis for their action, but ubiquitin is absent in prokaryotes and the means of identification of proteins for degradation is still obscure. It is likely that protein degradation will turn out to be as complex and important a problem as protein biosynthesis.

CLINICAL CORRELATION 17.9

Deletion of a Codon, Incorrect Posttranslational Modification, and Premature Protein Degradation: Cystic Fibrosis

Cystic fibrosis (CF) is the most common autosomal recessive disease in Caucasians, with a frequency of almost 1 per 2000. The CF gene is 230 kb in length and includes 27 exons encoding a protein of 1480 amino acids. The protein known as the cystic fibrosis transmembrane conductance regulator or CFTR is a member of a family of ATP-dependent transport proteins and it includes two membrane-spanning domains, two nucleotide-binding domains that interact with ATP, and one regulatory domain that includes several phosphorylation sites. CFTR functions as a cyclic AMP-regulated chloride channel. CF epithelia are characterized by defective electrolyte transport. The organs most strongly affected include the lungs, pancreas, and liver, and the most life-threatening effects involve thick mucous secretions that lead to chronic obstructive lung disease and persistent infections of lungs.

In about 70% of affected individuals the problem is traced to a three-nucleotide deletion that results in deletion of a single amino acid, phenylalanine 508, normally located in ATP-binding domain 1 on the cytoplasmic side of the plasma membrane. As with several other CF mutations, the Phe 508 deletion protein is not properly glycosylated or transported to the cell surface. Instead, it is only partially glycosylated, and it is degraded within the endoplasmic reticulum. It is postulated that the mutant protein does not fold properly and is marked for degradation rather than movement to the plasma membrane.

Ward, C., Omura, S., and Kopito, R. Degradation of CFTR by the ubiquitin–proteasome pathway. *Cell* 83:121, 1995.

Bibliography

Ribosomes and Transfer RNA

- Filonenko, V. V., and Deutscher, M. P. Evidence for similar structural organization of the multienzyme aminoacyl-tRNA complex *in vivo* and *in vitro*. *J. Biol. Chem.* 269:17375, 1994.
- Frank, J., Zhu, J., Penczek, P., et al. A model of protein synthesis based on a new cryo-electron microscopy reconstruction of the *E. coli* ribosome. *Nature* 376:441, 1995.
- Freist, W. Mechanisms of aminoacyl-tRNA synthetases: a critical consideration of recent results. *Biochemistry* 28:6787, 1989.
- Gesteland, R. F., and Atkins, J. F. (Eds.). *The RNA World*. Cold Spring Harbor, NY: Cold Spring Harbor Press, 1993.
- Herold, M., and Nierhaus, K. H. Incorporation of six additional proteins to complete the assembly map of the 50S subunit from *Escherichia coli* ribosomes. *J. Biol. Chem.* 262:8826, 1987.
- Hou, Y.-M., Francklyn, C., and Schimmel, P. Molecular dissection of a transfer RNA and the basis for its identity. *Trends Biochem. Sci.* 14:233, 1989.
- Jakubowski, H., and Goldman, E. Editing errors in selection of amino acids for protein synthesis. *Microbiol. Rev.* 56:412, 1992.
- Nierhaus, K. H., Franceschi, F., Subramanian, A. R., Erdmann, V. A., and Wittmann-Liebold, B. (Eds.). *The Translational Apparatus: Structure, Function, Regulation, Evolution*. New York: Plenum Press, 1993.
- Nomura, M. The role of RNA and protein in ribosome function: a review of early reconstitution studies and prospects for future studies. *Cold Spring Harbor Symp. Quant. Biol.* 52:653, 1987.
- Perona, J., Rould, M., and Steitz, T. Structural basis for transfer RNA aminoacylation by *Escherichia coli* glutamyl-tRNA synthetase. *Biochemistry* 32:8758, 1993.
- Stark, H., Mueller, F., Orleva, E. V., et al. The 70S *Escherichia coli* ribosome at 23Å resolution: fitting the ribosomal RNA. *Structure* 3:815, 1995.
- Verschoor, A., and Frank, J. Three-dimensional structure of the mammalian cytoplasmic ribosome. *J. Mol. Biol.* 214:737, 1990.

Protein Biosynthesis and its Regulation

- Barrell, B., Anderson, S., Bankier, A. T., et al. Different pattern of codon recognition by mammalian mitochondrial tRNAs. *Proc. Natl. Acad. Sci. USA* 77:3164, 1980.
- Berchtold, H., Reshetnikova, L., Reiser, C. O., et al. Crystal structure of active elongation factor T_u reveals major domain rearrangements. *Nature* 365:126, 1993.
- Gnrke, A., Geigenmuller, U., Rheinberger, H., and Nierhaus, K. The allosteric three-site model for the ribosomal elongation cycle. *J. Biol. Chem.* 264:7291, 1989.
- Merrick, W. C. Mechanism and regulation of eukaryotic protein synthesis. *Microbiol. Rev.* 56:291, 1992.
- Merrick, W. C. Eukaryotic protein synthesis: an *in vitro* analysis. *Biochimie* 76:822, 1994.
- Rhoads, R. E. Regulation of eukaryotic protein biosynthesis by initiation factors. *J. Biol. Chem.* 268:3017, 1993.
- Samuel, C. E. The eIF2a protein kinases as regulators of protein synthesis in eukaryotes from yeasts to humans. *J. Biol. Chem.* 268:7603, 1993.
- Zhouravleva, G., Frolova, L., LeGoff, X., et al. Termination of translation in eukaryotes is governed by two interacting polypeptide chain release factors, eRF1 and eRF3. *EMBO J* 14:4065, 1995.
- Ziff, E. B. Transcription and RNA processing by the DNA tumour viruses. *Nature* 287:491, 1980.

Protein Targeting and Posttranslational Modification

- Dahms, N. M., Lobel, P., and Kornfeld, S. Mannose 6-phosphate receptors and lysosomal enzyme targeting. *J. Biol. Chem.* 264:12115, 1989.
- Danpure, C. J. How can products of a single gene be localized to more than one subcellular compartment? *Trends Cell Biol.* 5:230, 1995.
- Kornfeld, R., and Kornfeld, S. Assembly of asparagine-linked oligosaccharides. *Annu. Rev. Biochem.* 54:631, 1985.
- Krishna, R. G., and Wold, F. Post-translational modification of proteins. *Adv. Enzymol.* 67:265, 1993.
- Kuhn, K. The classical collagens. In: R. Mayne and R. E. Burgeson (Eds.), *Structure and Function of Collagen Types*. Orlando, FL: Academic Press, 1987, pp. 1–42.
- Nothwehr, S. F., and Stevens, T. H. Sorting of membrane proteins in the yeast secretory pathway. *J. Biol. Chem.* 269:10185, 1994.
- Paulson, J. C. Glycoproteins: what are the sugar chains for? *Trends Biochem. Sci.* 14:272, 1989.
- Paulson, J. C., and Colley, K. J. Glycosyltransferases: structure, localization, and control of cell type-specific glycosylation. *J. Biol. Chem.* 264:17615, 1989.
- Pfanner, N., Craig, E., and Meijer, M. The protein import machinery of the mitochondrial inner membrane. *Trends Biochem. Sci.* 19:368, 1994.
- Pfeffer, S. R., and Rothman, J. E. Biosynthetic protein transport and sorting by the endoplasmic reticulum and Golgi. *Annu. Rev. Biochem.* 56:829, 1987.
- Rachubinski, R. A., and Subramani, S. How proteins penetrate peroxisomes. *Cell* 83:525, 1995.
- Rogenkamp, R. Targeting signals for protein import into peroxisomes. *Cell Biochem. Function* 10:193, 1992.
- Rudd, P. M., et al. The effects of variable glycosylation on the functional activities of ribonuclease, plasminogen and tissue plasminogen activator. *Biochim. Biophys. Acta* 1248:1, 1995.
- von Heijne, G. Signals for protein targeting into and across membranes. In: A. H. Maddy and J. R. Harris (Eds.), *Subcellular Biochemistry, Vol. 22: Membrane Biochemistry*. New York: Plenum Press, 1994, pp. 1–19.
- Walter, P., and Johnson, A. E. Signal sequence recognition and protein targeting to the endoplasmic reticulum membrane. *Annu. Rev. Cell Biol.* 10:87, 1994.
- Wolin, S. From the elephant to *E. coli*: SRP-dependent protein targeting. *Cell* 77:787, 1994.

Protein Turnover and Proteasomes

- Ciechanover, A. The ubiquitin–proteasome proteolytic pathway. *Cell* 79:13, 1994.
- Dice, J. F. Molecular determinants of protein half-lives in eukaryotic cells. *FASEB J.* 1:349, 1987.
- Gonda, D. K., Bachmair, A., Wüning, I., et al. Universality and structure of the N-end rule. *J. Biol. Chem.* 264:16700, 1989.
- Jentsch, S. The ubiquitin-conjugation system. *Annu. Rev. Genet.* 26:179, 1992.
- Kessel, M., Maurizi, M. R., Kim, B., et al. Homology in structural organization between *E. coli* ClpAP protease and the eukaryotic 26S proteasome. *J. Mol. Biol.* 250:587, 1995.
- Löwe, J., Stock, D., Jap, B., et al. Crystal structure of the 20S proteasome from the archaeon *T. acidophilum* at 3.4Å resolution. *Science* 268:533, 1995.
- Rechsteiner, M. Natural substrates of the ubiquitin proteolytic pathway. *Trends Biochem. Sci.* 66:615, 1991.
- Rock, K., Gramm, C., Rothstein, L., et al. Inhibitors of the proteasome block the degradation of most cell proteins and the generation of peptides presented on MHC class II molecules. *Cell* 78:761, 1994.
- Rogers, S., Wells, R., and Rechsteiner, M. Amino acid sequences common to rapidly degraded proteins: the PEST hypothesis. *Science* 234:364, 1986.
- Wlodawer, A. Proteasome: a complex protease with a new fold and a distinct mechanism. *Structure* 3:417, 1995.

Questions

J. Baggott and C. N. Angstadt

- Degeneracy of the genetic code denotes the existence of:
 - multiple codons for a single amino acid.
 - codons consisting of only two bases.
 - base triplets that do not code for any amino acid.
 - different protein synthesis systems in which a given triplet codes for different amino acids.
 - codons that include one or more of the "unusual" bases.
- Deletion of a single base from a coding sequence of mRNA may result in a polypeptide product with any of the following EXCEPT:
 - a sequence of amino acids that differs from the sequence found in the normal polypeptide.
 - more amino acids.
 - fewer amino acids.
 - a single amino acid replaced by another amino acid.
- During initiation of protein synthesis.
 - methionyl-tRNA appears at the A site of the 80S initiation complex.
 - eIF-3 and the 40S ribosomal subunit participate in forming a preinitiation complex.
 - eIF-2 is phosphorylated by GTP.
 - the same methionyl-tRNA is used as is used during elongation.
 - a complex consisting of mRNA, the 60S ribosomal subunit, and certain initiation factors is formed.
- Requirements for eukaryotic protein synthesis include all of the following EXCEPT:
 - mRNA.
 - ribosomes.
 - GTP.
 - 20 different amino acids in the form of aminoacyl-tRNAs.
 - E. $fMet-tRNA_i^{Met}$.
- During the elongation stage of eukaryotic protein synthesis:
 - the incoming aminoacyl-tRNA binds to the P site.
 - a new peptide bond is synthesized by peptidyl transferase site of the large ribosomal subunit in a GTP-requiring reaction.
 - the peptide, still bound to a tRNA molecule, is translocated to a different site on the ribosome.
 - streptomycin can cause premature release of the incomplete peptide.
 - peptide bond formation occurs by the attack of the carboxyl group of the incoming aminoacyl-tRNA on the amino group of the growing peptide chain.
- Diphtheria toxin:
 - acts catalytically.
 - releases incomplete polypeptide chains from the ribosome.
 - inhibits translocase.
 - prevents release factor from recognizing termination signals.
 - attacks the RNA of the large subunit.
- How many high-energy bonds are expended in the formation of one peptide bond?
 - 1
 - 2
 - 3
 - 4
 - 5
- Formation of mature insulin includes all of the following EXCEPT:
 - removal of a signal peptide.
 - folding into a three-dimensional structure.
 - disulfide bond formation.
 - removal of a peptide from an internal region.
 - γ -carboxylation of glutamate residues.
- 4-Hydroxylation of specific prolyl residues during collagen synthesis requires all of the following EXCEPT:
 - Fe^{2+} .
 - a specific amino acid sequence.
 - ascorbic acid.
 - succinate.
 - individual α -chains, not yet assembled into a triple helix.
- In the formation of an aminoacyl-tRNA:
 - ADP and P_i are products of the reaction.
 - aminoacyl adenylate appears in solution as a free intermediate.
 - the aminoacyl-tRNA synthetase is believed to recognize and hydrolyze incorrect aminoacyl-tRNAs it may have produced.
 - there is a separate aminoacyl-tRNA synthetase for every amino acid appearing in the final, functional protein.
 - there is a separate aminoacyl-tRNA synthetase for every tRNA species.
- During collagen synthesis, events that occur extracellularly include all of the following EXCEPT:
 - modification of prolyl residues.
 - amino-terminal peptide cleavage.
 - carboxyl-terminal peptide cleavage.
 - modification of lysyl residues.
 - covalent cross-linking.
- In the functions of ubiquitin all of the following are true EXCEPT:
 - ATP is required for activation of ubiquitin.
 - ubiquitin-dependent degradation of proteins occurs in the lysosomes.
 - linkage of a protein to ubiquitin does not always mark it for degradation.
 - the identity of the N-terminal amino acid is one determinant of selection for degradation.
 - ATP is required by the protease that degrades the tagged protein.

Match each of the following numbered markers with the appropriate lettered target site.

- A. export from the cell
- B. lysosomes
- C. mitochondria
- D. nucleus
- E. peroxisomes

- 13. Clusters of lysine and arginine amino acid residues.
- 14. Mannose 6-phosphate.
- 15. Positively charged amphiphilic α -helix.
- 16. Ser-Lys-Leu (SKL).

Answers

1. A This is the definition of degeneracy (p. 719). B and E are not known to occur, although sometimes tRNA reads only the first two bases of a triplet (wobble), and sometimes unusual bases occur in anticodons (p. 719). C denotes the stop (nonsense) codons (p. 719). D is a deviation from universality of the code, as found in mitochondria (p. 719).
2. D Deletion of a single base causes a frameshift mutation (p. 721). The frameshift would destroy the original stop codon; another one would be generated before or after the original location. In contrast, replacement of one base by another would cause replacement of one amino acid (missense mutation), unless a stop codon is thereby generated (p. 721).
3. B A: $\text{Methionyl-tRNA}_c^{\text{Met}}$ is used internally. E: mRNA associates first with the 40S subunit (p. 725).
4. E $\text{fMet-tRNA}_i^{\text{Met}}$ is involved in initiation of protein synthesis in prokaryote (p. 725).
5. C A: The incoming aminoacyl-tRNA binds to the A site. B: Peptide bond formation requires no energy source other than the aminoacyl-tRNA (pp. 727 and 730). D: Streptomycin inhibits formation of the prokaryotic 70S initiation complex (analogous to the eukaryotic 80S complex) and causes misreading of the genetic code when the initiation complex is already formed (p. 734). E: The electron pair of the amino group carries out a nucleophilic attack on the carbonyl carbon.
6. A This toxin catalyzes the formation of an ADP ribosyl derivative of translocase, which irreversibly inactivates the translocase (p. 735).
7. D One ATP is converted to AMP during activation of an amino acid (p. 721), and two GTP are converted to GDP during elongation (pp. 727 and 730). The ATP AMP counts as two high-energy bonds expended.
8. E See p. 743. γ -Carboxylation is of special importance in several blood clotting proteins (p. 746).
9. D See pp. 746–747.
10. C C. Bonds between a tRNA and an incorrect smaller amino acid may form but are rapidly hydrolyzed (p. 723). A and B: ATP and the amino acid react to form an enzyme-bound aminoacyl adenylate; PP_i is released into the medium (p. 721). D: Some amino acids, such as hydroxyproline and hydroxylysine, arise by co- or posttranslational modification (p. 747). E: An aminoacyl-tRNA synthetase may recognize any of several tRNAs specific for a given amino acid (p. 722).
11. A See p. 747. Some modification of lysyl residues also occurs intracellularly (p. 747).
12. E A–D: True (see p. 751). C: Linkage to histones does not result in their degradation.
13. D (see p. 743).
14. B (see p. 740).
15. C (see p. 742).
16. E (see p. 743). This tripeptide must occur at the carboxyl terminal.

Chapter 18— Recombinant DNA and Biotechnology

Gerald Soslau

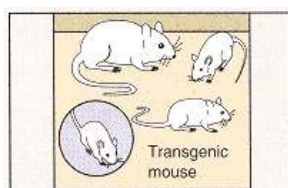

18.1 Overview	758
18.2 Polymerase Chain Reaction	759
18.3 Restriction Endonuclease and Restriction Maps	760
Restriction Endonucleases Permit Selective Hydrolysis of DNA to generate Restriction Maps	760
Restriction Maps Permit the Routine Preparation of Defined Segments of DNA	761
18.4 DNA Sequencing	762
Chemical Cleavage Method: Maxam–Gilbert Procedure	762
Interrupted Enzymatic Cleavage Method: Sanger Procedure	763
18.5 Recombinant DNA and Cloning	765
DNA from Different Sources Can Be Ligated to Form a New DNA Species: Recombinant DNA	765
Recombinant DNA Vectors Can Be Produced in Significant Quantities by Cloning	766
DNA Can Be Inserted into Vector DNA in a Specific Direction: Directional Cloning	766
Bacteria Can Be Transformed with Recombinant DNA	767
It Is Necessary to Be Able to Select Transformed Bacteria	768
Recombinant DNA Molecules in a Gene Library	768
PCR May Circumvent the Need to Clone DNA	768
18.6 Selection of Specific Cloned DNA in Libraries	770
Loss of Antibiotic Resistance Is Used to Select Transformed Bacteria	770
α -Complementation for Selecting Bacteria Carrying Recombinant Plasmids	772
18.7 Techniques for Detection and Identification of Nucleic Acids	773
Nucleic Acids Can Serve As Probes for Specific DNA or RNA Sequences	773
Southern Blot Technique Is Useful for Identifying DNA Fragments	774
Single-Strand Conformation Polymorphism	775
18.8 Complementary DNA and Complementary DNA Libraries	777
mRNA Is Used As a Template for DNA Synthesis Using Reverse Transcriptase	777
Desired mRNA in a Sample Can Be Enriched by Separation Techniques	777
Complementary DNA Synthesis	777
Total Cellular RNA May Be Used As a Template for DNA Synthesis Using RT-PCR	778
18.9 Bacteriophage, Cosmid, and Yeast Cloning Vectors	778
Bacteriophage As Cloning Vectors	778
Screening Bacteriophage Libraries	779
Cloning DNA Fragments into Cosmid and Yeast Artificial Chromosome Vectors	780
18.10 Techniques to Further Analyze Long Stretches of DNA	781
Subcloning Permits Definition of Large Segments of DNA	781
Chromosome Walking Is a Technique to Define Gene Arrangement in Long Stretches of DNA	781
18.11 Expression Vectors and Fusion Proteins	783
Foreign Genes Can Be Expressed in Bacteria Allowing Synthesis of Their Encoded Proteins	783
18.12 Expression Vectors in Eukaryotic Cells	784
DNA Elements Required for Expression of Vectors in Mammalian Cells	785
Transfected Eukaryotic Cells Can Be Selected by Utilizing Mutant Cells That Require Specific Nutrients	785
Foreign Genes Can Be Expressed in Eukaryotic Cells by Utilizing Virus Transformed Cells	786

18.13 Site-Directed Mutagenesis	786
Role of Flanking Regions in DNA Can Be Evaluated by Deletion and Insertion Mutations	786
Site-Directed Mutagenesis of a Single Nucleotide	787
18.14 Applications of Recombinant DNA Technologies	790
Antisense Nucleic Acids Hold Promise As Research Tools and in Therapy	790
Normal Genes Can Be Introduced into Cells with a Defective Gene in Gene Therapy	793
Transgenic Animals	794
Recombinant DNA in Agriculture Will Have Significant Commercial Impact	794
18.15 Concluding Remarks	795
Bibliography	795
Questions and Answers	796
Clinical Correlations	
18.1 Polymerase Chain Reaction and Screening for Human Immunodeficiency Virus	760
18.2 Restriction Mapping and Evolution	762
18.3 Direct Sequencing of DNA for Diagnosis of Genetic Disorders	766
18.4 Multiplex PCR Analysis of HGPRTase Gene Defects in Lesch–Nyhan Syndrome	770
18.5 Restriction Fragment Length Polymorphisms Determine the Clonal Origin of Tumors	776
18.6 Site-Directed Mutagenesis of HSV I gD	789
18.7 Normal Genes Can Be Introduced into Cells with Defective Genes in Gene Therapy	793
18.8 Transgenic Animal Models	795

18.1— Overview

By 1970, the stage was set for modern molecular biology based on studies of numerous scientists in the previous 30 years, during which ignorance of what biochemical entity orchestrated the replication of life forms with such fidelity gave way to a state where sequencing and manipulating the expression of genes would be feasible. The relentless march toward a full understanding of gene regulation under normal and pathological conditions has moved with increasing rapidity since the 1970s. Deoxyribonucleic acid, composed of only four different nucleotides covalently linked by a sugar–phosphate backbone, is deceptively complex. Complexity is conferred on the DNA molecule by the nonrandom sequence of its bases, multiple conformations that exist in equilibrium in the biological environment, and specific proteins that recognize and associate with selected regions. By the 1970s biochemical knowledge of the cellular processes and their macromolecular components had established several facts required for the surge forward. It was clear that gene expression was highly regulated. Enzymes involved in DNA replication and RNA transcription had been purified and their function in the synthetic process defined. The genetic code had been broken. Genetic maps of prokaryotic chromosomes had been established based on gene linkage studies with thousands of different mutants. Finally, RNA species could be purified, enzymatically hydrolyzed into discrete pieces, and laboriously sequenced. It was evident that further progress in the understanding of gene regulation would require techniques to selectively cut DNA into homogeneous pieces. Even small, highly purified viral DNA genomes were too complex to decipher. The thought of tackling the human genome with more than 3×10^9 base pairs was all the more onerous.

Identification, purification, and characterization of restriction endonucleases that faithfully hydrolyze DNA molecules at specific sequences permitted the development of recombinant DNA methodologies. Development of DNA sequencing opened the previously tightly locked molecular biology gates to the secrets held within the organization of diverse biological genomes. Genes could finally be sequenced, but perhaps more importantly so could the flanking regions that regulate their expression. Sequencing regulatory regions of numerous genes defined consensus sequences such as those found in promoters, enhancers, and many binding sites for regulatory proteins (see Chapter 19). Each gene contains an upstream promoter where a DNA-dependent RNA polymerase binds prior to initiation of transcription. While some DNA regulatory sites lie just upstream of the transcription initiation site, other regulatory regions are hundreds to thousands of bases removed and still others are downstream.

This chapter presents many of the sophisticated techniques, developed in the past 25 years, that allow for the dissection of complex genomes into defined fragments with the complete analysis of the nucleotide sequence and function of these DNA regions. The modification and manipulation of genes, that is, genetic engineering, facilitates the introduction and expression of genes in both prokaryotic and eukaryotic cells. Many methodological approaches in genetic engineering have been greatly simplified by employment of a method that rapidly amplifies selected regions of DNA—the polymerase chain reaction (PCR). Proteins for experimental and clinical uses are readily produced by these procedures and it is anticipated that in the not too distant future these methods will allow for the rapid increase of treatment modalities of genetic diseases with gene replacement therapy. Current and potential uses of recombinant DNA technologies are also described. The significance to our society of advancements in the understanding of genetic macromolecules and their manipulation cannot be overstated.

18.2— Polymerase Chain Reaction

The rapid production of large quantities of a specific DNA sequence took a leap forward with the development of the **polymerase chain reaction (PCR)**. The PCR requires two nucleotide oligomers that hybridize to the complementary DNA strands in a region of interest. The oligomers serve as primers for a DNA polymerase that extends each strand. Repeated cycling of the PCR yields large amounts of each DNA molecule of interest in a matter of hours as opposed to days and weeks associated with cloning techniques.

The PCR *amplification of a specific DNA sequence* can be accomplished with a purified DNA sample or a small region within a complex mixture of DNA. The principles of the reaction are shown in Figure 18.1. The nucleotide sequence of the DNA to be amplified must be known or it must be cloned in a vector (see p. 778) where the sequence of the flanking DNA has been established. The product of PCR is a double-stranded DNA molecule and the reaction is completed in each cycle when all of the template molecules have been copied. In order to initiate a new round of replication the sample is heated to melt the double-stranded DNA and, in the presence of excess oligonucleotide primers, cooled to permit hybridization of the single-stranded template with free oligomers. A new cycle of DNA replication will initiate in the presence of DNA polymerase and all four dNTPs. Heating to about 95°C as required for melting DNA inactivates most DNA polymerases, but a heat stable polymerase,

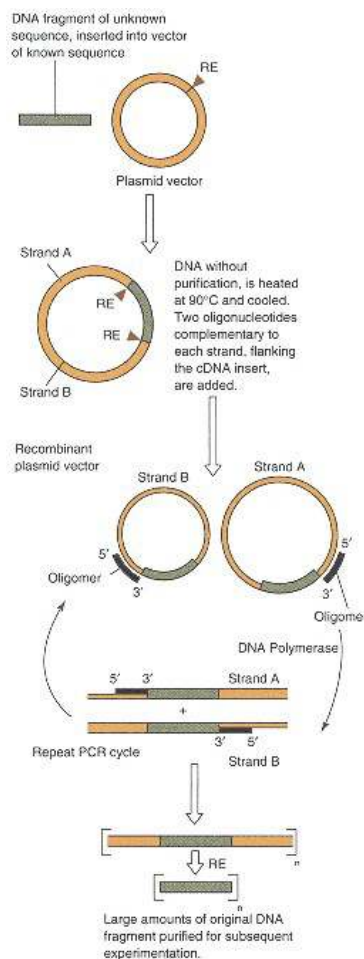

Figure 18.1

Polymerase chain reaction (PCR).

A DNA fragment of unknown sequence is inserted into a vector of known sequence by normal recombinant methodologies. The recombinant DNA of interest does not need to be purified from contaminating DNA species. The DNA is heated to 90°C to dissociate the double strands and cooled in the presence of excess amounts of two different complementary oligomers that hybridize to the known vector DNA sequences flanking the foreign DNA insert. Only recombinant single-stranded DNA species can serve as templates for DNA replication, yielding double-stranded DNA fragments of foreign DNA bounded by the oligomer DNA sequences. The heating–replication cycle is repeated many times to rapidly produce greatly amplified amounts of the original foreign DNA. The DNA fragment of interest can be purified from the polymerase chain reaction mixture by cleaving it with the original restriction endonuclease (RE), electrophoresing the DNA mixture through an agarose gel, and eluting the band of interest from the gel.

CLINICAL CORRELATION 18.1**Polymerase Chain Reaction and Screening for Human Immunodeficiency Virus**

Use of the polymerase chain reaction (PCR) to amplify minute quantities of DNA has revolutionized the ability to detect and analyze DNA species. With PCR it is possible to synthesize sufficient DNA for analysis. Conventional methods for detection and identification of the human immunodeficiency virus (HIV), such as Southern blot–DNA hybridization and antigen analysis, are labor intensive, expensive, and have low sensitivity. An infected individual, with no sign of AIDS (acquired immunodeficiency syndrome), may test false negative for HIV by these procedures. Early detection of HIV infections in these individuals is crucial to initiate treatment and/or monitor the progression of their disease. In addition, a sensitive method is required to be certain that contributed blood from donors does not contain HIV. PCR amplification of potential HIV DNA sequences within DNA isolated from an individual's white blood cells permits the identification of viral infections prior to the presence of antibodies, the so-called seronegative state. Current methodologies are too costly to apply this testing to large-scale screening of donor blood samples. PCR can also be used to increase the sensitivity to detect and characterize DNA sequences of any other human infectious pathogen.

Kwok, S., and Sninsky, J. J. Application of PCR to the detection of human infectious diseases. In: H. A. Erlich (Ed.), *PCR Technology*. New York: Stockton Press, 1989, p. 235.

termed Taq DNA polymerase isolated from *Thermus aquaticus*, is now employed, obviating the need for fresh polymerase after each cycle. This has permitted the automation of PCR with each DNA molecule capable of being amplified one million-fold.

When the DNA to be amplified is present in very low concentrations relative to the total DNA in the sample, it is possible to amplify the DNA region of interest along with other spurious sequences. In this situation the specificity of the amplification reaction can be enhanced by **nested PCR**. After conducting the first PCR with one set of primers for 10–20 cycles, a small aliquot is removed for a second PCR. However, the second PCR is conducted with a new set of primers that are complementary to the template DNA just downstream of the first set of primers, or "nested" between the original set of primers. This process amplifies the DNA region of interest twice with a greatly enhanced specificity.

PCR has many applications including gene diagnosis, forensic investigations where only a drop of dried blood or a single hair is available, and evolutionary studies with preserved biological material. Use of PCR for screening for human immunodeficiency virus is presented in Clin. Corr. 18.1.

18.3—**Restriction Endonuclease and Restriction Maps*****Restriction Endonucleases Permit Selective Hydrolysis of DNA to Generate Restriction Maps***

Nature possesses a diverse set of tools, the **restriction endonucleases**, capable of selectively dissecting DNA molecules of all sizes and origin into smaller fragments. These enzymes confer some protection on bacteria against invading viruses, that is, bacteriophage. The bacterial DNA sequences normally recognized by the restriction endonuclease may be protected from cleavage in the host cell by methylation of bases within the enzyme recognized palindrome while the unmethylated viral DNA is recognized as foreign and is hydrolyzed. Numerous Type II restriction endonucleases, with differing sequence specificities, have been identified and purified; many are now commercially available (see p. 609 for discussion of restriction endonuclease activities).

Restriction endonuclease permits construction of a new type of genetic map, the **restriction map**, in which the site of enzyme cleavage within the DNA is identified. Purified DNA species that contain restriction endonuclease sequences are subjected to restriction endonuclease cleavage. By regulating the time of exposure of the purified DNA molecules to restriction endonuclease cleavage, a population of DNA fragments that are partially to fully hydrolyzed can be generated. Separation of these enzyme-generated fragments by agarose gel electrophoresis allows for the construction of restriction maps; an example of this procedure with circular DNA is presented in Figure 18.2. Analysis of a DNA completely hydrolyzed by a restriction endonuclease establishes how many sites the restriction endonuclease recognizes within the molecule and what size fragments are generated. The size distribution of composite fragments generated by the partial enzymatic cleavage of the DNA molecules demonstrates linkage of all potential fragments. The sequential use of different restriction endonucleases has permitted a detailed restriction map of numerous circular DNA species including bacterial plasmids, viruses, and mitochondrial DNA. The method is also equally amenable to linear DNA fragments that have been purified to homogeneity.

Restriction Maps Permit the Routine Preparation of Defined Segments of DNA

Restriction maps may yield little information as to the genes or regulatory elements within the various DNA fragments. They have been used to demonstrate sequence diversity of organelle DNA, such as mitochondrial DNA, within species (see Clin. Corr. 18.2). Restriction maps can also be used to detect deletion mutations where a defined DNA fragment from the parental strain

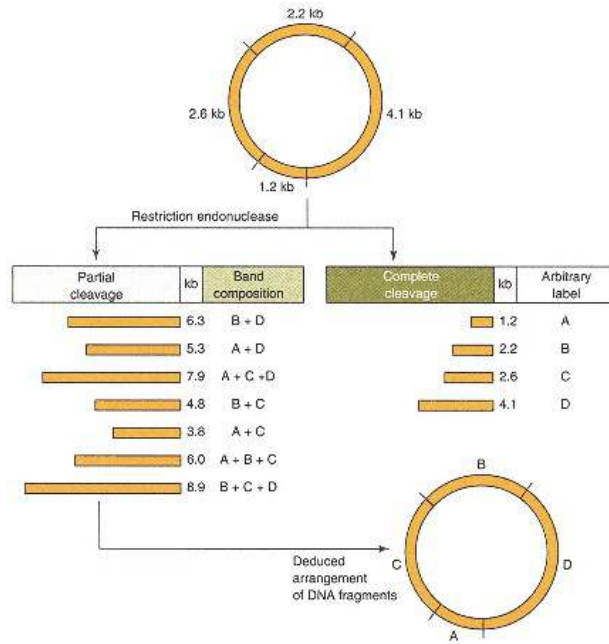

Figure 18.2
Restriction endonuclease mapping of DNA.

Purified DNA is subjected to restriction endonuclease digestion for varying times, which generates partially to fully cleaved DNA fragments. The DNA fragments are separated by agarose gel electrophoresis and stained with ethidium bromide. The DNA bands are visualized with a UV light source and photographed. The size of the DNA fragments is determined by the relative migration through the gel as compared to co-electrophoresed DNA standards. The relative arrangement of each fragment within the DNA molecule can be deduced from the size of the incompletely hydrolyzed fragments.

CLINICAL CORRELATION 18.2

Restriction Mapping and Evolution

In the past, evolutionary studies of species have depended solely on anatomical changes observed in fossil records and on carbon dating. More recently, these studies are being supported by molecular analysis of the sequence and size of selected genes or whole DNA molecules. Evolutionary alterations of a selected DNA molecule from different species can be rapidly assessed by restriction endonuclease mapping. Generation of restriction endonuclease maps requires a pure preparation of DNA. Mammalian mitochondria contain a covalently closed circular DNA molecule of approximately 16,000 base pairs that can rapidly be purified from cells. The mitochondrial DNA (mtDNA) can be employed directly for the study of evolutionary changes in DNA without the need of cloning a specific gene.

Mitochondrial DNA has been purified from the Guinea baboon, rhesus macaque, guenon, and human and cleaved with 11 different restriction endonucleases. Restriction maps were constructed for each species. The maps were all aligned relative to the direction and nucleotide site where DNA replication is initiated. A comparison of shared and altered restriction endonuclease sites allowed for calculation of the degree of divergence in nucleotide sequence between species. It was found that the rate of base substitution (calculated from the degree of divergence versus the time of divergence) has been about tenfold greater than changes in the nuclear genome. This high rate of mutation of the readily purified mtDNA molecule makes it an excellent model to study evolutionary relationships between species.

Brown, W. M., George, M. Jr., and Wilson, A. C. Rapid evolution of animal mitochondrial DNA. *Proc. Natl. Acad. Sci. USA* 76:1967, 1979.

migrates as a smaller fragment in the mutated strain. Most importantly, the enzymatic microscissors used to generate restriction maps cut DNA into defined homogeneous fragments that can be readily purified. These maps are crucial for cloning and for sequencing genes and their flanking DNA regions.

18.4—

DNA Sequencing

To determine the complexities of regulation of gene expression and to seek the basis for genetic diseases, techniques were necessary to determine the exact sequence of bases in DNA. In the late 1970s two different sequencing techniques were developed, one by A. Maxam and W. Gilbert, the chemical cleavage approach, and the other by F. Sanger, the enzymatic approach. Both procedures may employ the labeling of a terminal nucleotide, followed by the separation and detection of generated oligonucleotides.

Chemical Cleavage Method:

Maxam–Gilbert Procedure

Requirements for this procedure include (1) labeling of the terminal nucleotide, (2) selective hydrolysis of the phosphodiester bond for each nucleotide separately to produce fragments with 1, 2, 3, or more bases, (3) quantitative separation of the hydrolyzed fragments, and (4) a qualitative determination of the label added in Step 1. The following describes one approach of the **Maxam–Gilbert procedure**. The overall approach is presented in Figure 18.3.

One end of each strand of DNA can be selectively radiolabeled with ^{32}P . This is accomplished when a purified double helix DNA fragment contains restriction endonuclease sites on either side of the region to be sequenced. Hydrolysis of the DNA with two different restriction endonucleases then results in different staggered ends, each with a different base in the first position of the single-stranded region. Labeling of the 3' end of each strand is accomplished with addition of the next nucleotide as directed by the corresponding base sequence on the complementary DNA strand. A fragment of *E. coli* DNA polymerase I, termed the **Klenow fragment**, will catalyze this reaction. The Klenow fragment, produced by partial proteolysis of the polymerase holoenzyme, lacks 5' → 3' exonuclease activity but retains the 3' → 5' exonuclease and polymerase activity. Each strand can therefore be selectively labeled in separate experiments. The complementary unlabeled strand will not be detectable when analyzing the sequence of the labeled strand.

The hydrolysis of the labeled DNA into different lengths is accomplished by first selectively destroying one or two bases of the four nucleotides. The procedure used exposes the phosphodiester bond connecting adjoining bases and permits selective cleavage of the DNA at the altered base. In separate chemical treatments, samples of labeled DNA are treated to alter purines and pyrimidines without disrupting the sugar–phosphate backbone; a method is not currently available to specifically alter adenine or thymine. Conditions for base modification are selected such that only one or a few bases are destroyed randomly within any one molecule. The four separate DNA samples are then reacted with piperidine, which chemically breaks the sugar–phosphate back-bone at sites where a base has been destroyed, generating fragments of different sizes. Since labeling is specific at the end while the chemical alteration of the base is random and not total, some of the fragments will be end labeled. For example, wherever a cytosine residue had been randomly destroyed in the appropriate reaction tube a break will be introduced into the DNA fragment. The series of chemically generated, end-labeled DNA fragments from each of the four tubes are electrophoresed through a polyacrylamide gel. Bases destroyed near the end-labeled nucleotide will generate fragments that migrate faster through the gel, as low molecular weight species, while fragments derived

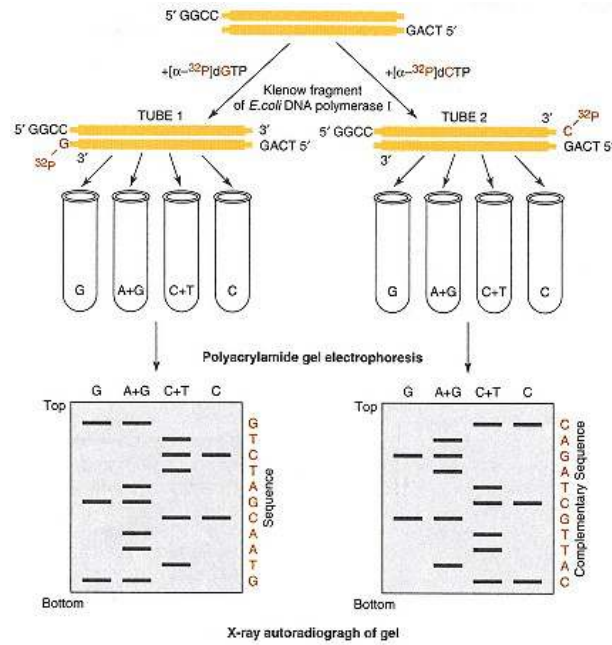

Figure 18.3
Maxam–Gilbert chemical method to sequence DNA.
 A double-stranded DNA fragment to be sequenced is obtained by restriction endonuclease cleavage and purified. Both strands are sequenced by selectively labeling the ends of each DNA strand. One strand of DNA is end-labeled with $[^{32}\text{P}]\text{dGTP}$ in reaction tube 1 while the other is end-labeled with $[^{32}\text{P}]\text{dCTP}$ in reaction tube 2. The end-labeled DNA is then subdivided into four fractions where the different bases are chemically destroyed at random positions within the single-stranded DNA molecule. The less selective chemical destruction of adenine simultaneously destroys G and the destruction of thymine destroys the C bases. The single-stranded DNA is cleaved at the sites of the destroyed bases. This generates end-labeled fragments of all possible lengths corresponding to the distance from the end to the sites of base destruction. Labeled DNA fragments are separated according to size by electrophoresis. The DNA sequence can then be determined from the electrophoretic patterns detected on autoradiograms.

from bases destroyed more distant from the end will migrate through the gel more slowly as higher molecular weight molecules. The gel is then exposed to X-ray film, which detects the ^{32}P , and the radioactively labeled bands within the gel can be visualized. The sequence can be read manually or by automated methods directly from the X-ray autoradiograph beginning at the bottom (smaller fragments) and proceeding toward the top of the film (larger fragments). Sequencing the complementary strand checks the correctness of the sequence.

Interrupted Enzymatic Cleavage Method: Sanger Procedure

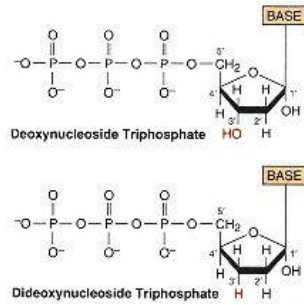
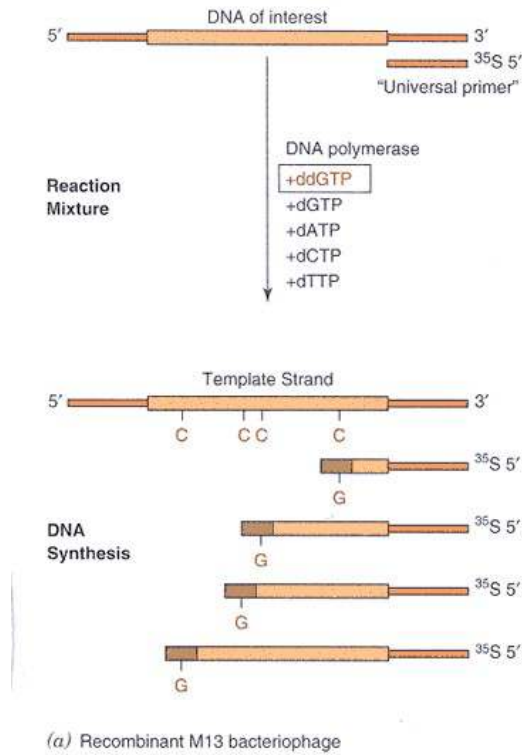

Figure 18.4
Structure of deoxynucleoside triphosphate and dideoxynucleoside triphosphate.
 The 3 -OH group is lacking on the ribose component of the dideoxynucleoside triphosphate (ddNTP). This molecule can be incorporated into a growing DNA molecule through a phosphodiester bond with its 5 -phosphates. Once incorporated, the ddNTP blocks further synthesis of the DNA molecule since it lacks the 3 -OH acceptor group for an incoming nucleotide.

The **Sanger procedure** of DNA sequencing is based on the random termination of a DNA chain during enzymatic synthesis. The technique is possible because the dideoxynucleotide analog of each of the four normal nucleotides (Figure 18.4) can be incorporated into a growing DNA chain by DNA polymerase. The ribose of the **dideoxynucleoside triphosphate (ddNTP)** has the OH group at both the 2 and 3 positions replaced with a proton at the 2 position. Thus the ddNTP incorporated into the growing chain is unable to form a phosphodiester bond with another dNTP because the 3 position of the ribose does not contain an OH group. The growing DNA molecule can be terminated at random points, from the first nucleotide incorporated to the last, by including in the reaction system both the normal nucleotide and the ddNTP (e.g., dATP and ddATP) at concentrations such that the two nucleotides compete for incorporation.

Identification of DNA fragments requires labeling of the 5 end of the DNA molecules or the incorporation of labeled nucleotides during synthesis. The technique, outlined in Figure 18.5, is best conducted with pure single-stranded DNA; however, denatured double-stranded DNA can be used. Today, the DNA



(a) Recombinant M13 bacteriophage

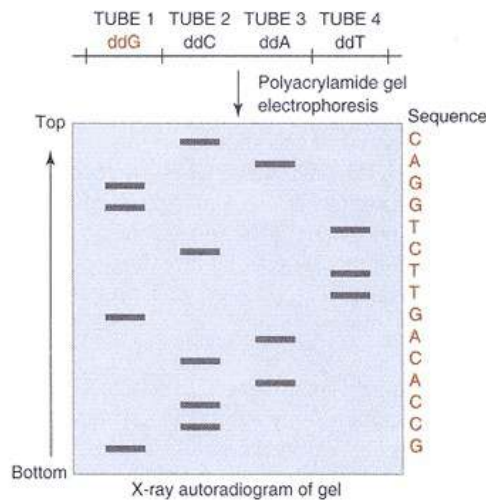

(b) Polyacrylamide gel electrophoresis of reaction mixture

Figure 18.5

Sanger dideoxynucleoside triphosphate method to sequence DNA.

The DNA region of interest is inserted into bacteriophage DNA molecule. Replicating bacteriophage produces a single-stranded recombinant DNA molecule that is readily purified. The known sequence of the bacteriophage DNA downstream of the DNA insert serves as a hybridization site for an end-labeled oligomer with a complementary sequence, a universal primer. Extension of this primer is catalyzed with a DNA polymerase in the presence of all four deoxynucleoside triphosphates plus one dideoxynucleoside triphosphate, for example, ddGTP. Synthesis stops whenever a dideoxynucleoside triphosphate is incorporated into the growing molecule. Note that the dideoxynucleotide competes for incorporation with the deoxynucleotide. This generates end-labeled DNA fragments of all possible lengths that are separated by electrophoresis. The DNA sequence can then be determined from the electrophoretic patterns.

to be sequenced is frequently isolated from a recombinant single-stranded bacteriophage (see p. 778) where a region flanking the DNA of interest contains a sequence that is complementary to a universal primer. The primer can be labeled with either ³²P or ³⁵S nucleotide. Primer extension is accomplished with one of several different available DNA polymerases; one with great versatility is a genetically engineered form of the bacteriophage T7 DNA polymerase. The reaction mixture, composed of the target DNA, labeled primer, and all four deoxynucleoside triphosphates, is divided into four tubes, each containing a different dideoxynucleoside triphosphate. The ddNTPs are randomly incorporated during the enzymatic synthesis of DNA and cause termination of the chain.

Since the ddNTP is present in the reaction tube at a low level, relative to the corresponding dNTP, termination of DNA synthesis occurs randomly at all possible complementary sites to the DNA template. This yields DNA molecules of varying sizes, labeled at the 5' end, that can be separated by polyacrylamide gel electrophoresis. The labeled species are detected by X-ray autoradiography and the sequence is read.

Initially, this method required a single-stranded DNA template, production of a specific complementary oligonucleotide primer, and the need for a relatively pure preparation of the Klenow fragment of *E. coli* DNA polymerase I. These difficulties have been overcome and modifications have simplified the approach. The Sanger method can rapidly sequence as many as 400 bases while the Maxam–Gilbert method is limited to about 250 bases.

The PCR and Sanger methods can be combined for **direct sequencing** of small DNA regions of interest. The double-stranded PCR product is employed directly as template. Conditions are set such that one strand of melted DNA (template) anneals with the primer in preference to reannealing of template with its complementary strand, which would reform the original double-stranded DNA. Sequencing then follows the standard dideoxy chain termination reaction (typically with Sequenase in lieu of the Klenow polymerase) with synthesis of random-length chains occurring as extensions of the PCR primer. This method has been employed successfully for the diagnosis of genetic disorders (see Clin. Corr. 18.3).

18.5—

Recombinant DNA and Cloning

DNA from Different Sources Can Be Ligated to Form a New DNA Species: Recombinant DNA

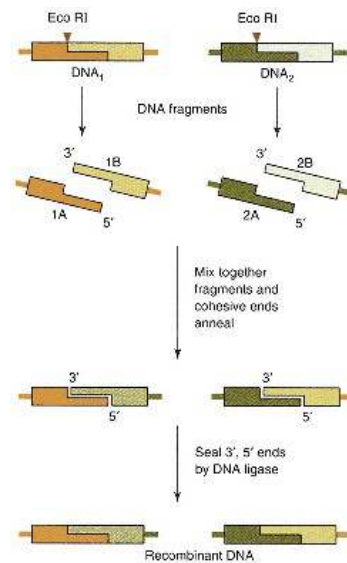

Figure 18.6
Formation of recombinant DNA from restriction endonuclease-generated fragments containing cohesive ends.

Many restriction endonucleases hydrolyze DNA in a staggered fashion, yielding fragments with single-stranded regions at their 5' and 3' ends. DNA fragments generated from different molecules with the same restriction endonuclease have complementary single-stranded ends that can be annealed and covalently linked together with a DNA ligase.

All different combinations are possible in a mixture. When two DNA fragments of different origin combine it results in a recombinant DNA molecule.

The ability to selectively hydrolyze a population of DNA molecules with a battery of restriction endonucleases led to the development of a technique for joining two different DNA molecules termed **recombinant DNA**. This technique combined with the various techniques for replication, separation, and identification permits the production of large quantities of purified DNA fragments. The combined techniques, referred to as **recombinant DNA technologies**, allow the removal of a piece of DNA out of a larger complex molecule, such as the genome of a virus or human, and amplification of the DNA fragment. Recombinant DNAs have been prepared with DNA fragments from bacteria combined with fragments from humans, viruses with viruses, and so on. The ability to join two different pieces of DNA together at specific sites within the molecules is achieved with two enzymes, a restriction endonuclease and a **DNA ligase**. There are a number of different restriction endonucleases, varying in their nucleotide sequence specificity, that can be used (Section 18.3). Some hydrolyze the two strands of DNA in a staggered fashion, producing "*sticky* or *cohesive*" ends (Figure 18.6), while others cut both strands symmetrically, producing a *blunt end*. A specific restriction enzyme cuts DNA at exactly the same nucleotide sequence site regardless of the source of the DNA (bacteria, plant, mammal, etc.). A DNA molecule may have one, several, hundreds, thousands, or no recognition sites for a particular restriction endonuclease. The staggered cut results in a fragmented DNA molecule with ends that are single stranded. When different DNA fragments generated by the same restriction endonuclease are mixed, their single-stranded ends can hybridize, that is, anneal together. In the presence of DNA ligase the two fragments are connected covalently, producing a recombinant DNA molecule.

The DNA fragments produced from restriction endonuclease that form blunt ends can also be ligated but with much lower efficiency. The efficiency can be increased by enzymatically adding a poly(dA) tail to one species of DNA and a poly(dT) tail to the ends of the second species of DNA. The DNA fragments

CLINICAL CORRELATION 18.3**Direct Sequencing of DNA for Diagnosis of Genetic Disorders**

The X-linked recessive hemorrhagic disorder hemophilia B is caused by a coagulation factor IX deficiency. The factor IX gene has been cloned and sequenced and contains 8 exons spanning 34 kb that encode a glyco-protein secreted by the liver. Over 300 mutations of the gene have been discovered of which about 85% are single base substitutions and the rest are complete or partial gene deletions. Several methods have been employed to identify carriers of a defective gene copy and for prenatal diagnoses. Unfortunately, these methods were costly, time consuming, and all too often inaccurate. Direct sequencing of PCR amplified genomic DNA has been employed to circumvent these diagnostic shortcomings. Between 0.1 and 1 μ g of genomic DNA can readily be isolated from patient blood samples and each factor IX exon can be PCR amplified with appropriate primers. The amplified DNA can then be used for direct sequencing to determine if a mutation in the gene exists that would be diagnostic of one of the forms of hemophilia B. For example, a patient with a moderate hemophilia B (London 6) had an A/G transition at position 10442 that led to a substitution of Asp 64 by Gly.

Green, P. M., Bentley, D. R., Mibashan, R. S., Nilsson, I. M., and Gianelli, F. Molecular pathology of hemophilia b. *EMBO J.* 8:1067, 1989.

with complementary tails can be annealed and ligated in the same manner as fragments with restriction enzyme-generated cohesive ends.

Recombinant DNA Vectors Can Be Produced in Significant Quantities by Cloning

Synthesis of a recombinant DNA opens the way for production of significant quantities of interesting DNA fragments. By incorporating a recombinant DNA into a cellular system that allows replication of recombinant DNA, amplification of DNA of interest can be achieved. A carrier DNA, termed a **cloning vector**, is employed. Bacterial plasmids are ideally suited as recombinant DNA vectors. Many bacteria contain a single circular chromosome of approximately 4 million base pairs and minicircular DNA molecules called **plasmids**. Plasmids are usually composed of only a few thousand base pairs and are rarely associated with the large chromosomal molecule. Genes within the plasmid have various functions; one of the most useful is the ability to confer antibiotic resistance to the bacterium, an attribute useful in selecting specific colonies of the bacteria. Plasmids replicate independently of replication of the main bacterial chromosome. One type of plasmid, the **relaxed-control** plasmids, may be present in tens to hundreds of copies per bacterium, and replication is dependent solely on host enzymes that have long half-lives. Therefore replication of "**relaxed**" plasmids can occur in the presence of a protein synthesis inhibitor. Bacteria can accumulate several thousand plasmid copies per cell under these conditions. Other plasmid types are subjected to **stringent control** and their replication is dependent on the continued synthesis of plasmid-encoded proteins. These plasmids replicate at about the same rate as the large bacterial chromosome, and only a low number of copies occur per cell. The former plasmid type is routinely used for recombinant DNA studies.

The first practical recombinant DNA molecule that could be cloned involved as a vector the *E. coli* **plasmid pSC101**, which contains a single EcoRI restriction endonuclease site and a gene that encodes for a protein that confers antibiotic resistance to the bacteria. This plasmid contains an origin of replication and associated DNA regulatory sequences that are referred to as a **replicon**. This vector, however, suffers from a number of limiting factors. The single restriction endonuclease site limits the DNA fragments that can be cloned and the one antibiotic-resistance selectable marker reduces the convenience in selection; in addition, it replicates poorly.

Plasmid vectors with broad versatilities have been constructed using recombinant DNA technology. The desirable features of a plasmid vector include a relatively low molecular weight (3–5 kb) to accommodate larger fragments; several different restriction endonuclease sites useful in cloning a variety of restriction enzyme-generated fragments; multiple selectable markers to aid in selecting bacteria with recombinant DNA molecules; and a high rate of replication. The first plasmid constructed (Figure 18.7) to satisfy these requirements was **pBR322** and this plasmid has been used for the subsequent generation of newer vectors in use today. Most currently employed vectors contain an inserted sequence of DNA termed **polylinker**, **restriction site bank**, or **polycloning site**, which contains numerous restriction endonuclease sites unique to the plasmid.

DNA Can Be Inserted into Vector DNA in a Specific Direction:**Directional Cloning**

Directional cloning reduces the number of variable "recombinants" and enhances the probability of selection of the desired recombinant. Insertion of foreign DNA, with a defined polarity, into a plasmid vector in the absence of the plasmid resealing itself can be accomplished by employing two restriction

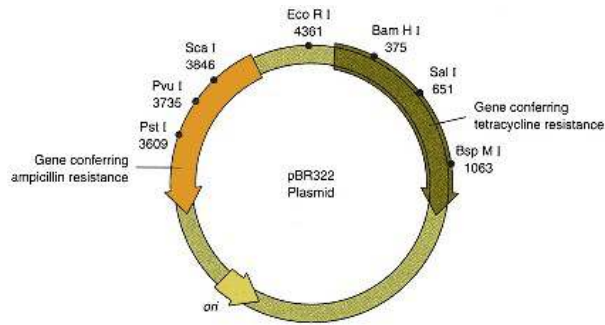

Figure 18.7

The pBR322 plasmid constructed in the laboratory to contain features that facilitate cloning foreign DNA fragments.

By convention, the numbering of the nucleotides begins with the first T in the unique EcoRI recognition sequence (GAATTC) and the positions on the map refer to the 5' base of the various restriction endonuclease-recognition sequences. Only a few of the unique restriction sites within the antibiotic resistance genes and none of the numerous sites where an enzyme cuts more than once within the plasmid are shown.

endonucleases to cleave the plasmids (Figure 18.8); vectors with polylinkers are ideally suited for this purpose. The use of two enzymes yields DNA fragments and linearized plasmids with different "sticky" ends. Under these conditions the plasmid is unable to reanneal with itself. In addition, the foreign DNA can be inserted into the vector in only one orientation. This is extremely important when one clones a potentially functional gene downstream from the promoter-regulatory elements in expression vectors (see p. 778).

Bacteria Can Be Transformed with Recombinant DNA

The process of artificially introducing DNA into bacteria is referred to as **transformation**. It is accomplished by briefly exposing the cells to divalent cations that make them transiently permeable to small DNA molecules. Recombinant plasmid molecules, containing foreign DNA, can be introduced into bacteria where it would replicate normally.

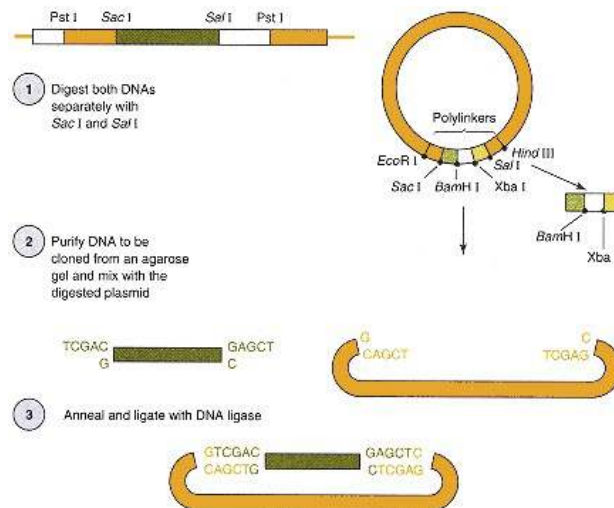

Figure 18.8

Directional cloning of foreign DNA into vectors with a specified orientation.

Insertion of a foreign DNA fragment into a vector with a specified orientation requires two different annealing sequences at each end of the fragment and the corresponding complementary sequence at the two ends generated in the vector. A polylinker with numerous unique restriction endonuclease sites within the vector facilitates directional cloning. Knowledge of the restriction map for the DNA of interest allows for selection of appropriate restriction endonucleases to generate specific DNA fragments that can be cloned in a vector.

It Is Necessary to Be Able to Select Transformed Bacteria

Once the plasmid has been introduced into the bacterium, both can replicate. Methods are available to select those bacteria that carry the recombinant DNA molecules. In the recombinant process some bacteria may not be transformed or may be transformed with a vector not carrying foreign DNA; in preparing the vector some may reanneal without inclusion of the DNA of interest. In some experimental conditions one can generate DNA fragments that can be readily purified for recombinant studies. Such fragments can be generated from small, highly purified DNA species, for example, some DNA viruses. More typically, however, a single restriction endonuclease will generate hundreds to hundreds of thousands of DNA fragments, depending on the size and complexity of DNA being studied. Individual fragments cannot be isolated from these samples to be individually incorporated into the plasmid. Methods have therefore been developed to select those bacteria containing the desired DNA.

Restriction endonucleases do not necessarily hydrolyze DNA into fragments containing intact genes. If the fragment contains an entire gene it may not contain the required flanking regulatory sequences, such as the promoter region. If the foreign gene is of mammalian origin, its regulatory sequences would not be recognized by the bacterial synthetic machinery. The primary gene transcript (pre-mRNA) can also contain introns that cannot be processed by the bacteria.

Recombinant DNA Molecules in a Gene Library

When a complex mixture of thousands of different genes, arranged on different chromosomes, as in the human genome, is subjected to hydrolysis with a single restriction endonuclease, thousands of DNA fragments are generated. These DNA fragments are annealed with a plasmid vector that has been cleaved to a linear molecule with the same restriction endonuclease. By adjusting the ratio of plasmid to foreign DNA the probability of joining at least one copy of each DNA fragment within a cyclized recombinant-plasmid DNA approaches one. Usually, only one out of the multiple DNA fragments is inserted into each plasmid vector. Bacteria are transformed with the recombinant molecules such that only one plasmid is taken up by a single bacterium. Each recombinant molecule can now be replicated within the bacterium and the bacterium will give rise to progeny, each carrying multiple copies of the recombinant DNA. The total population of bacteria now contain fragments of DNA that may represent the entire human genome. This is termed a **gene library**. As in any library containing thousands of volumes, a selection system must be available to retrieve the book or gene of interest.

Plasmids are commonly employed to clone DNA fragments generated from molecules of limited size and complexity, such as viruses, and to subclone large DNA fragments previously cloned in other vectors. Genomic DNA fragments are usually cloned from other vectors capable of carrying larger foreign DNA fragments than plasmids (see p. 780).

PCR May Circumvent the Need to Clone DNA

Cloning and amplification of a DNA fragment carried within a vector may be employed for subcloning, mutagenesis, and sequencing. The PCR has, in many instances, replaced the need to amplify recombinant DNA in a replicating biological system, greatly reducing the time and preparative steps required. It is not necessary to know the sequence of the DNA insert (up to 6 kb) to amplify it by the PCR, since the sequence of the vector DNA flanking the insert is known.

In some instances the PCR completely circumvents the need to clone the DNA of interest. For instance, a gene that has previously been cloned and sequenced can readily be analyzed in patient DNA for the detection of mutations

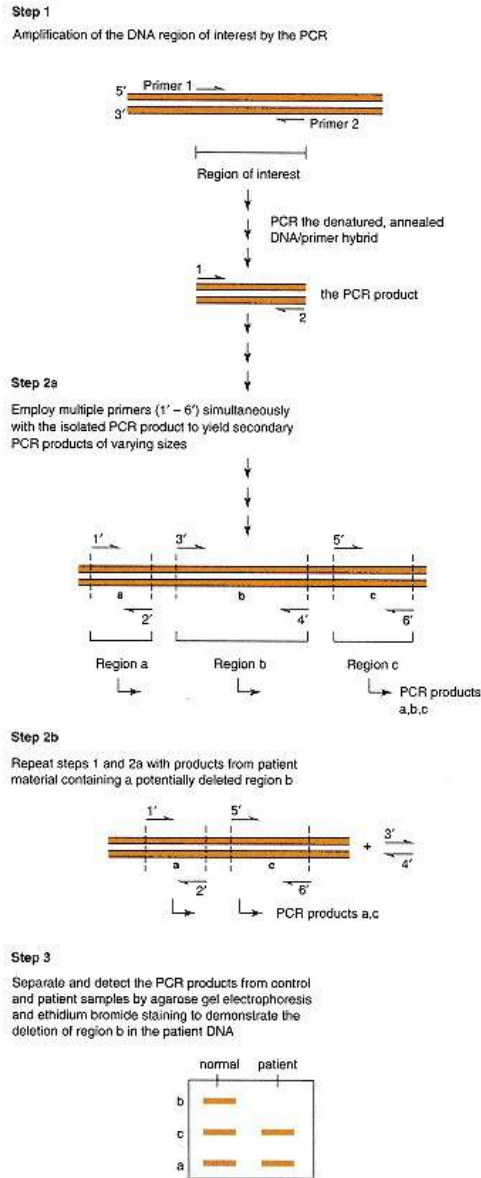

Figure 18.9

A multiplex PCR strategy to analyze a DNA region of interest for mutated alterations.

A region of DNA within a complex DNA molecule, derived from any source, can be amplified by the PCR with specific primers that are complementary to sequences flanking the DNA region of interest (Step 1). After multiple PCR cycles the amplified DNA (PCR product) can then be used as a template simultaneously for multiple pairs of primers (Step 2a) that are complementary throughout the DNA (here they cover three segments—a, b, and c). This procedure requires prior knowledge of the sequence of the normal DNA/gene. Step 2a is repeated for DNA derived from a patient with potential mutation(s) in the DNA region of interest (Step 2b). The amplified DNA products from the multiplex PCR step (Steps 2a and 2b) are then analyzed by agarose gel electrophoresis to ascertain if the patient sample contains a mutation (Step 3).

within this gene by a **multiplex PCR strategy**. DNA is isolated from patient blood cells and multiple pairs of oligonucleotide primers are synthesized to amplify the entire gene or selected regions within the gene (Figure 18.9). Analysis of the amplified DNA fragments by agarose gel electrophoresis would

CLINICAL CORRELATION 18.4**Multiplex PCR Analysis of HGPRTase Gene Defects in Lesch–Nyhan Syndrome**

Lesch–Nyhan syndrome, as described in Clin. Corr. 12.2, results from a deficiency in hypoxanthine–guanine phosphoribosyl-transferase (HGPRTase) activity. Several variant forms of HGPRTase defects have been detected. Multiplex PCR amplification of the *HGPRT* gene locus has been employed to analyze this gene in cells derived from Lesch–Nyhan patients and results account for the variability of the HGPRTase. The gene, comprised of 9 exons, can be multiplex amplified using 16 different primers in a single PCR. The products can be separated by agarose gel electrophoresis. Analysis of the *HGPRT* gene locus by multiplex amplification of DNA derived from cells of several patients detected great variations in deletions of different exons to total absence of the exons.

Rossiter, B. J. F., et al. In: M. J. McPherson, P. Quirke, and G. R. Taylor (Eds.), *PCR. A Practical Approach*, Vol. 1. Oxford, England: Oxford University Press, 1994, p. 67.

allow one to detect any potential deletion mutation as compared to the normal gene products. Direct sequencing of multiple PCR products can be employed to detect point mutations in the patient gene. Multiplex PCR has been used to detect various defects in the HGPRTase gene in Lesch–Nyhan patients (see Clin. Corr. 18.4).

18.6—**Selection of Specific Cloned DNA in Libraries*****Loss of Antibiotic Resistance Is Used to Select Transformed Bacteria***

When a single transformed bacterium carrying a recombinant molecule multiplies, its progeny are all genetically the same. If the transformed bacterium carries a recombinant DNA, all progeny will carry copies of the same recombinant plasmid. The foreign DNA has been amplified and is derived from a single cloned DNA fragment. The problem is how to identify the one colony containing the desired plasmid in a field of thousands to millions of different bacterial colonies. The plasmid construct pBR322 and its descendants carry two genes that confer antibiotic resistance. Within these antibiotic-resistant genes are DNA sequences sensitive to restriction endonuclease. When a fragment of foreign DNA is inserted into a restriction site within the gene for antibiotic resistance, the gene becomes nonfunctional. Bacteria carrying this recombinant plasmid are sensitive to the antibiotic (Figure 18.10). The second antibiotic resistance gene within the plasmid, however, remains intact and the bacteria will be resistant to this antibiotic. This technique of **insertional inactivation** of plasmid gene products affords a method to select bacteria that carry recombinant plasmids.

pBR322 contains genes that confer resistance to ampicillin (*amp^r*) and tetracycline (*tet^r*). A gene library with cellular DNA fragments inserted within the *tet^r* gene can be selected and screened in two stages (Figure 18.10). First, the bacteria are grown in an ampicillin-containing growth medium. Bacteria that are not transformed by a plasmid (they lack a normal or recombinant plasmid) during the construction of the gene library will not grow in the presence of the antibiotic, thus eliminating this population of bacteria. This, however, does not indicate which of the remaining viable bacteria carry a recombinant plasmid vector versus a plasmid with no DNA insert. The second step is to identify bacteria carrying recombinant vectors with nonfunctional *tet^r* genes, which are therefore sensitive to tetracycline.

Bacteria insensitive to ampicillin are plated and grown on agar plates containing ampicillin (Figure 18.10). Replica plates can be made by touching the colonies on the original agar plate with a filter and then touching additional sterile plates with the filter. All the plates will contain portions of each original colony at identifiable positions on the plates. The replica plate can contain tetracycline, which will not support the growth of bacteria harboring recombinant plasmids with their *tet^r* gene disrupted. Comparison of replica plates with and without tetracycline will indicate which colonies on the original ampicillin plate contain recombinant plasmids. Thus individual colonies containing the recombinant DNA can be selected, cultured, and analyzed.

Either **DNA** or **RNA probes** (see pp. 583 and 773) can be utilized to identify the DNA of interest. Ampicillin-resistant bacterial colonies on agar can be replica plated onto a nitrocellulose filter and adhering cells from each colony can be lysed with NaOH (Figure 18.10). DNA within the lysed bacteria is also denatured by the NaOH and becomes firmly bound to the filter. A labeled DNA or RNA probe that is complementary to the DNA of interest can be hybridized to the nitrocellulose-bound DNA. The filter is exposed to X-ray autoradiography. Any colony carrying the cloned DNA of interest will appear as a developed signal on the X-ray film. These spots would then correspond to the colony on the

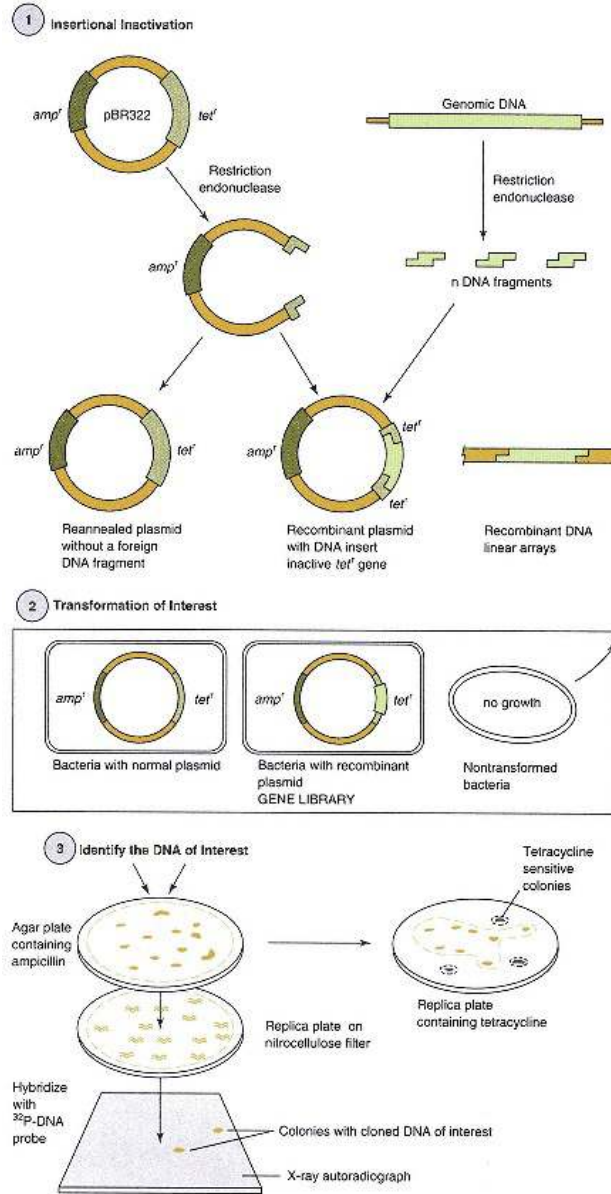

Figure 18.10

Insertional inactivation of recombinant plasmids and detection of transformed bacteria carrying a cloned DNA of interest.

When the insertion of a foreign DNA fragment into a vector disrupts a functional gene sequence, the resulting recombinant DNA does not express the gene. The gene that codes for antibiotic resistance to tetracycline (*tet^r*) is destroyed by DNA insertion while the ampicillin resistance gene (*amp^r*) remains functional. Destruction of one antibiotic resistance gene and retention of a second antibiotic resistance gene allow for the detection of bacterial colonies carrying the foreign DNA of interest within the replicating recombinant vector.

original agar plate that can then be grown in a large-scale culture for further manipulation.

Cloned and amplified DNA fragments usually do not contain a complete gene and are not expressed. The DNA inserts, however, can readily be purified for sequencing or used as probes to detect genes within a mixture of genomic DNA, transcription levels of mRNA, and pathological conditions via clinical diagnostic tests.

α-Complementation for Selecting Bacteria Carrying Recombinant Plasmids

Other selection techniques can identify bacteria carrying recombinant DNA molecules. Vectors have been constructed (the pUC series) such that selected bacteria transformed with these vectors carrying foreign DNA inserts can be identified visually (Figure 18.11). The pUC plasmids contain the regulatory sequences and a portion of the 5'-end coding sequence (N-terminal 146 amino acids) for the β -galactosidase gene (*lacZ* gene) of the *lac* operon (Chapter 19, p. 802). The translated N-terminal 146 amino acid fragment of β -galactosidase is an inactive polypeptide. Mutant *E. coli* that code for the missing inactive carboxy-terminal portion of β -galactosidase can be transformed with the pUC plasmids. The translation of the host cell and plasmid portions of the β -galactosidase in response to an inducer, isopropylthio- β -D-galactoside, complement each other, yielding an active enzyme. The process is referred to as **α -complementation**. When these transformed bacteria are grown in the presence of a chromogenic substrate (5-bromo-4-chloro-3-indolyl- β -D-galactoside [X-gal]) for β -galactosidase they form blue colonies. If, however, a foreign DNA fragment is inserted into the base sequence for the N-terminal portion of β -galactosidase,

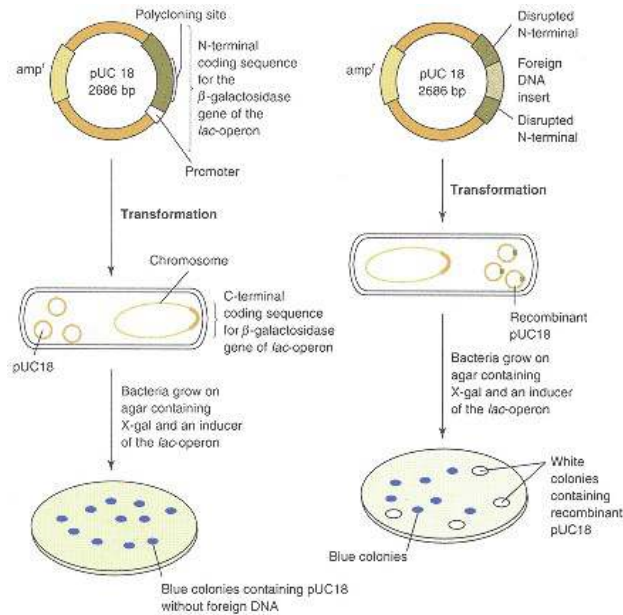

Figure 18.11

α -Complementation for detection of transformed bacteria.

A vector has been constructed (pUC 18) that expresses the N-terminal coding sequence for the enzyme β -galactosidase of the *lac* operon. Bacterial mutants coding for the C-terminal portion of β -galactosidase are transformed with pUC 18. These transformed bacteria, grown in the presence of a special substrate for the intact enzyme (X-gal), result in blue colonies because they contain the enzyme to react with substrate. The functional N-terminal and C-terminal coding sequences for the gene complement each other to yield a functional enzyme. If, however, a foreign DNA fragment insert disrupts the pUC 18 N-terminal coding sequence for β -galactosidase, bacteria transformed with this recombinant molecule will not produce a functional enzyme. Bacterial colonies carrying these recombinant vectors can then be visually detected as white colonies.

the active enzyme cannot be formed. Bacteria transformed with these recombinant plasmids and grown on X-gal will yield white colonies and can be selected visually from nontransformed blue colonies.

18.7—

Techniques for Detection and Identification of Nucleic Acids

Nucleic Acids Can Serve As Probes for Specific DNA or RNA Sequences

Selection of bacteria harboring recombinant DNAs of interest, analysis of mRNAs expressed in a cell, or identification of the presence of DNA sequences within a genome require sensitive and specific detection methods. DNA and RNA **probes** meet these requirements. These probes contain nucleotide sequences complementary to the target nucleic acid and will thus hybridize with the nucleic acid of interest. The degree of complementarity of a probe with the DNA under investigation determines the tightness of binding of the probe. The probe does not need to contain the entire complementary sequence of the DNA. The probe, RNA or DNA, can be labeled, usually with ^{32}P . Nonradioactive labels are also employed that depend on enzyme substrates coupled to nucleotides, which when incorporated into the nucleic acid can be detected by an enzyme-catalyzed reaction.

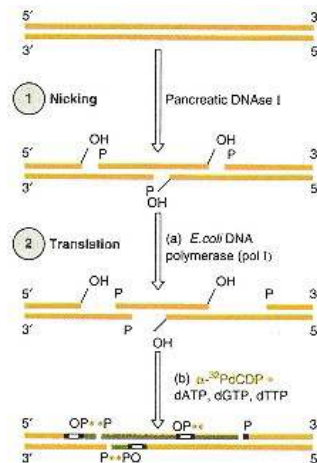

Figure 18.12

Nick translation to label DNA probes.

Purified DNA molecules can be radioactively labeled and used to detect, by hybridization, the presence of complementary RNA or DNA in experimental samples.

- (1) Nicking step: introduces random single-stranded breaks in the DNA.
- (2) Translation step: (a) *E. coli* DNA polymerase (pol I) has 5' → 3' exonucleolytic activity that hydrolyzes nucleotides from the 5' end of the nick; (b) pol I simultaneously fills in the single-stranded gap with radioactively labeled nucleotides using the 3' end as a primer.

Labeled probes can be produced by **nick translation** of double-stranded DNA. Nick translation (Figure 18.12) involves the random enzymatic hydrolysis of a phosphodiester bond in the backbone of one strand of DNA by DNase I; the enzymatic breaks in the DNA backbone are referred to as nicks. A second enzyme, *E. coli* DNA polymerase I, with its 5' → 3' exonucleolytic activity and its DNA polymerase activity, creates single-strand gaps by hydrolyzing nucleotides from the 5' side of the nick and then filling in the gaps with its polymerase activity. The polymerase reaction is usually carried out in the presence of one α - ^{32}P -labeled deoxynucleotide triphosphate and three unlabeled deoxynucleotide triphosphates. The DNA employed in this method is usually purified and is derived from cloned DNA, viral DNA, or cDNA.

Another method to label DNA probes, **random primer labeling of DNA**, has distinct advantages over the nick translation method. The random primer method typically requires only 25 ng of DNA as opposed to 1–2 μg of DNA for nick translation and results in labeled probes with a specific activity ($>10^9$ cmp μg^{-1}) approximately ten times higher. This method generally produces longer labeled DNA probes. The double-stranded probe is melted and hybridized with a mixture of random hexanucleotides containing all possible sequences (ACTCGG, ACTCGA, ACTCGC, etc.). The hybridized hexanucleotides serve as primers for DNA synthesis with a DNA polymerase, such as the Klenow enzyme, in the presence of one or more radioactively labeled deoxynucleoside triphosphates.

Labeled RNA probes have advantages over DNA probes. For one, relatively large amounts of RNA can be transcribed from a template, which may be available in very limited quantities. A double-stranded DNA (dsDNA) probe must be denatured prior to hybridization with the target DNA and rehybridization with itself competes for hybridization with the DNA of interest. No similar competition occurs with the single-stranded RNA probes that hybridize with complementary DNA or RNA molecules. Synthesis of an RNA probe requires DNA as a template. To be transcribed the template DNA must be covalently linked to an upstream promoter that can be recognized by a DNA-dependent RNA polymerase. Vectors have been constructed that are well suited for this technique.

A labeled DNA or RNA probe can be hybridized to nitrocellulose-bound nucleic acids and identified by the detection of the labeled probe. The nucleic

acids of interest can be transferred to nitrocellulose from bacterial colonies grown on agar or from agarose gels where the nucleic acid species have been electrophoretically separated by size.

Southern Blot Technique Is Useful for Identifying DNA Fragments

A technique to transfer DNA species, separated by agarose gel electrophoresis, to a filter for analysis was developed in the 1970s, and it is an indispensable tool. The method, developed by E. M. Southern, is referred to as the **Southern blot technique** (Figure 18.13). A DNA mixture of discrete restriction endonuclease-generated fragments from any source and complexity can be separated according to size by electrophoresis through an agarose gel. The DNA is dena-

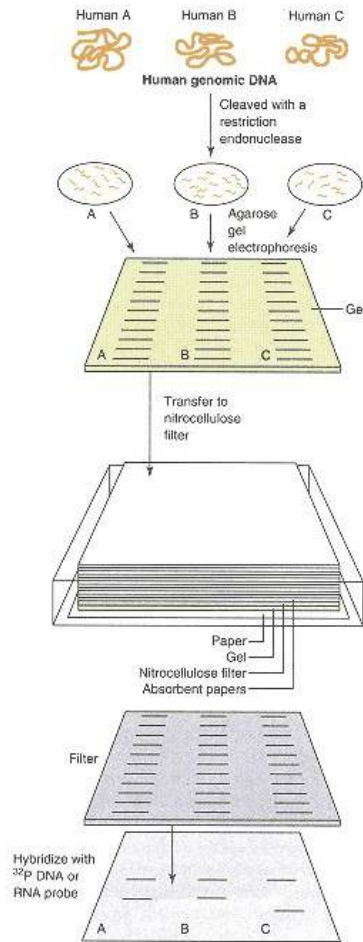

Figure 18.13
Southern blot to transfer DNA from agarose gels to nitrocellulose.

Transfer of DNA to nitrocellulose, as single-stranded molecules, allows for the detection of specific DNA sequences within a complex mixture of DNA. Hybridization with nick translated labeled probes can demonstrate if a DNA sequence of interest is present in the same or different regions of the genome.

tured by soaking the gel in alkali. The gel is then placed on absorbent paper and a nitrocellulose filter placed directly on top of the gel. Several layers of absorbent paper are placed on top of the nitrocellulose filter. The absorbent paper under the gel is kept wet with a concentrated salt solution that by capillary action is pulled up through the gel, the nitrocellulose, and into the absorbent paper layers above. The DNA is eluted from the gel by the upward movement of the high salt solution onto the nitrocellulose filter directly above, where it becomes bound. The position of the DNA bound to the nitrocellulose filter is exactly that which was present in the agarose gel. In its single-stranded membrane-bound form, the DNA can be analyzed with labeled probes.

The Southern blot technique is invaluable in analytical procedures for detection of the presence and determination of the number of copies of particular sequences in complex genomic DNA, confirming DNA cloning results, and demonstrating the polymorphic DNA arrangements of the human genome that correspond to pathological states. An example of the use of Southern blots is shown in Figure 18.13. Here whole human genomic DNA, isolated from three individuals, was digested with a restriction endonuclease, generating thousands of fragments. These fragments were distributed throughout the agarose gel according to size in an electric field. The DNA was transferred (blotted) to a nitrocellulose filter and hybridized with a ^{32}P -labeled DNA or RNA probe that represents a portion of a gene of interest. The probe detected two bands in all three individuals, indicating that the gene of interest is cleaved at one site within its sequence. Individuals A and B presented a normal pattern while patient C had one normal band and one lower molecular weight band. This is an example of altered DNA within different individuals of a single species, **restriction fragment length polymorphism (RFLP)**, and implies a deletion in a segment of the gene that may be associated with a pathological state. The gene from this patient can be cloned, sequenced, and fully analyzed to characterize the altered nature of the DNA (see Clin. Corr. 18.5).

Other techniques that employ the principles of Southern blot are the transfer of RNA (Northern blots) and of proteins (Western blots) to nitrocellulose filters or nylon membranes.

Single-Strand Conformation Polymorphism

Southern blot analysis and detection of base changes in DNA from different individuals by RFLP analysis is dependent on alteration of a restriction endonuclease site. Often a base substitution, deletion, or insertion does not occur within a restriction endonuclease site. However, these modifications can readily be detected by **single-strand conformation polymorphism (SSCP)**. This technique takes advantage of the fact that single-stranded DNA, smaller than 400 bases long, subjected to electrophoresis through a polyacrylamide gel migrates with a mobility partially dependent on its conformation. A single base alteration usually modifies the DNA conformation sufficiently to be detected as a mobility shift upon electrophoresis through a nondenaturing polyacrylamide gel. The analysis of a small region of genomic DNA or cDNA for SSCP can be accomplished by PCR amplification of the region of interest. Sense and antisense oligonucleotide primers are synthesized that flank the region of interest and this DNA is amplified by PCR in the presence of radiolabeled nucleotide(s). The resulting purified radiolabeled double-stranded PCR product is then heat denatured in 80% formamide and immediately loaded onto a nondenaturing polyacrylamide gel. The mobilities of control products are compared to samples derived from experimental/patient samples. Detection of mutations in patient samples can identify genetic lesions. This method depends on prior knowledge of the sequence of the gene/gene fragment of interest, while analysis by RFLP requires only restriction map analysis of DNA.

CLINICAL CORRELATION 18.5

Restriction Fragment Length Polymorphisms Determine the Clonal Origin of Tumors

It is generally assumed that most tumors are monoclonal in origin; that is, a rare event alters a single somatic cell genome in such a fashion that the cells grow abnormally into a tumor mass with all-daughter cells carrying the identically altered genome. Proof that a tumor is of monoclonal origin versus polyclonal in origin can help to distinguish hyperplasia (increased production and growth of normal cells) from neoplasia (growth of new or tumor cells). The detection of restriction fragment length polymorphisms (RFLPs) of Southern blotted DNA samples allows one to define the clonal origin of human tumors. If tumor cells were collectively derived from different parental cells they should contain a mixture of DNA markers characteristic of each cell of origin. However, an identical DNA marker in all tumor cells would indicate a monoclonal origin. The analysis is limited to females where one can take advantage of the fact that each cell carries only one active X chromosome of either paternal or maternal origin with the second X chromosome being inactivated. Activation occurs randomly during embryogenesis and is faithfully maintained in all-daughter cells with one-half the cells carrying an activated maternal X chromosome and the other one-half an activated paternal X chromosome.

Analysis of the clonal nature of a human tumor depends on the fact that activation of an X chromosome involves changes in the methylation of selected cytosine (C) residues within the DNA molecule. Several restriction endonucleases, such as Hha I, which cleaves DNA at GCGC sites, will not cleave DNA at their recognition sequences if a C is methylated within this site. Therefore the methylated state (activated versus inactivated) of the X chromosome can be probed with restriction endonucleases. Furthermore, the paternal X chromosome can be distinguished from the maternal X chromosome in a significant number of individuals based on differences in the electrophoretic migration of restriction endonuclease generated fragments derived from selected regions of the chromosome. These DNA fragments are identified on a Southern blot by hybridization with a DNA probe that is complementary to this region of the X chromosome. An X-linked gene that is amenable to these studies is the hypoxanthine phosphoribosyltransferase (*HPRTase*) gene. The *HPRTase* gene consistently has two BamHI restriction endonuclease sites (B_1 and B_3 in figure), but in many individuals a third site (B_2) is also present (see figure).

The presence of site B_2 in only one parental X chromosome *HPRT* allows for the detection of restriction enzyme-generated polymorphisms. Therefore a female cell may carry one X chromosome with the *HPRT* gene possessing two BamHI sites (results in a single detectable DNA fragment of 24 kb) or three BamHI sites (results in a single detectable DNA fragment of 12 kb). This figure depicts the expected results for the analysis of tumor cell DNA to determine its monoclonal or polyclonal origin. As expected, three human tumors examined by this method were shown to be of monoclonal origin.

Vogelstein, B., Fearon, E. R., Hamilton, S. R., and Feinberg, A. B. Use of restriction fragment length polymorphism to determine the clonal origin of tumors. *Science* 227:642, 1985.

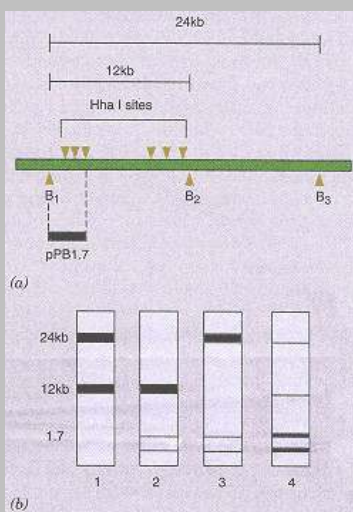

Analysis of genomic DNA to determine the clonal origin of tumors.

- (a) The X chromosome-linked *HPRTase* gene contains two invariant BamHI restriction endonuclease sites (B_1 and B_3) while in some individuals a third site, B_2 , is also present. The *HPRTase* gene also contains several HhaI sites; however, all of these sites, except H1, are usually methylated in the active X chromosome. Therefore only the H1 site would be available for cleavage by HhaI in the active X chromosome. A cloned, labeled probe, pPB1.7, is employed to determine which form of the *HPRTase* gene is present in a tumor and if it is present on an active X chromosome.
- (b) Restriction endonuclease patterns predicted for monoclonal versus polyclonal tumors are as follows:
- (1) Cleaved with BamHI alone; 24-kb fragment derived from *HPRTase* gene containing only B_1 and B_3 sites and 12-kb fragment derived from *HPRTase* gene containing extra B_2 site. Pattern is characteristic for heterozygous individual.
 - (2) Cleaved with BamHI plus HhaI; monoclonal tumor with the 12-kb fragment derived from an active X chromosome (methylated).
 - (3) Cleaved with BamHI plus HhaI; monoclonal tumor with the 24-kb fragment derived from an active X chromosome (methylated).
 - (4) Cleaved with BamHI plus HhaI; polyclonal tumor. All tumors studied displayed patterns as in Lane 2 or Lane 3.

18.8—

Complementary DNA and Complementary DNA Libraries

The insertion of specific functional eukaryotic genes into vectors that can be expressed in a prokaryotic cell could produce large amounts of "genetically engineered" proteins with significant medical, agricultural, and experimental potential. Hormones and enzymes are currently produced by these methods, including insulin, erythropoietin, thrombopoietin, interleukins, interferons, and tissue plasminogen activator. Unfortunately, it is impossible, except in rare instances, to clone functional genes from genomic DNA. One reason for this is that most genes within the mammalian genome yield transcripts that contain introns that must be spliced out of the primary mRNA transcript. Prokaryotic systems cannot splice out the introns to yield functional mRNA transcripts. This problem can be circumvented by synthesizing **complementary DNA (cDNA)** from functional eukaryotic mRNA.

mRNA Is Used As a Template for DNA Synthesis Using Reverse Transcriptase

Messenger RNA can be reverse transcribed to cDNA and the cDNA inserted into a vector for amplification, identification, and expression. Mammalian cells normally contain 10,000–30,000 different species of mRNA molecules at any time during the cell cycle. In some cases, however, a specific mRNA species may approach 90% of the total mRNA, such as mRNA for globin in reticulocytes. Many mRNAs are normally present at only a few (1–14) copies per cell. A **cDNA library** can be constructed from the total cellular mRNA but if only a few copies per cell of mRNA of interest are present, the cDNA may be very difficult to identify. Methods that enrich the population of mRNAs or their corresponding cDNAs permit reduction of the number of different cDNA species within a cDNA library and greatly enhance the probability of identifying the clone of interest.

Desired mRNA in a Sample Can Be Enriched by Separation Techniques

Messenger RNA can be separated by size by gel electrophoresis or centrifugation. Utilization of mRNA in a specific molecular size range will enrich several-fold an mRNA of interest. Knowledge of the molecular weight of the protein encoded by the gene of interest gives a clue to the approximate size of the mRNA transcript or its cDNA; variability in the predicted size, however, will arise from differences in the length of the untranslated regions of the mRNAs.

Enrichment of a specific mRNA molecule can also be accomplished by immunological procedures but requires the availability of antibodies against the protein encoded by the gene of interest. Antibodies added to an *in vitro* protein synthesis mixture will react with the growing polypeptide chain associated with the polysome and precipitate it. The mRNA can be purified from the immunoprecipitated polysomal fraction.

Complementary DNA Synthesis

Figure 18.14
Synthesis of cDNA from mRNA.

The 3' poly(A) tail of mRNA is hybridized with an oligomer of dT [oligo(dT)12–18] that serves as a primer for reverse transcriptase, which catalyzes the synthesis of the complementary DNA (cDNA) strand in the presence of all four deoxynucleotide triphosphates (dNTPs).

The resulting cDNA–mRNA hybrid is separated into single-stranded cDNA by melting with heat or hydrolyzing the mRNA with alkali. The 3' end of the cDNA molecule forms a hairpin loop that serves as a primer for the synthesis of the second DNA strand catalyzed by the Klenow fragment of *E. coli* DNA polymerase. The single-stranded unpaired DNA loop is hydrolyzed by S_1 nuclease to yield a double-stranded DNA molecule.

An isolated mRNA mixture is used as a template to synthesize a complementary strand of DNA using RNA-dependent DNA polymerase, reverse transcriptase (Figure 18.14). A primer is required for the reaction; advantage is taken of the poly(A) tail at the 3' terminus of eukaryotic mRNA. An oligo(dT) with 12–18 bases is employed as the primer that will hybridize with the poly(A) sequence. After cDNA synthesis, the hybrid is denatured or the mRNA hydrolyzed in alkali in order to obtain the single-stranded cDNA. The 3' termini of single-stranded cDNAs form a hairpin loop that serves as a primer for the synthesis of the second strand of the cDNA. Either the Klenow fragment or a reverse transcriptase can be used for this step. The resulting double-stranded cDNA contains a single-

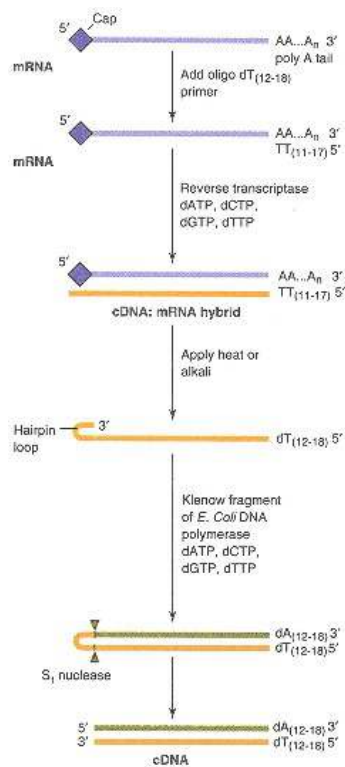
stranded loop that is selectively recognized and digested by S1 nuclease. The ends of the cDNA must be modified prior to cloning in a vector. One method involves incubating blunt-ended cDNA molecules with linker molecules and a bacteriophage T4 DNA ligase that catalyzes the ligation of blunt-ended molecules (Figure 18.15). The synthetic linker molecules contain restriction endonuclease sites that can now be hydrolyzed with the appropriate enzyme for insertion of the cDNA into a compatibly cut vector.

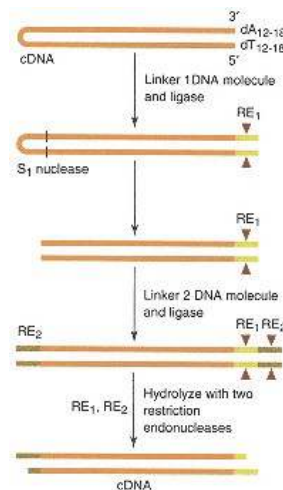

Figure 18.15

Modification of cDNA for cloning.

The procedure begins with double-stranded DNA containing a hairpin loop. A linker DNA containing a restriction endonuclease site (RE_1) is added to the free end of the cDNA by blunt-end ligation. The single-stranded hairpin loop is next hydrolyzed with S_1 nuclease. A second linker with a different restriction endonuclease site within (RE_2) is blunt-end ligated to the newly created free cDNA. The second linker will probably bind to both ends but will not interfere with the first restriction endonuclease site. The modified DNA is hydrolyzed with the two restriction endonucleases and can be inserted into a plasmid or bacteriophage DNA by directional cloning.

Bacteriophage DNA (see p. 779) is the most convenient and efficient vector to create cDNA libraries because they can readily be amplified and stored indefinitely. Two bacteriophage vectors, λ gt10 and λ gt11, and their newer constructs have been employed to produce cDNA libraries. The cDNA libraries in λ gt10 can be screened only with labeled nucleic acid probes, whereas those in λ gt11, an expression vector, can also be screened with antibody for the production of the protein or antigen of interest.

Total Cellular RNA May Be Used As a Template for DNA Synthesis Using RT-PCR

Alternative methods to construct cDNA libraries employ a **reverse transcriptase–PCR (RT-PCR) technique** and obviate the need to purify mRNA. One such strategy is depicted in Figure 18.16 and begins with the reverse transcriptase production of a DNA–mRNA hybrid. The method then adds a dG homopolymer tail to the 3' end catalyzed by terminal transferase and the subsequent hydrolysis of the mRNA. PCR primers are synthesized to hybridize with the dG, dA tails and terminate with two different restriction endonuclease sequences. The resulting PCR-amplified cDNA can then be hydrolyzed with the two different restriction endonucleases for directional cloning (see p. 765, Section 18.5) into an appropriate vector.

18.9—

Bacteriophage, Cosmid, and Yeast Cloning Vectors

Detection of noncoding sequences in most eukaryotic genes and distant regulatory regions flanking the genes necessitated new cloning strategies to package larger DNA fragments than could be cloned in plasmids. Plasmids can accommodate foreign DNA inserts with a maximum length in the range of 5–10 kb (kilobases). Portions of recombinant DNA fragments larger than this are randomly deleted during replication of the plasmid within the bacterium. Thus alternate vectors have been developed.

Bacteriophage As Cloning Vectors

Bacteriophage λ (λ phage)—a virus that infects and replicates in bacteria—is an ideal vector for DNA inserts of approximately 15-kb lengths. The λ phage selectively infects bacteria and can replicate by either a lytic or nonlytic (lysogenic) pathway. The λ phage contains a self-complementary 12-base single-stranded tail (cohesive termini) at both ends of its 50-kb double-stranded DNA molecule. Upon infection of the bacteria the cohesive termini (cos sites) of a single λ phage DNA molecule self-anneal and the ends are covalently linked with the host cell DNA ligase. The circular DNA molecule serves as a template for transcription and replication. The λ phage, with restriction endonuclease-generated fragments representing a cell's whole genomic DNA inserted into it, is used to infect bacteria. Recombinant bacteriophages, released from the lysed cells, are collected and constitute a genomic library in λ phage. The phage library can be screened more rapidly than a plasmid library due to the increased size of the DNA inserts.

Numerous λ phage vectors have been constructed for different cloning strategies. For the sake of simplicity only a generic λ phage vector will be

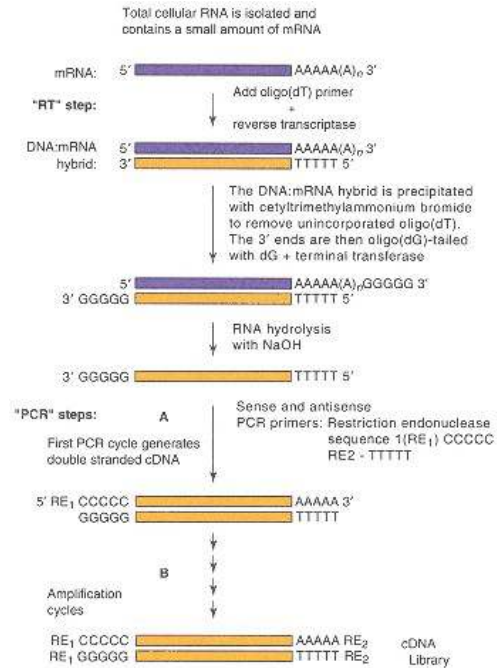

Figure 18.16

Generation of cDNA by reverse transcriptase–PCR (RT-PCR). Total cellular RNA or mRNA can be used to generate cDNA by RT-PCR. The mRNA with an oligo rA tail is reverse transcribed with an oligo dT primer. An oligo dG tail is added to the 3' ends of the RNA and DNA strands and the RNA strand is subsequently hydrolyzed with NaOH. Sense and antisense primers, modified with restriction site sequences, are then employed to amplify the cDNA by the PCR. The products can be hydrolyzed with the specific restriction endonucleases (RE₁ and RE₂) for cloning and subsequent studies.

described here. Cloning large fragments of DNA in λ phage takes advantage of the fact that a 15–25 kb segment of the phage DNA can be replaced without impairing its replication in *E. coli* (Figure 18.17). Packaging of phage DNA into the virus particle is constrained by its total length, which must be approximately 50 kb. The linear phage DNA can be digested with specific restriction endonucleases that generate small terminal fragments with their **cos sites** (arms), which are separated from the larger intervening fragments. Cellular genomic DNA is partially digested with the appropriate restriction enzymes to permit annealing and ligation with the phage arms. Genomic DNA is not enzymatically hydrolyzed completely in order to randomly generate fragments that can be properly packaged into phage particles. The DNA fragments that are smaller or larger than 15–25 kb can hybridize with the cos arms but are excluded from being packaged into infectious bacteriophage particles. All of the information required for phage infection and replication in bacteria is carried within the cos arms. The recombinant phage DNA is mixed with phage proteins *in vitro*, which assemble into infectious virions. The infectious recombinant phage particles are then propagated in an appropriate *E. coli* strain to yield a **λ phage library**. Many different *E. coli* strains have been genetically altered to sustain replication of specific recombinant virions.

Screening Bacteriophage Libraries

The bacteriophage library can be screened by plating the virus on a continuous layer of bacteria (a bacterial lawn) grown on agar plates (Figure 18.18). The individual phage will infect, replicate, and lyse one cell. The progeny virions will then infect and subsequently lyse bacteria immediately adjacent to the site of the first infected cell, creating a clear region or plaque in the opaque bacterial

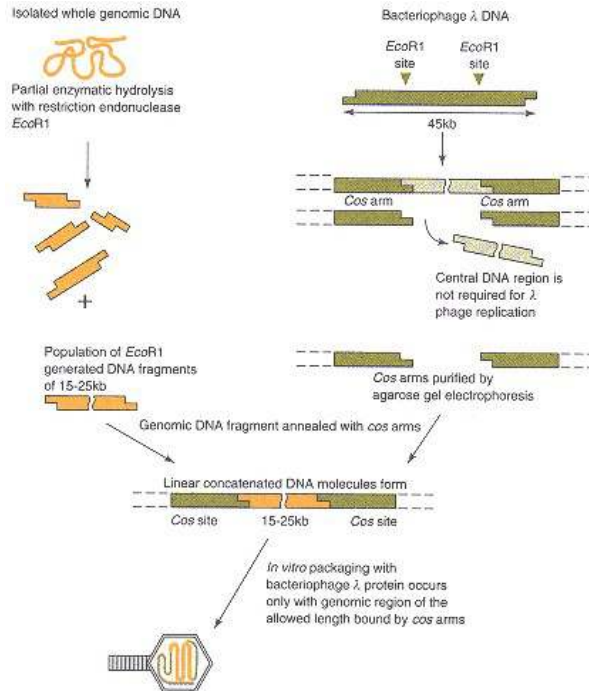

Figure 18.17

Cloning genomic DNA in bacteriophage λ .

Whole genomic DNA is incompletely digested with a restriction endonuclease (e.g., EcoRI). This results in DNA of random size fragments with single-stranded sticky ends. DNA fragments, cos arms, are generated with the same restriction endonuclease from bacteriophage λ DNA. The purified cos arm fragments carry sequence signals required for packaging DNA into a bacteriophage virion. The genomic fragments are mixed with the cos arms, annealed, and ligated, forming linear concatenated DNA arrays. The *in vitro* packaging with bacteriophage λ proteins occurs only with genomic DNA fragments of allowed lengths (15–25 kb) bounded by cos arms.

field. Phage, within each plaque, can be picked up on a nitrocellulose filter (as for replica plating) and the DNA fixed to the filter with NaOH. The location of cloned DNA fragments of interest is determined by hybridizing the filter-bound DNA with a labeled DNA or RNA probe followed by autoradiography. Bacteriophages in the plaque corresponding to the labeled filter-bound hybrid are picked up and amplified in bacteria for further analysis. Complementary DNA libraries in bacteriophage are also constructed that contain the phage cos arms. If the cDNA is recombined with phage DNA that permits expression of the gene, such as *gt11*, then plaques can be screened immunologically with antibodies specific for the antigen of interest.

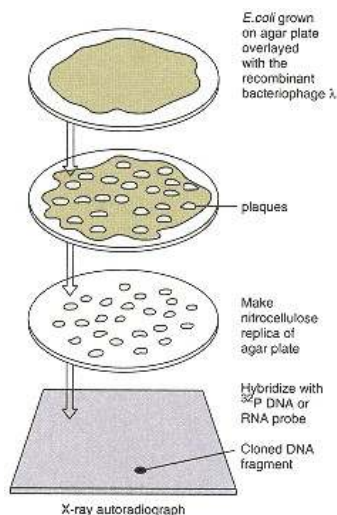

Figure 18.18

Screening genomic libraries in bacteriophage λ .

Competent *E. coli* are grown to confluence on an agar plate and then overlaid with the recombinant bacteriophage. Plaques develop where bacteria are infected and subsequently lysed by the phage. Replicas of the plate can be made by touching the plate with a nitrocellulose filter. The DNA is denatured and fixed to the nitrocellulose with NaOH. The fixed DNA is hybridized with a ^{32}P -labeled probe and exposed to X-ray film. The autoradiograph identifies the plaque(s) with recombinant DNA of interest.

Cloning DNA Fragments into Cosmid and Yeast Artificial Chromosome Vectors

Even though phage are the most commonly used vectors to construct genomic DNA libraries, the lengths of many genes exceed the maximum size of the

DNA that can be inserted between the phage arms. A **cosmid vector** can accommodate foreign DNA inserts of approximately 45 kb. **Yeast artificial chromosomes (YACs)** have been developed to clone DNA fragments of 200–500 kb lengths. While cosmid and yeast artificial chromosome vectors are difficult to work with, their libraries permit the cloning of large genes with their flanking regulatory sequences, as well as families of genes or contiguous genes.

Cosmid vectors are a cross between plasmid and bacteriophage vectors. Cosmids contain an antibiotic-resistance gene for selection of recombinant DNA molecules, an origin of replication for propagation in bacteria, and a *cos* site for packaging of recombinant molecules in bacteriophage particles. The bacteriophage with recombinant cosmid DNA can infect *E. coli* and inject its DNA into the cell. Cosmid vectors contain only approximately 5 kb of the 50-kb bacteriophage DNA and therefore cannot direct replication and assembly of new infectious phage particles. Instead, the recombinant cosmid DNA circularizes and replicates as a large plasmid. Bacterial colonies with recombinants of interest can be selected and amplified by methods similar to those described for plasmids.

Standard cloning procedures and some novel methods are employed to construct YACs. Very large foreign DNA fragments are joined to yeast DNA sequences, one that functions as a telomere (distal extremity of chromosome arm) and another that functions as a centromere and as an origin of replication. The recombinant YAC DNA is introduced into the yeast by transformation. The YAC constructs are designed so that yeast transformed with recombinant chromosomes grow as visually distinguishable colonies. This facilitates selection and analysis of cloned DNA fragments.

18.10—

Techniques to Further Analyze Long Stretches of DNA

Subcloning Permits Definition of Large Segments of DNA

Complete analysis of functional elements in a cloned DNA fragment requires sequencing of the entire molecule. Current techniques can sequence 200–400 bases in a DNA fragment, yet cloned DNA inserts are frequently much larger. Restriction maps of the initial DNA clone are essential for cleaving the DNA into smaller pieces to be recloned, or **subcloned** for further analysis. The sequences of each of the small subcloned DNA fragments can be determined. Overlapping regions of the subcloned DNA properly align and confirm the entire sequence of the original DNA clone.

Sequencing can often be accomplished without subcloning. Antisense primers can be synthesized that are complementary to the initially sequenced 3' ends of the cloned DNA. This process is repeated until the full length of the cloned DNA has been sequenced. This method obviates the need to prepare subclones but it requires synthesis/purchase of numerous primers. On the other hand, the subcloned DNA is always inserted back into the same region of the plasmid. Therefore one set of primers complementary to the plasmid DNA sequences flanking the inserted DNA can be used for all of the sequencing reactions with subcloned DNA.

Chromosome Walking Is a Technique to Define Gene Arrangement in Long Stretches of DNA

Knowledge of how genes and their regulatory elements are arranged in a chromosome should lead to an understanding of how sets of genes may be coordinately regulated. Currently, it is difficult to clone DNA fragments large enough to identify contiguous genes. The combination of several techniques allows for the analysis of very long stretches of DNA (50–100 kb). The method, **chromosome walking**, is possible because phage or cosmid libraries contain

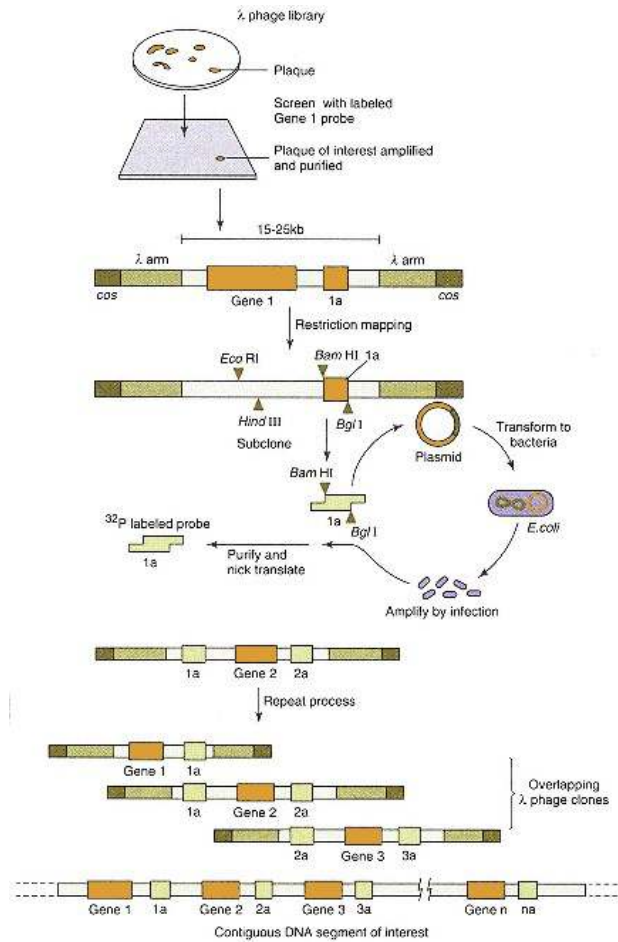

Figure 18.19

Chromosome walking to analyze contiguous DNA segments in a genome.

Initially, a DNA fragment is labeled by nick translation to screen a library for recombinant phage carrying a gene of interest. The amplified DNA is mapped with a battery of restriction endonucleases to select a new region (1a) within the original cloned DNA that can be recloned (subcloned). The subcloned DNA (1a) is used to identify other DNA fragments within the original library that would overlap the initially amplified DNA region. The process can be repeated many times to identify contiguous DNA regions upstream and downstream of the initial DNA (gene 1) of interest.

partially cleaved genomic DNA cut at specific restriction endonuclease sites. The cloned fragments will contain overlapping sequences with other cloned fragments. Overlapping regions are identified by restriction mapping, subcloning, screening phage or cosmid libraries, and sequencing procedures.

The overall procedure of chromosome walking is shown in Figure 18.19. Initially the phage library is screened for a sequence of interest with a DNA or RNA probe. The cloned DNA is restriction mapped and a small segment is subcloned in a plasmid, amplified, purified, and labeled by nick translation. This labeled probe is then used to rescreen the phage library for complementary sequences, which are then cloned. The newly identified overlapping cloned DNA is then treated in the same fashion as the initial DNA clone to search for other overlapping sequences. Caution must be taken that the subcloned DNA does not contain a sequence common to the large numbers of repeating DNA

sequences in higher eukaryotic genomes. If a subcloned DNA probe contains a repeat sequence it hybridizes to numerous bacteriophage plaques and prevents the identification of a specific overlapping clone.

18.11—

Expression Vectors and Fusion Proteins

Recombinant DNA methodology described to this point has dealt primarily with screening, amplification, and purification of cloned DNA species. An important goal of recombinant DNA studies, as stated earlier, is to have a foreign gene expressed in bacteria with the product in a biologically active form. Sequencing the DNA of many bacterial genes and their flanking regions has identified the spatial arrangement of regulatory sequences required for expression of genes. A promoter and other regulatory elements upstream of the gene are required to transcribe a gene (Chapter 19, Section 19.3). mRNA transcript of a recombinant eukaryotic gene, however, is not translated in a bacterial system because it lacks the bacterial recognition sequence, the Shine–Dalgarno sequence, required to properly orient it with a functional bacterial ribosome. Vectors that facilitate the functional transcription of DNA inserts, termed **expression vectors**, have been constructed such that a foreign gene can be inserted into the vector downstream of a regulated promoter but within a bacterial gene, commonly the *lacZ* gene. The mRNA transcript of the recombinant DNA contains the *lacZ* Shine–Dalgarno sequence, codons for a portion of the 3' end of the *lacZ* gene protein, followed by the codons of the complete foreign gene of interest. The protein product is a **fusion protein** that contains a few N-terminal amino acids of the *lacZ* gene protein and the complete amino acid sequence of the foreign gene product.

Foreign Genes Can Be Expressed in Bacteria Allowing Synthesis of Their Encoded Proteins

Many plasmid and bacteriophage vectors have been constructed to permit expression of eukaryotic genes in bacterial cells. Rapidly replicating bacteria can serve as a biological factory to produce large amounts of specific proteins, which have research, clinical, and commercial value. As an example, human protein hormones are produced by recombinant technologies, which serve as replacement or supplemental hormones in patients with aberrant or missing hormone production. Figure 18.20 depicts a generalized plasmid vector for the expression of a mammalian gene. Recall that the inserted foreign gene must be in the form of cDNA from its corresponding mRNA since the bacterial system cannot remove the introns in the pre-mRNA transcript. The DNA must be inserted in register with the codons of the 3'-terminal codons of the bacterial protein when creating a fusion protein. That is, insertion must occur after a triplet codon of the bacterial protein and at the beginning of a triplet codon of the eukaryotic gene protein to ensure proper translation. Finally, the foreign gene must be inserted in the proper orientation relative to the promoter to yield a functional transcript. This can be achieved by directional cloning.

Eukaryotic proteins synthesized within bacteria are often unstable and are degraded by intracellular proteases. Fusion protein products, however, are usually stable. The fusion protein amino acids encoded by the prokaryotic genome may be cleaved from the purified protein of interest by enzymatic or chemical procedures. An alternative cloning strategy to circumvent the intracellular instability of some proteins is to produce a foreign protein that is secreted. This requires cloning the foreign gene in a vector such that the fusion protein synthesized contains a signal peptide that can be recognized by the bacterial signal peptidase that properly processes the protein for secretion.

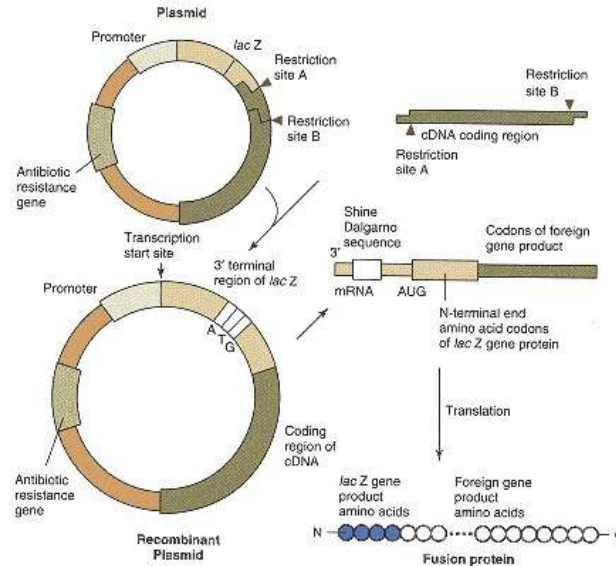

Figure 18.20

Construction of a bacterial expression vector.

A cDNA coding region of a protein of interest is inserted downstream of bacterial regulatory sequences (promoter, P) for the *lacZ* gene, the coding sequence for the mRNA Shine–Dalgarno sequence, the AUG codon, and a few codons for the N-terminal amino acids of the *lacZ* gene protein. The mRNA produced from this expression vector will therefore direct synthesis of a foreign protein in the bacterium with a few of its N-terminal amino acids of bacterial protein origin (a fusion protein).

18.12—**Expression Vectors in Eukaryotic Cells**

Mammalian genetic diseases result from missing or defective intracellular proteins. To utilize recombinant techniques to treat these diseases, vectors have to be constructed that can be incorporated into mammalian cells. In addition, these vectors have to be selective for the tissue or cells containing the aberrant protein. Numerous vectors permit the expression of foreign DNA genes in mammalian cells grown in tissue culture. These vectors have been used extensively for elucidation of the posttranslational processing and synthesis of proteins in cultured eukaryotic cells. Unfortunately, the goal to selectively express genes in specific tissues or at specific developmental stages within an animal has met with very limited success.

Several types of expression vectors have been developed that allow the replication, transcription, and translation of foreign genes in eukaryotic cells grown *in vitro*, including both RNA and DNA viral vectors that contain a foreign DNA insert. These viral vectors are able to infect and then replicate in a host cell. Experimentally constructed vectors that contain essential DNA elements, usually derived from a viral genome, permit expression of foreign gene inserts. **Shuttle vectors** contain both bacterial and eukaryotic replication signals, thus permitting replication of the vector in both bacteria and mammalian cells. A shuttle vector allows a gene to be cloned and purified in large quantities from a bacterial system and then the same recombinant vector can be expressed in a mammalian cell. Some expression vectors become integrated into the host cell genome while others remain as extrachromosomal entities (episomes) with stable expression of their recombinant gene in the daughter cells. Other expression vectors remain as episomal DNA, permitting only transient expression of their foreign gene prior to cell death.

Foreign DNA, such as viral expression vectors, may be introduced into the cultured eukaryotic cells by **transfection**, a process that is analogous to transformation of DNA into bacterial cells. The most commonly employed

transfection methods involve the formation of a complex of DNA with calcium phosphate or diethylaminoethyl (DEAE)-dextran, which is then taken up by the cell by endocytosis. The DNA is subsequently transferred from the cytoplasm to the nucleus, where it is replicated and expressed. The details of the mechanism of transfection are not known. Both methods are employed to establish transiently expressed vectors while the calcium phosphate procedure is also used for permanently expressed foreign genes. Typically, 10–20% of the cells in culture can be transfected by these procedures.

DNA Elements Required for Expression of Vectors in Mammalian Cells

Expression of recombinant genes in mammalian cells requires the presence of DNA-controlling elements within the vector that are not necessary in the bacterial system. To be expressed in a eukaryotic cell the cloned gene is inserted in the vector in the proper orientation relative to control elements, including a promoter, polyadenylation signals, and an enhancer sequence. Expression may be improved by the inclusion of an intron. Some or all of these DNA elements may be present in the recombinant gene if whole genomic DNA is used for cloning. A particular cloned fragment generated by restriction endonuclease cleavage, however, may not contain the required controlling elements. A cDNA would not possess these required DNA elements. It is therefore necessary that the expression vector to be used in mammalian cells be constructed such that it contains all of the required controlling elements.

An expression vector can be constructed by insertion of required DNA-controlling elements into the vector by recombinant technologies. Enhancer and promoter elements, engineered into an expression vector, should be recognized by a broad spectrum of cells in culture for the greatest applicability of the vector. Controlling elements derived from viruses with a broad host range are used for this purpose and are usually derived from the **papovavirus, simian virus 40 (SV40), Rous sarcoma virus**, or the **human cytomegalovirus**.

The vector must replicate so as to increase the number of copies within each cell or to maintain copies in daughter cells. The vector therefore is constructed to contain DNA sequences that promote its replication in the eukaryotic cell. This DNA region is usually derived from a virus and is referred to as the origin of replication (Ori). Specific protein factors, encoded by genes engineered into the vector or previously introduced into the host genome, recognize and interact with the ori sequences to initiate DNA replication.

Transfected Eukaryotic Cells Can Be Selected by Utilizing Mutant Cells That Require Specific Nutrients

It is important to have a means of selectively growing the transfected cells since they often represent only 10–20% of the cell population. As was the case for the bacterial plasmid, a gene can be incorporated into the vector that encodes an enzyme that confers resistance to a drug or confers selective growth capability to the cells carrying the vector. Constructing vectors that express both a selectable marker and a foreign gene is difficult. **Cotransfection** circumvents this problem. Two different vectors are efficiently taken up by those cells capable of being transfected. In most cases greater than 90% of transfected cells carry both vectors, one with the selectable marker and the second carrying the gene of interest.

Two of the more commonly employed selectable markers are the thymidine kinase (*tk*) and the dihydrofolate reductase gene. The *tk* gene product, thymidine kinase, is expressed in most mammalian cells and participates in the salvage pathway for thymidine. Several mutant cell lines have been isolated that lack a functional thymidine kinase gene (*tk⁻*) and in growth medium containing hypoxanthine, aminopterin, and thymidine these cells will not survive. Only

those *tk*⁻ mutant cells cotransfected with a vector carrying a *tk* gene, usually of herpes simplex virus origin, will grow in the medium. In most instances, these cells have been cotransfected with the gene of interest.

The dihydrofolate reductase gene (*dhfr*) is required to maintain cellular concentrations of tetrahydrofolate for nucleotide biosynthesis (see Chapter 13). Cells lacking this enzyme will only survive in media containing thymidine, glycine, and purines. Mutant cells (*dhfr*⁻), which are transfected with the *dhfr* gene, can therefore be selectively grown in a medium lacking these supplements. Expressing foreign genes in mutant cells, cotransfected with selectable markers, is limited to cell types that can be isolated with the required gene defect. Normal cells, however, transfected with a vector carrying the *dhfr* gene, are also resistant to methotrexate, an inhibitor of dihydrofolate reductase, and these cells can be selected for by growth in methotrexate.

Another approach for selecting nonmutated cells involves the use of a bacterial gene coding for aminoglycoside 3-phosphotransferase (APH) for co-transfection. Cells expressing APH are resistant to aminoglycoside antibiotics such as neomycin and kanamycin, which inhibits protein synthesis in both prokaryotes and eukaryotes. Vectors carrying an *APH* gene can therefore be used as a selectable marker in both bacterial and mammalian cells.

Foreign Genes Can Be Expressed in Eukaryotic Cells by Utilizing Virus Transformed Cells

Figure 18.21 depicts the transient expression of a transfected gene in COS cells, a commonly used system to express foreign eukaryotic genes. The COS cells are permanently cultured simian cells, transformed with an origin-defective SV40 genome. The defective viral genome has integrated into the host cell genome and constantly expresses viral proteins. Infectious viruses, which are normally lytic to infected cells, are not produced because the viral origin of replication is defective. The SV40 proteins expressed by the transformed COS cell will recognize and interact with a normal SV40 ori carried in a vector transfected into these cells. These SV40 proteins will therefore promote the repeated replication of the vector. A transfected vector containing both an SV40 ori and a gene of interest may reach a copy number in excess of 10⁵ molecules/cell. Transfected COS cells die after 3–4 days, possibly due to a toxic overload of the episomal vector DNA.

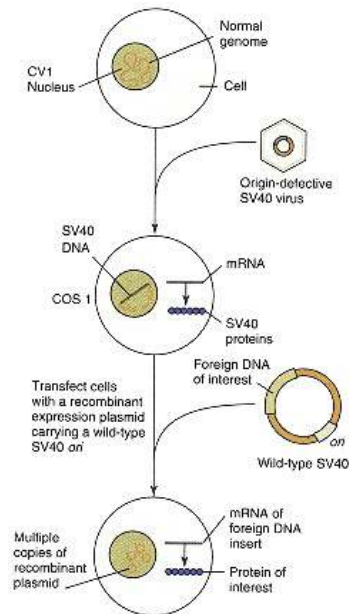

Figure 18.21
Expression of foreign genes in the eukaryotic COS cell.

CV1, an established tissue culture cell line of simian origin, can be infected and supports the lytic replication of the simian DNA virus, SV40. Cells are infected with an origin (ori)-defective mutant of SV40 whose DNA permanently integrates into the host CV1 cell genome. The defective viral DNA continuously codes for proteins that can associate with a normal SV40 ori to regulate replication. Due to its defective ori, the integrated viral DNA will not produce viruses. The SV40 proteins synthesized in the permanently altered CV1 cell line, COS-1, can, however, induce the replication of recombinant plasmids carrying a wild-type SV40 ori to a high copy number (as high as 10⁵ molecules per cell). The foreign protein synthesized in the transfected cells may be detected immunologically or enzymatically.

18.13— Site-Directed Mutagenesis

By mutating selected regions or single nucleotides within cloned DNA, it is possible to define the role of DNA sequences in gene regulation and amino acid sequences in protein function. **Site-directed mutagenesis** is the controlled alteration of selected regions of a DNA molecule. It may involve the insertion or deletion of selected DNA sequences or the replacement of a specific nucleotide with a different base. A variety of chemical methods mutate DNA *in vitro* and *in vivo* usually at random sites within the molecule.

Role of Flanking Regions in DNA Can Be Evaluated by Deletion and Insertion Mutations

Site-directed mutagenesis can be carried out in various regions of a DNA sequence including the gene itself or the flanking regions. Figure 18.22 depicts a simple deletion mutation strategy where the sequence of interest is selectively cleaved with restriction endonuclease, the specific sequence removed, and the altered recombinant vector recircularized with DNA ligase. The role of the

deleted sequence can be determined by comparing the level of expression (translation) of the gene product, measured immunologically or enzymatically, to the unaltered recombinant expression vector. A similar technique is used to insert new sequences at the site of cleavage. Deletion of a DNA sequence within the flanking region of a cloned gene can help to define its regulatory role in gene expression. The presence or absence of a regulatory sequence may not be sufficient to evaluate its role in controlling expression. The spatial arrangement of regulatory elements to one another, to the gene, and to its promoter may be important in the regulation of gene expression (see Chapter 19).

Analysis of potential regulatory sequences is conveniently conducted by inserting the sequence of interest upstream of a reporter gene in an expression vector. A **reporter gene**, usually of prokaryotic origin, encodes for a gene product that can readily be distinguished from proteins normally present in the nontransfected cell and for which there is a convenient and rapid assay. A commonly used reporter gene is the chloramphenicol acetyltransferase (*CAT*) gene of bacteria. The gene product catalyzes the acetylation and inactivation of chloramphenicol, a protein synthesis inhibitor of prokaryotic cells. The ability of a regulatory element to enhance or suppress expression of the *CAT* gene can be determined by assaying the level of acetylation of chloramphenicol in extracts prepared from transfected cells. The regulatory element can be mutated prior to insertion into the vector carrying the reporter gene to determine its spatial and sequence requirements as a regulator of gene expression.

A difficulty encountered in analysis of regulatory elements is the lack of restriction endonuclease sites at useful positions within the cloned DNA. **Deletion mutations** can be made, in the absence of appropriately positioned restriction endonuclease sites, by linearizing cloned DNA with a restriction endonuclease downstream of the potential regulatory sequence of interest. The DNA can then be systematically truncated with an exonuclease, which hydrolyzes nucleotides from the free end of both strands of the linearized DNA. Increasing times of digestion generates smaller DNA fragments. Figure 18.23 demonstrates how larger deletion mutations (yielding smaller fragments) can be tested for functional activity. The enzymatic hydrolysis of the double strand of DNA occurs at both ends of the linearized recombinant vector, destroying the original restriction endonuclease site (RE₁). A unique restriction endonuclease site is reestablished to recircularize the truncated DNA molecule for further manipulations to evaluate the function of the deleted sequence. This is accomplished by ligating the blunt ends with a linker DNA, a synthetic oligonucleotide containing one or more restriction endonuclease sites. The ligated linkers are cut with the appropriate enzyme permitting recircularization and ligation of the DNA.

Site-Directed Mutagenesis of a Single Nucleotide

The previously discussed procedures can elucidate the functional role of small to large DNA sequences. Frequently, however, one wants to evaluate the role of a single nucleotide at selected sites within the DNA molecule. A single base change permits evaluation of the role of specific amino acids in a protein (see Clin. Corr. 18.6). This method also allows one to create or destroy a restriction endonuclease site at specific locations within a DNA sequence. The site-directed mutagenesis of a specific nucleotide is a multistep process that begins with cloning the normal type gene in a bacteriophage (Figure 18.24). The M13 series of recombinant bacteriophage vectors are commonly employed for these studies. M13 is a filamentous bacteriophage that specifically infects male *E. coli* that express sex pili encoded for by a plasmid (F factor). M13 bacteriophage contains DNA in a single-stranded or replicative form, which is replicated to double-stranded DNA within an infected cell. The double-stranded form of the

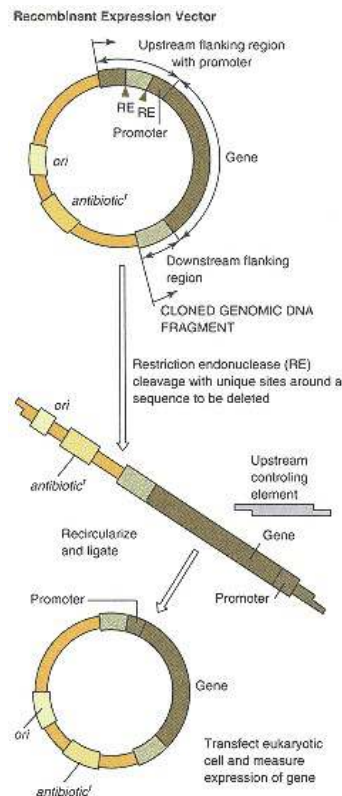

Figure 18.22
Use of expression vectors to study DNA regulatory sequences.

The gene of interest along with upstream and/or downstream DNA flanking regions is inserted and cloned in an expression vector and the baseline expression of the gene in an appropriate cell is determined. Defined regions of potential regulatory sequences can be removed by restriction endonuclease cleavage and the truncated recombinant DNA vector can be recircularized, ligated, and transfected into an appropriate host cell. The level of gene expression in the absence of the potential regulator is determined and compared to controls to ascertain the regulatory role of the deleted flanking DNA sequence.

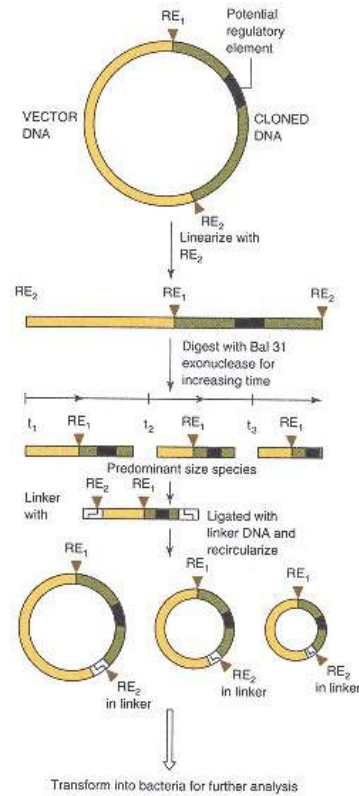

Figure 18.23

Enzymatic modification of potential DNA regulatory sequences.

A purified recombinant DNA molecule with a suspected gene regulatory element within flanking DNA regions is cleaved with a restriction endonuclease (RE_2). The linearized recombinant DNA is digested for varying time periods with the exonuclease, Bal31, reducing the size of the DNA flanking the potential regulatory element. The resulting recombinant DNA molecules of varying reduced sizes have small DNA oligomers (linkers) containing a restriction endonuclease sequence for RE_2 ligated to their ends. The linker-modified DNA is hydrolyzed with RE_2 , creating complementary single-stranded sticky ends that permit recircularization of recombinant vectors. The potential regulatory element, bounded by various reduced-sized flanking DNA sequences, can be amplified, purified, sequenced, and inserted upstream of a competent gene in an expression vector. Modification of expression of the gene in an appropriate transfected cell can then be monitored to evaluate the role of the potential regulatory element placed at varying distances from the gene.

DNA is isolated from infected cells and used for cloning the gene to be mutated. The plaques of interest can be visually identified by α -complementation (see p. 772).

The M13 carrying the cloned gene of interest is used to infect susceptible *E. coli*. The progeny bacteriophages are released into the growth medium and contain single-stranded DNA. An oligonucleotide (18–30 nucleotides long) is synthesized that is complementary to a region of interest except for the nucleotide to be mutated. This oligomer, with one mismatched base, will hybridize to the single-stranded gene cloned in the M13 DNA and serves as a primer. Primer extension is accomplished with the bacteriophage T4 DNA polymerase and the resulting double-stranded DNA can be transformed into susceptible *E. coli*, where the mutated DNA strand serves as a template to replicate new (+) strands now carrying the mutated nucleotide.

The bacteriophage plaques, containing the mutated DNA, are screened by hybridizing with a labeled probe of the original oligonucleotide. By adjusting the wash temperature of the hybridized probe only the perfectly matched hybrid will remain complexed while the wild-type DNA–oligomer with mismatched nucleotide will dissociate. The M13 carrying the mutated gene is then replicated in bacteria, the DNA purified, and the mutated region of the gene sequenced.

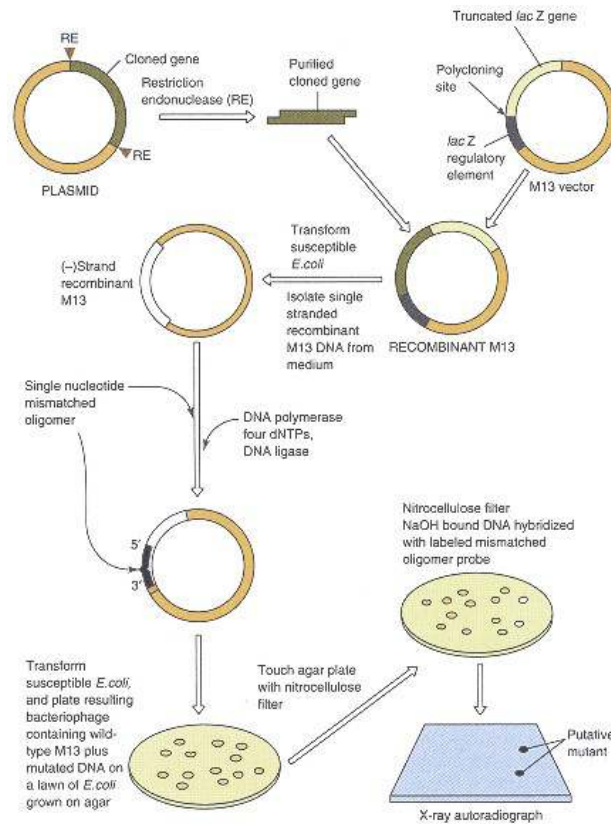

Figure 18.24

Site-directed mutagenesis of a single nucleotide and detection of the mutated DNA.

The figure is a simplified overview of the method. This process involves the insertion of an amplified pure DNA fragment into a modified bacteriophage vector, M13. Susceptible *E. coli*, transformed with the recombinant M13 DNA, synthesize the (+) strand DNA packaged within the virion bacteriophage proteins. The bacteriophages are isolated from the growth medium and the single-stranded recombinant M13 DNA is purified. The recombinant M13 DNA serves as a template for DNA replication in the presence of DNA polymerase, deoxynucleoside triphosphates (dNTPs), DNA ligase, and a special primer. The DNA primer (mismatched oligomer) is synthesized to be exactly complementary to a region of the DNA (gene) of interest except for the one base intended to be altered (mutated). The newly synthesized M13 DNA therefore contains a specifically mutated base, which when reintroduced into susceptible *E. coli* will be faithfully replicated. The transformed *E. coli* are grown on agar plates with replicas of the resulting colonies picked up on a nitrocellulose filter. DNA associated with each colony is denatured and fixed to the filter with NaOH and the filter-bound DNA is hybridized with a ^{32}P -labeled mismatched DNA oligomer probe. The putative mutants are then identified by exposing the filter to X-ray film.

CLINICAL CORRELATION 18.6

Site-Directed Mutagenesis of HSV I gD

The structural and functional roles of a carbohydrate moiety covalently linked to a protein can be studied by site-directed mutagenesis. The gene that codes for a glycoprotein whose asparagine residue(s) is normally glycosylated (N-linked) must first be cloned. The herpes simplex virus type I (HSV I) glycoprotein D (gD) may contain as many as three N-linked carbohydrate groups. The envelope bound HSV I gD appears to play a central role in virus absorption and penetration. Carbohydrate groups may play a role in these processes.

The cloned *HSV I gD* gene has been modified by site-directed mutagenesis to alter codons for the asparagine residue at the three potential glycosylation sites. These mutated genes, cloned within an expression vector, were transfected into eukaryotic cells (COS-1), where the gD protein was transiently expressed. The mutated HSV I gD, lacking one or all of its normal carbohydrate groups, can be analyzed with a variety of available monoclonal anti-gD antibodies to determine if immunological epitopes (specific sites on a protein recognized by an antibody) have been altered. Altered epitopes would indicate that the missing carbohydrate moiety is directly associated with the normal recognition site or played a role in the protein's native conformation. An altered protein conformation can impact on immunogenicity (e.g., for vaccines) and protein processing (movement of the protein from the endoplasmic reticulum, where it is synthesized, to the membrane, where it is normally bound). Mutations at two of the glycosylation sites altered the native conformation of the protein such that it was less reactive with selected monoclonal antibodies. Alteration at a third site had no apparent effect on protein structure, and loss of the carbohydrate chain at all three sites did not prevent normal processing of the protein.

Sodora, D. L., Cohen, G. H., and Eisenberg, R. J. Influence of asparagine-linked oligosaccharides on antigenicity, processing, and cell surface expression of herpes simplex virus type I glycoprotein D. *J. Virol.* 63:5184, 1989.

to confirm the identity of the mutation. Many modifications have been developed to improve the efficiency of site-directed mutagenesis of a single nucleotide including a method to selectively replicate the mutated strand. M13 bacteriophage, replicated in a mutant *E. coli*, incorporates some uracil residues into its DNA in place of thymine due to a metabolic defect in the synthesis of dTTP from dUTP and the lack of an enzyme that normally removes uracil residues from DNA. The purified single-stranded M13 uracil-containing DNA is hybridized with a complementary oligomer containing a mismatched base at the nucleotide to be mutated. The oligomer serves as the primer for DNA replication *in vitro* with the template (+) strand containing uracils and the new (–) strand containing thymines. When this double-stranded M13 DNA is transformed into a wild-type *E. coli*, the uracil-containing strand is destroyed and the mutated (–) strand serves as the template for the progeny bacteriophages, most of which will carry the mutation of interest.

The polymerase chain reaction can also be employed for site-directed mutagenesis. Strategies have readily been developed to incorporate a mismatched base into one of the oligonucleotides that primes the PCR. Some of these procedures employ M13 bacteriophage and follow the principles described in Figure 18.24. A variation of these PCR methods, **inverse PCR mutagenesis**, has been applied to small recombinant plasmids (4–5 kb) (Figure 18.25). The method is very rapid with 50–100% of the generated colonies containing the mutant sequence. The two primers are synthesized so that they anneal back-to-back with one primer carrying the mismatched base.

18.14—

Applications of Recombinant DNA Technologies

The practical uses of recombinant DNA methods in biological systems are limited only by one's imagination. Recombinant DNA methods are applicable to numerous biological disciplines including agriculture, studies of evolution, forensic biology, and clinical medicine. Genetic engineering can introduce new or altered proteins into crops (e.g., corn), so that they contain amino acids essential to humans but often lacking in plant proteins. Toxins that are lethal to specific insects but harmless to humans can be introduced into crops to protect plants without the use of environmentally destructive pesticides. The DNA isolated from cells in the amniotic fluid of a pregnant woman can be analyzed for the presence or absence of genetic defects in the fetus. Minuscule quantities of DNA can be isolated from biological samples that have been preserved in ancient tar pits or frozen tundra and can be amplified and sequenced for evolutionary studies at the molecular level. The DNA from a single hair, a drop of blood, or sperm from a rape victim can be isolated, amplified, and mapped to aid in identifying felons. Current technologies in conjunction with future invented methods should permit the selective introduction of genes into cells with defective or absent genes. Developing methodologies are also likely to become available to introduce nucleic acid sequences into cells to selectively turn off the expression of detrimental genes.

Antisense Nucleic Acids Hold Promise As Research Tools and in therapy

Recently, a new tool, **antisense nucleic acids**, has been introduced to study the intracellular expression and function of specific proteins. Natural and synthetic antisense nucleic acids that are complementary to mRNAs will hybridize within the cell, inactivate the mRNA, and block translation. The introduction of antisense nucleic acids into cells has opened new avenues to explore how proteins, whose expression has been selectively repressed in a cell, function within that cell. This method also holds great promise in control of diseased processes

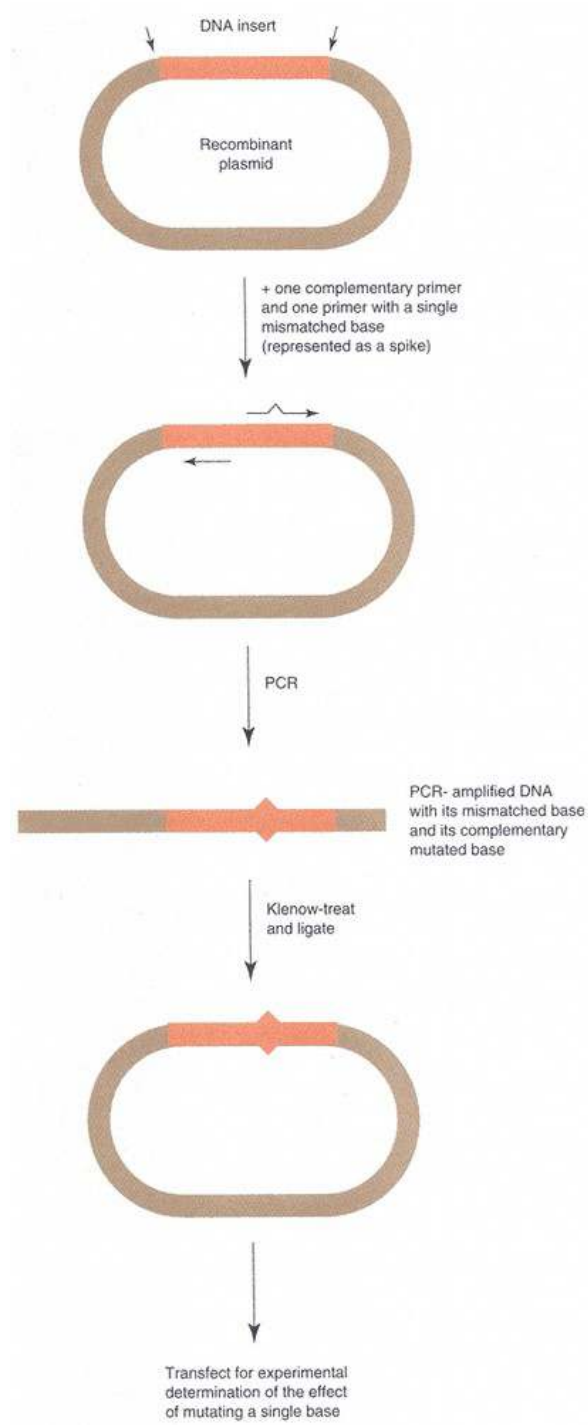

Figure 18.25
Inverse PCR mutagenesis.

A single base can be mutated in recombinant DNA plasmids by inverse PCR. Two primers are synthesized with their antiparallel 5' ends complementary to adjacent bases on the two strands of DNA. One of the two primers carries a specific mismatched base that is faithfully copied during the PCR amplification steps, yielding ultimately a recombinant plasmid with a single mutated base.

such as viral infections. Antisense technology, along with site-directed mutagenesis, are part of a new approach termed **reverse genetics**. Reverse genetics (from gene to phenotype) selectively modifies a gene to evaluate its function, as opposed to classical genetics, which depends on the isolation and analysis of cells carrying random mutations that can be identified. A second use of the term reverse genetics refers to the mapping and ultimate cloning of a human gene associated with a disease where no prior knowledge of the molecular agents causing the disease exists. The use of the term "reverse genetics" in this latter case is likely to be modified.

Antisense RNA can be introduced into a cell by common cloning techniques. Figure 18.26 demonstrates one method. A gene of interest is cloned in an expression vector in the wrong orientation. That is, the sense or coding strand that is normally inserted into the expression vector downstream of a promoter is intentionally inserted in the opposite direction. This now places the complementary or antisense strand of the DNA under the control of the promoter with expression or transcription yielding antisense RNA. Transfection of cells with the antisense expression vector introduces antisense RNA that is capable of hybridizing with normal cellular mRNA. The mRNA–antisense RNA complex is not translated due to a number of reasons, such as its inability to bind to ribosomes, blockage of normal processing, and rapid enzymatic degradation.

DNA oligonucleotides have also been synthesized that are complementary to the known sequences of mRNAs of selected genes. Introduction of specific DNA oligomers to cells in culture have inhibited viral infections including infections by the human immunodeficiency virus (HIV). It is conceivable that one day bone marrow cells will be removed from AIDS patients and antisense HIV nucleic acids will be introduced into their cells in culture. These "protected" cells can then be reintroduced into the AIDS patient's bone marrow (autologous bone marrow transplantation) and replace those cells normally destroyed by

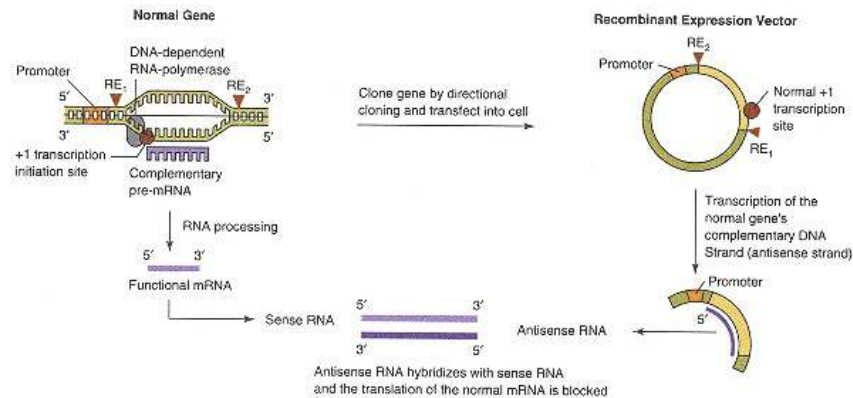

Figure 18.26

Production of antisense RNA.

A gene, or a portion of it, is inserted into a vector by directional cloning downstream of a promoter and in the reversed orientation to that normally found in the cell of origin. Transfection of this recombinant DNA into the parental cell carrying the normal gene results in the transcription of RNA (antisense RNA) from the cloned reversed-polarity DNA along with a normal cellular mRNA (sense RNA) transcript. The two anti-parallel complementary RNAs hybridize within the cell, resulting in blocked expression (translation) of the normal mRNA transcript.

the virus. Experimental progress is also being made with antisense nucleic acids that can regulate the expression of oncogenes, genes involved in the cancer-forming process. Harnessing antisense technologies holds great promise for treatment of human diseases.

Normal Genes Can Be Introduced into Cells with a Defective Gene in Gene Therapy

It is sometimes desirable for the transfected recombinant DNA to replicate to high copy numbers independent of the cell cycle. In other situations it is preferable for only one or few copies to integrate into the host genome with its replication regulated by the cell cycle. Individuals who possess a defective gene resulting in a debilitating or fatal condition could theoretically be treated by supplying their cells with a normal gene. **Gene therapy** is in its infancy; however, the successful transfer of a normal gene to humans has been accomplished employing retroviral vectors (see Clin. Corr 18.7). The success of gene transfer depends, in part, on integration of the gene into the host genome. This is directed by the retroviral integration system. Integration, however, is normally a random event that could result in deleterious sequelae. Exciting studies are in progress that indicate that the viral integration machinery can be selectively tethered to specific target sequences within the host DNA by protein-protein interactions to obviate these potential problems.

CLINICAL CORRELATION 18.7

Normal Genes Can Be Introduced into Cells with Defective Genes in Gene Therapy

More than 4000 different genetic diseases are known, many of which are debilitating or fatal. Most are currently incurable. With the advent of new technologies in molecular biology, the clinical application of gene transfer and gene therapy is becoming a reality. Adenosine deaminase (ADA) deficiency and Gaucher's disease are but two of many genetic diseases that may readily be cured by gene therapy.

ADA is important in purine salvage, catalyzing the conversion of adenosine to inosine or deoxyadenosine to deoxyinosine. It is a protein of 363 amino acids with highest activity in thymus and other lymphoid tissues. A defect in the *ADA* gene is inherited as an autosomal recessive disorder. Over 30 mutations are associated with the disease. ADA deficiency causes a severe combined immunodeficiency disease (SCID), by an unknown mechanism. These immune-compromised children usually die in the first few years of life due to overwhelming infections. The first authorized gene therapy in humans began on September 14, 1990 with the treatment of a four-year-old girl with ADA deficiency. The patient's peripheral blood T cells were expanded in tissue culture with appropriate growth factors. The *ADA* gene was introduced within these cells by retroviral mediated gene transfer. A modified retrovirus was constructed to contain the human *ADA* gene such that it would be expressed in human cells without virus replication. (These viruses that cannot replicate are first propagated in a cell line that contains a helper virus to produce "infectious" viruses. The "infectious" viruses with foreign genetic information can now infect and transfer information to cells without helper virus functions and, therefore, cannot replicate.) Transfer of the *ADA* gene to the patient's T cells was mediated by retroviral infection. Modified T cells carrying a normal *ADA* gene were then reintroduced to the patient by autologous transfusion. Levels of ADA as low as 10% of normal are sufficient to normalize the patient.

Gaucher's disease is an autosomal recessive lysosomal storage disorder caused by a deficiency of lysosomal glucocerebrosidase (GC). Clinical problems include hepatosplenomegaly, pancytopenia, and bone deterioration. The enzyme is a lysosomal membrane glycoprotein that contains 497 amino acids. Over 36 mutations, mostly missense, that decrease catalytic activity are associated with the disease. The disorder can be treated with enzyme replacement; however, this is very expensive and the patient must be subjected to intravenous therapy throughout life. Viral constructs, similar to the ADA protocol, have been made that carry the *GC* gene and have been successfully transduced into a Gaucher patient's hematopoietic cells in culture with very high efficiencies. These studies indicate that Gaucher patients may be normalized by gene therapy in the near future. The genetically altered cells would become endogenous factories capable of continuously synthesizing *GC*, thus obviating the need for intravenous delivery of the missing enzyme.

Blaese, R.M. Progress toward gene therapy. *Clin. Immunol. Immunopathol* 61:574, 1991; Mitani, K., Wakamiya, M., and Caskey, C. T. Long-term expression of retroviral-transduced adenosine deaminase in human primitive hematopoietic progenitors. *Hum. Gene Ther.* 4:9, 1993; and Xu, L., Stahl, S. K., Dave, H. P., Schiffman, R., Correll, P. H., Kessler, S., and Karlsson, S. Correction of the enzyme deficiency in hematopoietic cells of Gaucher patients using a clinically acceptable retroviral supernatant transduction protocol. *Exp. Hematol.* 22:223, 1994.

Transgenic Animals

Recombinant DNA methods allow production of large amounts of foreign gene products in bacteria and cultured cells. These methods also facilitate evaluation of the role of a specific gene product in cell structure or function. In order to investigate the role of a selected gene product in the growth and development of a whole animal, the gene must be introduced into the fertilized egg. Foreign genes can be inserted into the genome of a fertilized egg. Animals that develop from a fertilized egg with a foreign gene insert carry that gene in every cell and are referred to as **transgenic animals**.

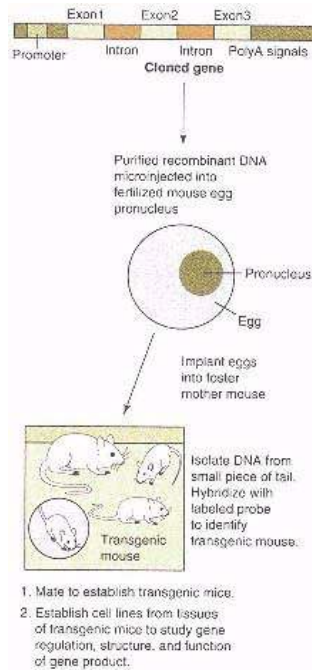

Figure 18.27

Production of transgenic animals.

Cloned, amplified, and purified functional genes are microinjected into several fertilized mouse egg pronuclei *in vitro*. The eggs are implanted into a foster mother. DNA is isolated from a small piece of each offspring pup's tail and hybridized with a labeled probe to identify animals carrying the foreign gene (transgenic mouse). The transgenic mice can be mated to establish a new strain of mice. Cell lines can also be established from tissues of transgenic mice to study gene regulation and the structure/function of the foreign gene product.

The most commonly employed method to create transgenic animals is outlined in Figure 18.27. The gene of interest is usually a cloned recombinant DNA molecule that includes its own promoter or is cloned in a construct with a different promoter that can be selectively regulated. Multiple copies of the foreign gene are microinjected into the pronucleus of the fertilized egg. The foreign DNA inserts randomly within the chromosomal DNA. If the insert disrupts a critical cellular gene the embryo will die. Usually, nonlethal mutagenic events result from the insertion of the foreign DNA into the chromosome.

Transgenic animals are currently being used to study several different aspects of the foreign gene, including the analysis of DNA regulatory elements, expression of proteins during differentiation, tissue specificity, and the potential role of oncogene products on growth, differentiation, and induction of tumorigenesis. Eventually, it is expected that these and related technologies will allow for methods to replace defective genes in the developing embryo (see Clin. Corr. 18.8).

Recombinant DNA in Agriculture Will Have Significant Commercial Impact

Perhaps the greatest gain to all humanity would be the practical use of recombinant technologies to improve our agricultural crops. Genes must be identified and isolated that code for properties that include higher crop yield, rapid plant growth, resistance to adverse conditions such as arid conditions or cold periods, and plant size. New genes, not common to plants, may be engineered into plants that confer resistance to insects, fungi, or bacteria. Finally, genes encoding existing structural proteins can be modified to contain essential amino acids not normally present in the plant, without modifying the protein function. The potential to produce plants with new genetic properties depends on the ability to introduce genes into plant cells that can differentiate into whole plants.

New genetic information carried in **crown gall plasmids** can be introduced into plants infected with soil bacteria known as agrobacteria. Agrobacteria naturally contain a crown gall or Ti (tumor-inducing) plasmid whose genes integrate into an infected cell's chromosome. The plasmid genes direct the host plant cell to produce new amino acid species that are required for bacterial growth. A crown gall, or tumor mass of undifferentiated plant cells, develops at the site of bacterial infection. New genes can be engineered into the Ti plasmid, and the recombinant plasmid introduced into plant cells upon infection with the agrobacteria. Transformed plant cells can then be grown in culture and under proper conditions can be induced to redifferentiate into whole plants. Every cell would contain the new genetic information and would represent a transgenic plant.

Some limitations in producing plants with improved genetic properties must be overcome before significant advances in our world food supply can be realized. Clearly, proper genes must yet be identified and isolated for desired characteristics. Also, important crops such as corn and wheat cannot be transformed by Ti plasmids; therefore other vectors must be identified. However, significant success has been achieved in recent years in designing crop plants

CLINICAL CORRELATION 18.8**Transgenic Animal Models**

Transgenic animal model systems hold promise for future methodologies to correct genetic diseases early in fetal development. These animals are used to study the regulation of expression and function of specific gene products in a whole animal and have the potential for creating new breeds of commercially valuable animals. Transgenic mice have been developed from fertilized mouse eggs with rat growth hormone (*GH*) genes microinjected into their male pronuclei (see p. 835). The rat *GH* gene DNA, fused to the mouse metallothionein-I (MT-I) promoter region, was purified from the plasmid in which it had been cloned. Approximately 600 copies of the promoter-gene complex were introduced into each egg, which was then inserted into the reproductive tract of a foster mother mouse. The resulting transgenic mouse was shown to carry the rat *GH* gene within its genome by hybridizing a labeled DNA probe to mouse DNA that had been purified from a slice of the tail, restriction endonuclease digested, electrophoresed, and Southern blotted. The diet of the animals was supplemented with ZnSO₄ at 33 days postparturition. The ZnSO₄ presumably can activate the mouse MT-I promoter to initiate transcription of the rat *GH* gene. The continuous overexpression of rat GH in some transgenic animals produced mice nearly twice the size of littermates that did not carry the rat *GH* gene. A transgenic mouse transmitted the rat *GH* gene to one-half of its offspring, indicating that the gene stably integrated into the germ cell genome and that new breeds of animals can be created.

Palmiter, R. D., Brinster, R. L., Hammer, R. E., et al. Dramatic growth of mice that develop from eggs microinjected with metallothionein-growth hormone fusion genes. *Nature* 300:611, 1982.

with resistance to insects and viruses. Of equal importance is the very recent genetic engineering feat of inserting a foreign gene into pea plants that now produce a protein that inhibits the feeding of weevil larvae on the pea seeds. Peas and other legume seeds will be able to be stored without the need of protective chemical fumigants (currently Brazilian farmers lose 20–40% of their stored beans to pests).

18.15—**Concluding Remarks**

The old cliché, so close and yet so far away, seems appropriate for our current juncture in molecular biology. The eukaryotic yeast genome, which consists of approximately 14 million base pairs of DNA distributed among 16 chromosomes, will be entirely sequenced by the mid-1990s. Equally impressive is the fact that the entire human genome will likely be sequenced in the next decade or so (see Clin. Corr. 15.11). Two human chromosomes, 16 and 19, have been fully mapped and it is anticipated they will be the first chromosomes to be fully sequenced. More than 100,000 cDNA clones are available for sequencing, which ultimately will provide landmarks of the huge human genetic map. More than 100 clinical trials in gene therapy have been initiated since the apparent success with ADA. Genetic diseases now identified and to be identified should eventually be curable by gene replacement therapy when the technical roadblocks are surmounted. If one looks at the enormous advances made in molecular biology in just the past two decades it is reasonable to believe the "when" will not be that far off.

Bibliography

- Askari, F. K., and McDonnell, W. M. Molecular medicine: Antisense oligonucleotide therapy. *N. Engl. J. Med.* 334:316, 1996.
- Brown, W. M., George, M. Jr., and Wilson, A. C. Rapid evolution of animal mitochondrial DNA. *Proc. Natl. Acad. Sci. USA* 76:1967, 1979.
- Bushman, F. Targeting retroviral integration. *Science* 267:1443, 1995.
- Davis, L. G., Kuehl, W. M., and Battey, J. F. *Basic Methods in Molecular Biology*, 2nd ed. Norwalk, CT: Appleton & Lange, 1994.
- Erlich, H. A. (Ed.). *PCR Technology. Principles and Applications for DNA Amplification*. New York: Stockton Press, 1989.
- Feinberg, A., and Vogelstein, B. Addendum: A technique for radiolabeling DNA restriction endonuclease fragments to high specific activity. *Anal Biochem.* 137:266, 1984.
- Jaenisch, R. Transgenic animals. *Science* 240:1468, 1988.
- Kreeger, K. Y. Influential consortium's cDNA clones praised as genome research time-saver. *The Scientist* 9:1, 1995.
- Kunkel, T. A. Rapid and efficient site-specific mutagenesis without phenotypic selection. *Proc. Natl. Acad. Sci. USA* 82:488, 1985.
- Marshall, E. Gene therapy's growing pains. *Science* 269:1050, 1995.

Maxam, A. M., and Gilbert, W. A new method of sequencing DNA. *Proc. Natl. Acad. Sci. USA* 74:560, 1977.

McPherson, M. J., Quirke, P., and Taylor, G. R. (Eds.). *PCR. A Practical Approach*, Vol. 1. Oxford, England: Oxford University Press, 1994.

Mulligan, R. C. The basic science of gene therapy. *Science* 260:926, 1993.

Palmiter, R. D., Brinster, R. L., Hammer, R. E., et al. Dramatic growth of mice that develop from eggs microinjected with metallothionein–growth hormone fusion genes. *Nature* 300:611, 1982.

Rigby, P. W. J., Dieckmann, M., Rhodes, C., and Berg, P. Labelled deoxyribonucleic acid to high specific activity in vitro by nick translation with DNA polymerase I. *J. Mol. Biol.* 113:237, 1977.

Sambrook, J., Fritsch, E. F., and Maniatis, T. *Molecular Cloning. A Laboratory Manual*, 2nd ed. New York: Cold Spring Harbor Laboratory Press, 1989.

Sanger, F., Nicklen, S., and Coulson, A. R. DNA sequencing with chain-terminating inhibitors. *Proc. Natl. Acad. Sci. USA* 74:5463, 1977.

Southern, E. M. Detection of specific sequences among DNA fragments separated by gel electrophoresis. *J. Mol. Biol.* 98:503, 1975.

Vogelstein, B., Fearon, E. R., Hamilton, S. R., and Feinberg, A. P. Use of restriction fragment length polymorphism to determine the clonal origin of human tumors. *Science* 227:642, 1985.

Watson, J. D., Tooze, J., and Kurtz, D. T. *Recombinant DNA: A Short Course* San Francisco: Scientific American Books/Freeman, 1983.

Weintraub, H. M. Antisense RNA and DNA. *Sci. Am.* 262:40, 1990.

Williams, N. Closing in on the complete yeast genome sequence. *Science* 268:1560, 1995.

Zhang, Y., and Yunis, J. J. Improved blood RNA extraction micro-technique for RT-PCR. *Biotechniques* 18:788, 1995.

Questions

J. Baggott and C. N. Angstadt

1. Development of recombinant DNA methodologies is based on discovery of:

- A. the polymerase chain reaction (PCR).
- B. restriction endonucleases.
- C. plasmids.
- D. complementary DNA (cDNA).
- E. yeast artificial chromosomes (YACs).

2. The essential property of the DNA polymerase employed in the polymerase chain reaction (PCR) is that it:

- A. does not require a primer.
- B. is unusually active.
- C. is thermostable.
- D. replicates double-stranded DNA.
- E. can replicate both eukaryotic and prokaryotic DNA.

3. Construction of a restriction map of DNA requires all of the following EXCEPT:

- A. partial hydrolysis of DNA.
- B. complete hydrolysis of DNA.
- C. electrophoretic separation of fragments on a gel.
- D. staining of an electrophoretic gel to locate DNA.
- E. cyclic heating and cooling of the reaction mixture.

4. In the Maxam–Gilbert method of DNA sequencing:

- A. cleavage of the DNA backbone occurs randomly at only some of the sites where the base had been destroyed.
- B. all nucleotides produced during cleavage of the DNA backbone are detected by radioautography.
- C. electrophoretic separation of DNA fragments is due to differences in both size and charge.
- D. the sequence of bands in the four lanes of the autoradiogram contains the base sequence information.
- E. dideoxynucleoside triphosphates are used.

5. The Sanger and Maxam–Gilbert methods of DNA sequencing differ in that:

- A. the Maxam–Gilbert method involves labeling the 5' end, while the Sanger method requires labeling the 3' end of the DNA.
- B. only the Maxam–Gilbert method involves electrophoresing a mixture of fragments of different sizes.
- C. the Sanger method employs DNA cleavage, while the Maxam–Gilbert method employs interrupted DNA synthesis.
- D. only the Maxam–Gilbert method uses radioautography to detect fragments in which one of the termini is radioactively labeled.
- E. in the Maxam–Gilbert method, a complete DNA chain is cleaved, while in the Sanger method, synthesis of the chain is interrupted at different points.

6. Preparation of recombinant DNA requires:

- A. restriction endonucleases that cut in a staggered fashion.
- B. restriction endonucleases that cleave to yield blunt-ended fragments.
- C. poly (dT).
- D. DNA ligase.
- E. cDNA.

7. In the selection of colonies of bacteria that carry cloned DNA in plasmids, such as pBR322, that contain two antibiotic resistance genes:

- A. one antibiotic resistance gene is nonfunctional in the desired bacterial colonies.
- B. untransformed bacteria are antibiotic resistant.
- C. both antibiotic resistance genes are functional in the desired bacterial colonies.
- D. radiolabeled DNA or RNA probes play a role.
- E. none of the above.

8. A technique for defining gene arrangement in very long stretches of DNA (50–100 kb) is:

- A. RFLP.
- B. chromosome walking.
- C. nick translation.
- D. Southern blotting.
- E. SSCP.

9. Which of the following pairs of vectors and DNA insert sizes is correct?

- A. plasmids 5–10 kb
- B. cosmids 15 kb
- C. YACs 2000–5000 kb
- D. bacteriophage 45 kb
- E. none of the above

10. Expression of a eukaryotic gene in prokaryotes involves which of the following:

- A. a SD sequence in mRNA.
- B. absence of introns.
- C. regulatory elements upstream of the gene.
- D. a fusion protein.
- E. all of the above.

Refer to the following for Questions 11–15.

- A. antisense nucleic acid
- B. polymerase chain reaction
- C. site-directed mutagenesis
- D. shuttle vector
- E. transfecton

- 11. Contains both bacterial and eukaryotic replication signals.
- 12. Complementary to mRNA and will hybridize to it, thus blocking translation.
- 13. Can rapidly produce large quantities of a specific DNA.
- 14. Oligomer with one mismatched base is used as a primer.
- 15. A process that introduces foreign DNA into a eukaryotic genome.

Answers

- 1. B The ability to cleave DNA predictably at specific sites is essential to recombinant DNA technology (p. 760).
- 2. C PCR requires cycling between low temperatures, where hybridization of template DNA and oligomer primers occurs, and high temperatures, where DNA melts (p. 759). The Taq DNA polymerase, isolated from a thermophilic organism discovered in a hot spring on federal land, is stable at high temperatures and makes the cycling possible with no addition of fresh polymerase after each cycle. The lucrative commercialization of this publicly owned natural resource, with no royalties accruing to the public (i.e., taxpayers') coffers, has evoked criticism from some observers.
- 3. E Cyclic heating and cooling are part of the PCR process, not of restriction mapping (p. 761). A and B: Restriction mapping involves all degrees of hydrolysis. Partial hydrolysis gives fragments of varying sizes, and complete hydrolysis gives the smallest possible fragments. C and D: Fragments are electrophoretically separated by size on agarose gel, which is stained to reveal the DNA.
- 4. D The relative positions of G are given by the bands in the lane corresponding to the destruction of G; of A by the bands in the AG lane that are not duplicated in the G lane; of C by the bands in the C lane; of T by the bands in the CT lane that are not duplicated in the C lane. A: Cleavage occurs at all such sites. Limited destruction of the bases is random (p. 762). B: Only the nucleotides that contain the labeled 5' terminal are detected. Other nucleotides are produced but are not detected by the method and do not contribute information to the analysis (p. 762). C: Although charge is, of course, required to produce movement of a particle in a field, the separation of these fragments is not due to charge differences, but to size differences, with the smallest fragments migrating farthest (pp. 762–763). E: This is part of the Sanger method (p. 763).
- 5. D They both use radioautography to detect fragments in which one of the termini is radioactively labeled. A: The Sanger method involves a labeled 5' end. With the Maxam–Gilbert method either end could be labeled. Here we show labeling of the 3' end. B: Both methods do this. C: This statement reverses the methodologies. E: See pp. 762–765.
- 6. D DNA ligase covalently connects fragments held together by interaction of cohesive ends (p. 765). A: This is the most desirable type of restriction endonuclease to use, but it is not essential. B: Restriction nucleases that make blunt cuts can also be used if necessary. C: This is used in conjunction with poly (dA) if restriction endonucleases that make blunt cuts are employed, but it is not essential to all of recombinant DNA preparation.
- 7. A The foreign DNA is inserted into one antibiotic resistance gene, thus destroying it (p. 770). B: Resistance is due to the plasmids. C: See the comment for A above. D: Radiolabeling detects the DNA of interest, not the colonies that contain cloned DNA (p. 770).
- 8. B A: Restriction fragment length polymorphism (RFLP) is a characteristic of DNA, not a technique (p. 775). C: Nick translation is used to label DNA during chromosome walking (p. 773). D: Southern blotting is a method for analyzing DNA (p. 774). E: Single-strand conformation polymorphism (SSCP) is a method for detecting base changes in DNA that do not alter restriction endonuclease sites.
- 9. A B: Cosmids will accept a 45-kb insert (p. 781). C: YACs will accept a 200–500 kb insert (p. 781). D: Bacteriophage λ will accept a 15-kb insert (p. 779).
- 10. E A: The SD sequence is necessary for the bacterial ribosome to recognize the mRNA. B: Bacteria do not have the intracellular machinery to remove introns from mRNA. C: Appropriate regulatory elements are necessary to allow the DNA to be transcribed. D: A fusion protein may be a product of the reaction (p. 783).
- 11. D (see p. 784).
- 12. A (see p. 790).
- 13. B (see p. 759).
- 14. C (see p. 788).
- 15. E (see p. 784).

Chapter 19— Regulation of Gene Expression

John E. Donelson



19.1 Overview	800
19.2 Unit of Transcription in Bacteria: The Operon	800
19.3 Lactose Operon of <i>E. Coli</i>	802
Repressor of the Lactose Operon Is a Diffusible Protein	803
Operator Sequence of the Lactose Operon Is Contiguous on DNA with a Promoter and Three Structural Genes	805
Promoter Sequence of Lactose Operon Contains Recognition Sites for RNA Polymerase and a Regulator Protein	806
Catabolite Activator Protein Binds at a Site on the Lactose Promoter	807
19.4 Tryptophan Operon of <i>E. Coli</i>	807
Tryptophan Operon Is Controlled by a Repressor Protein	808
Tryptophan Operon Has a Second Control Site: The Attenuator Site	810
Transcription Attenuation Is a Mechanism of Control in Operons for Amino Acid Biosynthesis	813
19.5 Other Bacterial Operons	813
Synthesis of Ribosomal Proteins Is Regulated in a Coordinated Manner	813
Stringent Response Controls Synthesis of rRNAs and tRNAs	815
19.6 Bacterial Transposons	816
Transposons Are Mobile Segments of DNA	816
<i>Tn3</i> Transposon Contains Three Structural Genes	816
19.7 Inversion of Genes in <i>Salmonella</i>	818
19.8 Organization of Genes in Mammalian DNA	820
Only a Small Fraction of Eukaryotic DNA Codes for Proteins	820
Eukaryotic Genes Usually Contain Intervening Sequences (Introns)	820
19.9 Repetitive DNA Sequences in Eukaryotes	822
Importance of Highly Repetitive Sequences Is Unknown	822
A Variety of Repeating Units Are Defined as Moderately Repetitive Sequences	822
19.10 Genes for Globin Proteins	824
Recombinant DNA Technology Has Been Used to Clone Genes for Many Eukaryotic Proteins	824
Sickle Cell Anemia Is Due to a Single Base Pair Change	828
Thalassemias Are Caused by Mutations in Genes for the α or β Subunits of Globin	828
19.11 Genes for Human Growth Hormone-Like Proteins	829
19.12 Mitochondrial Genes	830
19.13 Bacterial Expression of Foreign Genes	832
Recombinant Bacteria Can Synthesize Human Insulin	832
Recombinant Bacteria Can Synthesize Human Growth Hormone	834
19.14 Introduction of Rat Growth Hormone Gene into Mice	835
Bibliography	836
Questions and Answers	836
Clinical Correlations	
19.1 Transmissible Multiple Drug Resistances	816
19.2 Duchenne/Becker Muscular Dystrophy and the Dystrophin Gene	822
19.3 Huntington's Disease and Trinucleotide Repeat Expansions	823
19.4 Prenatal Diagnosis of Sickle Cell Anemia	828
19.5 Prenatal Diagnosis of Thalassemia	829
19.6 Leber's Hereditary Optic Neuropathy (LHON)	831

19.1—

Overview

To survive, a living cell must be able to respond to changes in its environment. One of many ways in which cells adjust to changes is to alter expression of specific genes, which, in turn, affects the number of corresponding protein molecules in the cell. This chapter focuses on some of the molecular mechanisms that determine when a given gene will be expressed and to what extent. The attempt to understand how expression of genes is regulated is one of the most active areas of biochemical research today.

It makes sense for a cell to vary the amount of a given gene product available under different conditions. For example, the bacterium *Escherichia coli* (*E. coli*) contains genes for about 3000 different proteins, but it does not need to synthesize all of these proteins at the same time. Therefore it regulates the number of molecules of these proteins that are made. The classic illustration of this phenomenon is the regulation of the number of **β -galactosidase** molecules in the cell. This enzyme converts the disaccharide lactose into the monosaccharides, glucose and galactose. When *E. coli* is growing in a medium containing glucose as the carbon source, β -galactosidase is not required and only about five molecules of the enzyme are present in the cell. When lactose is the sole carbon source, however, 5000 or more molecules of β -galactosidase occur in the cell. Clearly, the bacteria respond to the need to metabolize lactose by increasing the synthesis of β -galactosidase molecules. If lactose is removed from the medium, the synthesis of this enzyme stops as rapidly as it began.

The complexity of eukaryotic cells means that they have even more extensive mechanisms of gene regulation than do prokaryotic cells. The differentiated cells of higher organisms have a much more complicated physical structure and often a more specialized biological function that is determined, again, by the expression of their genes. For example, **insulin** is synthesized in β cells of the pancreas and not in kidney cells even though the nuclei of all cells of the body contain the insulin genes. Molecular regulatory mechanisms facilitate the expression of insulin in pancreas and prevent its synthesis in kidney and other cells. In addition, during development of the organism appearance or disappearance of proteins in specific cell types is tightly controlled with respect to timing and sequence of developmental events.

As expected from the differences in complexities, far more is understood about the regulation of genes in prokaryotes than in eukaryotes. However, studies on the control of gene expression in prokaryotes often provide exciting new ideas that can be tested in eukaryotic systems. Sometimes, discoveries about eukaryotic gene structure and regulation alter the interpretation of data on the control of prokaryotic genes.

Several of the best studied examples of gene regulation in bacteria will be discussed, followed by some illustrations of the organization and regulation of related genes in the human genome. Finally, the use of recombinant DNA techniques to express some human genes of clinical interest will be presented.

19.2—

Unit of Transcription in Bacteria:

The Operon

The single *E. coli* chromosome is a circular double-stranded DNA molecule of about four million base pairs. Most of the approximately 3000 *E. coli* genes are not distributed randomly throughout this DNA; instead, the genes that code for the enzymes of a specific metabolic pathway are clustered in one region of the DNA. In addition, genes for associated structural proteins, such as the 70 or so proteins that comprise the ribosome, are frequently adjacent to one another. Members of a set of clustered genes are usually coordinately regulated; they are transcribed together to form a "polycistronic" mRNA species that contains the coding sequences for several proteins. The term **operon** describes the

complete regulatory unit of a set of clustered genes. An operon includes the adjacent **structural genes** that code for the related enzymes or associated proteins, a **regulatory gene** or genes that code for regulator protein(s), and **control elements** that are sites on the DNA near the structural genes at which regulator proteins act. Figure 19.1 shows a partial genetic map of the *E. coli* chromosome that gives locations of structural genes of some of the different operons.

When transcription of the structural genes of an operon increases in response to the presence of a specific substrate in the medium, the effect is known as **induction**. The increase in transcription of the β -galactosidase gene when lactose is the sole carbon source is an example of induction. Bacteria also respond to nutritional changes by quickly turning off the synthesis of enzymes that are no longer needed. As will be described below, *E. coli* synthesizes the amino acid tryptophan as the end product of a specific biosynthetic pathway. However, if tryptophan is supplied in the medium, the bacteria do not need to make it themselves, and synthesis of enzymes for this metabolic pathway is stopped. This process is called **repression**. It permits the bacteria to avoid using their energy for making unnecessary and even harmful proteins.

Induction and repression are manifestations of the same phenomenon. In one case the bacterium changes its enzyme composition so that it can utilize a specific substrate in the medium; in the other it reduces the number of enzyme

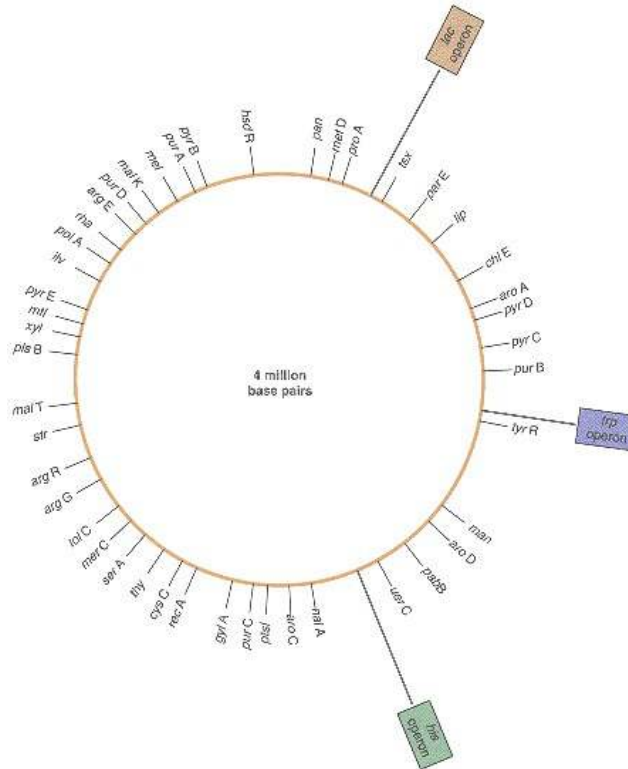

Figure 19.1
Partial genetic map of *E. coli*.
 The locations of only a few of the genes identified and mapped in *E. coli* are shown here. Three operons discussed in this chapter are indicated.
 Reproduced with permission from Stent, G. S., and Calendar, R. *Molecular Genetics, An Introductory Narrative*. San Francisco: Freeman, 1978, p. 289; modified from Bachmann, B. J., Low, K. B., and Taylor, A. L. *Bacteriol Rev.* 40:116, 1976.

molecules so that it does not overproduce a specific metabolic product. The signal for each type of regulation is the small molecule that is a substrate for the metabolic pathway or a product of the pathway, respectively. These small molecules are called **inducers** when they stimulate induction and **corepressors** when they cause repression to occur.

Section 19.3 will describe in detail the lactose operon, the best studied example of a set of inducible genes. Section 19.4 will present the tryptophan operon, an example of a repressible operon. Sections 19.5–19.7 will briefly describe some other operons as well as some gene systems in which physical movement of the genes themselves within the DNA (i.e., gene rearrangements) plays a role in their regulation.

19.3—

Lactose Operon of *E. Coli*

The lactose operon contains three adjacent structural genes as shown in Figure 19.2. *LacZ* codes for the enzyme β -galactosidase, which is composed of four identical subunits of 1021 amino acids. *LacY* codes for a permease, which is a 275-amino acid protein that occurs in the cell membrane and participates in the transport of sugars, including lactose, across the membrane. The third gene, *lacA*, codes for β -galactoside transacetylase, a 275-amino acid enzyme that transfers an acetyl group from acetyl CoA to β -galactoside. Of these three proteins, only β -galactosidase actually participates in a known metabolic pathway. However, the permease is clearly important in the utilization of lactose since it is involved in transporting lactose into the cell. The acetylation reaction may be associated with detoxification and excretion reactions of nonmetabolized analogs of β -galactosides.

Mutations in *lacZ* or *lacY* that destroy the function of β -galactosidase or permease prevent cells from cleaving lactose or acquiring it from the medium, respectively. Mutations in *lacA* that destroy transacetylase activity do not seem to have an identifiable effect on cell growth and division. Perhaps there are other related enzymes in the cell that serve as backups for this enzyme, or perhaps it has an unknown function that is required only under certain conditions.

A single mRNA species containing the coding sequences of all three structural genes is transcribed from a promoter that occurs just upstream from the *lacZ* gene. Induction of these three genes occurs during initiation of their

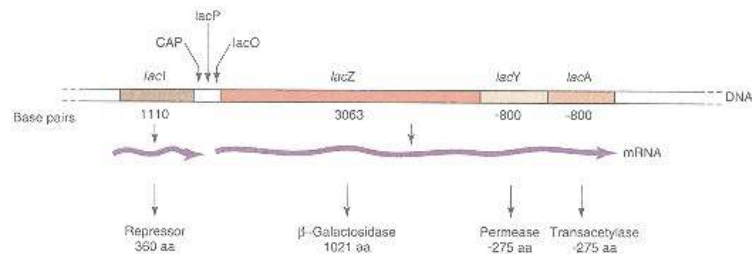

Figure 19.2

Lactose operon of *E. coli*.

The lactose operon is composed of the *lacI* gene, which codes for a repressor, the control elements of *CAP*, *lacP*, and *lacO*, and three structural genes, *lacZ*, *lacY*, and *lacA*, which code for β -galactosidase, a permease, and a transacetylase, respectively. The *lacI* gene is transcribed from its own promoter. Three structural genes are transcribed from the promoter, *lacP*, to form a polycistronic mRNA from which the three proteins are translated.

transcription. Without the inducer, transcription of the gene cluster occurs only at a very low level. In the presence of the inducer, transcription begins at the **promoter**, called *lacP*, and goes through all three genes to a transcription terminator located slightly beyond the end of *lacA*. Therefore the genes are **coordinately expressed**; either all three are transcribed in unison or none is transcribed.

The presence of three coding sequences on the same mRNA molecule suggests that the relative amounts of the three proteins are always the same under varying conditions of induction. An inducer that causes a high rate of transcription will result in a high level of all three proteins; an inducer that stimulates only a little transcription of the operon will result in a low level of the proteins. The inducer can be thought of as a molecular switch that influences synthesis of the single mRNA species for all three genes. The number of molecules of each protein in the cell may be different, but this does not reflect differences in transcription; it reflects differences in translation rates of the coding sequences or in degradation of the proteins themselves.

The mRNA induced by lactose is very unstable; it is degraded with a half-life of about 3 min. Therefore expression of the operon can be altered very quickly. Transcription ceases as soon as inducer is no longer present, existing mRNA molecules disappear within a few minutes, and cells stop making the proteins.

Repressor of the Lactose Operon Is a Diffusible Protein

The regulatory gene of the lactose operon, *lacI*, codes for a protein whose only function is to control the transcription initiation of the three *lac* structural genes. This regulator protein is called the **lac repressor**. The *lacI* gene is located just in front of the controlling elements for the *lacZYA* gene cluster. However, it is not obligatory that a regulatory gene be physically close to the gene cluster it regulates. In some of the other operons it is not. Transcription of *lacI* is not regulated; instead, this single gene is always transcribed from its own promoter at a low rate that is relatively independent of the cell's status. Therefore affinity of the *lacI* promoter for **RNA polymerase** seems to be the only factor involved in its transcription initiation.

The lac repressor is initially synthesized as a monomer of 360 amino acids and four monomers associate to form a tetramer, the active form of the repressor. Usually there are about 10 tetramers per cell. The repressor has a strong affinity for a specific DNA sequence that lies between *lacP* and the start of *lacZ*. This sequence is called the **operator** and is designated *lacO*. The operator overlaps the promoter somewhat so that presence of repressor bound to the operator physically prevents RNA polymerase from binding to the promoter and initiating transcription.

In addition to recognizing and binding to the lac operator DNA sequence, the repressor also has a strong affinity for the inducer molecules of the *lac* operon. Each monomer has a binding site for an inducer molecule. Binding of inducer to the monomers causes an **allosteric change** in the repressor that greatly lowers its affinity for the operator sequence (Figure 19.3). In other words, when inducer molecules are bound to their sites on the repressor, a conformational change in the repressor occurs that alters the binding site for the operator. The result is that repressor no longer binds to the operator so that RNA polymerase, in turn, can begin transcription from the promoter. A repressor molecule that is already bound to the operator when the inducer becomes available can still bind to inducer so that the repressor–inducer complex immediately disassociates from the operator.

A study of the lactose operon has been greatly facilitated by the discovery that some small molecules fortuitously serve as inducers but are not metabolized by β -galactosidase. Isopropylthiogalactoside (**IPTG**) is one of several thiogalac-

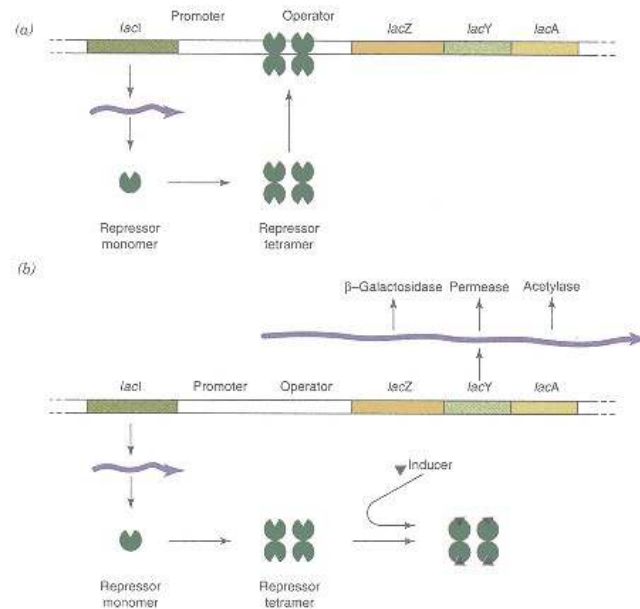

Figure 19.3
Control of *lac* operon.

- (a) Repressor tetramer binds to operator and prevents transcription of structural genes.
 (b) Inducer binds to repressor tetramer, which prevents repressor from binding to operator. Transcription of three structural genes can occur from the promoter.

tosides with this property. They are called **gratuitous inducers**. They bind to inducer sites on the repressor molecule causing the conformational change but are not cleaved by the induced β -galactosidase. Therefore they affect the system without themselves being altered (metabolized) by it. If it were not possible to manipulate experimentally the system with these gratuitous inducers, it would have been much more difficult to reach our current understanding of the lactose operon in particular and bacterial gene regulation in general.

The product of the *lacI* gene, the repressor protein, acts in trans; that is, it is a diffusible product that moves through the cell to its site of action. Therefore mutations in the *lacI* gene can exert an effect on the expression of other genes located far away or even on genes located on different DNA molecules. *LacI* mutations can be of several types. One class of mutations changes or deletes amino acids of the repressor that are located in the binding site for the inducer. These changes interfere with interaction between the inducer and the repressor but do not affect the affinity of repressor for the operator. Therefore the repressor is always bound to the operator, even in the presence of inducer, and the *lacZYA* genes are never transcribed above a very low basal level. Another class of *lacI* mutations changes the amino acids in the operator-binding site of the repressor. Most of these mutations lessen the affinity of the repressor for the operator. This means that repressor does not bind to the operator and *lacZYA* genes are always being transcribed. These mutations are called **repressor-constitutive mutations** because *lac* genes are permanently turned on. Interestingly, a few rare *lacI* mutants actually increase the affinity of repressor for the operator over that of wild-type repressor. In these cases inducer molecules can still bind to repressor, but they are less effective in releasing repressor from the operator.

Repressor-constitutive mutants illustrate the features of a negative control system. An active repressor, in the absence of an inducer, shuts off the expres-

sion of the *lac* structural genes. An inactive repressor results in the constitutive, unregulated, expression of these genes. It is possible, using the recombinant DNA techniques described in Chapter 18, to introduce into constitutive *lacI* mutant cells a recombinant plasmid containing the wild-type *lacI* gene (but not the rest of the *lac* operon). Therefore these cells have one wild-type and one mutant *lacI* gene and will synthesize both active and inactive repressor molecules. Under these conditions, normal wild-type regulation of the lactose operon occurs. In genetic terms, the wild-type induction is dominant over the mutant constitutivity. This property is the main feature of a negative control system.

Operator Sequence of the Lactose Operon Is Contiguous on DNA with a Promoter and Three Structural Genes

The known control elements in front of the structural genes of the lactose operon are the operator and promoter. The operator was originally identified, like the *lacI* gene, by mutations that affected the transcription of the *lacZYA* region. Some of these mutations also result in the constitutive synthesis of lac mRNA; that is, they are **operator-constitutive mutations**. In these cases the operator DNA sequence has undergone one or more base pair changes so that the repressor no longer binds as tightly to the sequence. Thus the repressor is less effective in preventing RNA polymerase from initiating transcription.

In contrast to mutations in the *lacI* gene that affect the diffusible repressor, mutations in the operator do not affect a diffusible product. They exert their influence on the transcription of only the three *lac* genes that lie immediately downstream of the operator on the same DNA molecule. This means that if a second lac operon is introduced into a bacterium on a recombinant plasmid, the operator of one operon does not influence action on the other operon. Therefore an operon with a wild-type operator will be repressed under the usual conditions, whereas in the same bacterium a second operon that has an operator-constitutive mutation will be transcribed continuously.

Operator mutations are frequently referred to as **cis-dominant** to emphasize that these mutations affect only adjacent genes on the same DNA molecule and that they are not influenced by the presence in the cell of other copies of the unmutated sequence. Cis-dominant mutations occur in DNA sequences that are recognized by proteins rather than in DNA sequences that code for the diffusible proteins. **Trans-dominant** mutations occur in genes that specify the diffusible products. Therefore cis-dominant mutations also occur in promoter and transcription termination sequences, whereas trans-dominant mutations also occur in the genes for the subunit proteins of RNA polymerase, the ribosomes, and so on.

Figure 19.4 shows the sequence of both the *lac* operator and promoter. The operator sequence has an axis of dyad symmetry. The sequence of the upper strand on the left side of the operator is nearly identical to the lower strand on the right side; only three differences occur between these inverted

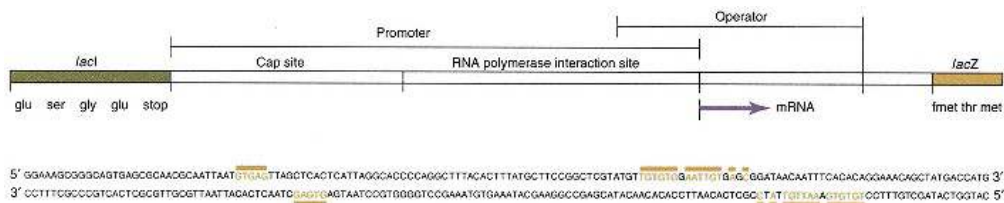

Figure 19.4

Nucleotide sequence of control elements of lactose operon.

The end of the *lacI* gene (coding for the lactose repressor) and the beginning of the *lacZ* gene (coding for β -galactosidase) are also shown. Lines above and below the sequence indicate symmetrical sequences within the CAP site and operator.

DNA repeats. This symmetry in the DNA recognition sequence reflects symmetry in the tetrameric repressor. It probably facilitates the tight binding of the subunits of the repressor to the operator, although this has not been definitively demonstrated. A common feature of many protein-binding or recognition sites on double-stranded DNA, including most recognition sites for restriction enzymes, is a **dyad symmetry** in the nucleotide sequence.

The 30 bp that constitute the *lac* operator are an extremely small fraction of the total *E. coli* genome of 4×10^6 bp and occupy an even smaller fraction of the total volume of the cell. Therefore it would seem that the approximately 10 tetrameric repressors in a cell might have trouble finding the *lac* operator if they just randomly diffuse about the cell. Although this remains a puzzling consideration, there are factors that confine the repressor to a much smaller space than the entire volume of the cell. First, it probably helps that the repressor gene is very close to the *lac* operator. This means that the repressor does not have far to diffuse if its translation begins before its mRNA is fully synthesized. Second, and more importantly, the repressor possesses a low general affinity for all DNA sequences. When the inducer binds to the repressor, its affinity for the operator is reduced about a 1000-fold, but its low affinity for random DNA sequences is unaltered. Therefore all of the *lac* repressors of the cell probably spend the majority of the time in loose association with the DNA. As the binding of the inducer releases a repressor molecule from the operator, it quickly reassociates with another nearby region of the DNA. Therefore induction redistributes the repressor on the DNA rather than generates freely diffusing repressor molecules. This confines the repressor to a smaller volume within the cell.

Another question is how does lactose enter a *lac*-repressed cell in the first place if the *lacY* gene product, the permease, is repressed yet is required for lactose transport across the cell membrane? The answer is that even in the fully repressed state, there is a very low basal level of transcription of the *lac* operon that provides five or six molecules of the permease per cell. Perhaps this is just enough to get a few molecules of lactose inside the cell and begin the process.

An even more curious observation is that, in fact, lactose is not the natural inducer of the lactose operon as we would expect. When the repressor is isolated from fully induced cells, the small molecule bound to each repressor monomer is **allolactose**, not lactose. Allolactose, like lactose, is composed of galactose and glucose, but the linkage between the two sugars is different. It turns out that a side reaction of β -galactosidase (which normally breaks down lactose to galactose and glucose) converts these two products to allolactose. Therefore it appears that a few molecules of lactose are taken up and converted by β -galactosidase to allolactose, which then binds to the repressor and induces the operon. Further confirmation that lactose itself is not the real inducer comes from experiments indicating that lactose binding to the purified repressor slightly increases the repressor's affinity for the operator. Therefore, in the induced state, a small amount of allolactose must be present in the cell to overcome this "anti-inducer" effect of the lactose substrate.

Promoter Sequence of Lactose Operon Contains Recognition Sites for RNA Polymerase and a Regulator Protein

Immediately in front of the *lac* operator sequence is the promoter sequence. This sequence contains the recognition sites for two different proteins, RNA polymerase and the **CAP-binding protein** (Figure 19.4). The site at which RNA polymerase interacts with the DNA to initiate transcription has been identified using several different genetic and biochemical approaches. Point mutations in this region frequently affect the affinity to which RNA polymerase will bind the DNA. Deletions (or insertions) that extend into this region also dramatically affect the binding of RNA polymerase to the DNA. The end points of the sequence to which RNA polymerase binds were identified by **DNase protection**

experiments. Purified RNA polymerase was bound to the *lac* promoter region cloned in a bacteriophage DNA or a plasmid, and this protein–DNA complex was digested with DNase I. The DNA segment protected from degradation by DNase was recovered and its sequence determined. The ends of this protected segment varied slightly with different DNA molecules but corresponded closely to the boundaries of the RNA polymerase interaction site shown in Figure 19.4.

The sequence of the RNA polymerase interaction site is not composed of symmetrical elements similar to those described for the operator sequence. This is not surprising since RNA polymerase must associate with the DNA in an asymmetrical fashion for RNA synthesis to be initiated in only one direction from the binding site. However, that portion of the promoter sequence recognized by the CAP-binding protein does contain some symmetry. A **DNA–protein interaction** at this region enhances transcription of the *lac* operon as described in the next section.

Catabolite Activator Protein Binds at a Site on the Lactose Promoter

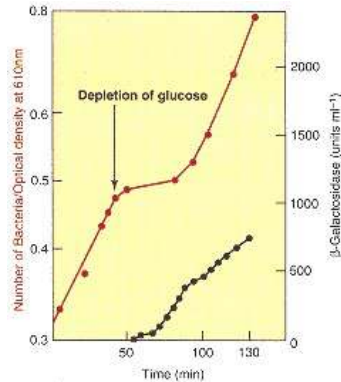

Figure 19.5
Lack of synthesis of β -galactosidase in *E. coli* when glucose is present.

The bacteria are growing in a medium containing initially 0.4 mg mL^{-1} of glucose and 2 mg mL^{-1} lactose. The left-hand ordinate indicates the optical density of the growing culture, an indicator of the number of bacterial cells. The right-hand ordinate indicates the units of β -galactosidase per milliliter. Note that the appearance of β -galactosidase is delayed until the glucose is depleted. Redrawn from Epstein, W., Naono, S., and Gros, F. *Biochem. Biophys. Res. Commun.* 24:588, 1966.

Escherichia coli prefers to use glucose instead of other sugars as a carbon source. For example, if the concentrations of glucose and lactose in the medium are the same, the bacteria will selectively metabolize the glucose and not utilize the lactose. This phenomenon is illustrated in Figure 19.5, which shows that the appearance of β -galactosidase, the *lacZ* product, is delayed until all of the glucose in the medium is depleted. Only then can lactose be used as the carbon source. This delay indicates that glucose interferes with the induction of the lactose operon. This effect is called **catabolite repression** because it occurs during the catabolism of glucose and may be due to a catabolite of glucose rather than glucose itself. An identical effect is exerted on a number of other inducible operons, including the arabinose and galactose operons, which code for enzymes involved in the utilization of various substances as energy sources. It probably is a general coordinating system for turning off synthesis of unwanted enzymes whenever the preferred substrate, glucose, is present.

Catabolite repression begins in the cell when glucose lowers the concentration of intracellular **cyclic AMP** (cAMP). The exact mechanism by which this reduction in the cAMP level is accomplished is not known. Perhaps glucose influences either the rate of synthesis or degradation of cAMP. At any rate, cAMP can bind to another regulatory protein, which has not been discussed yet, called CAP (for **catabolite activator protein**) or CRP (for cAMP receptor protein). CAP is an **allosteric protein**, and when it is combined with cAMP, it is capable of binding to the CAP regulatory site that is at the promoter of the *lac* (and other) operons. The CAP–cAMP complex exerts positive control on the transcription of these operons. Its binding to the CAP site on the DNA facilitates the binding of RNA polymerase to the promoter (Figure 19.6). Alternatively, if the CAP site is not occupied, RNA polymerase has more difficulty binding to the promoter, and transcription of the operon occurs much less efficiently. Therefore, when glucose is present, the cAMP level drops, the CAP–cAMP complex does not form, and the positive influence on RNA polymerase does not occur. Conversely, if glucose is absent, the cAMP level is high, a CAP–cAMP complex binds to the CAP site, and transcription is enhanced.

19.4—

Tryptophan Operon of *E. Coli*

Tryptophan is essential for bacterial growth; it is needed for the synthesis of all proteins that contain tryptophan. Therefore, if tryptophan is not present in sufficient amount by the medium, the cell must make it. In contrast, lactose is not absolutely required for the cell's growth; many other sugars can substitute for it, and, in fact, as we saw in the previous section, the bacterium prefers to

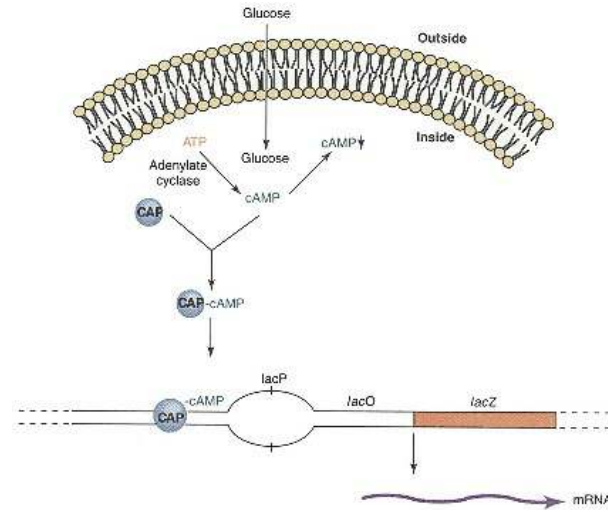

Figure 19.6
Control of *lacP* by cAMP.

A CAP-cAMP complex binds to the CAP site and enhances transcription at *lacP*. Catabolite repression occurs when glucose lowers the intracellular concentration of cAMP. This reduces the amount of the CAP-cAMP complex and decreases transcription from *lacP* and from the promoters of several other operons.

use some of these other sugars for the carbon source. As a result, synthesis of the tryptophan biosynthetic enzymes is regulated differently than synthesis of the proteins encoded by the lactose operon.

Tryptophan Operon Is Controlled by a Repressor Protein

In *E. coli* tryptophan is synthesized from chorismic acid in a five-step pathway that is catalyzed by three different enzymes as shown in Figure 19.7. The **tryptophan operon** contains the five structural genes that code for these three enzymes (two of which have two different subunits). Upstream from this gene cluster is a promoter where transcription begins and an operator to which binds a repressor protein encoded by the unlinked *trpR* gene. Transcription of the lactose operon is generally "turned off" unless it is induced by the small molecule inducer. The tryptophan operon, on the other hand, is always "turned on" unless it is repressed by the presence of a small molecule **corepressor** (a term used to distinguish it from the repressor protein). Hence the *lac* operon is inducible, whereas the *trp* operon is repressible. When the *trp* operon is being actively transcribed, it is said to be **derepressed**; that is, the *trp* repressor is not preventing RNA polymerase from binding. This is mechanistically the same as an induced lactose operon in which the *lac* repressor is not interfering with RNA polymerase.

The biosynthetic pathway for tryptophan synthesis is regulated by mechanisms that affect both the synthesis and activity of the enzymes that catalyze the pathway. For example, anthranilate synthetase, which catalyzes the first step of the pathway, is encoded by the *trpE* and *trpD* genes of the *trp* operon. The number of molecules of this enzyme that is present in the cell is determined by the transcriptional regulation of the *trp* operon. However, the catalytic activity of the existing molecules of the enzyme is regulated by **feedback inhibition**. This is a common short-term means of regulating the first committed step in a metabolic pathway. In this case, tryptophan, the end product of the pathway, can bind to an allosteric site on the anthranilate synthetase and interfere with its catalytic activity at another site. Therefore, as the concentration of tryptophan

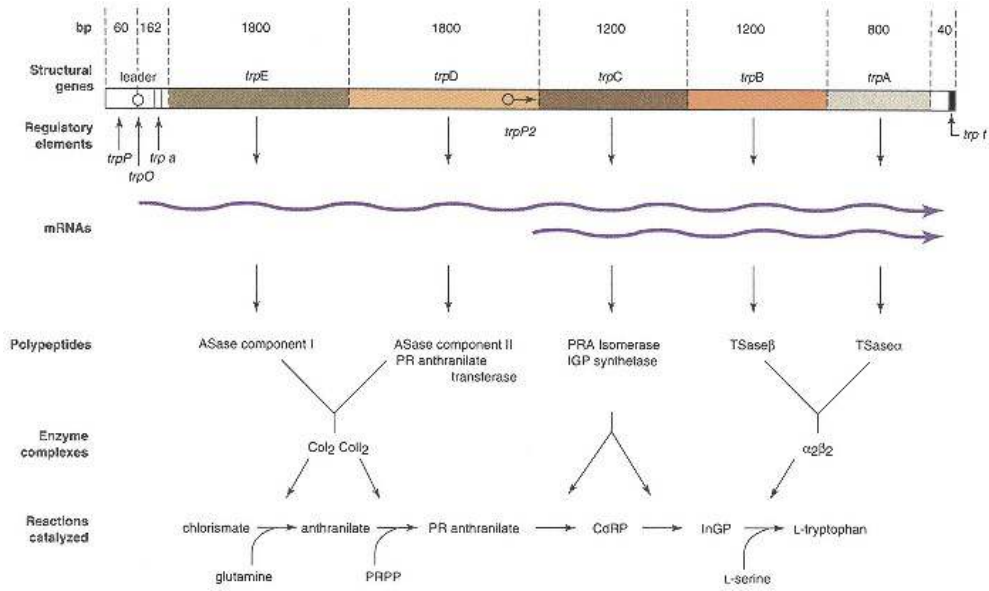

Figure 19.7

Genes of tryptophan operon of *E. coli*.

Regulatory elements are the primary promoter (*trpP*), operator (*trpO*), attenuator (*trp a*), secondary internal promoter (*trpP2*), and terminator (*trp t*) Direction of mRNA synthesis is indicated on the wavy lines representing mRNAs. Col₂ and ColI₂ signify components I and II, respectively, of the anthranilate synthetase (ASase) complex; PR-anthranilate is *N*-5-phosphoribosyl-anthranilate; CdRP is 1-(*o*-carboxy-phenylamino)-1-deoxyribulose-5-phosphate; InGP is indole-3-glycerol phosphate; PRPP is 5-phosphoribosyl-1-pyrophosphate; and TSase is tryptophan synthetase.

Redrawn from Platt, T. The tryptophan operon. In: J. H. Miller and W. Reznikoff (Eds.), *The Operon*. Cold Spring Harbor, NY: Cold Spring Harbor Laboratory Press, 1978, p. 263.

builds up in the cell, it begins to bind to anthranilate synthetase and immediately decreases its activity on the substrate, chorismic acid. In addition, tryptophan also acts as a **corepressor** to shut down the synthesis of new enzyme molecules from the *trp* operon. Thus feedback inhibition is a short-term control that has an immediate effect on the pathway, whereas repression takes a little longer but has the more permanent effect of reducing the number of enzyme molecules.

The *trp* repressor is a tetramer of four identical subunits of about 100 amino acids each. Under normal conditions about 20 molecules of the repressor tetramer are present in the cell. The repressor by itself does not bind to the *trp* operator. It must be complexed with tryptophan in order to bind to the operator and therefore acts *in vivo* only in the presence of tryptophan. This is exactly the opposite of the *lac* repressor, which binds to its operator only in the absence of its small molecule inducer. Interestingly, *trp* repressor also regulates transcription of *trpR*, its own gene. As *trp* repressor accumulates in cells, the repressor-tryptophan complex binds to a region upstream of this gene, turning off its transcription and maintaining the equilibrium of 20 repressors per cell. Another difference from the *lac* operon is that the *trp* operator occurs entirely within the *trp* promoter rather than adjacent to it, as shown in Figure 19.8. The operator sequence is a region of dyad symmetry, and the mechanism

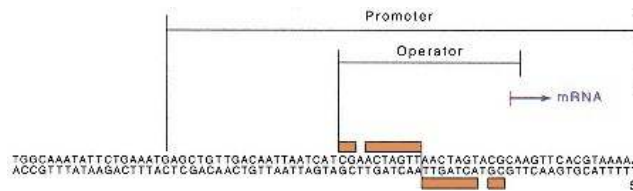

Figure 19.8

Nucleotide sequence of control elements of the tryptophan operon.

Lines above and below sequence indicate symmetrical sequences within operator.

of preventing transcription is the same as in the *lac* operon. Binding of the repressor–corepressor complex to the operator physically blocks the binding of RNA polymerase to the promoter.

Repression results in about a 70-fold decrease in the rate of transcription initiation at the *trp* promoter. (In contrast, the basal level of *lac* gene products is about 1000-fold lower than the induced level.) However, the *trp* operon contains additional regulatory elements that impose further control on the extent of its transcription. One of these additional control sites is a secondary promoter, designated *trpP2*, which is located within the coding sequence of the *trpD* gene (shown in Figure 19.7). This promoter is not regulated by the *trp* repressor. Transcription from it occurs constitutively at a relatively low rate and is terminated at the same location as transcription from the regulated promoter for the whole operon, *trpP*. The resulting transcription product from *trpP2* is an mRNA that contains the coding sequences for *trpCBA*, the last three genes of the operon. Therefore two polycistronic mRNAs are derived from the *trp* operon, one containing all five structural genes and one possessing only the last three genes. Under conditions of maximum repression the basal level of mRNA coding sequence for the last three genes is about five times higher than the basal mRNA level for the first two genes.

The reason for a second internal promoter is unclear. Perhaps the best alternative comes from the observation that three of the five proteins do not contain tryptophan; only the *trpB* and *trpC* genes contain the single codon that specifies tryptophan. Therefore, under extreme tryptophan starvation, these two proteins would not be synthesized, which would prevent the pathway from being activated. However, since both of these genes lie downstream of the unregulated second promoter, their protein products will always be present at the basal level necessary to maintain the pathway.

Tryptophan Operon Has a Second Control Site: The Attenuator Site

Another important control element of the *trp* operon not present in the *lac* operon is the **attenuator site** (Figure 19.9). It lies within 162 nucleotides between the start of transcription from *trpP* and the initiator codon of the *trpE* gene. Its existence was first deduced by the identification of mutations that mapped in this region and increased transcription of all five structural genes. Within the 162 nucleotides, called the **leader sequence**, are 14 adjacent codons that begin with a methionine codon and end with an in-phase termination codon. These codons are preceded by a canonical ribosome-binding site and

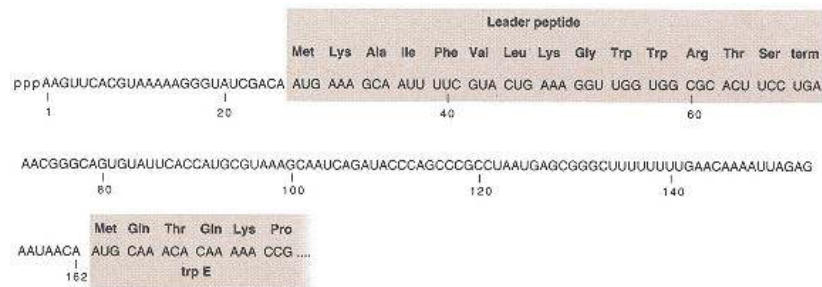

Figure 19.9

Nucleotide sequence of leader RNA from *trp* operon.

The 14 amino acids of the putative leader peptide are indicated over their codons.
Redrawn with permission from Oxender, D. L., Zurawski, G., and Yanofsky, C.
Proc. Natl. Acad. Sci. USA 76:5524, 1979.

could potentially specify a 14-residue leader peptide. This peptide has never been detected in bacterial cells, perhaps because it is degraded very rapidly. The ribosome-binding site does function properly when its corresponding DNA sequence is ligated upstream of a structural gene using recombinant DNA techniques.

The attenuator region provides RNA polymerase with a second chance to stop transcription if the *trp* enzymes are not needed by the cell. In the presence of tryptophan, it acts like a rho-independent transcription termination site to produce a short 140-nucleotide transcript. In the absence of tryptophan, it has no effect on transcription, and the entire polycistronic mRNA of the five structural genes is synthesized. Therefore, at both the operator and attenuator, tryptophan exerts the same general influence. At the operator it participates in repressing transcription, and at the attenuator it participates in stopping transcription by those RNA polymerases that have escaped repression. It has been estimated that attenuation has about a 10-fold effect on transcription of the *trp* structural genes. When multiplied by the 70-fold effect of derepression at the operator, about a 700-fold range exists in the level at which the *trp* operon can be transcribed.

The molecular mechanism by which transcription is terminated at the attenuator site is a marvelous example of cooperative interaction between bacterial transcription and translation to achieve desired levels of a given mRNA. The first hints that ribosomes were involved in the mechanism of attenuation came from the observation that mutations in the gene for **tRNA^{Trp} synthetase** (the enzyme that charges the tRNA with tryptophan) or the gene for an enzyme that modifies some bases in the tRNA prevent attenuation. Therefore a functional tRNA^{Trp} must participate in the process.

The leader peptide (Figure 19.9) of 14 residues contains two adjacent tryptophans in positions 10 and 11. This is unusual because tryptophan is a relatively rare amino acid in *E. coli*. It also provides a clue about the involvement of tRNA^{Trp} in attenuation. If the tryptophan in the cell is low, the amount of charged tRNA^{Trp} will also be low and the ribosomes may be unable to translate through the two *trp* codons of the leader peptide region. Therefore they will stall at this place in the leader RNA sequence.

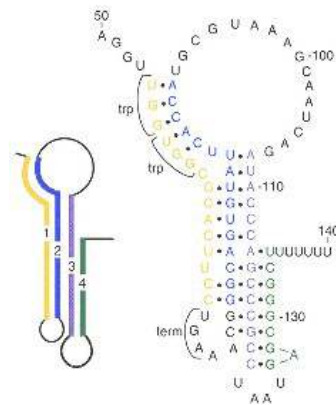

Figure 19.10
Schematic diagram showing the proposed secondary structures in *trp* leader RNA from *E. coli*.

Four regions can base pair to form three stem-and-loop structures. These are shown as 1-2, 2-3, and 3-4.
Reproduced with permission from Oxender, D. L., Zurawski, G., and Yanofsky, C. *Proc. Natl. Acad. Sci. USA* 76:5524, 1979.

It turns out that the RNA sequence of the attenuator region can adopt several possible secondary structures (Figure 19.10). The position of the ribosome within the leader peptide-coding sequence determines the secondary structure that will form. This secondary structure, in turn, is recognized (or sensed) by the RNA polymerase that has just transcribed through the attenuator coding region and is now located a small distance downstream. The RNA secondary structure that forms when a ribosome is not stalled at the *trp* codons is a termination signal for the RNA polymerase. Under these conditions the cell does not need to make tryptophan, and transcription stops after the synthesis of a 140-nucleotide transcript, which is quickly degraded. On the other hand, the secondary structure that results when the ribosomes are stalled at the *trp* codons is not recognized as a termination signal, and the RNA polymerase continues on into the *trpE* gene. Figure 19.11 shows these different secondary structures in detail.

The structure in Figure 19.11a shows the situation when a ribosome does not stall at the two tandem *trp* codons, UGG-UGG, near the beginning of region 1, but instead moves on to region 2. When the ribosome is in region 2, regions 1 and 2 cannot base pair but regions 3 and 4 can form base pairs, resulting in a hairpin loop followed by eight U residues, a structure common to sequences that signal transcription termination. Thus when the leader RNA sequence is being synthesized in the presence of sufficient tryptophan (and charged tryptophanyl-tRNA^{Trp}), it is likely that a loop between regions 3 and 4 will occur and be recognized as a signal for termination by the RNA polymerase.

A different structure occurs if the ribosome is stalled at the *trp* codons and

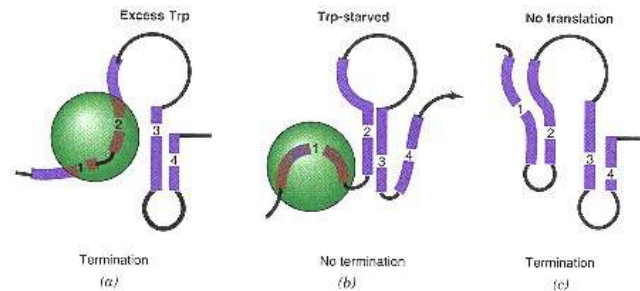

Figure 19.11

Schematic diagram showing the model for attenuation in the *trp* operon of *E. coli*.

- (a) Under conditions of excess tryptophan, the ribosome (green sphere) translating the newly transcribed leader RNA will synthesize the complete leader peptide. During this synthesis the ribosome will bind to regions 1 and 2 of the RNA and prevent formation of stem and loop 1–2 or 2–3. Stem and loop 3–4 will be free to form and signal the RNA polymerase molecule (not shown) to terminate transcription.
- (b) Under conditions of tryptophan starvation, tryptophanyl-tRNA^{Trp} will be limiting, and the ribosome will stall at the adjacent *trp* codons at the beginning of region 1 in the leader peptide-coding region. Because region 1 is bound to the ribosomes, stem and loop 2–3 will form, excluding formation of stem and loop 3–4, which is required as the signal for transcription termination. Therefore RNA polymerase will continue transcription into the structural genes.
- (c) Under conditions in which the leader peptide is not translated, stem and loop 1–2 will form, preventing formation of stem and loop 2–3, and thereby permit formation of stem and loop 3–4. This will signal transcription termination.

Reproduced with permission from Oxender, D. L., Zurawski, G., and Yanofsky, C. *Proc. Natl. Acad. Sci. USA* 76:5524, 1979.

region 1 is prevented from base pairing with region 2 (Figure 19.11*b*). Under these circumstances, region 2 now can base pair with region 3. This region 2 and 3 hairpin ties up the sequence complementary to region 4, so that region 4 remains single stranded. Therefore the region 3 and 4 hairpin loop that serves as the termination signal does not form, and the RNA polymerase continues on with its transcription. Thus for transcription to proceed past the attenuator, region 1 must be prevented from pairing with region 2. This is accomplished if the ribosome stalls in region 1 due to an insufficient amount of charged tryptophan-tRNA for translation of the leader peptide to continue beyond two *trp* codons. When this happens, region 1 is bound within the ribosome and cannot pair with region 2. Since regions 2 and 3 are synthesized before region 4, they, in turn, will base pair before region 4 appears in the newly transcribed RNA. Therefore region 4 remains single stranded, the termination hairpin does not form, and RNA polymerase continues transcription into the structural genes.

Since the two *trp* codons occur in region 1, if the ribosome happens to stall at an earlier codon in the leader sequence, it will have little effect on attenuation. For example, starvation for lysine, valine, or glycine would be expected to reduce the amount of the corresponding charged tRNA and stall the ribosome at that codon, but a deficiency in these amino acids has no effect on transcription of the *trp* operon. An exception is arginine whose codon occurs immediately after the *trp* codons. Starving for arginine does attenuate transcription termination somewhat, probably because of ribosome stalling at this codon, but to less of an extent than a deficiency in tryptophan.

Cis-acting mutations in the attenuator region support this alternate hairpin model. Most of these mutations result in increased transcription because they disrupt base pairing in the double-stranded portion of the termination hairpin

Operon	Leader peptide sequence	Regulatory amino acids
<i>his</i>	Met-Thr-Arg-Val-Gln-Phe-Lys-His-His-His-His-His-His-His-His-His-Pro-Asp	His
<i>pheA</i>	Met-Lys-His-Ile-Pro-Phe-Phe-Phe-Ala-Phe-Phe-Phe-Thr-Phe-Pro	Phe
<i>thr</i>	Met-Lys-Arg-Ile-Ser-Thr-Thr-Ile-Thr-Thr-Ile-Thr-Ile-Thr-Thr-Gly-Asn-Gly-Ala-Gly	Thr Ile
<i>leu</i>	Met-Ser-His-Ile-Val-Arg-Phe-Thr-Gly-Leu-Leu-Leu-Leu-Asn-Ala-Phe-Ile-Val-Arg-Gly-Arg-Pro-Val-Gly-Gly-Ile-Gln-His	Leu
<i>ilv</i>	Met-Thr-Ala-Leu-Leu-Arg-Val-Ile-Ser-Leu-Val-Val-Ile-Ser-Val-Val-Val-Ile-Ile-Ile-Pro-Pro-Cys-Gly-Ala-Ala-Leu-Gly-Arg-Gly-Lys-Ala	Leu, Val, Ile

Figure 19.12

Leader peptide sequences specified by biosynthetic operons of *E. coli*.

All contain multiple copies of amino acid(s) synthesized by enzymes coded for by operon.

and render it less stable. Some mutations, however, increase termination at the attenuator. One of these interferes with base pairing between regions 2 and 3, allowing region 3 to be available for pairing with region 4 even when region 1 is bound to a stalled ribosome. Another mutation occurs in the AUG initiator codon for the leader peptide so that the ribosome cannot begin its synthesis.

Transcription Attenuation Is a Mechanism of Control in Operons for Amino Acid Biosynthesis

Attenuation is a common phenomenon in bacterial gene expression; it occurs in at least six other operons that code for enzymes catalyzing amino acid biosynthetic pathways. Figure 19.12 shows the corresponding **leader peptide** sequences specified by each of these operons. In each case, the leader peptide contains several codons for the amino acid product of the biosynthetic pathway. The most extreme case is the 16-residue leader peptide of the histidine operon that contains seven contiguous histidines. Starvation for histidine results in a decrease in the amount of histidyl-tRNA^{His} and a dramatic increase in transcription of the *his* operon. As with the *trp* operon, this effect is diminished by mutations that interfere with the level of charged histidyl-tRNA^{His}. Furthermore, the nucleotide sequence of the attenuator region suggests that ribosome stalling at the histidine codons also influences the formation of alternate hairpin loops, one of which resembles a termination hairpin followed by several U residues. In contrast to the *trp* operon, transcription of the *his* operon is regulated entirely by attenuation; it does not possess an operator that is recognized by a repressor protein. Instead, the **ribosome** acts rather like a positive regulator protein, similar to the cAMP–CAP complex discussed with the *lac* operon. If the ribosome is bound to (i.e., stalled at) the attenuator site, then transcription of the downstream structural genes is enhanced. If the ribosome is not bound, then transcription of these genes is greatly reduced.

Transcription of the other operons shown in Figure 19.12 can be attenuated by more than one amino acid. For example, the *thr* operon is attenuated by either threonine or isoleucine; the *ilv* operon is attenuated by leucine, valine, or isoleucine. This effect can be explained in each case by stalling of the ribosome at the corresponding codon, which, in turn, interferes with the formation of a termination hairpin. Although not proved, it is possible that in the cases of the longer leader peptides, stalling at more than one codon is necessary to achieve maximal transcription through the attenuation region.

19.5—**Other Bacterial Operons*****Synthesis of Ribosomal Proteins Is Regulated in a Coordinated Manner***

Many other bacterial operons have been studied and found to possess the same general regulatory mechanisms as the *lac*, *trp*, and *his* operons, as discussed

Operon	Regulator protein	Proteins specified by the operon
<i>Spc</i>	S8	L14-L24-L5-S14-S8-L6-L18-S5-L15-L30
<i>S10</i>	L4	S10-L3-L2-L4-L23-S19-L22-S3-S17-L16-L29
<i>str</i>	S7	S12-S7-EF•G-EF•Tu
α	S4	S13-S11-S4- α -L17
<i>L11</i>	L1	L11-L1
<i>rif</i>	L10	L10-L7- β

Figure 19.13

Operons containing genes for ribosomal proteins *E. coli*.

Genes for the protein components of the small (S) and large (L) ribosomal subunits of *E. coli* are clustered on several operons. Some of these operons also contain genes for RNA polymerase subunits α , β , and β' , and protein synthesis factors EF•G and EF•Tu. At least one of the protein products of each operon usually regulates expression of that operon (see text).

in Section 19.4. However, each operon has evolved its own distinctive quirks. For example, one interesting group of operons are those containing the structural genes for the 70 or more proteins that comprise the ribosome (Figure 19.13). Each ribosome contains one copy of each **ribosomal protein** (except for protein L7-L12, which is probably present in four copies). Therefore all 70 proteins are required in equimolar amounts, and it makes sense that their synthesis is regulated in a coordinated fashion. Characterization of this set of operons is not yet complete, but six operons, containing about one-half of the ribosomal protein genes, occur in two major gene clusters. One cluster contains four adjacent operons (*str*, *Spc*, *S10*, and *a*), and the other two operons are near each other elsewhere in the *E. coli* chromosome. There is no obvious pattern to distribution of these genes among different operons. Some operons contain genes for proteins of just one ribosomal subunit; others code for proteins of both subunits. In addition to structural genes for ribosomal proteins, these operons also contain genes for other (related) proteins. For example, *str* operon contains genes for the two soluble **translation elongation factors**, EF•Tu and EF•G, as well as genes for some proteins in the 30S ribosomal subunit. The α operon has genes for proteins of both 30S and 50S ribosomal subunits plus a gene for one of the subunits of RNA polymerase. The *rif* operon has genes for two other protein subunits of RNA polymerase and genes for ribosomal proteins.

A common theme among the six ribosomal operons is that their expression is regulated by one of their own structural gene products; that is, they are **self-regulated**. The precise mechanism of this self-regulation varies considerably with each operon and is not yet understood in detail. However, in some cases the regulation occurs at the level of translation, not transcription as discussed for the *lac* and *trp* operons. After the polycistronic mRNA is made, the "regulatory" ribosomal protein binds to this mRNA and determines which regions, if any, are translated. In general, the ribosomal protein that regulates expression of its own operon, or part of its own operon, is a protein that is associated with one of the ribosomal RNAs (rRNAs) in the intact ribosome. This ribosomal protein has a high affinity for the rRNA and a lower affinity for one or more regions of its own mRNA. Therefore a competition between the rRNA and the operon's mRNA for binding with the ribosomal protein occurs. As the ribosomal protein accumulates to a higher level than the free rRNA, it binds to its own mRNA and prevents the initiation of protein synthesis at one or more of the coding sequences on this mRNA (Figure 19.14). As more ribosomes are formed, the excess of this particular ribosomal protein is used up and translation of its coding sequence on the mRNA can begin again.

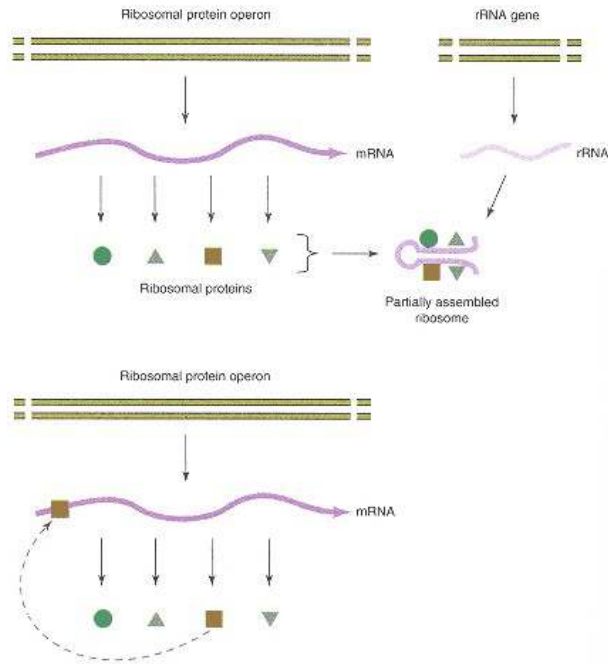

Figure 19.14
Self-regulation of ribosomal protein synthesis.
 If free rRNA is not available for assembly of new ribosomal subunits, individual ribosomal proteins bind to polycistronic mRNA from their own operon, blocking further translation.

Stringent Response Controls Synthesis of rRNAs and tRNAs

Bacteria have several ways in which to respond molecularly to emergency situations; that is, times of **extreme general stress**. One of these situations is when the bacterium does not have a sufficient pool of amino acids to maintain protein synthesis. Under these conditions the cell invokes what is called the **stringent response**, a mechanism that reduces the synthesis of the rRNAs and tRNAs about 20-fold. This places many of the activities within the cell on hold until conditions improve. The mRNAs are less affected, but there is also about a three-fold decrease in their synthesis.

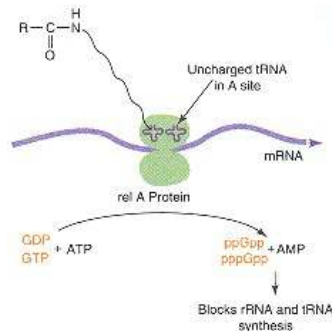

Figure 19.15
Stringent control of protein synthesis in *E. coli*.
 During extreme amino acid starvation, an uncharged tRNA in the A site of the ribosome activates the *relA* protein to synthesize ppGpp and pppGpp, which, in turn, are involved in decreasing transcription of the genes coding for rRNAs and tRNAs.

The stringent response is triggered by the presence of an uncharged tRNA in the A site of the ribosome. This occurs when the concentration of the corresponding charged tRNA is very low. The first result, of course, is that further peptide elongation by the ribosome stops. This event causes a protein called the **stringent factor**, the product of the *relA* gene, to synthesize **guanosine tetraphosphate** (ppGpp) and **guanosine pentaphosphate** (pppGpp), from ATP and GTP or GDP as shown in Figure 19.15. Stringent factor is loosely associated with a few, but not all, ribosomes of the cell. Perhaps a conformational change in the ribosome is induced by occupation of the A site by an uncharged tRNA, which, in turn, activates the associated stringent factor. The exact functions of ppGpp and pppGpp are unknown. However, they seem to inhibit transcription initiation of the rRNA and tRNA genes. In addition they affect transcription of some operons more than others.

CLINICAL CORRELATION 19.1**Transmissible Multiple Drug Resistances**

Pathogenic bacteria are becoming increasingly resistant to a large number of antibiotics, which is viewed with alarm by many physicians. Many cases have been documented in which a bacterial strain in a patient being treated with one antibiotic suddenly became resistant to that antibiotic and, simultaneously, to several other antibiotics even though the bacterial strain had never been previously exposed to these other antibiotics. This occurs when the bacteria suddenly acquire from another bacterial strain a plasmid that contains several different transposons, each containing one or more antibiotic-resistance genes. Examples include the genes encoding β -lactamase, which inactivates penicillins and cephalosporins, chloramphenicol acetyltransferase, which inactivates chloramphenicol, and phosphotransferases, which modify aminoglycosides such as neomycin and gentamycin.

Neu, H. C. The crisis in antibiotic resistance. *Science* 257: 1064, 1992.

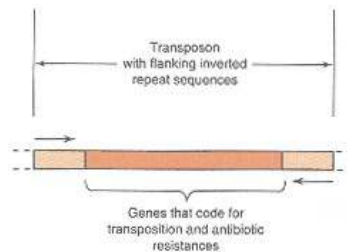
19.6—**Bacterial Transposons***Transposons Are Mobile Segments of DNA***Figure 19.16****General structure of transposons.**

Transposons are relatively rare mobile segments of DNA that contain genes coding for their own rearrangement and (usually) genes that specify resistance to various antibiotics.

So far we have only discussed the regulation of bacterial genes whose locations are fixed in the chromosome. Their positions relative to the neighboring genes do not change. The vast majority of bacterial genes are of this type. In fact, genetic maps of *E. coli* and *Salmonella typhimurium* are quite similar, indicating the lack of much evolutionary movement of most genes within the bacterial chromosome. There is a class of bacterial genes, however, in which newly duplicated gene copies "jump" to another genomic site with a frequency of about 10^{-7} per generation, the same rate as spontaneous point mutations occur. The mobile segments of DNA containing these genes are called **transposable elements** or **transposons** (Figure 19.16). Transposons were first detected as rare insertions of foreign DNA into structural genes of bacterial operons. Usually, these insertions interfere with the expression of the structural gene into which they have inserted and all downstream genes of the operon. This is not surprising since they can potentially destroy the translation reading frame, introduce transcription termination signals, affect the mRNA stability, and so on. Many transposons and the sites into which they insert have been isolated using recombinant DNA techniques and have been extensively characterized. These studies have revealed many interesting features about the mechanisms of transposition and the nature of genes located within transposons.

Transposons vary tremendously in length. Some are a few thousand base pairs and contain only two or three genes; others are many thousands of base pairs long, containing several genes. Several small transposons can occur within a large transposon. All active transposons contain at least one gene that codes for a **transposase**, an enzyme required for the transposition event. Often they contain genes that code for resistance to antibiotics or heavy metals. Most transpositions involve generation of an addition copy of the transposon and insertion of this copy into another location. The original transposon copy is the same after the duplication as before; that is, the donor copy is unaffected by insertion of its duplicate into the recipient site. Transposons contain short inverted **terminal repeat sequences** that are essential for the insertion mechanism, and in fact these inverted repeats are often used to define the two boundaries of a transposon. The multiple target sites into which most transposons can insert seem to be fairly random in sequence; other transposons have a propensity for insertion at specific "hot spots." The duplicated transposon can be located in a different DNA molecule than its donor. Frequently, transposons are found on plasmids that pass from one bacterial strain to another and are the source of a suddenly acquired resistance to one or more antibiotics by a bacterium (Clin. Corr. 19.1).

As with bacterial operons, each transposon or set of transposons has its own distinctive characteristics. The well-characterized transposon *Tn3* will be discussed as an example of their general properties.

***Tn3* Transposon Contains Three Structural Genes**

The **transposon *Tn3*** has been cloned using recombinant DNA techniques and its complete sequence determined. It contains 4957 base pairs including 38 base pairs at one end that occur as an inverted repeat at the other end (Figure 19.17). Three genes are present in *Tn3*. One gene codes for the enzyme β -lactamase, which hydrolyzes ampicillin and renders the cell resistant to this antibiotic. The other two genes, *tnpA* and *tnpR*, code for a transposase and a repressor protein, respectively. The transposase has 1021 amino acids and binds to single-stranded DNA. Little else is known about its action, but it is thought

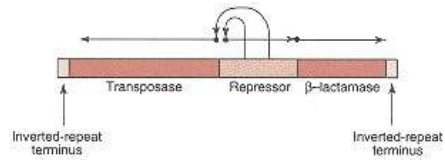

Figure 19.17

Functional components of the transposon *Tn3*.

Genetic analysis shows there are at least four kinds of regions: the inverted repeat termini; a gene for the enzyme β -lactamase, which confers resistance to ampicillin and related antibiotics; a gene encoding an enzyme required for transposition (transposase); and a gene for a repressor protein that controls transcription of genes for transposase and for repressor itself. The horizontal arrows indicate direction in which DNA of various regions is transcribed.

Redrawn from Cohen, S. N., and Shapiro, J. A. *Sci. Am.* 242:40, 1980. W. H. Freeman and Company, Copyright © 1980.

to recognize the repetitive ends of the transposon and to participate in the cleavage of the recipient site into which the new transposon copy inserts. The *tnpR* gene product is a protein of 185 amino acids. In its role as a repressor it controls transcription of both the transposase gene and its own gene. The *tnpA* and *tnpR* genes are transcribed divergently from a 163 base pair control region located between the two genes that is recognized by the repressor. The *tnpR* product also participates in the recombination process that results in the insertion of the new transposon. Transcription of the ampicillin-resistance gene is not affected by the *tnpR* gene product.

Mutations in the transposase gene generally decrease the frequency of *Tn3* transposition, demonstrating its direct role in the transposition process. Mutations that destroy the repressor function of the *tnpR* product cause an increased frequency of transposition. These mutations derepress the *tnpA* gene, resulting in more molecules of the transposase, which increases the formation of more transposons. They also derepress the *tnpR* gene but, since the repressor is inactive, this has no effect on the system.

When a transposon, containing its terminal inverted repeats, inserts into a new site, it generates short (5–10 bp) direct repeats of the sequences at the recipient site that flank the new transposon. This is due to the mechanism of recombination that occurs during the insertion process (Figure 19.18). The first step is the generation of staggered nicks at the recipient sequence. These staggered single-strand, protruding 5' ends then join covalently to the inverted repeat ends of the transposon. The resulting intermediate resembles two replicating forks pointing toward each other and separated by the length of the transposon. The replication machinery of the cell fills in the gaps and continues the divergent elongation of the two primers through the transposon region. This ultimately results in two copies of the transposon sequence. Reciprocal recombination within the two copies regenerates the original transposon copy at its original position and completes the process of forming a new copy at the recipient site that is flanked by direct repeats of the recipient sequence.

The practical importance of transposons located on plasmids has taken on increased significance for the use of antibiotics in treatment of bacterial infections. Plasmids that have not been altered for experimental use in the laboratory usually contain genes that facilitate their transfer from one bacterium to another. As the plasmids transfer (e.g., between different infecting bacterial strains), their transposons containing **antibiotic-resistance genes** are moved into new bacterial strains. Once inside a new bacterium, the transposon can be duplicated onto the chromosome and become permanently established in that cell's lineage.

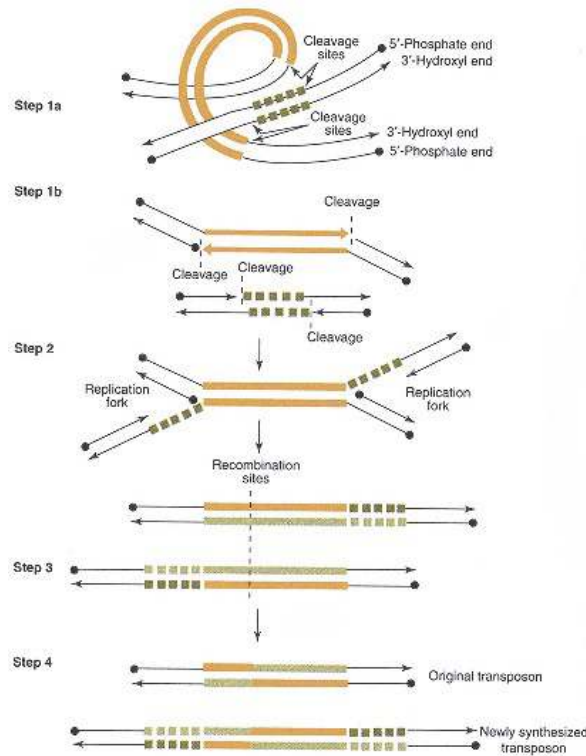

Figure 19.18

Proposed molecular pathway for transposition and chromosome rearrangements.

Donor DNA, including the transposon, shown in red, recipient DNA contains small light green. The pathway has four steps, beginning with staggered, single-strand cleavages (Step 1a) at each end of the transposable element and at each end of the "target" nucleotide sequence to be duplicated. The cleavages expose (Step 1b) the DNA strand ends involved in the next step: the joining of DNA strands from donor and recipient molecules in such a way that the double-stranded transposable element has a DNA replication fork at each end (Step 2). DNA synthesis (Step 3) replicates transposon (red bars) and target sequence (light green squares), accounting for the observed duplication. This step forms two new complete double-stranded molecules; each copy of the transposable element joins a segment of the donor molecule and a segment of the recipient molecules. (Copies of the element serve as linkers for the recombination of two unrelated DNA molecules.) In the final Step 4, reciprocal recombination between copies of the transposable element inserts the element at a new genetic site and regenerates the donor molecule.

Redrawn from Cohen, S. N., and Shapiro, J. A. *Sci. Am.* 252:40, 1980. W. H. Freeman and Company, Copyright © 1980.

The result is that more and more pathogenic bacterial strains become resistant to an increasing number of antibiotics.

19.7—

Inversion of Genes in *Salmonella*

A different mechanism of differential gene regulation has been discovered for one set of genes in *Salmonella*. Similar control mechanisms exist for the expression of other genes in other prokaryotes (e.g., a bacteriophage called λ).

Bacteria move by waving their **flagella** that are composed predominantly of subunits of a protein called flagellin. Many *Salmonella* species possess two different flagellin genes and express only one of these genes at a time. Bacteria are said to be in phase 1 if they are expressing the H1 flagellin gene and in phase 2 if they are expressing the H2 flagellin gene. A bacterial clone in one phase switches to the other phase about once every 1000 divisions. This switch is called **phase variation**, and its occurrence is controlled at the level of transcription of *H1* and *H2* genes.

Organization of the flagellin genes and their regulatory elements are shown in Figure 19.19. A 995-bp segment of DNA flanked by 14-bp repeats is adjacent to the *H2* gene and a *rhl* gene that codes for a repressor of *H1*. The *H2* and

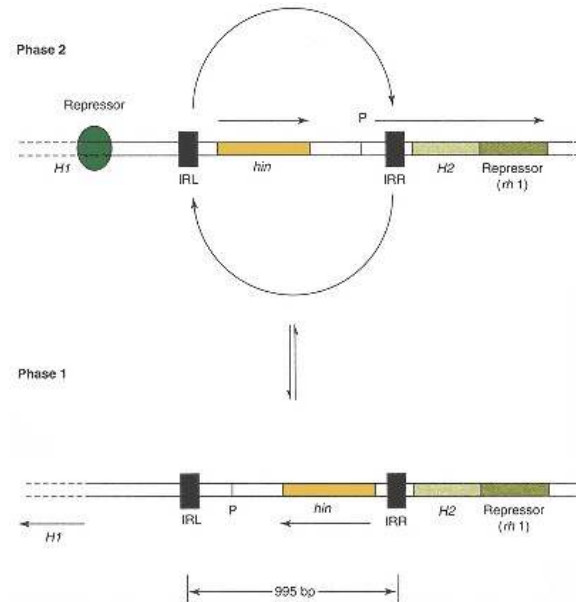

Figure 19.19
 Organization of the flagellin genes of *Salmonella*.
 Orientation of a 995-bp DNA segment flanked by 14-bp inverted repeats (IRL and IRR) controls the expression of *H1* and *H2* flagellin genes. In phase 2, transcription initiates at promoter P within the invertible segment and continues through *H2* and *rh1* genes. In phase 1, the orientation is reversed so that transcription of *H2* and *rh1* genes does not occur.

rhl genes are coordinately transcribed. Therefore, when *H2* is expressed, the repressor is also made and turns off *H1* expression. When *H2* protein and the repressor are not made, the *H1* gene is derepressed and *H1* synthesis occurs.

The promoter for the operon containing *H2* and *rhl* lies near one end of the 995-bp segment, just inside one copy of the 14-bp repeats. This segment can undergo inversions between the 14-bp repeats. In one orientation of the segment, the promoter is upstream of the *H2*–*rhl* transcription unit; in the other orientation it points toward the opposite direction so that *H2* and *rhl* are not transcribed. In addition to containing this promoter, the invertible segment of DNA possesses the *hin* gene whose product is an enzyme that catalyzes the inversion event itself. The *hin* gene seems to be transcribed constitutively at a low rate. Mutations in *hin* reduce the rate of inversion by 10,000-fold. Therefore phase variation is controlled by physical inversion of the segment of DNA that removes a promoter from its position in front of the *H2*–*rhl* operon. When the promoter is in the opposite direction, it presumably still initiates transcription, but the fate of that RNA is unknown. It does not initiate transcription of the *H1* that maps in this direction. That gene apparently has its own promoter controlled directly by the *rhl* repressor.

Inversion of the *hin* segment probably occurs via recombination between the 14-bp inverted repeats that is similar to recombination events involved in the transposition of a transposon. In fact, transposons do invert relative to their flanking sequences in a fashion exactly analogous to the *hin* inversion. Furthermore, the amino acid sequence of the *hin* product shows considerable similarity to that of the *tnpR* product of the *Tn3* transposon, which participates in the integration of the transposon into a new site. Thus it is possible, and even likely, that the two processes are evolutionarily related.

19.8—

Organization of Genes in Mammalian DNA

The past 20 years have seen a virtual explosion of new information about the organization, structure, and regulation of genes in eukaryotic organisms. The reason for this enormous increase in our knowledge about eukaryotic genes has been the concurrent development of recombinant DNA techniques and DNA sequencing techniques (Chapter 18). Experiments undreamed of a few years ago are now routine accomplishments.

The human haploid genome contains 3×10^9 bp of DNA, about 1000 times more DNA than the *E. coli* chromosome. All available evidence suggests that each of the 23 haploid chromosomes in the human genome has a single unique DNA molecule. Since the distance between two adjacent base pairs is 3.4×10^{-10} meters (3.4 Å), if these 23 human chromosomal DNA molecules were stretched out end-to-end, they would extend about 1 meter. Each mammalian cell contains virtually a complete copy of this genome, and all except the haploid germline cells contain two copies.

Different types of mammalian cells express widely different proteins even though each contains the same complement of genes. In addition, widely different patterns of protein synthesis occur at different developmental stages of the same type of cells. Therefore extremely intricate and complicated mechanisms of regulation for these genes must exist, and, in fact, these mechanisms are not understood for even one mammalian gene to the extent that they are understood for many bacterial operons. Despite the great advances of the past 20 years, our understanding of gene regulation in mammals, and indeed all eukaryotes, remains fragmentary at best and probably is still very naive.

Only a Small Fraction of Eukaryotic DNA Codes for Proteins

It was appreciated even before the advent of recombinant DNA methodology that eukaryotic cells, including mammalian cells, contain far more DNA than seems necessary to code for all of the required proteins. Furthermore, organisms that appear rather similar in complexity can have a several-fold difference in cellular DNA content. A housefly, for example, has about six times the cellular DNA content of a fruitfly. Some plant cells have almost ten times more DNA than human cells. Therefore DNA content does not always correlate with the complexity and diversity of functions of the organism.

It is difficult to obtain an accurate estimate of the number of different proteins, and therefore genes, in a mammalian cell or in the entire mammalian organism. However, nucleic acid hybridization procedures indicate that a maximum of 5000–10,000 different mRNA species may be present in a mammalian cell at a given time. Most of these mRNAs code for proteins that are common to many cell types. Therefore a generous estimate is that there are approximately 100,000 genes for the entire mammalian genome. If the average coding sequence is 1500 nucleotides (specifying a 500 amino acid protein), this accounts for 5% of the mammalian genome. DNA regulatory elements, repetitive genes for rRNAs, and so on may account for another 5–10%. However, as much as 85–90% of the mammalian genome may not have a direct genetic function. This remarkable conclusion is in contrast to the bacterial genome in which virtually all of the DNA is consumed by genes and their regulatory elements.

Eukaryotic Genes Usually Contain Intervening Sequences (Introns)

As discussed in Chapter 16, coding sequences (**exons**) of eukaryotic genes are frequently interrupted by intervening sequences or **introns** that do not code for a product. These introns are transcribed into a **precursor RNA** species found in the nucleus and are removed by **RNA splicing** events during the processing of the nuclear precursor RNA to the mature mRNA in the cytoplasm.

The number and length of the introns in a gene can vary tremendously. Histone genes and interferon genes lack introns; they contain a continuous coding sequence for the protein as do bacterial genes. The mammalian collagen gene, on the other hand, has more than 50 different introns that collectively consume 90% of the gene. The largest human gene discovered to date is 2400 kb, or more than half the size of the entire *E. coli* genome of 4000 kb. This gene contains 79 introns of about 30-kb average size and encodes a 427-kDa muscle protein called **dystrophin** (Figure 19.20). Despite the fact that dystrophin is a very large protein, the dystrophin gene's introns consume more than 99% of the gene's length. Mutations in this huge dystrophin gene are responsible for **Duchenne/Becker muscular dystrophy** (see Clin. Corr. 19.2). On the basis of the many mammalian genes analyzed to date, it appears that most have three or four introns and that the presence of 50 or more introns in a single gene represents an extreme case. Nevertheless, introns of genes clearly account for some of the "excess" DNA present in eukaryotic genomes.

The significance of introns and their potential biological functions, if any, are the subject of much speculation and experimentation. In a few genes, including those for the **α - and β -globin subunits** of hemoglobin (see below), introns separate the coding regions for functional domains of the protein. In many other genes, however, no obvious correlation exists between the intron positions of a gene and the three-dimensional domains of its encoded protein. In fact, the number of introns in a given gene sometimes is not the same in different mammalian species, or even within a single species. For example, the rat haploid genome has two insulin genes, one with two introns and one with a single intron. The haploid genomes of other rodents have a single insulin gene with two introns.

One widely quoted hypothesis for the possible function of introns is that they may have served to facilitate the mixing and matching of exons during the course of evolution so that occasionally new protein-encoding genes are created, which provide a selective advantage for the organism. Some circumstantial evidence exists to support this possibility. For example, **chicken collagen** has a larger number of repeating Gly-X-Y triplets and most of the exons in its genes are multiples of 9 bp (i.e., 45, 54, 99, 108, or 162 bp per exon) beginning with a glycine codon and ending with a Y codon. Thus the collagen gene may have evolved via multiple duplications of an exon-intron unit. Genes of unicellular lower eukaryotes, such as **yeast**, have either no introns or a small number of introns that tend to be short compared to introns of higher eukaryotes. Perhaps these lower eukaryotes, which reproduce much faster than do higher organisms, have to be more efficient in their DNA and RNA metabolism and

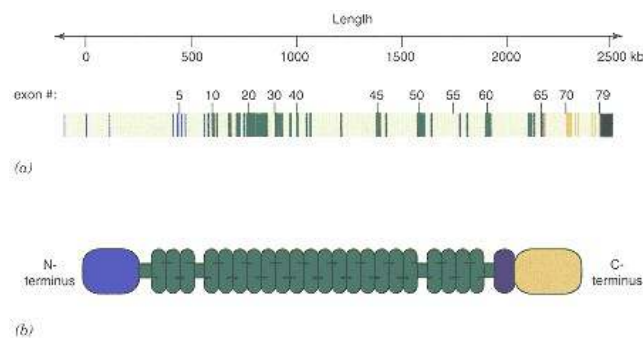

Figure 19.20
Human dystrophin gene and its protein.

(a) The 79 exons (dark thin vertical lines) of human dystrophin gene span 2.4×10^6 bp (2400 kb), more than one-half the length of the *E. coli* genome. The average dystrophin exon is 140 bp and the average dystrophin intron (light gray background regions) is more than 30,000 bp.

(b) Dystrophin (427 kDa) has 3685 amino acids. It contains an actin-binding domain blue, 24 tandem repeats of about 109 amino acids that likely form a rod-like domain (green), a cysteine-rich domain (purple), and a C terminus that may associate with the membrane (red).

Redrawn from Ahn, A. H., and Kunkel, L. M. *Nature Genetics* 3:283, 1993.

CLINICAL CORRELATION 19.2**Duchenne/Becker Muscular Dystrophy and the Dystrophin Gene**

Both Duchenne muscular dystrophy (DMD) and the milder Becker muscular dystrophy (BMD) are inherited as X-linked recessive diseases. They result in degenerative disorders of skeletal muscle and are the most common of all lethal neuromuscular genetic diseases, affecting 1 in 3500 males. They are associated with abnormally high levels of serum creatine kinase levels from birth. Although most afflicted males inherit the defect from their unaffected, heterozygous mother, 30% of the cases exhibit no previous family history and appear to be "spontaneous" new mutations in the germline of either the mother or her parents. Both forms of muscular dystrophy are caused by defects in the dystrophin gene on the X chromosome. This gene is huge and complicated. It has 79 exons and spans 2.4×10^6 bp and encodes a membrane-associated cytoskeleton protein. Its expression is regulated in a cell-specific and developmentally controlled manner from at least five different promoters. Many mutations responsible for DMD and BMD are large deletions that remove one or more of the 79 exons, but the size of the deletion does not necessarily correlate with the severity of the disorder. In DMD patients, dystrophin is undetectable or absent, whereas in BMD patients, it is reduced or altered. Genetic, biochemical, and anatomical studies suggest that dystrophin may serve diverse roles in many other tissues besides muscle. It is hoped that future studies of dystrophin may lead to an understanding of the cause and perhaps a rational treatment for muscular dystrophy.

Ahn, A. H., and Kunkel, L. M. The structural and functional diversity of dystrophin. *Nature Genetics* 3:283, 1993.

cannot tolerate large numbers of large introns. In many ways, however, introns remain as big an enigma as when first discovered.

19.9—**Repetitive DNA Sequences in Eukaryotes**

Another curiosity about mammalian DNA, and the DNA of most higher organisms, is that, in contrast to bacterial DNA, it contains repetitive sequences in addition to single copy sequences. This repetitive DNA falls into two general classes—**highly repetitive** simple sequences and **moderately repetitive** longer sequences of several hundred to several thousand base pairs.

Importance of Highly Repetitive Sequences Is Unknown

The highly repetitive sequences range from 5 to about 300 bp and occur in tandem. Their contribution to the total genomic size is extremely variable, but in most organisms they are repeated millions of times and in a few organisms they consume 50% or more of the total DNA. These highly repetitive sequences are sometimes called **satellite DNAs** because when total DNA isolated from a eukaryote is sheared slightly and centrifuged in a CsCl gradient, they can be separated as "satellites" of the bulk of the DNA on the basis of their differing buoyant densities. They are concentrated primarily at the **centromeres** and to a lesser extent at **telomeres** (i.e., ends of chromosomes). Figure 19.21 shows the three main repeat units of the highly repetitive sequences at the chromosomal centromeres of the fruitfly, *Drosophila virilis*. Repeats of these three sequences of 7 bp comprise 41% of the organism's DNA. They are obviously related evolutionarily since two of the repeats can be derived from the third by a single base pair change. Relatively little transcription occurs from the highly repetitive sequences, and their biological importance remains, for the most part, a mystery (see Clin. Corr. 19.3). Those repetitive sequences that occur near the telomeres are probably required for the replication of the ends of the linear DNA molecules. The ones at the centromeres might play a structural role since these regions attach to the **microtubules** of the **mitotic spindle** during chromosome pairing and segregation in mitosis and meiosis. Highly repetitive sequences occur in human DNA at both centromeres and telomeres but their repeat units at centromeres are longer and more variable in sequence than those of *Drosophila virilis* shown in Figure 19.21.

A Variety of Repeating Units Are Defined as Moderately Repetitive Sequences

The moderately repetitive sequences consist of a large number of different sequences repeated to such different extents that it is somewhat misleading to group them under one heading. Some are clustered in one region of the genome;

Genome (%)	Number of copies in genome	Predominant sequence
25	1×10^7	5' -ACAAACT- 3' 3' -TGTTTGA- 5'
8	3.6×10^6	5' -ATAAACT- 3' 3' -TATTTGA- 5'
8	3.6×10^6	5' -ACAAATT- 3' 3' -TGTTTAA- 5'

Figure 19.21

Main repeat units of repetitive sequences of the fruitfly *Drosophila virilis*.

Approximately 41% of genomic DNA of *Drosophila virilis* is comprised of three related repeat sequences of 7 bp. The bottom two sequences differ from the top sequence at one base pair shown in box.

CLINICAL CORRELATION 19.3

Huntington's Disease and Trinucleotide Repeat Expansions

Huntington's disease is an autosomal dominant neurodegenerative disorder characterized by increasing behavioral disturbance, involuntary movements, cognitive impairment, and dementia. It can be inherited from either parent. Disease onset often does not occur until age 40 and death results 10–15 years later from aspiration, trauma, or pneumonia. The defective gene on chromosome 4 responsible for the disease is dominant over the normal gene, suggesting the defect causes the gene's protein to gain a deleterious function. This gene encodes a large protein called "huntingtin" that contains 3144 amino acids found in many tissues but whose function is unknown. Near the beginning of the gene is a run of CAGs that encodes a polyglutamine tract in huntingtin. The length of this polyglutamine tract is 11–34 in normal individuals and 37–121 in Huntington's disease patients. The larger the number of repeats, the sooner the onset of the disease. Furthermore, the child of a parent with an abnormally large number of repeats will often have an even larger number of repeats, resulting in a "genetic anticipation" of the disease. Neither the cause of the trinucleotide repeat expansions nor the abnormal function of huntingtin with an expanded polyglutamine is known. However, at least seven other neurological disorders are caused by trinucleotide repeat expansions in other genes, including X-linked spinal and bulbar muscular atrophy, fragile X syndrome, and myotonic dystrophy. The reason for this neuronal toxicity is currently the subject of intense research. These diseases can be diagnosed molecularly by tests based on the polymerase chain reaction.

La Spada, A. R., Paulson, H. L., and Fischbeck, K. H. Trinucleotide repeat expansion in neurological disease. *Ann. Neurol.* 36:814, 1994.

many are scattered throughout the DNA. Some moderate repeats are several thousand base pairs in length; other repeats come in a unit size of only a hundred base pairs. Sometimes the sequence is highly conserved from one repeat to another; in other cases, different repeat units of the same basic sequence will have undergone considerable divergence. Two examples from the human genome will be described.

In mammalian cells the 18S, 5.8S, and 28S rRNAs are transcribed as a single precursor transcript that is subsequently processed to yield the mature rRNAs. In humans the length of this precursor is 13,400 nucleotides, about one-half of which is comprised of the three mature rRNA sequences. Several **posttranscriptional cleavage** steps remove the extra sequences from the ends and the middle of the precursor RNA, releasing the mature rRNA species. DNA that contains the rRNA genes is a moderately repetitive sequence of about 43,000 bp of which 30,000 bp are nontranscribed spacer DNA. Clusters of this entire DNA unit occur on five chromosomes. In total, there are about 280 repeats of this unit, which comprise about 0.3% of the total genome (Figure 19.22). The 5S rRNA genes are repeated about 2000 times but in different clusters. The need for so many rRNA genes is because the rRNAs are structural RNAs. Each transcript from the gene yields only one copy of each rRNA molecule. On the other hand, each mRNA molecule derived from a ribosomal protein gene can be translated repeatedly to give many protein molecules.

In contrast to tandemly repetitive rRNA genes clustered at a few chromosomal sites, most moderately repetitive sequences in the mammalian genome do not code for a stable gene product and are interspersed with nonrepetitive sequences that occur only once or a few times in the genome. The average size of these interspersed repetitive sequences is about 300 bp. Almost one-half of these sequences are members of a general family of moderately repetitive sequences called the **Alu family** because they can be cleaved by the restriction enzyme *AluI*. There are about 300,000 Alu sequences scattered throughout the human haploid genome (on the high side of being moderately repetitive). Individual members are related in sequence but are frequently not identical. Their average homology with a consensus sequence is about 87%.

Additional repeat symmetry occurs within an Alu sequence. The sequence appears to have arisen by tandem duplication of a 130-bp sequence with a 31-bp insertion in one of the two adjacent repeats. Some members of the Alu family resemble bacterial transposons in that they are flanked by short direct repeats. This does not prove that an Alu repeat can be duplicated and transposed to another site like true transposons, but it suggests that such events may occur.

The biological function of Alu sequences is unknown. One suggestion is that they serve as multiple origins for the DNA replication during S phase, but more sequences occur than seem necessary for this function. Alu sequences appear in the introns of some genes and are transcribed as part of large precursor RNAs in which the Alu sequences are removed during RNA splicing. Other Alu sequences are transcribed into small RNA molecules whose function is unknown. All mammalian genomes appear to have a counterpart to the human interspersed Alu sequence family although the size of the repeat and its distribution can vary considerably between species.

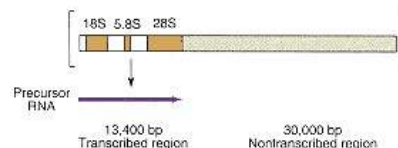

Figure 19.22

Repetitive sequence in human DNA for rRNA.

In human cells a single transcription unit of 13,400 nucleotides is processed to yield the 18S, 5.8S, and 28S rRNAs. About 280 copies of the corresponding rRNA genes are clustered on five chromosomes. Each repeat contains a nontranscribed spacer region of about 30,000 bp.

19.10— Genes for Globin Proteins

Recombinant DNA Technology Has Been Used to Clone Genes for Many Eukaryotic Proteins

Many mammalian structural genes that have been cloned by recombinant DNA techniques specify proteins that either occur in large quantity in a specific cell type, such as the **globin subunits** in the red blood cell, or after induction of a specific cell type, for example, **growth hormone** or **prolactin** in the pituitary. As a result, more is known about the regulation of these genes than of other genes whose protein products occur at lower levels in many different cell types. Increasingly, however, information is being gained about mammalian genes for "rare" proteins with low abundances in the cell. We will discuss organization, structure, and regulation of the related members of two gene families—the genes for the globin subunits and the growth hormone-like proteins.

The first step in characterizing a eukaryotic gene is usually to use recombinant DNA techniques to clone a **complementary DNA** (cDNA) copy of that gene's corresponding mRNA. In fact, this is the reason that the most extensively studied mammalian genes code for the major proteins of specific cells; a large fraction of the total mRNA isolated from these cells codes for protein of interest. **Hemoglobin** is comprised of two **α -globin** subunits (141 amino acids) and two **β -globin** subunits (146 amino acids). Almost all of the mRNA isolated from immature red cells (**reticulocytes**) codes for these two subunits of hemoglobin.

There are several experimental variations of the procedure for synthesizing double-stranded cDNA copies of isolated mRNA *in vitro*. As discussed in Chapter 18, many different plasmid and viral DNA vectors are available for cloning the (passenger) cDNA molecules. Figure 19.23 shows one protocol for constructing and cloning cDNAs prepared from mRNA of reticulocytes.

A synthetic **oligonucleotide** composed of 12–18 residues of deoxythymidine is hybridized to the 3'-polyadenylate tail of the mRNA and serves as a primer for **reverse transcriptase**, an enzyme that copies an RNA sequence into a DNA strand in the presence of the four deoxynucleoside triphosphates. The resulting RNA–DNA heteroduplex is treated with NaOH, which degrades the RNA strand and leaves the DNA strand intact. The 3' end of the remaining DNA strand can then fold back and serve as a primer for initiating synthesis of a second DNA strand at random locations by reverse transcriptase, the same enzyme used to synthesize the first strand. The hairpin loop is then nicked by **S1 nuclease**, an enzyme that cleaves single-stranded DNA but has little activity against double-stranded DNA. The ends of the resulting double-stranded cDNAs are ligated to small synthetic "linker" oligonucleotides that contain the recognition site for the restriction enzyme *Hind*III.

Digestion of the resulting DNA with *Hind*III generates DNA fragments that contain *Hind*III-specific ends. These fragments can be ligated into the *Hind*III site of a plasmid, and when the resulting circular "recombinant" DNA species are incubated with *E. coli* in the presence of cations such as calcium or rubidium, a few molecules will be taken up by the bacteria. The incorporated **recombinant DNAs** will be replicated and maintained in the progeny of the original transformed bacterial cell.

The collection of cloned cDNAs synthesized from the total mRNA in a given tissue or cell type is called a cDNA library, for example, a liver cDNA library or a reticulocyte cDNA library. Since most of the mRNAs of a reticulocyte code for either α - or β -globin, it is relatively easy to identify these globin cDNAs in a reticulocyte cDNA library using procedures discussed in Chapter 16. Once identified, the nucleotide sequences of the cDNAs can be determined to confirm that they do code for the known amino acid sequences of the α - and β -globins. In cases in which the amino acid sequence of the protein is not known, other procedures (sometimes immunological) are used to confirm the identification of the desired cDNA clone.

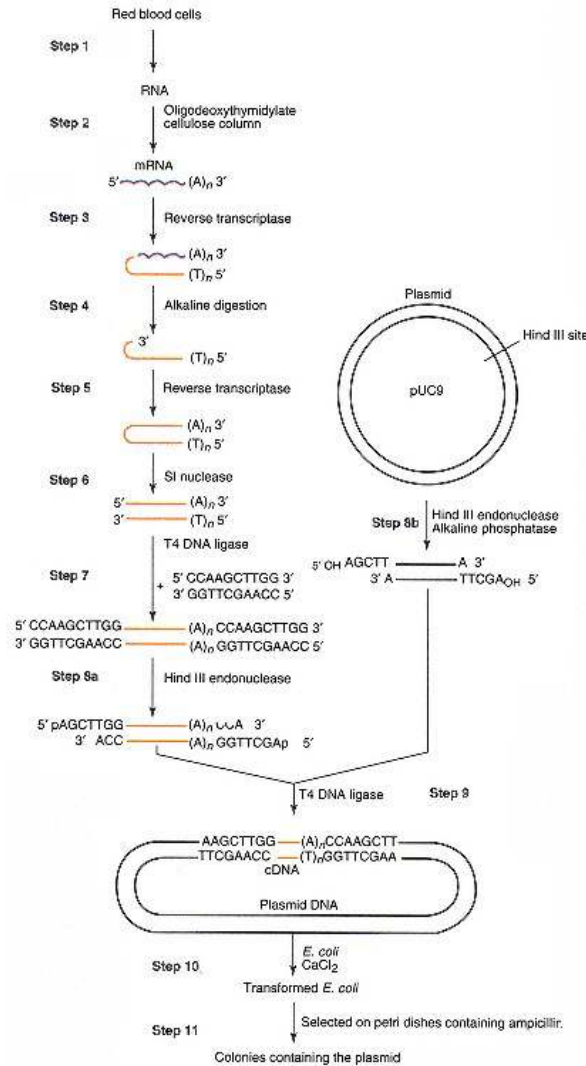

Figure 19.23

Cloning of globin cDNA.

- Step 1: Total RNA is extracted from red blood cells.
- Step 2: The total RNA is passed through an oligodeoxythymidylate cellulose column, which separates polyadenylated mRNA (see Chapter 15) from rRNA and tRNA. Polyadenylated mRNA of red blood cells contains predominantly hemoglobin mRNA.
- Step 3: The mRNA is reverse-transcribed into first-strand cDNA using reverse transcriptase, the viral enzyme that synthesizes DNA from RNA templates (see Chapter 15).
- Step 4: The mRNA is hydrolyzed with alkali whereas the DNA is unaffected.
- Step 5: The single-stranded cDNA is converted into double-stranded DNA by reverse transcriptase.
- Step 6: The resulting double helix contains a single-stranded hairpin loop that is removed by S1 nuclease, an enzyme that hydrolyzes single-stranded DNA.
- Step 7: The cDNA is now a double helix with A-T base pairs at one end. To generate cohesive ends for the ligation of this cDNA into a plasmid, a chemically synthesized decanucleotide is attached to both ends using DNA ligase from bacteriophage T4. This decanucleotide contains the sequence recognized by *Hind*III restriction nuclease.
- Step 8a: Treatment with *Hind*III produces a cDNA molecule with *Hind*III cohesive ends.
- Step 8b: The plasmid pUC9, which contains an ampicillin-resistance gene, is cleaved with *Hind*III and exposed to bacterial alkaline phosphatase, an enzyme that removes the phosphates from the cleaved 5'-terminal ends of the plasmids at the *Hind*III site. This prevents the cleaved plasmid from recircularizing without the insertion of the cDNA.
- Step 9: The linear plasmid and the cDNA molecules are mixed with T4 DNA ligase, and circular, dimeric, "recombinant" DNA molecules are formed.
- Step 10: This ligation mixture is used to transform *E. coli*.
- Step 11: Individual *E. coli* cells that take up the plasmid are selected by their ability to grow on ampicillin. The globin cDNA is confirmed by determining the nucleotide sequence of the small DNA fragment released from the plasmid DNA by *Hind*III; if the observed nucleotide sequences corresponded to those expected based on the known amino acid sequence of α - and β -globin, then the cDNA is identified.

Comparison of the α - and β -globin cDNA sequences with the corresponding globin genes, which have also been cloned using recombinant DNA techniques, reveals that all members of both sets of genes contain two introns at approximately the same positions relative to the coding sequences (Figure 19.24). The α (and α -like) genes have an intron of 95 bp between codons 31 and 32 and a second intron of 125 bp between codons 99 and 100. The β (and β -like) genes have introns of 125–150 bp and 800–900 bp located between codons 30

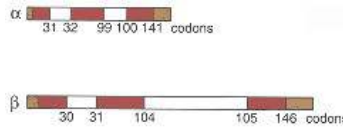

Figure 19.24

Structures of human globin genes.

Structures for the human α -like and β -like globin genes are drawn to approximate scale. Red rectangles and open rectangles represent exons and introns, respectively. Gray rectangles indicate the (5') upstream and (3') downstream nontranslated regions in the DNA. The α -like globin genes contain introns of approximately 95 and 125 bp, located between codons 31 and 32, and 99 and 100, respectively. The β -like globin genes contain introns of approximately 125–150 and 800–900 bp, located between codons 30 and 31, and 104 and 105, respectively.

and 31 and codons 104 and 105, respectively. Introns separate the coding sequences of different functional domains of a few proteins, including the globins. The coding region between the two globin introns specifies the region of the protein that interacts with the heme group. The final coding region (after the second intron) encodes the region of the protein that serves as the interface with the opposite subunit, that is, the α -globin- β -globin interaction. This separation of the coding sequences for functional domains of a protein by introns is not a general phenomenon, however. The positioning of introns in other genes seems to bear little relationship to the final three-dimensional structure of the encoded protein.

Different α -like and β -like globin subunits are synthesized at different developmental stages. These developmentally distinct subunits have slightly different amino acid sequences and oxygen affinities but are closely related. In humans there are two α -like chains—that is, ζ , which is expressed in the embryo during the first 8 weeks, and α itself, which replaces ζ in the fetus and continues through adulthood. There are four β -like chains. Epsilon (ϵ) and γ are expressed in the embryo, γ in the fetus, and δ plus β in the adult.

Each of the different globin chains is coded by at least one gene in the haploid genome. The α -like genes are clustered on the short arm of human **chromosome 16**, and the β -like genes are clustered on the short arm of **chromosome 11**. The gene organization within these two clusters is shown in Figure 19.25. The genes within both clusters are positioned relative to one another in the order of both their transcriptional direction and their developmental expression; that is, 5'—embryonic—fetal—adult—3'.

The α -gene cluster spans about 28 kb and includes three functional genes and two **pseudogenes**. The functional genes are the embryonic ζ gene and two α genes, $\alpha 1$ and $\alpha 2$, that code for identical α -globin proteins but have different 3' untranslated regions. The two pseudogenes, αH and αA , occur between the ζ and $\alpha 1$ genes. They have sequences very similar to the functional genes, but various mutations prevent them from coding for an active globin subunit. Pseudogenes are common in eukaryotic genomes. They do not seem to be deleterious and probably arose via a duplication of a segment of DNA followed by mutations.

The β -gene cluster encompasses about 60 kb and has five active genes and one pseudogene. Of the five functional genes, two are for the γ subunit and specify proteins that differ only at position 136, which is a glycine in the G variant and an alanine in the A variant. Only a single haploid gene exists for the δ -, ϵ -, and β -globin subunits. Alu repetitive sequences and other moderately repetitive sequences are scattered between some genes of the α - and β -gene clusters.

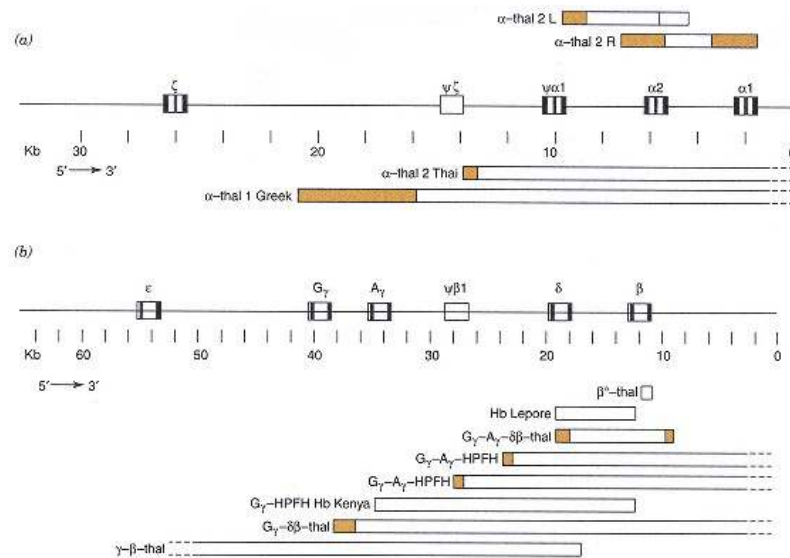

Figure 19.25

Gene organization for α -like and β -like genes of human hemoglobin.

(a) Linkage of human α -like globin genes on chromosome 16 and locations of some known deletions within α -like gene cluster. The positions of adult ($\alpha 1$, $\alpha 2$) and embryonic (ϵ) α -like globin genes and two pseudogenes (ζ , $\psi 1$) are shown. Pseudogenes have mutations that prevent the formation of functional proteins from them. For each functional gene the black and white boxes represent exons and introns, respectively. Horizontal arrow indicates the direction of transcription of each gene. The locations of DNA deletions associated with the leftward and rightward types of α -thalassemia 2 are indicated above the linkage map by the rectangles labeled α -thal 2 L and α -thal 2 R. Red areas at the ends of these rectangles indicate the deletion end points have not been mapped precisely. Locations of deletions associated with two cases of α -thalassemia 1 (α -thal 1 Thai and α -thal 1 Greek) are shown below the linkage map. The light green areas and dashed lines indicate uncertainties in the left and right endpoints, respectively, of each deletion.

(b) Linkage of the human β -like globin genes on chromosome 11 and locations of deletions within the β -like gene cluster. The positions of the embryonic (ϵ), fetal (G_γ , A_γ), and adult (δ , β) β -like globin genes and one β -like pseudogene ($\psi\beta 1$) are shown. For each functional gene the black and white boxes represent the exons and introns, respectively. The locations of various known deletions within the gene cluster are shown below the map. Open rectangles represent areas known to be deleted; Red areas and dashed lines indicate that the endpoints of the deletion have not been determined. For $\delta\beta$ -thalassemia and hereditary persistence of fetal hemoglobin (HPFH), the type of fetal globin chain produced (G_γ and/or A_γ) is indicated in the name of each syndrome (e.g., in (G_γ - A_γ - $\delta\beta$ -thalassemia, the G_γ and A_γ -globin chains are produced).

Redrawn from Maniatis, T., Fritsch, E. F. Lauer, J., and Lawn, R. M. *Annu. Rev. Genet.* 14:145, 1980. Copyright © 1980 by Annual Reviews, Inc.; and from Karlsson, S., and Nienhuis, A. W. *Annu. Rev. Biochem.* 54:1071, 1985. Copyright © 1985 by Annual Reviews, Inc.

Other mammalian species often have a different number of globin-like genes within the two clusters. For example, rabbits have only four β -like genes, goats have seven, and mice have as many as nine. Some of these additional genes are pseudogenes.

Many patients have been identified who have abnormalities in hemoglobin structure or expression. In many cases the precise molecular defect responsible for these abnormalities is known. The two that have been the most extensively studied are **sickle cell anemia** and a family of diseases collectively called **thalassemias**.

CLINICAL CORRELATION 19.4

Prenatal Diagnosis of Sickle Cell Anemia

Sickle cell anemia can be diagnosed from fetal DNA obtained by amniocentesis. This genetic disease is caused by a single base pair change that converts a glutamate to a valine in the sixth position of β -globin. In the normal β -globin gene, the sequence that specifies amino acids 5, 6, and 7 (Pro-Glu-Glu) is CCT-GAG-GAG. In a heterozygous carrier of sickle cell anemia, this sequence is CCT-GTG-GAG. An A in the middle of the sixth codon has been changed to a T. The restriction enzyme *Mst*II recognizes and cleaves the sequence CCT-GAG-G, which is present at this position in normal DNA but not the mutated DNA. Therefore digestion of fetal DNA with *Mst*II followed by the Southern blot technique (see p. 774) using β -globin cDNA as the radioactive probe reveals whether this restriction site is present in one or both allelic copies of the gene. If it is absent in both copies, the fetus will be homozygous for the sickle trait; if it is missing in only one copy, the fetus will be heterozygous for the trait. The difference in restriction enzyme patterns observed between individuals is often called a restriction fragment length polymorphism (RFLP). Polymerase chain reaction methods can be used to amplify the desired chromosomal DNA region and greatly speed up the RFLP analysis.

Other methods are necessary if the disease mutation does not cause a change in a restriction site or is not linked to an RFLP. For example, the DNA carrying the mutation can be amplified by the polymerase chain reaction, and the alleles can be detected by hybridization with allele-specific oligonucleotides (ASOs). Two ASOs differing at usually one nucleotide are made so that one ASO matches the normal allele perfectly while the other ASO matches the abnormal allele. Hybridization conditions are used in which only the ASO matching perfectly remains bound to the DNA.

Sickle Cell Anemia Is Due to a Single Base Pair Change

A **single base pair change** within the coding region for the β -globin subunit is responsible for sickle cell anemia. This occurs in the second position of the codon for position 6 of the β chain. In the mRNA the codon, GAG, which specifies glutamate in normal β chains, is converted to GUG, which specifies valine. The resultant hemoglobin, called **hemoglobin S** (HbS), has altered surface charge properties (because the negative charge of glutamate has been replaced by valine's nonpolar group), which is responsible for clinical symptoms. This mutation occurs mainly in peoples of equatorial African descent and is the classic example of a mutation that confers an adaptive advantage as well as a **genetically inheritable disease**. Individuals heterozygous for HbS are resistant to infection by the parasites that cause **malaria** but do not acquire the symptoms of sickle cell disease exhibited by individuals homozygous for HbS. The life cycle of the malaria-causing parasites includes an obligatory stage that occurs inside erythrocytes and they do not survive in erythrocytes containing HbS. Carriers of the mutation can be detected by restriction enzyme digestion of a sample of the potential carrier's DNA followed by **Southern hybridization** technique with the β -globin cDNA as described in Clin. Corr. 19.4.

Thalassemias Are Caused by Mutations in Genes for the α or β Subunits of Globin

Thalassemias are a family of related genetic diseases that occur in people who frequently originate from the Mediterranean areas and Asia. If there is a reduced synthesis or a total lack of synthesis of α -globin mRNA, the disease is classified as **α -thalassemia**; if the β -globin mRNA level is affected, it is called **β -thalassemia**. Thalassemias can be due to the deletion of one or more globin-like genes in either of the globin gene clusters or be caused by a defect in the transcription or processing of a globin gene's mRNA.

Since each chromosome 16 contains two adjacent α -globin genes, a normal diploid individual has four copies of this gene. α -Thalassemic patients may be missing one to four α -globin genes. The condition in which one α -globin gene is missing is referred to as **α -thal 1**; when two α -globin genes are gone, the condition is **α -thal 2**. In both cases the individuals can experience mild to moderate anemia but may have no additional symptoms. When three α -globin genes are missing, many more β -globin molecules are synthesized than α -globin molecules, resulting in the formation of a globin tetramer of four β -globins, which causes **HbH disease** and accompanying anemia. When all four α -globin genes are absent, the disease **hydrops fetalis** occurs, which is fatal at or before birth. Some chromosomal deletions that have been mapped in the α -globin gene cluster are shown in Figure 19.25.

β -Thalassemias also exhibit different degrees of severity and can be caused by a variety of defects or deletions. In one case the β -globin gene is present but has undergone a mutation in the codon 17, which generates a termination codon. In another case the β -globin gene is transcribed in the nucleus but no β -globin mRNA occurs in the cytoplasm. Thus a defect has occurred in the processing and/or transport of the primary transcript of the gene.

Other β -thalassemias are caused by deletions within the β -globin gene cluster on chromosome 11 (Figure 19.25). In some cases these deletions remove the DNA between two adjacent genes, resulting in a new fusion gene. For example, in the normal person the linked δ -globin and β -globin genes differ in only about 7% of their positions. In **Hb Lepore** a deletion has placed the front portion of the δ -globin gene in register with the back portion of the β -globin gene. From this fusion gene a new β -like globin is produced in which the N-terminal sequence of δ -globin is joined to the C-terminal sequence of β -globin. Several variants of Hb Lepore are known, and in each case the globin

CLINICAL CORRELATION 19.5

Prenatal Diagnosis of Thalassemia

If a fetus is suspected of being thalassemic because of its genetic background, recombinant DNA techniques can be used to determine if one or more globin genes are missing from its genome. Fetal DNA can easily be obtained (in relatively small quantities) from amniotic fluid cells aspirated early during the second trimester of pregnancy. Regions of interest are amplified from the fetal DNA by polymerase chain reactions and digested with restriction enzymes that divide the globin genes among restriction fragments of several hundred to 2000 base pairs. These fragments are separated by electrophoresis through an agarose gel and hybridized with radioactive cDNA for α - and/or β -globin using the Southern blot technique (see p. 774). If one or more globin genes are missing, the corresponding restriction fragment will not be detected or its hybridization to the radioactive cDNA probe will be reduced (in the case when only one of two diploid genes is absent).

Benz, E. J. The hemoglobinopathies. In: W. N. Kelly (Ed.), *Textbook of Internal Medicine*. Philadelphia: Lippincott, 1989, pp. 1423–1432.

product is a composite of the α and β sequence, but the actual fusion junction is different.

Another fusion β -like globin is **Hb Kenya**. This deletion results in a gene product that contains the N-terminal sequence of the γ -globin gene and the C-terminal sequence of the β -globin gene. Still another series of deletions has been found in which both the α - and β -globin genes are removed, causing HPFH (**hereditary persistence of fetal hemoglobin**). Frequently, there are no clinical symptoms of this condition because fetal hemoglobin ($\gamma_2\alpha_2$) continues to be synthesized after the time at which γ -globin gene expression is normally turned off (see Clin. Corr. 19.5.)

19.11—

Genes for Human Growth Hormone-Like Proteins

Human growth hormone (hGH, also called somatotropin) is a polypeptide of 191 amino acids. A larger precursor is synthesized in the somatotrophs of the anterior pituitary, and the mature form is secreted into the circulatory system. Growth hormone induces liver (and perhaps other) cells to produce other hormones called **somatomedins**, which are insulin-like growth factors that stimulate proliferation of mesodermal tissues such as bone, cartilage, and muscle. Infants with a deficiency in growth hormone become dwarfs, whereas those who produce too much become giants.

A closely related protein of 191 amino acids, having 85% homology with growth hormone, is human **chorionic somatomammotropin** (hCS, also called placental lactogen) synthesized in the placenta. The complete role of this hormone in normal fetal–maternal physiology is still unclear, but it participates in placental growth and contributes to mammary gland preparation for lactation during pregnancy.

The hormones hGH and hCS are examples of two very similar proteins that serve different biological functions and are synthesized in different tissues. It is to be expected that their genes also are closely related but expressed in a tissue-specific fashion. The genes for hGH and hCS are very similar and occur in the same region of chromosome 17 (Figure 19.26).

Five related genes comprise the human growth hormone gene family. They occur over a distance of about 55 kb and share a common structure of five exons and four introns, with the exon–intron boundaries always in the same locations. Alu repetitive sequences occur between some of the genes, as in the globin gene clusters. The order of the genes is 5' *hGH-N* *hCS-L*, *hCS-A*, *hGH-V*, *hCS-B* 3'. The first gene in this cluster, *hGH-N*, is expressed in the anterior

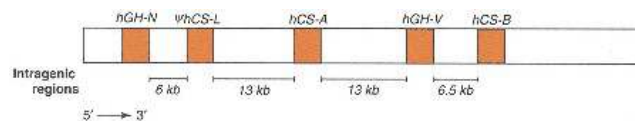

Figure 19.26

Organization of human growth hormone (*hGH*) gene family.

The five structural genes of this family occur as a linear array over about 55 kb on the long arm of chromosome 17. Two genes (*hGH-N* and *hGH-V*) code for growth hormone, two genes code for the closely related human chorionic somatomammotropin (*hCS-A* and *hCS-B*), and one gene appears to be a pseudogene (*hCS-L*). Only *hGH-N* is expressed in the pituitary; other genes are expressed in the placenta. The order of the genes in the array (red boxes) is 5' *hGH-N*, *hCS-L*, *hCS-A*, *hGH-V*, *hCS-B* 3', and all are transcribed in the same direction. Each gene has the same basic structure of five exons and four introns (not shown).

Redrawn from Chen, E. Y., Liao, Y. C., Smith, D. H., Barrera-Saldana, H. A. et al. *Genomics* 2:479, 1989.

pituitary, whereas the others are expressed in the placenta. The *hGH* and *hCS* genes have different sequences about 100 bp beyond their polyadenylation sites. The *hGH-N* gene codes for normal growth hormone of 22 kDa. Alternative splicing of intron 3 of this gene occurs in about 10% of the primary transcripts, giving rise to a 20-kDa version of growth hormone whose significance is not known. (See Chapter 16.) The *hGH-V* gene codes for a variant growth hormone that can be expressed in transgenic animals (see Section 19.14), but whose function in the placenta is unknown. The *hCS-A* and *hCS-B* genes specify the same mature hormone but are expressed at different levels in the placenta. The *hCS-L* pseudogene has a single base substitution at an exon-intron splice site that appears to prevent normal maturation of its primary transcript into mRNA.

Expression of *hGH* and *hCS* genes is under the regulation of other hormones. **Thyroxine** and **cortisol** stimulate increased transcription of these genes. In cultured rat pituitary tumor cells these hormones act in a synergistic fashion to induce growth hormone mRNA synthesis. Pituitary cells that have only about two molecules of growth hormone mRNA per cell can be stimulated to a level of 1000 growth hormone mRNA molecules per cell, a 500-fold increase comparable in magnitude to the induction of many bacterial operons.

Only some of the details by which thyroxine and cortisol stimulate this increased transcription are known. Their regulatory effect at the molecular level is clearly more complicated than is the control of bacterial operon transcription. Two promoter sites lie just upstream of *hGH-N* and a specific transcription factor, GHF-1 (also called Pit-1), contributes to this gene's pituitary-specific expression. GHF-1 belongs to a family of **homeodomain transcription factors** found in organisms as diverse as yeast and fruitflies. The regulatory hormones are transported into the nucleus and in association either with their receptors or with a binding protein, such as GHF-1, affect transcription initiation at *hGH-N*. Alternatively, these other hormones may interact with additional factors in the cell that in turn regulate the level of transcription. The DNA regulatory site influenced by glucocorticoid hormones is known to be upstream of the site at which transcription of *hGH-N* begins. An example of the many transcription initiation protein factors that can interact with the DNA in the vicinity of eukaryotic genes is shown in Figure 16.18.

Deletions can occur within the growth hormone gene family. Deletions of *hGH-N* in both copies of chromosome 17 have been detected in some cases of severe growth hormone deficiency. These individuals are very short and do not have detectable serum growth hormone. Some such children initially respond very well to treatment with recombinant human growth hormone synthesized in the bacterium *E. coli* (see p. 834 and Figure 19.29) but they often develop antibodies against the growth hormone. Deletions also have been detected in which *hCS-A*, *hGH-V*, and *hCS-B* are lost from both chromosome 17 copies. Despite the fact that maternal sera of these individuals lack these hormones, fetal development usually proceeds normally, suggesting they either are unnecessary or can be compensated for by other hormones or factors.

19.12—

Mitochondrial Genes

About 0.3% of the DNA of human cells occurs in the mitochondria. Human mitochondrial DNA (mtDNA) is a double-stranded circular molecule of 16,569 bp whose sequence has been completely determined. As many as 100 molecules of mtDNA can occur in a metabolically active cell. Each mtDNA codes for 2 rRNAs, 22 tRNAs, and 13 proteins, most of which are subunits of multi-subunit complexes in the mitochondrial inner membrane that catalyze oxidative phosphorylation (Figure 19.27). For example, Complex I (NADH dehydrogenase), the first of three proton-pumping complexes involved in oxidative phosphorylation, is comprised of 26 proteins. Seven of these proteins are encoded by the

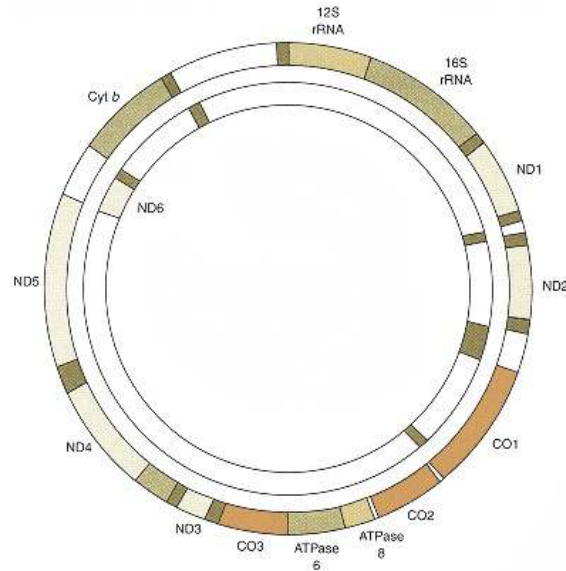

Figure 19.27

Human mitochondrial DNA.

The 16,569-bp human mtDNA molecule codes for two ribosomal RNAs (12 S and 16 S rRNA), some of the subunits for NADH dehydrogenase (ND), cytochrome oxidase (CO), ATP synthase (ATPase), and cytochrome b (cyt *b*), and 22 tRNAs (dark gray regions). Most genes occur on the outer DNA strand but genes for ND6 and a few tRNAs are on the inner strand.

CLINICAL CORRELATION 19.6

Leber's Hereditary Optic Neuropathy (LHON)

Leber's hereditary optic neuropathy, first described in 1871, is a maternally inherited genetic disease that usually strikes young adults and results in complete or partial blindness from optic nerve degeneration. Other neurological disorders such as cardiac dysrhythmia can also be associated with the disease. The cause of this defect in many patients has been traced to a single base pair mutation in the mitochondrial DNA that changes an arginine to a histidine at amino acid 340 in NADH dehydrogenase subunit 4 of Complex I in the inner mitochondrial membrane. Although it is not clear why this mutation leads to blindness, the eyes require a high level of mitochondrial activity and perhaps become sensitive over time to a small decrease in ATP synthesis by oxidative phosphorylation.

Singh, G., Lott, M. T., and Wallace, D. C. A mitochondrial DNA mutation as a cause of Leber's Hereditary Optic Neuropathy. *N. Eng. J. Med.* 320:1300, 1989.

mtDNA. Mitochondrial DNA also contains genes for three cytochrome oxidase subunits, two ATP synthase subunits, and cytochrome *b*. In contrast to the nucleus, where much of the chromosomal DNA seems to have no genetic function, virtually every base pair in mtDNA is essential. Regions between the protein-coding genes usually encode tRNAs and sometimes the last nucleotide of one gene will be the first nucleotide of the adjacent gene. Polyadenylation at the 3' ends of some of the mitochondrial mRNAs adds the last two A residues of the termination codon, UAA, to create the end of the reading frame.

Even more remarkable, the genetic code of mammalian mtDNA is not identical to the genetic code of nuclear or prokaryotic DNA. UGA codes for tryptophan instead of for termination, AUA codes for methionine rather than isoleucine, and AGA and AGG serve as stop codons instead of specifying arginine. It is not clear why mitochondria have their own altered genetic system. Perhaps mtDNA is an evolutionary vestige of an early symbiotic relationship between a bacterium and the progenitor of eukaryotic cells. What is clear is that cells make a large investment to express the 13 mitochondria-encoded proteins. To produce those proteins a large group of nucleus-encoded ribosomal proteins and associated translation factors must be imported into the mitochondrion and assembled, as well as all of the enzymes and binding proteins required for mtDNA replication and transcription. More than 100 nucleus-encoded proteins are probably necessary to maintain the mtDNA and express its gene products.

Since mitochondria are in the cytoplasm, mtDNA molecules are maternally inherited. mtDNA sequences can be used as markers for maternal lineages. In addition, mutations in mtDNA can lead to genetic diseases that are inherited only from the mother. For example, a single base pair change in mtDNA has been found to be responsible for **Leber's hereditary optic neuropathy** (see Clin. Corr. 19.6). Similar mtDNA mutations may be the cause of two other maternally inherited genetic diseases, *myoclonic epilepsy* and *infantile bilateral striatal necrosis*.

19.13—

Bacterial Expression of Foreign Genes

Recombinant DNA techniques are now frequently used to construct bacteria that are "factories" for making large quantities of specific human proteins useful in the diagnosis or treatment of disease. The two examples to be illustrated here are the construction of bacteria that synthesize human insulin and human growth hormone.

Many factors must be considered in designing recombinant plasmids that contain a eukaryotic gene to be expressed in bacteria. First, the cloned eukaryotic gene cannot have any introns since the bacteria do not have the RNA-splicing enzymes that correctly remove introns from the initial transcript. Thus the actual eukaryotic chromosomal gene is usually not used for these experiments; instead, the cDNA or a synthetic equivalent of the coding sequence, or a combination of both, is placed in the bacterial plasmid.

Another consideration is that different nucleotide sequences comprise the binding sites for RNA polymerase and ribosomes in bacteria and eukaryotes. Therefore, to achieve expression of the desired protein, it is necessary to insert the eukaryotic coding sequence directly behind a set of bacterial regulatory elements. This has the advantage that the foreign gene is now under the regulation of the bacterial control elements, but its disadvantage is that considerable recombinant DNA manipulation is required to make the appropriate plasmid. Still other factors to be considered are that the foreign gene product must not be degraded by bacterial proteases or require modification before it is active (e.g., specific glycosylation events that the bacteria cannot perform) and must not be toxic to the bacteria. Even when the bacteria do synthesize the desired product, it must be isolated from the 1000 or more endogenous bacterial proteins.

Recombinant Bacteria Can Synthesize Human Insulin

Insulin is produced by the β cells of the pancreatic islets of Langerhans. It is initially synthesized as **preproinsulin**, a precursor polypeptide that possesses an N-terminal signal peptide and an internal C peptide of 33 amino acids that are removed during the subsequent maturation and secretion of insulin (see p. 40). The **A peptide** (21 amino acids) and **B peptide** (30 amino acids) of mature insulin are both derived from this initial precursor and are held together by two disulfide bridges. Bacteria do not have the processing enzymes that convert the precursor form to mature insulin. Therefore the initial strategy for bacterial synthesis of human insulin involved the production of the A and B chains by separate bacteria followed by purification of the individual chains and subsequent formation of the proper disulfide linkages.

The first step was to use synthetic organic chemistry methods to prepare a series of single-stranded oligonucleotides (11–18 nucleotides) that were both complementary and overlapping with each other. When these oligonucleotides were mixed together in the presence of **DNA ligase** under proper conditions, they formed a double-stranded fragment of DNA with termini equivalent to those formed by specific restriction enzymes (Figure 19.28). The sequences of the oligonucleotides were carefully chosen so that one of the two strands contained a methionine codon followed by the coding sequence of the A chain of insulin and a termination codon. A second set of overlapping complementary oligonucleotides were prepared and ligated together to form another double-stranded DNA fragment that contained a methionine codon followed by 30 codons specifying the B chain of insulin and a termination codon.

These two double-stranded fragments were then individually cloned at a restriction site in the β -galactosidase gene of the lactose operon in a plasmid. These two recombinant plasmids were introduced into bacteria. The bacteria could now produce a fusion protein of β -galactosidase and the A chain (or B chain) whose expression was under control of the lactose operon. In the absence

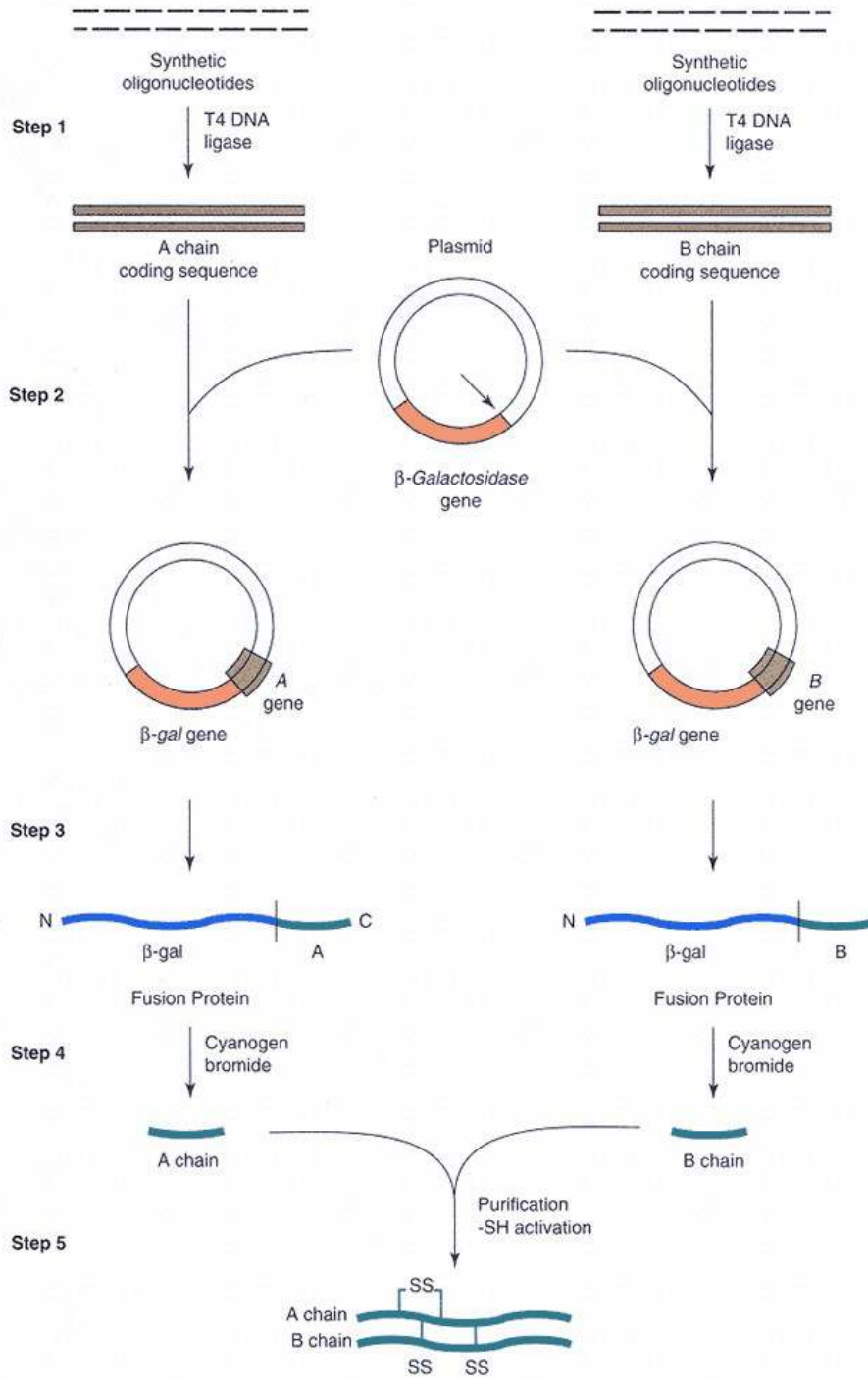

Figure 19.28

Bacterial expression of the A and B chains of human insulin.

Step 1: A series of overlapping, complementary oligonucleotides (11 for the A chain and 18 for the B chain) were synthesized and ligated together. One end of the resulting small DNA fragments contained a methionine codon followed by coding sequence for A chain and B chain, respectively.

Step 2: The small DNA fragments were ligated into a restriction site near the end of the β -galactosidase gene of the lactose operon in a plasmid.

Step 3: Recombinant plasmids were introduced into *E. coli* and the β -galactosidase gene was induced with IPTG, an inducer of the lactose operon. A fusion protein was produced that contained most of the β -galactosidase sequence at the N terminus and the A chain (or B chain) at the C terminus.

Step 4: Bacterial cell lysates containing the fusion protein were treated with cyanogen bromide, which cleaves peptide bonds following methionine residues. Step 5: A and B chains were purified away from all other cyanogen bromide peptides using biochemical and immunological separation techniques. The -SH groups on the cysteines were activated and reacted to form intra- and interchain disulfide bridges found in mature human insulin.

Redrawn from Crea, R., Krazewski, A., Hirose, T., and Itakura, K. *Proc. Natl. Acad. Sci. USA* 75:5765, 1980.

of lactose in the bacterial medium, the lactose operon is repressed and only very small amounts of the fusion protein are synthesized. Using induction with IPTG and some additional genetic tricks, the bacteria can be forced to synthesize as much as 20% of their protein as the fusion protein. The A peptide (or B peptide) can be released from this fusion protein by treatment with cyanogen bromide, which cleaves on the carboxyl side of methionine residues. Since neither the A nor B peptide contains a methionine, they will be liberated intact and can subsequently be purified to homogeneity. The final steps involve chemically activating the free -SH groups on the cysteines and mixing the activated A and B chains together in a way that the proper disulfide linkages form to generate molecules of mature human insulin.

Recombinant Bacteria Can Synthesize Human Growth Hormone

The strategy for generating a recombinant DNA plasmid from which bacteria can synthesize human growth hormone is somewhat different than for insulin synthesis. First, human growth hormone is 191 amino acids long so the synthetic construction of the corresponding DNA coding sequence is more difficult (although certainly not impossible) than in the insulin case. On the other hand, growth hormone is a single polypeptide so it is not necessary to deal with the production of two chains and their subsequent dimerization to form a protein with biological activity. Because of these considerations, the coding sequence was initially cloned into a bacterial expression plasmid using part of a cloned growth hormone cDNA and several synthetic oligonucleotides (Figure 19.29). The overlapping oligonucleotides were prepared so that, when ligated together, they would form a small double-stranded DNA containing the codons for the first 24 amino acids of mature human growth hormone. One end of this DNA

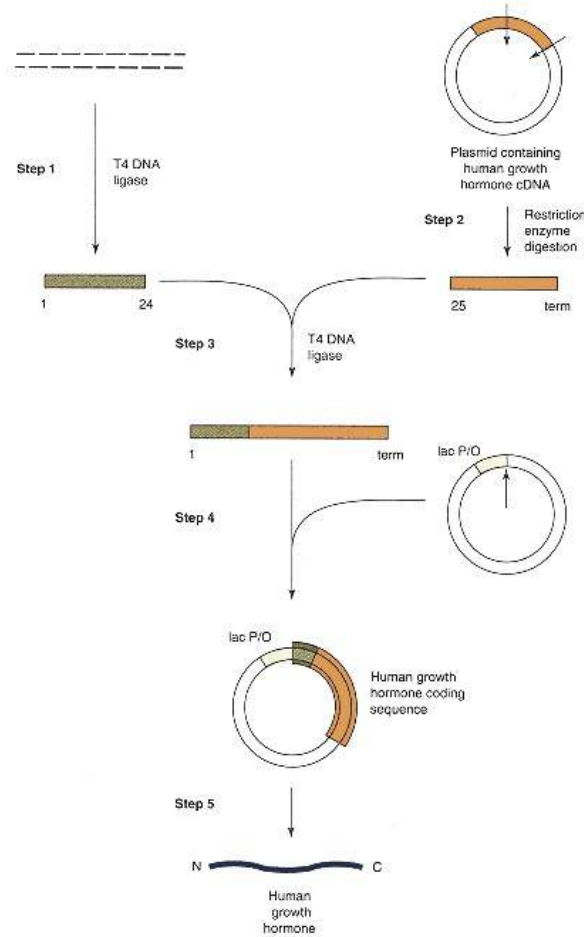

Figure 19.29

Expression of human growth hormone in *E. coli*.

- Step 1: Several overlapping, complementary, oligonucleotides were synthesized and ligated together. One strand of the resulting small DNA fragment contains the coding sequence for the first 24 amino acids of mature human growth hormone (after removal of the N-terminal signal peptide).
- Step 2: A recombinant plasmid with a full length human growth hormone (hGH) cDNA, which is not expressed, is cleaved with restriction enzymes that release a fragment containing the complete growth hormone coding sequence after codon 24.
- Step 3: The synthetic fragment and the partial cDNA-containing fragment are ligated together to yield a new fragment containing the complete coding sequence of mature hGH.
- Step 4: The new fragment is ligated into a restriction site just downstream from the lactose promoter–operator region cloned in a plasmid.
- Step 5: The resulting recombinant DNA plasmid is introduced into bacteria in which synthesis of hGH can be induced with IPTG, an inducer of the lactose operon.

fragment was designed so that the fragment could be ligated in front of a restriction fragment of growth hormone cDNA that provided the rest of the coding sequence, including the termination codon. The other end of the synthetic fragment was chosen so that the composite coding sequence could easily be inserted into a site immediately downstream of the promoter–operator–ribosome binding site of the lactose operon cloned in a plasmid. After the introduction into bacteria, the bacteria were induced with IPTG to transcribe this foreign coding region and the greatly overproduced human growth hormone subsequently was purified away from the bacterial proteins.

19.14— Introduction of Rat Growth Hormone Gene into Mice

The previous section described the use of bacteria to produce large quantities of human proteins for treatment of disease. It is possible to microinject molecules of purified RNA or DNA directly into eukaryotic cells. This provides a very powerful approach for identifying conditions under which specific genes are expressed in eukaryotic cells. One of the most dramatic illustrations of this approach was the microinjection of a chromosomal DNA fragment containing the structural gene for rat growth hormone into the **pronuclei** of fertilized mouse eggs. The eggs were then reimplanted into the reproductive tracts of foster mouse mothers. Some of the mice that developed from this procedure were **transgenic**; one or more copies of the microinjected growth hormone gene integrated into a host mouse chromosome at an early stage of embryo development. These foreign genes were transmitted through the germline and became a permanent feature in the host chromosomes of the progeny (Figure 19.30).

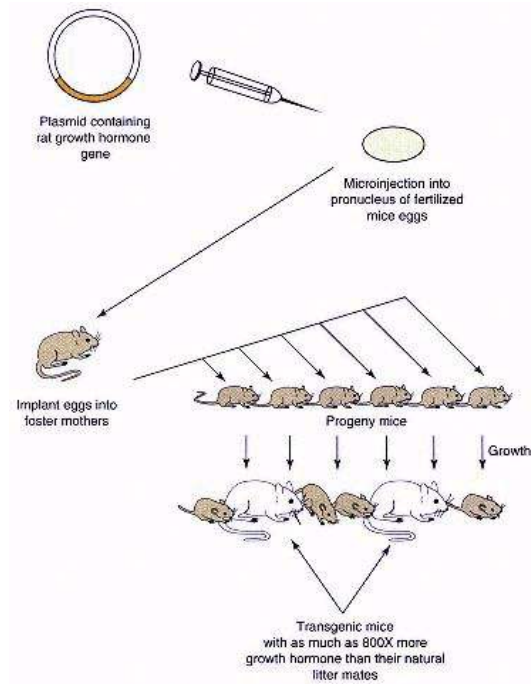

Figure 19.30
Schematic illustration of the introduction of rat growth hormone gene into mice.

Copies of a recombinant plasmid DNA containing rat growth hormone gene were microinjected into fertilized mouse eggs that were reimplanted into foster mothers. Some of the resulting progeny contained the foreign gene integrated into their own genome and greatly overexpressed growth hormone, growing much larger than their normal-sized littermates.

Redrawn from Palmiter, R. D., Brinster, R. L., Hammer, R. E. et al.
Nature 300:611, 1982.

Analysis of these transgenic mice revealed that in some cases several tandem copies of the rat growth hormone gene had integrated into a mouse chromosome; in other cases only one gene copy was present. In all cases at least some transcription occurred from the integrated gene(s), and in a few cases a dramatic overproduction of rat growth hormone resulted. In these latter cases, as much as 800 times more growth hormone was present in the transgenic mice than in normal mice, resulting in animals more than three times the size and weight of their unaffected littermates.

These results present many potential experimental possibilities for the future and raise a number of issues. One implied possibility is the use of similar growth hormone gene insertions to stimulate rapid growth of commercially valuable animals. This could result in a shorter production time and increased efficiency of food utilization. Another long-term possibility is the use of this approach to correct certain human genetic diseases or mimic the diseases in experimental animals so that they can be studied more carefully. One obvious human disease that is a candidate for this "**gene therapy**" approach is thalassemia. For example, an individual with two to three missing α -globin genes might benefit tremendously from receiving bone marrow transplants of his/her own cells that have been established in culture and microinjected with additional copies of the normal α -globin gene. This approach to gene therapy is being investigated. Insertion of normal genes into human somatic cells of a defective tissue or organ does not result in transmission of these genes to the progeny. This lessens the ethical considerations for experiments that do not alter germline characteristics.

Bibliography

Prokaryotic Gene Expression

Cohen, S. N., and Shapiro, J. A. Transposable genetic elements. *Sci. Am.* 242:40, 1980.

Miller, J. H. The *lac* gene: its role in *lac* operon control and its use as a genetic system. In: J. H. Miller and W. S. Resnikoff (Eds.), *The Operon*. Cold Spring Harbor, NY: Cold Spring Harbor Laboratory Press, 1978, p. 31.

Platt, T. Regulation of gene expression in the tryptophan operon of *Escherichia coli*. In: J. H. Miller and W. S. Resnikoff (Eds.), *The Operon*. Cold Spring Harbor, NY: Cold Spring Harbor Laboratory Press, 1978, p. 263.

Simon, M., Zieg, J., Silverman, M., Mandel, G., and Doolittle, R. Phase variation: evolution of a controlling element. *Science* 209:1370, 1980.

Eukaryotic Gene Expression

Ahn, A. H., and Kunkel, L. M. The structural and functional diversity of dystrophin. *Nature Genetics* 3:283, 1993.

Chen, E. Y., Liao, Y.-C., Smith, D. H., Barrera-Saldaña, H. A., Gelinas, R. E., and Seeburg, P. H. The human growth hormone locus: nucleotide sequence, biology and evolution. *Genomics* 4:479, 1989.

Enver, T., and Greaves, D. R. Globin gene switching: a paradigm or what? *Curr. Opin. Biotech.* 2:787, 1991.

Johns, D. R. Mitochondrial DNA and disease. *N. Engl. J. Med.* 333:638, 1995.

Karlsson, S., and Nienhuis, A. W. Developmental regulation of human globin genes. *Annu. Rev. Biochem.* 54:1071, 1985.

Maniatis, T., Fritsch, E. F., Laurer, J., and Lawn, R. M. The molecular genetics of human hemoglobins. *Annu. Rev. Genet.* 14:145, 1980.

Mitchell, P. J., and Tjian, R. Transcription regulation in mammalian cells by sequence-specific DNA binding proteins. *Science* 245:371, 1989.

Palmiter, R. D., Brinster, R. L., Hammer, R. E., et al. Dramatic growth of mice that develop from eggs microinjected with metallothionein-growth hormone fusion genes. *Nature* 300:611, 1982.

Singh, G., Lott, M. T., and Wallace, D. C. A mitochondrial DNA mutation as a cause of Leber's hereditary optic neuropathy. *N. Engl. J. Med.* 320:1300, 1989.

Struhl, K. Chromatin structure and RNA polymerase II connection: implications for transcription. *Cell* 84:179, 1996.

The Huntington's Disease Collaborative Research Group. A novel gene containing a trinucleotide repeat that is expanded and unstable on Huntington's disease chromosomes. *Cell* 72:971, 1993.

Questions

J. Baggott and C. N. Angstadt

1. Full expression of the *lac* operon requires:

- A. lactose and cAMP.
- B. allolactose and cAMP.
- C. lactose alone.
- D. allolactose alone.
- E. absence or inactivation of the *lac* corepressor.

2. In an operon:

- A. each gene of the operon is regulated independently to achieve levels of expression required by the cell.
- B. control may be exerted via induction or via repression.
- C. operator and promoter may be trans to the genes they regulate.

- D. the structural genes are either not expressed at all or are fully expressed.
- E. control of gene expression consists exclusively of induction and repression.
3. The *E. coli lacZYA* region will be upregulated if:
- A. there is a defect in binding of the inducer to the product of the *lacI* gene.
- B. glucose and lactose are both present in the growth medium, but there is a defect in the cell's ability to bind the CAP protein.
- C. glucose and lactose are both readily available in the growth medium.
- D. the operator has mutated so it can no longer bind repressor.
- E. the *lac* corepressor is not present.
4. All of the following describe an operon EXCEPT:
- A. control mechanism for eukaryotic genes.
- B. includes structural genes.
- C. expected to code for polycistronic mRNA.
- D. contains control sequences such as an operator.
- E. can have multiple promoters.

Refer to the following for Questions 5–9:

- A. repression
- B. corepression
- C. attenuation
- D. stringent response
- E. RNA splicing
5. Associated with guanosine tetraphosphate and guanosine pentaphosphate.
6. Not found in prokaryotes.
7. Involves rho-independent transcription termination.
8. Involves a leader peptide containing several occurrences of the same amino acid.
9. The only regulatory mechanism for the *his* operon.
10. Ribosomal operons:
- A. all contain genes for proteins of just one ribosomal subunit.
- B. all contain genes for proteins of both ribosomal subunits.
- C. all contain genes for only ribosomal proteins.
- D. can have their expression regulated at the level of translation.
- E. are widely separated in the *E. coli* chromosome.
11. All of the following phrases describe transposons EXCEPT:
- A. a means for the permanent incorporation of antibiotic resistance into the bacterial chromosome.
- B. contain short inverted terminal repeat sequences.
- C. code for an enzyme that synthesizes guanosine tetraphosphate and guanosine pentaphosphate, which inhibit further transposition.
- D. include at least one gene that codes for a transposase.
- E. contain varying numbers of genes, from two to several.
12. Introns:
- A. are of approximately uniform size.
- B. are skipped over during translation.
- C. are found in all eukaryotic genes.
- D. function to separate functional domains of proteins.
- E. are smaller and shorter in unicellular lower eukaryotes than in higher, more complicated eukaryotes.
13. Repetitive DNA:
- A. is common in bacterial and mammalian systems.
- B. is uniformly distributed throughout the genome.
- C. includes DNA that codes for rRNA.
- D. consists mostly of DNA that codes for enzymes catalyzing major metabolic processes.
- E. is resistant to the action of restriction endonucleases.
14. The β -gene cluster contains:
- A. one haploid α gene.
- B. one haploid β gene.
- C. one haploid γ gene.
- D. two haploid α genes.
- E. two haploid β genes.
15. The number of α genes in the haploid α -gene cluster is
- A. one.
- B. two.
- C. three.
- D. four.
- E. five.
16. In designing a recombinant DNA for the purpose of synthesizing an active eukaryotic polypeptide in bacteria all of the following should be true EXCEPT:
- A. the eukaryotic gene may contain its usual complement of introns.
- B. the foreign polypeptide should be resistant to degradation by bacterial proteases.
- C. glycosylation of the polypeptide should be unnecessary.
- D. the foreign polypeptide should be nontoxic to the bacteria.
- E. bacterial controlling elements are necessary.

Answers

1. B A: The true inducer is allolactose, not lactose (p. 806). C: Lactose is converted in the cell to allolactose. D: In addition, cAMP must bind to the CAP protein, and the cAMP-CAP complex serves as a positive control of transcription (p. 807). E: The *lac* operon does not involve corepression.
2. B Induction and repression are among the mechanisms used to control operons. A: In an operon the structural genes are under coordinate control. C: The operator and promoter are elements of the same strand of DNA as the operon they control; they are not diffusible. D: Typically, regulation of operators is somewhat leaky; some gene product is produced even in the repressed state. E: Another mechanism for regulation of an operon is attenuation (p. 810).

3. D If the operator is unable to bind repressor, the rate of transcription is greater than the basal level (p. 804). A: The product of the *lacI* gene is the repressor protein. When this protein binds an inducer, it changes its conformation, no longer binds to the operator site of DNA, and transcription occurs at an increased rate. Failure to bind an inducer prevents this sequence. B and C: In the presence of glucose catabolite repression occurs. Glucose lowers the intracellular level of cAMP. The catabolite activator protein (CAP) then cannot complex with cAMP, so there is no CAP–cAMP complex to activate transcription. The same would occur if the cell had lost its capacity to synthesize cAMP (p. 808). E: The *lac* operon does not involve corepression.
4. A Operons are prokaryotic mechanisms. B–D: An operon is the complete regulatory unit of a set of clustered genes, including the structural genes (which are transcribed together to form a polycistronic mRNA), regulatory genes, and control elements, such as the operator (p. 801). E: An operon may have more than one promoter, as does the tryptophan operon of *E. coli* (p. 810).
5. D The exact functions of these species are not yet known, but their production is very rapid after the onset of amino acid starvation (p. 815).
6. E Splicing is a eukaryotic phenomenon (p. 820).
7. C The hairpin loop that forms between regions 3 and 4 (Figure 19.11) is followed by an oligo-U region (Figure 19.10). This constellation compromises the signal for rho-independent termination of transcription. (See pp. 811–812.)
8. C Synthesis of the leader peptide depends strongly on availability of this amino acid, since it must be incorporated several times. When it is insufficiently available, the ribosome stalls, in region 1 (Figure 19.11), allowing the 2–3 hairpin to form. This in turn prevents formation of the 3–4 hairpin, which would signal termination of transcription.
9. C In this operon the stalled ribosome acts rather like a positive regulator protein, that is, the cAMP–CAP complex (p. 813).
10. D Excess ribosomal protein binds to its own mRNA, preventing initiation of further synthesis of that protein (p. 814). A, B, C, and E: The genes for one half of the ribosomal proteins are in two major clusters. There is no pattern to the distribution of genes for the proteins of the two ribosomal subunits, and they are intermixed with genes for other proteins involved in protein synthesis.
11. C These guanosine phosphates are synthesized by the product of the *relA* gene; they inhibit initiation of transcription of the rRNA and tRNA genes, shutting off protein synthesis in general. This is the stringent response (p. 815).
12. E A: Introns are of various sizes. B: They are excised during splicing, not skipped over during translation. C: Although they are common, some genes do not have them, for example, the histone and interferon genes (p. 821). D: Sometimes they occur between functional domains of proteins, but not always.
13. C This makes sense, since many copies of these structural elements are needed (p. 823). A and B: Highly repetitive and moderately repetitive DNA are found only in eukaryotes. Highly repetitive sequences tend to be clustered, as are some moderately repetitive sequences (p. 822). D: Most repetitive DNA does not code for a stable gene product (p. 822). E: The Alu family of moderately repetitive DNA is named for the restriction endonuclease that cleaves them (p. 823).
14. B This means that there are only two β genes per diploid cell. As a result, in β -thalassemia, one defective β -globin gene gives rise to a minor form of the disease, while two defective genes cause the major form. (See p. 828.)
15. B As a result, α -thalassemia is more complicated than β -thalassemia because there are four α -globin genes per diploid cell, and anywhere between zero and four of them can be defective. (See p. 828.)
16. A A and C: The bacterial system has no mechanism for posttranscriptional modification of mRNA or for posttranslational (or cotranslational) modification of protein. E: Bacterial systems need bacterial promoters, and so on (p. 832).

Chapter 20— Biochemistry of Hormones I: Polypeptide Hormones

Gerald Litwack and Thomas J. Schmidt

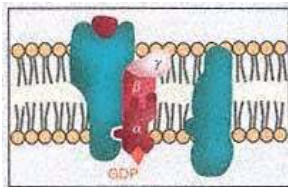

20.1 Overview	840
20.2 Hormones and the Hormonal Cascade System	841
Cascade System Amplifies a Specific Signal	841
Polypeptide Hormones of the Anterior Pituitary	844
20.3 Major Polypeptide Hormones and Their Actions	846
20.4 Genes and Formation of Polypeptide Hormones	849
Proopiomelanocortin Is a Precursor Polypeptide for Eight Hormones	849
Many Polypeptide Hormones Are Encoded Together in a Single Gene	849
Multiple Copies of a Hormone Can Be Encoded on a Single Gene	852
20.5 Synthesis of Amino Acid-Derived Hormones	853
Epinephrine Is Synthesized from Phenylalanine/Tyrosine	853
Synthesis of Thyroid Hormone Requires Incorporation of Iodine into a Tyrosine of Thyroglobulin	854
20.6 Inactivation and Degradation of Hormones	857
20.7 Cell Regulation and Hormone Secretion	859
G-Proteins Serve as Cellular Transducers of Hormone Signals	859
Cyclic AMP Activates Protein Kinase A Pathway	862
Inositol Triphosphate Formation Leads to Release of Calcium from Intracellular Stores	862
Diacylglycerol Activates Protein Kinase C Pathway	865
20.8 Cyclic Hormonal Cascade Systems	866
Melatonin and Serotonin Synthesis Are Controlled by Light and Dark Cycles	866
Ovarian Cycle Is Controlled by Gonadotropin-Releasing Hormone	867
Absence of Fertilization	868
Fertilization	870
20.9 Hormone–Receptor Interactions	871
Scatchard Analysis Permits Determination of the Number of Receptor-Binding Sites and Association Constant for Ligand	872
Some Hormone–Receptor Interactions Involve Multiple Hormone Subunits	872
20.10 Structure of Receptors: β -Adrenergic Receptor	875
20.11 Internalization of Receptors	876
Clathrin Forms a Lattice Structure to Direct Internalization of Hormone–Receptor Complexes from the Plasma Membrane	877
20.12 Intracellular Action: Protein Kinases	878
Insulin Receptor: Transduction through Tyrosine Kinase	879
Activity of Vasopressin: Protein Kinase A	880
Gonadotropin-Releasing Hormone (GnRH): Protein Kinase C	883
Activity of Atrial Natriuretic Factor (ANF): Protein Kinase G	885
20.13 Oncogenes and Receptor Functions	888
Bibliography	890
Questions and Answers	890
Clinical Correlations	
20.1 Testing Activity of the Anterior Pituitary	844
20.2 Hypopituitarism	846
20.3 Lithium Treatment of Manic–Depressive Illness: The Phosphatidylinositol Cycle	863

20.1— Overview

Cells are regulated by many hormones, growth factors, neurotransmitters, and certain toxins through interactions of these diverse ligands with their **cognate receptors** located at the cell surface. This collection of receptors is the major mechanism through which **peptide hormones** and **amino acid-derived hormones** exert their effects at the cellular level. Another important mechanism involves permeation of the cell membrane by **steroid hormones** that subsequently interact with their intracellular cognate receptors (Chapter 21). These two sites, the plasma membrane and the intracellular milieu, represent the principal locations of the initial interaction between ligands and cellular receptors and are diagrammed in Figure 20.1. Polypeptide hormones and several amino acid-derived hormones bind to cognate receptors in the plasma membrane. One exception is thyroid hormone, which binds to a receptor that resides in the nucleus much like certain steroid hormone receptors.

The **hormonal cascade system** is applicable to many, but not all, hormones. It begins with signals in the central nervous system (CNS), followed by hormone secretion by the hypothalamus, pituitary, and end target organ. In this chapter major polypeptide hormones are summarized and the synthesis of specific hormones is described. Synthesis of the amino acid-derived hormones, epinephrine and triiodo-L-thyronine, is also outlined. Examples of hormone inactivation and degradation are presented. The remainder of this chapter focuses on receptors, **signal transduction**, and **second messenger pathways**. Receptor internalization is described and examples of cyclic hormonal cascade systems are introduced. Finally, a discussion of oncogenes and receptor function is presented.

In terms of receptor mechanisms, aspects of hormone–receptor interactions are presented with a brief mathematical analysis. Signal transduction is considered, especially in reference to GTP-binding proteins. Second messenger systems discussed include cAMP and the protein kinase A pathway, inositol triphosphate–diacylglycerol and the Ca^{2+} –protein kinase C pathway, and cGMP and

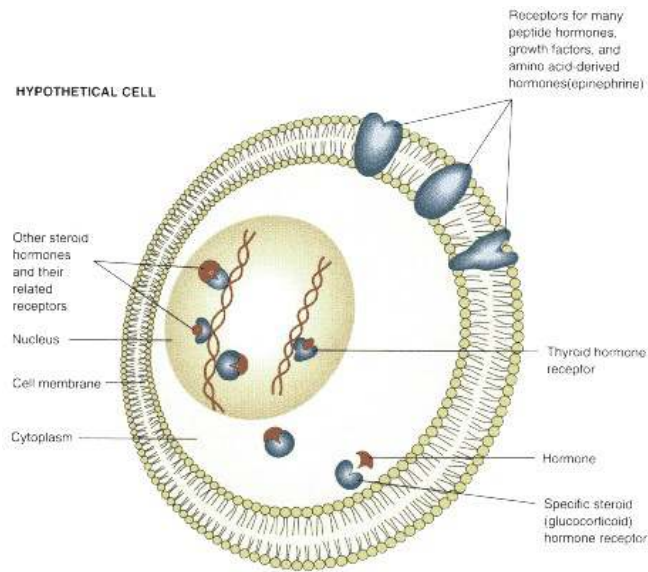

Figure 20.1

Diagram showing the different locations of classes of receptors expressed by a target cell.

the protein kinase G pathway. These pathways are discussed in the context of representative hormone action. Newly identified components of these signal transduction pathways are defined in terms of the kinase system(s) involved. In addition, the insulin receptor and its tyrosine kinase and second messenger pathways are considered.

20.2—

Hormones and the Hormonal Cascade System

The definition of a hormone has been expanded over the last several decades. Hormones secreted by endocrine glands were originally considered to represent all of the physiologically relevant hormones. Today, the term **hormone** refers to any substance in an organism that carries a signal to generate some sort of alteration at the cellular level. Thus **endocrine hormones** represent a class of hormones that arise in one tissue, or "gland," and travel a considerable distance through the circulation to reach a target cell expressing cognate receptors. **Paracrine hormones** arise from a cell and travel a relatively small distance to interact with their cognate receptors on another neighboring cell. **Autocrine hormones** are produced by the same cell that functions as the target for that hormone (neighboring cells may also be targets). Thus we can classify hormones based on their radii of action. Often, endocrine hormones that travel long distances to their target cells may be more stable than autocrine hormones that exert their effects over very short distances.

Cascade System Amplifies a Specific Signal

For many hormonal systems in higher animals, the signal pathway originates with the brain and culminates with the ultimate target cell. Figure 20.2 outlines the sequence of events in this cascade. A stimulus may originate in the external environment or within the organism in this cascade. This signal may be transmitted as an electrical pulse (action potential) or as a chemical signal or both. In many cases, but not all, such signals are forwarded to the limbic system and subsequently to the hypothalamus, the pituitary, and the target gland that secretes the final hormone. This hormone then affects various target cells to a degree that is frequently proportional to the number of cognate receptors

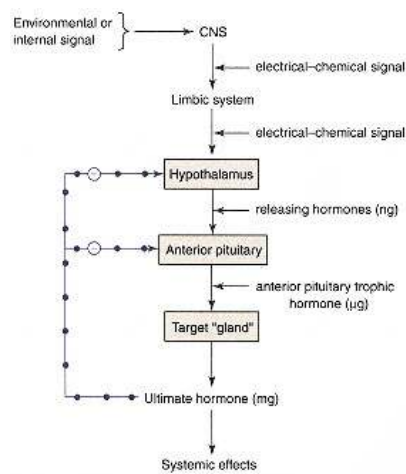

Figure 20.2
Hormonal cascade of signals from CNS to ultimate hormone.

The target "gland" refers to the last hormone-producing tissue in the cascade, which is stimulated by an appropriate anterior pituitary hormone. Examples would be thyroid gland, adrenal cortex, ovary, and testis. Ultimate hormone feeds back negatively on sites producing intermediate hormones in the cascade. Amounts [nanogram (ng), microgram (μg), and milligram (mg)] represent approximate quantities of hormone released.

Redrawn from Norman, A. W., and Litwack, G. *Hormones*. New York: Academic Press, 1987, p. 38.

expressed by that cell. This may be a true **cascade** in the sense that increasing amounts of hormones are generated at successive levels (hypothalamus, pituitary, and target gland) and also because the half-lives of these blood-borne hormones tend to become longer in progression from the hypothalamic hormone to the ultimate hormone. In the case of environmental stress, for example, there is a single stressor (change in temperature, noise, trauma, etc.). This stress results in a signal to the hippocampal structure in the limbic system that signals the hypothalamus to release a hypothalamic releasing hormone, corticotropin-releasing hormone (CRH), which is usually secreted in nanogram amounts and may have a $t_{1/2}$ in the bloodstream of several minutes. This hormone travels down a closed portal system to gain access to the **anterior pituitary**, where it binds to its cognate receptor in the cell membrane of corticotropic cells and initiates a set of metabolic changes resulting in the release of adrenocorticotropic hormone (ACTH) as well as β -lipotropin. This hormone, which is released in microgram amounts and has a longer $t_{1/2}$ than CRH, circulates in the bloodstream until it binds to its cognate receptors expressed in the membranes of cells located in the inner layer of the cortex of the adrenal gland (target gland). Here it affects metabolic changes leading to the synthesis and release in 24 h of the ultimate hormone, cortisol, in multimilligram amounts and this active glucocorticoid hormone has a substantial $t_{1/2}$ in blood. Cortisol is taken up by a wide variety of cells that express varying amounts of the intracellular glucocorticoid receptor. The ultimate hormone, in this case cortisol, feeds back negatively on cells of the anterior pituitary, hypothalamus, and perhaps higher levels to shut down the overall pathway in a process that is also mediated by the glucocorticoid receptor. At the **target cell** level these cortisol-receptor complexes mediate specific transcriptional responses and the individual hormonal effects summate to produce the systemic effects of the hormone. The cascade is represented in this example by a single environmental stimulus generating a series of hormones in progressively larger amounts and with increasing stabilities, and by the ultimate hormone that affects most of the cells in the body. Many other systems operate similarly, there being different specific **releasing hormones, anterior pituitary tropic hormones**, and ultimate hormones involved in the process. Clearly, the final number of target cells affected may be large or small depending on the distribution of receptors for each ultimate hormone.

A related system involves the **posterior pituitary hormones**, oxytocin and vasopressin (antidiuretic hormone), which are stored in the posterior pituitary gland but are synthesized in neuronal cell bodies located in the hypothalamus. This system is represented in Figure 20.3; elements of Figure 20.2 appear in the central vertical pathway. The posterior pituitary system branches to the right from the hypothalamus. Oxytocin and vasopressin are synthesized in separate cell bodies of hypothalamic neurons. More cell bodies dedicated to synthesis of vasopressin are located in the supraoptic nucleus and more cell bodies dedicated to synthesis of oxytocin are located in the paraventricular nucleus. Their release from the posterior pituitary gland along with **neurophysin**, a stabilizing protein, occurs separately via specific stimuli impinging on each of these types of neuronal cells.

There are highly specific signals dictating the release of polypeptide hormones along the cascade of this system. Thus there are a variety of **aminergic neurons** (secreting amine-containing substances like dopamine and serotonin) which connect to neurons involved in the synthesis and release of the **releasing hormones** of the hypothalamus. Releasing hormones are summarized in Table 20.1. These aminergic neurons fire depending on various types of internal or external signals and their activities account for **pulsatile release patterns** of certain hormones, such as the gonadotropin-releasing hormone (GnRH), and the **rhythmic cyclic release** of other hormones like cortisol.

Another prominent feature of the hormonal cascade (Figure 20.3) is the **negative feedback** system operating when sufficiently high levels of the ultimate hormone have been secreted into the circulation. Generally, there are three feedback loops—the **long feedback**, the **short feedback**, and the **ultra-**

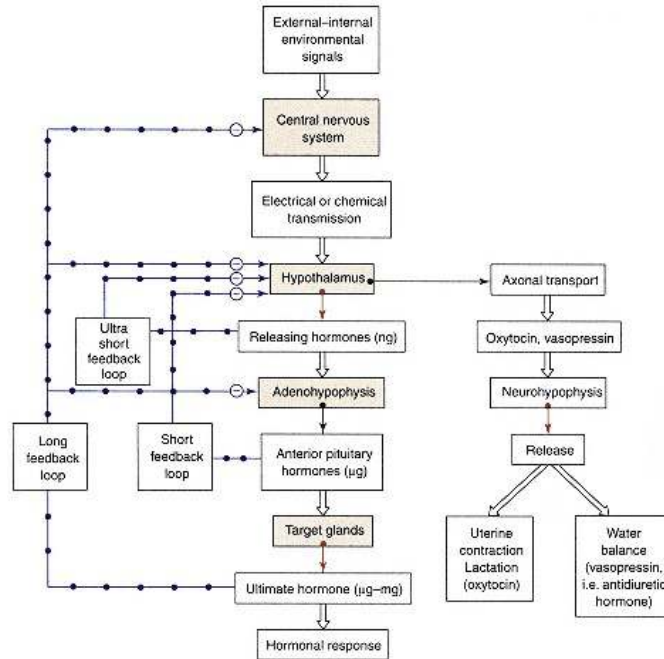

Figure 20.3

Many hormonal systems involve the hypothalamus.

Cascade of hormonal signals starting with an external or internal environmental signal. This is transmitted first to the CNS and may involve components of the limbic system, such as the hippocampus and amygdala. These structures innervate the hypothalamus in a specific region, which responds with secretion of a specific releasing hormone, usually in nanogram amounts. Releasing hormones are transported down a closed portal system connecting the hypothalamus and anterior pituitary, bind to cell membrane receptors and cause the secretion of specific anterior pituitary hormones, usually in microgram amounts. These access the general circulation through fenestrated local capillaries and bind to specific target gland receptors. The interactions trigger release of an ultimate hormone in microgram to milligram daily amounts, which generate the hormonal response by binding to receptors in several target tissues. In effect, this overall system is an amplifying cascade. Releasing hormones are secreted in nanogram amounts and they have short half-lives on the order of a few minutes. Anterior pituitary hormones are produced often in microgram amounts and have longer half-lives than releasing hormones. Ultimate hormones can be produced in daily milligram amounts with much longer half-lives. Thus the products of mass \times half-life constitute an amplifying cascade mechanism. With respect to differences in mass of hormones produced from hypothalamus to target gland, the range is nanograms to milligrams, or as much as one million-fold. When the ultimate hormone has receptors in nearly every cell type, it is possible to affect the body chemistry of virtually every cell by a single environmental signal. Consequently, the organism is in intimate association with the external environment, a fact that we tend to underemphasize. Solid arrows indicate a secretory process. Long arrows studded with open or closed circles indicate negative feedback pathways (ultra-short, short, and long feedback loops).

Redrawn from Norman, A. W., and Litwack, G. *Hormones*.
New York: Academic Press, 1987, p. 102.

TABLE 20.1 Hypothalamic Releasing Hormones^a

Releasing Hormone	Number of Amino Acids in Structure	Anterior Pituitary Hormone Released or Inhibited
Thyrotropin-releasing hormone (TRH)	3	Thyrotropin (TSH); can also release prolactin (PRL) experimentally
Gonadotropin-releasing hormone (GnRH)	10	Luteinizing and follicle-stimulating hormones (LH and FSH) from the same cell type; leukotriene C ₄ (LTC ₄) can also release LH and FSH by a different mechanism
Gonadotropin release-inhibiting factor (GnRIF)	12.2 kDa molecular weight	LH and FSH release inhibited
Corticotropin-releasing hormone (CRH)	41	ACTH, β -lipotropin (β -LPH), and some β -endorphin
Arginine vasopressin (AVP)	9	Stimulates CRH action in ACTH release
Angiotensin II (AII)	8	Stimulates CRH action in ACTH release; releases ACTH weakly
Somatocrinin (GRH)	44	Growth hormone (GH) release
Somatostatin (GIH)	14	GH release inhibited
Hypothalamic gastrin-releasing peptide		Inhibits release of GH and PRL
Prolactin-releasing factor (PRF)		Releases prolactin (PRL)
Prolactin release-inhibiting factor (PIF)		Evidence that a new peptide may inhibit PRL release; dopamine also inhibits PRL release and was thought to be PIF for some time; dopamine may be a secondary PIF; oxytocin may inhibit PRL release

^a Melanocyte-stimulating hormone (MSH) is a major product of the *pars intermedia* (Figure 20.5) in the rat and is under the control of aminergic neurons. Humans may also secrete α -MSH from *pars intermedia*-like cells although this structure is anatomically indistinct in the human.

CLINICAL CORRELATION 20.1

Testing Activity of the Anterior Pituitary

Releasing hormones and chemical analogs, particularly of the smaller peptides, are now routinely synthesized. The gonadotropin-releasing hormone, a decapeptide, is available for use in assessing the function of the anterior pituitary. This is of importance when a disease situation may involve either the hypothalamus, the anterior pituitary, or the end organ. Infertility is an example of such a situation. What needs to be assessed is which organ is at fault in the hormonal cascade. Initially, the end organ, in this case the gonads, must be considered. This can be accomplished by injecting the anterior pituitary hormone LH or FSH. If sex hormone secretion is elicited, then the ultimate gland would appear to be functioning properly. Next, the anterior pituitary would need to be analyzed. This can be done by i.v. administration of synthetic GnRH; by this route GnRH can gain access to the gonadotropic cells of the anterior pituitary and elicit secretion of LH and FSH. Routinely, LH levels are measured in the blood as a function of time after the injection. These levels are measured by radioimmunoassay (RIA) in which radioactive LH or hCG is displaced from binding to an LH-binding protein by LH in the serum sample. The extent of the competition is proportional to the amount of LH in the serum. In this way a progress of response is measured that will be within normal limits or clearly deficient. If the response is deficient, the anterior pituitary cells are not functioning normally and are the cause of the syndrome. On the other hand, normal pituitary response to GnRH would indicate that the hypothalamus was nonfunctional. Such a finding would prompt examination of the hypothalamus for conditions leading to insufficient availability/production of releasing hormones. Obviously, the knowledge of hormone structure and the ability to synthesize specific hormones permit the diagnosis of these disease states.

Marshall, J. C., and Barkan, A. L. Disorders of the hypothalamus and anterior pituitary. In: W. N. Kelley (Ed.), *Internal Medicine*. New York: Lippincott, 1989, p. 2159; and Conn, P. M. The molecular basis of gonadotropin-releasing hormone action. *Endocr. Rev.* 7:3, 1986.

short feedback loops. In the long feedback loop, the final hormone binds a cognate receptor in/on cells of the anterior pituitary, hypothalamus, and CNS to prevent further elaboration of hormones from those cells that are involved in the cascade. The short feedback loop is accounted for by the pituitary hormone that feeds back negatively on the hypothalamus operating through a cognate receptor. In ultra-short feedback loops the hypothalamic releasing factor feeds back at the level of the hypothalamus to inhibit further secretion of this releasing factor. These mechanisms provide tight controls on the operation of the cascade, responding to stimulating signals as well as negative feedback, and render this system highly responsive to the hormonal milieu. Clinical Correlation 20.1 describes approaches for testing the responsiveness of the anterior pituitary gland.

Polypeptide Hormones of the Anterior Pituitary

The polypeptide hormones of the anterior pituitary are shown in Figure 20.4 together with their controlling hormones from the hypothalamus. The major

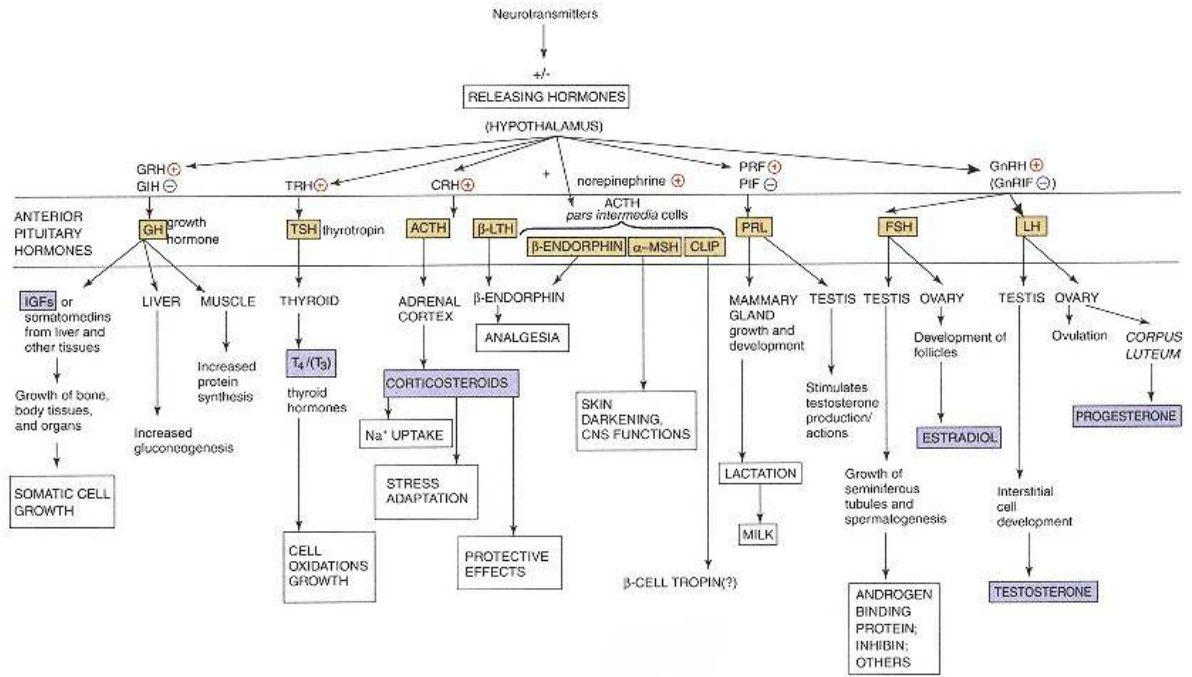

Figure 20.4
Overview of anterior pituitary hormones with hypothalamic releasing hormones and their actions.

CLINICAL CORRELATION 20.2**Hypopituitarism**

The hypothalamus is connected to the anterior pituitary by a delicate stalk that contains the portal system through which releasing hormones, secreted from the hypothalamus, gain access to the anterior pituitary cells. In the cell membranes of these cells are specific receptors for releasing hormones. In most cases, different cells express different releasing hormone receptors. The connection between the hypothalamus and anterior pituitary can be disrupted by trauma or tumors. Trauma can occur in automobile accidents or other local damaging events that may result in severing of the stalk and preventing the releasing hormones from reaching their target anterior pituitary cells. When this happens, the anterior pituitary cells no longer have their signaling mechanism for the release of anterior pituitary hormones. In the case of tumors of the pituitary gland, all of the anterior pituitary hormones may not be shut off to the same degree or the secretion of some may disappear sooner than others. In any case, if hypopituitarism occurs this condition may result in a life-threatening situation in which the clinician must determine the extent of loss of pituitary hormones, especially ACTH. Posterior pituitary hormones—oxytocin and vasopressin—may also be lost, precipitating a problem of excessive urination (vasopressin deficiency) that must be addressed. The usual therapy involves administration of the end organ hormones, such as thyroid hormone, cortisol, sex hormones, and progestin; with female patients it is also necessary to maintain the ovarian cycle. These hormones can easily be administered in oral form. Growth hormone deficiency is not a problem in the adult but would be an important problem in a growing child. The patient must learn to anticipate needed increases of cortisol in the face of stressful situations. Fortunately, these patients are usually maintained in reasonably good condition.

Marshall, J. C., and Barkan, A. L. Disorders of the hypothalamus and anterior pituitary. In: W. N. Kelley (Ed.), *Internal Medicine*. New York: Lippincott, 1989, p. 2159; and Robinson, A. G. Disorders of the posterior pituitary. In: W. N. Kelley (Ed.), *Internal Medicine*, New York: Lippincott, 1989, p. 2172.

hormones of the anterior pituitary are growth hormone (GH), thyrotropin or thyroid-stimulating hormone (TSH), adrenocorticotrophic hormone (ACTH), β -lipotropin (β -LTH), β -endorphin (from *pars intermedia*-like cells), α -MSH (from *pars intermedia*-like cells), β -MSH (from *pars intermedia*-like cells), corticotropin-like intermediary peptide (CLIP; from *pars intermedia*-like cells), prolactin (PRL), follicle-stimulating hormone (FSH), and luteinizing hormone (LH). Of these, all are single polypeptide chains, except TSH, FSH, and LH, which are dimers that share a similar or identical subunit, the α subunit. Since the intermediate lobe in humans is rudimentary, the circulating levels of free α - and β -MSH are relatively low. It is of interest, particularly in the human, that MSH receptors recognize and are activated by ACTH, since the first 13 amino acids of ACTH contain the α -MSH sequence. For this reason, ACTH may be an important contributing factor to skin pigmentation and may exceed the importance of MSH, especially in conditions where the circulating level of ACTH is high. The clinical consequences of hypopituitarism are presented in Clin. Corr. 20.2.

20.3—**Major Polypeptide Hormones and Their Actions**

Since cellular communication is so specific, it is not surprising that there are a large number of hormones in the body and new hormones continue to be discovered. Limitations of space permit a summary of only a few of the well-characterized hormones. Table 20.2 presents some major polypeptide hormones and their actions. By inspection of Table 20.2 it becomes evident that many hormones cause the release of other substances, some of which may themselves be hormones. This is particularly the case for hormonal systems that are included in cascades like that presented in Figures 20.2 and 20.3. Other activities of receptor-hormone complexes located in cell membranes are to increase the flux of ions into cells, particularly calcium ions, and to activate or suppress activities of enzymes in contact with the receptor or a transducing protein with which the receptor interacts. Examples of these kinds of activities are discussed later in this chapter. In the functioning of most membrane-receptor complexes,

TABLE 20.2 Important Polypeptide Hormones in the Body and Their Actions^a

Source	Hormone	Action
Hypothalamus	Thyrotropin-releasing hormone (TRH)	Acts on thyrotrope to release TSH
	Gonadotropin-releasing hormone (GnRH)	Acts on gonadotrope to release LH and FSH from the same cell
	Growth hormone-releasing hormone or somatocrinin (GRH)	Acts on somatotrope to release GH
	Growth hormone release inhibiting hormone or somatostatin (GIH)	Acts on somatotrope to prevent release of GH
	Corticotropin-releasing hormone (CRH) Vasopressin is a helper hormone to CRH in releasing ACTH; angiotensin II also stimulates CRH action in releasing ACTH	Acts on corticotrope to release ACTH and β -li-potropin
	Prolactin-releasing factor (PRF) (not well established)	Acts on lactotrope to release PRL
	Prolactin release inhibiting factor (PIF) (not well established; may be a peptide hormone under control of dopamine or may be dopamine itself)	Acts on lactotrope to inhibit release of PRL
Anterior pituitary	Thyrotropin (TSH)	Acts on thyroid follicle cells to bring about release of T_4 (T_3)
	Luteinizing hormone (LH) (human chorionic gonadotropin, hCG, is a similar hormone from the placenta)	Acts on Leydig cells of testis to increase testosterone synthesis and release; acts on corpus luteum of ovary to increase progesterone production and release
	Follicle-stimulating hormone (FSH)	Acts on Sertoli cells of seminiferous tubule to increase proteins in sperm and other proteins; acts on ovarian follicles to stimulate maturation of ovum and production of estradiol
	Growth hormone (GH)	Acts on a variety of cells to produce IGFs (or somatomedins), cell growth, and bone sulfation
	Adrenocorticotrophic hormone (ACTH)	Acts on cells in the adrenal gland to increase cortisol production and secretion
	β -Endorphin	Acts on cells and neurons to produce analgesic and other effects
	Prolactin (PRL)	Acts on mammary gland to cause differentiation of secretory cells (with other hormones) and to stimulate synthesis of components of milk
Ultimate gland hormones	Melanocyte-stimulating hormone (MSH)	Acts on skin cells to cause the dispersion of melanin (skin darkening)
	Insulin-like growth factors (IGF)	Respond to GH and produce growth effects by stimulating cell mitosis
	Thyroid hormone (T_4 / T_3) (amino acid-derived hormone)	Responds to TSH and stimulates oxidation in many cells
	Opioid peptides	May derive as breakdown products of γ -lipotropin or β -endorphin or from specific gene products; can respond to CRH or dopamine and may produce analgesia and other effects
	Inhibin	Responds to FSH in ovary and in Sertoli cell; regulates secretion of FSH from anterior pituitary. Second form of inhibin (activin) may stimulate FSH secretion
	Corticotropin-like intermediary peptide (CLIP)	Derives from intermediate pituitary by degradation of ACTH; contains β -cell tropin activity, which stimulates insulin release from β cells in presence of glucose

(continued)

TABLE 20.2 (Continued)

Source	Hormone	Action
Peptide hormones responding to other signals than anterior pituitary hormones	Arginine vasopressin (AVP; antidiuretic hormone, ADH)	Responds to increase in osmoreceptor, which senses extracellular $[Na^+]$; increases water reabsorption from distal kidney tubule
	Oxytocin	Responds to suckling reflex and estradiol; causes milk "let down" or ejection in lactating female, involved in uterine contractions of labor; luteolytic factor produced by <i>corpus luteum</i> ; decreases steroid synthesis in testis
β Cells of pancreas respond to glucose and other blood constituents to release insulin	Insulin	Increases tissue utilization of glucose
α Cells of pancreas respond to low levels of glucose and falling serum calcium	Glucagon	Decreases tissue utilization of glucose to elevate blood glucose
Derived from circulating blood protein by actions of renin and converting enzyme	Angiotensin II and III (AII and AIII)	Renin initially responds to decreased blood volume or decreased $[Na^+]$ in the <i>macula densa</i> of the kidney. AII/AIII stimulate outer layer of adrenal cells to synthesize and release aldosterone
Released from heart atria in response to hypovolemia; regulated by other hormones	Atrial natriuretic factor (ANF) or atriopeptin	Acts on outer adrenal cells to decrease aldosterone release; has other effects also
Generates from plasma, gut, or other tissues	Bradykinin	Modulates extensive vasodilation resulting in hypotension
Hypothalamus and intestinal mucosa	Neurotensin	Effects on gut; may have neurotransmitter actions
Hypothalamus, CNS, and intestine	Substance P	Pain transmitter, increases smooth muscle contractions of the GI tract
Nerves and endocrine cells of gut; hypothalamic hormone	Bombesin	Increases gastric acid secretion
	Cholecystokinin (CCK)	Stimulates gallbladder contraction and bile flow; increases secretion of pancreatic enzymes
Stomach antrum	Gastrin	Increases secretion of gastric acid and pepsin
Duodenum at pH values below 4.5	Secretin	Stimulates pancreatic acinar cells to release bicarbonate and water to elevate duodenal pH
Hypothalamus and GI tract	Vasointestinal peptide (VIP)	Acts as a neurotransmitter in peripheral autonomic nervous system; relaxes smooth muscles of circulation; increases secretion of water and electrolytes from pancreas and gut
Kidney	Erythropoietin	Acts on bone marrow for terminal differentiation and initiates hemoglobin synthesis
Ovarian corpus luteum	Relaxin	Inhibits myometrial contractions; its secretion increases during gestation
	Human placental lactogen (hPL)	Acts like PRL and GH because of large amount of hPL produced
Salivary gland	Epidermal growth factor	Stimulates proliferations of cells derived from ectoderm and mesoderm together with serum; inhibits gastric secretion
Thymus	Thymopoietin (α -thymosin)	Stimulates phagocytes; stimulates differentiation of precursors into immune competent T cells

(table continued on next page)

TABLE 20.2 (Continued)

Source	Hormone	Action
Parafollicular C cells of thyroid gland	Calcitonin (CT)	Lowers serum calcium
Parathyroid glands	Parathyroid hormone (PTH)	Stimulates bone resorption; stimulates phosphate excretion by kidney; raises serum calcium levels
Endothelial cells of blood vessels	Endothelin	Vasoconstriction

Source: Part of this table is reproduced from Norman, A. W., and Litwack, G. *Hormones*. Orlando, FL: Academic Press, 1987.

^a This is only a partial list of polypeptide hormones in humans. TSH, thyroid-stimulating hormone or thyrotropin; LH, luteinizing hormone, FSH, follicle-stimulating hormone; GH, growth hormone; ACTH, adrenocorticotropic hormone; PRL, prolactin; T₄, thyroid hormone (also T); IGF, insulin-like growth factor. For the releasing hormones and for some hormones in other categories, the abbreviation may contain "H" at the end when the hormone has been well characterized, and "F" in place of H to refer to "Factor" when the hormone has not been well characterized. Names of hormones may contain "tropic" or "trophic" endings, tropic is mainly used here. Tropic refers to a hormone generating a change, whereas trophic refers to growth promotion. Both terms can refer to the same hormone at different stages of development. Many of these hormones have effects in addition to those listed here.

stimulation of enzymes or flux of ions is followed by a chain of events, which may be described as intracellular cascades, during which a high degree of amplification is obtained.

20.4—

Genes and Formation of Polypeptide Hormones

Genes for polypeptide hormones contain the information for the hormone and the control elements upstream of the transcriptionally active sequence. In some cases, more than one hormone is encoded in a gene. One example is **proopiomelanocortin**, a hormone precursor that encodes the following hormones: ACTH, β -lipotropin, and other hormones like γ -lipotropin, γ -MSH, α -MSH, CLIP, β -endorphin, and potentially β -MSH and enkephalins. In the case of the posterior pituitary hormones, oxytocin and vasopressin, information for these hormones are each encoded on a separate gene together with information for each respective **neurophysin**, a protein that binds to the completed hormone and stabilizes it.

Proopiomelanocortin Is a Precursor Polypeptide for Eight Hormones

Proopiomelanocortin, as schematized in Figure 20.5, can generate at least eight hormones from a single gene product. All products are not expressed simultaneously in a single cell type, but occur in separate cells based on their content of specific proteases required to cleave the propeptide, specific metabolic controls, and the presence of different positive regulators. Thus, while proopiomelanocortin is expressed in both the corticotropic cell of the anterior pituitary and the *pars intermedia* cell, the stimuli and products are different as summarized in Table 20.3. The *pars intermedia* is a discrete anatomical structure located between the anterior and posterior pituitary in the rat (Figure 20.6). In the human, however, the *pars intermedia* is not a discrete anatomical structure, although the cell type may be present in the equivalent location.

Many Polypeptide Hormones Are Encoded Together in a Single Gene

An example of another gene and gene products encoding more than one peptide are the genes for vasopressin and oxytocin and their accompanying neurophysin proteins, products that are released from the posterior pituitary upon specific stimulation. In much the same manner that ACTH and β -lipotropin

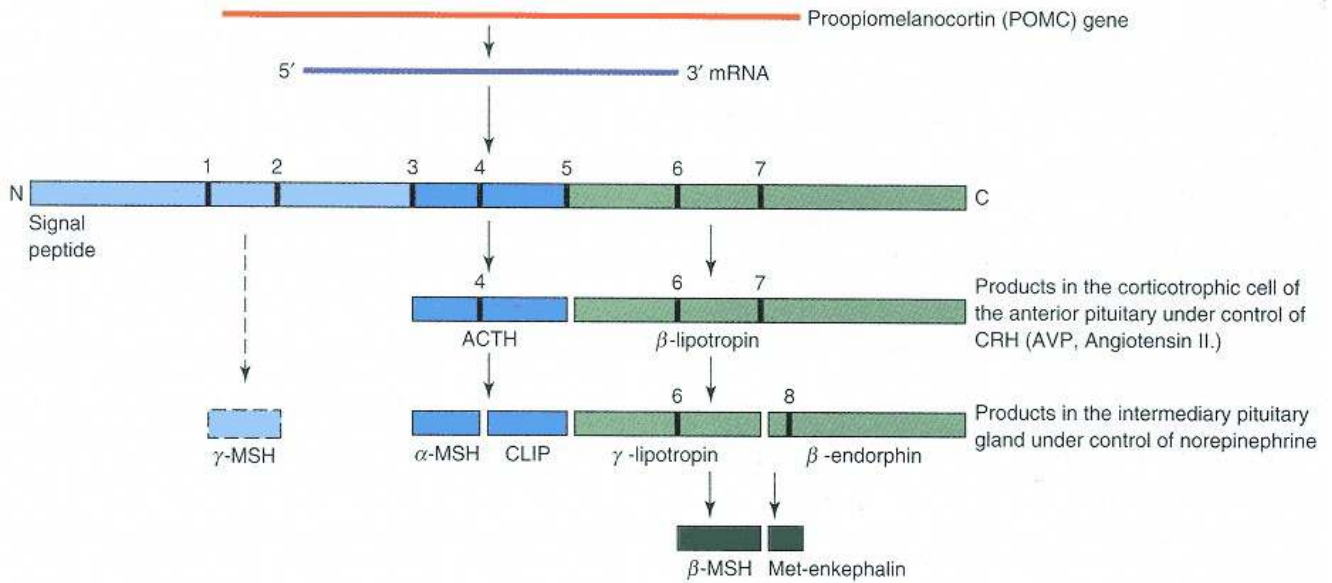

Figure 20.5

Proopiomelanocortin is a polypeptide product encoded by a single gene.

The dark vertical bars represent proteolytic cleavage sites for specific enzymes. The cleavage sites are Arg-Lys, Lys-Arg, or Lys-Lys. Some specificity also may be conferred by neighboring amino acid residues. In the corticotrophic cell of the anterior pituitary, enzymes are present that cleave at sites 3 and 5, releasing the major products, ACTH and β -lipotropin, into the general circulation. In the pars intermedia, especially in vertebrates below humans, these products are further cleaved at major sites 4, 6, and 7 to release α -MSH, CLIP, γ -lipotropin, and β -endorphin into the general circulation. Some β -lipotropin arising in the corticotroph may be further degraded to form β -endorphin. These two cell types appear to be under separate controls. The corticotrophic cell of the anterior pituitary is under the positive control of the CRH and its auxiliary helpers, arginine vasopressin (AVP) and angiotensin II. AVP by itself does not release ACTH but enhances the action of CRH in this process. The products of the intermediary pituitary, α -MSH, CLIP (corticotropin-like intermediary peptide), γ -lipotropin, and β -endorphin, are under the positive control of norepinephrine, rather than CRH, for release. Obviously there must exist different proteases in these different cell types in order to generate a specific array of hormonal products. β -Endorphin also contains a pentapeptide, enkephalin, which potentially could be released at some point (hydrolysis at 8).

TABLE 20.3 Summary of Stimuli and Products of Proopiomelanocortin^a

Cell type	Corticotroph	Pars intermedia
Stimulus	CRH (+) (Cortisol (-))	Dopamine (-) Norepinephrine (+)
Auxiliary stimulus	AVP, AII	
Major products	ACTH, β -lipotropin (β -endorphin)	α MSH, CLIP, γ -lipotropin, β -endorphin

^a CRH, corticotropin-releasing hormone; AVP, arginine vasopressin; AII, angiotensin II; ACTH, adrenocorticotropin; α -MSH, α melanocyte-stimulating hormone; CLIP, corticotropin-like intermediary peptide.

Note: Although there are pars intermedia cells in the human pituitary gland, they do not represent a distinct lobe.

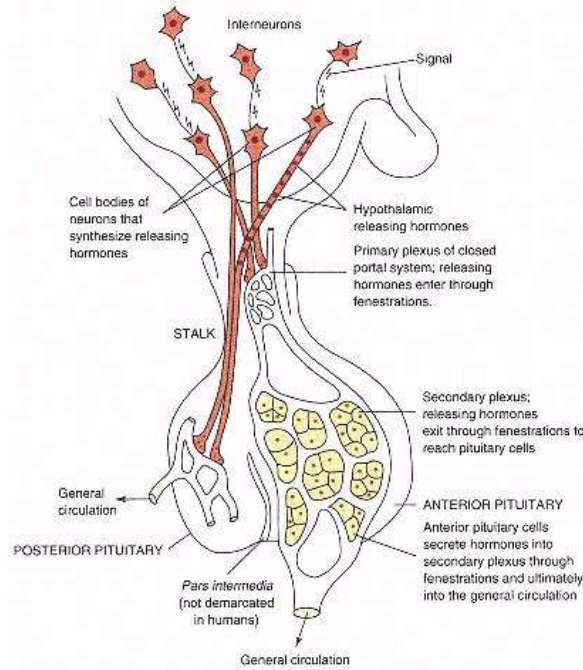

Figure 20.6
The hypothalamus with nuclei in various locations in which the hypothalamic releasing hormones are synthesized.
 Shown is the major vascular network consisting of a primary plexus where releasing hormones enter its circulation through fenestrations and the secondary plexus in the anterior pituitary where the releasing hormones are transported out of the circulation, again through fenestrations in the vessels, to the region of the anterior pituitary target cells. Also shown are the resultant effects of the actions of the hypothalamic releasing hormones causing the secretion into the general circulation of the anterior pituitary hormones. Adapted from Norman, A. W., and Litwack, G. *Hormones*. New York: Academic Press, 1987, p. 104.

(β -LPH) are split out of the proopiomelanocortin precursor peptide, so are the products vasopressin, neurophysin II, and a glycoprotein of as yet unknown function split out of the vasopressin precursor. A similar situation exists for oxytocin and neurophysin I (Figure 20.7).

Vasopressin and neurophysin II are released by the activity of baroreceptors and osmoreceptors, which sense a fall in blood pressure or a rise in extracellular sodium ion concentration, respectively. Generally, **oxytocin** and

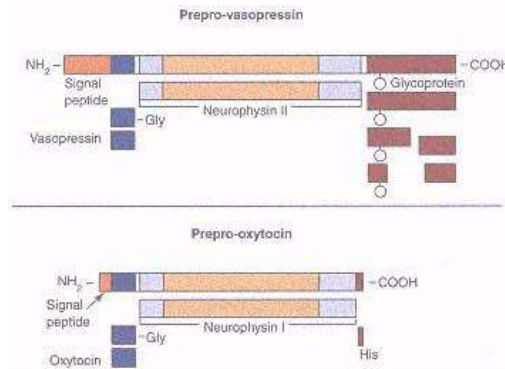

Figure 20.7
Prepro-vasopressin and prepro-oxytocin.
 Proteolytic maturation proceeds from top to bottom for each precursor. The organization of the gene translation products is similar in either case except that a glycopeptide is included on the proprotein of vasopressin in the C-terminal region. Orange bars of the neurophysin represent conserved amino acid regions; gray bars represent variable C and N termini. Redrawn with permission from Richter, D. VP and OT are expressed as polyproteins. *Trends Biochem.* 8:278, 1983.

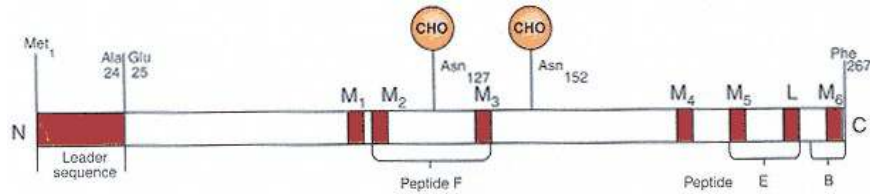

Figure 20.8
Model of enkephalin precursor.

The distribution of Met-enkephalin sequences (M_1 – M_6) and Leu-enkephalin (L) sequences within the protein precursor of bovine adrenal medulla. CHO, potential carbohydrate attachment sites. Redrawn from Comb, M., Seeburg, P. H., Adelman, J., Eiden, L., and Herbert, E. *Nature* 295:663, 1982.

neurophysin I are released from the posterior pituitary by the suckling response in lactating females or by other stimuli mediated by a specific cholinergic mechanism. Oxytocin–neurophysin I release can be triggered by injection of estradiol. Release of vasopressin–neurophysin II can be stimulated by administration of nicotine. The two separate and specific releasing agents, estradiol and nicotine, prove that oxytocin and vasopressin, together with their respective neurophysins, are synthesized and released from different cell types. Although oxytocin is well known for its milk-releasing action in the lactating female, in the male it seems to have a separate role associated with an increase in testosterone synthesis in the testes.

Other polypeptide hormones are being discovered that are co-encoded together by a single gene. An example is the discovery of the gene encoding GnRH, a decapeptide that appears to reside to the left of a gene for the GnRH-associated peptide (GAP), which, like dopamine, may be capable of inhibiting prolactin release. Thus both hormones—GnRH and the prolactin release inhibiting factor GAP—appear to be co-secreted by the same hypothalamic cells.

Multiple Copies of a Hormone Can Be Encoded on a Single Gene

An example of multiple copies of a single hormone encoded on a single gene is the gene product for enkephalins located in the chromaffin cell of the adrenal medulla. **Enkephalins** are pentapeptides with opioid activity; methionine-enkephalin (Met-ENK) and leucine-enkephalin (Leu-ENK) have the structures:

Tyr-Gly-Gly-Phe-Met (Met-ENK)

Tyr-Gly-Gly-Phe-Leu (Leu-ENK)

A model of enkephalin precursor in adrenal medulla is presented in Figure 20.8, which encodes several Met-ENK (M) molecules and a molecule of Leu-

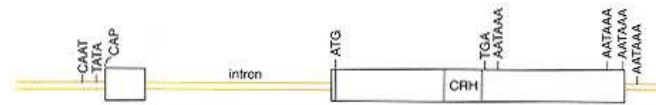

Figure 20.9
Nucleic acid sequence for rat proCRH genes.

Representation of the rat proCRH gene. Exons are shown as blocks and the intron by a double red line. The TATA and CAAT sequence, putative cap site, translation initiation ATG, translation terminator TGA, and poly(A) addition signals (AATAAA) are indicated.

The location of the CRH peptide is indicated by CRH.

Redrawn from Thompson, R. D., Seasholz, A. F., and Herbert, E. *Mol. Endocrinol.* 1:363, 1987.

ENK (L). Again, the processing sites to release enkephalin molecules from the protein precursor involve Lys–Arg, Arg–Arg, and Lys–Lys bonds.

Many genes for hormones are constructed to encode only one hormone and this may be the general situation. An example of a single hormone gene is shown in Figure 20.9. In this case the information for the hormone CRH is contained in the second exon and the information in the first exon is not expressed. Having cDNAs for use as probes that contain the information for expression of CRH allows for the localization of the hormone in tissues. Previously it was thought that the hormone should be restricted to the hypothalamus, the anterior pituitary, and the stalk, which contains the closed vascular transporting system (Figure 20.6). However, RNA extracts from different tissues probed with this DNA reveal the location of CRH mRNA in testis, brain stem, and adrenal gland in addition to pituitary and hypothalamus. The presence of the hormone in extrahypothalamic–pituitary axis tissues and its functions there are subjects of active investigation.

20.5—

Synthesis of Amino Acid-Derived Hormones

Many hormones and neurotransmitters are derived from amino acids, principally from tyrosine and phenylalanine. Glutamate, aspartate, and other compounds are important neurotransmitter substances as well. Although there may be some confusion about which compounds are neurotransmitters and which are hormones, it is clear that epinephrine from the adrenal medulla is a hormone, whereas norepinephrine is a neurotransmitter. This section considers epinephrine and thyroxine or triiodothyronine. The other biogenic amines, such as dopamine, which are considered to be neurotransmitters, are discussed in Chapter 22.

Epinephrine Is Synthesized from Phenylalanine/Tyrosine

The synthesis of epinephrine occurs in the adrenal medulla. A number of steroid hormones, including aldosterone, cortisol, and dehydroepiandrosterone (sulfate), are produced in the adrenal cortex and are discussed in Chapter 21. The biochemical reactions leading to the formation of **epinephrine** from tyrosine or phenylalanine are presented in Figure 20.10. Epinephrine is a principal hormone secreted from the adrenal medulla chromaffin cell along with some norepinephrine, enkephalins, and some of the enzyme *dopamine- β -hydroxylase*. Secretion of epinephrine is signaled by the neural response to stress, which is transmitted to the adrenal medulla by way of a preganglionic acetylcholinergic neuron (Figure 20.11). Release of acetylcholine by the neuron increases the availability of intracellular calcium ion, which stimulates exocytosis and release of the material stored in the **chromaffin granules** (Figure 20.11b). This overall system of epinephrine synthesis, storage, and release from the adrenal medulla is regulated by neuronal controls and also by glucocorticoid hormones synthesized in and secreted from the adrenal cortex in response to stress. Since the products of the adrenal cortex are transported through the adrenal medulla on their way out to the general circulation, cortisol becomes elevated in the medulla and induces **phenylethanolamine *N*-methyltransferase (PNMT)**, a key enzyme catalyzing the conversion of norepinephrine to epinephrine. Thus, in biochemical terms, the stress response at the level of the adrenal cortex ensures the production of epinephrine from the adrenal medulla (Figure 20.12). Presumably, epinephrine once secreted into the bloodstream not only affects α receptors of hepatocytes to ultimately increase blood glucose levels as indicated, but also interacts with α receptors on vascular smooth muscle cells and on pericytes to cause cellular contraction and increase blood pressure.

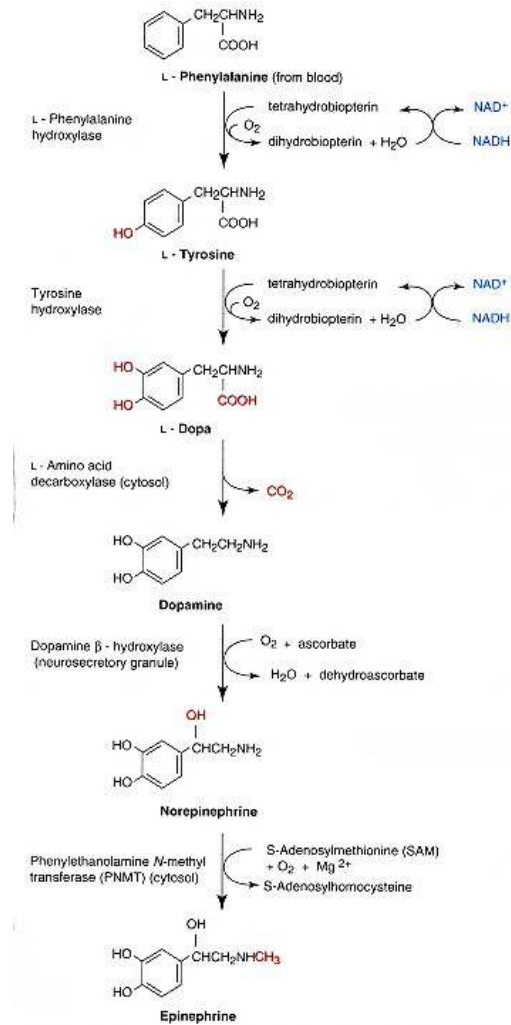

Figure 20.10
Biochemical steps in synthesis of epinephrine by chromaffin cell of adrenal medulla.

Synthesis of Thyroid Hormone Requires Incorporation of Iodine into a Tyrosine of Thyroglobulin

An outline of the biosynthesis and secretion of thyroid hormone, **tetraiodo-L-thyronine (T_4)**, also called **thyroxine**, and its active cellular counterpart, **triiodo-L-thyronine (T_3)** (structures presented in Figure 20.13) is presented in Figure 20.14. The thyroid gland is differentiated to concentrate iodide from the blood and through the series of reactions shown in Figures 20.13 and 20.14, monoiodotyrosine (MIT), diiodotyrosine (DIT), T_4 , and T_3 are produced within **thyroglobulin** (TG). Thus the iodinated amino acids and thyronines are stored in the thyroid follicle as part of thyroglobulin. Recent work indicates that there

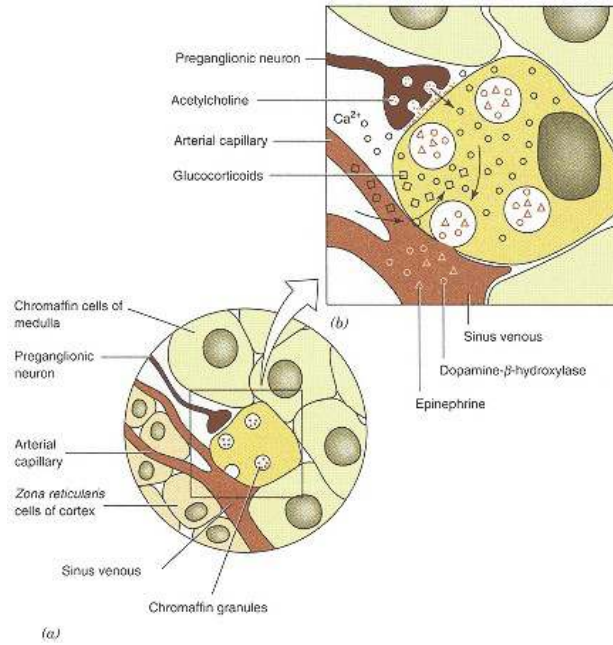

Figure 20.11
Relationship of adrenal medulla chromaffin cells to preganglionic neuron innervation and the structural elements involved in the synthesis of epinephrine and the discharge of catecholamines in response to acetylcholine.
 (a) Functional relationship between cortex and medulla for control of synthesis of adrenal catecholamines. Glucocorticoids that stimulate enzymes catalyzing the conversion of norepinephrine to epinephrine reach the chromaffin cells from capillaries shown in (b).
 (b) Discharge of catecholamines from storage granules in chromaffin cells after nerve fiber stimulation, resulting in the release of acetylcholine. Calcium enters the cells as a result, causing the fusion of granular membranes with the plasma membrane and exocytosis of the contents.
 Reprinted with permission from Krieger, D. T., and Hughes, J. C. (Eds.). *Neuroendocrinology*. Sunderland, MA: Sinauer Associates, 1980.

are hot spots (regions for very active iodination) in the thyroglobulin sequence for the incorporation of iodine. Apparently, the sequences around iodotyrosyls occur in three consensus groups: Glu/Asp-Tyr, associated with the synthesis of thyroxine or iodotyrosines; Ser/Thr-Tyr-Ser, associated with the synthesis of

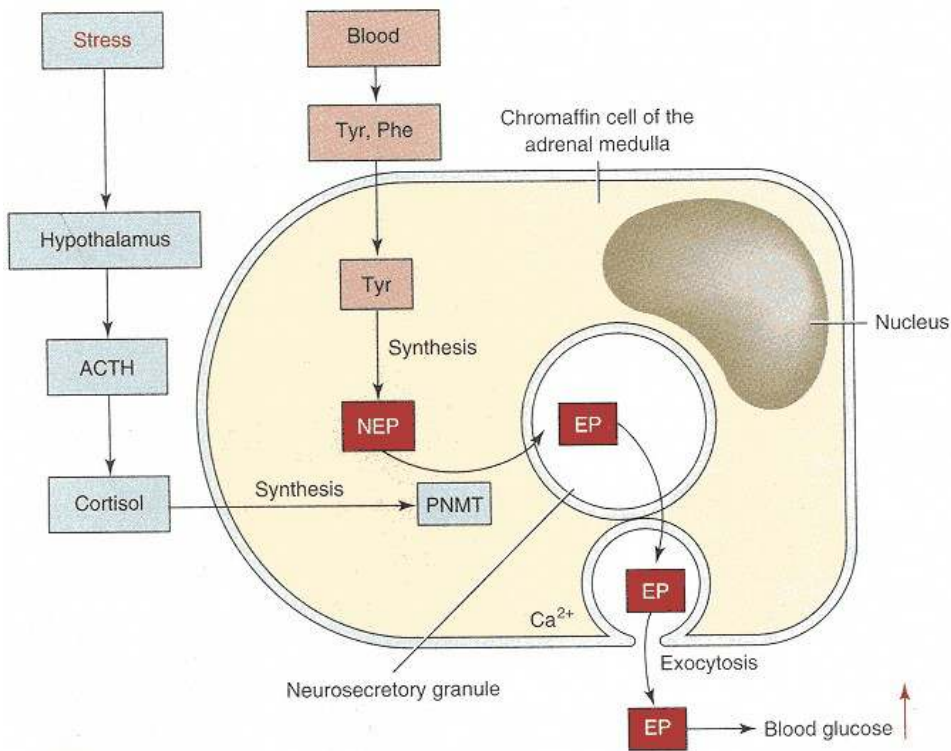

Figure 20.12
Biosynthesis, packaging, and release of epinephrine in the adrenal medulla chromaffin cell.

PNMT, phenylethanolamine N-methyltransferase; EP, epinephrine; NEP, norepinephrine. Neurosecretory granules contain epinephrine, dopamine β-hydroxylase, ATP, Met- or Leu-enkephalin, as well as larger enkephalin-containing peptides or norepinephrine in place of epinephrine. Epinephrine and norepinephrine are stored in different cells. Enkephalins could also be contained in separate cells, although that is not completely clear.

Adapted from Norman, A. W., and Litwack, G. *Hormones*. New York: Academic Press, 1987, p. 464.

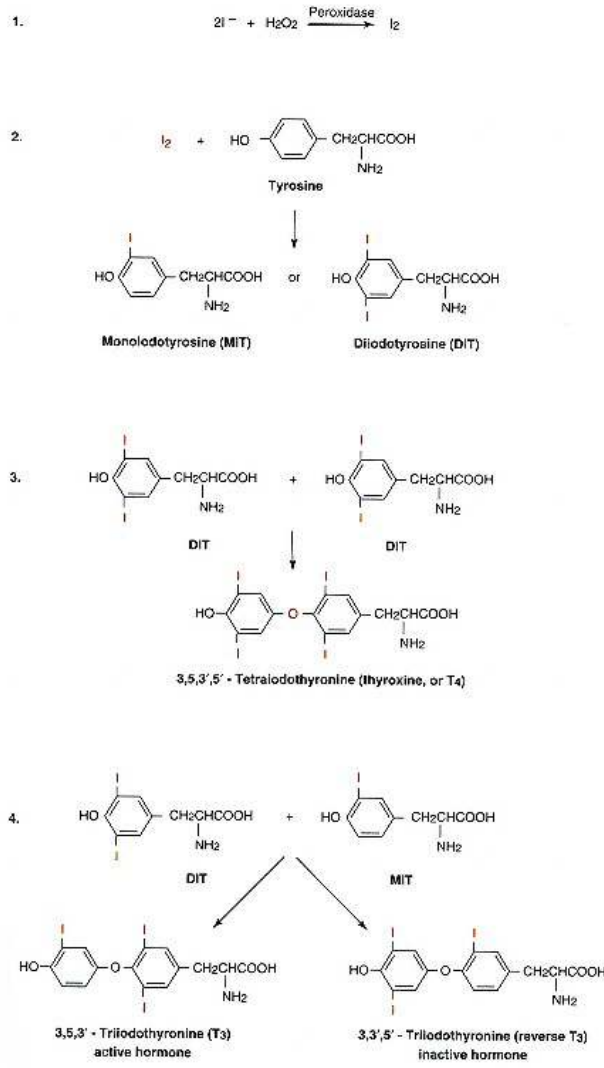

Figure 20.13
Synthesis and structures of thyroid hormones T₄, T₃, and reverse T₃.

- Step 1, oxidation of iodide;
 - Step 2, iodination of tyrosine residues;
 - Step 3, coupling of DIT to DIT;
 - Step 4, coupling of DIT to MIT
- (coupling may be intramolecular or intermolecular).

iodothyronine and iodotyrosine; and Glu-X-Tyr, associated with the remaining iodotyrosyls in the sequence. As depicted in Figure 20.14, secretion of T₃ and T₄ into the bloodstream requires endocytosis of the thyroglobulin stored in the follicle and subsequent proteolysis within the epithelial cell. The released DIT and MIT are then deiodinated and the released iodide ions are recycled and reutilized for hormone synthesis.

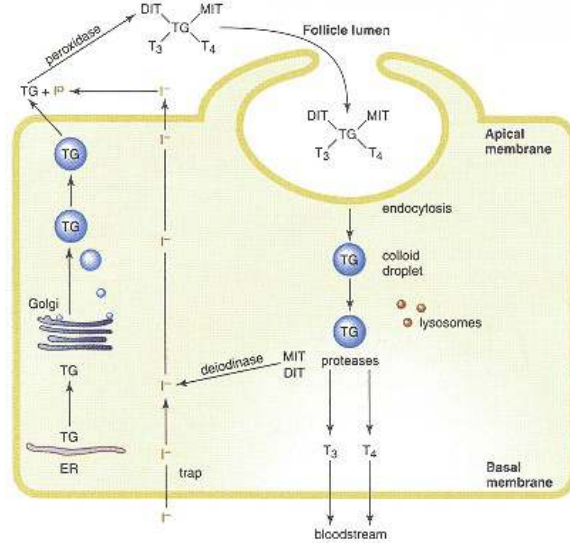

Figure 20.14

Cellular mechanisms for T₃ and T₄ release into the bloodstream.

Iodide trapping at basal membrane of thyroid epithelium concentrates iodide approximately 30-fold. Secretion of T₃ and T₄ into bloodstream requires endocytosis of thyroglobulin and subsequent proteolysis. DIT and MIT are deiodinated and the released iodide ions are reutilized for hormone synthesis.

**20.6—
Inactivation and Degradation of Hormones**

Most polypeptide hormones are degraded to amino acids by hydrolysis, which presumably occurs in the **lysosome**. Partial hydrolysis by proteinases is a principal pathway for degradation. Certain hormones, however, contain modified amino acids; for example, among the hypothalamic releasing hormones, the N-terminal amino acid can be **cycloglutamic acid** (or pyroglutamic acid) (Table 20.4) and a C-terminal amino acid amide. Some of the releasing hormones

TABLE 20.4 Hypothalamic Releasing Hormones Containing an N-Terminal Pyroglutamate, ^a a C-Terminal Amino Acid Amide, or Both

Hormone	Sequence ^b
Thyrotropin-releasing hormone (TRH)	pGlu-H-Pro-NH ₂
Gonadotropin-releasing hormone (GnRH)	pGlu-HWSYGLRP-Gly-NH ₂
Corticotropin-releasing hormone (CRH)	SQEPPISLDLTFHLLREVLEMTKADQLAQQAHNSNRKLLDI-Ala-NH ₂
Somatocrinin (GRH)	YADAIFTNSYRKVLGQLSARKLLQDIMSRRQGESNQERG-ARAR-Leu-NH ₂

^a The pyroglutamate structure is

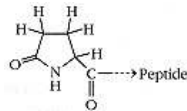

^b Single-letter abbreviations used for amino acids: Ala, A; Arg, R; Asn, N; Asp, D; Cys, C; Glu, E, Gln, Q; Gly, G; His, H; Ile, I; Leu, L; Lys, K; Met, M; Phe, F; Pro, P; Ser, S; Thr, T; Trp, W; Tyr, Y; Val, V.

that have either or both of these amino acid derivatives are listed in Table 20.4. Apparently, breakage of the cyclic glutamate ring or cleavage of the C-terminal amide can lead to inactivation of many of these hormones and such enzymic activities have been reported in blood. This activity probably accounts, in part, for the short half-life of many of these hormones.

TABLE 20.5 Examples of Hormones Containing a Cystine Disulfide Bridge Structure

Hormone	Sequence ^a
Somatostatin	
Oxytocin	
Arginine vasopressin	

^a Letters refer to single-letter amino acid abbreviations (see Table 20.4)

Some hormones contain a ring structure joined by a cystine disulfide bond. A few examples are given in Table 20.5. Peptide hormones, such as those shown in Table 20.5, may be degraded initially by the random action of **cystine aminopeptidase** and **glutathione transhydrogenase** as shown in Figure 20.15. Alternatively, as has been suggested in the case of oxytocin, the peptide may be broken down through partial proteolysis to shorter peptides, some of which may have hormonal actions on their own. Maturation of **prohormones** in many cases involves proteolysis, which may be considered as a degradation process in the sense that the prohormone is degraded to active forms (e.g., Figure 20.5), although degradation is usually thought of as the reduction of active peptides to inactive ones.

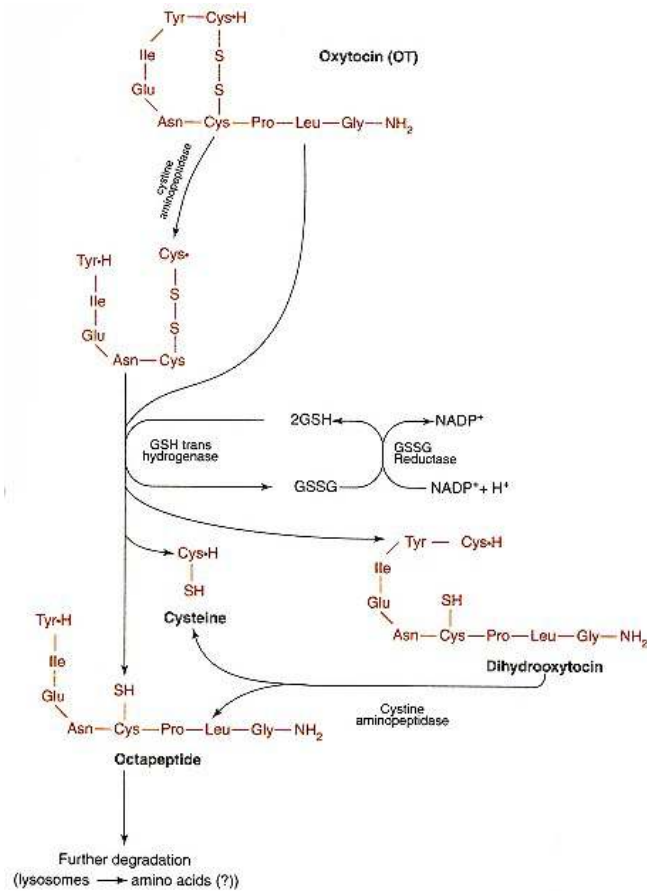

Figure 20.15
Degradation of posterior pituitary hormones.
 Oxytocin transhydrogenase is similar to degrading enzymes for insulin; presumably, these enzymes also degrade vasopressin.
 Redrawn from Norman, A. W., and Litwack, G. *Hormones*. New York: Academic Press, 1987, p. 167.

20.7—

Cell Regulation and Hormone Secretion

Hormonal secretion is under specific control. In the cascade system displayed in Figures 20.2 and 20.3, hormones must emanate from one source, cause hormonal release from the next cell type in line, and so on, down the cascade system. The correct responses must follow from a specific stimulus. The precision of these signals is defined by the hormone and the receptor as well as by the activities of the CNS, which precedes the first hormonal response in many cases. Certain generalizations can be made. Polypeptide hormones generally bind to their cognate receptors located in cell membranes. The receptor recognizes structural features of the hormone to generate a high degree of specificity and affinity. The affinity constants for these interactions are in the range of 10^9 – 10^{11} M^{-1} , representing tight binding. This interaction usually activates or complexes with a transducing protein in the membrane, such as a **G-protein** (GTP-binding protein), or other transducer and causes an activation of some enzymatic function on the cytoplasmic side of the membrane. In some cases receptors undergo **internalization** to the cell interior; these receptors may or may not (e.g., the insulin receptor) be coupled to transducing proteins in the cell membrane. A discussion of internalization of receptors is presented in Section 20.11. The "activated" receptor complex could physically open a membrane ion channel or have other profound impacts on membrane structure and function. For example, binding of the hormone to the receptor may cause conformational changes in the receptor molecule, enabling it to associate with transducer in which further conformational changes may occur to permit interaction with an enzyme on the cytoplasmic side of the plasma membrane. This interaction may cause conformational changes in an enzyme so that its catalytic site becomes active.

G-Proteins Serve as Cellular Transducers of Hormone Signals

Most transducers of receptors in the plasma membrane are GTP-binding proteins and are referred to as **G-proteins**. G-Proteins consist of three types of **subunits**— **α** , **β** , and **γ** . The **α subunit** is the guanine nucleotide-binding component and is thought to interact with the receptor indirectly through the **β** and **γ** subunits and then directly with an enzyme, such as adenylate cyclase, resulting in enzyme activation. Actually there are two forms of the **α** subunit, designated G_{α_s} for a stimulatory subunit and G_{α_i} for an inhibitory subunit. Two types of receptors, and thus hormones, control the adenylate cyclase reaction: hormone–receptors that lead to a stimulation of the adenylate cyclase and those that lead to an inhibition of the cyclase. This is depicted in Figure 20.16 with an indication of the role of G_{α_s} and G_{α_i} and some of the hormones that interact with the stimulatory and inhibitory receptors.

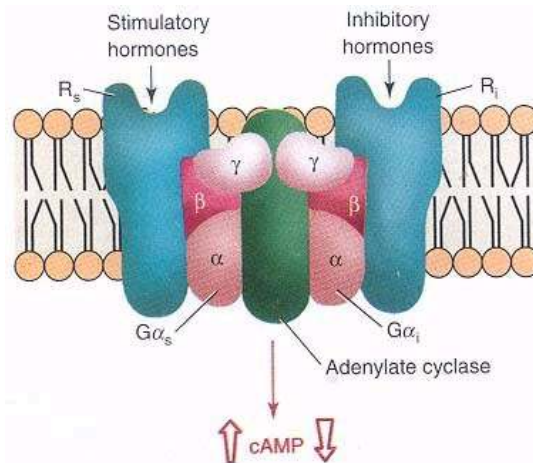

Figure 20.16

Components that constitute a hormone-sensitive adenylate cyclase system and the subunit composition.

Adenylate cyclase is responsible for conversion of ATP to cAMP. The occupancy of R_s by stimulatory hormones stimulates adenylate cyclase via formation of an active dissociated G_{α_s} subunit. The occupancy of R_i by inhibitory hormones results in the formation of an "active" G_{α_i} complex and concomitant reduction in cyclase activity. The fate of β and γ subunits in these dissociation reactions is not yet known. R_s , stimulatory hormone receptor; R_i , inhibitory hormone receptor.

The sequence of events that occurs when hormone and receptor interact is presented in Figure 20.17 and is as follows: receptor binds hormone in the membrane (Step 1); which produces a conformational change in receptor to expose a site for G-protein (β , γ subunit) attachment (Step 2); G-protein can be either stimulatory, G_s , or inhibitory, G_i , referring to the ultimate effects on the activity of adenylate cyclase; the receptor interacts with β , γ subunit of G-protein, enabling the α subunit to exchange GTP for bound GDP (Step 3); dissociation of GDP causes separation of G-protein α subunit from β , γ subunit and the α -binding site for interaction with adenylate cyclase appears on the surface of the G-protein α subunit (Step 4); α subunit binds to adenylate cyclase and activates the catalytic center, so that ATP is converted to cAMP (Step 5); GTP is hydrolyzed to GDP by the GTPase activity of the α subunit, returning it to its original conformation and allowing its interaction with β , γ subunit once again (Step 6); GDP associates with the α subunit and the system is returned to the unstimulated state awaiting another cycle of activity. It is important to note that there is also evidence suggesting that the β , γ complexes may play important roles in regulating certain effectors including adenylate cyclase.

In the case where an inhibitory G-protein is coupled to the receptor, the events are similar but inhibition of adenylate cyclase activity may arise by direct interaction of the inhibitory α subunit with adenylate cyclase or, alternatively, the inhibitory α subunit may interact directly with the stimulatory α subunit on the other side and prevent the stimulation of adenylate cyclase activity indirectly. Immunochemical evidence suggests multiple G_i subtypes and molecular cloning of complementary DNAs encoding putative α subunits has also provided evidence for multiple G_i subtypes.

Purification and biochemical characterization of G-proteins (G_s as well as G_i) have revealed somewhat unanticipated diversity in this subfamily. Polymerase chain reaction-based cloning has now brought the number of distinct genes encoding mammalian α subunits to at least 15. With regard to α subunits, further diversity is achieved by alternative splicing of the G_s (four forms) gene. There also appears to be diversity among the mammalian β and γ subunits. At least four distinct β subunit cDNAs and probably as many γ subunits have been described. What is not clear is how these complexes combine to form distinct β , γ complexes. Some data suggest that different β , γ complexes may have distinct properties with respect to α subunit and receptor interactions, but additional research will be required to fully describe these unique interactions.

Table 20.6 lists some activities transduced by G-protein subfamilies.

TABLE 20.6 Activities Transduced by G-Protein Subfamilies

α Subunit	Expression		Effector
G_s	Ubiquitous		Adenylate cyclase, Ca^{2+} channel
G_{olf}	Olfactory		Adenylate cyclase
G_{i1} (transducin)	Rod photoreceptors		cGMP-phosphodiesterase
G_{i2} (transducin)	Cone photoreceptors		cGMP-phosphodiesterase
G_{i1}	Neural > other tissues	}	Adenylate cyclase
G_{i2}	Ubiquitous		
G_{i3}	Other tissues > neural		
G_o	Neural, endocrine		Ca^{2+} channel
G_q	Ubiquitous	}	Phospholipase C
G_{11}	Ubiquitous		
G_{14}	Liver, lung, kidney		
$G_{15/16}$	Blood cells		

Source: Adapted from Spiegel, A. M., Shenker, A., and Weinstein, L. S. *Endocr. Rev.* 13:536, 1992.

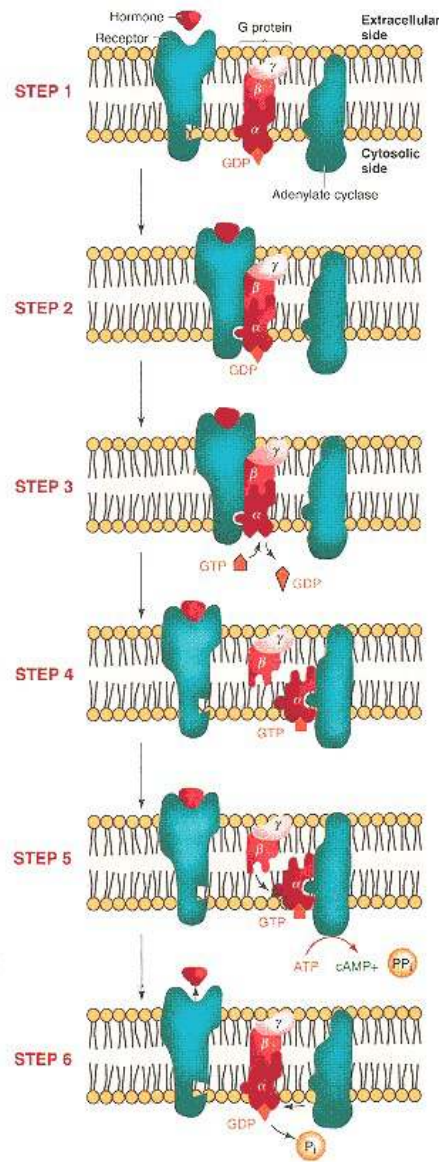

Figure 20.17
Activation of adenylate cyclase by binding
of a hormone to its receptor.

The cell membrane is depicted, which contains on its outer surface a receptor protein for a hormone. On the inside surface of the membrane is adenylate cyclase protein and the transducer protein G. In the resting state GDP is bound to the α subunit of the G-protein. When a hormone binds to the receptor, a conformational change occurs (Step 1). The activated receptor binds to the G-protein (Step 2), which activates the latter so that it releases GDP and binds GTP

(Step 3), causing the α and the complex of β and γ -subunits to dissociate

(Step 4). Free G_{α} subunit binds to the adenylate cyclase and activates it so that it catalyzes the synthesis of cAMP from ATP

(Step 5); this step may involve a conformational change in G_{α} .

In some cases the β, γ complex may play an important role in regulation of certain effectors including adenylate cyclase. When GTP is hydrolyzed to GDP, a reaction most likely catalyzed by G_{α} itself, G_{α} is no longer able to activate adenylate cyclase

(Step 6), and G_{α} and $G_{\beta\gamma}$ reassociate. The hormone dissociates from the receptor and the system returns to its resting state.

Redrawn from Darnell, J., Lodish, H., and Baltimore, D. *Molecular Cell Biology*. New York: Scientific American Books, 1986, p. 682.

Cyclic AMP Activates Protein Kinase A Pathway

The generation of cAMP in the cell usually activates protein kinase A, referred to as the **protein kinase A pathway**. The overall pathway is presented in Figure 20.18. Four cAMP molecules are used in the reaction to complex two regulatory subunits (R) and liberating two protein kinase catalytic subunits (C). The liberated catalytic subunits are able to phosphorylate proteins to produce a cellular effect. In many cases the cellular effect leads to the release of preformed hormones. For example, ACTH binds to membrane receptors, elevates intracellular **cAMP** levels, and releases cortisol from the *zona fasciculata* cells of the adrenal gland by this general mechanism. Part of the mechanism of release of thyroid hormones from the thyroid gland involves the cAMP pathway as outlined in Figure 20.19. TSH has been shown to stimulate numerous key steps in this secretory process, including iodide uptake and endocytosis of thyroglobulin (Figure 20.14). The protein kinase A pathway is also responsible for the release of testosterone by testicular Leydig cells as presented in Figure 20.20. There are many other examples of hormonal actions mediated by cAMP and the protein kinase A pathway.

Inositol Triphosphate Formation Leads to Release of Calcium from Intracellular Stores

Uptake of calcium from the cell exterior through calcium channels may be affected directly by hormone-receptor interaction at the cell membrane. In some cases, ligand-receptor interaction is thought to open calcium channels directly in the cell membrane (Chapter 5, Section 5.5). Another system to increase intracellular Ca^{2+} concentration derives from hormone-receptor activation of **phospholipase C** activity transduced by a G-protein (Figure 20.21).

A hormone operating through this system binds to a specific cell membrane receptor, which interacts with a G-protein in a mechanism similar to that of the protein kinase A pathway and transduces the signal, resulting in stimulation of phospholipase C. This enzyme catalyzes the hydrolysis of **phosphatidylinositol-4,5-bisphosphate (PIP₂)** to form two **second messengers, diacylglycerol (DAG)** and **inositol 1,4,5-triphosphate (IP₃)**.

Inositol 1,4,5-triphosphate diffuses to the cytosol and binds to an IP₃ receptor on the membrane of a particulate **calcium** store, either separate from or

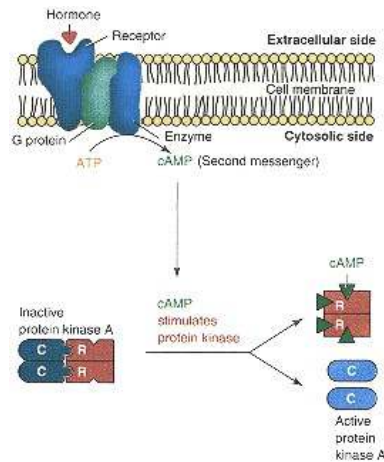

Figure 20.18
Activation of protein kinase A.
 Hormone-receptor mediated stimulation of adenylyl cyclase and subsequent activation of protein kinase A. C, catalytic subunit; R, regulatory subunit.

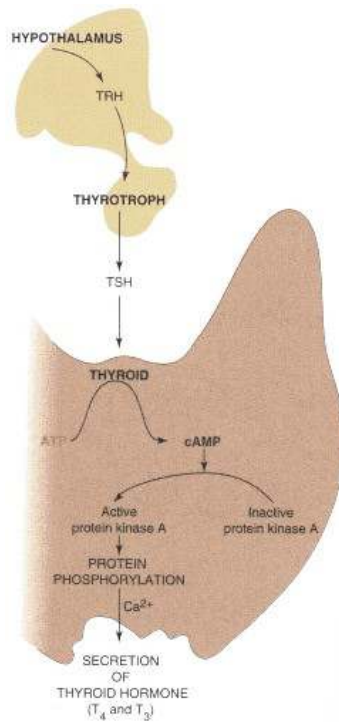

Figure 20.19
Overview of secretion controls of thyroid hormone.

CLINICAL CORRELATION 20.3

Lithium Treatment of Manic–Depressive Illness: The Phosphatidylinositol Cycle

Lithium has been used for years in the treatment of manic depression. Our newer knowledge suggests that lithium therapy involves the phosphatidylinositol (PI) pathway. This pathway generates the second messengers inositol 1,4,5-triphosphate (IP₃) and diacylglycerol following the hormone/neurotransmitter–membrane receptor interaction and involves the G-protein complex and activation of phospholipase C. IP₃ and its many phosphorylated derivatives are ultimately dephosphorylated in a stepwise fashion to generate free inositol. Inositol is then used for the synthesis of phosphatidylinositol monophosphate. The phosphatase that dephosphorylates IP to inositol is inhibited by Li⁺. In addition, Li⁺ may also interfere directly with G-protein function. The result of Li⁺ inhibition is that the PI cycle is greatly slowed even in the face of continued hormonal/neurotransmitter stimulation and the cell becomes less sensitive to these stimuli. Manic–depressive illness may occur through the overactivity of certain CNS cells, perhaps as a result of abnormally high levels of hormones or neurotransmitters whose actions are to stimulate the PI cycle. The chemotherapeutic effect of the Li⁺ could be to decrease the cellular responsiveness to elevated levels of agents that might promote high levels of PI cycle and precipitate manic-depressive illness.

Avissar, S., and Schreiber, G. Muscarinic receptor subclassification and G-proteins: significance for lithium action in affective disorders and for the treatment of the extrapyramidal side effects of neuroleptics. *Biol. Psychiatry* 26:113, 1989; Hallcher, L. M., and Sherman, W. R. The effects of lithium ion and other agents on the activity of myoinositol 1-phosphatase from bovine brain. *J. Biol. Chem.* 255:896, 1980; and Pollack, S. J., Atack, J. R., Knowles, M. R., McAllister, G., Ragan, C. I., Baker, R., Fletcher, S. R., Iversen, L. L., and Broughton, H. B. Mechanism of inositol monophosphatase, the putative target of lithium therapy. *Proc. Natl. Acad. Sci. USA* 91:5766, 1994.

part of the endoplasmic reticulum. IP₃ binding results in the release of calcium ions contributing to the large increase in cytosolic Ca²⁺ levels. Calcium ions may be important to the process of exocytosis by taking part in the fusion of secretory granules to the internal cell membrane, in microtubular aggregation or in the function of contractile proteins, which may be part of the structure of the exocytotic mechanism, or all of these.

The IP₃ is metabolized by stepwise removal of phosphate groups (Figure 20.21) to form inositol. This combines with phosphatidic acid (PA) to form phosphatidylinositol (PI) in the cell membrane. PI is phosphorylated twice by a kinase to form PIP₂, which is ready to undergo another round of hydrolysis and formation of second messengers (DAG and IP₃) upon hormonal stimulation. If the receptor is still occupied by hormone, several rounds of the cycle could occur before the hormone–receptor complex dissociates or some other feature of the cycle becomes limiting. It is interesting that the conversion of inositol phosphate to inositol is inhibited by **lithium ion** (Li⁺) (Figure 20.21). This could be the metabolic basis for the beneficial effects of Li⁺ in manic-depressive illness (see Clin. Corr. 20.3). Finally, it is important to note that not all of the generated IP₃ is dephosphorylated during hormonal stimulation. Some of the IP₃ is phosphorylated via IP₃ kinase to yield inositol 1,3,4,5-tetraphosphate (IP₄), which may mediate some of the slower or more prolonged hormonal responses or facilitate replenishment of intracellular Ca²⁺ stores from the extracellular fluid, or both.

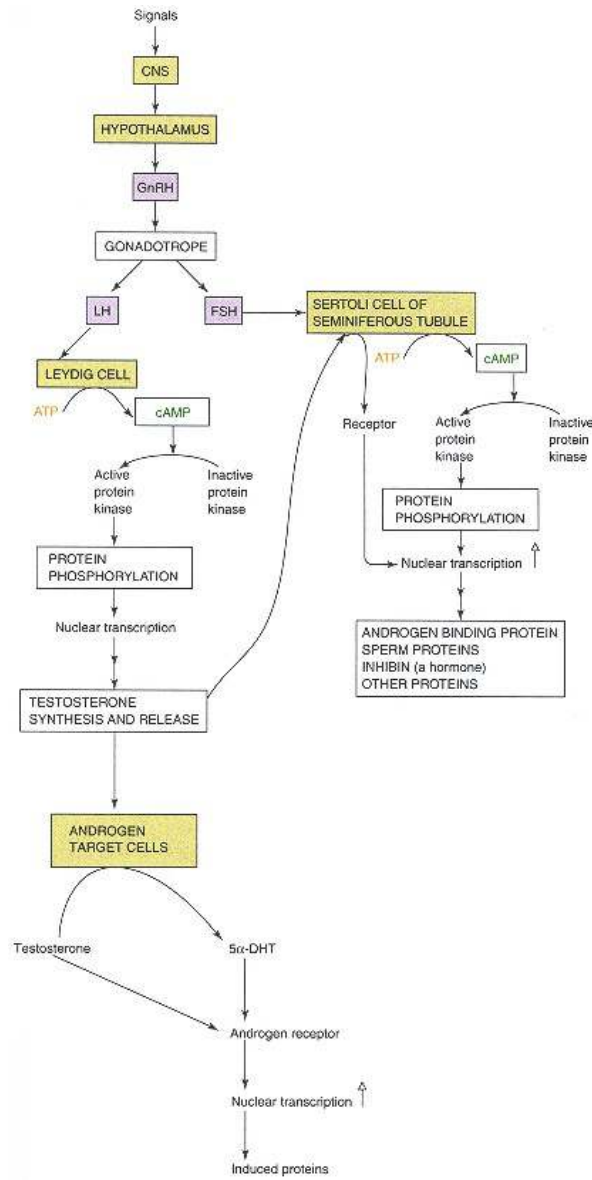

Figure 20.20
Overview of the secretion controls and some general actions of the gonadotropes and testosterone release in males.
 In some, but not all, androgen target cells, testosterone is reduced to the more potent androgen, 5 α -dihydrotestosterone (5 α -DHT).

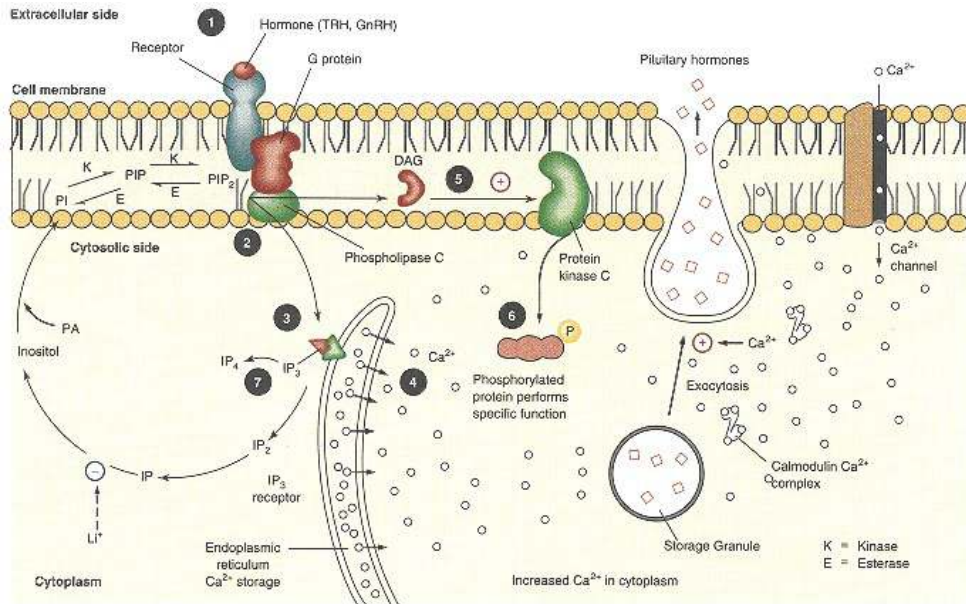

Figure 20.21
Overview of hormonal signaling through the phosphatidylinositol system generating the second messengers, inositol 1,4,5-trisphosphate (IP₃) and diacylglycerol (DAG).

The action of IP₃ is to increase cytosol Ca²⁺ levels by a receptor-mediated event in the cellular calcium store. Steps in pathway: (1) binding of hormone to cell membrane receptor; (2) production of IP₃ from PIP₂; (3) binding of IP₃ to receptor on calcium storage site; (4) release of free calcium to the cytosol; (5) release of DAG and subsequent binding to protein kinase C; (6) phosphorylation of protein substrates by protein kinase C activated by DAG and Ca²⁺; and (7) phosphorylation of IP₃ to yield IP₄. DAG, diacylglycerol; PA, phosphatidic acid; IP, inositol phosphate; IP₂, inositol bisphosphate; IP₃, inositol 1,4,5-trisphosphate; IP₄, inositol 1,3,4,5-tetrakisphosphate; PIP, phosphatidylinositol phosphate; PIP₂, phosphatidylinositol 4,5-bisphosphate; K, kinase; E, esterase.

Diacylglycerol Activates Protein Kinase C Pathway

At the same time that the IP₃ produced by hydrolysis of PIP₂ is increasing the concentration of Ca²⁺ in the cytosol, the other cleavage product, DAG, mediates different effects. Importantly, DAG activates a crucial serine/threonine protein kinase called **protein kinase C** because it is Ca²⁺ dependent (details of protein kinase C discussed on p. 883). The initial rise in cytosolic Ca²⁺ induced by IP₃ is believed to somehow alter kinase C so that it translocates from the cytosol to the cytoplasmic face of the plasma membrane. Once translocated, it is activated by a combination of Ca²⁺, DAG, and the negatively charged membrane phospholipid, phosphatidylserine. Once activated, protein kinase C then phosphorylates specific proteins in the cytosol or, in some cases, in the plasma membrane. These phosphorylated proteins perform specific functions that they could not mediate in their nonphosphorylated states. For example, a phosphorylated protein could potentially migrate to the nucleus and stimulate mitosis and

growth. It is also possible that a phosphorylated protein could play a role in the secretion of preformed hormones.

**20.8—
Cyclic Hormonal Cascade Systems**

Hormonal cascade systems can be generated by external signals as well as by internal signals. Examples of this are the **diurnal variations** in levels of cortisol secreted from the adrenal gland probably initiated by serotonin and vasopressin, the day and night variations in the secretion of **melatonin** from the pineal gland and the internal regulation of the **ovarian cycle**. Some of these biorhythms operate on a cyclic basis, often dictated by daylight and darkness, and are referred to as **chronotropic control** of hormone secretion.

Melatonin and Serotonin Synthesis Are Controlled by Light and Dark Cycles

The release of melatonin from the pineal gland, presented in overview in Figure 20.22, is an example of a biorhythm. Here, as in other such systems, the internal signal is provided by a neurotransmitter, in this case norepinephrine produced by an adrenergic neuron. In this system, control is exerted by light entering the eyes and is transmitted to the pineal gland by way of the CNS. The adrenergic neuron innervating the pinealocyte is inhibited by light transmitted through the eyes. Norepinephrine released as a neurotransmitter in the dark stimulates cAMP formation through a β receptor in the pinealocyte cell membrane, which leads to the enhanced synthesis of **N-acetyltransferase**. The increased activity of this enzyme causes the conversion of **serotonin** to **N-acetylserotonin**, and **hydroxyindole-O-methyltransferase (HIOMT)** then catalyzes the conversion of **N-acetylserotonin** to **melatonin**, which is secreted in the dark hours but not during light hours. Melatonin is circulated to cells containing receptors that generate effects on reproductive and other functions. For example, melatonin has been shown to exert an antigonadotropic effect, although the physiological significance of this effect is unclear.

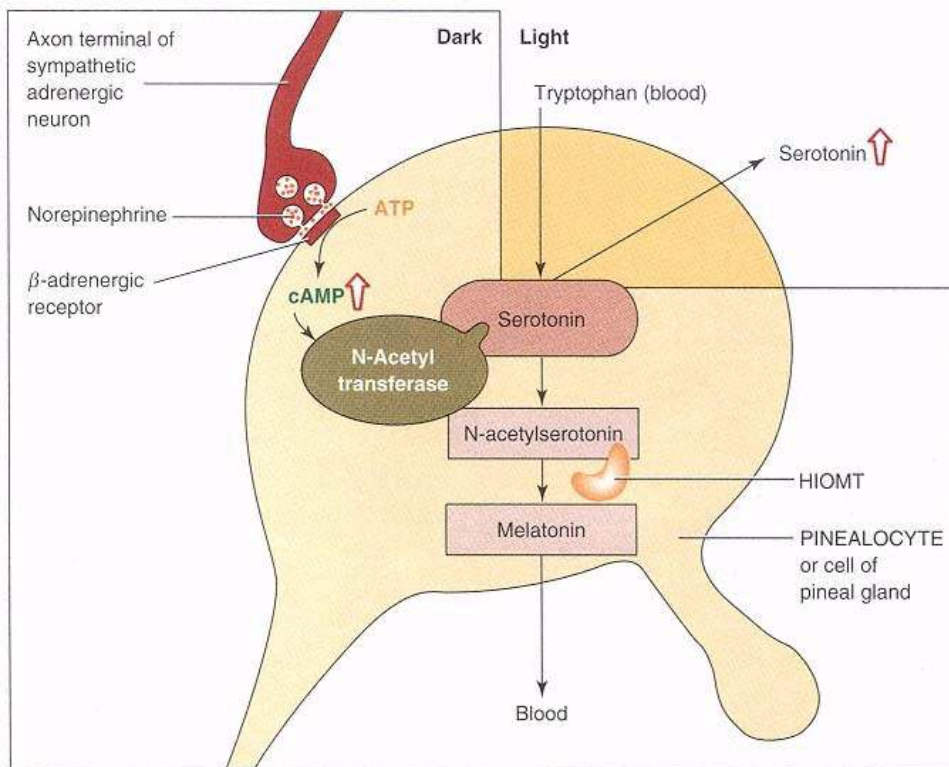

Figure 20.22
Biosynthesis of melatonin in pinealocytes.
HIOMT, hydroxyindole-O-methyltransferase.
Redrawn from Norman, A. W., and Litwack, G. *Hormones*. New York: Academic Press, 1987, p. 710.

Ovarian Cycle Is Controlled by Gonadotropin-Releasing Hormone

An example of a pulsatile release mechanism is regulation of the periodic release of GnRH. A periodic control regulates the release of this substance at definitive periods (of about 1 h in higher animals) and is controlled by aminergic neurons, which may be adrenergic (norepinephrine secreting) in nature. The initiation of this function occurs at puberty and is important in both the male and female. While the male system functions continually, the female system is periodic and known as the **ovarian cycle**. This system is presented in Figure 20.23. In the

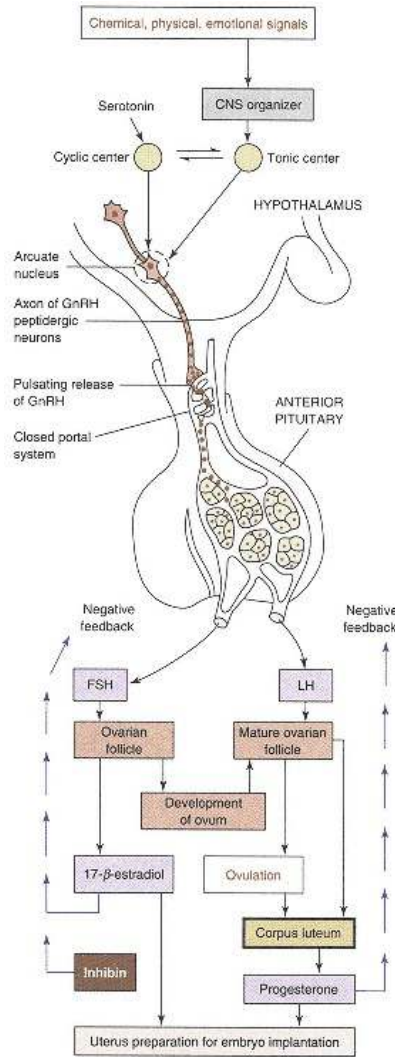

Figure 20.23
Ovarian cycle in terms of generation of hypothalamic hormone, pituitary gonadotropic hormones, and sex hormones.

To begin the cycle at puberty, several centers in the CNS coordinate with the hypothalamus so that hypothalamic GnRH can be released in a pulsatile fashion. This causes the release of the gonadotropic hormones, LH and FSH, which in turn affect the ovarian follicle, ovulation, and the corpus luteum. The hormone inhibin selectively inhibits FSH secretion. Products of the follicle and corpus luteum, respectively, are β -estradiol and progesterone. GnRH, gonadotropin-releasing hormone; FSH, follicle-stimulating hormone; LH, luteinizing hormone.

male, the cycling center in the CNS does not develop because its development is blocked by androgens before birth.

In the female, a complicated set of signals needs to be organized in the CNS before the initial secretion of GnRH occurs at puberty. The higher centers (CNS organizer) must harmonize with the tonic and cycling centers and these interact with each other to prime the hypothalamus. The pulsatile system, which innervates the arcuate nucleus of the hypothalamus, must also function for GnRH to be released, and this system apparently must be functional throughout life for these cycles to be maintained. Release of GnRH from the axon terminals of the cells that synthesize this hormone is followed by entry of the hormone into the primary plexus of the closed portal system connecting the hypothalamus and the anterior pituitary (Figure 20.23). The blood–brain barrier preventing peptide transport is overcome in this process by allowing GnRH to enter the vascular system through fenestrations, or openings in the blood vessels, that permit such transport. The GnRH is then carried down the **portal system** and leaves the secondary plexus through fenestrations, again, in the region of the target cells (**gonadotropes**) of the anterior pituitary. The hormone binds to its cognate membrane receptor and the signal, mediated by the phosphatidylinositol metabolic system, causes the release of both FSH and LH from the same cell. The **FSH** binds to its cognate membrane receptor on the ovarian follicle and, operating through the protein kinase A pathway via cAMP elevation, stimulates synthesis and secretion of 17β -estradiol, the female sex hormone, and maturation of the follicle and ovum. Other proteins, such as **inhibin**, are also synthesized. Inhibin is a negative feedback regulator of FSH production in the gonadotrope. When the follicle reaches full maturation and the ovum also is matured, LH binds to its cognate receptor and plays a role in ovulation together with other factors, such as prostaglandin $F_{2\alpha}$. The residual follicle remaining after ovulation becomes the functional *corpus luteum* under primary control of LH (Figure 20.23). The **LH** binds to its cognate receptor in the *corpus luteum* cell membrane and, through stimulation of the protein kinase A pathway, stimulates synthesis of progesterone, the progestational hormone. **Estradiol** and **progesterone** bind to intracellular receptors (Chapter 21) in the uterine endometrium and cause major changes resulting in the thickening of the wall and vascularization in preparation for implantation of the fertilized egg. Estradiol, which is synthesized in large amount prior to production of progesterone, induces the progesterone receptor as one of its inducible phenotypes. This induction of progesterone receptors primes the uterus for subsequent stimulation by progesterone secreted by the *corpus luteum*.

Absence of Fertilization

If fertilization of the ovum does not occur, the *corpus luteum* involutes as a consequence of diminished LH supply. Progesterone levels fall sharply in the blood with the regression of the *corpus luteum*. Estradiol levels also fall due to the cessation of its production by the *corpus luteum*. Thus the stimuli for a thickened and vascularized uterine endometrial wall are lost. *Menstruation* occurs through a process of programmed cell death of the uterine endometrial cells until the endometrium reaches its unstimulated state. Ultimately, the fall in blood steroid levels releases the negative feedback inhibition on the gonadotropes and hypothalamus and the cycle starts again with release of FSH and LH by the gonadotropes in response to GnRH.

The course of the ovarian cycle is shown in Figure 20.24 with respect to the relative blood levels of hormones released from the hypothalamus, anterior pituitary, ovarian follicle, and corpus luteum. In addition, changes in the maturation of the follicle and ovum as well as the uterine endometrium are shown. Aspects of the steroid hormones, estradiol and progesterone, are discussed in Chapter 21.

The cycle first begins at puberty when GnRH is released, corresponding

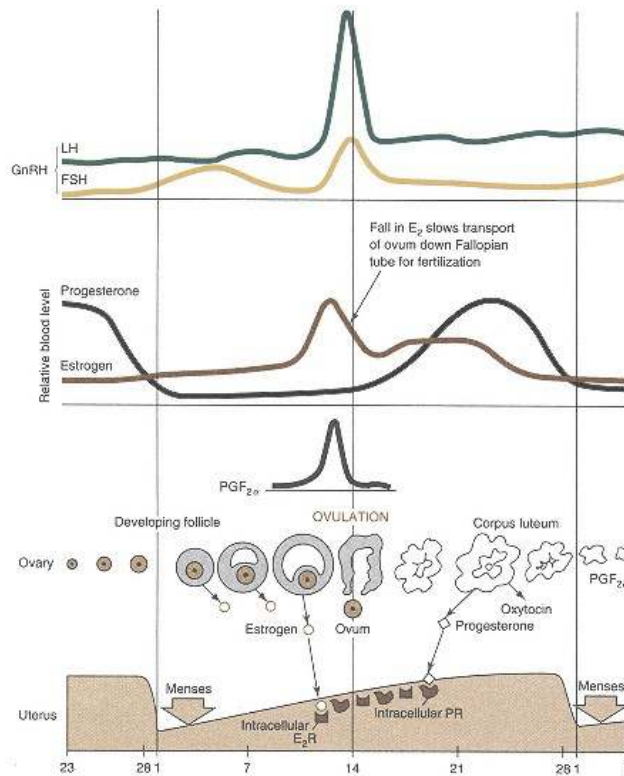

Figure 20.24
The ovarian cycle.

In the upper diagram, relative blood levels of GnRH, LH, FSH, progesterone, estrogen, and $\text{PGF}_{2\alpha}$ are shown. In the lower diagram, events in the ovarian follicle, corpus luteum, and uterine endometrium are diagrammed. GnRH, gonadotropin-releasing hormone; LH, luteinizing hormone; FSH, follicle-stimulating hormone; $\text{PGF}_{2\alpha}$, prostaglandin $\text{F}_{2\alpha}$; E_2 , estradiol; E_2R , intracellular estrogen receptor; PR, intracellular progesterone receptor.

to day 1 in Figure 20.24. GnRH is released in a pulsatile fashion, causing the gonadotrope to release FSH and LH; there is a rise in the blood levels of these gonadotropic hormones in subsequent days. Under the stimulation of FSH the follicle begins to mature (lower section of Figure 20.24) and estradiol (E_2) is produced. In response to estradiol the uterine endometrium begins to thicken (there would have been no prior menstruation in the very first cycle). Eventually, under the continued action of FSH, the follicle matures with the maturing ovum, and extraordinarily high levels of estradiol are produced (around day 13 of the cycle). These levels of estradiol, instead of causing feedback inhibition, now generate, through **feedback stimulation**, a huge release of LH and to a lesser extent FSH from the gonadotrope. The FSH responds to a smaller extent due to the ovarian production of the hormone inhibin under the influence of FSH. Inhibin is a specific negative feedback inhibitor of FSH, but not of LH, and probably suppresses the synthesis of the β subunit of FSH. The high midcycle peak of LH is referred to as the "LH spike." Ovulation then occurs at about day 14 (midcycle) through the effects of high LH concentration together with other factors, such as $\text{PGF}_{2\alpha}$. Both LH and $\text{PGF}_{2\alpha}$ act on cell membrane receptors. After ovulation, the function of the follicle declines as reflected by the fall in blood estrogen levels. The spent follicle now differentiates into the functional corpus luteum driven by the still high levels of blood LH (Figure 20.23, top).

Under the influence of prior high levels of estradiol (estrogen) and the high levels of progesterone produced by the now functional *corpus luteum*, the uterine endometrial wall reaches its greatest development in preparation for implantation of the fertilized egg, should fertilization occur. Note that the previous availability of estradiol in combination with the estrogen receptor (E_2R) produces elevated levels of progesterone receptor (PR) within the cells of the uterine wall. The blood levels of estrogen fall with the loss of function of the follicle but some estrogen is produced by the *corpus luteum* in addition to the much greater levels of progesterone. In the absence of fertilization the *corpus luteum* continues to function for about 2 weeks, then involutes because of the loss of high levels of LH. The production of oxytocin by the *corpus luteum* itself and the production or availability of $PGF_{2\alpha}$ cause inhibition of progesterone synthesis and enhances luteolysis by a process of programmed cell death (Chapter 21). With the death of the *corpus luteum* there is a profound decline in blood levels of estradiol and progesterone so that the thickened endometrial wall can no longer be maintained and menstruation occurs, followed by the start of another cycle with a new developing follicle.

Fertilization

The situation changes if fertilization occurs as shown in Figure 20.25. The *corpus luteum*, which would have ceased function by 28 days, remains viable due to the production of **chorionic gonadotropin**, which resembles and acts like LH, from the trophoblast. Eventually, the production of **human chorionic gonadotropin** (hCG) is taken over by the placenta, which continues to produce the hormone at very high levels throughout most of the gestational period. Nevertheless, the *corpus luteum*, referred to as the "*corpus luteum* of pregnancy," eventually dies and, by about 12 weeks of pregnancy, the placenta has taken over the production of progesterone, which is secreted at high levels throughout pregnancy. Although both progesterone and estrogen are secreted in progressively greater quantities throughout pregnancy, from the seventh month onward estrogen secretion continues to increase while progesterone secretion remains constant or may even decrease slightly (Figure 20.25). The increased production of a progesterone-binding protein may also serve to lower the effective concentration of free progesterone in the myometrium. Thus the estrogen/progesterone ratio increases toward the end of pregnancy and may

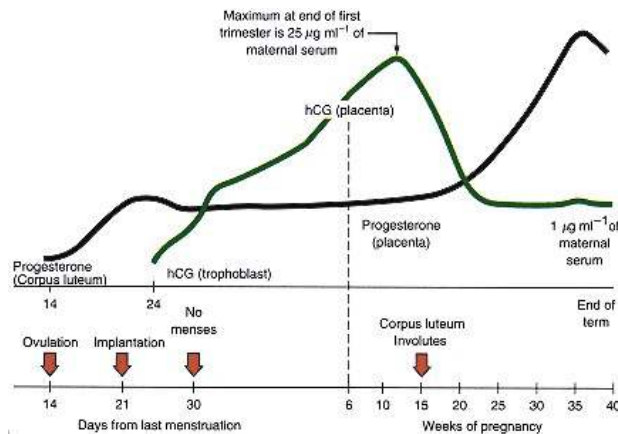

Figure 20.25
Effect of fertilization on ovarian cycle in terms of progesterone and secretion of human chorionic gonadotropin (hCG).

be partly responsible for the increased uterine contractions. Oxytocin secreted by the posterior pituitary also contributes to these uterine contractions. The fetal membranes also release prostaglandins ($\text{PGF}_{2\alpha}$) at the time of parturition and they also increase the intensity of uterine contractions. Finally, the fetal adrenal glands secrete cortisol, which not only stimulates fetal lung maturation by inducing surfactant but may also stimulate uterine contractions.

As mentioned before, the system in the male is similar, but less complex in that cycling is not involved, and it progresses much as outlined in Figure 20.25. This is only one example of biorhythmic and pulsatile systems.

20.9— Hormone–Receptor Interactions

Receptors are proteins and differ by their specificity for ligands and by their location in the cell (see Figure 20.1). The interaction of ligand with receptor essentially resembles a semienzymatic reaction:

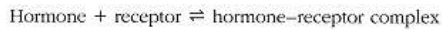

The **hormone–receptor complex** usually undergoes conformational changes resulting from interaction with the hormonal ligand. These changes allow for a subsequent interaction with a transducing protein (G-protein) in the membrane or for activation to a new state in which active domains become available on the surface of the receptor. The mathematical treatment of the interaction of hormone and receptor is a function of the concentrations of the reactants, hormone $[\text{H}]$ and receptor $[\text{R}]$, in the formation of the hormone–receptor complex $[\text{RH}]$, and the rates of formation and reversal of the reaction:

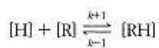

The reaction can be studied under conditions, such as low temperature, that will further reduce reactions involving the hormone–receptor complex. The equilibrium can thus be expressed in terms of the association constant, K_a , which is equal to the inverse of the dissociation constant, K_d :

$$K_a = \frac{[\text{RH}]}{[\text{H}][\text{R}]} = \frac{k_{+1}}{k_{-1}} = \frac{1}{K_d}$$

The concentrations are equilibrium concentrations that can be restated in terms of the forward and reverse velocity constants, k_{+1} being the on-rate and k_{-1} being the off-rate (**on** refers to hormone association with the receptor and **off** refers to hormone dissociation). Experimentally, equilibrium under given conditions is determined by a progress curve of binding that reaches saturation. A saturating amount of hormone is determined using variable amounts of free hormone and measuring the amount bound with some convenient assay. The half-maximal value of a plot of receptor-bound hormone (ordinate) versus total free-hormone concentration (abscissa) approximates the dissociation constant, which will have a specific hormone concentration in molarity as its value. Hormone bound to receptor is corrected for nonspecific binding of the hormone to the membrane or other nonreceptor intracellular proteins. This can be measured conveniently if the hormone is radiolabelled, by measuring receptor binding using labeled hormone ("hot" or "uncompeted") and receptor binding using labeled hormone after the addition of an excess (100–1000 times) of unlabeled hormone ("hot" + "cold" or competed). The excess of unlabeled hormone will displace the high-affinity hormone-binding sites but not the low-affinity nonspecific binding sites. Thus when the "competed" curve is subtracted from the "uncompeted" curve, as seen in Figure 20.26, an intermediate curve will represent specific binding of labeled hormone to receptor. This is of critical

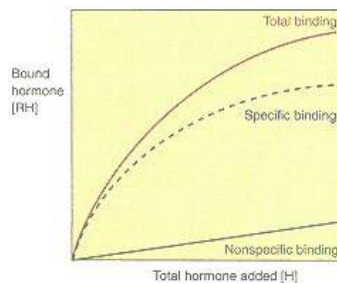

Figure 20.26
Typical plot showing specific hormone binding.

importance when receptor is measured in a system containing other proteins. As an approximation, 20 times the K_d value of hormone is usually enough to saturate the receptor.

Scatchard Analysis Permits Determination of the Number of Receptor-Binding Sites and Association Constant for Ligand

Most measurements of K_d are made using **Scatchard analysis**, which is a manipulation of the equilibrium equation. The equation can be developed by a number of routes but can be envisioned from mass action analysis of the equation presented above. At equilibrium the total possible number of binding sites (B_{\max}) equals the unbound plus the bound sites, so that $B_{\max} = R + RH$, and the unbound sites (R) will be equal to $R = B_{\max} - RH$. To consider the sites left unbound in the reaction the equilibrium equation becomes

$$K_d = \frac{[RH]}{[H](B_{\max} - [RH])}$$

Thus

$$\frac{\text{bound}}{\text{free}} = \frac{[RH]}{[H]} = K_d(B_{\max} - [RH]) = \frac{1}{K_d}(B_{\max} - [RH])$$

The Scatchard plot of bound/free = $[RH]/[H]$ on the ordinate versus bound on the abscissa yields a straight line, as shown in Figure 20.27. When the line is extrapolated to the abscissa, the intercept gives the value of B_{\max} (the total number of specific receptor-binding sites). The slope of the negative straight line is $-K_d$ or $-1/K_d$.

These analyses are sufficient for most systems but become more complex when there are two components in the Scatchard plot. In this case the straight line usually curves as it approaches the abscissa and a second phase is observed somewhat asymptotic to the abscissa while still retaining a negative slope (Figure 20.28a). In order to obtain the true value of K_d for the steeper, higher-affinity sites, the low-affinity curve must be subtracted from the first set, which also corrects the extrapolated value of B_{\max} . From these analyses information is obtained on K_d , the number of classes of binding sites (usually one or two), and the maximal number of high-affinity receptor sites (receptor number) in the system (see Figure 20.28b). These curvilinear Scatchard plots can result not only from the existence of more than one distinct binding component but also as a consequence of what is referred to as **negative cooperativity**. This term refers to the fact that in some systems the affinity of the receptor for its ligand is gradually decreased as more and more ligand binds. From application to a wide variety of systems it appears that K_d values for many hormone receptors range from 10^{-9} to 10^{-11} M, indicating very tight binding. These interactions are generally marked by a high degree of specificity so that both parameters describe interactions of a high order, indicating the uniqueness of receptors and the selectivity of signal reception.

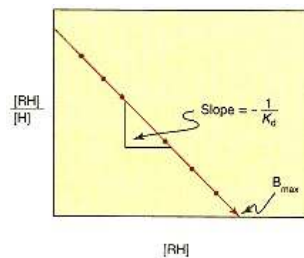
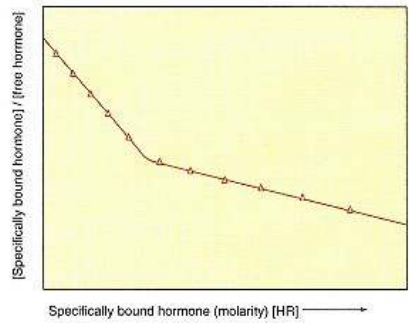

Figure 20.27
Typical plot of Scatchard analysis of specific binding of ligand to receptor.

Some Hormone-Receptor Interactions Involve Multiple Hormone Subunits

Interaction of hormone and receptor can be exemplified by the anterior pituitary hormones, **thyrotropin (TSH)**, **luteinizing hormone (LH)**, and **follicle-stimulating hormone (FSH)**. These hormones each contain two subunits, an α and a β subunit. The α subunit for all three hormones is nearly identical and the α subunit of any of the three can substitute for the other two. Consequently, the α subunit performs some function in common to all three hormones in their interaction with receptor but is obviously not responsible for the specificity



(a)

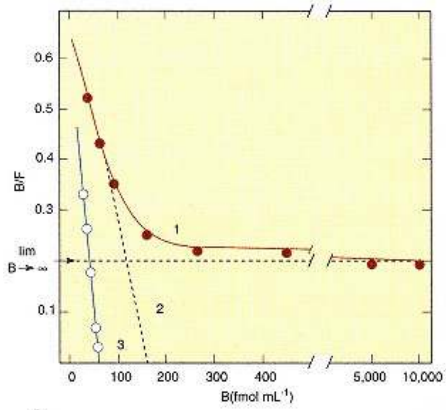

(b)

Figure 20.28
Scatchard analysis of curves representing two components.
 (a) Scatchard curve showing two components.
 (b) Scatchard plot with correction of high-affinity component by subtraction of nonspecific binding attributable to the low-affinity component. Curve 1: total binding. Curve 2: Linear extrapolation of high-affinity component that includes contribution from low-affinity component. Curve 3: Specific binding of high-affinity component after removal of nonspecific component.
 Redrawn from Chamness, G. C., and McGuire, W. L. *Steroids* 26:538, 1975.

required for each cognate receptor. The hormones cannot replace each other in binding to their specific receptor. Thus the specificity of receptor recognition is imparted by the β subunit, whose structure is unique for the three hormones.

On the basis of topological studies with monoclonal antibodies, a picture of the interaction of LH with its receptor has been suggested as shown in Figure 20.29. In this model, the receptor recognizes both subunits of the hormonal ligand, but the β subunit is specifically recognized by the receptor to lead to a response. With the TSH-receptor complex there may be more than one second messenger generated. In addition to the stimulation of adenylate cyclase and the increased intracellular level of cAMP, the phosphatidylinositol pathway (Figure 20.21) is also turned on. The preferred model is one in which there is a single receptor whose interaction with hormone activates both the adenylate cyclase and the phospholipid second messenger systems, as shown in Figure 20.30. Thus a variety of reactions could follow the hormone-receptor interaction through the subsequent stimulation of cAMP levels (protein kinase A pathway) and stimulation of phosphatidylinositol turnover (protein kinase C pathway).

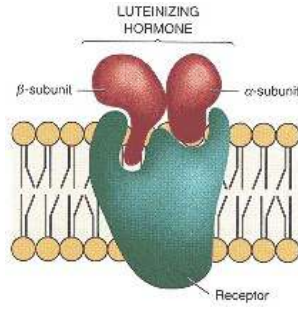

Figure 20.29
Interaction of the α and β subunits of LH with the LH receptor of rat Leydig cells.

The interaction was determined by topological analysis with monoclonal antibodies directed against epitopes on the α and β subunits of the hormone. Both α and β subunits participate in LH receptor binding. Adapted from Alonoso-Whipple, C., Couet, M. L., Doss, R., Koziarz, J., Ogunro, E. A., and Crowley, W. E. Jr. *Endocrinology* 123:1854, 1988.

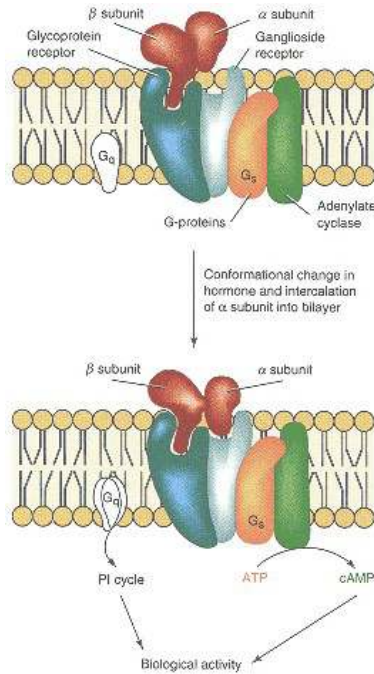

Figure 20.30
Model of TSH receptor, which is composed of glycoprotein and ganglioside component.

After the TSH β subunit interacts with receptor, the hormone changes its conformation and the α subunit is brought into the bilayer, where it interacts with other membrane components. The β subunit of TSH may carry primary determinants recognized by the glycoprotein receptor component. It is suggested that the TSH signal to adenylate cyclase is via the ganglioside; the glycoprotein component appears more directly linked to phospholipid signal system. PI, phosphatidylinositol; G_s , G-protein linked to activation of adenylate cyclase; G_q , G-protein linked to PI cycle. Adapted with modifications from L. D. Kohn, et al. *Biochemical Actions of Hormones*, 12. G. Litwack (Ed.). Academic Press, 1985, p. 466.

20.10—

**Structure of Receptors:
 β -Adrenergic Receptor**

Structures of receptors are conveniently discussed in terms of functional domains. Consequently, for membrane receptors there will be functional **ligand-binding domains** and the **transmembrane domains**, which for many membrane receptors involve protein kinase activities. In addition, specific **immuno-logical domains** contain primary epitopes of antigenic regions. Several membrane receptors have been cloned and studied with regard to structure and function, including the β receptors (β_1 and β_2), which recognize catecholamines, principally norepinephrine, and stimulate adenylate cyclase. The β_1 and β_2 receptors are subtypes that differ in affinities for norepinephrine and for synthetic antagonists. Thus β_1 -adrenergic receptor binds norepinephrine with a higher affinity than epinephrine, whereas the order of affinities is reversed for the β_2 -adrenergic receptor. The drug isoproterenol has a greater affinity for both receptors than the two hormones. In Figure 20.31 the amino acid sequence is shown (with single letter abbreviations for amino acids; see Table 20.4 for list) for the β_2 -adrenergic receptor. A polypeptide stretch extending from α helix I extends to the extracellular space. There are seven membrane-spanning domains and these appear also in the β_1 receptor, where there is extensive homology with the β_2 receptor. Cytosolic peptide regions extend to form loops between I and II, III and IV, and V and VI and an extended chain from VII.

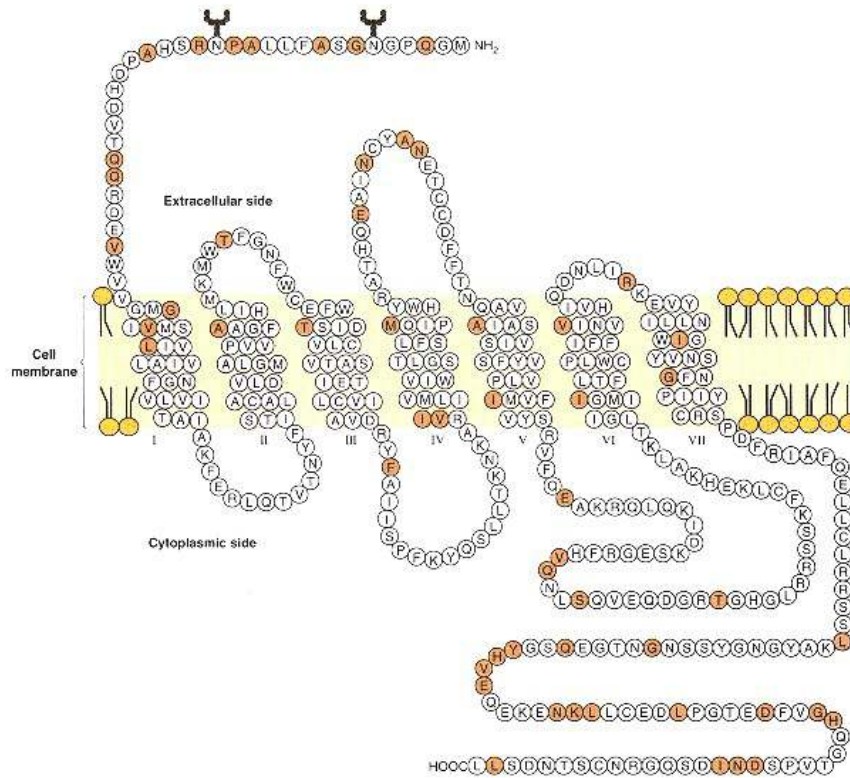

Figure 20.31

Proposed model for insertion of the β_2 -adrenergic receptor (AR) in the cell membrane.

The model is based on hydropathicity analysis of the human β_2 -AR. Standard one-letter codes for amino acid residues are used. Hydrophobic domains are represented as transmembrane helices. Pink circles with black letters indicate residues in the human sequence that differ from those in hamster. Also noted are the potential sites of N-linked glycosylation.

Redrawn from Kobilka, B. K., Dixon, R. A., Frielle, T., Dohlman, H. G., et al. *Proc. Natl. Acad. Sci. USA* 84:46, 1987.

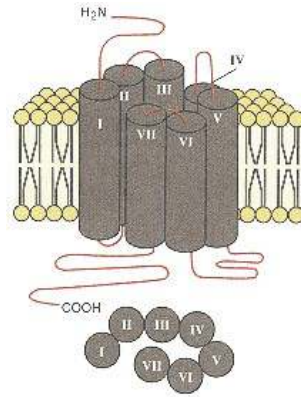

Figure 20.32

Proposed arrangement of β -adrenergic receptor helices in the membrane.

Lower portion of the figure is a view from above the plane of the plasma membrane. It is proposed that helices IV, VI, and VII are arranged in the membrane in such a way as to delineate a ligand-binding pocket, with helix VII centrally located.

Adapted from Frielle, T., Daniel, K. W., Caron, M. G., and Lefkowitz, R. J. *Proc. Natl. Acad. Sci. USA* 85:9494, 1988.

The long extended chain from VII may contain phosphorylation sites (serine and threonine residues) of the receptor, which are important in terms of the receptor regulatory process involving receptor desensitization. Phosphorylation of these residues within the cytoplasmic tail of the receptor results in the binding of an inhibitory protein, called β arrestin, which blocks the receptor's ability to activate G_s . Cell exterior peptide loops extend from II to III, IV to V, and VI to VII, but mutational analysis suggests that the external loops do not take part in ligand binding. It appears that ligand binding may occur in a pocket arranged by the location of the membrane-spanning cylinders I–VII, which for the β_1 receptor appear to form a ligand pocket, as shown from a top view in Figure 20.32. Recently reported work suggests that transmembrane domain VI may play a role in the stimulation of adenylate cyclase activity. By substitution of a specific cysteine residue in this transmembrane domain, a mutant was generated that displays normal ligand-binding properties but a decreased ability to stimulate the cyclase.

**20.11—
Internalization of Receptors**

Up to now we have described receptor systems that transduce signals through other membrane proteins, such as G-proteins, which move about in the fluid

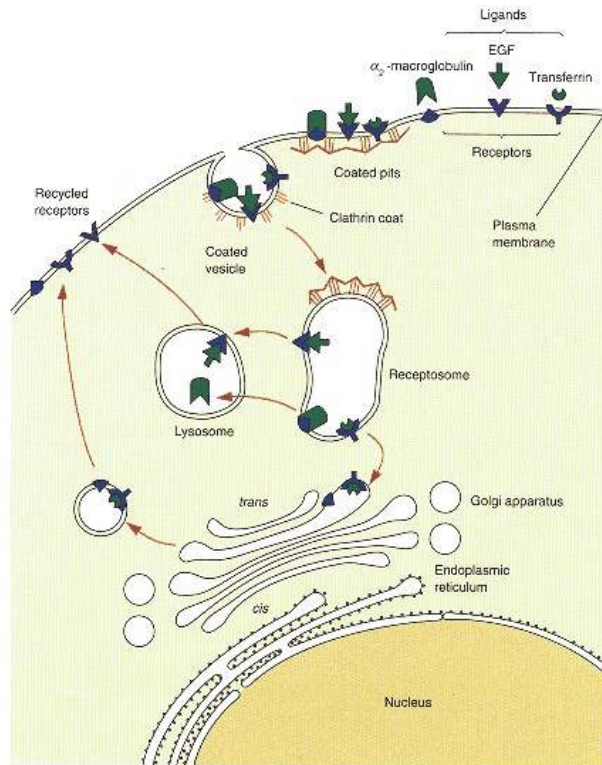

Figure 20.33

Diagrammatic summary of the morphological pathway of endocytosis in cells.

The morphological elements of the pathway of endocytosis are not drawn to scale. The ligands shown as examples are EGF, transferrin, and α_2 -macroglobulin. EGF is an example of a receptor system in which both ligand and receptor are delivered to lysosomes; transferrin is shown as an example of a system in which both the ligand and receptor recycle to the surface; α_2 -macroglobulin is shown as an example of a system in which the ligand is delivered to lysosomes but the receptor recycles efficiently back to the cell surface via the Golgi apparatus.

Adapted from Pastan, I., and Willingham, M. C. (Eds.). *Endocytosis*. New York: Plenum Press, 1985, p. 3.

cell membrane. However, many types of cell membrane hormone–receptor complexes are internalized, that is, moved from the cell membrane to the cell interior by a process called **endocytosis**. This would represent the opposite of exocytosis in which components within the cell are moved to the cell exterior. The process of endocytosis as presented in Figure 20.33 involves the polypeptide–receptor complex bound in **coated pits**, which are indentations in the plasma membrane that invaginate into the cytosol and pinch off from the membrane to form **coated vesicles**. The vesicles shed their coats, fuse with each other, and form vesicles called **receptosomes**. The receptors and ligands on the inside of these **receptosomes** can have different fates. Receptors can be recycled to the cell surface following fusion with the Golgi apparatus. Alternatively, the vesicles can fuse with lysosomes for degradation of both the receptor and hormone. In addition, some hormone–receptor complexes are dissociated in the lysosome and only the hormone is degraded, while the receptor is returned intact to the membrane. In some systems, the receptor may also be concentrated in coated pits in the absence of exogenous ligand and cycle in and out of the cell in a constitutive, nonligand-dependent manner.

Clathrin Forms a Lattice Structure to Direct Internalization of Hormone–Receptor Complexes from the Plasma Membrane

The major protein component of the coated vesicle is **clathrin**, a nonglycosylated protein of mol wt 180,000 whose amino acid sequence is highly conserved. The coated vesicle contains 70% clathrin, 5% polypeptides of about 35 kDa, and 25% polypeptides of 50–100 kDa. Aspects of the structure of a coated vesicle are shown in Figure 20.34. Coated vesicles have a lattice-like surface

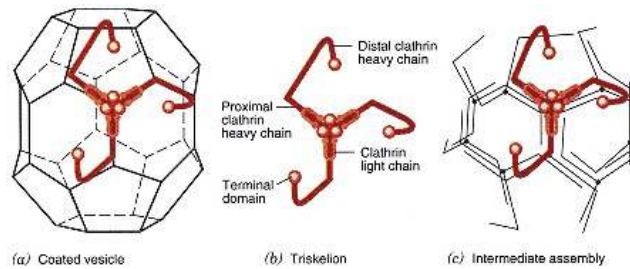

Figure 20.34

Structure and assembly of a coated vesicle.

(a) A typical coated vesicle contains a membrane vesicle about 40 nm in diameter surrounded by a fibrous network of 12 pentagons and 8 hexagons. The fibrous coat is constructed of 36 clathrin triskelions. One clathrin triskelion is centered on each of the 36 vertices of the coat. Coated vesicles having other sizes and shapes are believed to be constructed similarly: each vesicle contains 12 pentagons but a variable number of hexagons.

(b) Detail of a clathrin triskelion. Each of three clathrin heavy chains is bent into a proximal arm and a distal arm. A clathrin light chain is attached to each heavy chain, most likely near the center.

(c) An intermediate in the assembly of a coated vesicle, containing 10 of the final 36 triskelions, illustrates the packing of the clathrin triskelions. Each of the 54 edges of a coated vesicle is constructed of two proximal and two distal arms intertwined. The 36 triskelions contain $36 \times 3 = 108$ proximal and 108 distal arms, and the coated vesicle has precisely 54 edges.

See Crowther, R. A., and Pearse, B. M. F. *J. Cell Biol.* 91:790, 1981.
Redrawn from Nathk, I. S., Heuser, J., Lupas, A., Stock, J., Turck, C. W., and Brodsky, E. M. *Cell* 68:899, 1992.

Redrawn from Darnell, J., Lodish, H., and Baltimore, D. *Molecular Cell Biology*. New York: Scientific American Books, 1986, p. 647.

structure comprised of hexagons and pentagons. Three clathrin molecules generate each polyhedral vertex and two clathrin molecules contribute to each edge. The smallest such structure would contain 12 pentagons with 4–8 hexagons and 84 or 108 clathrin molecules. A 200-nm diameter coated vesicle contains about 1000 clathrin molecules. Clathrin can form flexible lattice structures that can act as scaffolds for vesicular budding. Completion of the budding process results in the mature vesicle being able to enter the cycle.

The events following endocytosis are not always clear with respect to a specific membrane receptor system. This process can be a means to introduce the intact receptor or ligand to the cell interior in cases where the nucleus is thought to contain a receptor or ligand-binding site. Consider, for example, growth factors that are known to bind to a cell membrane receptor but trigger events leading to mitosis. It is possible that signal transmission occurs by the alteration of a specific cytosolic protein, perhaps by membrane growth factor receptor-associated protein kinase activity, resulting in the nuclear translocation of the covalently modified cytosolic protein. In the case of internalization, delivery of an intact ligand (or portion of the ligand) could interact with a nuclear receptor. Such mechanisms are speculative. Nevertheless, these ideas could constitute a rationale for the participation of endocytosis in signal transmission to intracellular components.

Endocytosis renders a cell less responsive to hormone. Removal of the receptor to the interior, or cycling of membrane components, alters responsiveness or metabolism (e.g., glucose receptors can be shuffled between the cell interior and the cell membrane under the control of hormones in certain cells). In another type of downregulation, a hormone–receptor complex translocated to the nucleus can repress its own receptor mRNA levels by interacting with a specific DNA sequence. More about this form of receptor downregulation is mentioned in Chapter 21.

20.12—

Intracellular Action: Protein Kinases

Many amino acid-derived hormones or polypeptides bind to cell membrane receptors (except for thyroid hormone) and transmit their signal by (1) elevation of cAMP and transmission through the **protein kinase A pathway**; (2) triggering of the hydrolysis of phosphatidylinositol 4,5-bisphosphate and stimulation of the **protein kinase C** and IP_3 - Ca^{2+} pathways; or (3) stimulation of intracellular levels of cGMP and activation of the **protein kinase G pathway**. There are also other less prevalent systems for signal transfer, which, for example, affect molecules in the membrane like phosphatidylcholine. As previously discussed in the case of TSH–receptor signaling, it may be possible that two of these pathways are activated.

The cAMP system operating through protein kinase A activation has been described. Specific proteins are expected to be phosphorylated by this kinase compared to other protein kinases, such as protein kinase C. Both protein kinase A and C phosphorylate proteins on **serine** or **threonine** residues. An additional protein kinase system involves phosphorylation of **tyrosine**, which occurs in cytoplasmic domains of some membrane receptors especially growth factor receptors. This system is important for the insulin receptor, IGF receptor, and certain oncogenes discussed below. The cellular location of these protein kinases is presented in Figure 20.35.

The catalytic domain in the protein kinases is similar in amino acid sequence, suggesting that they have all evolved from a common primordial kinase. The three **tyrosine-specific kinases** shown in Figure 20.35 are transmembrane receptor proteins that, when activated by the binding of specific extracellular ligands, phosphorylate proteins (including themselves) on tyrosine residues inside the cell. Both chains of the insulin receptor are encoded by a single

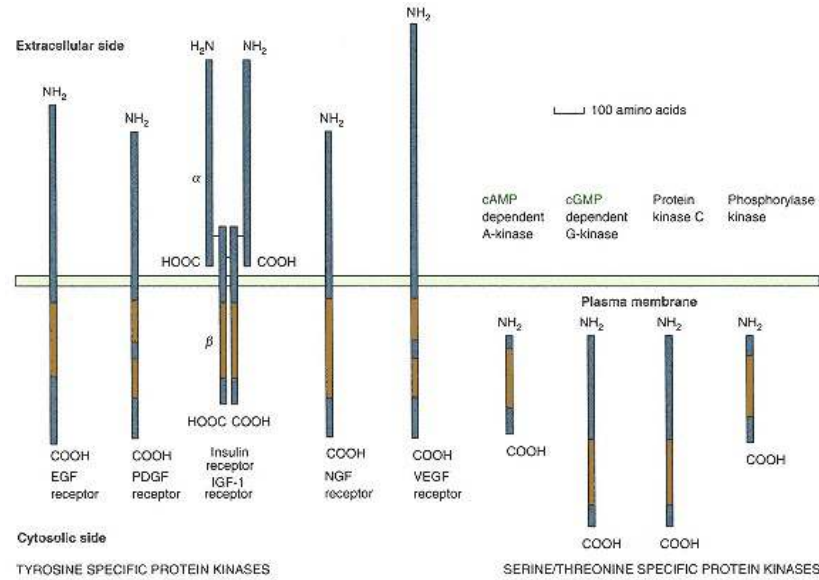

Figure 20.35

Protein kinases showing the size and location of their catalytic domain.

In each case the catalytic domain (red region) is about 250 amino acid residues long. The regulatory subunits normally associated with A-kinase and with phosphorylase kinase are not shown. EGF, epidermal growth factor; NGF, nerve growth factor; VEGF, vascular endothelial growth factor.

Redrawn from Alberts, B., Bray, D., Lewis, J., Raff, M., Roberts, K., and Watson, J. D. *Molecular Biology of the Cell*, 3rd ed. New York: Garland Publishing, 1994, p. 760.

gene, which produces a precursor protein that is cleaved into the two disulfide-linked chains. The extracellular domain of the PDGF receptor is thought to be folded into five immunoglobulin (Ig)-like domains, suggesting that this protein belongs to the Ig superfamily.

Proteins that are regulated by phosphorylation–dephosphorylation can have multiple phosphorylation sites and may be phosphorylated by more than one class of protein kinase.

Insulin Receptor:**Transduction through Tyrosine Kinase**

From Figure 20.35 it is seen that the α subunits of the **insulin receptor** are located outside the cell membrane and apparently serve as the insulin-binding site. The insulin–receptor complex undergoes an activation sequence probably involving conformational changes and phosphorylation (**autophosphorylation**) of tyrosine residues located in the cytoplasmic portion of the receptor β subunits). This results in activation of the tyrosine kinase activity located in the β subunit, which is now able to phosphorylate cytosolic proteins that may carry the insulin signal to the interior of the cell. The net results of these phosphorylation events include a series of short-term metabolic effects, such as increased uptake of glucose, as well as longer-term effects of insulin on cellular differentiation and growth. Although, as already indicated, the insulin receptor itself is a tyrosine kinase that is activated upon hormone binding, the

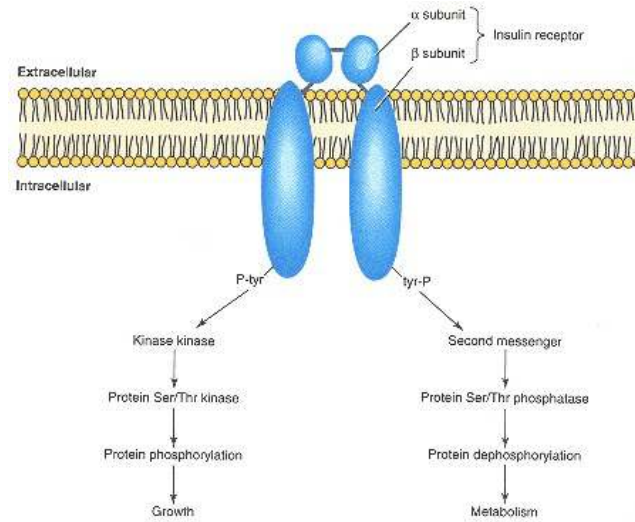

Figure 20.36

Hypothetical model depicting two separate biochemical pathways to explain paradoxical effects of insulin on protein phosphorylation.

Insulin simultaneously produces increases in the serine/threonine phosphorylation of some proteins and decreases in others. This paradoxical effect may result from activation of both kinases and phosphatases. Model explains (1) the generation of a soluble second messenger that directly or indirectly activates serine/threonine phosphatase and (2) the stimulation of a cascade of protein kinases, resulting in phosphorylation of cellular proteins.

Redrawn from Saltiel, A. R. The paradoxical regulation of protein phosphorylation in insulin action. *FASEB J.* 8:1034, 1994.

subsequent changes in phosphorylation occur predominantly on serine and threonine residues, as indicated in Figure 20.36. As also shown, insulin can simultaneously stimulate the phosphorylation of some proteins and the dephosphorylation of other proteins. Either of these biochemical events can lead to activation or inhibition of specific enzymes involved in mediating the effects of insulin. These opposite effects (phosphorylation and dephosphorylation) mediated by insulin suggest that perhaps separate signal transduction pathways may originate from the insulin receptor to produce these pleiotropic actions. A hypothetical scheme for this bifurcation of signals in insulin's action is presented in Figure 20.37. The substrates of the insulin–receptor tyrosine kinase are an important current research effort since phosphorylated proteins could produce the long-term effects of insulin. On the other hand, there is evidence that an insulin second messenger may be developed at the cell membrane to account for the short-term metabolic effects of insulin. The substance released as a result of insulin–insulin receptor interaction may be a glycoinositol derivative that, when released from the membrane into the cytosol, could be a stimulator of phosphoprotein phosphatase. This activity would dephosphorylate a variety of enzymes, either activating or inhibiting them, and produce effects already known to be associated with the action of insulin. In addition, this second messenger, or the direct phosphorylating activity of the receptor tyrosine kinase, might explain the movement of glucose receptors (transporters) from the cell interior to the surface to account for enhanced cellular glucose utilization in cells that utilize this mechanism to control glucose uptake. These possibilities are reviewed in Figure 20.37. Activation of the enzymes indicated in this figure leads to increased metabolism of glucose while inhibition of the enzymes indicated leads to decreased breakdown of glucose or fatty acid stores.

Activity of Vasopressin:

Protein Kinase A

An example of the activation of the **protein kinase A** pathway by a hormone is the activity of arginine vasopressin (AVP) on the distal kidney cell. Here the action of **vasopressin (VP)**, also called the antidiuretic hormone (Table 20.5),

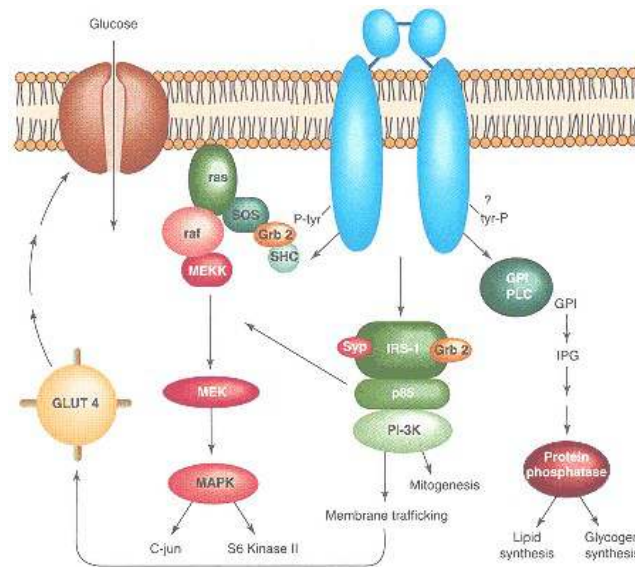

Figure 20.37

Hypothetical scheme for signal transduction in insulin action.

The insulin receptor undergoes tyrosine autophosphorylation and subsequent kinase activation upon hormone binding. The receptor phosphorylates intracellular substrates including IRS-1 and Shc proteins, which associate with SH2-containing proteins like p85, SYP, or Grb2 upon phosphorylation. Formation of the IRS-1-p85 complex activates PI 3-kinase; the IRS-1-SYP complex activates SYP, leading to MEK activation. Formation of the Shc-Grb2 complex mediates the stimulation of P21^{Ras} GTP binding, leading to a cascade of phosphorylations. These phosphorylations probably occur sequentially and involve *raf* proto-oncogene, MEK, MAP kinase, and S6 kinase II. The receptor is probably separately coupled to activation of a specific phospholipase C that catalyzes the hydrolysis of the glycosyl-PI molecules in the plasma membrane.

A product of this reaction, inositol phosphate glycan (IPG), may act as a second messenger, especially with regard to activation of serine/threonine phosphatases and the subsequent regulation of lipid and glucose metabolism. Abbreviations:

IRS-1, insulin receptor substrate-1; SH, *src* homology; MAP kinase, mitogen-activated protein kinase; MEK, MAP kinase kinase; GPI, glycosylphosphatidylinositol; PLC, phospholipase; SOS, son of sevenless.

Redrawn from Saltiel, A. R. The paradoxical regulation of protein phosphorylation in insulin action. *FASEB J.* 8:1034, 1994.

is to cause increased water reabsorption from the urine in the distal kidney. A mechanism for this system is shown in Figure 20.38. Neurons synthesizing AVP (vasopressinergic neurons) are signaled to release AVP from their nerve endings by interneuronal firing from a **baroreceptor** responding to a fall in blood pressure or from an **osmoreceptor** (probably an interneuron), which responds to an increase in extracellular salt concentration. The high extracellular salt concentration apparently causes shrinkage of the osmoreceptor cell and generates an electrical signal transmitted down the axon of the osmoreceptor to the cell body of the VP neuron generating an action potential. This signal is then transmitted down the long axon from the VP cell body to its nerve ending where, by depolarization, the VP-neurophysin II complex is released in to the

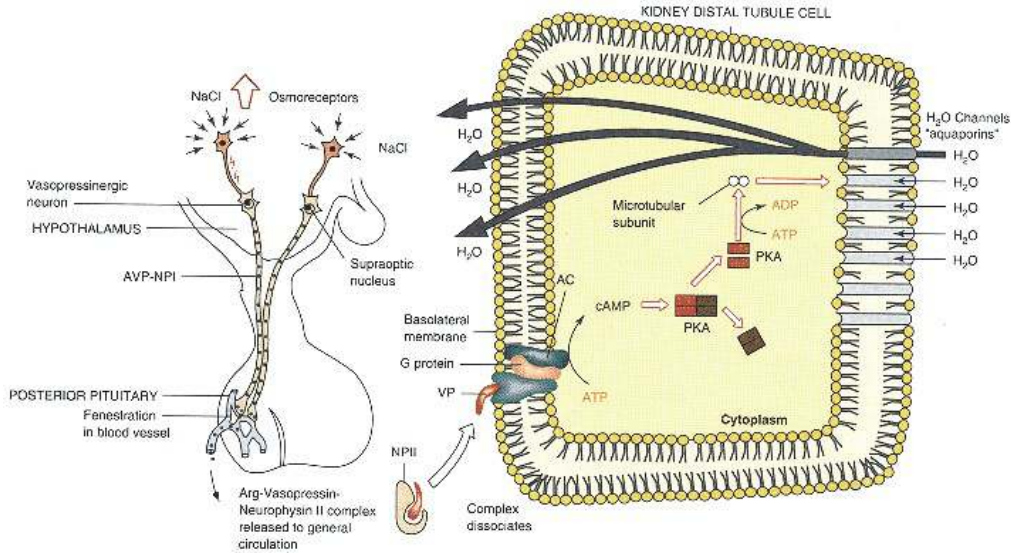

Figure 20.38

Secretion and action of arginine vasopressin in the distal kidney.

The release of arginine vasopressin (AVP or VP) from the posterior pituitary begins with a signal from the osmoreceptor, or baroreceptor (not shown), in the upper right-hand corner of figure. The signal can be an increase in the extracellular concentration of sodium chloride, which causes the osmoreceptor neuron to shrink and send an electrical message down its axon, which interfaces with the vasopressinergic cell body. This signal is transmitted down the long axon of the vasopressinergic neuron and depolarizes the nerve endings causing the release, by exocytosis, of the VP–neurophysin complex stored there. They enter the local circulation through fenestrations in the vessels and perfuse the general circulation. Soon after release, neurophysin dissociates from VP and VP binds to its cognate receptor in the cell membrane of the kidney distal tubule cell (other VP receptors are located on the corticotrope of the anterior pituitary and on the hepatocytes and their mechanisms in these other cells are different from the one for the kidney tubule cell). NPII, neurophysin II; VP, vasopressin; R, receptor; AC, adenylate cyclase; MF, myofibril; GP, glycogen phosphorylase; PK_i,

inactive protein kinase; PK_a, active protein kinase; R-Ca, regulatory subunit–cyclic AMP complex; TJ, tight junction; PD, phosphodiesterase. Vasopressin–neurophysin complex dissociates at some point and free VP binds to its cell membrane receptor in the plasma membrane surface. Through a G-protein adenylate cyclase is stimulated on the cytoplasmic side of the cell membrane, generating increased levels of cAMP from ATP. Cyclic AMP-dependent protein kinases are stimulated and phosphorylate various proteins (perhaps including microtubular subunits) which, through aggregation, insert as water channels (aquaporins) in the luminal plasma membrane, thus increasing the reabsorption of water by free diffusion.

Redrawn in part from Dousa, T. P., and Valtin, H. Cellular actions of vasopressin in the mammalian kidney. *Kidney Int.* 10:45, 1975.

extracellular space. The complex enters local capillaries through fenestrations and progresses to the general circulation. The complex dissociates and free VP is able to bind to its cognate membrane receptors in the distal kidney, anterior pituitary, hepatocyte, and perhaps other cell types. After binding to the kidney receptor, VP causes stimulation of adenylate cyclase through the stimulatory G-protein and activates protein kinase A. The protein kinase phosphorylates

TABLE 20.7 Examples of Hormones that Operate Through the Protein Kinase A Pathway

Hormone	Location of Action
CRH	Corticotrope of anterior pituitary
TSH (also phospholipid metabolism?)	Thyroid follicle
LH	Leydig cell of testis
	Mature follicle at ovulation and <i>corpus luteum</i>
FSH	Sertoli cell of seminiferous tubule Ovarian follicle
ACTH	Inner layers of cells of adrenal cortex
Opioid peptides	Some in CNS function on inhibitory pathway through G_i
AVP	Kidney distal tubular cell (the AVP hepatocyte receptor causes phospholipid turn-over and calcium ion uptake; the AVP receptor in anterior pituitary causes phospholipid turnover)
PGI_2 (prostacyclin)	Blood platelet membrane
Norepinephrine/epinephrine	β -Receptor

microtubular subunits that aggregate to form specific water channels, referred to as aquaporins, which are inserted into the luminal membrane for admission of larger volumes of water than would occur by free diffusion. Water is transported across the kidney cell to the basolateral side and to the general circulation, causing a dilution of the original high salt concentration (signal) and an increase in blood pressure. These aquaporins, which are a family of integral membrane proteins that function as selective water channels, consist of six transmembrane α helical domains. Although aquaporin monomers function as water channels or pores, their stability and proper functioning may require a tetrameric assembly. Specific mutations in the amino acid sequences of the intracellular and extracellular loops of these proteins result in nonfunctional aquaporins and the development of diabetes insipidus, which is characterized by increased thirst and production of a large volume of urine.

Some hormones that operate through the protein kinase A pathway are listed in Table 20.7.

**Gonadotropin-Releasing Hormone (GnRH):
Protein Kinase C**

Table 20.8 presents examples of polypeptide hormones that stimulate the phosphatidylinositol pathway. An example of a system operating through stimulation of the phosphatidylinositol pathway and subsequent activation of the **protein kinase C** system is **GnRH** action, shown in Figure 20.39. Probably under aminergic interneuronal controls, a signal is generated to stimulate the cell body of the GnRH-ergic neuron where GnRH is synthesized. The signal is transmitted down the long axon to the nerve ending where the hormone is stored. The hormone is released from the nerve ending by exocytosis resulting from depolarization caused by signal transmission. The GnRH enters the primary plexus of the closed portal system connecting the hypothalamus and anterior pituitary through fenestrations. Then GnRH exits the closed portal system through fenestrations in the secondary plexus and binds to cognate receptors in the cell membrane of the gonadotrope (see enlarged view in Figure 20.39). The signal from the hormone–receptor complex is transduced (through a G-protein) and phospholipase C is activated. This enzyme catalyzes the hydrolysis of PIP_2 to form DAG and IP_3 . Diacylglycerol activates protein kinase C, which phosphoryl-

TABLE 20.8 Examples of Polypeptide Hormones that Stimulate the Phosphatidylinositol Pathway

Hormone	Location of Action
TRH	Thyrotrope of the anterior pituitary releasing TSH
GnRH	Gonadotrope of the anterior pituitary releasing LH and FSH
AVP	Corticotrope of the anterior pituitary; assists CRH in releasing ACTH; hepatocyte: causes increase in cellular Ca^{2+}
TSH	Thyroid follicle: releasing thyroid hormones causes increase in phosphatidylinositol cycle as well as increase in protein kinase A pathway
Angiotensin II/III	<i>Zona glomerulosa</i> cell of adrenal cortex: releases aldosterone
Epinephrine (thrombin)	Platelet: releasing ADP/serotonin; hepatocyte via α receptor: releasing intracellular Ca^{2+}

ates specific proteins, some of which may participate in the resulting secretory process to transport LH and FSH to the cell exterior. The product IP_3 , which binds to a receptor on the membrane of the calcium storage particle, probably located near the cell membrane, stimulates the release of calcium ion. Elevated cytosolic Ca^{2+} causes increased stimulation of protein kinase C and participates in the exocytosis of LH and FSH from the cell.

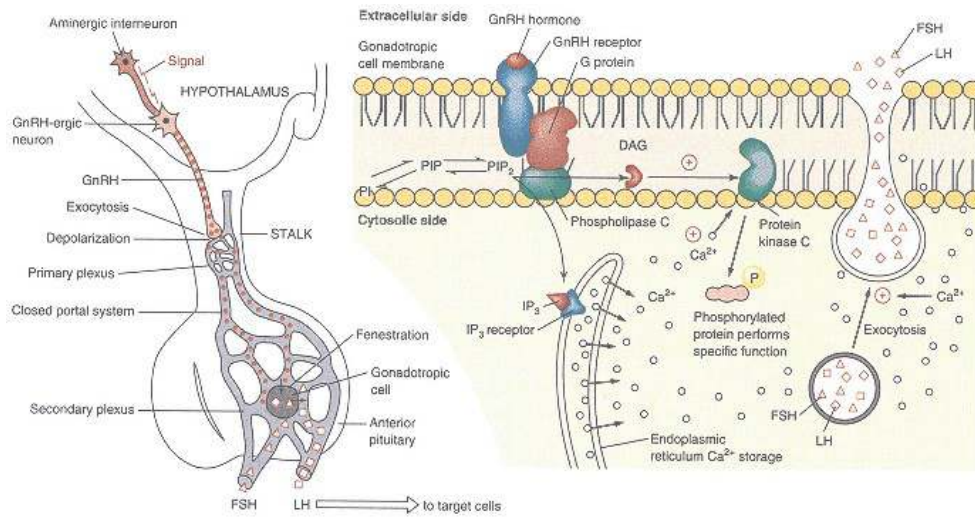

Figure 20.39

Overview of regulation of secretion of LH and FSH.

A general mode of action of GnRH to release the gonadotropes from the gonadotropic cell of the anterior pituitary is presented. GnRH, gonadotropin-releasing hormone; FSH, follicle-stimulating hormone; LH, luteinizing hormone; DAG, diacylglycerol.

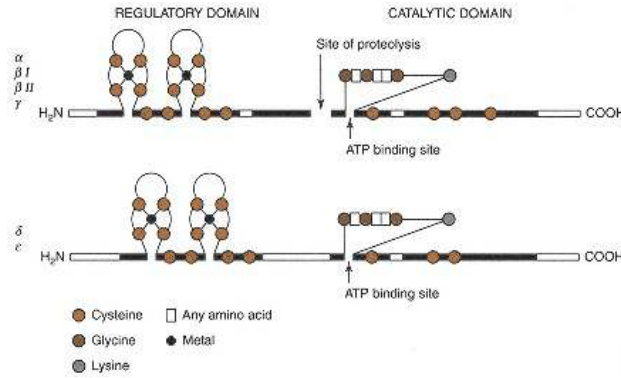

Figure 20.40
Common structure of protein kinase C subspecies.
 Modified from U. Kikkawa, A. Kishimoto, and Y. Nishizuka, *Annu. Rev. Biochem.* 58:31, 1989.

Much recent work has focused on protein kinase C. It has been shown to have a number of subspecies; such heterogeneity may indicate that there are multiple functions for this critical enzyme (Figure 20.40). The enzyme consists of two domains, a regulatory and a catalytic domain, which can be separated by proteolysis at a specific site. The free catalytic domain, formerly called **protein kinase M**, can phosphorylate proteins free of the regulatory components. The free catalytic subunit, however, may be degraded. More needs to be learned about the dynamics of this system and the translocation of the enzyme from one compartment to another. The regulatory domain contains two Zn^{2+} fingers usually considered to be hallmarks of DNA-binding proteins (see Chapter 3). This DNA-binding activity has not yet been demonstrated for protein kinase C and metal fingers may participate in other types of interactions. The ATP-binding site in the catalytic domain contains the G box, GXGXXG, which is a consensus sequence for ATP binding with a downstream lysine residue.

**Activity of Atrial Natriuretic Factor (ANF):
 Protein Kinase G**

The third system is the **protein kinase G** system, which is stimulated by the elevation of cytosolic cGMP (Figure 20.41). **Cyclic GMP** is synthesized by guanylate cyclase from GTP. Like adenylate cyclase, guanylate cyclase is linked to a specific biological signal through a membrane receptor. The guanylate cyclase extracellular domain may serve the role of the hormone receptor. This is directly coupled to the cytosolic domain through one membrane-spanning domain (Figure 20.42), which may be applicable to the **atrial natriuretic factor (ANF)**; also referred to as **atriopeptin receptor-guanylate cyclase system**. Thus the hormone-binding site, transmembrane domain, and guanylate cyclase activities are all served by a single polypeptide chain.

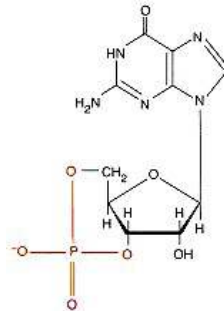

Figure 20.41
 Structure of cGMP.

This hormone is a family of peptides, as shown in Figure 20.43; a sequence of human ANF is shown at the bottom. The functional domains of the ANF receptor are illustrated in Figure 20.44. Atrial natriuretic factor is released from atrial cells of the heart under control of several hormones. Data from atrial cell culture suggest that ANF secretion is stimulated by activators of protein kinase C and decreased by activators of protein kinase A. These opposing actions may be mediated by the actions of α - and β -adrenergic receptors, respectively. An overview of the secretion of ANF and its general effects is shown in Figure 20.45. ANF is released by a number of signals, such as blood volume expansion, elevated blood pressure directly induced by vasoconstrictors, high salt intake,

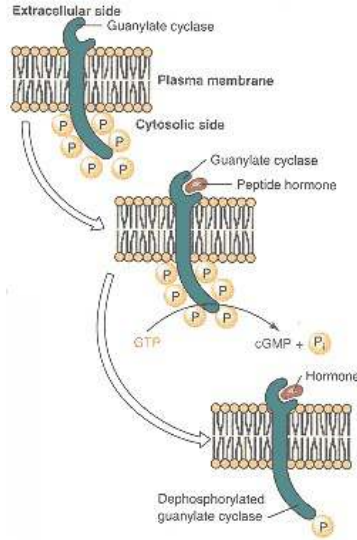

Figure 20.42
Model for the regulation of guanylate cyclase activity after peptide hormone binding.
 The enzyme exists in a highly phosphorylated state under normal conditions. Binding of hormone markedly enhances enzyme activity, followed by a rapid dephosphorylation of guanylate cyclase and a return of activity to basal state despite continued presence of hormonal peptide.
 Redrawn from Schultz, S., Chinkers, M., and Garbers, D. L. *FASEB J.* 3:2026, 1989.

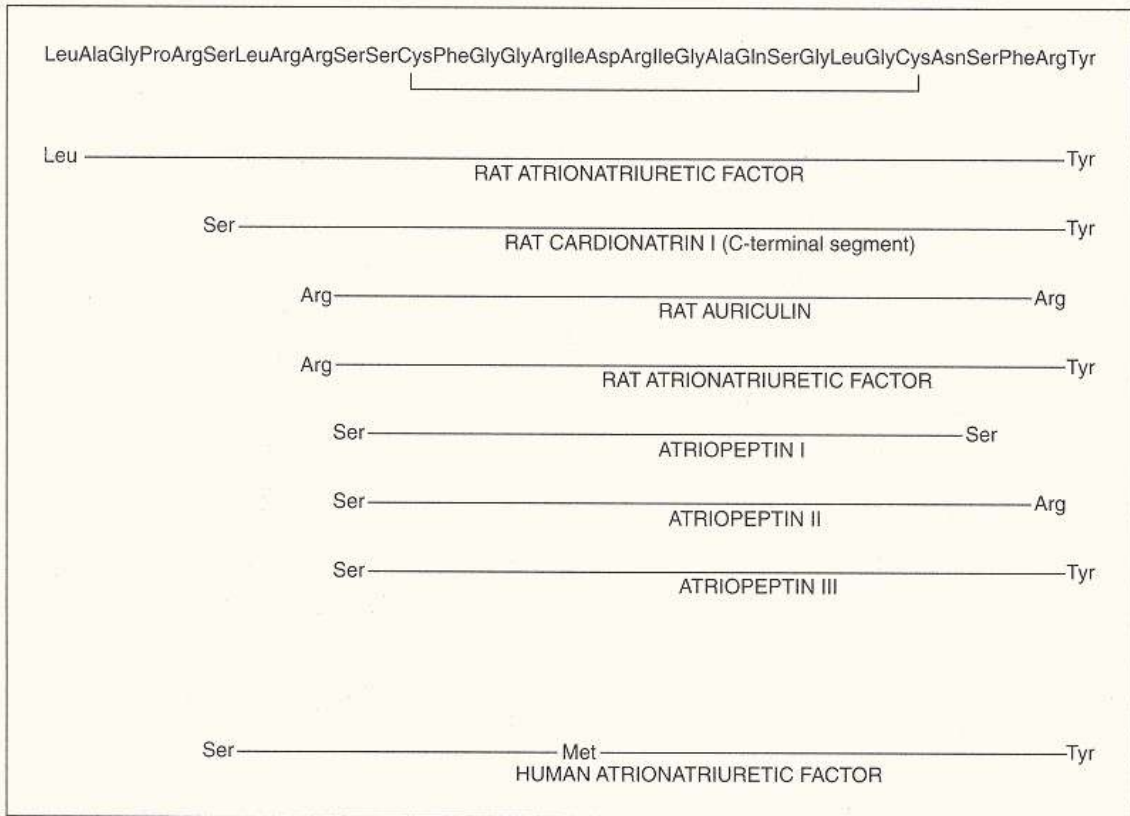

Figure 20.43
Atrial natriuretic peptides.
 These active peptides relax vascular smooth muscle and produce vasodilation and natriuresis as well as other effects discussed in the text.
 Adapted from Carlin, M., and Genest, J. The heart and the atrial natriuretic factor. *Endocr. Rev.* 6:107, 1985.

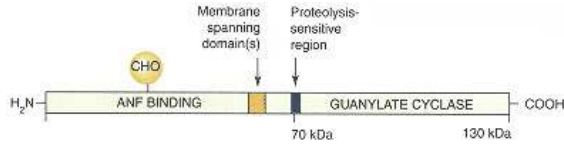

Figure 20.44

Functional domains of ANF-R₁ receptor.

Hypothetical model shows the sequence of an ANF-binding domain, a membrane-spanning domain(s), a proteolysis-sensitive region, a guanylate cyclase catalytic domain, glucosylation sites (CHO), and amino (H₂N) and carboxyl terminals (COOH) of receptor.

Redrawn from Liu, B., Meloche, S., McNicoll, N., Lord, C., and DeLéan, A. *Biochemistry* 28:5599, 1989.

and increased heart pumping rate. ANF is secreted as a dimer that is inactive for receptor interaction and is converted in plasma to a monomer capable of interacting with receptor. The actions of ANF (Figure 20.45) are to increase the glomerular filtration rate without increasing renal blood flow, leading to increased urine volume and excretion of sodium ion. Renin secretion is also reduced and aldosterone secretion by the adrenal cortex is lowered. This action reduces aldosterone-mediated sodium reabsorption. ANF inhibits the vasoconstriction produced by angiotensin II and relaxes the constriction of the renal vessels, other vascular beds, and large arteries. ANF operates through its mem-

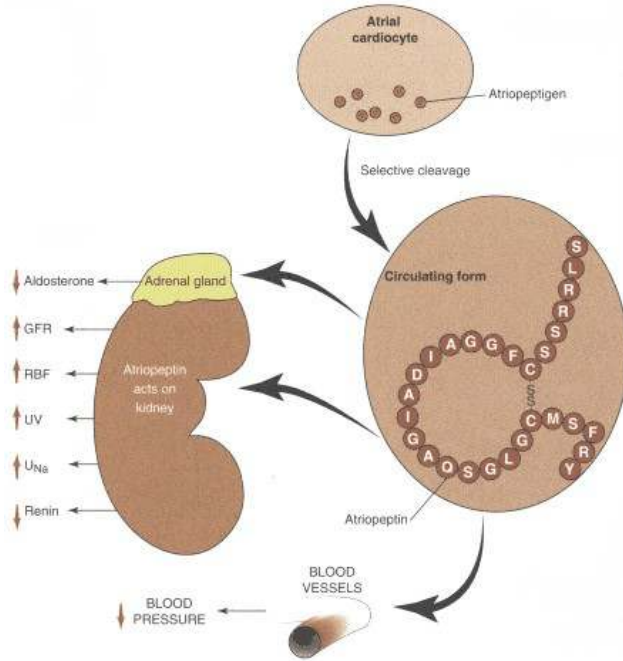

Figure 20.45

Schematic diagram of atrial natriuretic factor–atriopeptin hormonal system.

Prohormone is stored in granules located in perinuclear atrial cardiocytes. An elevated vascular volume results in cleavage and release of atriopeptin, which acts on the kidney (glomeruli and papilla) to increase the glomerular filtration rate (GFR), to increase renal blood flow (RBF), to increase urine volume (UV) and sodium excretion (U_{Na}), and to decrease plasma renin activity. Natriuresis and diuresis are also enhanced by the suppression of aldosterone secretion by the adrenal cortex and the release from the posterior pituitary of arginine vasopressin. Vasodilatation of blood vessels also results in a lowering of blood pressure (BP). Diminution of vascular volume provides a negative feedback signal that suppresses circulating levels of atriopeptin.

Redrawn from Needleman, P., and Greenwald, J. E. Atriopeptin: a cardiac hormone intimately involved in fluid, electrolyte, and blood pressure homeostasis. *N. Engl. J. Med.* 314:828, 1986.

brane receptor, which appears to be the extracellular domain of guanylate cyclase. The cGMP produced activates protein kinase G, which further phosphorylates cellular proteins to express many of the actions of this pathway. More needs to be learned about protein kinase G. Using analogs of ANF it has been shown that the majority of receptors expressed in the kidney are biologically silent, since they fail to elicit a physiological response. This new class of receptors may serve as specific peripheral storage–clearance binding sites and as such act as a hormonal buffer system to modulate plasma levels of ANF.

20.13—

Oncogenes and Receptor Functions

Oncogenes are genes that are expressed by cancerous transformed cells. A cancer cell may express few or many oncogenes that dictate the aberrant uncontrolled behavior of the cell. There are three mechanisms by which oncogenes allow a cell to escape dependence on exogenous growth factors; these are presented in Figure 20.46. Some oncogenes are genes for parts of receptors, most often related to growth factor hormone receptors, which can function in the absence of the hormonal ligand. Thus an oncogene may represent a truncated gene where the ligand-binding domain is missing. This would result in production of the receptor protein, insertion into the cell membrane, and continuous constitutive function in the absence or presence of ligand (Figure 20.46*b,c*). In this situation the second messengers would be produced constitutively at a high rate, instead of being regulated by ligand, and the result would be uncontrolled growth of the cell. Some oncogenes may have tyrosine protein kinase activity and therefore function like tyrosine kinase normally related to certain cell membrane receptors. Other oncogenes relate to thyroid and steroid hormone receptors (see Chapter 21) while still others are DNA-binding proteins, some of which may be transactivating factors or related to such factors. Oncogene-encoded proteins that bind to DNA may be identical with or related to transactivating factors. The oncogene *Jun*, for example, is a component of activator protein 1 (AP1), a transactivating factor that regulates transcription. Table 20.9 reviews some of the oncogenes, or cancer-causing genes, together with the functions of their proto-oncogenes (normal proliferation gene).

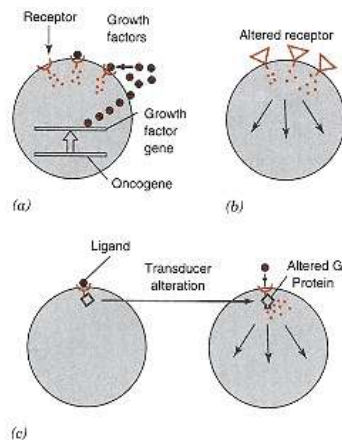

Figure 20.46

Mechanisms by which oncogenes can allow a cell to escape dependence on exogenous growth factors.

- (a) By autocrine mechanism, where the cytosolic oncogene indirectly stimulates expression of growth factor gene and oversecretion of growth factors, which then over-stimulates receptors on same cell;
 - (b) by receptor alteration so that receptor is "permanently turned on" without a requirement for growth factor binding; and
 - (c) by transducer alteration, where the intermediate between the receptor and its resultant activity, that is, the GTP-stimulatory protein, is permanently activated, uncoupling the normal requirement of ligand–receptor binding.
- Redrawn from Weinberg, R. A. The action of oncogenes in the cytoplasm and nucleus. *Science* 230:770, 1985.

TABLE 20.9 Known Oncogenes, Their Products and Functions^a

Name of Oncogene			Oncogenic Protein	
	Retrovirus	Virus-Induced Tumor	Cellular Location	Proto-oncogene Function
<i>src</i>	Chicken sarcoma	Chicken sarcoma	Plasma membrane	Tyrosine-specific protein kinase
<i>yes</i>	Chicken sarcoma		Plasma membrane (?)	
<i>fgr</i>	Cat sarcoma		(?)	
<i>abl</i>	Mouse leukemia	Human leukemia	Plasma membrane	Tyrosine-specific protein kinase
<i>fps</i>	Chicken sarcoma		Cytoplasm (plasma membrane?)	
<i>fes</i>	Cat sarcoma	Sarcoma	Cytoplasm (cytoskeleton?)	Tyrosine-specific protein kinase
<i>ros</i>	Chicken sarcoma		(?)	
<i>erb-B</i>	Chicken leukemia	Erythroleukemia, fibrosarcoma	Plasma and cytoplasmic membranes	EGF receptor's cytoplasmic tyrosine-specific protein kinase domain
<i>fms</i>	Cat sarcoma	Sarcoma	Plasma and cytoplasmic membranes	Tyrosine-specific protein kinase; macrophage colony-stimulating factor receptor
<i>mil</i>	Chicken carcinoma		Cytoplasm	(?)
<i>raf</i>	Mouse sarcoma	Sarcoma	Cytoplasm	Protein kinase (serine/threonine) activated by Ras
<i>mos</i>	Mouse sarcoma	Mouse leukemia	Cytoplasm	(?)
<i>sis</i>	Monkey sarcoma	Monkey sarcoma	Secreted	PDGF-like growth factor, β -chain
<i>Ha-ras</i>	Rat sarcoma	Human carcinoma, rat carcinoma	Plasma membrane	GTP-binding protein
<i>Ki-ras</i>	Rat sarcoma	Human carcinoma, leukemia, and sarcoma	Plasma membrane	GTP-binding protein
<i>N-ras</i>	—	Human leukemia and carcinoma	Plasma membrane	
<i>myc</i>	Chicken leukemia	Sarcoma, myelocytoma, and carcinoma	Nucleus	DNA-binding related to cell proliferation; transcriptional control
<i>myb</i>	Chicken leukemia	Human leukemia	Nucleus	(?)
<i>B-lym</i>	—	Chicken lymphoma, human lymphoma	Nucleus (?)	(?)
<i>ski</i>	Chicken sarcoma		Nucleus (?)	(?)
<i>rel</i>	Turkey leukemia	Reticuloendotheliosis	(?)	(?)
<i>erb-A</i>	Chicken leukemia		(?)	Thyroid hormone receptor (c-erb-A α 1); related to steroid hormone receptors, retinoic acid receptor, and vitamin D ₃ receptor
<i>ets</i>	Chicken leukemia		(?)	DNA binding
<i>elk</i> (<i>ets</i> -like)				DNA-binding protein
<i>jun</i>		Osteosarcoma		Products associate to form AP1 gene transcription factor
<i>fos</i>		Fibrosarcoma		Products associate to form AP1 gene transcription factor

Source: Adapted from Hunter, T. The proteins of oncogenes. *Sci. Am.* 251:70, 1984.

^a The second column gives the source from which each viral oncogene was first isolated and the cancer induced by the oncogene. Some names, such as *fps* and *fes*, may be equivalent genes in birds and mammals. The third column lists human and animal tumors caused by agents other than viruses in which the *ras* oncogene or an inappropriately expressed proto-oncogene has been identified.

Bibliography

- Alberts, B., Bray, D., Lewis, J., Raff, R., Roberts, K., and Watson, J. D. *Molecular Biology of the Cell*, 3rd ed. New York: Garland Publishing, 1994.
- Cuatrecasas, P. Hormone receptors, membrane phospholipids, and protein kinases. *The Harvey Lectures Series* 80:89, 1986.
- DeGroot, L. J., (Ed.). *Endocrinology*. Philadelphia: Saunders, 1995.
- Hunter, T. The proteins of oncogenes. *Sci. Am.* 251:70, 1984.
- Krieger, D. T., and Hughes, J. C. (Eds.). *Neuroendocrinology*. Sunderland, MA: Sinauer Associates, 1980.
- Litwack, G. (Ed.). *Biochemical Actions of Hormones*, Vols. 1–14. New York: Academic Press, 1973–1987.
- Litwack, G. (Ed. in Chief) *Vitamins and Hormones*, Vol. 50. Orlando: Academic Press, 1995.
- Norman, A. W., and Litwack, G. *Hormones*. Orlando: Academic Press, 1987.
- Richter, D. Molecular events in expression of vasopressin and oxytocin and their cognate receptors. *Am. J. Physiol.* 255:F207, 1988.
- Ryan, R. J., Charlesworth, M. C., McCormick, D. J., Milius, R. P., and Keutmann, H. T. *FASEB J.* 2:2661, 1988.
- Saltiel, A. R. The paradoxical regulation of protein phosphorylation in insulin action. *FASEB J.* 8:1034, 1994.
- Spiegel, A. M., Shenker, A., and Weinstein, L. S. Receptor–effector coupling by G proteins: implication for normal and abnormal signal-transduction. *Endocr. Rev.* 13:536, 1992.
- Struthers, A. D. (Ed.) *Atrial Natriuretic Factor*. Boston: Blackwell Scientific Publications, 1990.
- Weinberg, R. A. The action of oncogenes in the cytoplasm and nucleus. *Science* 230:770, 1985.

Questions

J. Baggott and C. N. Angstadt

- In a cascade of hormones (e.g., hypothalamus, pituitary, and target tissue), at each successive level:
 - the quantity of hormone released and its half-life can be expected to increase.
 - the quantity of hormone released increases, but its half-life does not change.
 - the quantity of hormone released and its half-life are approximately constant.
 - the quantity of hormone released decreases, but its half-life does not change.
 - the quantity of hormone released and its half-life can both be expected to decrease.
- All of the following have an identical (or very similar) α sub-unit EXCEPT:
 - growth hormone.
 - thyroid-stimulating hormone.
 - luteinizing hormone.
 - follicle-stimulating hormone.
- If a single gene contains information for the synthesis of more than one hormone molecule:
 - all the hormones are produced by any tissue that expresses the gene.
 - all of the hormone molecules are identical.
 - cleavage sites in the gene product are typically pairs of basic amino acids.
 - all of the peptides of the gene product have well-defined biological activity.
 - the hormones all have similar function.
- In the sequence of events associated with signal transduction, which one is out of place? Receptor binds hormone.
 - Conformational change occurs in receptor.
 - Receptor interacts with G-protein.
 - α Subunit of G-protein hydrolyzes GTP.
 - α Subunit of G-protein dissociates from β and γ subunits.
 - α Subunit of G-protein binds to adenylate cyclase.
- The direct effect of cAMP in the protein kinase A pathway is to:
 - activate adenylate cyclase.
 - dissociate regulatory subunits from protein kinase.
 - phosphorylate certain cellular proteins.
 - phosphorylate protein kinase A.
 - release hormones from a target tissue.
- Activation of phospholipase C initiates a sequence of events including all of the following EXCEPT:
 - release of inositol 4,5-bisphosphate from a phospholipid.
 - increase in intracellular Ca^{2+} concentration.
 - release of diacylglycerol (DAG) from a phospholipid.
 - activation of protein kinase C.
 - phosphorylation of certain cytoplasmic proteins.
- In the ovarian cycle:
 - GnRH enters the vascular system via transport by a specific membrane carrier.
 - the corpus luteum dies only if fertilization does not occur.
 - inhibin works by inhibiting the synthesis of the α subunit of FSH.
 - FSH activates a protein kinase A pathway.
 - LH is taken up by the corpus luteum and binds to cytoplasmic receptors.
- The Scatchard plot, shown in the accompanying figure, could be used to determine kinetic parameters of an enzyme. Which letter in the graph corresponds to total binding sites in a Scatchard plot or V_{max} in an enzyme kinetic plot?
 

9. With the anterior pituitary hormones, TSH, LH, and FSH:

- the α subunits are all different.
- the β subunits are specifically recognized by the receptor.
- the β subunit alone can bind to the receptor.
- hormonal activity is expressed through activation of protein kinase B.
- intracellular receptors bind these hormones.

10. In the interaction of a hormone with its receptor, all of the following are true EXCEPT:

- A. more than one polypeptide chain of the hormone may be necessary.
- B. more than one second messenger may be generated.
- C. an array of transmembrane helices may form the binding site for the hormone.
- D. receptors have a greater affinity for hormones than for synthetic agonists or antagonists.
- E. hormones released from their receptor after endocytosis could interact with a nuclear receptor.

In the following questions, match the numbered hormone with the lettered kinase it stimulates.

- A. protein kinase A
- B. tyrosine kinase
- C. protein kinase C
- D. protein kinase G

- 11. Atrial natriuretic factor.
- 12. Gonadotropin-releasing hormone.
- 13. Insulin.
- 14. Vasopressin.

Answers

- 1. A Each successive step typically releases a larger amount of a longer lived hormone (p. 842).
- 2. A All of these are anterior pituitary hormones, but only the last three, the glycoprotein hormones, have an α subunit that is similar or identical from hormone to hormone (p. 846).
- 3. C One or more trypsin-like proteases catalyze the reaction (Figure 20.5). A: The POMC gene product is cleaved differently in different parts of the anterior pituitary (p. 849). B: Multiple copies of a single hormone may occur (p. 852), but not necessarily (Figure 20.5, p. 850). D: Some fragments have no known function. E: ACTH and β -endorphin, for example, hardly have similar functions (p. 847; Table 20.2).
- 4. C Hydrolysis of GTP returns the α subunit to its original conformation and allows it to associate with the β and γ subunits (p. 861).
- 5. B cAMP binding causes a conformational change in the regulatory subunits, resulting in the release of active protein kinase A (p. 862).
- 6. A Inositol 1,4,5-triphosphate (IP_3) is released from the phospholipid, phosphatidylinositol 4,5-bisphosphate (PIP_2) (p. 862).
- 7. D A: GnRH enters the vascular system through fenestrations (p. 868). B: The corpus luteum is replaced by the placenta if fertilization occurs (p. 870). C: The glycoprotein hormones share a common α subunit. Specific control of them would not involve a subunit they share. E: LH interacts with receptors on the cell membrane.
- 8. D A is free ligand concentration (analogous to substrate concentration), B is bound ligand concentration (analogous to K_m), C is the equilibrium constant (analogous to K_m), and D is the extrapolated maximum number of binding sites (analogous to V_{max}) (p. 872).
- 9. B A: The α subunits are identical or nearly so (p. 872). B and C: Although specificity is conferred by the β subunits, which differ among the three hormones, binding to the receptor requires both subunits (p. 873). D: It is protein kinase A, and perhaps also protein kinase C in the case of TSH (p. 873). E: These large glycoprotein hormones do not penetrate the cell membrane; they bind to receptors on the cell surface (p. 874). See Figure 20.30.
- 10. D β Receptors bind isoproterenol more tightly than their hormones (p. 875). A and B: These are true of the glycoprotein hormones (p. 873). C: This appears to be true for the β_1 receptor (Figure 20.31). E: This is possible, but entirely speculative; there are currently no known examples.
- 11. D See p. 885.
- 12. C See p. 883.
- 13. B See p. 879.
- 14. A See p. 880.

Chapter 21— Biochemistry of Hormones II: Steroid Hormones

Gerald Litwack and Thomas J. Schmidt

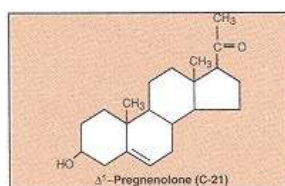

21.1 Overview	894
21.2 Structures of Steroid Hormones	894
21.3 Biosynthesis of Steroid Hormones	896
Steroid Hormones Are Synthesized from Cholesterol	896
21.4 Metabolic Inactivation of Steroid Hormones	901
21.5 Cell–Cell Communication and Control of Synthesis and Release of Steroid Hormones	901
Steroid Hormone Synthesis Is Controlled by Specific Hormones	901
Aldosterone	901
Estradiol	905
Vitamin D ₃	907
21.6 Transport of Steroid Hormones in Blood	908
Steroid Hormones Are Bound to Specific Proteins or Albumin in Blood	908
21.7 Steroid Hormone Receptors	909
Steroid Hormones Bind to Specific Intracellular Protein Receptors	909
Some Steroid Receptors Are Part of the <i>cErbA</i> Family of Proto-oncogenes	913
21.8 Receptor Activation: Upregulation and Downregulation	914
Steroid Receptors Can Be Upregulated or Downregulated Depending on Exposure to the Hormone	915
21.9 A Specific Example of Steroid Hormone Action at Cell Level: Programmed Death	915
Bibliography	916
Questions and Answers	917
Clinical Correlations	
21.1 Oral Contraception	907
21.2 Apparent Mineralocorticoid Excess Syndrome	911
21.3 Programmed Cell Death in the Ovarian Cycle	916

21.1— Overview

Steroid hormones in the human include cortisol as the major glucocorticoid or anti-stress hormone, aldosterone as an important regulator of Na^+ uptake, and the sex and progestational hormones. Sex hormones are 17β -estradiol in females and testosterone in males. Progesterone is the major progestational hormone. Testosterone is reduced in some target tissues to dihydrotestosterone, a higher affinity ligand for the androgen receptor. Vitamin D_3 is converted to the steroid hormone, dihydroxy vitamin D_3 . Genes in the steroid receptor supergene family include retinoic acid receptors and thyroid hormone receptor, although the ligands for these additional receptors are not derivatives of cholesterol. Retinoic acid and thyroid hormone, however, have six-membered ring structures that could be considered to resemble the A ring of a steroid.

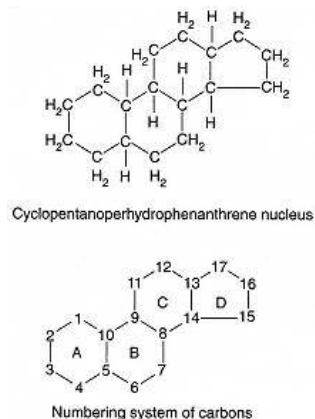

Figure 21.1
The steroid nucleus.

Steroidal structure will be reviewed with the synthesis and inactivation of steroid hormones. Regulation of synthesis of steroid hormones is reviewed with respect to the renin–angiotensin system for aldosterone, the gonadotropes, especially follicle-stimulating hormone for 17β -estradiol, and the vitamin D_3 mechanism. Steroid hormone transport is reviewed with respect to the transporting proteins in blood. A general model for steroid hormone action at the cellular level is presented with information on receptor activation and regulation of receptor levels. Specific examples of steroid hormone action for programmed cell death and for stress are presented. Finally, the roles of steroid hormone receptors as transcriptional transactivators and repressors are reviewed.

21.2— Structures of Steroid Hormones

Steroid hormones are derived in specific tissues in the body and are divided into two classes: the **sex** and **progestational hormones**, and the **adrenal hormones**. They are synthesized from cholesterol and all of these hormones pass through the required intermediate, 5 -pregnenolone. The structure of steroid hormones is related to the **cyclopentanoperhydrophenanthrene** nucleus. The numbering of the cyclopentanoperhydrophenanthrene ring system and the lettering of the rings is presented in Figure 21.1. The ring system of the steroid hormones is stable and not catabolized by mammalian cells. Conversion of active hormones to less active or inactive forms involves alteration of ring substituents rather than the ring structure itself. The parental precursor of the steroid is **cholesterol**, shown in Figure 21.2. The biosynthesis of cholesterol is given on p. 410.

The major steroid hormones of humans and their actions are shown in Table 21.1. Many of these hormones are similar in gross structure, although the specific receptor for each hormone is able to distinguish the cognate ligand. In the cases of cortisol and aldosterone, however, there is overlap in the ability of each specific receptor to bind both ligands. Thus the availability and concen-

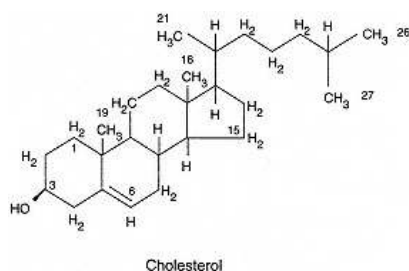
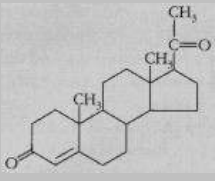
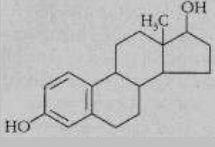
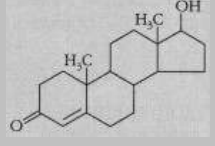
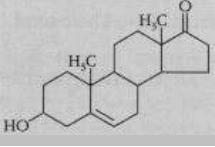
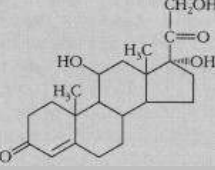
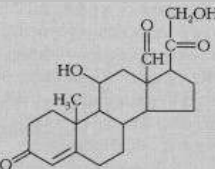
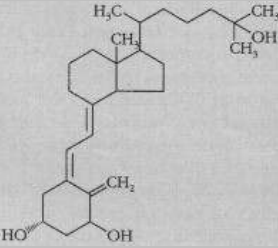

Figure 21.2
Structure of cholesterol.

TABLE 21.1 Major Steroid Hormones of Humans

Hormone	Structure	Secretion from	Secretion Signal ^a	Functions
Progesterone		Corpus luteum	LH	Maintains (with estradiol) the uterine endometrium for implantation; differentiation factor for mammary glands
17 β -Estradiol		Ovarian follicle; corpus luteum; (Sertoli cell)	FSH	Female: regulates gonadotropin secretion in ovarian cycle (see Chapter 20); maintains (with progesterone) uterine endometrium; differentiation of mammary gland. Male: negative feedback inhibitor of Leydig cell synthesis of testosterone
Testosterone		Leydig cells of testis; (adrenal gland); ovary	LH	Male: after conversion to dihydrotestosterone, production of sperm proteins in Sertoli cells; secondary sex characteristics (in some tissues testosterone is active hormone)
Dehydroepian-drosterone		Reticularis cells	ACTH	Various protective effects; weak androgen; can be converted to estrogen; no receptor yet found; inhibitor of G6-PDH: regulates NAD ⁺ coenzymes
Cortisol		Fasciculata cells	ACTH	Stress adaptation through various cellular phenotypic expressions; slight elevation of liver glycogen; killing effect on certain T cells in high doses; elevates blood pressure; sodium uptake in luminal epithelia
Aldosterone		Glomerulosa cells of adrenal cortex	Angiotensin II/III	Causes sodium ion uptake via conductance channel; occurs in high levels during stress; raises blood pressure; fluid volume increased
1,25-Dihydroxy-vitamin D ₃		Vitamin D arises in skin cells after irradiation and then successive hydroxylations occur in liver and kidney to yield active form of hormone	PTH (stimulates kidney proximal tubule hydroxylation system)	Facilitates Ca ²⁺ and phosphate absorption by intestinal epithelial cells; induces intracellular calcium-binding protein

^a LH, luteinizing hormone; FSH, follicle-stimulating hormone; ACTH, adrenocorticotropic hormone; PTH, parathyroid hormone.

trations of each receptor and the relative amounts of each hormone in a given cell become paramount considerations. The steroid hormones listed in Table 21.1 can be described as classes based on the carbon number in their structures. Thus a C-27 steroid is $1,25(\text{OH})_2\text{D}_3$; C-21 steroids are **progesterone**, **cortisol**, and **aldosterone**; C-19 steroids are **testosterone** and **dehydroepiandrosterone**; and a C-18 steroid is **17 β -estradiol**. Classes, such as sex hormones, can be distinguished easily by the carbon number, C-19 being androgens, C-18 being estrogens, and C-21 being progestational or adrenal steroids. Aside from the number of carbon atoms in a class structure, certain substituents in the ring system are characteristic. For example, glucocorticoids and mineralocorticoids (typically aldosterone) possess a C-11 OH or oxygen function. In rare exceptions, certain synthetic compounds can elicit a response without a C-11 OH group but they require a new functional group in proximity within the A-B ring system. Estrogens do not have a C-19 methyl group and the A ring is contracted by the content of three double bonds. Many receptors recognize the ligand A ring primarily, the estrogen receptor can distinguish the A ring of estradiol stretched out of the plane of the B-C-D rings compared to other steroids in which the A ring is coplanar with the B-C-D rings. These relationships are shown in Figure 21.3.

21.3—

Biosynthesis of Steroid Hormones

Steroid Hormones Are Synthesized from Cholesterol

Hormonal regulation of steroid hormone biosynthesis is generally believed to be mediated by an elevation of intracellular **cAMP** and **Ca²⁺**, although generation of **inositol triphosphate** may also be involved, as shown in Figure 21.4. The stimulatory response of cAMP is mediated via acute (occurring within seconds to minutes) and chronic (requiring hours) effects on steroid synthesis. The acute effect is to mobilize and deliver cholesterol, the precursor for all steroid hormones, to the mitochondrial inner membrane, where it is metabolized to pregnenolone by the cytochrome P450 cholesterol side chain cleavage enzyme (see Chapter 22 for discussion of P450 enzymes). In contrast, the chronic effects of cAMP are mediated via increased transcription of the genes that encode the steroidogenic enzymes and are thus responsible for maintaining optimal long-term steroid production. Data demonstrate that a protein is induced and that this newly synthesized regulatory protein actually facilitates the translocation of cholesterol from outer to inner mitochondrial membrane where the P450 enzyme is located. This 30-kDa phosphoprotein is designated as the **steroidogenic acute regulatory (StAR)** protein. In humans, StAR mRNA has been shown to be specifically expressed in testis and ovary, known sites of steroidogenesis. Patients with lipoid congenital adrenal hyperplasia (LCAH), an inherited disease in which both adrenal and gonadal steroidogenesis is significantly impaired and lipoidal deposits occur in these tissues, express truncated and non-functional StAR proteins. These biochemical and genetic data strongly suggest that StAR protein is the hormone-induced protein factor that mediates acute regulation of steroid hormone biosynthesis.

Pathways for conversion of cholesterol to the adrenal cortical steroid hormones are presented in Figure 21.5. Cholesterol is the major precursor and undergoes side chain cleavage to form Δ^5 -pregnenolone releasing a C₆ aldehyde, isocaproaldehyde. **Δ^5 -Pregnenolone** is mandatory in the synthesis of all steroid hormones. As shown in Figure 21.5, pregnenolone can be converted directly to progesterone, which requires two cytoplasmic enzymes, **3 β -ol dehydrogenase** and **Δ^4 -isomerase**. The dehydrogenase converts the 3-OH group of pregnenolone to a 3-keto group and the isomerase moves the double bond from the B ring to the A ring to produce progesterone. In the *corpus luteum* the bulk

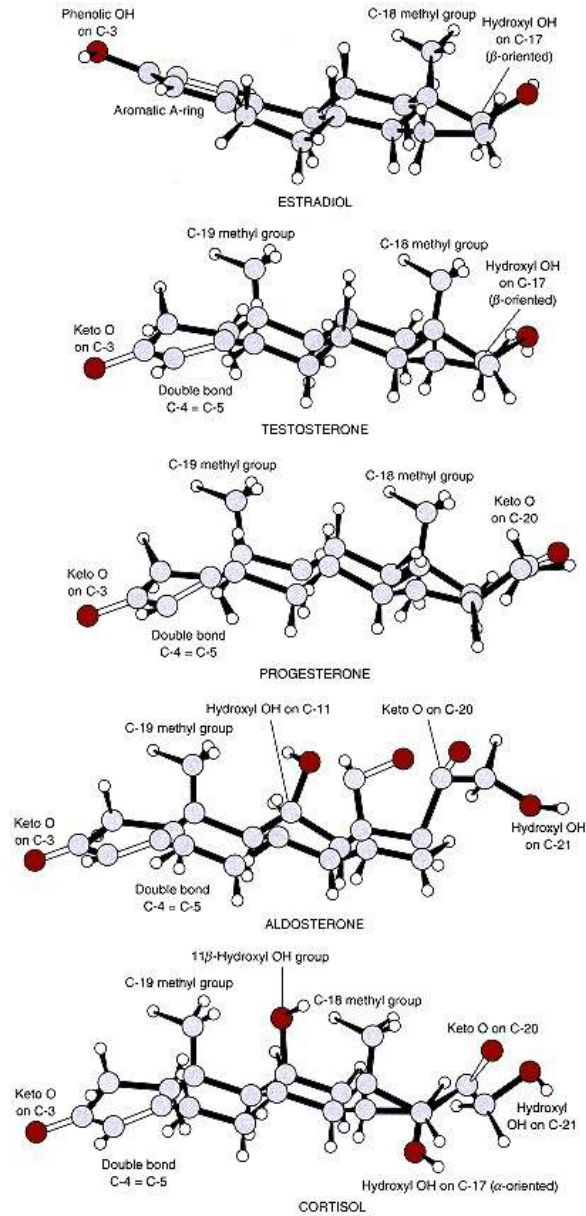
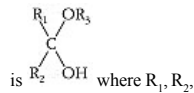

Figure 21.3
"Ball-and-stick" representations of the structures of some steroid hormones determined by X-ray crystallographic methods. Details of each structure are labeled. In aldosterone the acetal grouping



R_3 refer to different substituents.

Reprinted with permission from Glusker, J. P. In G. Litwack (Ed.), *Biochemical Actions of Hormones*, Vol. 6. New York: Academic Press, 1979, pp. 121–204.

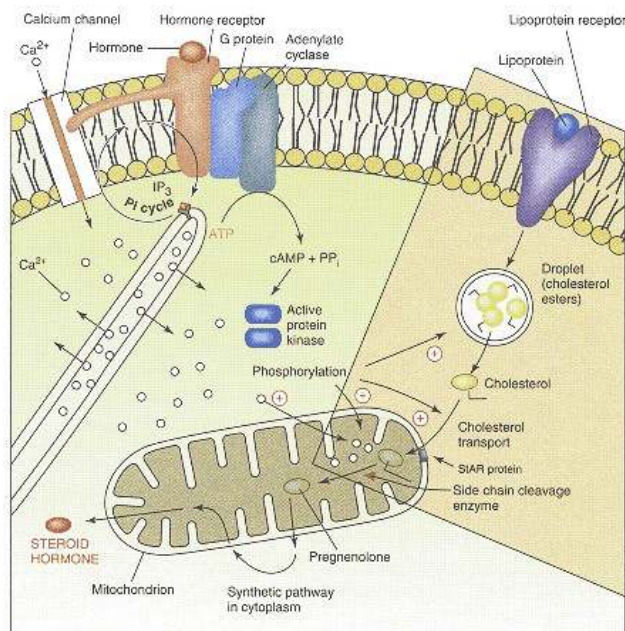

Figure 21.4

Overview of hormonal stimulation of steroid hormone biosynthesis.

Nature of the hormone (top of figure) depends on the cell type and receptor (ACTH for cortisol synthesis; FSH for estradiol synthesis; LH for testosterone synthesis, etc., as given in Table 20.1). It binds to cell membrane receptor and activates adenylate cyclase mediated by a stimulatory G-protein. Receptor, activated by hormone, may directly stimulate a calcium channel or indirectly stimulate it by activating the phosphatidylinositol cycle (PI cycle) as shown in Figure 20.25. If the PI cycle is concurrently stimulated, IP_3 could

augment cytosol Ca^{2+} levels from the intracellular calcium store. The increase in cAMP activates protein kinase A (Figure 21.21) whose phosphorylations cause increased hydrolysis of cholesteryl esters from the droplet to free cholesterol and increase cholesterol transport into the mitochondrion. The combination of elevated Ca^{2+} levels and protein phosphorylation, as well as induction of the StAR protein, result in increased side chain cleavage and steroid biosynthesis. These combined reactions overcome the rate-limiting steps in steroid biosynthesis and more steroid is produced, which is secreted into the extracellular space and circulated to the target tissues in the bloodstream.

of steroid synthesis stops at this point. Progesterone is further converted to aldosterone or cortisol. Conversion of pregnenolone to **aldosterone**, which occurs in the adrenal *zona glomerulosa* cells, requires endoplasmic reticulum 21-hydroxylase, and mitochondrial 11β -hydroxylase and 18-hydroxylase. To form cortisol, primarily in adrenal *zona fasciculata* cells, endoplasmic reticulum **17-hydroxylase** and **21-hydroxylase** are required together with mitochondrial **11 β -hydroxylase**. The endoplasmic reticulum (ER) hydroxylases are all cytochrome P450-linked enzymes (see Chapter 22). 5 -Pregnenolone is converted to **dehydroepiandrosterone** in the adrenal *zona reticularis* cells by the action of 17α -hydroxylase of the endoplasmic reticulum to form 17α -hydroxypregnenolone and then by the action of a carbon side chain-cleavage system to form dehydroepiandrosterone.

Cholesterol is also converted to the sex hormones by way of 5 -pregnenolone (Figure 21.6). **Progesterone** can be formed as described above and further converted to testosterone by the action of the endoplasmic reticulum enzymes and 17-dehydrogenase. **Testosterone**, so formed, is a major secretory product in the Leydig cells of the testis and undergoes conversion to dihydrotestosterone in some androgen target cells before binding to the androgen receptor. This conversion requires the activity of **5 α -reductase** located in the ER and nuclear fractions. Pregnenolone can enter an alternative pathway to form dehydroepiandrosterone as described above. This compound can be converted to 17β -estradiol via the aromatase enzyme system and the action of 17-reductase. Also, estradiol can be formed from testosterone by the action of the aromatase system.

The hydroxylases of endoplasmic reticulum involved in steroid hormone synthesis are cytochrome P450 enzymes (Chapter 22). Molecular oxygen (O_2) is a substrate with one oxygen atom incorporated into the steroidal substrate (as an OH) and the second atom incorporated into a water molecule. Electrons

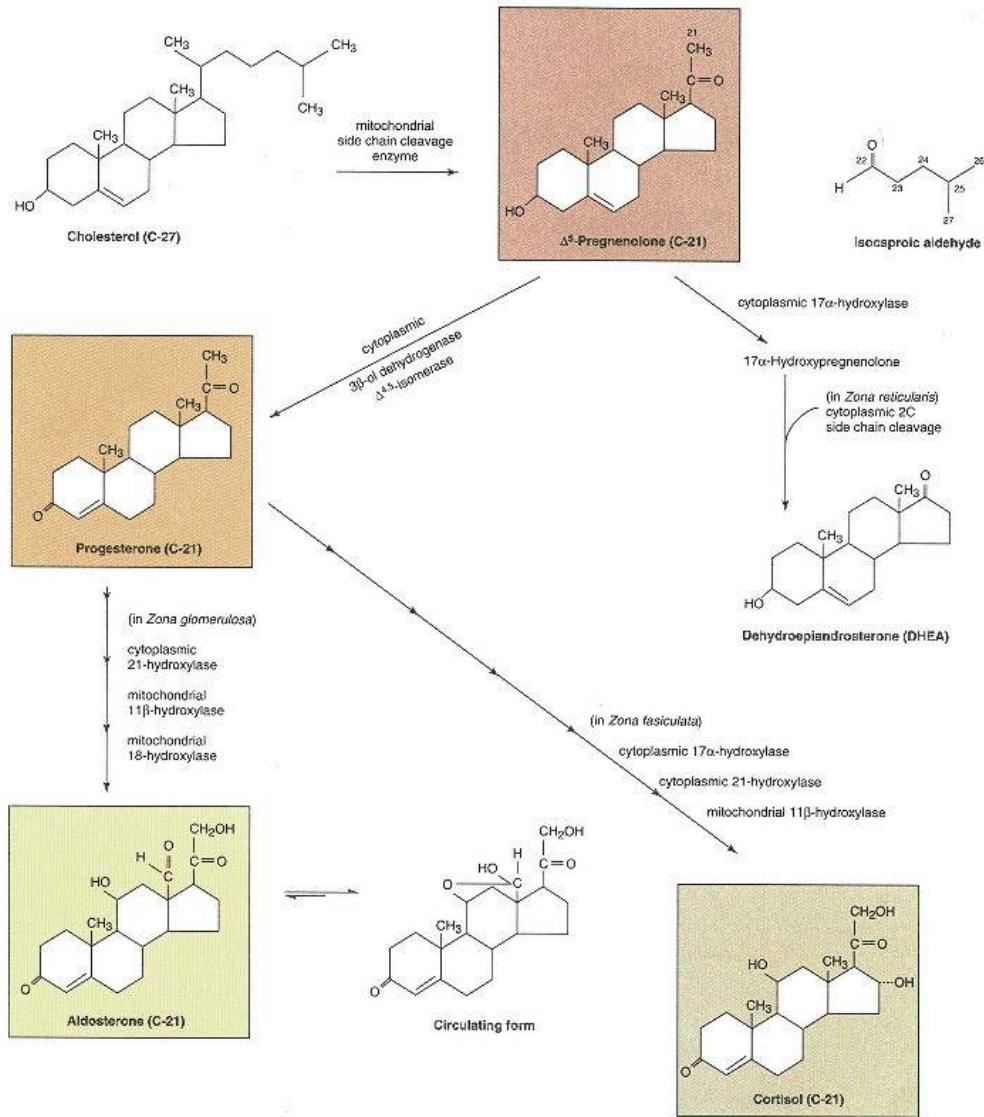

Figure 21.5
Conversion of cholesterol to adrenal cortical hormones.

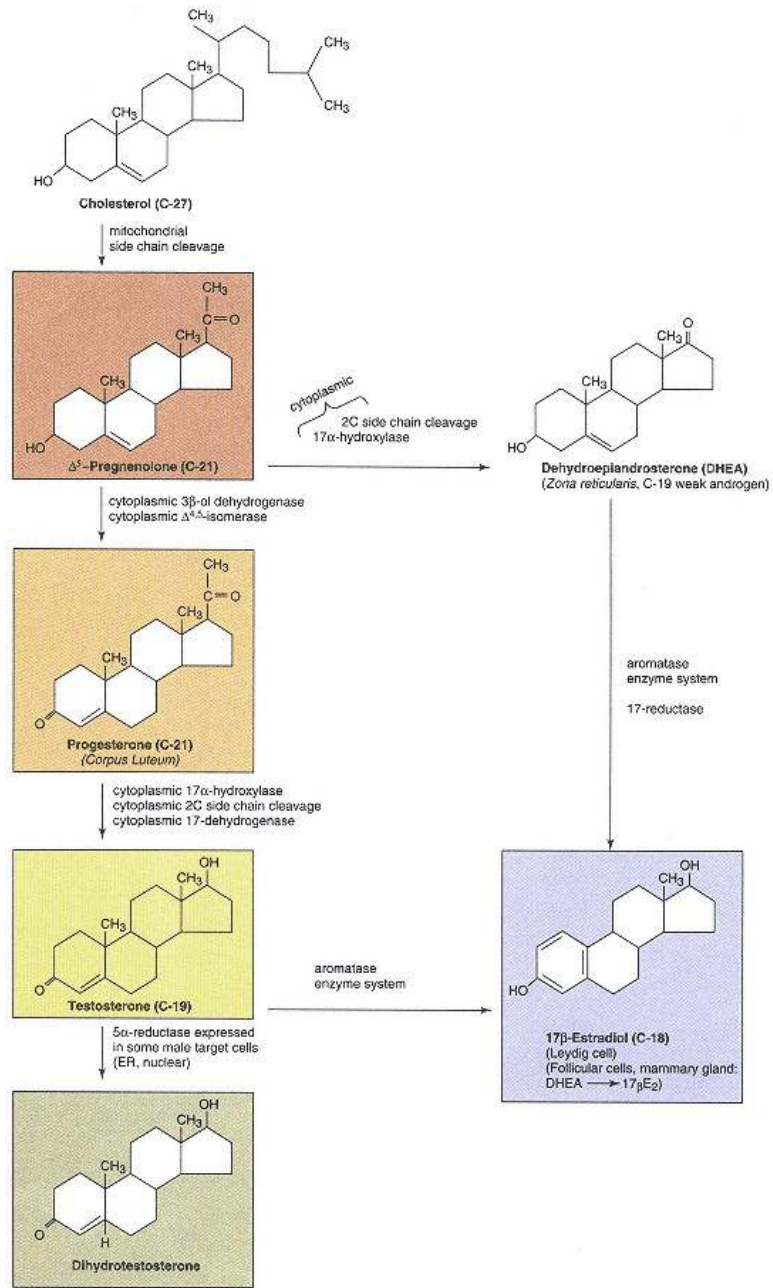

Figure 21.6
Conversion of cholesterol to sex hormones.
 Mt, mitochondrial, cyto, cytoplasmic; and ER, endoplasmic reticulum.

are generated from NADH or NADPH through a flavoprotein to ferredoxin or similar nonheme protein. Various agents can induce the levels of cytochrome P450.

Note that there is movement of intermediates in and out of the mitochondrial compartment during the steroid synthetic process.

21.4—

Metabolic Inactivation of Steroid Hormones

A feature of the steroid ring system is its great stability. For the most part, inactivation of steroid hormones involves reduction. Testosterone is initially reduced to a more active form by the enzyme 5α -reductase to form **dihydrotestosterone**, the preferred ligand for the androgen receptor. However, further reduction similar to the other steroid hormones results in inactivation. The inactivation reactions predominate in liver and generally render the steroids more water soluble, as marked by subsequent conjugation with glucuronides or sulfates (see Chapter 22) that are excreted in the urine. Table 21.2 summarizes reactions leading to inactivation and excretory forms of the steroid hormones.

21.5—

Cell–Cell Communication and Control of Synthesis and Release of Steroid Hormones

Secretion of steroid hormones from cells where they are synthesized is elicited by other hormones. Many, but not all, such systems are described in Chapter 20, Figures 20.2 and 20.3. The hormones that directly stimulate the biosynthesis and secretion of the steroid hormones are summarized in Table 21.3. The signals for stimulation of biosynthesis and secretion of steroid hormones are polypeptide hormones operating through cognate cell membrane receptors. In some systems where both cAMP and the phosphatidylinositol (PI) cycle are involved, it is not clear whether one second messenger predominates. In many such systems, for example, aldosterone synthesis and secretion, probably several components (i.e., acetylcholine muscarinic receptor, atriopeptin receptor, and their second messengers) are involved in addition to the signal listed in Table 21.3.

Steroid Hormone Synthesis Is Controlled by Specific Hormones

The general mechanism for hormonal stimulation of steroid hormone synthesis is presented in Figure 21.4. Figure 21.7 (p. 903) presents the system for stimulation of cortisol biosynthesis and release. The role of Ca^{2+} in steroid synthesis and/or secretion is unclear. Rate-limiting steps in the biosynthetic process involve the availability of cholesterol from cholesteryl esters in the droplet, the transport of cholesterol to the inner mitochondrial membrane (StAR protein), and the upregulation of the otherwise rate-limiting side chain cleavage reaction.

Aldosterone

Figure 21.8 (p. 904) shows the overall reactions leading to the secretion of aldosterone in the adrenal zona glomerulosa cell. This set of regulatory controls on aldosterone synthesis and secretion is complicated. The main driving force is **angiotensin II** generated from the signaling to the **renin–angiotensin system** shown in Figure 21.9 (p. 905). Essentially, the signal is generated under conditions when blood $[\text{Na}^+]$ and blood pressure (blood volume) are required to be increased. The N-terminal decapeptide of circulating **α_2 -globulin (angiotensinogen)** is cleaved by **renin**, a protease. This decapeptide is the hormonally inactive precursor, angiotensin I. It is converted to the octapeptide hormone, angiotensin II, by the action of converting enzyme. Angiotensin II is converted to the heptapeptide, angiotensin III, by an aminopeptidase. Both angiotensins

TABLE 21.2 Excretion Pathways for Steroid Hormones

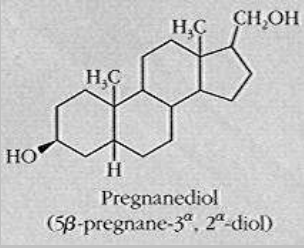
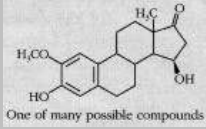
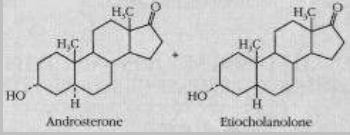
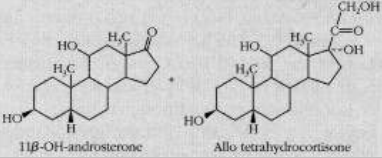
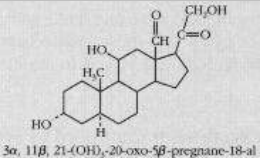
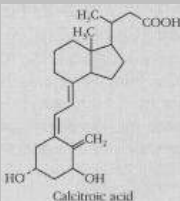
<i>Steroid Class</i>	<i>Starting Steroid</i>	<i>Inactivation Steps</i>	<i>A:B Ring Junction</i>	<i>Steroid Structure Representations of Excreted Product</i>	<i>Principal Conjugate Present^a</i>
Progestins	Progesterone	1. Reduction of C-20 2. Reduction of 4-ene-3-one	(cis)	 Pregnenediol (5β-pregnane-3 ^α , 20 ^α -diol)	G
Estrogens	Estradiol	1. Oxidation of 17β-OH 2. Hydroxylation at C-2 with subsequent methylation 3. Further hydroxylation or ketone formation at a variety of positions (e.g., C-6, C-7, C-14, C-15, C-16, C-18)		 One of many possible compounds	G
Androgens	Testosterone	1. Reduction of 4-ene-3-one 2. Oxidation of C-17 hydroxyl	(cis and trans)	 Androsterone Etiocholanolone	G, S
Glucocorticoids	Cortisol	1. Reduction of 4-ene-3-one 2. Reduction of 20-oxo group 3. Side chain cleavage	(trans)	 11β-OH-androsterone Allo tetrahydrocortisone	G
Mineralocorticoids	Aldosterone	1. Reduction of 4-ene-3-one	(trans)	 3 ^α , 11 ^β , 21-(OH) ₃ -20-oxo-5 ^β -pregnane-18-al	G
Vitamin D metabolites	1,25(OH) ₂ D ₃	1. Side chain cleavage between C-23 and C-24		 Calcitric acid	?

Source: From Norman, A. W., and Litwack, G. *Hormones*. Orlando, FL: Academic Press, 1987.

^a G, Glucuronide; S, sulfate.

II and III can bind to the angiotensin receptor (Figure 21.8), which activates the phosphatidylinositol cycle to generate IP₃ and DAG. IP₃ stimulates release of calcium ions from the intracellular calcium storage vesicles. In addition, the activity of the Ca²⁺ channel is stimulated by the angiotensin–receptor complex. K⁺ ions are also required to stimulate the Ca²⁺ channel and these events lead to a greatly increased level of cytoplasmic Ca²⁺. The enhanced cytoplasmic Ca²⁺

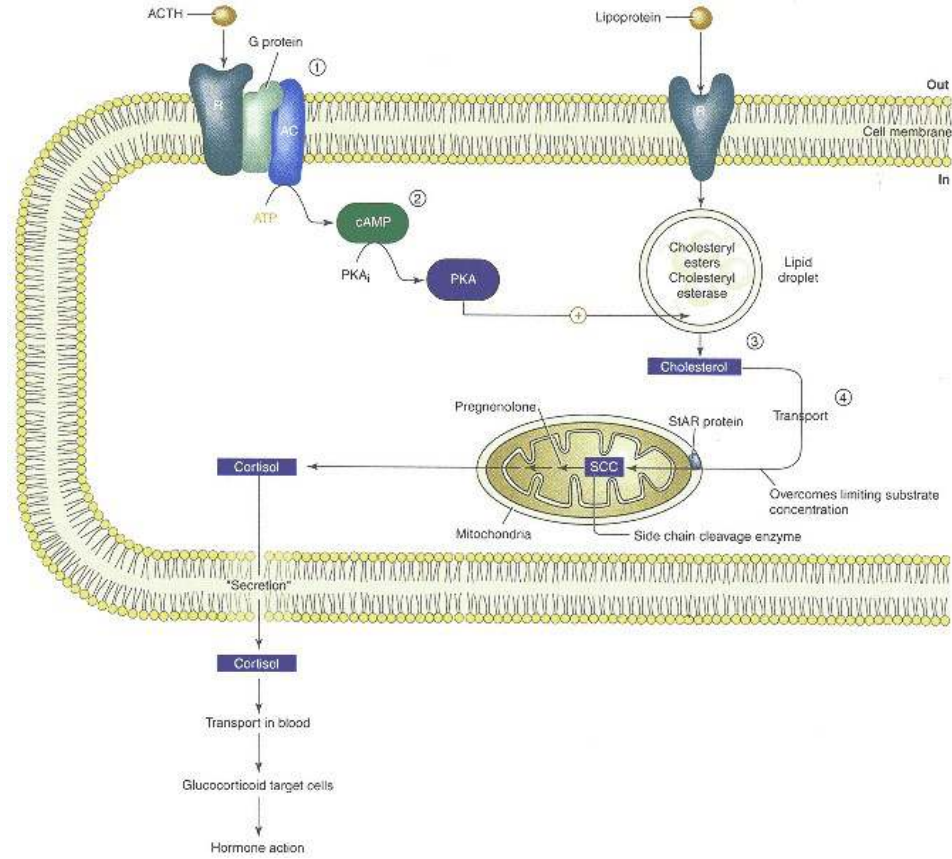

Figure 21.7
Action of ACTH on adrenal fasciculata cells to enhance production and secretion of cortisol.
 AC, adenylate cyclase; cAMP, cyclic AMP; PKA, protein kinase A; SCC, side chain cleavage system of enzymes. STAR (steroidogenic acute regulatory) protein is a cholesterol transporter functioning between the outer and inner mitochondrial membranes.

TABLE 21.3 Hormones that Directly Stimulate Synthesis and Release of Steroid Hormones

<i>Steroid Hormone</i>	<i>Steroid-Producing Cell or Structure</i>	<i>Signal^a</i>	<i>Second Messenger</i>	<i>Signal System</i>
Cortisol	Adrenal zona fasciculata	ACTH	cAMP, PI cycle, Ca ²⁺	Hypothalamic–pituitary cascade
Aldosterone	Adrenal zona glomerulosa	Angiotensin II/III	PI cycle, Ca ²⁺	Renin–angiotensin system
Testosterone	Leydig cell	LH	cAMP	Hypothalamic–pituitary cascade
17β-Estradiol	Ovarian follicle	FSH	cAMP	Hypothalamic–pituitary–ovarian cycle
Progesterone	Corpus luteum	LH	cAMP	Hypothalamic–pituitary–ovarian cycle
1,25 (OH) ₂ Vitamin D ₃	Kidney	PTH	cAMP	Sunlight, parathyroid glands, plasma Ca ²⁺ level

^a ACTH, adrenocorticotropic hormone; LH, luteinizing hormone; FSH, follicle-stimulating hormone; PI, phosphatidylinositol; PTH, parathyroid hormone.

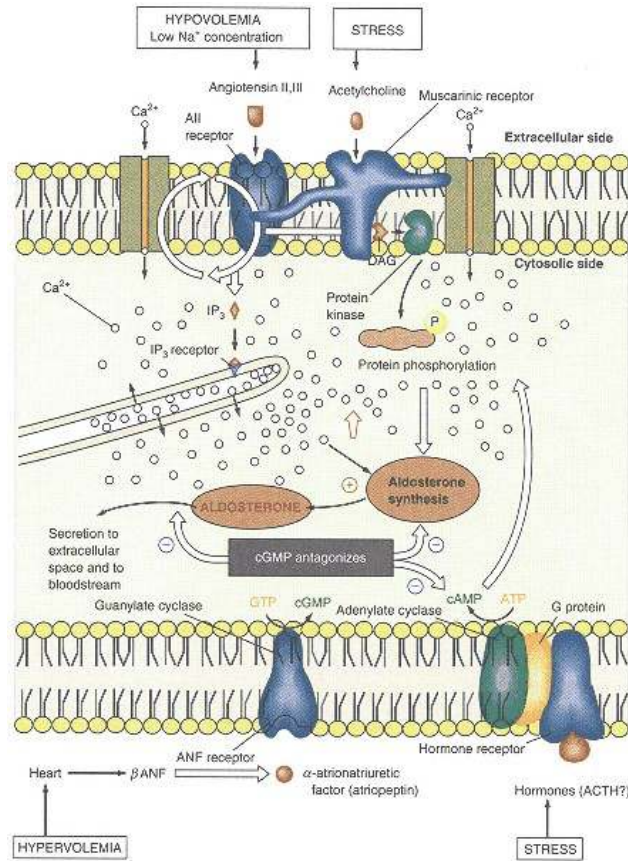

Figure 21.8
Reactions leading to the secretion of aldosterone in the adrenal *zona glomerulosa* cell.

cGMP, cyclic GMP; ANF, atrial natriuretic factor; see Figure 21.7 for additional abbreviations.

has a role in aldosterone secretion and together with diacylglycerol stimulates protein kinase C. **Acetylcholine** released through the neuronal stress signals has similar effects mediated by the muscarinic acetylcholine receptor to further reinforce Ca^{2+} uptake by the cell and stimulation of protein kinase C. Enhanced protein kinase C activity leads to protein phosphorylations that stimulate the rate-limiting steps of aldosterone synthesis leading to elevated levels of aldosterone, which are then secreted into the extracellular space and finally into the blood. Once in the blood aldosterone enters the distal kidney cell, binds to its receptor, which initially may be cytoplasmic, and ultimately stimulates expression of proteins that increase the transport of Na^+ from the glomerular filtrate to the blood (see p. 1043).

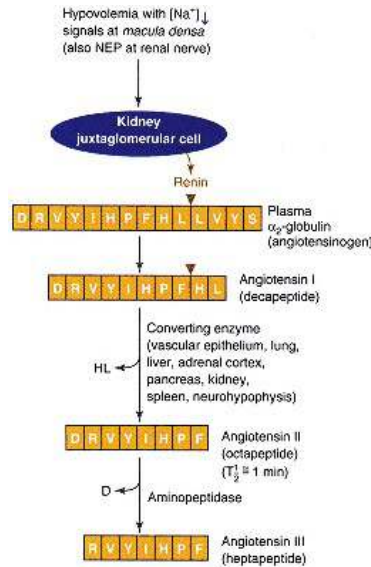

Figure 21.9

Renin-angiotensin system.

Amino acid abbreviations are found on p. 27.
NEP, norepinephrine.

Signals opposite to those that activate the formation of angiotensin generate **atrial natriuretic factor (ANF)** or atriopeptin from the heart atria (Figure 21.8; see also Figure 20.45). ANF binds to a specific *zona glomerulosa* cell membrane receptor and activates guanylate cyclase, which is part of the same receptor polypeptide so that the cytosolic level of cGMP increases. Cyclic GMP antagonizes the synthesis and secretion of aldosterone as well as the formation of cAMP by adenylate cyclase. Involvement of ACTH in aldosterone synthesis and release may involve adenylate cyclase but may be of secondary importance.

Aldosterone should be regarded as a stress hormone since its presence in elevated levels in blood occurs as a result of stressful situations. In contrast, cortisol, also released in stress has an additional biorhythmic release (possibly under control of serotonin and vasopressin), which accounts for a substantial reabsorption of Na^+ probably through glucocorticoid stimulation of the Na^+-H^+ antiport in luminal epithelial cells in addition to the many other activities of cortisol (e.g., anti-inflammatory action, control of T-cell growth factors, synthesis of glycogen, and effects on carbohydrate metabolism).

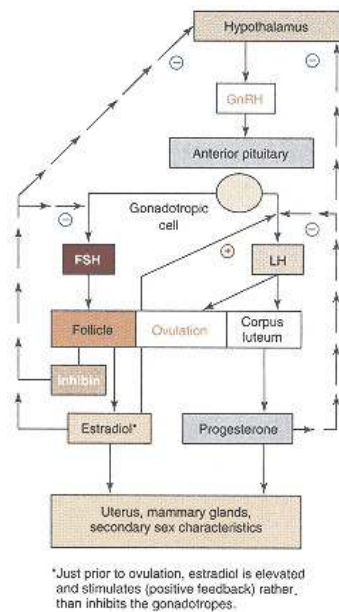

Figure 21.10

Formation and secretion of 17
 β -estradiol and progesterone.

Estradiol

Control of formation and secretion of **17 β -estradiol**, the female sex hormone, is shown in Figure 21.10. During development, control centers for the steady-state and cycling levels arise in the CNS. Their functions are required to initiate the ovarian cycle at puberty. These centers must harmonize with the firing of other neurons, such as those producing a clock-like mechanism via release of catecholamines or other amines to generate the pulsatile release of gonadotropin-releasing hormone (GnRH), probably at hourly intervals. Details of these reactions are presented on page 867, Chapter 20. The FSH circulates and binds to its cognate receptor on the cell membrane of the ovarian follicle cell and

through its second messengers, primarily cAMP and the activation of cAMP-dependent protein kinase, there is stimulation of the synthesis and secretion of the female sex hormone, 17β -estradiol. At normal stimulated levels of 17β -estradiol, there is a negative feedback on the **gonadotrope** (anterior pituitary), suppressing further secretion of FSH. Near ovarian midcycle, however, there is a superstimulated level of 17β -estradiol produced that has a positive rather than a negative feedback effect on the gonadotrope. This causes very high levels of LH to be released, referred to as the LH spike, and elevated levels of FSH. The level of FSH released is substantially lower than LH because the follicle produces **inhibin**, a polypeptide hormone that specifically inhibits FSH release without affecting LH release. The elevation of LH in the LH spike participates in the process of ovulation. After ovulation, the remnant of the follicle is differentiated into the functional *corpus luteum*, which now synthesizes progesterone (and also some estradiol), under the influence of elevated LH levels. Progesterone, however, is a feedback inhibitor of LH synthesis and release (operating through a progesterone receptor in the gonadotropic cell) and eventually the *corpus luteum* dies, owing to a fall in the level of available LH and the production of oxytocin, a luteolytic agent, by the *corpus luteum*. Prostaglandin $F_{2\alpha}$ may also be involved. With the death of the *corpus luteum*, the blood levels of progesterone and estradiol fall, causing menstruation as well as a decline in the negative feedback effects of these steroids on the anterior pituitary and hypothalamus, and the cycle begins again. Clinical Correlation 21.1 describes how oral contraceptives interrupt this sequence.

The situation is similar in males with respect to regulation of gonadotropin secretion, but LH acts principally on the Leydig cell for the stimulated production of testosterone, and FSH acts on the Sertoli cells to stimulate production of inhibin and sperm proteins. Production of testosterone is subject to the negative feedback effect of 17β -estradiol synthesized in the Sertoli cell. The 17β -estradiol so produced operates through a nuclear estrogen receptor in the Leydig cell to produce inhibition of testosterone synthesis at the transcriptional level. In all cases of steroid hormone production, the synthetic system resembles that shown in Figure 21.4.

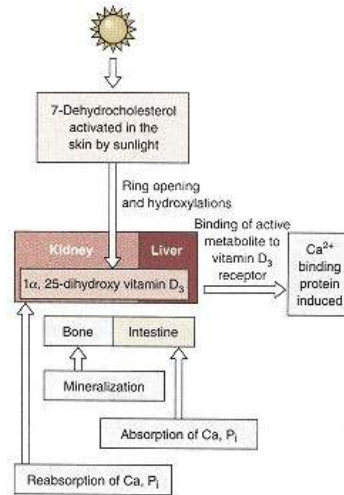

Figure 21.11
The vitamin D endocrine system.

P_i, inorganic phosphate.

Adapted from Norman, A. W. and Litwack, G.
Hormones. Orlando, FL: Academic
Press, 1987, f. 379.

CLINICAL CORRELATION 21.1

Oral Contraception

Oral contraceptives usually contain an estrogen and a progestin. Taken orally, the levels of these steroids increase in blood to a level where secretion of FSH and LH is repressed. Consequently, the gonadotropic hormone levels in blood fall and there is insufficient FSH to drive development of the ovarian follicle. As a result, the follicle does not mature and ovulation cannot occur. In addition, any *corpora lutea* cannot survive because of low LH levels. In sum, the ovarian cycle ceases. The uterine endometrium thickens and remains in this state, however, because of elevated levels of estrogen and progestin. Pills without the steroids (placebos) are usually inserted in the regimen at about the 28th day and, as a result, blood levels of steroids fall dramatically and menstruation occurs. When oral contraceptive steroids are resumed, the blood levels of estrogen and progestin increase again and the uterine endometrium thickens. This sequence creates a false "cycling" because of the occurrence of menstruation at the expected time in the cycle. The ovarian cycle and ovulation are suppressed by the oral contraceptive based on the negative feedback effects of estrogen and progestin on the secretion of the anterior pituitary gonadotropes. It is also possible to provide contraception by implanting in the skin silicone tubes containing progestins. The steroid is slowly released, providing contraception for up to 3–5 years.

Zatuchni, G. I. Female contraception. In: K. L. Becker (Ed.), *Principles and Practice of Endocrinology and Metabolism*. New York: Lippincott, 1990, p. 861; and Shoupe, D., and Mishell, D. R. Norplant: subdermal implant system for long term contraception. *Am. J. Obstet. Gynecol.* 160:1286, 1988.

Vitamin D₃

Activation of vitamin D to dihydroxy vitamin D₃ produces a hormone that has the general features of a steroid hormone. The active form of vitamin D stimulates intestinal absorption of dietary calcium and phosphorus, the mineralization of bone matrix, bone resorption, and reabsorption of calcium and phosphate in the renal tubule. The **vitamin D endocrine system** is diagrammed in Figure 21.11. 7-Dehydrocholesterol is activated in the skin by sunlight to form **vitamin D₃ (cholecalciferol)**. This form is hydroxylated first in the liver to **25-hydroxy vitamin D₃ (25-hydroxycholecalciferol)** and subsequently in the kidney to form the **1,25-vitamin D₃ (1,25(OH)₂D₃) (1,25-dihydroxycholecalciferol)**. The hormone can bind to nuclear 1,25(OH)₂D₃ receptors in intestine, bone, and kidney and then transcriptionally activate genes encoding calcium-binding proteins whose actions may lead to the absorption and reabsorption of Ca²⁺ (as well as phosphorus). The subcellular mode of action is presented in Figure 21.12. In this scheme the active form of vitamin D₃ enters the intestinal cell from the blood side and migrates to the nucleus. Once inside it binds to the high-affinity vitamin D₃ receptor, which probably undergoes an activation event, and associates with a vitamin D₃-responsive element to activate genes responsive to the hormone. Messenger RNA is produced and translated in the cytoplasm; these RNAs encode calcium-binding proteins, Ca²⁺-ATPase, other ATPases, membrane components, and facilitators of vesicle formation. Increased levels of calcium-binding proteins may cause increased uptake of Ca²⁺ from the intestine or may simply buffer the cytoplasm against high free Ca²⁺ levels.

With each of the steroid-producing systems discussed, feedback controls are operative whereby sufficient amounts of the circulating steroid hormone inhibit the further production and release of intermediate hormones in the pathway at the levels of the pituitary and hypothalamus, as viewed in Figure 20.3. In the case of the vitamin D systems, the controls are different since the steroid production is not stimulated by the cascade process applicable to estro-

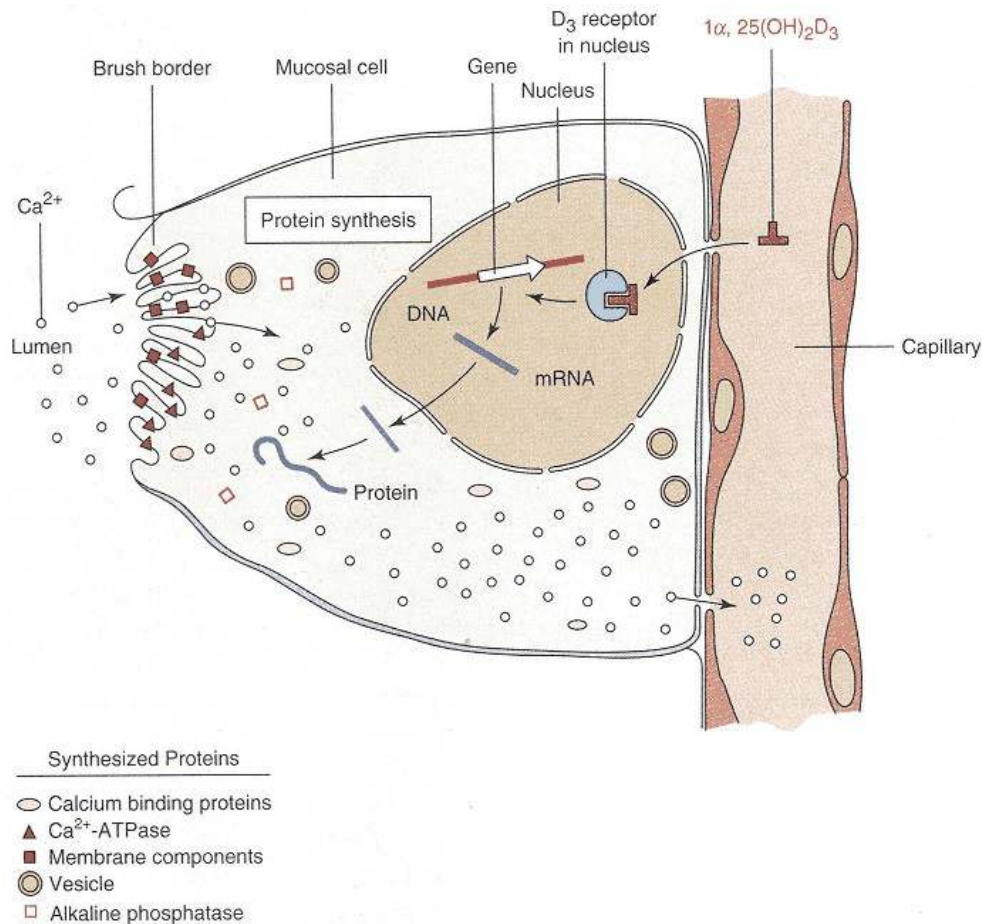

Figure 21.12
Schematic model to describe the action of 1,25(OH)₂D₃ in the intestine in stimulating intestinal calcium transport.

Redrawn from Nemere, I., and Norman, A. W. *Biochim. Biophys. Acta* 694:307, 1982.

diol. When the circulating levels of the active form of vitamin D (1, 25(OH)₂D₃) are high, hydroxylations at the 24 and 25 positions are favored and the inactive 24,25 (OH)₂-vitamin D₃ compound is generated.

21.6—

Transport of Steroid Hormones in Blood

Steroid Hormones Are Bound to Specific Proteins or Albumin in Blood

There are four major proteins in the circulation that account for much of the steroid hormones bound in the blood. They assist in maintaining a level of these hormones in the circulation and protect the hormone from metabolism and inactivation. The binding proteins of importance are corticosteroid-binding globulin protein, sex hormone-binding protein, androgen-binding protein, and albumin.

Corticosteroid-binding globulin (CBG) or transcortin is about 52 kDa, is 3–4 mg% in human plasma, and binds about 80% of the total 17-hydroxysteroids in the blood. In the case of cortisol, which is the principal antistress corticosteroid in humans, about 75% is bound by CBG, 22% is bound in a loose manner to albumin, and 8% is in free form. The unbound cortisol is the form that can permeate cells and bind to intracellular receptors to produce biological effects. The CBG has a high affinity for cortisol with a binding constant (K_d) of $2.4 \times 10^7 \text{ M}^{-1}$. Critical structural determinants for steroid binding to CBG are the ⁴-3-ketone and 20-ketone structures. Aldosterone binds weakly to CBG but is also bound by albumin and other plasma proteins. Normally, 60% of aldosterone is bound to albumin and 10% is bound to CBG. In human serum, albumin is 1000-fold the concentration of CBG and binds cortisol with an affinity of 10^3 M^{-1} , much lower than the affinity of CBG for cortisol. Thus cortisol will always fill CBG-binding sites first. During stress, when secretion of cortisol is very high, CBG sites will be filled but there will be sufficient albumin to accommodate excess cortisol.

Sex hormone binding globulin (SHBG) (40 kDa) binds androgens with an affinity constant of about 10^9 M^{-1} , which is much tighter than albumin binding of androgens. One to three percent of testosterone is unbound in the circulation and 10% is bound to SHBG, with the remainder bound to albumin. The level of SHBG is probably important in controlling the balance between circulating androgens and estrogens along with the actual amounts of these hormones produced in given situations. About 97–99% of bound testosterone is bound reversibly to SHBG but much less estrogen is bound to this protein in the female. As mentioned above, only the unbound steroid hormone can permeate cells and bind to intracellular receptors, thus expressing its activity. The level of SHBG before puberty is about the same in males and females, but, at puberty, when the functioning of the sex hormones becomes important, there is a small decrease in the level of circulating SHBG in females and a larger decrease in males, ensuring a relatively greater amount of the unbound, biologically active sex hormones—testosterone and 17 β -estradiol. In adults, males have about one-half as much circulating SHBG as females, so that the unbound testosterone in males is about 20 times greater than in females. In addition, the total (bound plus unbound) concentration of testosterone is about 40 times greater in males. Testosterone itself lowers SHBG levels in blood, whereas 17 β -estradiol raises SHBG levels in blood. These effects have important ramifications in pregnancy and in other conditions.

Androgen binding protein (ABP) is produced by Sertoli cells in response to testosterone and FSH, both of which stimulate protein synthesis in these cells. Androgen-binding protein is doubtless not of great importance in the entire blood circulation but is important because it maintains a ready supply of testosterone for the production of protein constituents of spermatozoa. Its

role may be to maintain a high local concentration of testosterone in the vicinity of the developing germ cells within the tubules.

From a variety of studies it is clear that these, as well as other transport proteins, protect the circulating pool of steroid hormones. They supply free steroids that can enter cellular targets after dissociation from the bound forms as more free hormone is utilized, thus serving the needs of target cells by a mass action effect.

21.7—

Steroid Hormone Receptors

Steroid Hormones Bind to Specific Intracellular Protein Receptors

The general model for steroid hormone action presented in Figure 21.13 takes into account the differences among steroid receptors in terms of their location within the cell. In contrast to polypeptide hormone receptors that are generally located on/in the cell surface, steroid hormone receptors, as well as other related receptors for nonsteroids (i.e. thyroid hormone, retinoic acid, vitamin D₃), are located in the cell interior. Among the steroid receptors there appear to be some differences as to the subcellular location of the **non-DNA-binding forms** of these **receptors**. The glucocorticoid receptor and possibly the aldosterone receptor appear to reside in the cytoplasm, whereas the other receptors, for which suitable data have been collected, may be located within the nucleus, presumably in association with DNA, although not necessarily at productive acceptor sites on the DNA. Figure 21.13, Step 1, shows a bound and a free form of a steroid hormone(s). The free form may enter the cell by a process of diffusion. In the case of glucocorticoids, like cortisol, the steroid would bind

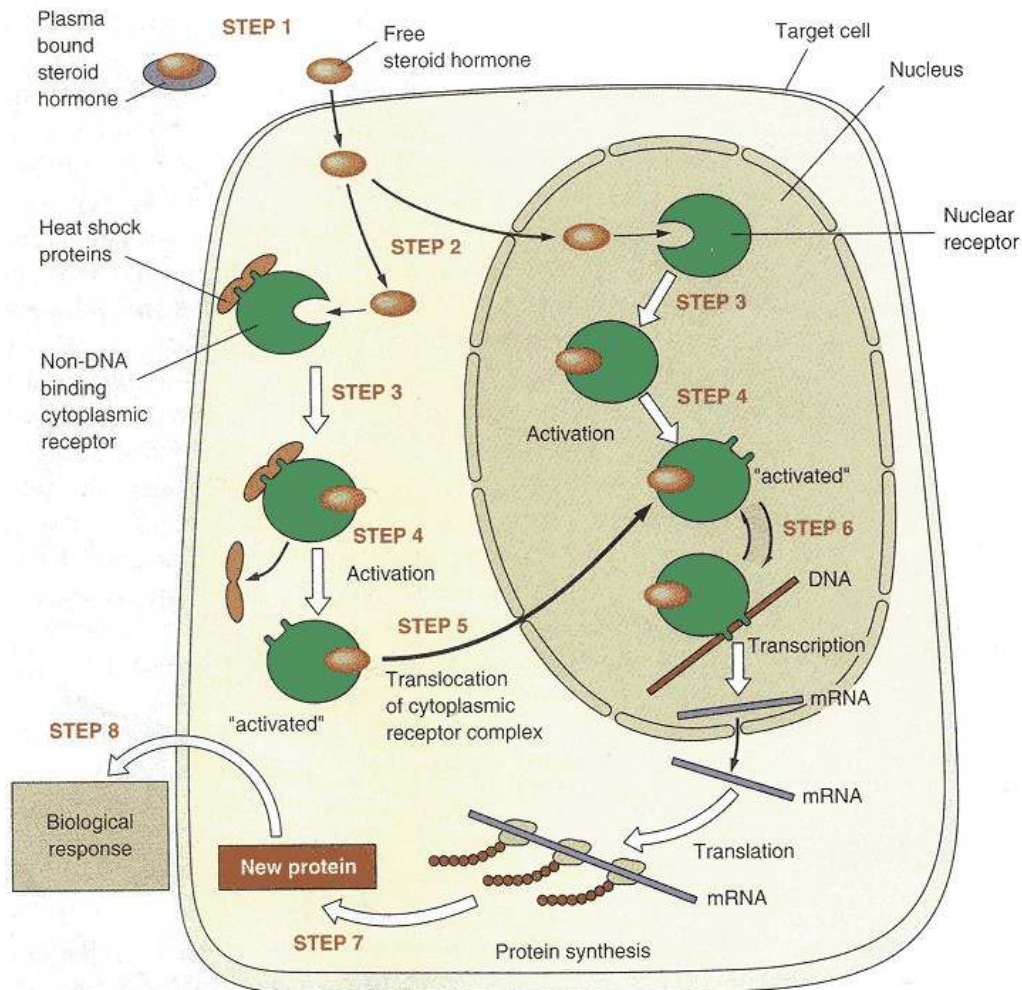

Figure 21.13

Model of steroid hormone action.

- Step 1—Dissociation of free hormone (biologically active) from circulating transport protein;
- Step 2—diffusion of free ligand into cytosol or nucleus;
- Step 3—binding of ligand to unactivated cytoplasmic or nuclear receptor;
- Step 4—activation of cytosolic or nuclear hormone–receptor complex to activated, DNA-binding form;
- Step 5—translocation of activated cytosolic hormone–receptor complex into nucleus;
- Step 6—binding of activated hormone–receptor complexes to specific response elements within the DNA;
- Step 7—synthesis of new proteins encoded by hormone-responsive genes; and
- Step 8—alteration in phenotype or metabolic activity of target cell mediated by specifically induced proteins.

to an unactivated receptor with an open ligand binding site (Step 3). The binding constant for this reaction is on the order of 10^9 M^{-1} , compared to about 10^7 M^{-1} for the binding to CBG (see above). The non-DNA-binding form also referred to as the unactivated or nontransformed receptor is about 300 kDa, because other proteins may be associated in the complex. Many investigators believe that a dimer of the 90-kDa protein, which is a heat shock protein that is induced when cells are stressed (**heat shock proteins**), is associated with the receptor in this form and occludes its DNA-binding domain, accounting for its non-DNA-binding activity. Associated with this dimer of hsp90 is another heat shock protein designated as hsp56, which interestingly also functions as an immunophilin and, as such, can bind to a number of potent immunosuppressive drugs. The dimer of the 90-kDa heat shock protein is depicted by the pair of red ovals attached to the cytoplasmic receptor that block the DNA-binding domain pictured as a pair of "fingers" in the subsequently activated form. Activation or transformation to the **DNA-binding form** is accomplished by release of the 90-kDa heat shock proteins (Step 4). It is not clear what actually drives the activation step(s). Clearly, the binding of the steroidal ligand is important but other factors may be involved. A low molecular weight component has been proposed to be part of the cross-linking between the nonhomologous proteins and the receptor in the DNA-binding complex. In the case of glucocorticoid receptor, only the non-DNA-binding form has a high affinity for binding steroidal ligand. Following activation and exposure of the DNA-binding domain, the receptor translocates to the nucleus (Step 5), binds to DNA, and "searches" the DNA for a high-affinity acceptor site. At this site the bound receptor complex, frequently a homodimer, acts as a transactivation factor, which together with other transactivators allows for the starting of RNA polymerase and stimulation of transcription. In some cases the binding of the receptor may lead to repression of transcription and this effect is less well understood. New mRNAs are translocated to the cytoplasm and assembled into translation complexes for the synthesis of proteins (Step 7) that alter metabolism and functioning of the target cell (Step 8).

When the unoccupied (nonliganded) steroid hormone receptor is located in the nucleus, as may be the case with the estradiol, progesterone, androgen, and vitamin D₃ receptors (see Figure 21.12), the steroid must travel through the cytoplasm and cross the perinuclear membrane. It is not clear whether this transport through the cytoplasm (aqueous environment) requires a transport protein for the hydrophobic steroid molecules. Once inside the nucleus the steroid can bind to the high-affinity, unoccupied receptor, presumably already on DNA, and cause it to be "activated" to a form bound to the acceptor site. The ligand might promote a conformation that decreases the off-rate of the receptor from its acceptor, if it is located on or near its acceptor site, or might cause the receptor to initiate searching if the unoccupied receptor associates with DNA at a locus remote from the acceptor site. Consequently, the mechanism underlying activation of nuclear receptors is less well understood as compared to activation of cytoplasmic receptors. After binding of activated receptor complexes to DNA acceptor sites, enhancement or repression of transcription occurs.

Consensus DNA sequences defining specific **hormone response elements (HREs)** for the binding of various activated steroid hormone–receptor complexes are summarized in Table 21.4. Receptors for glucocorticoids, mineralocorticoids, progesterone, and androgen all bind to the same HRE on the DNA. Thus, in a given cell type, the extent and type of receptor expressed will determine the hormone sensitivity. For example, sex hormone receptors are expressed in only a few cell types and the progesterone receptor is likewise restricted to certain cells, whereas the glucocorticoid receptor is expressed in a large number of cell types. In cases where aldosterone and cortisol receptors are coexpressed, only one form may predominate depending on the cell type. Some tissues, such as the kidney and colon, are known targets for aldosterone

CLINICAL CORRELATION 21.2**Apparent Mineralocorticoid Excess Syndrome**

Some patients (usually children) exhibit symptoms, including hypertension, hypokalemia, and suppression of the renin-angiotensin-aldosterone system, that would be expected if they were hypersecreting aldosterone. Since bioassays of plasma and urine sometimes fail to identify any excess of mineralocorticoids, these patients are said to suffer from the apparent mineralocorticoid excess (AME) syndrome. This syndrome results as a consequence of the failure of cortisol inactivation by the 11 β -hydroxy-steroid dehydrogenase enzyme. Inactivity of this key enzyme gives cortisol direct access to the renal mineralocorticoid receptor. Since cortisol circulates at much higher concentrations than aldosterone, this glucocorticoid saturates these mineralocorticoid receptors and functions as an agonist, causing sodium retention and suppression of the renin-angiotensin-aldosterone axis. Although this AME syndrome can result from a congenital defect in the distal nephron 11 β -hydroxysteroid dehydrogenase isoform, which renders the enzyme incapable of converting cortisol to cortisone (binds poorly to mineralocorticoid receptors), it can also be acquired by ingesting excessive amounts of licorice. The major component of licorice is glycyrrhizic acid and its hydrolytic product, glycyrrhetic acid (GE). This active ingredient (GE) acts as a potent inhibitor of 11 β -hydroxysteroid dehydrogenase. By blocking activity of this inactivating enzyme, GE facilitates the binding of cortisol to renal mineralocorticoid receptors and hence induces AME syndrome.

Edwards, C. R. W. Primary mineralocorticoid excess syndromes. In: L. J. DeGroot (Ed.), *Endocrinology*. Philadelphia: Saunders, pp. 1775–1803, 1995; and Shackleton, C. H. L., and Stewart, P. M. The hypertension of apparent mineralocorticoid excess syndrome. In: E. G. Biglieri and J. C. Melby (Eds.), *Endocrine Hypertension*. New York: Raven Press, 1990, pp. 155–173.

TABLE 21.4 Steroid Hormone Receptor Responsive DNA Elements: Consensus Acceptor Site

<i>Element</i>	<i>DNA Sequence^a</i>
POSITIVE	
Glucocorticoid responsive element (GRE)	5-GGTACAnnnTGTCT-3
Mineralocorticoid responsive element (MRE)	
Progesterone responsive element (PRE)	
Androgen responsive element (ARE)	
Estrogen responsive element (ERE)	5- <u>AGGTC</u> Annn <u>TCACT</u> -3
NEGATIVE	
Glucocorticoid responsive element	5- <u>ATYAC</u> Nnnn <u>TGATCW</u> -3

Source: Data are summarized from work of Beato, M. *Cell* 56:355, 1989.

^a n, any nucleotide; Y, a purine; W, a pyrimidine.

and express relatively high levels of mineralocorticoid receptors as well as glucocorticoid receptors. These mineralocorticoid target tissues express the enzyme **11 β -hydroxysteroid dehydrogenase** (see Clin. Corr. 21.2). This enzyme converts cortisol and corticosterone, both of which can bind to the mineralocorticoid receptor with high affinity, to their 11-keto analogs, which bind poorly to the mineralocorticoid receptor. This inactivation of corticosterone and cortisol, which circulate at much higher concentrations than aldosterone, facilitates the binding of aldosterone to the mineralocorticoid receptors in these classical target tissues. In tissues that express mineralocorticoid receptors but are not considered target tissues, this enzyme may not be expressed, and in these situations the mineralocorticoid receptors may simply function as pseudo-glucocorticoid receptors and mediate the effects of low circulating levels of cortisol (predominant glucocorticoid in humans). Thus the mineralocorticoid and glucocorticoid receptors may regulate the expression of an overlapping gene network in various target tissues. As also indicated in Table 21.4, the activated estrogen-receptor complex recognizes a distinct or unique response element. All of the response elements listed at the top of Table 21.4 function as positive elements, since binding of the indicated steroid receptors results in an increase in the rate of transcription of the associated gene.

Glucocorticoid hormones also repress transcription of specific genes. For example, glucocorticoids are known to repress transcription of the **proopio-melanocortin gene** (POMC) (see p. 849), which contains the ACTH sequences. Glucocorticoid-mediated repression of POMC gene expression thus plays a key role in the negative feedback loop regulating the rate of secretion of ACTH and ultimately cortisol. Negative glucocorticoid response elements (nGREs) mediate this repression of the POMC gene as well as other important genes. A general model of positive as well as negative transcriptional effects mediated by steroid receptors is shown in Figure 21.14: In (a) binding of a steroid receptor (R) homodimer to its response element allows it to interact synergistically with a positive transcription factor (TF) and hence induce gene transcription; in (b) binding of a receptor dimer to its response element displaces a positive transcription factor (TF) but has no or weak transactivation potential because no synergizing factor is nearby; and in (c) the DNA-AP1 (positive factor) may interact in a protein-protein fashion in such a way that the transactivating functions of both proteins are inhibited and gene transcription is repressed.

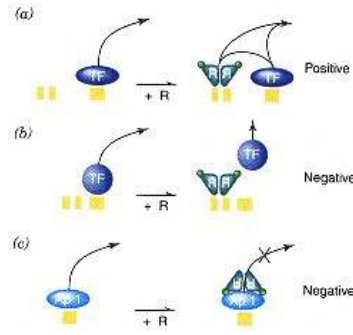

Figure 21.14
Positive and negative transcriptional effects
of steroid receptors.

Redrawn from Renkowitz, R. *Ann. N.Y.
Acad. Sci.* 684:1, 1993.

Some members of this receptor supergene family can mediate gene silencing. Silencer elements, in analogy to enhancer elements, function independently of their position and orientation. The silencer for a particular gene consists of modules that independently repress gene activity. In the absence of their specific ligands, the **thyroid hormone receptor** (T_3R) and **retinoic acid receptor** (RAR) appear to bind to specific silencer elements and repress gene transcription. This silencing activity may occur via destabilization of the transcription initiation complex or via direct or indirect effects on the carboxy-terminal domain of RNA polymerase II. After binding of their respective ligands, these two receptors lose this silencing activity and are converted into transactivators of gene transcription.

As indicated in Figure 21.14, **dimerization** of receptor monomers is a prerequisite for efficient DNA binding and transcriptional activation by most steroid receptors. Strong interactions between these monomers are mediated by the ligand-binding domains of several steroid receptors. The dimerization domain of the ligand-binding domain has been proposed to form a helical structure containing a succession of hydrophobic sequences that would generate a leucine zipper-like structure or a helix–turn–zipper motif (see p. 110), which are known to be necessary for the dimerization of other transcription factors. Although the majority of receptors in this superfamily form homodimers, heterodimers have also been detected. More specifically, a distinct class of retinoic acid receptors, classified as retinoid X receptors (RXRs), regulate gene expression via heterodimerization with the other distinct form of the retinoic acid receptor (RAR), the thyroid hormone receptor, and other members of this receptor superfamily. A model for the stabilization of the transcriptional preinitiation complex by an RXR/RAR heterodimer is presented in Figure 21.15.

Thus the changes produced in different cells by the activation of steroid hormone receptors may be different in different cells that contain the relevant receptor in suitable concentration. The whole process is triggered by the entry of the steroidal ligand in amounts that supersede the dissociation constant of the receptor. The different phenotypic changes in different cell types in response to a specific hormone then summate to give the systemic or organismic response to the hormone.

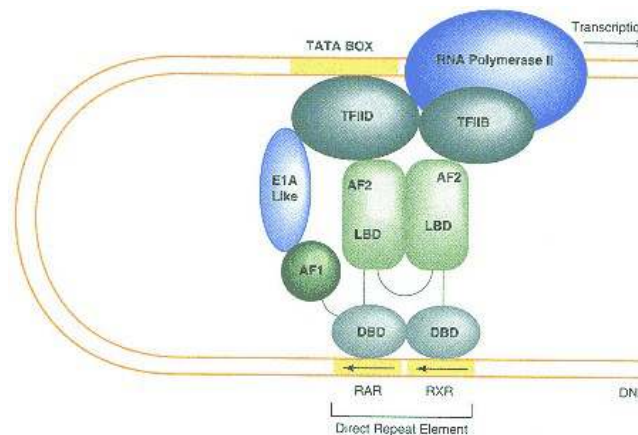

Figure 21.15
Model for stabilization of preinitiation complex by an RXR/RAR heterodimer.

TF, transcription factor; LBD, ligand-binding domain; DBD, DNA-binding domain; AF1, activation function located in amino-terminal region of receptor, which may provide contact with cell-specific proteins; AF2, activation function located within ligand-binding domain, which interacts directly with transcriptional machinery.

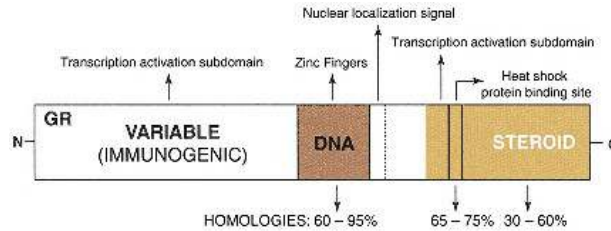

Figure 21.16

Model of a typical steroid hormone receptor.

The results are derived from studies on cDNA in various laboratories, especially those of R. Evans and K. Yamamoto.

Some Steroid Receptors Are Part of the *cErbA* Family of Proto-oncogenes

The glucocorticoid receptor is conveniently divided into three major **functional domains** (Figure 21.16). Starting at the C terminus, the steroid-binding domain is indicated and has 30–60% homology with the **ligand-binding domains** of other receptors in the steroid receptor family. The more alike two steroids that bind different receptors are, the greater the extent of homology to be anticipated in this domain. The steroid-binding domain contains a sequence that may be involved in the binding of molybdate and a dimer of the 90-kDa heat shock protein whose function would theoretically result in the assembly of the high molecular weight unactivated–nontransformed steroid–receptor complex. To the left of that domain is a region that modifies transcription. In the center of the molecule is the **DNA-binding domain**. Among the steroid receptors there is 60–95% homology in this domain. Two zinc fingers (see p. 108) interact with DNA. The structure of the zinc finger DNA-binding motif is shown in Figure 21.17. The N-terminal domain contains the principal **antigenic domains** and a site that modulates transcriptional activation. The amino acid sequences in this site are highly variable among the steroid receptors. These features are common to all steroid receptors. The family of steroid receptors is diagrammed in Figure 21.17. The ancestor to which these receptor genes are related is *v-erba* or *c-erba* (see p. 889). *v-Erba* is an oncogene that binds to DNA but has no ligand-binding domain. In some cases the DNA-binding domains are homologous enough that more than one receptor will bind to a common responsive element (consensus sequence on DNA) as shown in Table 21.4. In addition to those genes pictured in Figure 21.18, the **aryl hydrocarbon receptor (Ah)** may also be a member of this family. The Ah receptor binds carcinogens with increasing affinity paralleling increasing carcinogenic potency and translocates the carcinogen to the cellular nucleus unless the receptor is already located in the nucleus. The N-terminal portions of the receptors usually contain major antigenic sites and may also contain a site that is active in modulating binding of the receptor to DNA.

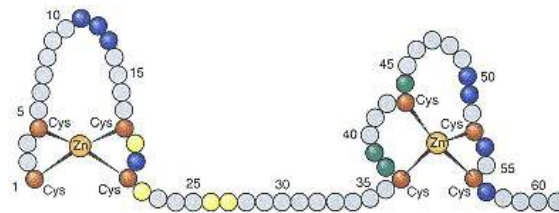

Figure 21.17

Structure of the zinc finger located within the glucocorticoid receptor DNA-binding domain as determined by X-ray crystallography. Yellow circles indicate amino acid residues (located in GR monomer) that interact with base pairs. Blue circles are those making phosphate backbone contacts. Green circles are those participating in dimerization. Redrawn from Luisi, B. F., Schwabe, J. W. R., and Freedman, L. P. In: G. Litwack (Ed.), *Vitamins and Hormones*, Vol. 49. San Diego, Academic Press, 1994, pp. 1–47.

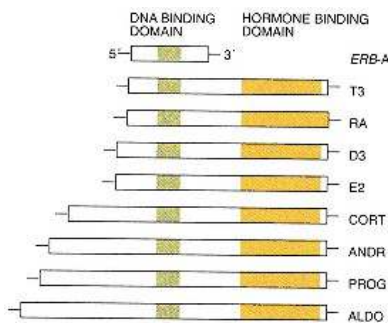

Figure 21.18

Steroid receptor gene superfamily.

T3, triiodothyronine; RA, retinoic acid; D3, dihydroxy vitamin D₃; E2, estradiol; CORT, cortisol; ANDR, androgen; PROG, progesterone; ALDO, aldosterone. Figure shows roughly the relative sizes of the genes for these receptors. Information derived from the laboratories of R. Evans, K. Yamamoto, P. Chambon, and others. In some cases there is high homology in DNA-binding domains and lower homology in ligand-binding domains.

Thyroid hormone and retinoic acid receptors are also members of the same superfamily of receptors although their ligands are not steroids. They do contain six-membered rings as shown in Figure 21.19. For some steroid receptors the A ring is the prominent site of recognition by the receptor, presenting the likelihood that the A ring inserts into the binding pocket of the receptor. In some cases, derivatives of the structures with a six-membered ring bind to the estradiol and glucocorticoid receptors. Thus the ring structures of thyroid hormone and retinoic acid have structural similarities not unlike many of the steroidal ligands involved in binding.

The receptors in this large gene family may act as transcriptional activators that together with other transcriptional regulators bring about gene activation.

21.8—

Receptor Activation:

Upregulation and Downregulation

Little is known about activation of steroid receptors. Activation converts a non-DNA-binding form (unactivated–nontransformed) of the receptor to a form (activated–transformed) that is able to bind nonspecific DNA or specific DNA (hormone-responsive element). The likelihood that certain receptors are cytoplasmic (glucocorticoid receptor and possibly the mineralocorticoid receptor) while others seem to be nuclear (progesterone, estradiol, vitamin D₃, and androgen receptors) may have a bearing on the significance of the activation phenomena. Most information is available for cytoplasmic receptors. The current view is that the non-DNA-binding form is a heteromeric trimer consisting of one molecule of receptor and a dimer of 90-kDa heat shock protein, as shown in Figure 21.20. The DNA-binding site of the receptor is blocked by the heteromeric proteins or by some other factor or by a combination of both. Upon activation–transformation a stepwise disaggregation of this complex could occur, leading to the activated receptor having its DNA-binding site fully exposed. The reaction may be initiated by the binding of steroid to the ligand-binding site that produces a conformational change in the receptor protein.

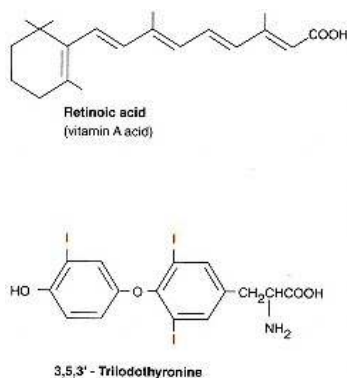

Figure 21.19

Structures of retinoic acid (vitamin A acid) and 3,5,3'-triiodothyronine.

Although the conditions required to induce activation *in vitro* are well known, the primary signal within the cell is not. Many believe that the binding of ligand alone is not sufficient to cause the activation process. Clearly, elevated temperature is a requirement for this conformational change, since incubation of target cells with appropriate steroids at low temperatures fails to result in *in vivo* activation and subsequent translocation. Once the liberated receptor is free in the cytoplasm it crosses the perinuclear membrane, perhaps through a nucleopore, to enter the nucleus. It binds nonspecifically and specifically to

chromatin, probably as a dimer, presumably in search of the specific response element (Table 21.4). Thus these receptors are transacting factors and may act in concert with other transacting factors to provide the appropriate structure to initiate transcription. Most steroid receptors have in their DNA-binding domains an SV40-like sequence (i.e., Pro-Lys-Lys-Lys-Arg-Lys-Val) known to code for nuclear translocation. Steroid receptors have variants of this sequence; some degeneracy is permitted but probably a specific lysine residue cannot be altered. This signal may provide recognition for the nucleopore.

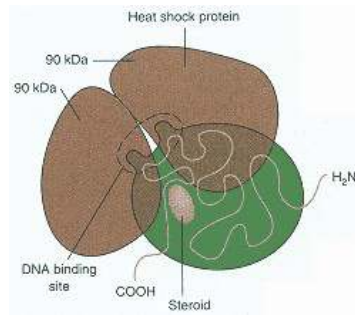

Figure 21.20
Hypothetical minimal model of a non-DNA-binding form of a steroid receptor.
 This form of the receptor cannot bind to DNA because the DNA-binding site is blocked by the 90-kDa hsp proteins or by some other constituent. Mass of this complex is approximately 300 kDa.

Steroid Receptors Can Be Upregulated or Downregulated Depending on Exposure to the Hormone

In general, many membrane or intracellular receptors are downregulated when the cell has been exposed to a certain amount of the hormonal ligand. In some cases, the downregulation is called "desensitization." **Downregulation** can take many forms. For membrane receptors the mechanism may be internalization by endocytosis of the receptors after exposure to hormone (see p.876). Internalization reduces the number of receptors on the cell surface and renders the cell less responsive to hormone; that is, desensitizes the cell. In the case of intracellular steroid receptors, downregulation generally takes the form of reducing the level of receptor mRNA, which decreases the concentration of receptor molecules. The receptor gene may have a specific responsive element on its promoter whose action results in an inhibition of transcription of receptor mRNA or the receptor may stimulate transcription of a gene that codes for a protein that degrades the mRNA of the receptor. Sequences are now being recognized on receptor gene promoters that may bind activated steroid–receptor complexes and result in inhibition of transcription (Table 21.4). Downregulation of receptors by their own ligands plays an important physiological role because it prevents overstimulation of target cells when circulating hormone levels are elevated.

Although downregulation of steroid receptor levels by their cognate hormones appears to be the most frequently detected form of autoregulation, it is not common to all target cells. In fact, glucocorticoid-mediated upregulation has been reported in a number of responsive cells. Since all of these cells are growth inhibited by these hormones, it was initially suggested that hormone-mediated upregulation may be required for subsequent growth inhibition. However, the fact that glucocorticoid-mediated upregulation also occurs in human lymphoid cells, which express glucocorticoid receptors but are not growth inhibited by these steroids, demonstrates that this positive **autoregulation** is neither the result nor cause of hormone-mediated growth arrest.

21.9— **Specific Example of Steroid Hormone Action at Cell Level:** **Programmed Death**

Programmed cell death or **apoptosis** is a suicide process by which cells die according to a program that may be beneficial for the organism. It can result from the rise or fall in the level of a specific hormone(s). Uterine endometrial cells at the beginning of menstruation are an example where programmed cell death is initiated by the fall in levels of progesterone and estradiol in the blood (see Clin. Corr. 21.3). Another case is **apoptosis** of thymus cells during development when the adrenal cortex becomes functional and begins to synthesize and secrete relatively large amounts of cortisol. A newborn has a large thymus but when cortisol is synthesized and released the thymus cortical cells begin to die until a resistant core of cells is reached and the gland achieves its adult size. Thus programmed cell death is a mechanism used in development for the maturation of certain organs as well as in cyclic systems where cells

CLINICAL CORRELATION 21.3**Programmed Cell Death in the Ovarian Cycle**

During the ovarian cycle, the ovarian follicle expels the mature ovum at day 14 and the remaining cells of the follicle are differentiated into a functional *corpus luteum*. The *corpus luteum* produces some estradiol to partially replace that provided earlier by the maturing follicle. However, its principal product is progesterone. Estradiol and progesterone are the main stimulators of uterine endometrial wall thickening in preparation for implantation. One of the proteins induced by estradiol action in the endometrium is the progesterone receptor. Thus the uterine endometrial cells become exquisitely sensitive to estradiol as well as progesterone. The corpus luteum supplies the latter, but in the absence of fertilization and development of an embryo, the corpus luteum lives only for a short while and then atrophies because of lack of LH or chorionic gonadotropin, a hormone produced by the early embryo. The production of oxytocin and $\text{PGF}_{2\alpha}$ in the ovary may bring about the destruction of the corpus luteum (luteolysis). Blood levels of estradiol and progesterone fall dramatically after luteolysis and the stimulators of uterine endometrial cells disappear, causing degeneration of this thickened, vascularized layer of tissue and precipitating menstruation. These cells die by programmed cell death (apoptosis) due to the withdrawal of steroids. The hallmark of programmed cell death is internucleosomal cleavage of DNA. Thus programmed cell death appears to play specific roles in development and in tissue cycling either due to a specific hormonal stimulus or to withdrawal of hormone(s) as described here.

Erickson, G. F., and Schreiber, J. R. Morphology and physiology of the ovary. In: K. L. Becker (Ed.), *Principles and Practice of Endocrinology and Metabolism*. New York: Lippincott, 1990, p. 776; Rebar, R. W., Kenigsberg, D., and Hogden, G. D. The normal menstrual cycle and the control of ovulation. In: K. Becker (Ed.), *Principles and Practice of Endocrinology and Metabolism*. New York: Lippincott, 1990, p. 788; and Hamburger, L., Hahlin, M., Hillensjo, T., Johanson, C., and Sjogren, A. Luteotropic and luteolytic factors regulating human corpus luteum function. *Ann. N.Y. Acad. Sci.* 541:485, 1988.

proliferate and then regress until another cycle is initiated to begin the proliferation all over again, as is the case with the ovarian cycle.

Glucocorticoid-induced apoptosis in thymocytes is mediated by the intracellular glucocorticoid receptor. There are two phases to this complex process: inhibition of cell proliferation (cytostatic phase) followed by a cytolytic phase characterized by internucleosomal DNA cleavage and ultimate cell death (cytolytic phase). These two phases are not necessarily linked, since some cells are growth inhibited, but not lysed, by glucocorticoid hormones. The precise mechanism by which glucocorticoid-receptor complexes induce cell death is not fully understood. Exposure to hormone may result in a conformational change in chromatin with the unmasking of internucleosomal linker DNA regions, which are substrates for a nuclease. Treatment of thymocytes with glucocorticoids results in the activation of a constitutive, endogenous $\text{Ca}^{2+}/\text{Mg}^{2+}$ -dependent endonuclease, while similar treatment of human leukemic T cells results in the activation of $\text{Ca}^{2+}/\text{Mg}^{2+}$ -independent nuclease. Recent studies have demonstrated that the $\text{Ca}^{2+}/\text{Mg}^{2+}$ -dependent nuclease that is activated by glucocorticoids in rat thymocytes is homologous with a cyclophilin. These proteins are high-affinity binding proteins for the immunosuppressive drug, cyclosporin A, and have $\text{Ca}^{2+}/\text{Mg}^{2+}$ -dependent nuclease activity. The mechanism(s) by which glucocorticoid hormones induce lysis of thymocytes versus leukemic T cells appears to differ in several other respects. Treatment of sensitive T cells with these hormones results in upregulation of glucocorticoid receptor mRNA levels, while identical treatment of thymocytes appears to result in down-regulation of mRNA levels. Also, the mRNA levels for an important growth factor, *c-myc*, are repressed in glucocorticoid-treated T cells but induced in thymocytes. Thus the cytostatic and cytolytic phases of apoptosis may be mediated by slightly different pathways in these two different cell types.

Bibliography

- Argentin, S., Sun, Y. L., Lihmann, I., Schmidt, T. J., Drouin, J., and Nemer, M. Distal *cis*-acting promoter sequences mediate glucocorticoid stimulation of cardiac ANF gene transcription. *J. Biol. Chem.* 266:23315, 1991.
- Baulieu, E.-E. Steroid hormone antagonists at the receptor level: a role for heat-shock protein MW 90,000 (hsp 90). *J. Cell Biochem.* 35:161, 1987.
- Beato, M. Gene regulation by steroid hormones. *Cell* 56:335, 1989.

- Carson-Jurica, M. A., Schrader, W. T., and O'Malley, B. W. Steroid receptor family: structure and functions. *Endocr. Rev.* 11:201, 1990.
- Chrousos, G. P., Loriaux, D. L., and Lipsett, M. B. (Eds.). *Steroid Hormone Resistance*. New York: Plenum Press, 1986.
- Drouin, J., Sun, Y. L., Trambly, S., Schmidt, T. J., deLean A., and Nemer, M. Homodimer formation is rate-limiting for high affinity DNA binding by glucocorticoid receptor. *Mol. Endocrinol.* 6:1299, 1992.
- Evans, R. M. The steroid and thyroid hormone receptor superfamily. *Science* 240:889, 1988.
- Giguere, V., Hollenberg, S. M., Rosenfeld, M. G., and Evans, R. M. Functional domains of the human glucocorticoid receptor. *Cell* 46:645, 1986.
- Green, S., Kumar, V., Theulaz, I., Wahli, W., and Chambon, P. The N-terminal DNA-binding "zinc-finger" of the estrogen and glucocorticoid receptors determines target gene specificity. *EMBO J.* 7:3037, 1988.
- Gustafsson, J. A., Carlstedt-Duke, J., Poellinger, L., et al. Biochemistry, molecular biology, and physiology of the glucocorticoid receptor. *Endocr. Rev.* 8:185, 1987.
- Huft, R. W., and Pauerstein, C. J. *Human Reproduction: Physiology and Pathophysiology*. New York: Wiley, 1979.
- Litwack, G. (Ed.). *Biochemical Actions of Hormones*, Vols. 1–14. New York: Academic Press, 1973–1987.
- Litwack, G. (Ed.). *Steroids. Vitamins and Hormones*, Vol. 49. San Diego: Academic Press, 1994.
- Litwack, G. (Ed. in Chief). *Vitamins and Hormones*, Vol. 51. San Diego: Academic Press, 1995.
- Mester, J., and Baulieu, E.-E. Nuclear receptor superfamily. In: L. J. DeGroot, (Ed.) *Endocrinology*, 3rd ed., Philadelphia: Saunders, 1995, pp. 93–118.
- Norman, A. W., and Litwack, G. *Hormones*. Orlando, FL: Academic Press, 1987.
- O'Malley, B. W., Tsai, S. Y., Bagchi, M., Weigel, N. L., Schrader, W. T., and Tsai, M.-J. Molecular mechanism of action of a steroid hormone receptor. *Recent Prog. Horm. Res.* 47:1, 1991.
- Renkawitz, R. Repression mechanisms of *v-erbA* and other members of the steroid receptor superfamily. *Ann. N.Y. Acad. Sci.* 684:1, 1993.
- Rusconi, S., and Yamamoto, K. R. Functional dissection of the hormone and DNA binding activities of the glucocorticoid receptor. *EMBO J.* 6:1309, 1987.
- Schmidt, T. J., and Meyer, A. S. Autoregulation of corticosteroid receptors. How, when, where and why? *Receptor* 4:229, 1994.
- Schwabe, J. W. R., and Rhodes, D. Beyond zinc fingers: steroid hormone receptors have a novel structural motif for DNA recognition. *Trends Biochem. Sci.* 16:291, 1991.
- Wahli, W., and Martinez, E. Superfamily of steroid nuclear receptors—positive and negative regulators of gene expression. *FASEB J.* 5:2243, 1991.

Questions

J. Baggott and C. N. Angstadt

- The C-21 steroid hormones include:
 - aldosterone.
 - dehydroepiandrosterone.
 - estradiol.
 - testosterone.
 - vitamin D₃.
- Side chain cleavage enzyme complex activity may be stimulated by all of the following EXCEPT:
 - cAMP.
 - Ca²⁺ released via stimulation of the IP₃ pathway.
 - Ca²⁺ entering the cell through a channel.
 - 5'-AMP.
 - induction of the STAR protein.
- 5-Pregnenolone is a precursor of all of the following EXCEPT:
 - aldosterone.
 - cortisol.
 - 17β-estradiol.
 - progesterone.
 - vitamin D₃.
- Major steps in the inactivation and excretion of ALL classes of steroid hormones (except vitamin D₃) include:
 - conjugation to glucuronic acid.
 - conjugation to sulfuric acid.
 - hydroxylation.
 - oxidation.
 - side chain cleavage.
- All of the following may be involved in the action of steroid hormone receptors EXCEPT:
 - binding of the hormone to an intracellular receptor.
 - activation of a G-protein.
 - association with a heat shock protein (hsp90) with a cytoplasmic receptor.
 - binding to a receptor in the nucleus.
 - translocation of a cytoplasmic hormone–receptor complex into the nucleus.
- Retinoic acid and its derivatives:
 - may activate genes by preventing the binding of receptor proteins to silencer elements.
 - bind to homodimeric proteins, which in turn bind to DNA.
 - bind to DNA via leucine zipper motifs.
 - are vitamin derivatives and hence have no effect on regulation of gene expression.
 - may substitute for thyroid hormones in binding to the thyroid hormone receptor.
- Reactions in the pathway of synthesis of active vitamin D involve all of the following organs EXCEPT:
 - skin.
 - kidney.
 - liver.
 - intestine.

Refer to the following for Questions 8–11:

- corticosteroid binding globulin
 - serum albumin
 - sex hormone-binding globulin
 - androgen-binding protein
 - transferrin
- Major aldosterone carrier in blood.
 - Produced by the Sertoli cells.
 - Binds about 20% of the cortisol in the plasma.
 - At puberty decreases more in males than in females.
 - Receptors for steroid hormones are found in:
 - cell membranes.
 - cytoplasm.
 - ribosomes.
 - mitochondria.
 - Golgi apparatus.

13. Which of the following involve(s) a response element of DNA that differs from all of the other listed hormones?

- A. estrogen
- B. glucocorticoid
- C. mineralocorticoid
- D. progesterone

14. All of the following receptors may belong to the steroid receptor gene superfamily EXCEPT:

- A. aryl hydrocarbon receptor.
- B. *erbA* protein.
- C. retinoic acid receptor.
- D. thyroid hormone receptor.
- E. α -tocopherol receptor.

Refer to the following for Questions 15 and 16:

- A. programmed cell death
- B. stress response
- C. downregulation of steroid receptors
- D. upregulation of steroid receptors
- E. silencing

15. Mechanism for the maturation of certain organs.

16. Receptor mRNA is reduced.

Answers

1. A B and D: These are C-19 androgens. C: Estradiol is a C-18 estrogen. E: Vitamin D₃ is a C-27 compound (pp. 899–900).

2. D See Figure 21.4, p. 898.

3. E See Figure 21.5 (p. 899) and Figure 21.6 (p. 900) for the synthesis of A–D. The synthesis of vitamin D₃ is summarized in Figure 21.11 (pp. 906–907).

4. A Oxidation (including hydroxylation) and reduction are common in steroid hormone degradation. Glucocorticoids undergo side chain cleavage. Conjugation to sulfate is important in the excretion of androgens. But conjugation to glucuronide is significant for all steroid hormones except vitamin D₃ (Table 21.2, p. 902).

5. B G-proteins are generally associated with signal transduction for receptors on the membrane surface. See Figure 21.13 for the roles of the other choices.

6. A The retinoic acid receptor (RAR) binds to specific silencer elements in the absence of the ligand, retinoic acid. When bound, transcription of the gene is repressed. In addition, there are retinoid X receptors (RXR), which also affect gene expression, via heterodimerization with RAR (p. 912, Figure 21.14b).

7. D Intestine is a target organ of the active hormone, but is not involved in synthesis. See Figure 21.11, p. 906. A: Light-induced cleavage of 7-dehydrocholesterol occurs in the skin. B: Hydroxylation of 25-(OH)D₃ occurs in the kidney. C: Hydroxylation of D₃ occurs in the liver.

8. B See p. 908.

9. D See p. 908.

10. B Cortisol-binding globulin carries most of the cortisol. Serum albumin, however, nonspecifically binds a large number of hydrophobic substances, including cortisol (p. 908).

11. C As a result, there is more unbound testosterone circulating in the blood of males (p. 908).

12. B B: In addition, the nucleus contains steroid hormone receptors. See Figure 21.13, p. 909. A: Membrane receptors are generally associated with nonhydrophobic hormones, such as epinephrine and peptide hormones (Figure 21.4, p. 898).

13. A The *positive* glucocorticoid response element is the same as the mineralocorticoid response element and the progesterone response element. The estrogen response element differs (Table 21.4, p. 911).

14. E Note that *c-erbA* is a protooncogene. See p. 913, Figure 21.17.

15. A Thymus cortical cells are killed by cortisol (p. 915).

16. C This contrasts with cell membrane receptors, which can be internalized to render the cell less responsive (p. 915).

Chapter 22— Molecular Cell Biology

Thomas E. Smith

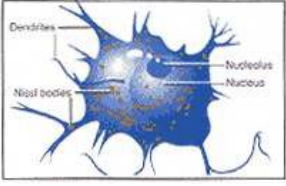

22.1 Overview	920
22.2 Nervous Tissue: Metabolism and Function	920
ATP and Transmembrane Electrical Potential in Neurons	921
Neuron–Neuron Interaction Occurs through Synapses	923
Synthesis, Storage, and Release of Neurotransmitters	924
Termination of Signals at Synaptic Junctions	927
Acetylcholine	928
Catecholamines	929
5-Hydroxytryptamine (Serotonin)	930
4-Aminobutyrate (γ -Aminobutyrate)	931
Neuropeptides Are Derived from Precursor Proteins	931
22.3 The Eye: Metabolism and Vision	932
The Cornea Derives ATP from Aerobic Metabolism	933
Lens Consists Mostly of Water and Protein	933
The Retina Derives ATP from Anaerobic Glycolysis	935
Visual Transduction Involves Photochemical, Biochemical, and Electrical Events	936
Photoreceptor Cells Are Rods and Cones	937
Color Vision Originates in the Cones	944
Other Physical and Chemical Differences between Rods and Cones	945
22.4 Muscle Contraction	946
Skeletal Muscle Contraction Follows an Electrical to Chemical to Mechanical Path	946
Myosin Forms the Thick Filament of Muscle	949
Actin, Tropomyosin, and Troponin Are Thin Filament Proteins	951
Muscle Contraction Requires Ca^{2+} Interaction	954
Energy for Muscle Contraction Is Supplied by ATP Hydrolysis	954
Model for Skeletal Muscle Contraction	957
Calcium Regulates Smooth Muscle Contraction	959
22.5 Mechanism of Blood Coagulation	960
Clot Formation Is a Membrane-Mediated Process	960
Reactions of the Intrinsic Pathway	961
Reactions of the Extrinsic Pathway	963
Thrombin Converts Fibrinogen to Fibrin	964
Major Roles of Thrombin	966
Formation of a Platelet Plug	967
Properties of Some of the Proteins Involved in Coagulation	968
Role of Vitamin K in Protein Carboxylase Reactions	970
Control of the Synthesis of Gla-Proteins	971
Dual Role of Thrombin in Promoting Coagulation and Clot Dissolution	972
The Allosteric Role of Thrombin in Controlling Coagulation	974
Inhibitors of the Plasma Serine Proteinases	975
Fibrinolysis Requires Plasminogen and Tissue Plasminogen Activator (t-PA) to Produce Plasmin	975
Bibliography	976
Questions and Answers	977
Clinical Correlations	
22.1 Lambert–Eaton Myasthenic Syndrome	927
22.2 Myasthenia Gravis: A Neuromuscular Disorder	929
22.3 Macula Degeneration: Other Causes of Vision Loss	936
22.4 Niemann–Pick Disease and Retinitis Pigmentosa	938
22.5 Retinitis Pigmentosa Resulting from a <i>De Novo</i> Mutation in the Gene Coding for Peripherin	940
22.6 Abnormalities in Color Perception	946
22.7 Troponin Subunits As Markers for Myocardial Infarction	954
22.8 Voltage-Gated Ion Channelopathies	956
22.9 Intrinsic Pathway Defects: Prekallikrein Deficiency	963
22.10 Classic Hemophilia	969
22.11 Thrombosis and Defects of the Protein C Pathway	971

22.1—

Overview

Animals sense their environment through the responses of certain organs to stimuli: touch, pain, heat, cold, intensity (light or noise), color, shape, position, pitch, quality, acid, sweet, bitter, salt, alkaline, fragrance, and so on. Externally, these generally reflect responses of the skin, eye, ear, tongue, and nose to stimuli. Some of these signals are localized to the point at which they occur; others—sound and sight—are projected in space, that is, the environment outside and distant to the animal.

Discrimination of these signals occurs at the point of reception, but acknowledgment of what they are occurs as a result of secondary stimulation of the nervous system and transmission of the signals to the brain. In many instances, a physical response is indicated, which results in muscular activity, either voluntary or involuntary.

Common to these events is electrical activity associated with signal transmission along neurons and chemical activity associated with signal transmission across synaptic junctions. In all cases, stimuli received from the environment in the form of pressure (skin, feeling), light (eye, sight), noise (ear, hearing), taste (tongue), or smell (nose) are converted (transduced) into electrical impulses and to some other form of energy in order to effect the desired terminal response dictated by the brain. A biochemical component is associated with each of these events.

General biochemical mechanisms of signal transduction and amplification will be discussed as they relate to biochemical events involved in nerve transmission, vision, and muscular contraction. Finally, a specialized case of biochemical signal amplification will be discussed, namely, blood coagulation. This process is initiated on membrane surfaces as a result of the exposure of specific proteins that act as receptors and form nucleation sites for formation of multienzyme complexes. These multienzyme complexes lead to the amplification of blood coagulation through a cascade mechanism.

22.2—

Nervous Tissue:**Metabolism and Function**

Knowledge of the chemical composition of the **brain** began with the work of J. L. W. Thudichum in 1884 and the publication of his monogram, "A Treatise on the Chemical Composition of the Brain, Based Throughout on Original Research" (cited in West and Todd, *Textbook of Biochemistry*, MacMillan, 1957). Thudichum's research was supplemented with the work of others during those earlier years. There have been almost explosive advances during more recent years, through the use of molecular biological techniques, not only in our knowledge of the composition of the brain but also of molecular mechanisms involved in many brain/neuronal functions.

About 2.4% of an individual's body weight is nervous tissue, of which approximately 83% is the brain. The **nervous system** provides the communications network between the senses, the environment, and all parts of the body. The brain is the command center. This system is always functioning and requires a large amount of energy to keep it operational. Under normal conditions, the brain derives its **energy** from **glucose metabolism**. **Ketone bodies** can cross the **blood–brain barrier** and be metabolized by brain tissue. Their metabolism becomes more prominent during **starvation**, but even then they cannot replace the need for glucose. The human brain uses approximately 103 g of glucose per day. For a 1.4-kg brain, this corresponds to a rate of utilization of approximately $0.3 \text{ mol min}^{-1} \text{ g}^{-1}$ of tissue. This rate of glucose utilization represents a capacity for **ATP production** through the **tricarboxylic acid (TCA) cycle** alone of approximately $6.8 \text{ mol min}^{-1} \text{ g}^{-1}$ of tissue. Of course, the TCA cycle is not 100% efficient for ATP production, nor is all of the glucose metabolized through it. Most of the ATP used by the brain and other nervous tissue is

generated aerobically through the TCA cycle, which functions at near maximum capacity. **Glycolysis** functions at approximately 20% capacity. Much of the energy used by the brain is to maintain ionic gradients across the plasma membranes, to effect various storage and transport processes, and for the synthesis of neurotransmitters and other cellular components.

Two features of brain composition are worth noting. It contains specialized and **complex lipids**, but they appear to function to maintain membrane integrity (see Chapter 5) rather than to have metabolic roles. There is generally a rapid **turnover rate of brain proteins** relative to other body proteins in spite of the fact that the cells do not divide after they have differentiated.

Cells of the nervous system responsible for collecting and transmitting messages are the **neurons**. They are very highly specialized (Figure 22.1). Each neuron consists of a cell body, **dendrites** that are short antenna-like protrusions that receive signals from other cells, and an **axon** that extends from the cell body and transmits signals to other cells. The central nervous system (CNS) is a highly integrated system where individual neurons can receive signals from a variety of different sources, including both inhibitory and excitatory stimuli.

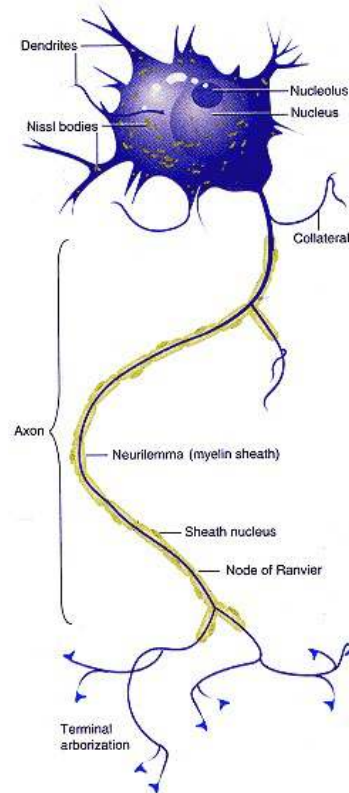

Figure 22.1

A motor nerve cell and investing membranes.

Cells other than neurons exist in the CNS. In the brain, there are about 10 times more glial cells than there are neurons. Glial cells occupy spaces between neurons and provide some electrical insulation. Glial cells are generally not electrically active, and they are capable of division. There are basically five types of glial cells: Schwann cells, oligodendrocytes, microglia, ependymal cells, and astrocytes. Each type of glial cell has a specialized function, but only astrocytes appear to be directly associated with biochemical functions related to neuronal activity. One is metabolic (see discussion below on GABA) and the other anatomical.

Astrocytes send out processes at the external surfaces of the CNS. These processes are linked to form anatomical complexes that provide sealed barriers and isolate the CNS from the external environment. Astrocytes also send out similar processes to the circulatory system, inducing the endothelial cells of the capillaries to become sealed by forming tight junctions that prevent the passive entry into the brain of water-soluble molecules. These tight junctions form what is commonly known as the **blood–brain barrier**. Water-soluble compounds enter the brain only if there are specific membrane transport systems for them.

The normal individual has between 10^{11} and 10^{13} neurons, and communication between them is by electrical and chemical signals. Electrical signals transmit nerve impulses down the axon and chemicals transmit signals across the gap between cells. Some of the biochemical events that give the cell its electrical properties and are involved in the propagation of an impulse will be discussed.

ATP and Transmembrane Electrical Potential in Neurons

Adenosine triphosphate generated from the metabolism of glucose is used to help maintain an **equilibrium electrical potential** across the membrane of the neuron of approximately -70 mV, with the inside being more negative than the outside. This potential is maintained by the action of the **Na⁺, K⁺ ion pump** (see pp. 206–207), the energy for which is derived from the hydrolysis of ATP to give ADP and inorganic phosphate. This system pumps Na⁺ out of the cell by an antiport mechanism, whereas K⁺ is moved into the cell. The channels through which Na⁺ enters the cell are **voltage gated**; that is, the proteins of the channel undergo a charge-dependent conformation change and open when the electrical potential across the membrane decreases (specifically, becomes less negative) by a value greater than some threshold value. When the membrane becomes depolarized, Na⁺, whose concentration is higher outside the cell than inside, flows into the cell and K⁺, whose concentration is greater inside the cell, flows out of the cell, both going down their respective concentration gradients. The channels are open in a particular geographical

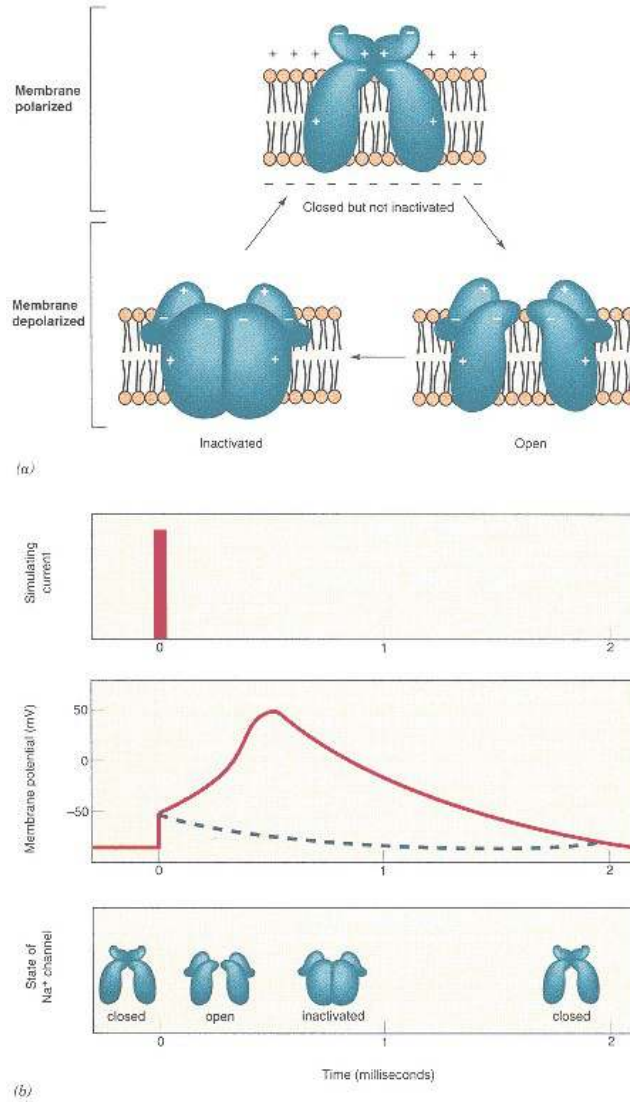

Figure 22.2

Schematic of Na⁺ channels opening and closing during nerve impulse transmission.

Redrawn from Alberts, B., Bray, D., Lewis, J., Raff, M., Roberts, K., and Watson, J. *Molecular Biology of the Cell*, 2d ed. New York: Garland Publishing, 1989, p. 1071.

region of the cell for fractions of a millisecond (Figure 22.2). The localized depolarization (voltage change) causes a conformation change in the neighboring proteins that make up the **voltage-gated ion channels**. These channels open momentarily to allow more ions in and, thus, by affecting adjacent channel proteins, allow the process to continue down the axon. There is a finite recovery

time. During this time, the proteins that form the channels cannot repeat the process of opening. Thus charge propagation proceeds in one direction. It is the progressive depolarization and repolarization along the length of the axon that allow electrical impulses to be propagated undiminished in amplitude. Electrical impulse transmission is a continuous process in nervous tissue, and it is the ATP generated primarily from the metabolism of glucose that keeps the system operational.

A current area of active research in biochemistry involves the use of gene cloning and engineering techniques to isolate ion channel proteins and to determine their structures and elucidate their mechanisms of action. A considerable amount of information has been obtained in recent years on how mutations in voltage-gated ion channels may affect muscle function. Considerably less is known, however, about the relationship between structural disorders of ion channels in neurons and clinical disorders.

TABLE 22.1 Some of the Neurotransmitters Found in Nervous Tissue

EXCITATORY
Acetylcholine
Aspartate
Dopamine
Histamine
Norepinephrine
Epinephrine
ATP
Glutamate
5-Hydroxytryptamine
INHIBITORY
4-Aminobutyrate
Glycine
Taurine

Neuron–Neuron Interaction Occurs through Synapses

There are generally two mechanisms for **neuron–neuron interaction**: through **electrical synapses** or through **chemical synapses**. Electrical synapses permit the more rapid transfer of signals from cell to cell. Chemical synapses allow for various levels of versatility in cell–cell communication. T. R. Elliot, in a paper published in 1904, was one of the first scientists to clearly express the idea that signaling between nerves could be chemical. Needless to say, considerably more information is now known about this mode of neuron–neuron communication. Chemical synapses are of two types: those that bind directly to an ion channel and cause it to open or to close, and those that bind to a receptor that releases a second messenger that reacts with the ion channel to cause it to open or to close. Primary emphasis here is on chemical synapses.

Chemical neurotransmitters fit the following criteria: they are found in the presynaptic axon terminal; enzymes necessary for their syntheses are present in the presynaptic neuron; stimulation under physiological conditions results in their release; mechanisms exist (within the synaptic junction) for rapid termination of their action; and their direct application to the postsynaptic terminal mimics the action of nervous stimulation. A sixth criterion, as a corollary of the five criteria listed above, is that drugs that modify the metabolism of the neurotransmitter should have predictable physiological effects *in vivo*, assuming that the drug is transported to the site where the neurotransmitter acts.

Chemical neurotransmitters may be excitatory or inhibitory. **Excitatory neurotransmitters** include acetylcholine and the catecholamines. **Inhibitory neurotransmitters** include γ -aminobutyric acid (also referred to as GABA or 4-aminobutyric acid), glycine, and taurine (Table 22.1).

The two major inhibitory neurotransmitters in the central nervous system are glycine and GABA. Glycine acts predominantly in the spinal cord and the brain stem, and γ -aminobutyric acid (GABA) acts predominantly in all other parts of the brain. **Strychnine** (Figure 22.3), a highly poisonous alkaloid obtained from *Nux vomica* and related plants of the genus *Strychnos*, binds to **glycine receptors** of the CNS. It has been used in very small amounts as a CNS stimulant. Can you propose how it works? The **GABA receptor** also reacts with a variety of pharmacologically significant agents such as benzodiazepines (Figure 22.4) and barbiturates. As with strychnine and glycine, there is little structural similarity between GABA and benzodiazepines.



Figure 22.3
Structures of glycine and strychnine.

The genes for the **acetylcholine receptor**, which also binds nicotinic acid, the glycine receptor, and the GABA receptor have been cloned and their amino acid sequences inferred. There is a relatively high degree of homology in their primary amino acid sequences.

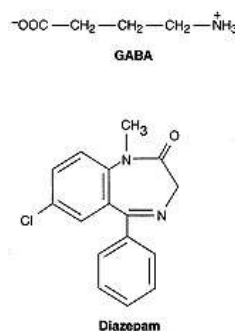

Figure 22.4
Structures of GABA and diazepam.

A model of one-half of the GABA receptor is shown in Figure 22.5. This receptor has an $\alpha_2\beta_2$ composition. The polypeptides are synthesized with "signal

peptides" that direct their transport to the membrane. The α subunit has 456 amino acid residues and the β subunit has 474. The signal peptides are cleaved, leaving α and β subunits of 429 and 449 amino acid residues, respectively. Interestingly, the pharmaceutical agents bind to the α subunit, whereas GABA, the natural inhibitory neurotransmitter, binds to the β subunit. The protrusion of an extended length of the amino-terminal end of each polypeptide to the extracellular side of the membrane suggests that the residues to which the channel regulators bind are at the N terminal. A smaller C-terminal segment is also on the extracellular side of the membrane. The four subunits of the receptor form a channel through which small negative ions (Cl^-) can flow, depending on what is bound to the receptor end of the molecule.

All neurotransmitters are made and stored in **presynaptic neurons**. They are released after stimulation of the neuron, traverse the synapse, and bind to a specific receptor on the postsynaptic junction to elicit a response in the next cell. If the neurotransmitter is an excitatory one, it causes depolarization of the membrane as described above. If it is an inhibitory neurotransmitter, it binds to a channel-linked receptor and causes a conformation change that opens the pores and permits small negatively charged ions, specifically Cl^- , to enter. The net effect of this is to increase the chloride conductance of the postsynaptic membrane, making it more difficult for it to become depolarized—that is, effectively causing **hyperpolarization**.

Synthesis, Storage, and Release of Neurotransmitters

Nonpeptide neurotransmitters may be synthesized in almost any part of the neuron, in the cytoplasm near the nucleus, or in the axon. Most nonpeptide neurotransmitters are amino acids, derivatives of amino acids, or other intermediary metabolites. Synthesis and degradation of many of them have been discussed elsewhere, but some aspects of their metabolism relative to nerve transmission will be discussed later in this chapter.

Neurotransmitters travel rapidly across the **synaptic junction** (which is about 20 nm across), bind to receptors on the postsynaptic side, induce

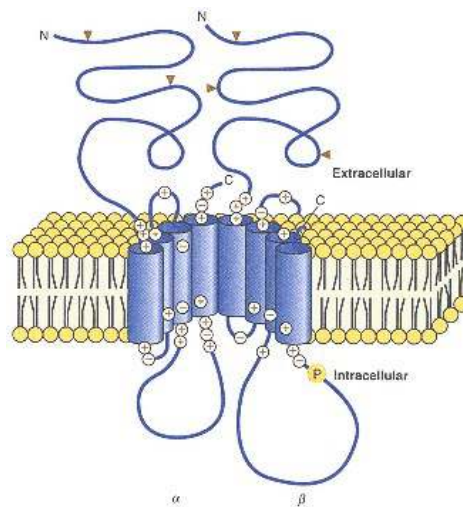

Figure 22.5
Schematic model of one-half of the GABA receptor embedded in the cell membrane.

The complete receptor has an $\alpha_2\beta_2$ structure and forms an ion channel. The site labeled P is a serine residue that may be phosphorylated by a cAMP-dependent protein kinase.

Redrawn from Schofield, P. R., Darlison, M. G., Fujita, N. et al. *Nature* 328:221, 1987.

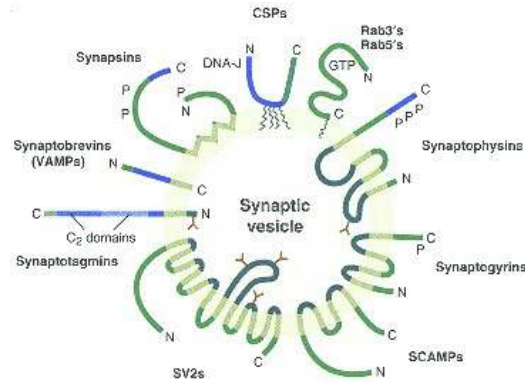

Figure 22.6
Schematic drawing of the relative arrangement of proteins of the synaptic vesicle (SV).

Rab proteins are attached by isoprenyl groups and cysteine string proteins by palmitoyl chains to SVs. The N and C termini of proteins are marked by N and C, respectively. Phosphorylation sites are indicated by P.

Redrawn from Sudhof, T. C. *Nature* 375:645, 1995.

conformational changes in receptors and/or that membrane, and start the process of electrical impulse propagation in the postsynaptic neuron. Storage and release of neurotransmitters are intricate processes, but many details of the mechanism of these processes have begun to unfold. It has been shown by conventional techniques that some neurons contain more than one chemical type of neurotransmitter. The significance of this observation is unclear. Release of neurotransmitter is a **quantal event**; that is, a nerve impulse reaching the presynaptic terminal results in the release of transmitters from a fixed number of **synaptic vesicles**. Release of neurotransmitters involves attachment of the synaptic vesicle to the membrane and **exocytosis** of their content into the synaptic cleft.

Storage of neurotransmitters occurs in large or small vesicles in the presynaptic terminal. Small vesicles are the predominant type and exist in two pools: free and attached to cytoskeletal proteins, mainly actin. Small vesicles contain only "classical" small molecule type transmitters, whereas large vesicles may contain "classical" small molecule neurotransmitters and neuropeptides. Some may also contain enzymes for synthesis of norepinephrine from dopamine. A schematic diagram of a small synaptic vesicle is shown in Figure 22.6. The genes for many of the proteins attached to the synaptic vesicle have been cloned and significant amounts of information about their functions are known. Table 22.2 contains a list of some of those proteins. Some of their properties are briefly described. Figure 22.7 shows schematically how some of them may be arranged on the synaptic vesicle and how they may interact with the plasma membrane of the presynaptic neuron.

1. **Synapsin** exists as a family of proteins encoded by two genes. The proteins differ primarily in the C-terminal end (Figure 22.8). They constitute about 9% of the total protein of the synaptic vesicle membrane. All can be phosphorylated near their N termini by either **cAMP-dependent protein kinase** and/or **calcium-calmodulin (CaM) kinase I**, which is considered to be the physiologically important one relative to nerve transmission. Synapsins Ia and Ib can also be phosphorylated by **CaM kinase II** near their C termini, a region that is missing in synapsin IIa and IIb.

Synapsin has a major role in determining whether the synaptic vesicles are in the free pool and available for binding to the presynaptic membrane. Nerve stimulation leads to the entry of Ca^{2+} into the presynaptic vesicle (see Clin. Corr. 22.1). CaM kinase I (II also) is activated and phosphorylates synapsin. This either prevents binding of synaptic vesicles to the cytoskeletal proteins or

TABLE 22.2 List of Synaptic Vesicle Proteins

Synapsin	Ia
	Ib
	IIa
	IIb
Synaptophysin	
Synaptotagmin (p65)	
Syntaxin (p35)	
Synaptobrevin/VAMP	
Rab3 and rabphilin	
SV-2	
Vacuolar proton pump	

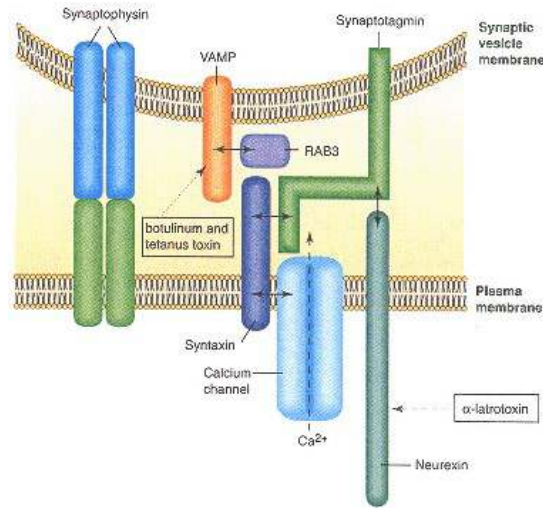

Figure 22.7
Schematic diagram showing how some of the synaptic vesicle proteins may interact with plasma membrane proteins to effect exocytosis.
 Redrawn from Bennett, M. K., and Scheller, R. H.
Proc. Natl. Acad. Sci. USA, 90:2559, 1993.

releases them from those binding sites. The result is an increase in the free pool of synaptic vesicles. It has also been observed that **calcium-calmodulin** itself can bind synapsin and competitively block its interaction with actin. Calcium-calmodulin therefore regulates the number of free synaptic vesicles in the two pools by two mechanisms.

2. **Synaptophysin** is an integral membrane protein of synaptic vesicles that is structurally similar to gap junction proteins. It may be involved in the **formation of a channel** from the synaptic vesicle through the presynaptic membrane to permit the passage of neurotransmitters into the synaptic cleft.

3. **Synaptotagmin** is also an integral membrane protein of synaptic vesicles that interacts in a Ca^{2+} -dependent manner with specific proteins localized

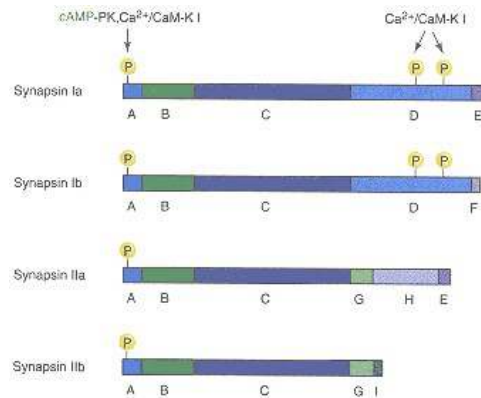

Figure 22.8
Structural arrangement of the synapsin family of proteins.
 Redrawn from Chilcote, T. J., Siow, Y. L., Schaeffer, E., et al.
J. Neurochem. 63:1568, 1994.

CLINICAL CORRELATION 22.1**Lambert–Eaton Myasthenic Syndrome**

Lambert–Eaton myasthenic syndrome (LEMS) is an autoimmune disease in which the body raises antibodies against voltage-gated calcium channels (VGCC) located on presynaptic nerve termini. Upon depolarization of presynaptic neurons, calcium channels at presynaptic nerve termini open, permitting the influx of calcium ions. This increase in calcium ion concentration initiates events of the synapsin cycle and leads to release of neurotransmitters into synaptic junctions. When autoantibodies against VGCC react with neurons at neuromuscular junctions, calcium ions cannot enter and the amount of acetylcholine released into synaptic junctions is diminished. Since action potentials to muscles may not be induced, the effect mimics that of classic myasthenia gravis.

LEMS has been observed in conjunction with other conditions such as small cell lung cancer. Some patients have shown a neurological disorder manifesting itself as subacute cerebellar degeneration (SCD). Plasma exchange (removal of antibodies) and immunosuppressive treatments have been effective for LEMS, but the latter treatment is less effective on SCD.

Diagnostic assays for LEMS depend on the detection of antibodies in patients' sera against VGCC. There are at least four subtypes of VGCC: T, L, N, and P. It has been found that the P subtype may be the one responsible for initiating neurotransmitter release at the neuromuscular junction in mammals. A peptide toxin produced by a cone snail (*Conus magnus*) binds to P-type VGCC in cerebella extracts. This small peptide has been labeled with ^{125}I , bound to VGCC in cerebella extracts, and the radiolabeled complex was precipitated by sera of patients who have been clinically and electrophysiologically defined as LEMS positive. This assay may prove useful not only in detecting LEMS but also in providing a means of finding out more about the antigenicity of the area(s) on the VGCCs to which antibodies are raised.

Goldstein, J. M., Waxman, S. G., Vollmer, T. L., et al. Subacute cerebellar degeneration and Lambert–Eaton myasthenic syndrome associated with antibodies to voltage-gated calcium channels: differential effect of immunosuppressive therapy on central and peripheral defects. *J. Neurol. Neurosurg. Psychiatry* 57:1138, 1994; and Motomura, M., Johnston, I., Lang, B., et al. An improved diagnostic assay for Lambert–Eaton myasthenic syndrome. *J. Neurol. Neurosurg. Psychiatry* 58:85, 1995.

on the presynaptic plasma membrane. It is probably involved in the process of **docking** of synaptic vesicles to the membrane.

4. **Syntaxin** is an integral membrane protein of the plasma membrane of the presynaptic neuron. Syntaxin binds synaptotagmin and mediates its interaction with Ca^{2+} channels at the site of release of the neurotransmitters. It also appears to have a role in **exocytosis**.
5. **Synaptobrevin/VAMP** (or vesicle-associated membrane protein) exists as a family of two small proteins of 18 and 17 kDa. They are anchored in the cytoplasmic side of the synaptic vesicle membrane through a single C-terminal domain and appear to be involved in **vesicle transport** and/or exocytosis. VAMPs appear to be involved in the release of synaptic vesicles from the plasma membrane of the presynaptic neuron. **Tetanus** and **botulinum toxins** bind VAMPs, causing slow and irreversible inhibition of transmitter release.
6. **Rab3** is one among a large rab family of **GTP-binding proteins**. Rab3 is specific for synaptic vesicles and is involved in the docking and **fusion process of exocytosis**. Rab3 is anchored to the membrane through a **polyprenyl side chain** near its C-terminal end. Elimination by genetic engineering of the polyprenyl side chain binding site did not alter its function *in vitro*, but it is not clear whether this is also true *in vivo*.
7. **SV-2** is a large **glycoprotein** with 12 transmembrane domains. No function has yet been assigned to it.
8. **Vacuolar proton pump** is an **ATPase** found in the vesicle membrane that is responsible for the **transport of neurotransmitters** into the synaptic vesicle.

Termination of Signals at Synaptic Junctions

Neurotransmitter action may be terminated by metabolism, reuptake, and/or diffusion into other cell types. Neurotransmitters responsible for fast responses are generally inactivated by one or both of the first two mechanisms. The following sections will outline some biochemical pathways involved in the synthesis and the degradation of representative fast-acting neurotransmitters—

specifically, acetylcholine, catecholamines, 5-hydroxytryptamine, and 4-aminobutyrate (GABA).

Acetylcholine

Reactions involving **acetylcholine** at the synapse are summarized in Figure 22.9. Acetylcholine is synthesized by the condensation of choline and acetyl CoA in a reaction catalyzed by **choline acetyltransferase** found in the cytosol of the neuron. The reaction is

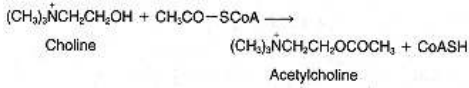

Choline is derived mainly from the diet; however, some may come from reabsorption from the synaptic junction or from other metabolic sources (see p. 460). The major source of acetyl CoA is the decarboxylation of pyruvate by the **pyruvate dehydrogenase complex** in mitochondria. Since choline acetyltransferase is present in the cytosol, acetyl CoA must get into the cytosol for the reaction to occur. The same mechanism discussed previously (see p. 371) for getting acetyl CoA across the inner mitochondrial membrane (as citrate) operates in presynaptic neurons.

Acetylcholine is released and reacts with the **nicotinic-acetylcholine receptor** located in the postsynaptic membrane (see Clin. Corr. 22.2). The action of acetylcholine at the postsynaptic membrane is terminated by the action of the enzyme **acetylcholinesterase**, which hydrolyzes the acetylcholine to acetate and choline:

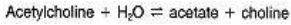

Choline is taken up by the presynaptic membrane and reutilized for synthesis of more acetylcholine. Acetate probably gets reabsorbed into the blood and is metabolized by tissues other than nervous tissue.

An X-ray crystallographic structure of acetylcholinesterase is shown in Figure 22.10. Its mechanism of action is similar to that of serine proteases (see p. 97). It too has a **catalytic triad**, but the amino acids in that triad, from N to C

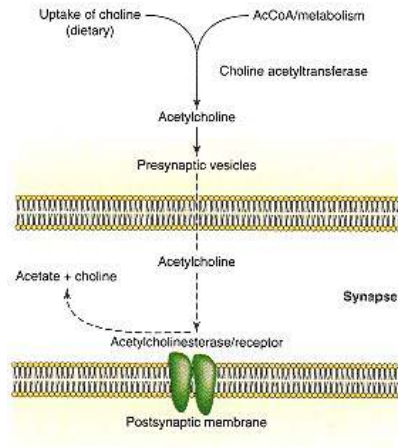

Figure 22.9
Summary of the reactions of acetylcholine at the synapse.
 AcCoA, acetyl coenzyme A.

CLINICAL CORRELATION 22.2**Myasthenia Gravis: A Neuromuscular Disorder**

Myasthenia gravis is an acquired autoimmune disease characterized by muscle weakness due to decreased neuromuscular signal transmission. The neurotransmitter involved is acetylcholine. The sera of more than 90% of patients with myasthenia gravis have antibodies to the nicotinic–acetylcholine receptor (AChR) located on the postsynaptic membrane of the neuromuscular junction. Antibodies against the AChR interact with it and inhibit its function, either its ability to bind acetylcholine or its ability to undergo conformation changes necessary to effect ion transport. Evidence in support of myasthenia gravis as an autoimmune disease affecting the AChR is the finding that the number of AChRs is reduced in patients with the disease, and experimental models of myasthenia gravis have been generated by either immunizing animals with the AChR or by injecting them with antibodies against it.

It is not known what events trigger the onset of the disease. There are a number of environmental antigens that have epitopes resembling those on the AChR. A rat monoclonal antibody of the IgM type prepared against AChRs reacts with two proteins obtained from the intestinal bacterium *Escherichia coli*. Both of the proteins are membrane proteins of 38 and 55 kDa, the smaller of which is located in the outer membrane. This does not suggest that exposure to *E. coli* proteins is likely to trigger the disease. The sera of both normal individuals and myasthenia gravis patients have antibodies against a large number of *E. coli* proteins. Some environmental antigens from other sources also react with antibodies against AChRs.

The thymus gland, which is involved in antibody production, is also implicated in this disease. Antibodies have been found in thymus glands of myasthenia gravis patients that react with AChRs and with environmental antigens. The relationship between environmental antigens, thymus antibodies against AChRs, and onset of myasthenia gravis is unclear.

Myasthenia gravis patients may receive one or a combination of several therapies. Pyridostigmine bromide, a reversible inhibitor of acetylcholine esterase (AChE) that does not cross the blood–brain barrier, has been used. The inhibition of AChE within the synapse by drugs of this type increases the half-time for acetylcholine hydrolysis. This leads to an increase in the concentration of acetylcholine, stimulation of more AChR, and increased signal transmission. Other treatments include use of immunosuppressant drugs, steroids, and surgical removal of the thymus gland to decrease the rate of production of antibodies. Future treatment may include the use of anti-idiotypic antibodies to the AChR antibodies, and/or the use of small nonantigenic peptides that compete with AChR epitopes for binding to the AChR antibodies.

Stefansson, K., Dieperink, M. E., Richman, D. P., Gomez, C. M., and Marton, L. S. *N. Engl. J. Med.* 312:221, 1985; Drachman, D. B. (Ed.). Myasthenia gravis: biology and treatment. *Ann. N.Y. Acad. Sci.* 505:1, 1987; and Steinman, L., and Mantegazza, R. *FASEB J.* 4:2726, 1990.

termini, are in reverse order to those of the serine proteases, and glutamate instead of aspartate is involved.

Catecholamines

The **catecholamine neurotransmitters** are **dopamine** (3,4-dihydroxyphenylethylamine), **norepinephrine**, and **epinephrine** (Figure 22.11). Their biosynthesis has been discussed (see p. 466).

The action of catecholamine neurotransmitters is terminated by reuptake into the presynaptic neuron by specific transporter proteins. Cocaine, for example, binds to the **dopamine transporter** and blocks its reuptake. Dopamine remains within the synapse for a prolonged period of time and continues to stimulate the receptors of the postsynaptic neuron. Once inside the neuron,

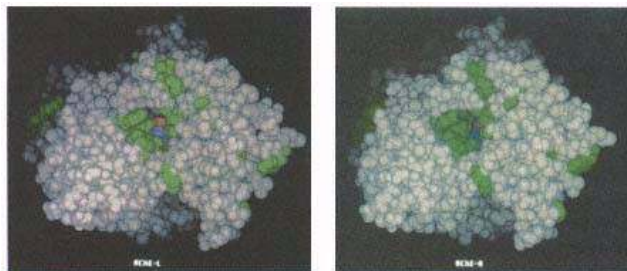

Figure 22.10
Space-filling stereo view of acetylcholinesterase looking down into the active site. Aromatic residues are in green, Ser-200 is red, Glu-199 is cyan, and other residues are gray.

Reproduced with permission from Sussman, J. L., Harel, M., Frolow, F., et al. *Science* 253:872, 1991. Copyright 1991 American Association for the Advancement of Science. Photograph generously supplied by Dr. J. L. Sussman.

these neurotransmitters may be either repackaged into synaptic vesicles or metabolized. The two enzymes primarily involved in their metabolism are **catechol-O-methyltransferase** and **monoamine oxidase**. The metabolic reactions are shown in Figure 22.12. Catechol-O-methyltransferase catalyzes the transfer of a methyl group from *S*-adenosylmethionine to one of the phenolic OH groups. Monoamine oxidase catalyzes the oxidative deamination of these amines to aldehydes and ammonium ions. Monoamine oxidase can use them as substrates whether or not they have been altered by the methyltransferase. The end product of dopamine metabolism is homovanillic acid, and that of epinephrine and norepinephrine is 3-methoxy-4-hydroxymandelic acid.

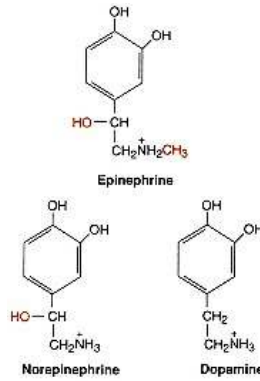
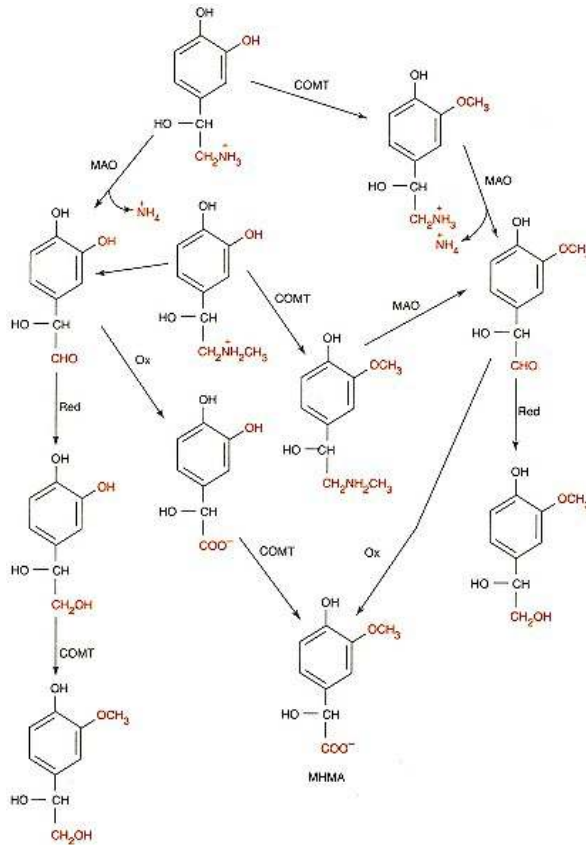

Figure 22.11
Catecholamine neurotransmitters.

5-Hydroxytryptamine (Serotonin)

Serotonin, 5-hydroxytryptamine, is derived from tryptophan (see p. 476). Like dopamine, the action of serotonin is terminated by its reuptake into the presynaptic neuron by a specific transporter. Some types of depression are associated with low brain levels of serotonin. The action of some **antidepressants** such as Paxil (paroxetine hydrochloride), Prozac (fluoxetine hydrochloride), and Zoloft (sertraline hydrochloride) is linked to their ability to inhibit



serotonin reuptake. Once inside the presynaptic neuron, serotonin may be either repackaged in synaptic vesicles or metabolized. The primary route for its **degradation** is **oxidative deamination** to the corresponding acetaldehyde catalyzed by the enzyme monoamine oxidase (Figure 22.13). The aldehyde is further oxidized to 5-hydroxyindole-3-acetate by an aldehyde dehydrogenase.

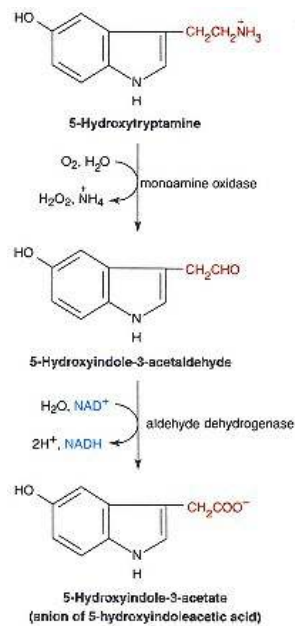

Figure 22.13
Degradation of
5-hydroxytryptamine (serotonin).

4-Aminobutyrate (γ -Aminobutyrate)

γ -Aminobutyrate (GABA), an inhibitory neurotransmitter, is synthesized and degraded through a series of reactions commonly known as the **GABA shunt**. In brain tissue, it appears that GABA and glutamate, an excitatory neurotransmitter, may share some common routes of metabolism in astrocytes (Figure 22.14). Both are taken up by astrocytes and converted to glutamine, which is then transported back into presynaptic neurons. In excitatory neurons, glutamine is converted to glutamate and repackaged in synaptic vesicles. In inhibitory neurons, glutamine is converted to glutamate and then to GABA, which is repackaged in synaptic vesicles.

It has been suggested that brain levels of GABA in some epileptic patients may be low. **Valproic acid** (2-propylpentanoic acid) apparently increases brain levels of GABA. The mechanism by which it does so is not clear. Valproic acid is metabolized primarily in the liver by glucuronidation and urinary excretion of the glucuronides, or by mitochondrial β -oxidation and microsomal oxidation.

Neuropeptides Are Derived from Precursor Proteins

Peptide neurotransmitters are generally synthesized as larger proteins and are cleaved by proteolysis to produce the neuropeptide molecules. Their synthesis requires the same biochemical machinery as does any protein synthesis and takes place in the cell body, not the axon. They travel down the axon to the presynaptic region by one of two generic mechanisms: **fast axonal transport** at a rate of about 400 millimeters per day and **slow axonal transport** at a rate of 1–5 millimeters per day. Since axons may vary in length from 1 millimeter to 1 meter, theoretically the total transit time could vary from 150 milliseconds to 200 days. It is highly unlikely that the latter transit time occurs under normal

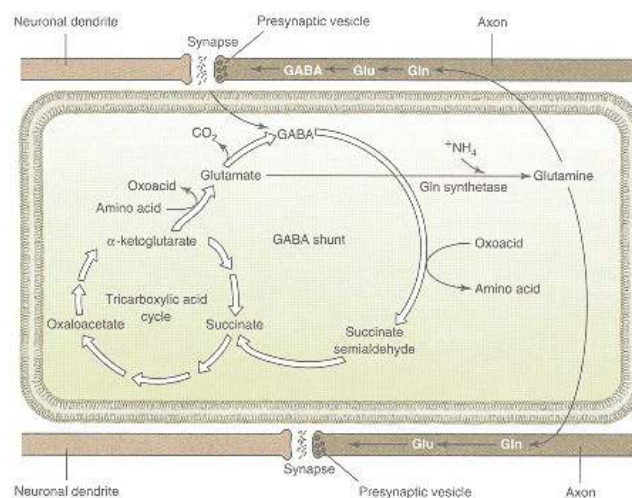

Figure 22.14
Involvement of the astrocytes in the metabolism of GABA and glutamate.

TABLE 22.3 Peptides Found in Brain Tissue^a

Peptide	Structure
β -endorphin	YGGFM TSEK SQTPLVT LFKNA I IKNAYKKGE
Met-enkephalin	YGGFM
Leu-enkephalin	YGGFL
Somatostatin	A G C K N F F W C S T F T K
Luteinizing hormone-releasing hormone	p-EHWSYGLRPG-NH ₂
Thyrotropin-releasing hormone	p-EHP-NH ₂
Substance P	RPKPEEFGLM-NH ₂
Neurotensin	p-ELYENKPRRPYIL
Angiotensin I	DRVYIHPFHL
Angiotensin II	DRVYIHPF
Vasoactive	HSDAVFTDNYTRLR
intestinal peptide	KEMAVKKYLN SILN-NH ₂

^a Peptides with p preceding the structure indicate that the N terminal is pyroglutamate. Those with NH₂ at the end indicate that the C terminal is an amide.

physiological conditions, and the upper limit is probably hours rather than days. Recent experiments suggest that the faster transit times prevail.

Neuropeptides mediate **sensory and emotional responses** such as those associated with hunger, thirst, sex, pleasure, and pain. Included in this category are **enkephalins, endorphins, and substance P**. Substance P is an excitatory neurotransmitter that has a role in pain transmission, whereas endorphins have roles in eliminating the sensation of pain. Some of the peptides found in brain tissue are shown in Table 22.3. Note that Met-enkephalin is derived from the N-terminal region of β -endorphin. The N-terminal or both the N- and C-terminal amino acids of many of the neuropeptide transmitters are modified. For a further discussion of these peptides, see Chapter 20.

22.3—

The Eye:

Metabolism and Vision

The eye, our window to the outside world, allows us to view the beauties of nature, the beauties of life, and, *vide* this textbook, the beauties of biochemistry. What are the features of this organ that permit this view? A view through any window, through any camera lens, is clearest when unobstructed. The eye has evolved in such a way that a similar objective has been achieved. It is composed of live tissues that require continuous nourishment for survival. Energy and metabolites for growth and maintenance are derived from nutrients by conventional biochemical mechanisms, but the structures responsible for these processes are arranged and distributed such that they do not interfere with the visual process. Also, the brain has devised an enormously efficient filtering system that makes invisible objects within the eye that may appear to lead to visual distortion. In addition, different tissues use specific metabolic pathways to accommodate their unique needs. A schematic diagram of a cross section of the eye is shown in Figure 22.15.

Light entering the eye passes progressively through the **cornea**; the anterior chamber, which consists of the **aqueous humor**; the lens; the vitreous body, which consists of the **vitreous humor**; and finally focuses on the **retina**, which contains the visual sensing apparatus. The exterior of the cornea is bathed by

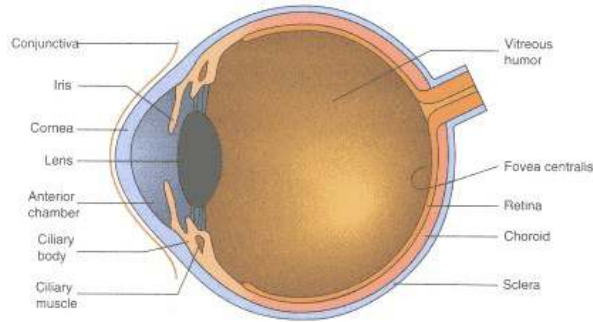

Figure 22.15
Schematic of a horizontal section of the left eye.

tears, while the interior is bathed by the aqueous humor, an iso-osmotic fluid containing salts, albumin, globulin, glucose, and other constituents. The aqueous humor brings nutrients to the cornea and to the lens, and it removes end products of metabolism from them. The vitreous humor is a collagenous or gelatinous mass that helps maintain the shape of the eye while allowing it to remain somewhat pliable.

The Cornea Derives ATP from Aerobic Metabolism

The eye is an extension of the nervous system, and like other tissues of the central nervous system, the major metabolic fuel is glucose. The cornea, which is not a homogeneous tissue, obtains a relatively large percentage of its ATP from aerobic metabolism. About 30% of glucose used by the cornea is metabolized by glycolysis and about 65% by the **hexose monophosphate pathway**. On a relative weight basis, the cornea has the highest activity of the hexose monophosphate pathway of any other mammalian tissue. It also has a high activity of **glutathione reductase**, an activity that requires NADPH, a product of the hexose monophosphate pathway. Corneal epithelium is permeable to atmospheric oxygen, that is necessary for various oxidative reactions. The reactions of oxygen can result in the formation of various **active oxygen species** that are harmful to the tissues, perhaps in some cases by oxidizing protein sulfhydryl groups to disulfides. Reduced glutathione (GSH) is used to reduce those disulfide bonds back to their original native states while GSH itself is converted to oxidized glutathione (GSSG). Furthermore, oxidized glutathione (GSSG) may also be formed by auto-oxidation. Glutathione reductase uses NADPH to reduce GSSG to 2GSH.



The activities of the hexose monophosphate pathway and the glutathione reductase maintain this tissue in an appropriately reduced state by effectively neutralizing the active oxygen species.

Lens Consists Mostly of Water and Protein

The **lens** is bathed on one side by the aqueous humor and supported on the other side by the vitreous humor. The lens has no blood supply, but it is metabolically active. It gets nutrients from the aqueous humor and eliminates waste into the aqueous humor. The lens is mostly water and proteins. The majority of the proteins are the **α -, β -, and γ -crystallins**. There are also albuminoids, enzymes, and membrane proteins that are synthesized in an epi-

TABLE 22.4 Eye Lens Crystallins and Their Relationships with Other Proteins

Crystallin	Distribution	[Related] or Identical
α	All vertebrates	Small heat shock proteins (αB) [<i>Schistosoma mansoni</i> antigen]
β	All vertebrates	[<i>Myxococcus xanthus</i> protein S]
γ	(embryonic γ not in birds)	[<i>Physarum polycephalum</i> spherulin 3a]
Taxon-specific enzyme crystallins		
	Most birds, reptiles	Argininosuccinate lyase (2)
	Crocodiles, some birds	Lactate dehydrogenase B
	Guinea pig, camel, llama	NADPH: quinone oxidoreductase
	Elephant shrew	Aldehyde dehydrogenase I

Source: Wistow, G. *TIBS* 18:301, 1993.

thelial layer around the edge of the lens. Some other types of proteins that are found in lens, including the lens of species other than vertebrates, are shown in Table 22.4. This shows that lens proteins may have different genetic origins and functions in other tissues. The most important physical requirement of these proteins is that they maintain a clear crystalline state. The center area of the lens, the core, consists of the lens cells that were present at birth. The lens grows from the periphery (Figure 22.16). The human lens increases in weight and thickness with age and becomes less elastic. This is accompanied by a loss of near vision (Table 22.5); a condition referred to as **presbyopia**. On average the lens may increase threefold in size and approximately 1 1/2-fold in thickness from birth to about age 80.

Lens proteins must be maintained in a native unaggregated state. They are sensitive to various insults such as changes in oxidation–reduction state, osmolarity, excessively increased concentrations of metabolites, and physical insults such as UV irradiation. Reactions that help maintain structural integrity of the lens are the Na^+ , K^+ –ATPase for osmotic balance, glutathione reductase for redox state balance, and protein synthesis for growth and maintenance. Energy for these processes comes from the metabolism of glucose. About 85% of the glucose metabolized by the lens is by glycolysis, 10% by the hexose monophosphate pathway, and 3% by the tricarboxylic acid cycle, presumably by the cells located at the periphery.

Cataract is the only known disease of the lens. Cataracts are opacities of lenses brought about by a loss of osmolarity and a change in solubility of some

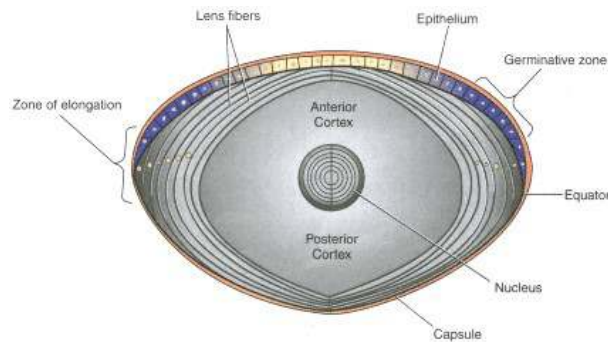

Figure 22.16
Schematic representation of a meridional section of a mammalian lens.

of the proteins, resulting in regions of high light scatter. Cataracts affect about 1 million people per year in the United States, and there are no known cures or preventative measures. The remedy is lens replacement, a very common operation in the United States. There are basically two types of cataracts: **senile cataracts** and **diabetic cataracts**. Both are the result of changes in the solubility and aggregation state of the lens crystallins. In senile cataracts, changes in the architectural arrangement of the lens crystallins are age-related and due to such changes as breakdown of the protein molecules starting at the C-terminal ends, deamidation, and racemization of aspartyl residues. Diabetic cataracts result from loss in osmolarity of the lens due to the activity of **aldose reductase** and **polyol (aldose) dehydrogenase** of the polyol metabolic pathway. When the glucose concentration in the lens is high, aldose reductase reduces some of it to **sorbitol** (Figure 22.17), which may be converted to **fructose** by polyol dehydrogenase. In human lens, the ratio of activities of these two enzymes favors sorbitol accumulation, especially since sorbitol is not used otherwise, and it diffuses out of the lens rather slowly. Accumulation of sorbitol in the lens increases osmolarity of the lens, affects the structural organization of the crystalline proteins within the lens, and enhances the rate of protein aggregation and denaturation. The areas where this occurs will have increased light scattering properties—which is the definition of cataracts. Normally, sorbitol formation is not a problem because the K_m of aldose reductase for glucose is about 200 mM and very little sorbitol would be formed. In diabetics, where the circulating concentration of glucose is high, activity of this enzyme can be significant.

TABLE 22.5 Changes in Focal Distance with Age

Age	Focal Distance (in.)
10	2.8
20	4.4
35	9.8
45	26.2
70	240.0

Source: Adapted from Koretz, J. F., and Handelman, G. H. *Sci. Am.*, 92, July 1988.

The Retina Derives ATP from Anaerobic Glycolysis

The **retina**, like the lens, depends heavily on anaerobic glycolysis for ATP production. Unlike the lens, the retina is a vascular tissue, but there are essentially no blood vessels in the area where visual acuity is greatest, the **fovea centralis** (see Clin. Corr. 22.3). Mitochondria are present in the retina, including in the rods and in the cones. There are no mitochondria in the outer segments of the rods and cones where the visual pigments are located.

NADH produced during glycolysis can be used to reduce pyruvate to lactate. The lactate dehydrogenase of the retina can use either NADH or NADPH, the

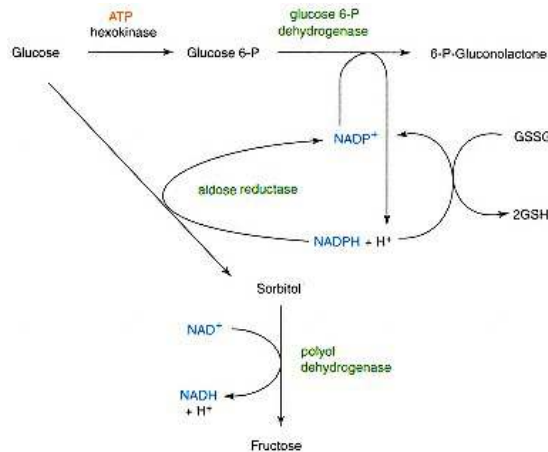

Figure 22.17 Metabolic interrelationships of lens metabolism.

CLINICAL CORRELATION 22.3**Macula Degeneration: Other Causes of Vision Loss**

Many diseases of the eye affect vision, not all of which have clear, direct biochemical origins. The most serious eye diseases are those that result in blindness. Glaucoma is the most common and there is a direct causal relationship with diabetes, the biochemistry of which is fairly well known. Glaucoma can be treated and blindness does not have to be a result.

Macula degeneration leads to blindness and there is no cure. The macula is a circular area of the retina, the center of which is the fovea centralis, the area containing the greater concentration of cones and the one of greatest visual acuity. Macula degeneration may be among the leading causes of blindness in people over the age of 50. Macula degeneration is of two types: dry and wet. The dry form develops gradually over time, whereas the wet form develops rapidly and can lead to blindness within days. Macula degeneration occurs when blood vessels rupture under the macula, leading to a loss of the nutrient supply and a rapid loss of vision. Experimental procedures are in progress to surgically remove scar tissue that develops and to transplant tissue from the rear of the eye to restore nourishment to the photoreceptor cells.

Rupture of blood vessels that obscure macula details and result in rapid onset of blindness may be temporary in some cases. Six cases of sudden visual loss associated with sexual activity have been reported that are not associated with a sexually transmitted disease. Vision was lost in one eye apparently during, but most often reported a few days after engaging in, "highly stimulatory" sexual activity. Blindness was due to rupture of blood vessels in the macula area. When patients did see an ophthalmologist, most were reluctant to discuss what they were doing when sight loss was first observed. Four of the patients recovered with restoration of vision upon reabsorption of blood. In one case, where blood was trapped between the vitreous gel and the retinal surface directly in front of the fovea, the hemorrhage cleared only slightly during the next month, but visual acuity did not improve. The patient did not return for a follow-up examination, but there was no indication that the condition was permanent. Since most of the persons affected by this phenomenon were over the age of 39, it may be a worry more to professors than to students. It also may give a new meaning to the phrase "love is blind."

Friberg, T. R., Braunstein, R. A., and Bressler, N. M. *Arch. Ophthalmol.* 113:738, 1995.

latter being formed from the hexose monophosphate pathway. It is not clear whether lactate dehydrogenase of the retina plays any substantial role in mediating the regulation of glucose metabolism through either of these pathways by its selective use of NADH or NADPH.

Visual Transduction Involves Photochemical, Biochemical, and Electrical Events

Figure 22.18 shows an electron micrograph and schematic of the retinal membrane. Light entering the eye through the lens passes the optic nerve fibers, the ganglion neurons, the bipolar neurons, and the nuclei of the rods and cones before it reaches the outer segment of the rods and cones where the **signal transduction** process begins. The **pigmented epithelial** layer of the eye, the choroid, lies behind the retina, absorbs the excess light, and prevents reflections back into the rods and cones where it may cause distortion or blurring of the image (see Clin. Corr. 22.4).

The eye may be compared with a video camera. The camera collects images, converts them into electrical pulses, records them on magnetic tape, and allows their visualization by decoding the taped information. The eye focuses on an image by projecting that image onto the retina. A series of events begins, the first of which is photochemical, followed by biochemical events that amplify the signal, and finally electrical impulses are sent to the brain where the image is reconstructed in "the mind's eye." During this process, the initial event has been transformed from a physical event to a chemical reaction, through a series of biochemical reactions, to an electrical event, to a conscious acknowledgment of the presence of an object in the environment outside the body.

When photons of light enter the eye and are absorbed by photoreceptors in the **outer segments of rods or cones**, they cause isomerization of the visual pigment, **retinal**, from the 11-*cis* form to the all-*trans* form. This isomerization causes a conformation change in the protein moiety of the complex and affects the resting membrane potential of the cell, resulting in an electrical signal being

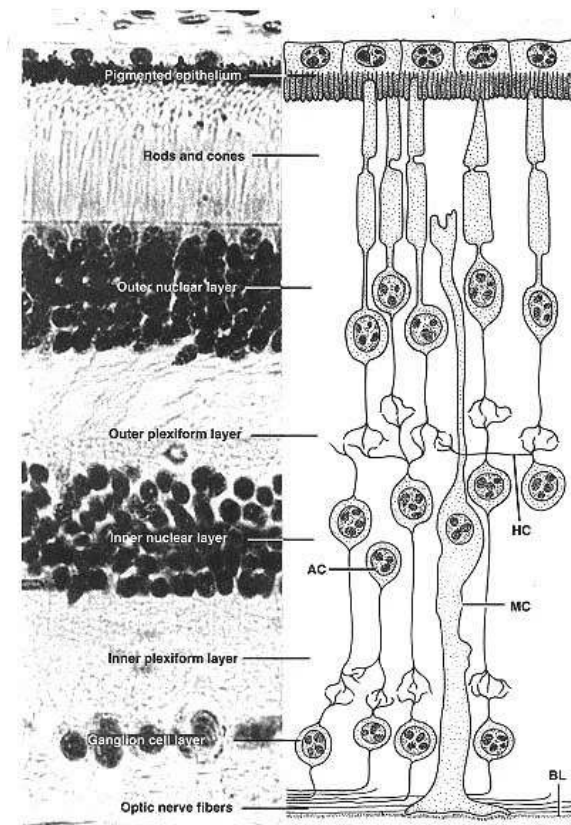

Figure 22.18

Electron micrograph and schematic representation of cells of the human retina.

Tips of rods and cones are buried in the pigmented epithelium of the outermost layer. Rods and cones form synaptic junctions with many bipolar neurons, which in turn form synapses with cells in the ganglion layer that send axons through the optic nerve to the brain. The synapse of a rod or cone with many cells is important for the integration of information. HC, horizontal cells; AC, amacrine cell; MC, Müller cell; BL, basal lamina.

Reprinted with permission from Kessel, R. G., and Kardon, R. H., *Tissues and Organs: A Text-Atlas of Scanning Electron Microscopy*. New York: W. H. Freeman, 1979, p. 87.

transmitted by way of the optic nerve to the brain. These processes will be discussed later in more detail.

Photoreceptor Cells Are Rods and Cones

The **photoreceptor cells** of the eye are the **rods** and the **cones** (Figure 22.18). Each type has flattened disks that contain a photoreceptor pigment. This pigment is **rhodopsin** in the rod cells, and **red, green, or blue pigment** in the cone cells. Rhodopsin is a transmembrane protein to which is bound a prosthetic group, **11-*cis*-retinal**. Rhodopsin minus its prosthetic group is **opsin**. The three proteins that form the red, green, and blue pigments of cone cells are different from each other and from opsin.

Rhodopsin, an approximately 40-kDa protein, contains seven transmembrane α -helices. The 11-*cis*-retinal is attached through a protonated Schiff base to the amino group of lysine-296 on the seventh helix. Lysine-296 lies about midway between the two faces of the membrane (Figure 22.19a). A 9-Å resolution three-dimensional (3-D) model for rhodopsin, obtained by cryomicroscopy, shows that most of the helices are perpendicular to the surface of the membrane

CLINICAL CORRELATION 22.4

Niemann–Pick Disease and Retinitis Pigmentosa

There are central nervous system disorders associated with the Niemann–Pick group of diseases that can become evident by ocular changes. Some of these are observed as abnormal macula with gray discoloration and granular pigmentation or granule opacities about the fovea.

Acute type I Niemann–Pick disease, lipidosis with sphingomyelinase deficiency and primary sphingomyelin storage, may show a cherry red spot in the retina in as many as 50% of patients. Macula halo syndrome applies to the crystalloid opacities seen in some patients with subacute type I disease. They form a halo approximately one-half the disk diameter at their outer edge and are scattered throughout the various layers of the retina. They do not interfere with vision.

In an 11-year-old girl who had type II disease, more extensive ocular involvement was observed. There was sphingomyelin storage in the keratocytes of the cornea, the lens, the retinal ganglion cells, the pigmented epithelium, the corneal tract, and the fibrous astrocytes of the optic nerve.

Retinitis pigmentosa is a secondary effect of the abnormal biochemistry associated with Niemann–Pick disease.

Spence, M. W., and Callahan, J. W. In: C. R. Scriver, A. L. Beaudet, W. Sly, and D. Valle (Eds.), *The Metabolic Basis of Inherited Disease*, New York: McGraw-Hill, 1989, pp. 1656–1676.

(Figure 22.19b). Some, however, are distorted from this perpendicular arrangement. It is not known whether the orientation of those distorted helices is associated with binding of 11-*cis*-retinal since this low-resolution structure will not permit tracing of the carbon backbone structure of rhodopsin. See also Clin. Corr. 22.5.

Reactions involved in the formation of 11-*cis*-retinal from β -carotene and rhodopsin from opsin and 11-*cis*-retinal are shown in Figure 22.20. The 11-*cis*-retinal is derived from **vitamin A** and/or β -carotene of the diet. These are

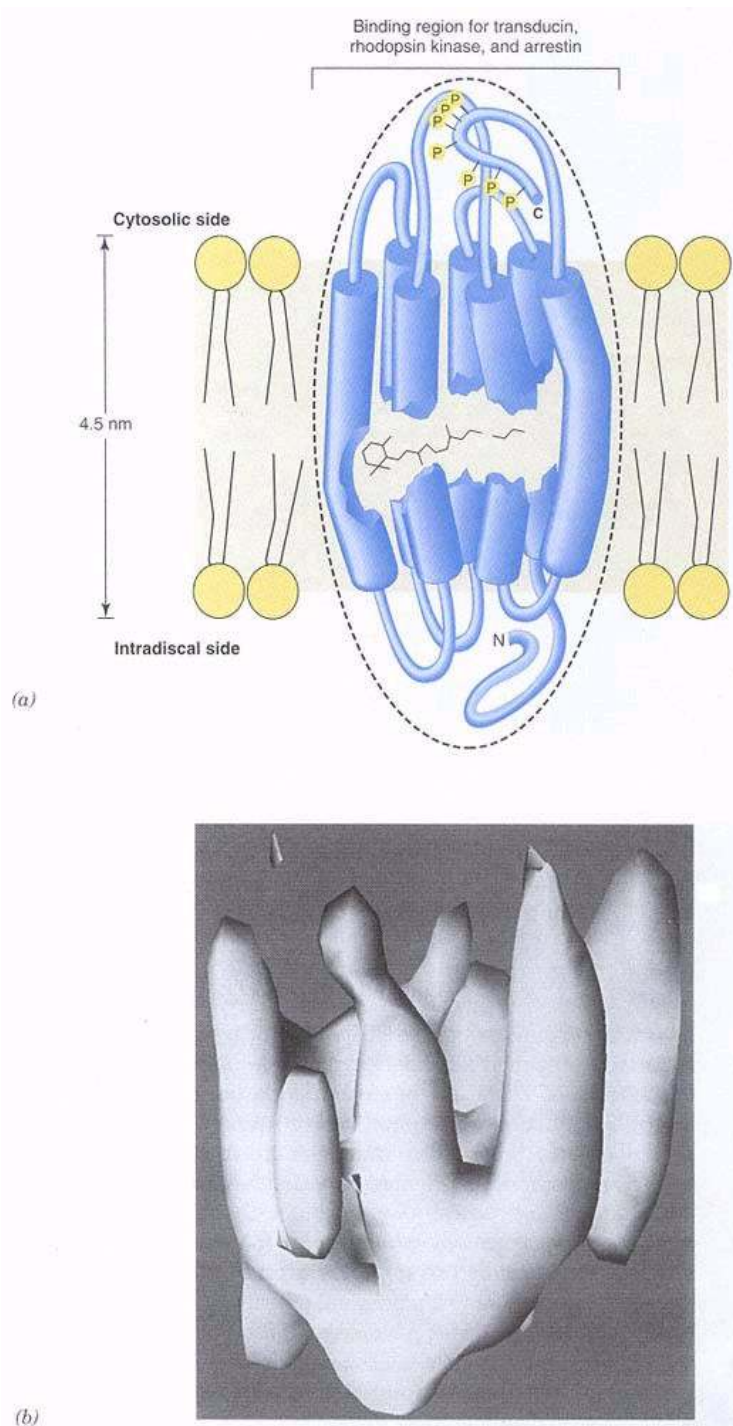

Figure 22.19
Rhodopsin.

- (a) A model of the structure of vertebrate rhodopsin.
 (b) A 9-Å resolution 3-D model for rhodopsin obtained by cryomicroscopy.
 (a) Redrawn from Stryer, L. *Annu. Rev. Neurosci.* 9:87, 1986 (based on Dratz and Hargrave, 1983).
 (b) Reproduced with permission from Unger, V. M. and Schertler, G. F. X. *Biophys. J. J.* 68:1776, 1995. Photograph generously supplied by Dr. G. F. X. Schertler.

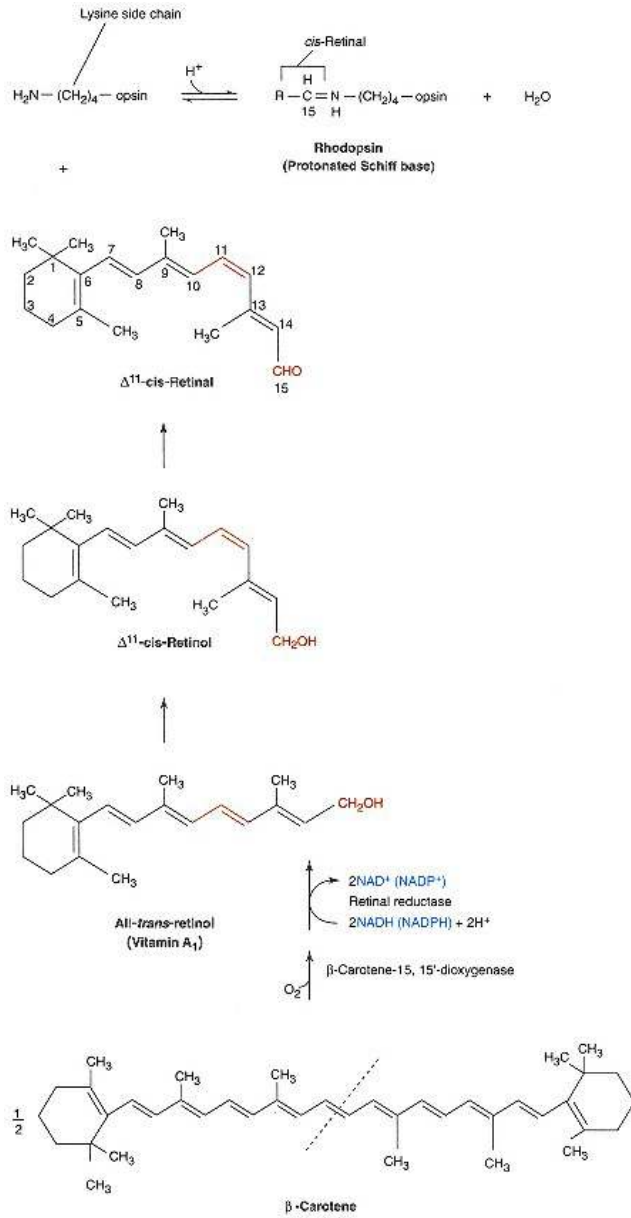

Figure 22.20
Formation of 11-cis-retinal and rhodopsin from β -carotene.

CLINICAL CORRELATION 22.5

Retinitis Pigmentosa Resulting from a *De Novo* Mutation in the Gene Coding for Peripherin

A group of heterogeneous diseases of variable clinical and genetic origins have been placed under the category of retinitis pigmentosa (RP). Several of these have origins in abnormal lipid metabolism. Approximately 1.5 million people throughout the world are affected by this disease. It is a slowly progressive condition associated with loss of night and peripheral vision. It can be inherited through an autosomal dominant, recessive, or X-linked mode. RP has been associated with mutations in the protein moiety of rhodopsin and in a related protein, peripherin/RDS, both of which are integral membrane proteins. Peripherin is a 344 amino acid residue protein located in the rim region of the disk membrane. Structural models of these two proteins are shown in the figure below. Filled circles and other notations in the figure mark residues or regions that have been correlated with RP or other retinal degenerations.

A case has been described where a *de novo* mutation in exon 1 of the gene coding for peripherin resulted in the onset of RP. Using molecular biological techniques, Lam et al. (1995) found the specific change in peripherin to be a C-to-T transition in the first nucleotide of codon 46. This resulted in changing an arginine to a stop codon (R46X). The pedigree of this family is shown in the figure on next page. Neither parent had the mutation and genetic typing analysis (20 different short tandem repeat polymorphisms) showed that the probability that the proband's parents are not his actual biological parents is less than 1 in 10 billion. This establishes with near certainty that the mutation is *de novo*.

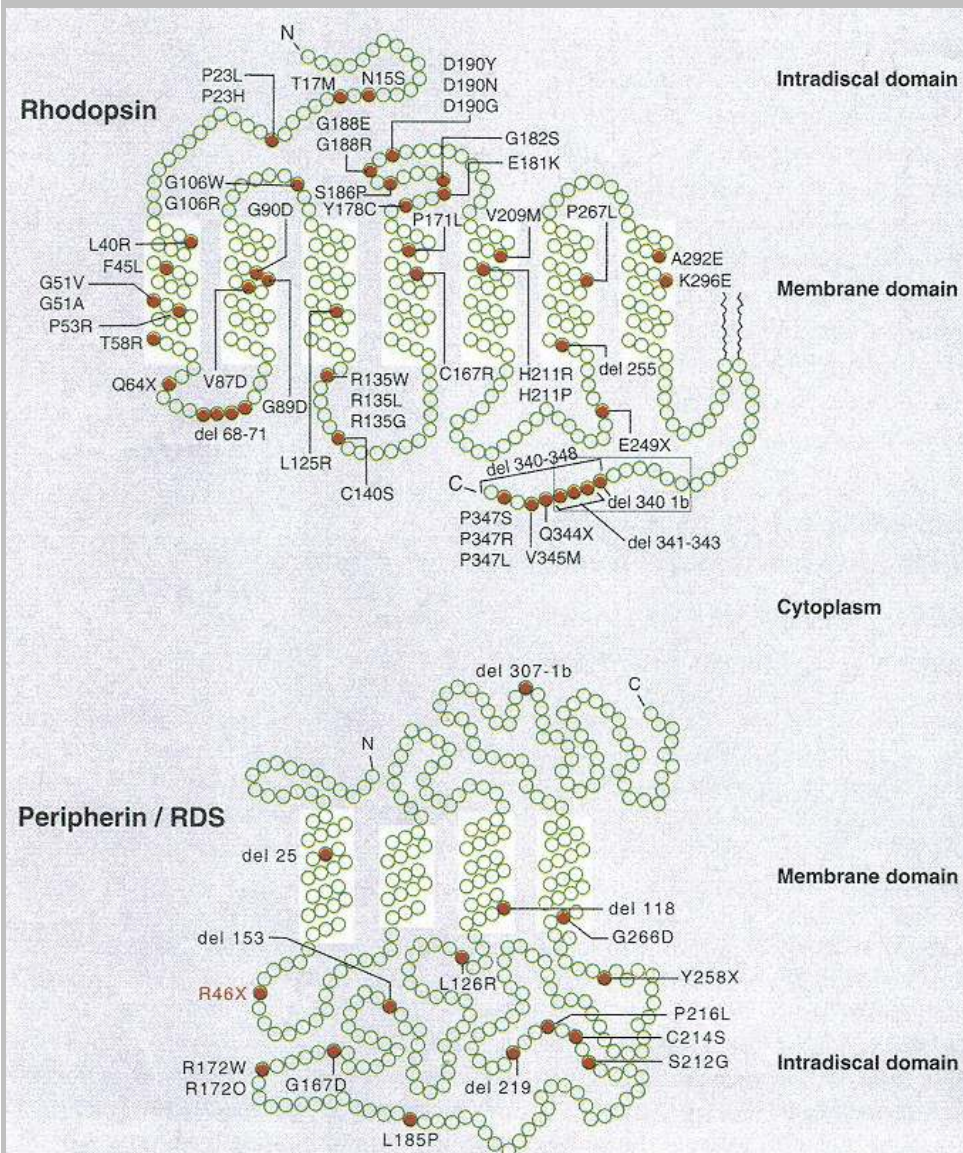

Schematic representation of structural models for rhodopsin (top) and peripherin/RDS (bottom). The location of mutations in amino acid residues that segregate with RP or other retinal degenerations are shown as solid red circles.

(Table continued on next page)

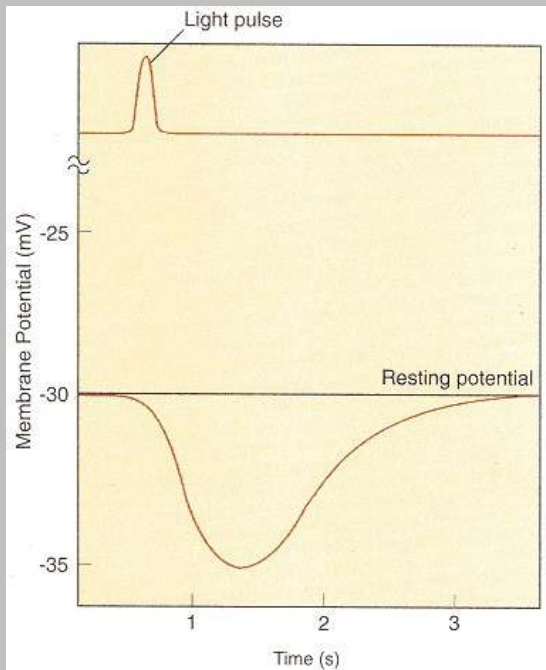

Pedigree of family.
Males are squares, females are circles.
Solid square indicates the proband.
A slash through a symbol indicates deceased.
From Lam et al. (1995).

This R46X mutation has been observed in another unrelated patient. These observations demonstrate the importance of the use of DNA analysis to establish the genetic basis for RP, especially considering that RP symptoms have been associated with a variety of other diseases, such as those related to abnormal lipid metabolism.

Shastry, B. S. *Am. J. Med. Genet.* 52:467, 1994; and Lam, B. L., Vandenburg, K., Sheffield, V. C., and Stone, E. M. *Am. J. Ophthalmol.* 119:65, 1995.

transported to specific sites in the body while attached to specific carrier proteins. Cleavage of β -carotene yields two molecules of **all-trans-retinol**. There is an enzyme in the pigmented epithelial cell layer of the retina that catalyzes the isomerization of all-trans-retinol to **11-cis-retinol**. Oxidation of the 11-cis-retinol to 11-cis-retinal and its binding to opsin occur in the rod outer segment.

The absorption spectra of 11-cis-retinal and the four visual pigments are shown in Figure 22.21. There is a shift in the wavelength of maximum absorption of 11-cis-retinal upon binding to opsin and the protein components of the other visual pigments. Absorption bands for the pigments are coincident with their light sensitivity.

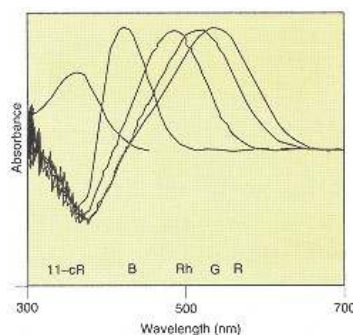

Figure 22.21
Absorption spectra of 11-cis-retinal and the four visual pigments.
Absorbance is relative and was obtained for pigments as difference spectra from reconstituted recombinant apoproteins. The spectrum for 11-cis-retinal (11-cR) is in the absence of protein. B, blue pigment; Rh, rhodopsin; G, green; R, red.
Adapted from Nathans, *J. Cell*, 78:357, 1994.

The magnitude of change in the electrical potential of photoreceptor cells following exposure to a light pulse is different in magnitude from that of neurons during depolarization. The **resting potential** of rod cell membrane is approximately **-30 mV** instead of the **-70 mV** observed with neurons. Excitation of rod cells causes **hyperpolarization** of the membrane, from about **-30 mV** to about **-35 mV** (Figure 22.22). It takes hundreds of milliseconds for the potential to reach its maximum state of hyperpolarization. A number of biochemical events take place during this time interval and before the potential returns to its resting state.

The initial events, absorption of photons of light and the subsequent isomerization of 11-cis-retinal, are rapid, requiring only picoseconds. Following this, a series of changes take place in rhodopsin, leading to various short-lived conformational states (Figure 22.23), each of which has specific absorption characteristics. Finally, rhodopsin dissociates, giving opsin and all-trans-retinal.

At 37°C, activated rhodopsin has decayed in slightly more than 1 millisecond through several intermediates to **metarhodopsin II**. Metarhodopsin II has a half-life of approximately 1 minute. It is the **active rhodopsin** species, **R***, that is involved in the biochemical reactions of interest. Metarhodopsin II will have begun to form within hundredths of microseconds of the initial event. All of the first series of reactions shown in Figure 22.23 take place in the disk of the

rod outer segment. Upon dissociation of metarhodopsin into opsin and all-*trans*-retinal, the all-*trans*-retinal is enzymatically converted to all-*trans*-retinol by **all-*trans*-retinol dehydrogenase** that is located in the rod outer segment. All-*trans*-retinol is transported (or diffuses) into the pigmented epithelium where a specific isomerase converts it to 11-*cis*-retinol. The 11-*cis*-retinol is then transported (or diffuses) back into the rod outer segment and is reoxidized to 11-*cis*-retinal. Since the all-*trans*-retinol dehydrogenase appears to have only about 6% as much activity with 11-*cis*-retinol, it appears that another enzyme may be responsible for its oxidation. Once the aldehyde is formed, it can recombine with opsin to form rhodopsin. Rhodopsin is now in a state to begin the cycle again. The same events take place in the cones with the three proteins of the red, green, and blue pigments.

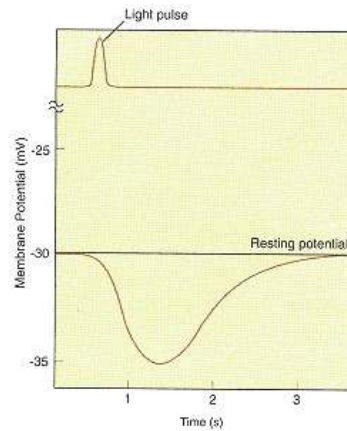

Figure 22.22
Changes in the potential of a rod cell membrane after a light pulse.
Redrawn from Darnell, J., Lodish, H., and Baltimore, D. *Molecular Cell Biology*. New York: Scientific American Books, 1986, p. 763.

There are three interconnecting "mini" biochemical cycles involved in the conversion of light energy to nerve impulses (Figure 22.24). These cycles describe the reactions of rhodopsin, **transducin**, and **phosphodiesterase**, respectively. The net result of their operation is to cause a hyperpolarization of the plasma membrane of the rod (or cone) cells, that is, from -30 mV to approximately -35 mV. It is important to understand first what the biochemical mechanism is for maintaining the plasma membrane at -30 mV.

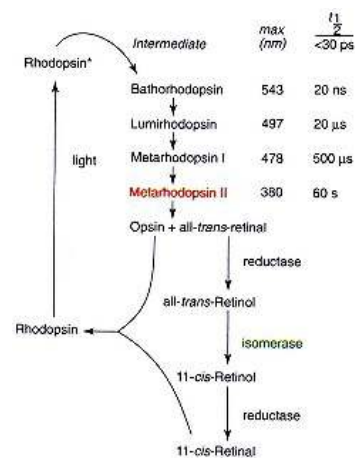

Figure 22.23
Light activation of rhodopsin.

Rod cells of a fully dark-adapted human can detect a flash of light that emits as few as 50 photons. The rod is a specialized type of neuron in that the signal generated does not depend on an all-or-none event. The signal may be graded in intensity, reflected by the extent that the millivolt potential of the plasma membrane changes from its steady-state value of -30 mV. This **steady-state potential** is maintained at a more positive value because **Na⁺ channels** of the photoreceptor cells are **ligand gated** and are maintained in a partially opened state. The ligand responsible for keeping some of the Na⁺ channels open is **cyclic GMP (cGMP)**. cGMP binds to them in a concentration-dependent, kinetically dynamic manner. Biochemical events that affect the concentration of cGMP within rod and cone cells also affect the number of Na⁺ channels that are open and, hence, the membrane potential (Figure 22.24).

Active rhodopsin (R^* , namely, metarhodopsin II) forms a complex with transducin. Transducin is a classical type of **G-protein** and functions in a manner very similar to that described on page 859 in relation to the action of some hormones. In the R^* -transducin complex ($R^*T_{\alpha,\beta,\gamma}$ complex), transducin undergoes a conformation change that facilitates an exchange of its bound **GDP** with **GTP**. When this occurs, the α subunit (T_α) of the trimeric molecule dissociates from its β , γ subunits. T_α interacts with and activates **phosphodiesterase (PDE)**, which hydrolyzes cGMP to 5'-GMP, resulting in a decreased concentration of cGMP and a decrease in the number of channels held open. The membrane potential becomes more negative, that is, hyperpolarized.

The diagram of Figure 22.24 shows in cartoon form two such channels embedded in the plasma membrane, one of which has cGMP bound to it and is open. The other does not have cGMP bound to it and it is closed. By this mechanism, the concentration of Na⁺ in the cell is directly linked to the concentration of cGMP and, thus, also to the membrane potential.

PDE in rod cells is a **heterotetrameric protein** consisting of one each α and β catalytic subunits and two γ regulatory subunits. T_α -GTP forms a complex with the γ subunits of PDE, resulting in their dissociation from the catalytic subunits, freeing the catalytically active α,β -dimeric PDE subunit complex. T_α has GTPase activity. Hydrolysis of bound GTP to GDP and inorganic phosphate (P_i) results in dissociation of T_α from the regulatory γ subunits of PDE, permitting them to reassociate with the catalytic subunits and to inhibit the PDE activity. The same reactions occur in cone cells, but the catalytic subunit of cone cell PDE is composed of two α catalytic subunits instead of α,β subunits as are present in rod cells.

cGMP concentration is regulated by intracellular Ca^{2+} concentration. Calcium enters rod cells in the dark through sodium channels, increasing its concen-

tration to the 500-nM range. At these concentrations, activity of **guanylate cyclase** is low. When sodium channels are closed, Ca^{2+} entry is inhibited, but efflux mediated by the sodium/calcium–potassium exchanger is unchanged (top complex of the plasma membrane in Figure 22.24). This results in a decrease in the intracellular Ca^{2+} concentration, which in turn leads to activation of guanylate cyclase and increased production of cGMP from GTP.

Both the resynthesis of cGMP and the hydrolysis of T_α -GTP play important roles in stopping the reactions of the visual cycle. The inactivation of activated rhodopsin, R^* , is also very important.

Activated rhodopsin, R^* , is phosphorylated by **rhodopsin kinase** in the presence of ATP (Figure 22.24). The $\text{R}^*\text{-P}$ has high binding affinity for the cytosolic protein, **arrestin**. The arrestin- $\text{R}^*\text{-P}$ complex is no longer capable of interacting with transducin. The kinetics of arrestin binding to the activated-phosphorylated rhodopsin is sufficiently rapid *in vivo* to stop the cascade of reactions.

Rhodopsin is regenerated through another series of reactions and the cycle can be initiated again by photons of light. Figure 22.23 shows that the series of reactions leading to the regeneration of rhodopsin includes the dissociation of all-*trans*-retinal from metarhodopsin. The regeneration of 11-*cis*-retinal from all-*trans*-retinal occurs by reactions previously described and occurs before it is used again to form rhodopsin.

Major proteins involved in the visual cycle are listed in Table 22.6.

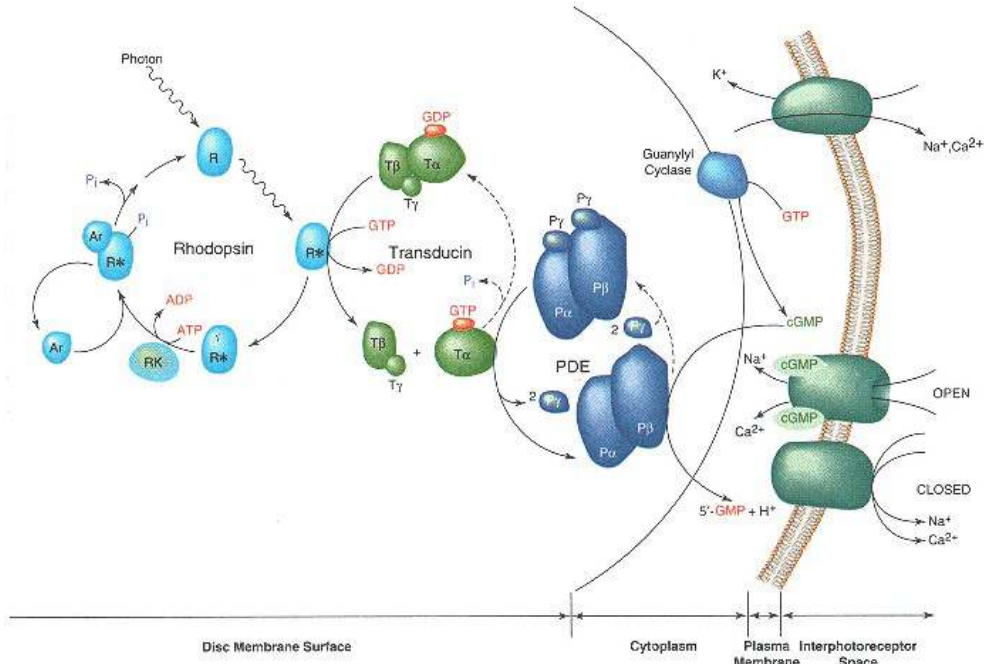

Figure 22.24
Cascade of biochemical reactions involved in the visual cycle.
 Redrawn from Farber, D. B. *Invest. Ophthalmol. Vis. Sci.* 36:263, 1995.

TABLE 22.6 Major Proteins Involved in the Phototransduction Cascade

<i>Protein</i>	<i>Relation to Membrane</i>	<i>Molecular Mass (kDa)</i>	<i>Concentration in Cytoplasm (μM)</i>
Rhodopsin	Intrinsic	39	—
Transducin ($\alpha + \beta + \gamma$)	Peripheral or soluble	80	500
Phosphodiesterase	Peripheral	200	150
Rhodopsin kinase	Soluble	65	5
Arrestin	Soluble	48	500
Guanylate cyclase	Attached to cytoskeleton	?	?
cGMP-activated channel	Intrinsic	66	?

Color Vision Originates in the Cones

Even though there are photographic artists, such as the late Ansel Adams, who make the world look beautiful in black and white, the intervention of colors in the spectrum of life's pictures brings another degree of beauty to the wonders of nature and the beauty of life . . . even the ability to make a distinction between tissues from histological staining. The ability of humans to distinguish colors resides within a relatively small portion of the visual system, the cones. The number of cones within the human eye are few compared with the number of rods. Some animals like dogs have even fewer cones, and other animals, like birds, have many more.

The general mechanism by which light stimulates cone cells is exactly the same as it is for rod cells. There are **three types of cone cells**, defined by the visual pigments they contain, which are either blue, green, or red. Normally, only one type of visual pigment occurs in a single cell. The blue pigment has optimum absorbance at 420 nm, the green pigment at 535 nm, and the red pigment at 565 nm (Figure 22.21). Each of these pigments has 11-*cis*-retinal as the prosthetic group, and, when activated by light, the 11-*cis*-retinal isomerizes to all-*trans*-retinal in exactly the same manner as it does in the rod cells. Colors other than those of the visual pigments are distinguished by graded stimulation of the different cones and comparative analysis by the brain. Color vision is **trichromatic**.

The characteristic of color discrimination by cone cells is an inherent property of the proteins of the visual pigments to which the 11-*cis*-retinal is attached. The 11-*cis*-retinal is attached to each of the proteins through a protonated Schiff base. The conjugated double-bond system of 11-*cis*-retinal influences the absorption spectrum of the pigment (Figure 22.21). When 11-*cis*-retinal is bound to different visual proteins, amino acid residues in the local areas around the protonated base and the conjugated π -bond system influence the energy level and give different absorption spectra with absorption maxima that are different for the different color pigments.

Genes for the color pigments have been cloned and their amino acid sequences inferred from the gene sequences. A structural comparison of the sequences of the visual pigments is shown in Figure 22.25. Open circles represent amino acids that are the same, and closed circles represent amino acids that are different. A string of closed circles at either end may represent an extension of the chain of one protein relative to the other. The red and green pigments show the greatest degree of homology, about 96% identity, whereas the degree of homology between different pairs of the others is between 40% and 45%.

Genes encoding the **visual pigments** have been mapped to specific chromosomes (see Clin. Corr. 22.6). The rhodopsin gene resides on the third chromo-

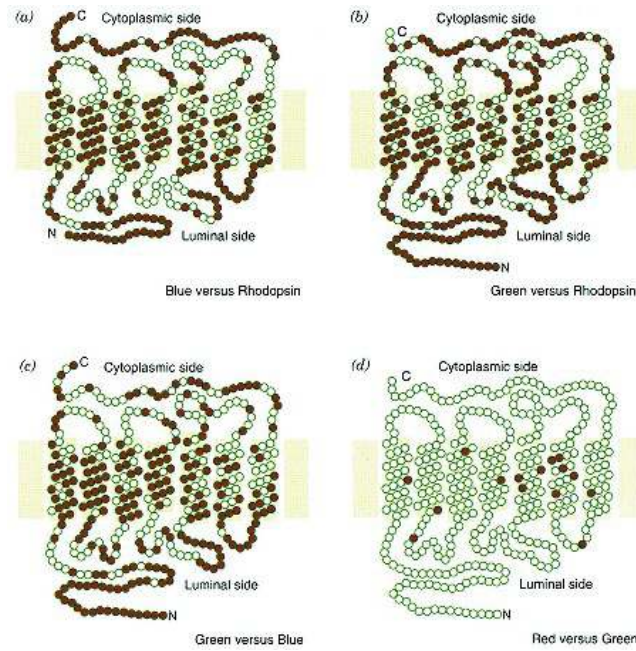

Figure 22.25
Comparisons of the amino acid sequences of the human visual pigments.
 Each red dot indicates an amino acid difference.
 Adapted from Nathans, *J. Annu. Rev. Neurosci.* 10:163, 1987.

some, the gene encoding the blue pigment resides on the seventh chromosome, and the two genes for the red and green pigments reside on the X chromosome. Abnormal color vision results from mutations in one or more of these genes (see Clin. Corr. 22.6). In spite of their great similarity, the red and green pigments are distinctly different proteins. Individuals have been identified with inherited variations that affect one but not both pigments simultaneously. In addition, there may be more than one gene for the green pigment, but it appears that only one is expressed.

The person who developed the atomic theory of chemistry, John Dalton (1766–1844), was color blind. He thought his color blindness was due to the vitreous humor being tinted blue, selectively absorbing longer wavelengths of light. He instructed that after his death his eyes be examined to determine whether his theory was correct. An autopsy revealed that the vitreous humor was "perfectly pellucid," normal. Using DNA analysis on his preserved eyes obtained from the British Museum, it has now been demonstrated that Dalton was missing the blue pigment. Thus, instead of having trichromatic vision, he was dichromatic with a vision type referred to as **deuteranopia**. The type of color blindness of one who is missing the green pigment is **protanopia**.

Other Physical and Chemical Differences between Rods and Cones

The sensitivity and the response time of the rods are different from that of the cones. Absorption of a single photon by photoreceptors in rod cells generates a current of approximately 1–3 picoamperes ($1-3 \times 10^{-12}$ pA), whereas the same event in the cones generates a current of approximately 10 femtoamperes (10×10^{-15} fA), about 1/100th of the rod response. The response time of cone cells, however, is about four times faster than that of rod cells. Thus the cones

CLINICAL CORRELATION 22.6**Abnormalities in Color Perception**

The chromosomal arrangement of genes for vision precludes inheritance of a single defective gene from one parent that would render recipients sightless. Genes that code for visual pigments occur on chromosomes that exist in pairs except in males where there is a single X chromosome containing the genes for red and green pigments. In females, there is a pair of X chromosomes and, therefore, color vision abnormalities in females are rare, affecting only about 0.5% of the population. By contrast, about 8% of males have abnormal color vision that affects red or green perception and, on rare occasions, both. For the sake of simplicity, the proteins coded for by the different genes will be referred to as pigments in spite of the fact that they become visual pigments only when they form complexes with 11-*cis*-retinal.

The gene that codes for the protein moiety of rhodopsin, the rod pigment, is located on the third chromosome. Genes that code for the three pigment proteins of cone cells are located on two different chromosomes. The gene for the blue pigment is on the seventh chromosome. The genes for the red and green pigments are tightly linked and are on the X chromosome, which normally contains one gene for the green pigment and from one to three genes for the red pigment. In a given set of cones, only one of these gene types is expressed, either the gene for the red pigment or one of the genes for the green pigment.

Genetic mutations may cause structural abnormalities in the proteins that influence the binding of retinal or the environment in which retinal resides. In addition, the gene for the protein of a specific pigment may not be expressed. If 11-*cis*-retinal does not bind or one of the proteins is not expressed, the individual will have dichromatic color vision and be color blind for the color of the missing pigment. If the mutation changes the environment around the 11-*cis*-retinal, shifting the absorption spectrum of the pigment, the individual will have abnormal trichromatic color vision; that is, the degree of stimulation of one or more of the three cone pigments will be abnormal. This will result in a different integration of the signal and hence a different interpretation of color.

Vollrath, D., Nathans, J., and Davis, R. W. *Science* 240:1669, 1988; and Nathans, J. *Cell* 78:357, 1994.

are better suited for discerning rapidly changing events and the rods are better suited for low-light visual sensitivity.

22.4—**Muscle Contraction**

On the basis of an extensive evaluation of electron micrographs of skeletal muscle tissue, the **sliding filament model** for muscle contraction was proposed. This simple but eloquent model has weathered the test of time. Genes for many of the proteins found in muscle tissue have been cloned, and the amino acid sequences of the proteins they encode inferred from their cDNA sequences. Three-dimensional structures of some of these proteins have also been published. Although the detailed picture of muscle contraction has not been completed, a clearer understanding of the process is emerging. In this section, some biochemical aspects of the mechanism of muscle contraction will be discussed. Primary emphasis will be on skeletal muscle rather than cardiac and smooth muscles.

Skeletal Muscle Contraction Follows an Electrical to Chemical to Mechanical Path

The signal for skeletal muscle contraction begins with an electrical impulse from a nerve. This is followed by a chemical change occurring within the unit cell of the muscle, and is followed by contraction, a mechanical process. Thus the **signal transduction** process goes from **electrical** to **chemical** to **mechanical**.

Figure 22.26 is a schematic diagram showing the structural organization of skeletal muscle. Muscle consists of bundles of fibers (diagram *c*). Each bundle is called a **fasciculus** (diagram *b*). The fibers are made up of **myofibrils** (diagram *d*), and each myofibril is a continuous series of muscle cells or units called **sarcomeres**. The muscle cell is multinucleated and is no longer capable of division. Most muscle cells survive for the life of the animal, but they can be replaced when lost or lengthened by fusion of **myoblast cells**.

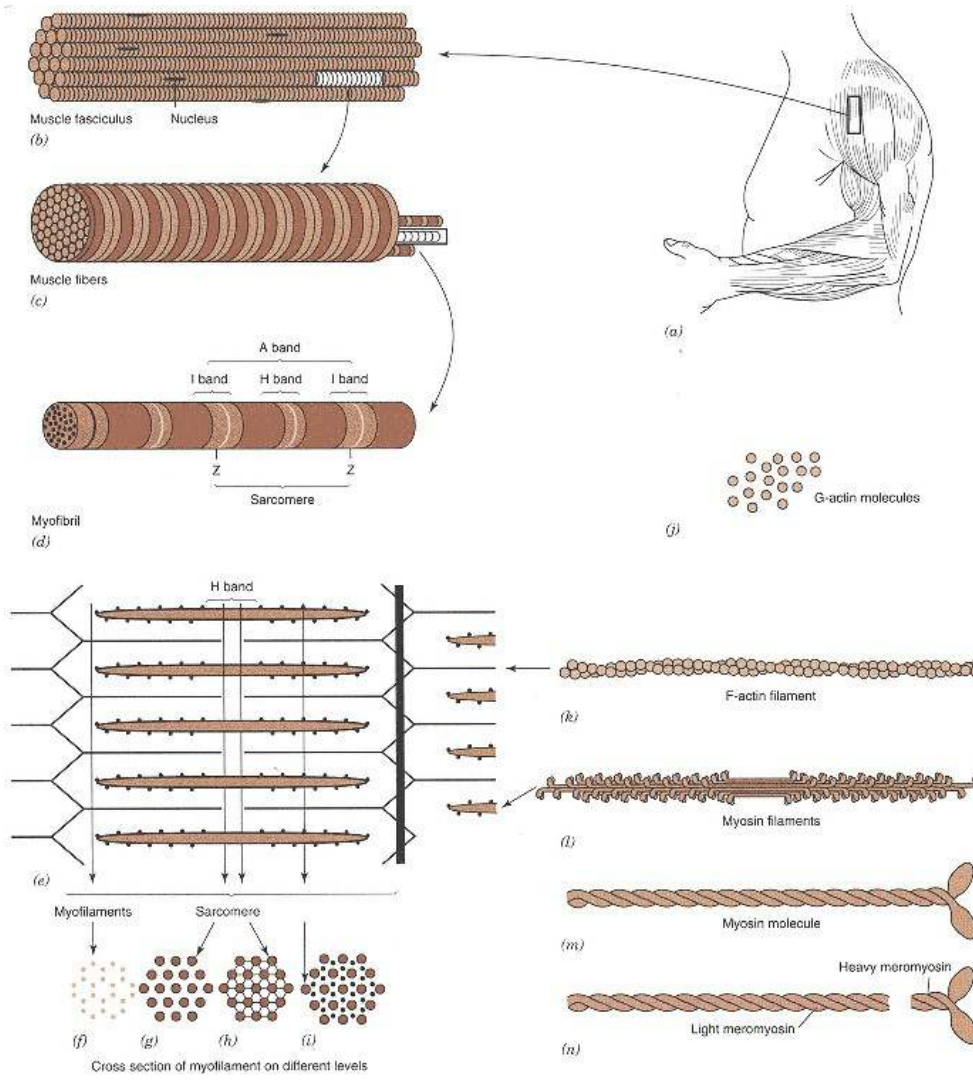

Figure 22.26
Structural organization of skeletal muscle.
 Redrawn from Bloom, W. D., and Fawcett, D. W. *Textbook of Histology*, 10th ed. Philadelphia: Saunders, 1975.

A muscle cell is shown diagrammatically in Figure 22.27. Note that the myofibrils are surrounded by a membranous structure called the **sarcoplasmic reticulum**. At discrete intervals along the fasciculi and connected to the terminal cisterna of the sarcoplasmic reticulum are **transverse tubules**. The transverse tubules are connected to the external plasma membrane that surrounds the

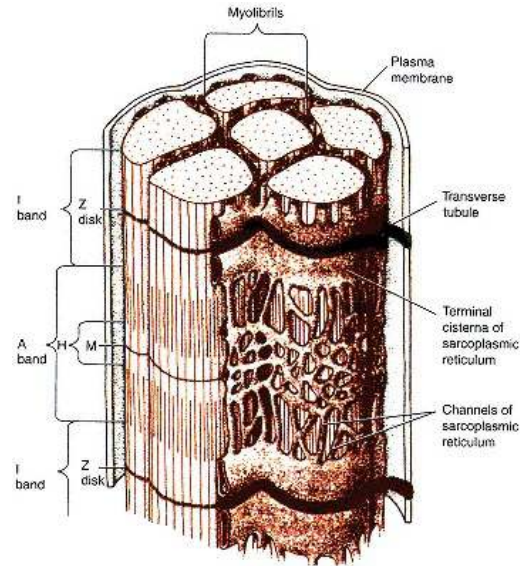

Figure 22.27

Schematic representation of a bundle of six myofibrils.

The lumen of the transverse tubules connects with the extracellular medium and enters the fibers at the Z disk. Reprinted with permission from Darnell, J., Lodish, H., and Baltimore, D. *Molecular Cell Biology*. New York: Scientific American Books, 1986, p. 827.

entire structure. The nuclei and the mitochondria lie just inside the plasma membrane.

The single contractile unit, the sarcomere, extends from Z line to Z line (Figures 22.26d and 22.27). Bands seen in the sarcomere are due to the arrangement of specific proteins (Figure 22.26e). Two types of fibers are apparent: long thick ones with protrusions on both ends lie near the center of the sarcomere, and long thin ones are attached to the **Z line**. The **I band (isotropic)** extends for a short distance on both sides of the Z line. This region contains only **thin filaments** that are attached to a protein band within the Z line. The **H band** is in the center of the sarcomere. There are no thin filaments within this region. In the middle of the H band, there is a somewhat diffuse band due to the presence of other proteins that assist in cross-linking the fibers of the **heavy filaments** (Figure 22.26, pattern h). The **A band (anisotropic)** is located between the inner edges of the I bands. When the muscle contracts, the H and I bands shorten, but the distance between the Z line and the near edge of the H band remains constant. The distance between the innermost edges of the I bands on both ends of the sarcomere also remains constant. This occurs because the length of the thin filaments and the thick filaments does not change during contraction. Contraction therefore results when these filaments "slide" past each other.

TABLE 22.7 Molecular Weights of Skeletal Muscle Contractile Proteins

Myosin	500,000
Heavy chain	200,000
Light chain	20,000
Actin monomer (G-actin)	42,000
Tropomyosin	70,000
Troponin	76,000
Tn-C subunit	18,000
Tn-I subunit	23,000
Tn-T subunit	37,000
α -Actinin	200,000
C-protein	150,000
β -Actinin	60,000
M-protein	100,000

The contractile elements, sarcomeres, consist of many different proteins, eight of which are listed in Table 22.7. The two most abundant proteins in the sarcomere are **myosin** and **actin**. About 60–70% of the muscle protein is myosin and about 20–25% is actin. The thick filament is mostly myosin and the thin filament is mostly actin. Three other proteins listed in Table 22.7 are associated with thin filaments, and two are associated with thick filaments.

Myosin Forms the Thick Filament of Muscle

The schematic drawing of the myosin molecule in Figure 22.28a is a representation of the electron micrographs in Figure 22.28b. Myosin, a long molecule with two globular heads on one end, is composed of two heavy chains of about 230 kDa each. Bound to each heavy chain in the vicinity of the head group is a dissimilar pair of **light chains**, each of which is approximately 20 kDa. The

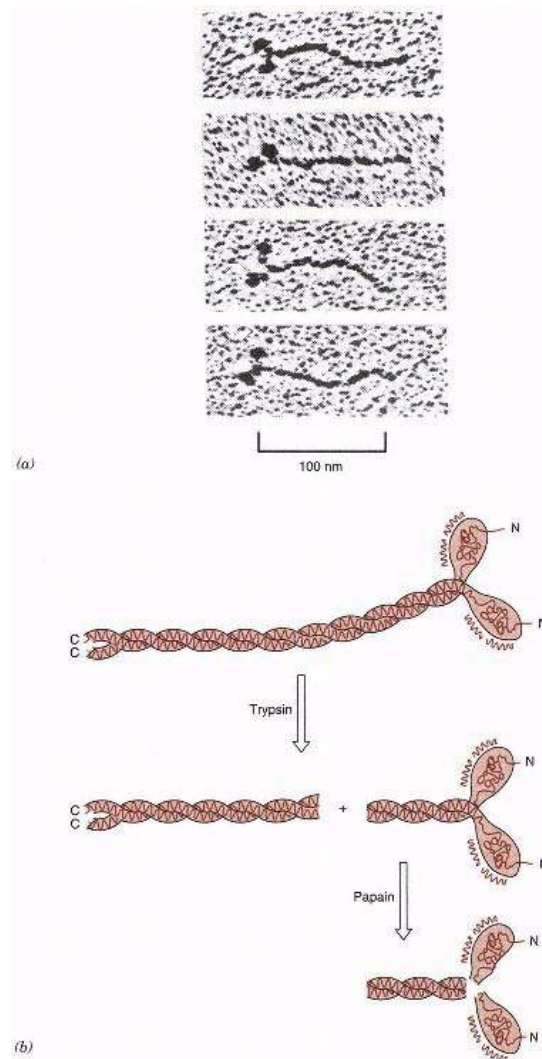

Figure 22.28
Myosin.

(a) Electron micrographs of the myosin molecule.
(b) Schematic drawing of a myosin molecule. Diagram shows the two heavy chains and the two light chains of myosin. Also shown are the approximate positions of cleavage by trypsin and papain.
Reprinted with permission from Alberts, B., Bray, D., Lewis, J., Raff, M., Roberts, K., and Watson, J. *Molecular Biology of the Cell*, 2nd ed. New York: Garland Publishing, 1983.

light chains are "**calmodulin-like**" proteins that bind calcium. One from each myosin can be removed easily without affecting *in vitro* function.

The carboxyl end of myosin is located in the tail section. The tail section of the two heavy chains are coiled around each other in an α -helical arrangement (Figure 22.28a). Trypsin cleaves the tail section at about one-third of its length from the head to produce **heavy meromyosin** (the head group and a short tail) and **light meromyosin** (the remainder of the tail section). Only light meromyosin has the ability to aggregate under physiological conditions, suggesting that aggregation is one of its roles in heavy chain formation. The head section can be separated from the remainder of the tail section by treatment with **papain**. The myosin head group resulting from this cleavage is referred to as **subfragment 1** or **S-1**. Action of these proteases also demonstrates that the molecule has at least two hinge points in the vicinity of the head–tail junction (Figure 22.28a).

cDNAs for myosin from many different species and from different types of muscle have been cloned and amino acid sequences for these myosin molecules inferred. Myosin has evolved very slowly, and there is a very high degree of homology among them, particularly within the head, or globular, region. There is somewhat less sequence homology within the tail region, but functional homology exists to an extraordinarily high degree regardless of length, which ranges from about 86 to about 150 nm for different species. The myosin head group contains nearly one-half of the total number of amino acid residues of the entire molecule in mammals, and it varies in the number of residues from only about 839 to about 850.

Myosin forms a **symmetrical tail-to-tail aggregate** around the M line of the H zone in the sarcomere. Its tail sections are aligned in a parallel manner on both sides of the M line with the head groups pointing towards the Z line. Each thick filament contains about 400 molecules of myosin. The C-protein (Table 22.7) is involved in their assembly. The M-protein is also involved, presumably to hold the tail sections together as well as to anchor them to the M line of the H zone.

The globular head section of myosin contains the **ATPase** activity that provides energy for contraction and the **actin binding site**. The S-1 fragment also contains the binding sites for the **essential light chain** and the **regulatory light chain**. A space-filling model of the three-dimensional structure of the myosin S-1 fragment is shown in Figure 22.29. The actin binding region is located at the lower right-hand corner and the cleft, visible in that region of the molecule, points toward the active site region where ATP binds. The 25-, 50-, and 20-kDa domains of the heavy chain are colored green, red, and blue, respectively. The essential light chain (ELC) and the regulatory light chain (RLC) are shown in yellow and magenta, respectively.

The active (ATP binding) site is also an open cleft about 13 Å deep and 13 Å wide. It is separated from the actin binding site by approximately 35 Å.

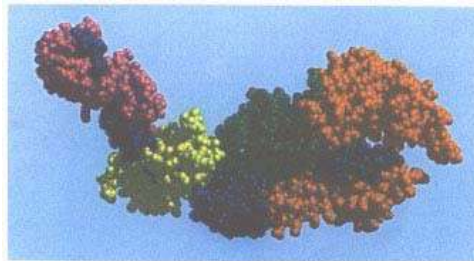

Figure 22.29
Space-filling model of the amino acid residues in myosin S-1 fragment.

The 25-, 50-, and 20-kDa domains of the heavy chain are green, red, and blue, respectively. The essential and regulatory light chains are yellow and magenta, respectively.

Reprinted with permission from Rayment, I., Rypniewski, W. R., Schmidt-Bäse, K., Smith, R., et al. *Science* 261:50, 1993. Copyright 1993 American Association for the Advancement of Science. Photograph generously supplied by Dr. I. Rayment.

Myosin binding to actin shows stereo specificity. The ELC and RLC are associated with a single long helix that connects the head region with the tail section. There is room for flexibility, which requires only a low energy expenditure, between the ELC and the connecting single helix. The conformation of myosin that has ATP bound to it has an affinity for actin that is 1/10,000 that of the conformation of myosin that does not have ATP bound to it! Thus the process of chemical energy transduction to mechanical work depends on the primary event of protein conformation changes that occur upon binding of ATP, its hydrolysis, and product dissociation.

Actin, Tropomyosin, and Troponin Are Thin Filament Proteins

Actin is a major protein of the thin filament and makes up about 20–25% of muscle protein. It is synthesized as a 42-kDa globular protein. It has a better than 90% conserved amino acid sequence among a variety of species. This is shown in Table 22.8 for skeletal muscle, smooth muscle, and cardiac muscle actin in three different species of animals. Differences are observed at most in about seven different positions. In fact, the primary amino acid sequences of more than 30 different actin isotypes, with the longest containing 375 amino acid residues, reveal that a maximum of only 32 residues in any of them had been substituted. A significant number of them occurred at the N terminal, which may be predicted considering that all actin molecules are posttranscriptionally modified at the N terminal. The N-terminal methionine is acetylated and removed, and the next amino acid is acetylated. The process may end at this stage or it may be repeated one or two additional times. In all cases, the N-terminal amino acid will be acetylated.

As first synthesized, actin is called **G-actin** for globular actin. The structure in Figure 22.30 shows that it is not strictly globular. Actin has two distinct domains of approximately equal size that, historically, have been designated as large (left) and small (right) domains. Each of these domains consists of two subdomains. Both the N-terminal and C-terminal amino acid residues are located within subdomain 1 of the small domain. The molecule has polarity, and when it aggregates to form **F-actin**, or fibrous actin, it does so with a specific directionality. This is important for the "stick and pull" processes involved in sarcomere shortening during muscular contraction.

G-actin contains a specific binding site, located between the two major domains, for ATP and a divalent metal ion. Mg^{2+} ion is most likely the physiologically important cation, but Ca^{2+} also binds tightly and competes with Mg^{2+} for the same tight binding site. It is the **G-actin-ATP- Mg^{2+} complex** that aggregates to form the **F-actin polymer** (see Figure 22.34). Aggregation can occur from either direction, but kinetic data indicate that the preferred direction of aggregation is

TABLE 22.8 Summary of the Amino Acid Differences Between Chicken Gizzard Smooth Muscle Actin, Skeletal Muscle Actin, and Bovine Cardiac Actin

Actin Type	Residue Number						
	1	2	3	17	89	298	357
Skeletal muscle ^a	Asp	Glu	Asp	Val	Thr	Met	Thr
Cardiac muscle ^b		Asp	Glu			Leu	Ser
Smooth muscle ^c	Absent		Glu	Cys	Ser	Leu	Ser

Source: Adapted from Vandekerckhove, J., and Weber K. *FEBS Lett.* 102:219, 1979.

^a From rabbit, bovine, and chicken skeletal muscle.

^b From bovine heart.

^c From chicken gizzard.

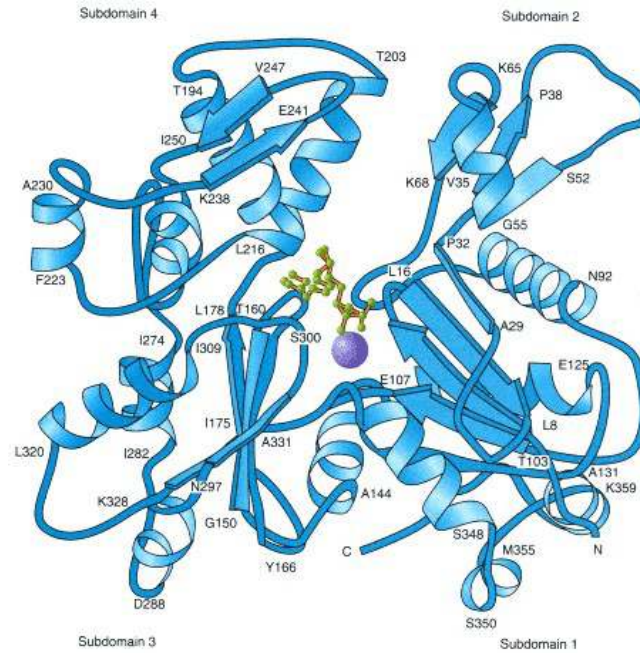

Figure 22.30

Secondary structural elements of G-actin crystal structure.

ADP and the metal ion are shown in the cleft between the two large domains.
Redrawn with permission from Lorenz, M., Popp, D., and Holmes, K. C. *J. Mol. Biol.* 234:826, 1993. By permission of the publisher, Academic Press Limited, London.

by extension from the large end of the molecule where the rate is diffusion controlled. ATP hydrolysis occurs by orders of magnitude faster in the aggregated actin than it does in the monomer. G-actin-ADP-Mg²⁺ also aggregates to form F-actin but at a slower rate. Orientation of G-actin molecules in F-actin is such that subdomains 1 and 2 are to the outside where myosin binding sites are located. F-actin may be viewed as either (1) a single-start, left-handed helix with rotation of the monomers through an approximate 166° with a rise of 27.5 Å or (2) a two-start, right-handed helix with a half pitch of 350–380 Å.

There are a number of proteins in the cytosol that bind actin. **β-Actinin** binds to F-actin and plays a major role in limiting the length of the thin filament. **α-Actinin**, a homodimeric protein with a subunit molecular weight of 90–110 kDa, binds adjacent actin monomers of F-actin at positions 86–117 and 350–375 and strengthens the fiber. It also helps to anchor the actin filament to the Z line of the sarcomere. There are two other major proteins associated with the thin filament, **tropomyosin** and **troponin**.

Tropomyosin is a rod-shaped protein consisting of two dissimilar subunits, each of about 35 kDa. It forms aggregates in a head-to-tail configuration. This polymerized protein interacts in a flexible manner with the thin filament throughout its entire length. It fits within the groove of the helical assembly of the actin monomers of F-actin. Each of the single tropomyosin molecules interacts with about seven monomers of actin. The site on actin with which tropomyosin interacts is between subdomains 1 and 3. Tropomyosin helps to stabilize the thin filament and to transmit signals for conformation change to other components of the thin filament upon Ca²⁺ binding. Bound to each individual tropomyosin molecule is one molecule of troponin.

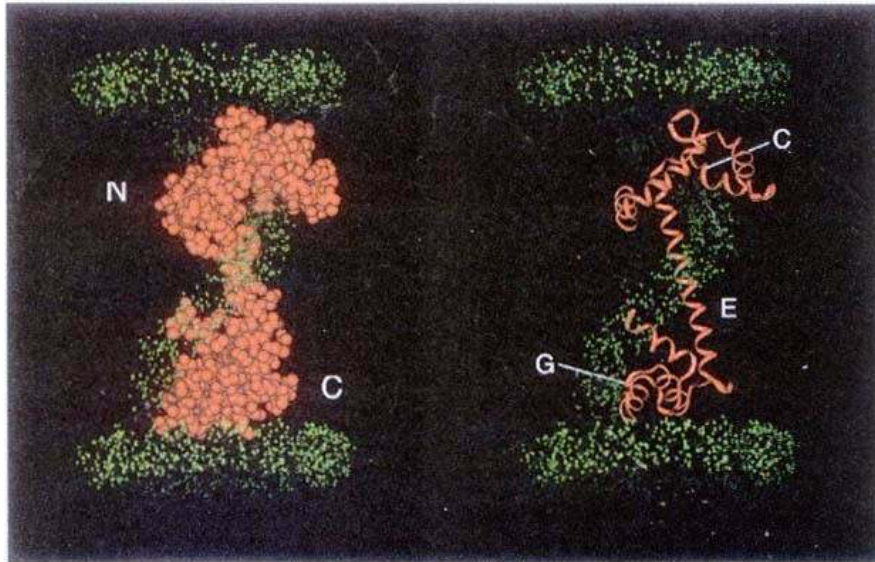

Figure 22.31

Best fit model for the 4 Ca²⁺-troponin C-troponin I complex.

A model for the complex of 4 Ca²⁺-troponin C-troponin I based on neutron scattering studies with deuterium labeling and contrast variation (Olah, C. A., and Trehwella, J., *Biochemistry* 33:12800, 1994). (Right) A view showing the spiral path of troponin I (green crosses) winding around the 4 Ca²⁺-troponin C that is represented by an α -carbon backbone trace (red ribbon) with the C, E, and G helices labeled. (Left) The same view with 4 Ca²⁺-troponin C represented as a CPK model.

Photograph generously supplied by Dr. J. Trehwella. The publisher recognizes that the U. S. Government retains a nonexclusive, royalty-free license to publish or reproduce the published form of this contribution or to allow others to do so, for U. S. Government purposes.

Troponin has three dissimilar subunits designated Tn-C, Tn-I, and Tn-T with molecular weights of about 18 kDa, 21 kDa, and 37 kDa, respectively. The Tn-T subunit binds to tropomyosin. The Tn-I subunit is involved in the inhibition of the binding of actin to myosin in the absence of Ca²⁺. The Tn-C subunit, a calmodulin-like protein, binds Ca²⁺ and induces a conformation change that alters the conformation of Tn-I and tropomyosin, resulting in exposure of the actin-myosin binding sites.

A three-dimensional structure of Tn-C shows it to be a dumbbell-shaped molecule with much similarity to calmodulin. A structural model of the calcium saturated Tn-C-Tn-I complex is shown in Figure 22.31. The Tn-I subunit fits around the central region of Tn-C in a helical coil conformation and forms caps over it at each end. The cap regions of Tn-I are in close contact with Tn-C when Tn-C is fully saturated with calcium ions. Tn-C has four divalent metal ion binding sites. Two are in the N-terminal region, are high affinity (K_{dissoc} of about 10^{-7} M), and are presumed to be always occupied since this is about the concentration of calcium ions in resting cells. Under these conditions, Tn-I has a conformation that permits its interaction with binding sites on actin, inhibiting myosin binding and preventing contraction. Upon excitation, the calcium ion concentration increases to about 10^{-5} M, high enough to effect calcium binding to sites within the N-terminal region of Tn-C. Tn-I now binds preferentially to Tn-C in a capped structural conformation as shown in Figure 22.31. Myosin binding sites on actin are now exposed. The relatively loose interaction of tropomyosin with actin gives it the flexibility to alter its conformation as a function of calcium ion concentration and to assist in blockage of the myosin binding sites on actin. (See Clin. Corr. 22.7 for additional information about troponin.)

Figure 22.26*i* shows schematically a cross section of the sarcomere and the relative arrangement of the thin and thick filaments. There are six thin filaments surrounding each thick filament. The arrangement of myosin head groups around the thick filaments and the flexibility of those head groups make it possible for each thick filament to interact with multiple thin filaments. When **cross-bridges** are formed between the thick and thin filaments, they do so in patterns consistent with that shown in the electron micrograph of Figure 22.32. This figure shows a two-dimensional view of the myosin of the thick filament interacting with the actin of the thin filaments lying on either side of it. Similar interactions of myosin occur with the actin of the other four thin filaments that surround it.

CLINICAL CORRELATION 22.7**Troponin Subunits as Markers for Myocardial Infarction**

Troponin has three subunits (Tn-T, Tn-I, and Tn-C) each of which is expressed by more than one gene. Two genes code for skeletal muscle Tn-I, one in fast- and one in slow-skeletal muscle; and one gene codes for cardiac muscle Tn-I. The genes that code for Tn-T have the same distribution pattern. They differ in that the slow-skeletal muscle gene for Tn-I is also expressed in fetal heart tissue. The gene for the cardiac form of Tn-I appears to be specific for heart tissue. Tn-C is encoded by two genes, but neither gene appears to be expressed only in cardiac tissue.

The cardiac form of Tn-I in humans is about 31 amino acids longer than the skeletal muscle form, which makes it easy to differentiate from others. Serum levels of Tn-I increase within four hours of an acute myocardial infarction and remain high for about seven days in about 68% of patients tested. Almost 25% of one group of patients tested also showed a slight increase in the cardiac-form of Tn-I after acute skeletal muscle injury. This would be a good but not a very sensitive test for myocardial infarction.

Two isoforms of cardiac Tn-T, Tn-T₁, and Tn-T₂, are present in adult human cardiac tissue. Two additional isoforms are also present in fetal heart tissue. Speculation is that the isoforms are the result of alternative splicing of mRNA. Serum levels of Tn-T₂ increase within four hours of acute myocardial infarction and remain high for up to 14 days. The appearance of Tn-T₂ in serum is 100% sensitive and 95% specific for detection of myocardial infarction. In the United States, the Food and Drug Administration has given approval for marketing of the first Tn-T assay for acute myocardial infarction. Myocardial infarcts are either undiagnosed or misdiagnosed in hospital patients admitted for other causes, or in 5 million or more people who go to doctors for episodes of chest pain. It is believed that this test will be sufficiently specific to diagnose myocardial incidents and to help direct doctors to proper treatment of these individuals.

Anderson, P. A. W., Malouf, N. N., Oakeley, A. E., Pagani, E. D., and Allen, P. D. *Circ. Res.* 69:1226, 1991; and Ottlinger, M. E., and Sacks, D. B. *Clin. Lab. News*, 33, 1994.

Muscle Contraction Requires Ca²⁺ Interaction

Contraction of skeletal muscle is initiated by transmission of **nerve impulses** across the **neuromuscular junction** mediated by release into the synaptic cleft of the neurotransmitter **acetylcholine**. The **acetylcholine receptors** are associated with the plasma membrane and are **ligand gated**. Binding of acetylcholine causes them to open and to permit Ca²⁺/Na⁺ to enter the sarcomere. The electron micrograph and accompanying diagrams of Figure 22.33 provide a picture of the anatomical relationship between the presynaptic nerve and the sarcomere. There are transverse tubules along the membrane in the vicinity of the Z lines that are connected to the terminal cisternae of the sarcoplasmic reticulum. Nerve impulses result in a depolarization of the plasma membrane and the transverse tubules, and an influx of Ca²⁺ into the sarcomere. As indicated above, Ca²⁺ concentration increases about 100-fold, permitting it to bind to the low-affinity sites of Tn-C and to initiate the contraction process. (See Clin. Corr. 22.8.)

Energy for Muscle Contraction Is Supplied by ATP Hydrolysis

ATP is an absolute requirement for muscular contraction. ATP hydrolysis by the **myosin-ATPase** to give the myosin-ADP complex and inorganic phos-

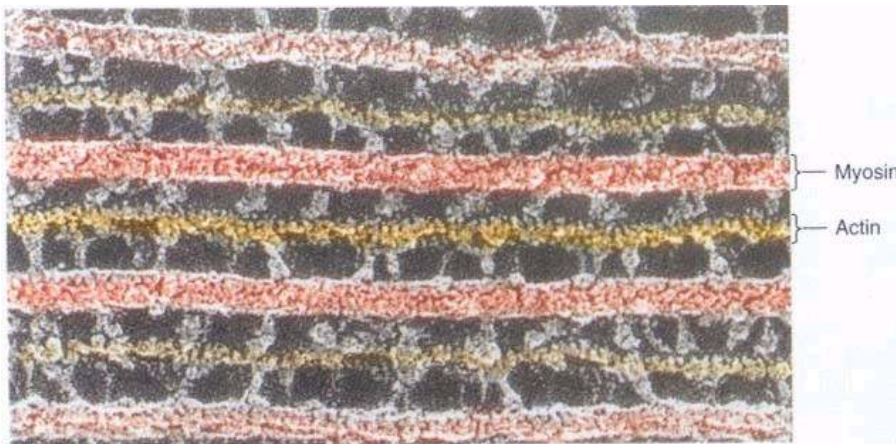

Figure 22.32
Electron micrograph of actin-myosin cross-bridges in a striated insect flight muscle.
 Reproduced with permission from Darnell, J., Lodish, H., and Baltimore, D. *Molecular Cell Biology*. New York: Scientific American Books, 1986.

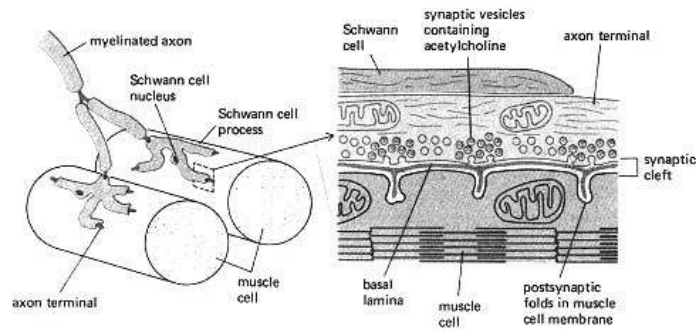
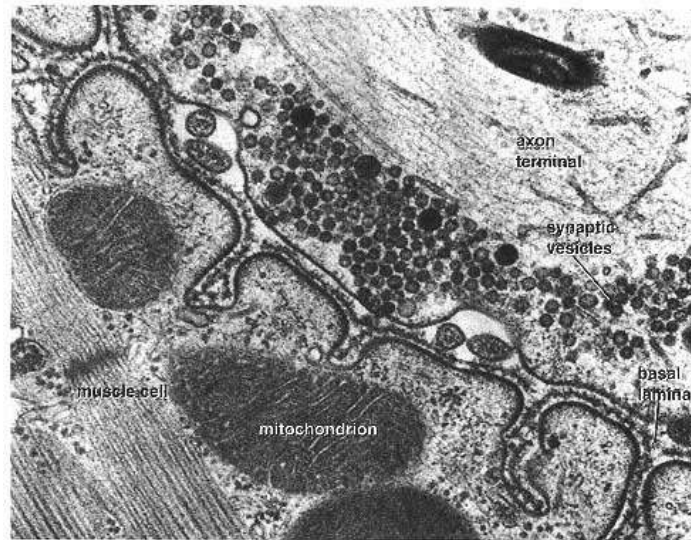

Figure 22.33

Neuromuscular junction.

(a) Electron micrograph of a neuromuscular junction.

(b) Schematic diagram of the neuromuscular junction shown in (a).

Reproduced with permission from Alberts, B., Bray, D., Lewis, J., Raff, M., Roberts, K., and Watson, J. *Molecular Biology of the Cell*. New York: Garland Publishing, 1983.

phate leads to a myosin conformation that has an increased binding affinity for actin. Additional ATP is required for the dissociation of the myosin–actin complex.

The concentration of ATP in the sarcomere remains fairly constant even during strenuous muscle activity, because of increased metabolic activity and of the action of two enzymes: **creatine phosphokinase** and **adenylate kinase**. Creatine phosphokinase catalyzes the transfer of phosphate from phosphocre-

CLINICAL CORRELATION 22.8

Voltage-Gated Ion Channelopathies

Action potentials in nerve and muscle are propagated by the operation of voltage-gated ion channels. Generally, there are three recognized types of voltage-gated cation channels: Na^+ , Ca^{2+} , and K^+ . Each of these has been cloned, primary sequence inferred from the DNA sequence, and a model constructed of how each may be assembled in the membrane. Each is a heterogeneous protein

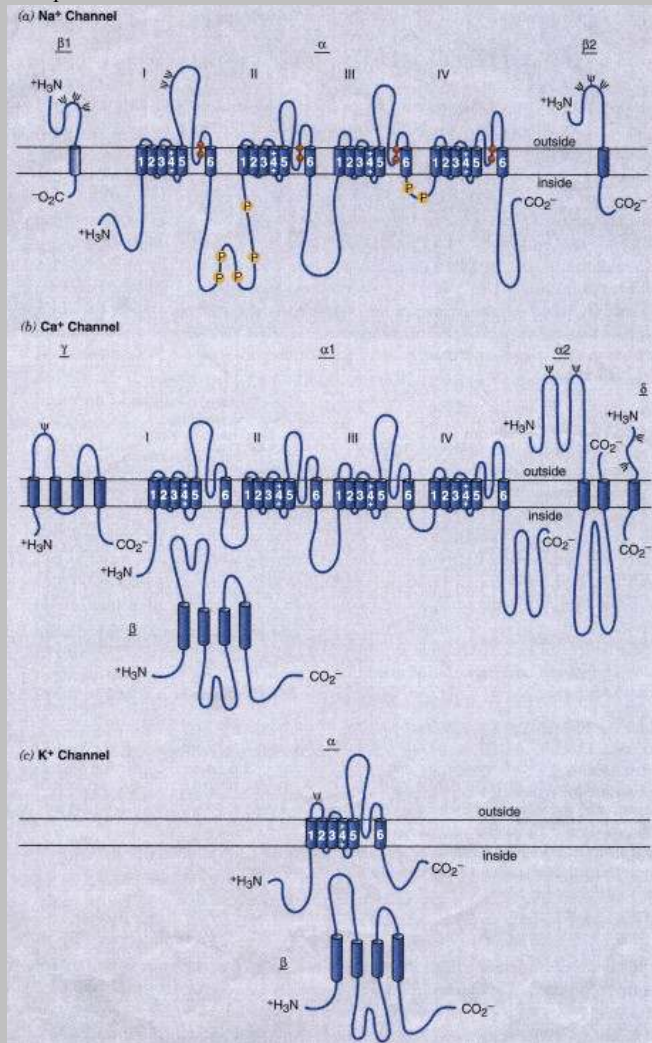

Transmembrane organization of ion channel subunits. Glycosylation and phosphorylation sites are marked. From Catterall (1995).

consisting of various numbers of α and β subunits. A linear model of the arrangement of each of these is shown in the figure above. In actual fact, they are arranged in a more-or-less circular manner with a channel formed through the middle of the α subunits. Roles of the β subunits are still being elucidated, but they appear to help stabilize and/or regulate activity of α subunits.

Toxins are being used to study subunit function. Tetrodotoxin and saxitoxin block Na^+ channel pores of the α subunit. Scorpion toxins also bind to the α subunit and appear to affect activation and inactivation gating. Experiments of this type suggest that the α subunit is involved in both conductance and gating.

Even though the Na^+ channel was first cloned from nerve tissue, the electroplax of the eel, more is known about how mutations affect its function in muscle. Voltage-gated channels from nerve and muscle tissue show high homology in many of the transmembrane domains but are less conserved in the intracellular connecting loops. A common effect of mutations in Na^+ channels is muscle weakness or paralysis. Some inherited sodium voltagegated ion channelopathies are listed below. Each of these is reported to result from a single amino acid change in the α subunit. The inheritance pattern generally is dominant.

<i>Disorder</i>	<i>Unique Clinical Feature</i>
Hyperkalemic periodic paralysis	Induced by rest after exercise, or the intake of K^+
Paramyotonia congenita	Cold-induced myotonia
Sodium channel myotonia	Constant myotonia

It has been surmised (by Hoffman, 1995; see Catterall, 1995) that if the membrane potential is slightly more positive (i.e., changes from -70 to -60 mV), the myofiber can reach the threshold more easily and the muscle becomes hyperexcitable. If the membrane potential becomes even more positive (i.e., up to -40 mV) the fiber cannot fire an action potential. This inability to generate an action potential is synonymous with paralysis. The fundamental biochemical defect in each case is a mutation in the channel protein.

Catterall, W. A. *Annu. Rev. Biochem.* 64:493, 1995; and Hoffmann, E. P. *Annu. Rev. Med.* 46:431, 1995.

atine to ADP in an energetically favored manner:



If the metabolic process is insufficient to keep up with the energy demand, the creatine phosphokinase system serves as a "buffer" to maintain cellular levels of ATP. The second enzyme is adenylate kinase that catalyzes the reaction



ATP depletion brings about rather rigid consequences to muscle cells. When the ATP supply of the muscle is exhausted and the intracellular Ca^{2+} concentration is no longer controlled, myosin will exist exclusively bound to actin, a condition called **rigor mortis**. The function of ATP binding in muscular contraction is to promote dissociation of the actin–myosin complex, not to promote its association.

Model for Skeletal Muscle Contraction

A model of the **actin–myosin complex** is shown in Figure 22.34. The myosin head undergoes conformation changes upon binding of ATP, hydrolysis of ATP, and release of products. ATP binding leads to closure of the active site cleft and opening of the cleft in the region of the actin binding site. Hydrolysis of ATP and release of inorganic phosphate result in closure of the cleft in the actin binding region. The conformation change that occurs is evident by the movement of two cysteine-containing helices. The distance between the two cysteine residues (697 and 707) changes from about 19 Å to about 2 Å. If further conformation change is prevented by cross-linking these two cysteines, ADP is trapped within its binding site. A stereo view of myosin showing the reactive cysteine pocket is shown in Figure 22.34b.

The sequence of events leading to muscle contraction from its resting state, following Ca^{2+} entry into the cell, probably begins with the hydrolysis of bound ATP. Myosin–ATP complex has a very low affinity for actin. Thus, even with exposed actin binding sites, any interaction between myosin and actin would be weak. The first significant interaction between myosin and actin probably

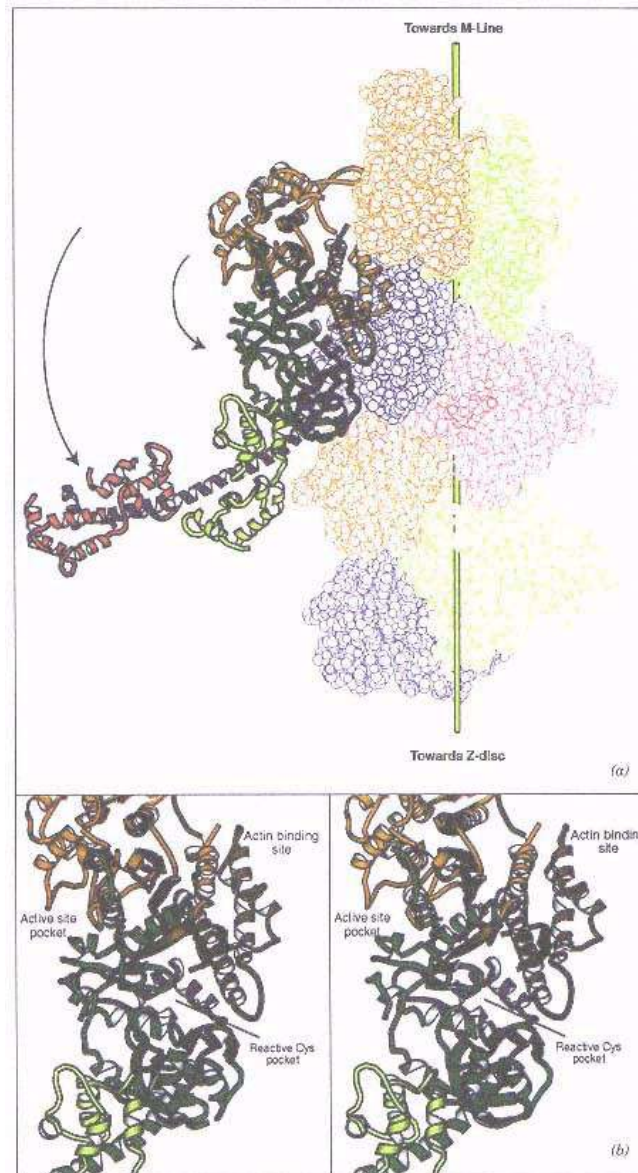

Figure 22.34

Model of actin–myosin interaction.

- (a) Myosin is shown as a ribbon structure and actin as space-filling. Each G-actin monomer is represented by different colors.
 (b) Stereo view of myosin showing the pocket that contains the mobile "reactive" cysteine residues.

Reproduced with permission from Rayment, I., and Holden, H. M. *TIBS* 19:129, 1994. Photograph generously supplied by Dr. I. Rayment.

occurs upon release of inorganic phosphate. Release of ADP leads to tight binding (approximately a 10,000-fold increase) and another conformation change that results in opening of the reactive cysteine pocket. The conformation change results in a movement of the upper portion of the myosin head in the direction of the arrows in Figure 22.34a and movement of the thin filament in a direction away from the Z line, the **power stroke**. The thick filament is anchored in the center of the sarcomere and the **myosin head groups are polarized** in opposite directions on each side of the M line. Each thick filament contains hundreds of S-1 or myosin head units surrounded by six actin-containing thin filaments. Individual myosin units function in an asynchronous manner—possibly like changes in the position of hands on a rope in the game of tug-of-war. Thus when some myosin head groups bind with high affinity, others have low affinity.

Calcium Regulates Smooth Muscle Contraction

Calcium ions play an important role in **smooth muscle contraction** also, but there are some important differences in the mechanism by which it acts. A mechanism for calcium regulation of smooth muscle contraction is shown in Figure 22.35. Key elements of this mechanism are as follows. (1) A phosphorylated form of **myosin light chain** stimulates **Mg-ATPase**, which supplies energy for the contractile process. (2) Myosin light chain is phosphorylated by a **myosin light chain kinase (MLCK)**. (3) MLCK is activated by a Ca^{2+} -calmodulin (CaM) complex. (4) Formation of the Ca^{2+} -CaM complex is dependent on the concentration of intracellular Ca^{2+} . Release of Ca^{2+} from its intracellular stores or an increase in its flux across the plasma membrane is important for control. (5) Contraction is stopped by the action of a **myosin phosphatase** or the transport of Ca^{2+} out of the cell. It is apparent that, in smooth muscle, many more biochemical steps are involved in the regulation of contraction, steps that can be regulated in a progressive manner by hormones and other agents. These serve the function of smooth muscles well, namely, giving them the ability to develop various degrees of tension and to retain it for prolonged periods of time.

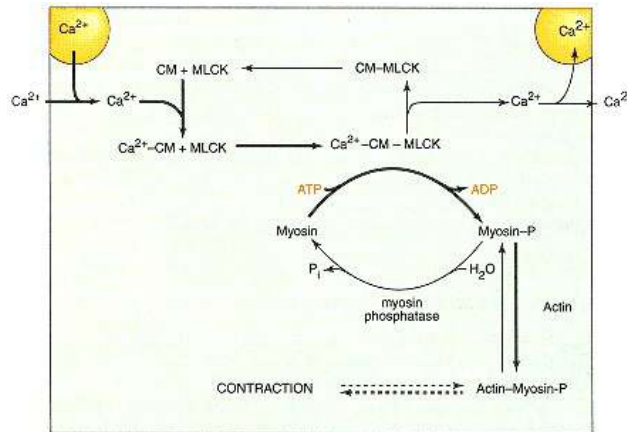

Figure 22.35

Schematic representation of the mechanism of regulation of smooth muscle contraction.

Heavy arrows show the pathway for tension development and light arrows show the pathway for release of tension. The Mg^{2+} -ATPase activity is highest in the actin-myosin-P complex. CaM, calmodulin; MLCK, myosin light chain kinase.

Adapted from Kramm, K. E., and Stull, J. T. *Annu. Rev. Pharmacol. Toxicol.* 25:593, 1985.

22.5—

Mechanism of Blood Coagulation

The circulation of blood is essential for life, and the integrity of the process must be maintained. Some aspects of the importance of blood circulation in the maintenance of pH, in the transport of oxygen and nutrients to cells, and in the transport of carbon dioxide and waste products from cells are well known. This section deals primarily with a description of the system responsible for clot formation and dissolution.

Blood circulation occurs in a very specialized type of closed system in which the volume of circulating fluid is maintained fairly constant. This system is also one in which the transfer of solutes across its boundaries is a necessary function. Like any system of pipes and tubes, leaks can occur and must be repaired. The process of **blood clotting** primarily addresses the question of stopping the leaks. Secondly, small clots may form due to disease and other abnormalities that are independent of total rupture of vesicles. Discussion of the function of the process must therefore extend beyond the primary one of leak prevention to include **clot dissolution**.

The purpose of this section is to give a general picture of the mechanism of blood clotting from a biochemical viewpoint. To this end, this section will focus on the relationship between blood clot formation, blood clot dissolution, and the enzymes and other proteins involved—their activation, regulation, inhibition, and synthesis. Blood clotting is not a process of signal transduction in the same sense as are the other topics of this chapter. Instead, it is a dynamic process of signal amplification and modulation. Some of the primary questions to be addressed are: (1) What initiates the clotting process? (2) What substances, reactions, and mechanisms are responsible for forming the clot? (3) What factors and mechanisms are involved in inhibiting the clotting process once it is initiated? (4) How is the clot dissolved?

It is important for the body to maintain **hemostasis**, that is, no bleeding. Thus the process of blood clotting is designed to stop as rapidly as possible the loss of blood following vascular injury. When such an injury occurs, three major events take place: (1) **aggregation** of a protein, **fibrin**, into an insoluble network, or clot, to cover the ruptured area to prevent the loss of blood; (2) **clumping of blood platelets** at the site of injury in an effort to form a physical plug to stop the leak; and (3) **vasoconstriction** in an effort to reduce the blood flow through the area. Equally important is regulation of the process to prevent excessive clot formation.

The processes mentioned above are emergency mechanisms for stopping the loss of blood. The process is not complete, however, until the ruptured vessel itself is repaired and the clot dissolved. Many of the proteins involved in blood coagulation contain **epidermal growth factor (EGF)-like domains**. Whether these EGF-like domains act directly to facilitate the regrowth of blood vesicles is not clear.

Some of the major proteins (players) involved in this process (silent drama) are listed in Table 22.9, not necessarily in order of appearance. All are important and, as time goes on, others are sure to be added. In fact, protein Z that occurs to a larger extent in children could be added but its role and function are not clear.

Clot Formation Is a Membrane-Mediated Process

Clot formation initially follows two separate pathways: **intrinsic** or **contact factor pathway** and **extrinsic** or **tissue factor pathway** (see Figures 22.36 and 22.38). These pathways merge with the formation of factor Xa, the proteinase component of the multienzyme complex that catalyzes the formation of thrombin from prothrombin. From this point on, there is a single pathway for clot formation. Historically, the term intrinsic pathway came from the observa-

TABLE 22.9 Some of the Factors Involved in Blood Coagulation, Control, and Clot Dissolution

Factor	Name	Pathway	Characteristic	Concentration ^a
I	Fibrinogen	Both		9.1
II	Prothrombin	Both	Contains N-terminal Gla residues	1.4
III	Tissue factor	Extrinsic	Transmembrane protein	—
IV	Calcium	Both		
V	Proaccelerin	Both	Protein cofactor	0.03 ^b
VII	Proconvertin	Extrinsic	Endopeptidase with Gla residues	0.010 ^c
VIII	Antihemophilic	Intrinsic	Protein cofactor	0.0003 ^b
IX	Christmas factor	Intrinsic	Endopeptidase with Gla residues	0.089
X	Stuart factor	Both	Endopeptidase with Gla residues	0.136
XI	Thromboplastin antecedent	Intrinsic	Endopeptidase	0.031
XII	Hageman factor	Intrinsic	Endopeptidase	0.375
XIII	Proglutamidase	Both	Transpeptidase	0.031 ^b
	Protein C	(Both)	Endopeptidase with Gla residues	0.065
	Protein S	(Both)	Cofactor with Gla residues	0.30
	Prekallikrein	Intrinsic	Zymogen/activator factor-XII	0.581
	HMWK ^d	Intrinsic	Receptor protein	0.636
	Antithrombin III	Both	Thrombin inhibitor	3.0
	Plasminogen		Zymogen/clot dissolution	2.4
	Heparin Co-II	Both	Thrombin inhibitor	1.364
	α_2 -Antiplasmin		Plasmin inhibitor	0.952
	Protein C inhibitor		Protein C inhibitor	0.070
	α_2 -Macroglobulin		Proteinase inhibitor	2.9
	LACI ^e		Extrinsic pathway inhibitor	0.003

^a Concentrations are approximate and shown in micromolar.

^b These values approximate solution concentrations since some are complexed with other proteins in platelets.

^c This factor probably circulates as both VII and VIIa.

^d HMWK is high molecular weight kininogen.

^e LACI is lipoprotein-associated coagulation factor.

tion that blood clotting would occur spontaneously when blood was placed in clean glass test tubes, leading to the idea that all components for the clotting process were intrinsic to the circulating blood. Glass contains **anionic surfaces** that formed the nucleation points that initiate the process. In mammals, anionic surfaces are exposed upon rupture of the **endothelial lining** of the blood vessels and are the binding sites for specific factors that initiate clotting in the intrinsic pathway. Similarly, the term extrinsic came from the observation that there was another factor extrinsic to circulating blood that facilitates blood clotting. This factor was identified as **factor III, tissue factor** (see Figure 22.39a). Whether intrinsic or extrinsic, the process of blood coagulation is initiated on the membrane and is continued on the membrane surface at the site of injury.

Reactions of the Intrinsic Pathway

Reactions of the intrinsic pathway are shown in Figure 22.36. Upon injury to the endothelial lining of blood vessels and exposure of external membrane surfaces, the proteinase zymogen **factor XII** binds directly to anionic surfaces and undergoes a conformation change that increases its catalytic activity 10^4 - to 10^5 -fold. **Prekallikrein** and **factor XI**, also zymogens, circulate in blood as separate complexes with **high molecular weight kininogen (HMWK)**: either a factor XI–HMWK complex or a prekallikrein–HMWK complex. In Figure 22.37 is a schematic diagram showing the functional regions of HMWK. The binding site on HMWK for prekallikrein consists of approximately 31 amino acid residues. Factor XI binds to approximately 58 amino acid residues that include the

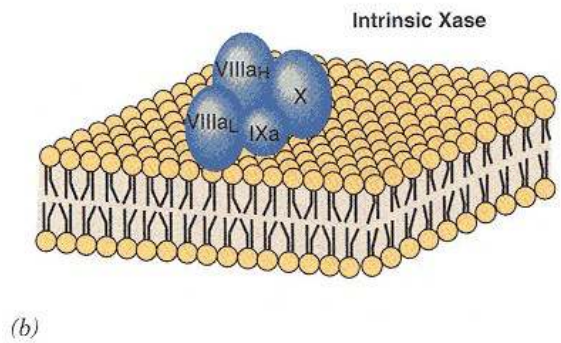
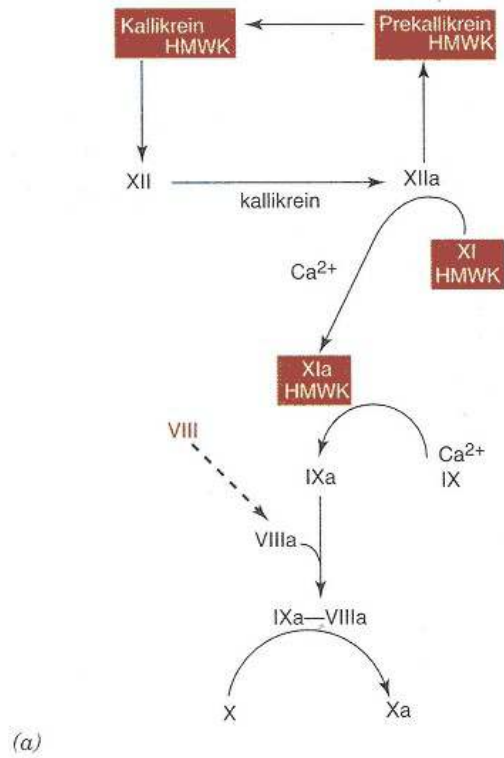

Figure 22.36
Intrinsic pathway of blood coagulation.
 HMWK, high molecular weight kinogen. Activated factors are designated with an "a."
 Adapted from Kalafatis, M., Swords, N. A., Rand M. D., and Mann, K. G. *Biochim. Biophys. Acta* 1227:113, 1994.

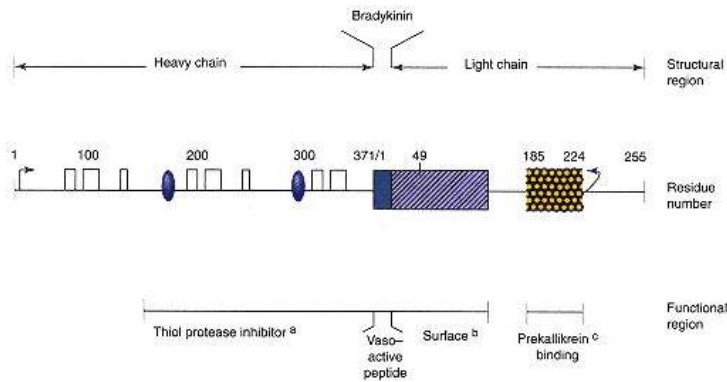

Figure 22.37
Schematic diagram of the functional regions of human high molecular weight kinogen (HMWK).
 Bradykinin is derived from near the middle of HMWK by proteolysis. The resulting two chains are held together by disulfide bonds (horizontal arrows).
 Redrawn from Tait, J. F., and Fujikawa, K. *J. Biol. Chem.* 261:15396, 1986.

31 to which prekallikrein binds. Factor XI and prekallikrein are attached to anionic sites of exposed membrane surfaces through their interactions with HMWK. This brings those zymogens to the site of injury and in direct proximity to factor XII. The membrane-bound "activated" form of factor XII activates prekallikrein, a 619 amino acid protein, by cleavage at Arg³⁷¹–Ile³⁷², to yield **kallikrein**. Kallikrein contains two chains covalently linked by a single disulfide bond. Kallikrein, whose C-terminal domain (248 amino acid residues) contains the catalytic site, further activates factor XII to give XIIa. Factor XI, which is membrane bound through its noncovalent attachment to HMWK, is activated by XIIa through proteolytic cleavage to XIa. Factor XIa activates **factor IX** to IXa. Factor IXa in the presence of **factor VIIIa**, a protein cofactor, forms the **intrinsic factor ten'ase (intrinsic Xase)** that can now activate **factor X** to Xa. Factor Xa is the catalytic moiety of the proteinase complex responsible for the activation of prothrombin to thrombin (see Clin. Corr. 22.9). This is essentially a four-step cascade started by the "contact" activation of factor XII and the **autocatalytic** action between factor XII and kallikrein to give XIIa (step 1). Factor XIIa activates factor XI (step 2); factor XIa activates factor IX (step 3); and factor IXa, in the presence of VIIIa, activates factor X (step 4). If each enzyme molecule activated also catalyzed the formation of 100 others before it is inactivated, the **amplification factor** would be 1×10^6 .

Reactions of the Extrinsic Pathway

A diagram of the extrinsic pathway is shown in Figure 22.38. The membrane receptor that initiates this process is factor III or tissue factor. Tissue factor (Figure 22.39a) is a transmembrane protein of 263 amino acids. Residues 243–263 are located on the cytosolic side of the membrane. Residues 220–242 are hydrophobic residues and represent the transmembrane sequence. Residues 1–219 are on the outside of the membrane, are exposed after injury, and form the receptor for formation of the initial complex of the extrinsic pathway. This domain is glycosylated and contains four cysteine residues. A stereo representation of a section of it highlighting some of the amino acid residues involved in factor VII binding is shown in Figure 22.39b.

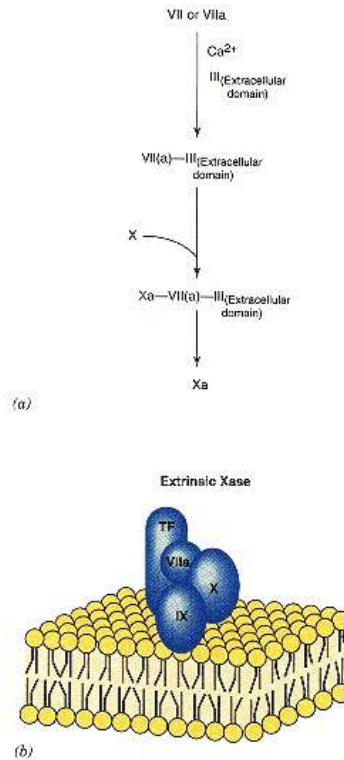

Figure 22.38
Extrinsic pathway of blood coagulation.

Tissue factor (factor III or TF) and factor VII are unique to the **extrinsic pathway** and are essentially all of its major components. Factor VII is a **γ -carboxyglutamyl** or Gla-containing protein that binds to tissue factor only

CLINICAL CORRELATION 22.9

Intrinsic Pathway Defects: Prekallikrein Deficiency

Components of the intrinsic pathway include factor XII (Hageman factor), factor XI, prekallikrein (Fletcher factor), and high molecular weight kininogen. Clinical disorders have been associated with defects in each of these components. Inherited disorders in each appear to be autosomal recessive. Each appears to be associated with an increase in activated partial thromboplastin time (APTT). The only one of these components directly associated with a clinical bleeding disorder is factor XI deficiency.

In some cases where there is a prekallikrein (Fletcher factor) deficiency, autocorrection after prolongation of the preincubation phase of the APTT test occurs. This phenomenon is explained by the ability of factor XII to be activated by an autocatalytic mechanism. The reaction is very slow in prekallikrein deficiency since the rapid reciprocal autoactivation between factor XII and prekallikrein cannot take place. Prekallikrein deficiency may be due to a decrease in the amount of the protein synthesized, to a genetic alteration in the protein itself that interferes with its ability to be activated, or its ability to activate factor XII. A lack of knowledge of the structure of the gene for prekallikrein precludes definitive explanations of the mechanisms operational in patients with prekallikrein deficiency. Specific deficiencies of the intrinsic pathway, however, can be localized to a specific factor if the appropriate number of tests are performed. These may include a direct measurement of the amount of each of the factors present in the patient's plasma in addition to APTT test performed with and without prolonged preincubation time. Use of these direct measurements helped diagnose a prekallikrein deficiency in a 9-year-old girl who had a prolonged APTT. The functional level of prekallikrein in this patient was less than 1/50th of the minimum normal value. Immunological test (ELISA) showed an antigen level of 20–25%, suggesting that she was synthesizing a dysfunctional molecule.

Coleman, R. W., Rao, A.K., and Rubin, R. N. *Am. J. Hematol.* 48:273, 1995.

in the presence of Ca^{2+} . The resulting TF–VII– Ca^{2+} complex is the catalytically active species. It catalyzes the formation of factor Xa from X.

The zymogen form of factor VII is initially **activated through protein–protein interaction** as a result of its binding to tissue factor. Additional factor VII is **activated by Xa** of the complex through proteolytic cleavage. Unlike other proteinases of the blood coagulation scheme, factor VIIa has a long half-life in circulating blood. Once dissociated from tissue factor, VIIa is not catalytically active, and its presence in blood would be harmless. Formation of the initial complex with TF could involve some of the already preformed factor VIIa, making it difficult to state with absolute certainty whether the zymogen form of VII in complex with tissue factor is totally responsible for the initial activation of factor X. A 3-D ribbon structural representation of factor VIIa is shown in Figure 22.40. The region for tissue factor interaction, Ca^{2+} binding, and the substrate binding pocket are highlighted.

Thrombin Converts Fibrinogen to Fibrin

The final phase in the formation of the fibrin clot (Figure 22.41) begins with action of the complex, **factor Xa–Va**, on **prothrombin**. A stereo view of factor

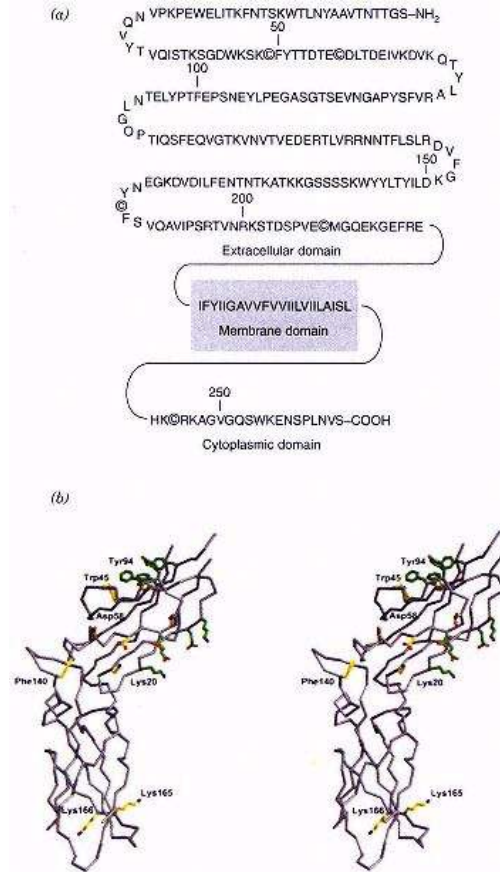

Figure 22.39
Tissue factor.

(a) Amino acid sequence of human tissue factor derived from its cDNA sequence.

(b) A stereo representation of the carbon chain of the extracellular domain of tissue factor. Residues important for binding of factor VII are shown in yellow. Clusters of aromatic and charged residues are shown in light blue.

(a) Redrawn from Spicer, E. K., Horton, R., Bloem, L., et al. Proc. Natl. Acad. Sci. USA 84:5148, 1987.

(b) Reproduced with permission from Muller, Y. A., Ultsch, M. H., Kelley, R. F., and deVos, A. M. *Biochemistry* 33:10864, 1994. Copyright 1994 American Chemical Society. Photograph generously supplied by Dr. A. de Vos.

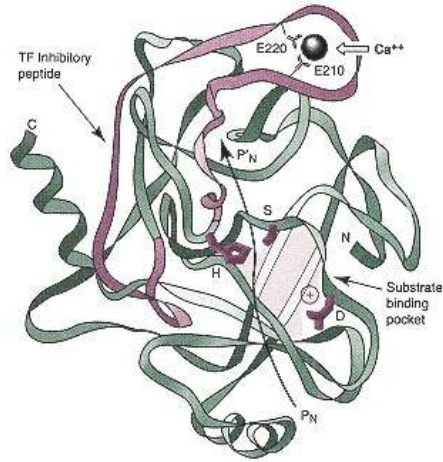
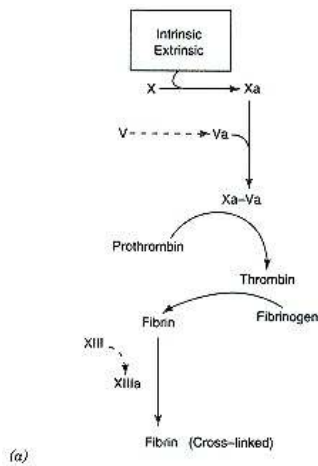

Figure 22.40
Ribbon structural representation of the protease domain of factor VIIa.

The dark ribbon labeled "TF inhibitory peptide" represents a section involved in binding to tissue factor. The catalytic triad is shown in the substrate binding pocket as H, S, and D for His¹⁹³, Ser³⁴⁴, and Asp³³⁸, respectively. The arrow labeled P_N-P'_N lies in the putative extended substrate binding region.

Redrawn with permission from Sabharwal, A. K., Birktoft, J. J., Gorka, J., et al. *J. Biol. Chem.* 270:1553, 1995.



(a)

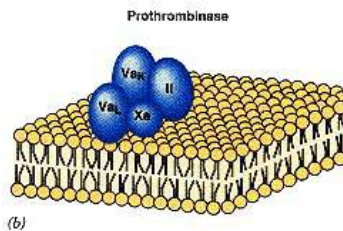

(b)

Figure 22.41
Clot forming pathway.
Adapted from Kalafatis, M., Swords, N. A., Rand, M. D., and Mann, K. G. *Biochim. Biophys. Acta* 1227:113, 1994.

Xa is shown in Figure 22.42. Factor Xa is formed by both the extrinsic and the intrinsic pathways by cleavage of factor X at positions 145 and 151 with elimination of a six amino acid peptide. Although the enzyme primarily responsible for activation of factor V is thrombin, factor Xa also catalyzes formation of Va. Thus the prothrombinase complex, Xa-Va, appears early in the process.

Thrombin, which circulates in plasma as prothrombin, catalyzes the conversion of fibrinogen to fibrin. Prothrombin, a 72-kDa protein (Figure 22.43), contains ten γ -carboxyglutamate (Gla) residues in its N-terminal region. Binding of calcium ions to these residues facilitates binding of prothrombin to membrane surfaces and to the Xa-Va complex at the site of injury. The prothrombinase complex (Xa-Va) activates prothrombin by making two proteolytic cleavages on the carboxyl side of arginine residues, first at position 320 and then at position 284. The active thrombin molecule (α -thrombin) consists of two chains, one of 6 kDa and the other of 31 kDa, that are covalently linked by a disulfide

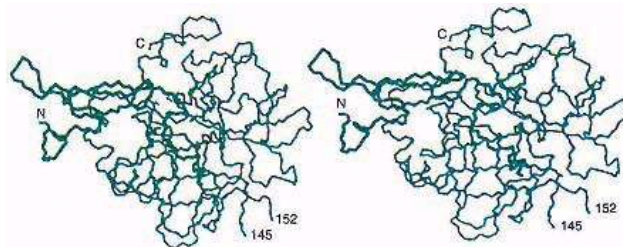

Figure 22.42
Stereo view of the CN-backbone structure of factor Xa.
The EGF-like domain is in bold.
Redrawn from Padmanabhan, K., Padmanabhan, K. P., Tulinsky, A., et al. *J. Mol. Biol* 232:947, 1993.

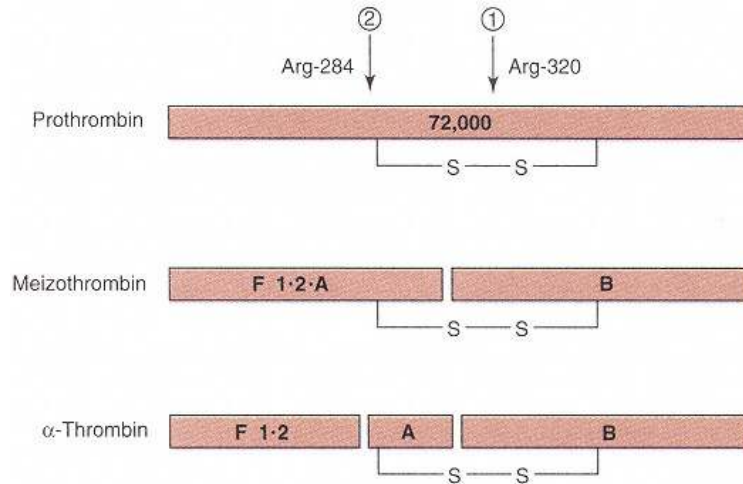

Figure 22.43
Schematic diagram of prothrombin activation.

bond. A stereo view of the active α -thrombin molecule is shown in Figure 22.44. Regions involved in some of its functions are highlighted. The substrate for thrombin is fibrinogen.

Fibrinogen is a large molecule of approximately 340 kDa consisting of two tripeptide units with α, β, γ structure (Figure 22.45). The subunits are "tied" together at their N-terminal regions by a group of disulfide bonds. Fibrinogen has three globular domains, one on each end and one in the middle where the chains are joined. The globular domains are separated by rod-like domains. A short segment of the free N-terminal regions projects out from the central globular domain. The N-terminal region of the α and the β subunits, through charge-charge repulsion, prevent aggregation of fibrinogen. Thrombin cleaves these N-terminal peptides and allows the resulting fibrin molecules to aggregate and to form the "**soft**" clot. The soft clot is stabilized and strengthened by the action of **factor XIIIa, transglutaminase**. This enzyme catalyzes the formation of an **isopeptide linkage** by replacing the ϵ -amide group of glutamine residues of one chain with the ϵ -amino group of lysine residues of another chain (Figure 22.46) with the release of ammonia. This cross-linking of fibrin completes the steps involved in the formation of the hard clot.

Major Roles of Thrombin

α -Thrombin activates the protein cofactors V and VIII and it is also involved in **platelet aggregation**. Factor V is a 330,000 molecular weight protein. Activation of factor V by thrombin occurs through proteolytic cleavage at Arg⁷⁰⁹ and Arg¹⁵⁴⁵. Factor Va is a heterodimer consisting of an N-terminal domain of 105

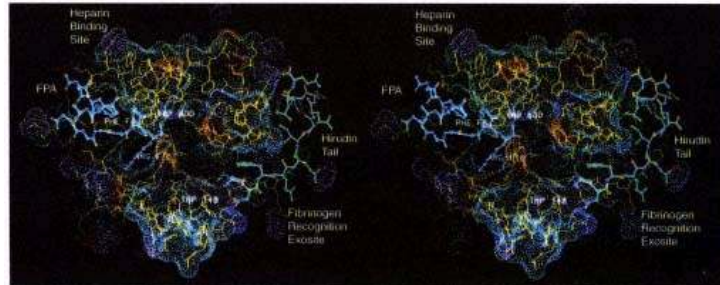

Figure 22.44
Stereo view of the active site cleft of human α -thrombin.
Dark blue, basic amino acids, red, acid; light blue, neutral. The active site goes from left to right. Figure courtesy of Dr. M. T. Stubbs II, Max-Planck Institut für Biochemie, Martinsreid, Germany.

kDa and a C-terminal domain of 74 kDa. These two subunits are noncovalently held together by a calcium ion (Figure 22.47).

Factor VIII circulates in plasma attached to another protein, **von Willebrand's factor (vWF)**. Factor VIII is a 285-kDa protein that is activated by thrombin cleavage at Arg³⁷², Arg⁷⁴⁰, Arg¹⁶⁴⁸, and Arg¹⁶⁸⁹. The latter cleavage releases VIIIa from vWF. Factor VIIIa is a heterotrimer (Figure 23.47) composed of N-terminal peptides of 40 kDa (A₂) and 50 kDa (A₁), and a C-terminal peptide of 74 kDa (A₃). Factor VIIIa also contains a Ca²⁺ bridge between the N- and C-terminal domains. Classic hemophilia results from a deficiency in factor VIII (see Clin. Corr. 22.10).

Thrombin also activates factor XIII, transglutaminase (Figure 22.48). **Protransglutaminase** exists in both plasma and platelets. The structural form of the platelet enzyme is $\alpha_2\beta_2$, whereas that of the plasma form is $\alpha_2\beta_2\gamma_2$. Thrombin cleaves the α subunit of both the platelet and the plasma forms of transglutaminase. Cleavage of the α subunit of the plasma form of the enzyme leads to dissociation of the β subunit, which is not catalytically active. The platelet form of the enzyme is released at the site of fibrin aggregation and is activated just by cleavage of the α subunit.

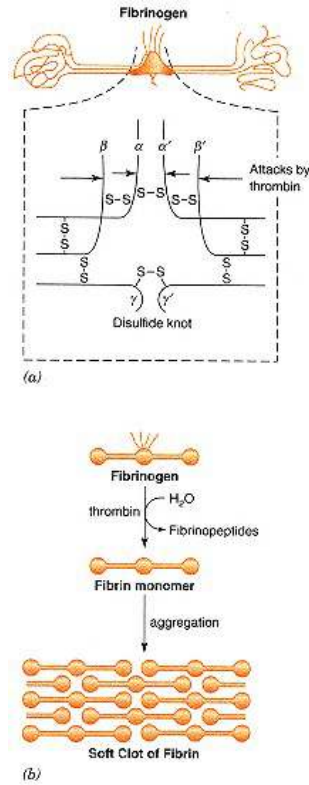

Figure 22.45
Diagrammatic representation
of the fibrinogen molecule and its
conversion to the soft clot of fibrin.

Formation of a Platelet Plug

The clumping of platelets at the site of injury is mediated by the presence of thrombin. There is a **thrombin receptor**, a member of the seven-transmembrane-domain family of receptors, on the outside of endothelial cells. This receptor is exposed upon injury and is activated by α -thrombin. **Aggregation of platelets** is facilitated by their initial binding to this activated receptor. In addition to the formation of a physical plug, platelets undergo a morphological change and release other chemicals that elicit other actions (Figure 22.49): ADP, serotonin, some types of phospholipids, and proteins that aid in coagulation and tissue repair. A glycoprotein, von Willebrand's factor (vWF) is released, concentrates in the area of the injury, and also forms a link between the exposed receptor and the platelets. von Willebrand's factor also serves as a carrier for factor VIII. Activation and release of factor VIII from vWF have been discussed.

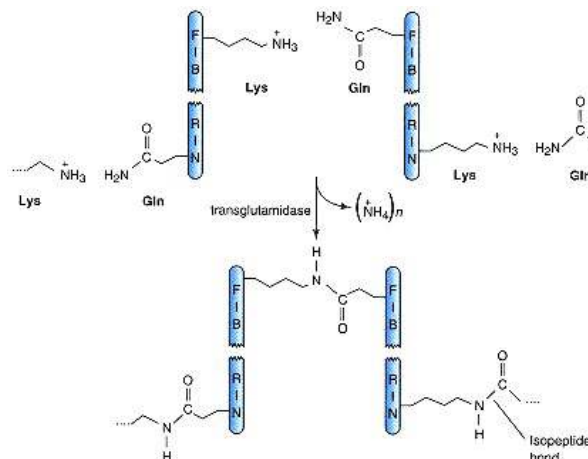

Figure 22.46
Reactions catalyzed by transglutaminase.

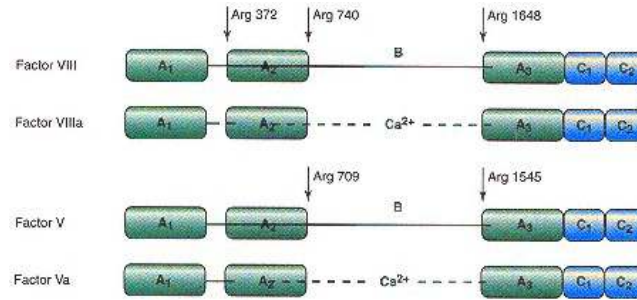

Figure 22.47
Organizational structure of cofactor proteins, factors VIII and V.
 Positions for thrombin cleavage are shown. A's and C's represent structural domains.
 Redrawn from Kalafatis, M., Swords, N. A., Rand, M. D., and Mann, K. G.
Biochim. Biophys. Acta 1227:113, 1994.

Platelet aggregation becomes autocatalytic with the release of ADP and **thromboxane A₂**. Platelet factor IV, **heparin binding protein**, prevents heparin–antithrombin III complexes from inhibiting serine proteinase coagulation factors, and it attracts cells with anti-inflammatory activity to the site of injury. About 20% of factor V exists in platelets as does one form of factor XIII, the transglutaminase.

Intact vascular endothelium does not normally initiate platelet aggregation since receptors and other elements are not exposed and activators such as ADP are rapidly degraded or are not in blood in sufficient concentration to be effective. The endothelium also secretes **prostacyclin(PGI₁)**, a potent inhibitor of platelet aggregation.

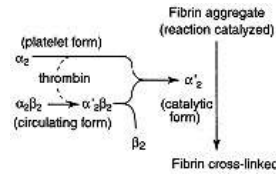

Figure 22.48
 Activation of transglutaminase by thrombin.

Properties of Some of the Proteins Involved in Coagulation

Calcium ions have at least two important functions in blood coagulation. They form complexes with factors that contain γ -carboxyglutamyl (Gla) residues and

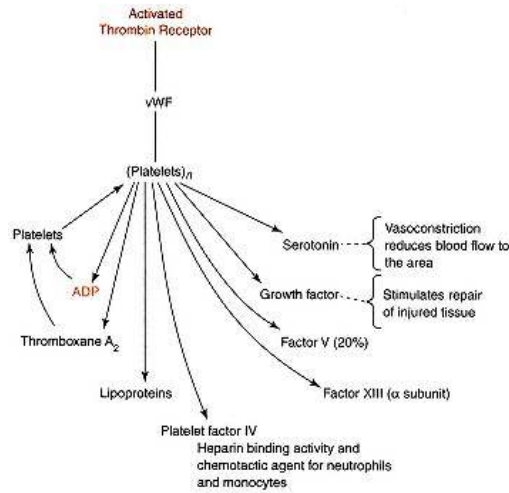

Figure 22.49
 Action of platelets in blood coagulation.

CLINICAL CORRELATION 22.10**Classic Hemophilia**

Hemophilia is an inherited disorder characterized by a permanent tendency for hemorrhages, spontaneous or traumatic, due to a defective blood clotting system. Classic hemophilia, hemophilia A, is an X-linked recessive disorder characterized by a deficiency of factor VIII. About 1 in 10,000 males is born with a deficiency of factor VIII. Of the approximate 25,000 hemophiliacs in the United States, more than 80% are of the A type. Hemophilia B is due to a dysfunction in factor IX.

Some hemophilia A patients may have a normal prothrombin time if the concentration of tissue factor is high. One possible explanation for this is that factor V in human plasma is much lower in concentration than factor X. Activation of an amount of factor X to Xa in excess of that required to bind all of factor Va would initiate blood clotting by the extrinsic pathway and give a normal prothrombin time. The intrinsic pathway would not function normally due to the deficiency in factor VIII. Without the two pathways operating in concert, the overall process of blood clotting would be impaired. Both factor Xa and thrombin activate factor V and are involved in a number of other reactions. If the overall process is not accelerated at its onset by intervention of the intrinsic pathway, due to kinetics of the interaction of thrombin and factor Xa with the normally low concentration of factor V, the clotting disorder is expressed. The blood levels of factor VII in severe hemophilia A patients are less than 5% of normal. These patients have generally been treated by blood transfusion with its associated dangers: the possibility of contraction of hepatitis or HIV, and the 6% possibility of patients making autoantibodies. Treatment of hemophiliacs has been made much safer as a result of cloning and expression of the gene for factor VIII. The pure protein can be administered to patients with none of the associated dangers mentioned above.

Nemerson, Y. *Blood* 71:1, 1988.

induce conformational and electronic states that facilitate their interaction with membrane "receptors" for initiation and localization of their reactions. Calcium ions also bind at sites other than Gla residues, producing protein conformational changes that enhance catalytic activity. Evidence for this second role for calcium ions comes from the observation that activation of at least one of the enzymes leads to both the cleavage and elimination of the N-terminal region containing the Gla residues, but calcium ions are still required for its effective participation in blood coagulation.

A schematic representation of the structural arrangement of five of the **Gla-containing proteins** listed in Table 22.9 is shown in Figure 22.50. Gla-containing residues are located in the N-terminal region of the molecules followed by a structural component that resembles epidermal growth factor. The position of proteolytic cleavage by activation proteinases is generally at an amino acid residue located between cysteine residues that form a disulfide bond. Activation may or may not result in loss of a small peptide. *Prothrombin is the only one whose activation is by cleavage outside the bridging disulfide bond and results in elimination of the Gla peptide.* Factor VII is activated by cleavage of a single Arg¹⁵²-Ile¹⁵³ bond. Factor IX is activated by cleavages at Arg¹⁴⁵ and Arg¹⁸⁰ with the release of an approximately 11-kDa peptide. Factor X consists of two chains connected by a disulfide bridge. It is activated by cleavage of its heavy chain at Arg¹⁹⁴-Ile¹⁹⁵. The Gla residues are located in the light chain. Protein C also consists of a heavy and a light chain connected by a disulfide bond. Cleavage of an Arg-Ile bond at position 169 results in its activation.

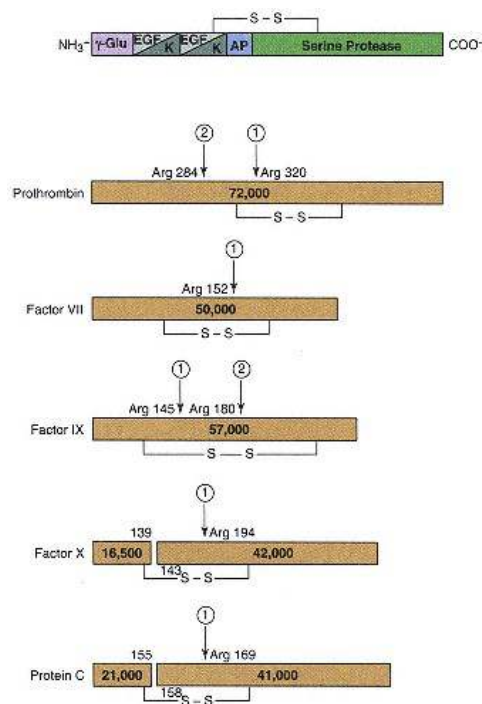

Figure 22.50

Gla-containing proteins.

- (a) General structure of the γ -carboxyglutamyl-containing proteins.
 (b) Structural organization of the zymogens and their cleavage sites for activation.

Role of Vitamin K in Protein Carboxylase Reactions

Modification of prothrombin, **protein C**, **protein S**, and factors VII, IX, and X to form Gla residues occurs during **synthesis** by a **carboxylase** located on the luminal side of the rough endoplasmic reticulum. **Vitamin K** (phytonadione, the "koagulation" vitamin) is an essential **cofactor** for this carboxylase. During the reaction, the dihydroquinone or reduced form of vitamin K (Figure 22.51), vit K(H₂), is oxidized to the epoxide form, vit K(O), using molecular oxygen. A plausible mechanism involves the addition of molecular oxygen to the C-1 position of dihydro-vitamin K and its subsequent rearrangement to an alkoxide with a pK_a of ~20. This intermediate serves as a strong base and abstracts a

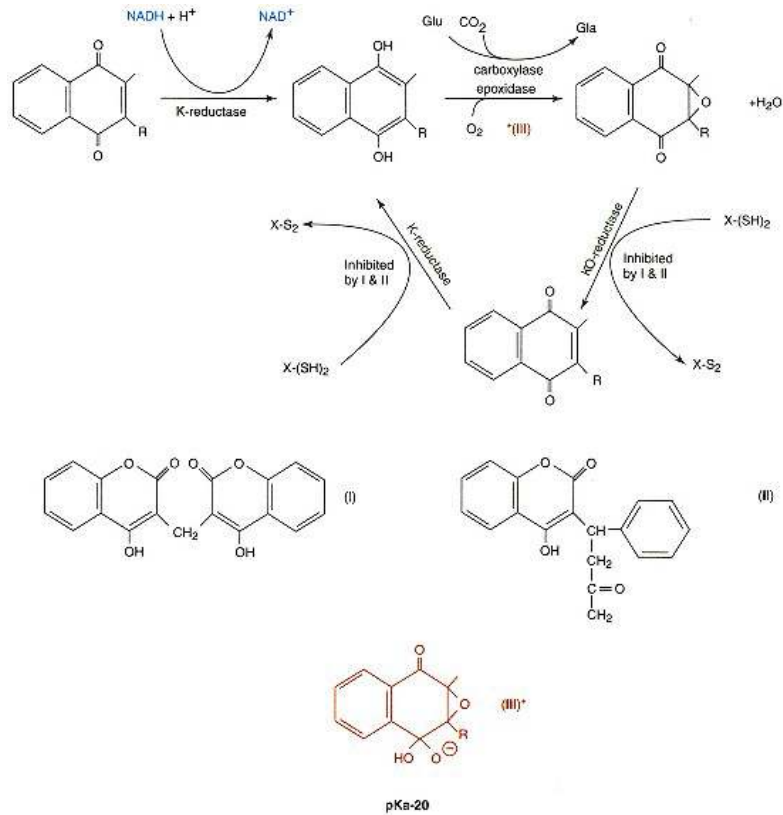

Figure 22.51

The vitamin K cycle as it functions in protein glutamyl carboxylation reaction.

X-(SH)₂ and X-S₂ represent the reduced and oxidized forms, respectively, of a thioredoxin. The NADH-dependent and the dithiol-dependent vitamin K reductases are different enzymes. The dithiol-dependent K and KO reductases are inhibited by dicumarol (I) and warfarin (II).
*Possible alkoxide intermediate (III).

Redrawn and modified from Vermeer, C. *Biochem. J.* 266:625, 1990.

proton from the γ -methylene carbon of glutamate, yielding a carbanion that can add to CO_2 by a nucleophilic mechanism (Figure 22.51). The **vitamin K epoxide** formed is converted back to the **dihydroquinone** by enzymes that require dithiols like **thioredoxin** as cofactors. Analogs of vitamin K inhibit dithiol-requiring vitamin K reductases and result in conversion of all available vitamin K to the epoxide form that is not functional in this reaction. The overall carboxylation reaction is

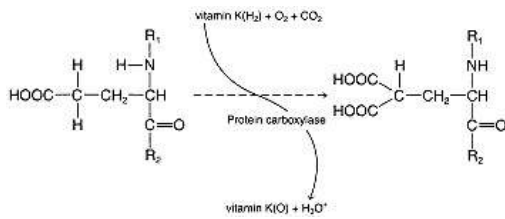

The structure of two analogs, **dicumarol** and **warfarin**, that interfere with the action of vitamin K are shown in Figure 22.51. In animals treated with these compounds, prothrombin, protein C, protein S, and factors VII, IX, and X are not posttranslationally modified, are deficient in Ca^{2+} binding, and cannot participate in blood coagulation. Dicumarol and warfarin have no effect on blood coagulation in the test tube.

Control of the Synthesis of Gla-Proteins

Gla-peptides that are released from prothrombin upon activation are removed from circulation by the liver. These N-terminal Gla-containing peptides stimulate the *de novo* synthesis of Gla-requiring proteins of the blood coagulation scheme (Figure 22.52). The proteins are synthesized even in the absence of vitamin K

CLINICAL CORRELATION 22.11

Thrombosis and Defects of the Protein C Pathway

Four major proteins are involved in the action of protein C in regulating blood coagulation: protein C itself; protein S, a cofactor for protein C action; factor Va; and factor VIIIa. The latter two are substrates for catalytic action of the protein C–protein S complex. Mutations, generally inherited, in any of them can result in venous thrombosis with various degrees of severity.

De novo mutations have also been identified in patients showing type I protein C deficiency. One was the result of a missense mutation, a transition of T to C, resulting in the change of a codon for amino acid residue 270 from TCG to CCG. This gave Pro instead of Ser at that position, resulting in a conformational change that affected activity. The gene for protein C is on chromosome 2 and has 9 exons and 8 introns. In another patient, a *de novo* mutation located at the exon VI–intron f junction was detected. A 5-bp deletion (underlined below) occurred, resulting in a "read through" of sections of the intron.

Exon VI \diamond Intron f

CAC CCC GCA G \diamond GTGAGAAGCCCCCAATAT

Normal sequence: **His Pro Ala**

CAC CCC GCA GGA GCC CCC AAT AT

Mutated sequence: **His Pro Ala Gly Ala Pro Asn**

The normally translated sequence is in bold type. The degree of severity of thrombotic events depends on the extent to which the gene inherited from the other parent is normal and the extent to which it is expressed.

Resistance to the action of activated protein C as a result of single point mutations in its substrates, factor Va and factor VIIIa, can occur. This prevents or retards their inactivation through the proteolytic action of protein C. The most commonly identified cause of inherited resistance to the action of activated protein C is single point mutations in the gene for factor V.

A third cause of protein C-related thrombosis is a defect in protein S. Fewer specific details are available that permit a definition of the mechanism of the interaction between protein C and protein S, and likewise of the mutations that affect its function. It is quite clear, however, that protein S deficiency leads to thrombotic events. Venous thrombosis occurs in almost one-half of patients at some stage of their lives if they have deficiencies in functional amounts of protein S.

Gandrille, S., Jude, B., Alhenc-gelas, M., et al. *Blood* 84:2566, 1994; Zoller, B., Bernsdotter, A., Garcia de Frutos, P., et al. *Blood* 85:3518, 1995; and Reistma, P. H., Bernardi, F., Doig, R. G., et al. *Thromb. Haemost.* 73:876, 1995.

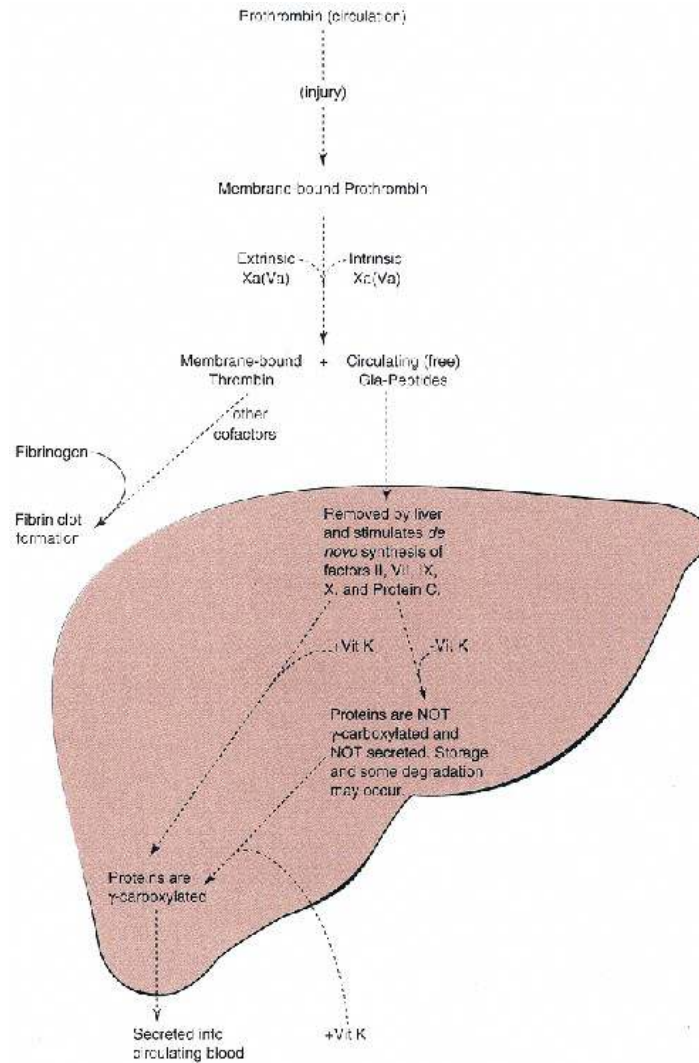

Figure 22.52

Role of Gla peptides in the regulation of *de novo* synthesis of coagulation factors.

or in the presence of antagonists of vitamin K. They are not secreted into the circulation, however. When vitamin K is restored, or is added in high enough concentrations to overcome the effects of antagonists, the preformed proteins are carboxylated and secreted into the circulation.

Activation of blood coagulation is a one-way process. The use of the activation peptides released from prothrombin to signal the liver to synthesize more of these proteins is an efficient mechanism for maintaining their concentrations in blood at effective levels. Monitoring of patients on long-term therapy with vitamin K antagonists is necessary to assure that posttranslational modification to produce the Gla-containing proteins is not shut down completely.

Dual Role of Thrombin in Promoting Coagulation and Clot Dissolution

The process of blood coagulation is self-controlling. One protein involved is **protein C**. Protein C, a Gla-containing protein, is activated in a membrane-

bound complex of thrombin, **thrombomodulin**, and calcium. Thrombomodulin is an integral glycoprotein of the endothelial cell membrane that contains 560 amino acid residues. Thrombomodulin shows amino acid **sequence homology** with the **low-density lipoprotein receptor** but very little with tissue factor. There is, however, a great deal of similarity in functional domains between tissue factor and thrombomodulin, each of which functions as a receptor and activator for a proteinase. Thrombomodulin carries out this function for thrombin for activation of the proteinase, protein C. Binding of thrombin to thrombomodulin reduces its catalytic specificity for fibrinogen and enhances its specificity for protein C. Protein C inhibits coagulation by

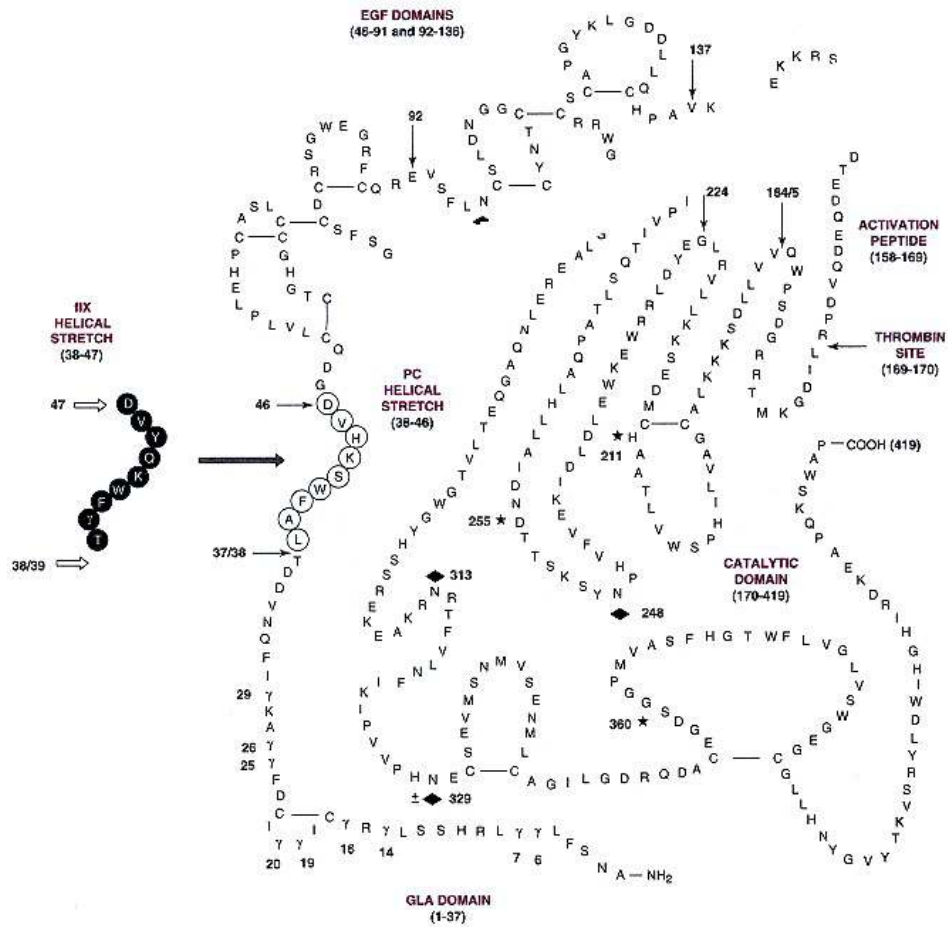

Figure 22.53

Primary structure of recombinant protein C.

Redrawn with permission from Christiansen, W. T., Geng, J. P., and Castellino, F. J. *Biochemistry* 34:8082, 1995. Copyright 1995 American Chemical Society.

inactivating factors Va and VIIIa. Another Gla-containing protein, **protein S** (a 75-kDa protein), is a cofactor for protein C. Deficiency in protein S and/or protein C, leads to **thrombotic diseases** (see Clin. Corr. 22.11). A schematic representation of protein C showing some of its reactive regions is depicted in Figure 22.53.

The Allosteric Role of Thrombin in Controlling Coagulation

Important reactions of thrombin relative to its dual role in the processes of promoting and stopping coagulation are summarized in Figure 22.54. Thrombin exists in two conformational forms: one is stabilized by Na⁺ and has high

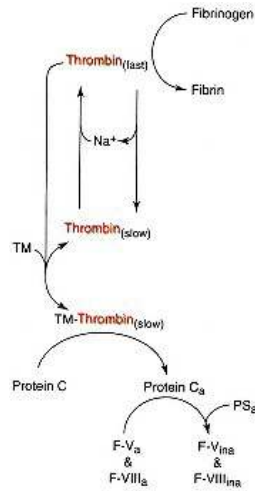

Figure 22.54
Allosteric reactions of thrombin and its actions on fibrinogen and protein C.

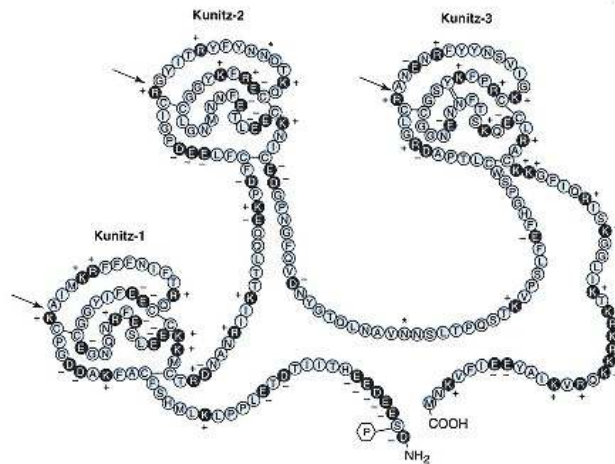
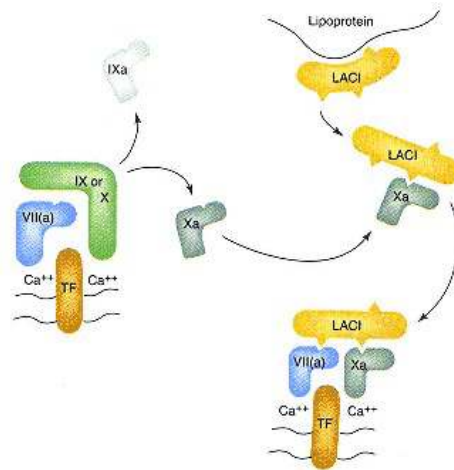

Figure 22.55

Proposed mechanism of inhibition of the extrinsic pathway.

LACI is lipoprotein-associated coagulation factor whose structure is shown in (b). Kunitz domain 1 inhibits factor VIIa and Kunitz domain 2 inhibits factor Xa. Arrows indicate the presumed location of the active-site inhibitor region for each domain. Redrawn with permission from Broze, G. J., Girard, T. J., and Novotny, W. F. *Biochemistry* 29:7539, 1990. Copyright 1990 American Chemical Society.

specificity for catalyzing the conversion of fibrinogen to fibrin; the other conformational form predominates in the absence of sodium, has low specificity for fibrinogen conversion, but high specificity for thrombomodulin binding and activity on protein C. These forms are referred to as "fast" and "slow," respectively. This dynamic "**feedback**" **mechanism** is important for stopping the clotting process at its point of origin. Many thrombotic diseases are associated with mutations in protein C that affect its activation by thrombin.

Inhibitors of the Plasma Serine Proteinases

Proteinase inhibitors in blood interact with enzymes of the blood coagulation system. Most of these fit into the serpin family of inhibitors. The term **serpin** was coined by Carrell and Travis and stands for **serine** proteinase **inhibitor**. There is a tertiary structural similarity between them with a common core domain of about 350 amino acids. **Antithrombin III** is one of the major serpins and inhibits most of the serine proteinases of coagulation. Inhibition of the proteinases is a **kinetic process** that can begin almost as soon as coagulation itself begins. Initially, formation of inhibitor complexes is slow because the concentrations of the enzymes with which the inhibitors interact are low. As activation of the enzymes proceeds, inhibition increases and becomes more prominent. These reactions, and destruction of protein cofactors, eventually stop the coagulation process completely. In general, **proteinase-inhibitor complexes** do not dissociate readily and are removed intact from blood by the liver.

Inhibition of the extrinsic pathway, that is, the TF-VIIa-Ca²⁺-Xa complex, is unique and involves specific interaction with a **lipoprotein-associated coagulation inhibitor (LACI)**, formerly known as **anticonvertin**. LACI is a 32-kDa protein that contains three tandem domains (Figure 22.55, p. 974). Each domain is a functionally homologous protease inhibitor that resembles other individual protease inhibitors such as the bovine **pancreas trypsin inhibitor**. LACI inhibits the extrinsic pathway by interacting specifically with the TF-VIIa-Ca²⁺-Xa complex. Domain 1 binds to factor Xa and domain 2 binds to factor VIIa of the complex. Binding of LACI to VIIa does not occur unless Xa is present. The uniqueness of this reaction is that LACI is a multi-enzyme inhibitor in which each of its separate domains inhibits the action of one of the enzymes of the multi-enzyme complex of the extrinsic pathway.

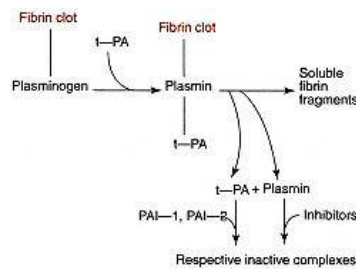

Figure 22.56
Reactions involved in clot dissolution.

Fibrinolysis Requires Plasminogen and Tissue Plasminogen Activator (t-PA) to Produce Plasmin

Reactions of **fibrinolysis** are shown in Figure 22.56. Lysis of the fibrin clot occurs through action of the enzyme **plasmin**, which is formed from **plasminogen** through the action of **tissue plasminogen activator (t-PA or TPA)**. Plasminogen has high affinity for fibrin clots and forms complexes with fibrin throughout various regions of the fibrin network. t-PA also binds to fibrin clots and activates plasminogen to plasmin by specific bond cleavage. The clot is then solubilized by the action of plasmin.

t-PA is a 72-kDa protein with several functional domains. It has a growth factor domain near its N terminus, two adjacent **Kringle domains** that interact with fibrin, and a domain with protease activity that is close to its C terminus. Kringle domains are conserved sequences that fold into large loops stabilized by disulfide bonds. These domains are important structural features for protein-protein interactions that occur with several blood coagulation factors. t-PA is activated by cleavage between an Arg-Ile bond, resulting in a molecule with a heavy and a light chain. The serine protease activity is located within the light chain.

Activity of t-PA is regulated by protein inhibitors. Four immunologically distinct types of inhibitors have been identified, two of which are of greater physiological significance because they react rapidly with t-PA and are specific for it. They are **plasminogen activator-inhibitor type 1 (PAI-1)** and **plasminogen activator-inhibitor type 2 (PAI-2)**. The human PAI-2 is a 415 amino acid protein.

Starting and stopping blood coagulation follow essentially the same type process, binding and proteolysis. Both are one-way processes and the only mechanism for replenishing the proteins once they are used is by resynthesis.

Bibliography

General

Alberts, B., Bray, D., Lewis, J., Raff, M., Roberts, K., and Watson, J. *Molecular Biology of the Cell*, 2nd ed. New York: Garland Publishing, 1989.

Nerve

Bennett, M. K., and Scheller, R. H. The molecular machinery for secretion is conserved from yeast to neurons. *Proc. Natl. Acad. Sci. USA* 90:2559, 1993.

Fried, G. Synaptic vesicles and release of transmitters: new insights at the molecular level. *Acta Physiol. Scand.* 154:1, 1995.

Greengard, P., Valtorta, F., Czernik, A. J., and Benfenati, F. Synaptic vesicle phosphoproteins and regulation of synaptic function. *Science* 259:780, 1993.

Grenningloh, G., Rienitz, A., Schmitt, D., et al. The strychnine-binding subunit of the glycine receptor shows homology with nicotinic acetylcholine receptors. *Nature* 328:215, 1987.

Goodman, S. R., Zimmer, W. E., Clark, M. B., Zegon, I. S., Barker, J. E., and Bloom, M. L. Brain spectrin: of mice and men. *Brain Res. Bull.* 36:593, 1995.

Pleribone, V. A., Shuplakov, O., Brodin, L., Hilfiker-Rothenfluh, S., Czernik, A. J., and Greengard, P. Distinct pools of synaptic vesicles in neurotransmitter release. *Nature* 375:493, 1995.

Sudhof, T. The synaptic vesicle cycle: a cascade of protein-protein interactions. *Nature* 375:645, 1995.

Taylor, P. The cholinesterases. *J. Biol. Chem.* 266:4025, 1991.

Vision

Abrahamson, E. W., and Ostroy, S. E. (Eds.). *Molecular Processes in Vision*, Benchmark Papers in Biochemistry/3. Stroudsburg, PA: Hutchinson Ross Publishing, 1981.

Farber, D. B. From mice to men: the cyclic GMP phosphodiesterase gene in vision and disease. *Invest. Ophthalmol. Vis. Sci.* 36:263, 1995.

Nathans, J. Molecular biology of visual pigments. *Annu. Rev. Neurosci.* 10:163, 1987.

Nathans, J., Davenport, C. M., Maumenee, I. H., et al. Molecular genetics of human blue cone monochromacy. *Science* 245:831, 1989.

Palczewski, K. Is vertebrate phototransduction solved? New insights into the molecular mechanism of phototransduction. *Invest. Ophthalmol. Vis. Sci.* 35:3577, 1994.

Stryer, L. Visual excitation and recovery. *J. Biol. Chem.* 266:10711, 1991.

Zigler, J. S. Jr., and Goosey, J. Aging of protein molecules: lens crystallins as a model system. *Trends Biochem. Sci.* 7:133, 1981.

Muscle

Anderson, P. A. W., Malouf, N. N., Oakley, A. E., Pagani, E. D., and Allen, P. D. Troponin T isoform expression in humans: a comparison among normal and failing adult heart, fetal heart, and adult and fetal skeletal muscle. *Circ. Res.* 69:1226, 1991.

Carlier, M.-F. Actin: protein structure and filament dynamics. *J. Biol. Chem.* 266:1, 1991.

da Silva, A. C. R., and Reinach, F. C. Calcium binding induces conformational changes in muscle regulatory proteins. *Trends Biochem. Sci.* 16:53, 1991.

dos Remedios, C. G., and Moens, P. D. J. Actin and the actomyosin interface: a review. *Biochim. Biophys. Acta* 1228:99, 1995.

Ebashi, S. Excitation-contraction coupling and the mechanism of muscle contraction. *Annu. Rev. Physiol.* 53:1, 1991.

Gerisch, G., Noegel, A. A., and Schleicher, M. Genetic alteration of proteins in actin-based motility systems. *Annu. Rev. Psychol.* 53:607, 1991.

Hirose, K., Franzini-Armstrong, C., Goldman, Y. E., and Murray, J. M. Structural changes in muscle crossbridges accompanying force generation. *J. Cell Biol.* 127:763, 1994.

Huxley, H. E. The mechanism of muscular contraction. *Science* 164:1356, 1969.

Lorenz, M., Popp, D., and Holmes, K. C. Refinement of the F-actin model against X-ray fiber diffraction data by the use of a directed mutation algorithm. *J. Mol. Biol.* 234:826, 1993.

Blood

Antalis, T. M., Clark, M. A., Barnes, T., et al. Cloning and expressing of a cDNA coding for a human monocyte-derived plasminogen activator inhibitor. *Proc. Natl. Acad. Sci. USA* 85:985, 1988.

Colombatti, A., and Bonaldo, P. The superfamily of proteins with von Willebrand factor type A-like domains: one theme common to components of extracellular matrix, hemostasis, cellular adhesion, and defense mechanisms. *Blood* 77:2305, 1991.

Cooper, D. N. The molecular genetics of familial venous thrombosis. *Blood Rev.* 5:55, 1991.

Dowd, P., Hershline, R., Ham, S. W., and Naganathan, S. Vitamin K and energy transduction: a base strength amplification mechanism. *Science* 269:1684, 1995.

Hessing, M. The interaction between complement component C4b-binding protein and the vitamin K-dependent protein S forms a link between blood coagulation and the complement system. *Biochem. J.* 277:581, 1991.

Kalafatis, M., Sworde, N. A., Rand, M. D., and Mann, K. G. Membrane-dependent reactions in blood coagulation: role of the vitamin K-dependent enzyme complexes. *Biochim. Biophys. Acta* 1227:113, 1994.

Kuliopulus, A., Hubbard, B. R., Lam, Z., Koski, I. J., Furie, B., Furie, B. C., and Walsh, C. T. Dioxygen transfer during vitamin K-dependent carboxylase catalysis. *Biochemistry* 31:7722, 1992.

McClure, D. B., Walls, J. D., and Grinnell, B. W. Post-translational processing events in the secretion pathway of human protein C, a complex vitamin K-dependent antithrombotic factor. *J. Biol. Chem.* 267:19710, 1992.

Ny, T., Elgh, F., and Lund, B. The structure of the human tissue-type plasminogen activator gene: correlation of intron and exon structures to functional and structural domains. *Proc. Natl. Acad. Sci. USA* 81:5355, 1984.

Palston, P. A., and Gettings, P. G. W. A database of recombinant wild-type and mutant serpins. *Thromb. Haemost.* 72:166, 1994.

Reitsma, P. H., Bernardi, F., Doig, R. G., et al. Protein C deficiency: a database of mutations, 1995 update. *Thromb. Haemost.* 73:876, 1995.

Vermeer, C. γ -Carboxyglutamate-containing proteins and the vitamin K-dependent carboxylase. *Biochem. J.* 266:625, 1990.

Zeheb, R., and Gelehrter, T. D. Cloning and sequencing of cDNA for the rat plasminogen activator inhibitor-1. *Gene* 73:459, 1988.

Questions

C. N. Angstadt and J. Baggott

- In the propagation of a nerve impulse by an electrical signal:
 - the electrical potential across the membrane maintained by the ATP-driven Na^+, K^+ ion pump becomes more negative.
 - local depolarization of the membrane causes protein conformational changes that allow Na^+ and K^+ to move down their concentration gradients.
 - charge propagation is bidirectional along the axon.
 - "voltage-gated" ion channels have a finite recovery time so the amplitude of the impulse changes as it moves along the axon.
 - astrocytes are the antenna-like protrusions that receive signals from other cells.
- All of the following are characteristics of nonpeptide neurotransmitters EXCEPT:
 - they transmit the signal across the synapse between cells.
 - they must be made in the cell body and then travel down the axon to the presynaptic terminal.
 - electrical stimulation increasing Ca^{2+} in the presynaptic terminal fosters their release from storage vesicles.
 - binding to receptors on the postsynaptic terminal induces a conformational change in proteins of that membrane.
 - their actions are terminated by specific mechanisms within the synaptic junction.

Refer to the following for Questions 3–5.

- acetylcholine
 - 4-aminobutyrate (GABA)
 - catecholamines
 - 5-hydroxytryptamine (serotonin)
- Binding to its receptor opens a channel for Cl^- , causing hyperpolarization of the cell.
 - Termination of the signal typically involves the actions of both methyltransferase and monoamine oxidase, as well as reuptake into the presynaptic neuron.
 - Action is terminated by an esterase.
 - Which of the following is a correct statement about biochemical events occurring in the eye is (are) true?
 - Glucose in the lens is metabolized by the TCA cycle in order to provide ATP for the Na^+, K^+ -ATPase.
 - Controlling the blood glucose level might reduce the incidence of diabetic cataracts by allowing the production of sorbitol.
 - The high rate of the hexose monophosphate pathway in the cornea is necessary to provide NADPH as a substrate for glutathione reductase.
 - The retina contains mitochondria so it depends on the TCA cycle for its production of ATP.
 - Cataracts are the result of increasing blood flow in the lens leading to disaggregation of lens proteins.
 - Which of the following statements about rhodopsin is true?
 - Rhodopsin is the primary photoreceptor of both rods and cones.
 - The prosthetic group of rhodopsin is all-*trans*-retinol derived from cleavage of β -carotene.
 - Conversion of rhodopsin to activated rhodopsin, R^* , by a light pulse requires depolarization of the cell.
 - Rhodopsin is located in the cytosol of the cell.
 - Absorption of a photon of light by rhodopsin causes an isomerization of 11-*cis*-retinal to all-*trans*-retinal.
 - All of the following statements about the transduction of the light signal on rhodopsin are true EXCEPT:
 - cGMP is involved in the transmission of the signal between the disk membrane and the plasma membrane.
 - it involves the G-protein, transducin.
 - cGMP concentration is increased in the presence of an activated rhodopsin–transducin–GTP complex.
 - the signal is turned off, in part, by the GTPase activity of the α subunit of transducin.
 - both guanylate cyclase and phosphodiesterase are regulated by calcium concentration.
 - The cones of the retina:
 - are responsible for color vision.
 - are much more numerous than the rods.
 - have red, blue, and green light-sensitive pigments that differ because of small differences in the retinal prosthetic group.
 - do not use transducin in signal transduction.
 - are better suited for discerning rapidly changing visual events because a single photon of light generates a stronger current than it does in the rods.
 - When a muscle contracts, the:
 - transverse tubules shorten, drawing the myofibrils and sarcoplasmic reticulum closer together.
 - thin filaments and the thick filaments of the sarcomere shorten.
 - light chains dissociate from the heavy chains of myosin.
 - H bands and I bands of the sarcomere shorten because the thin filaments and thick filaments slide past each other.
 - cross-linking of proteins in the heavy filaments increases.
 - All of the following statements about actin and myosin are true EXCEPT:
 - the globular head section of myosin has domains for binding ATP and actin.
 - actin is the major protein of the thick filament.
 - the binding of ATP to the actin–myosin complex promotes dissociation of actin and myosin.
 - F-actin, formed by aggregation of G-actin–ATP– Mg^{2+} complex, is stabilized when tropomyosin is bound to it.
 - binding of calcium to the calmodulin-like subunit of troponin induces conformational changes that permit myosin to bind to actin.
 - ATP concentration is maintained relatively constant during muscle contraction by:
 - increasing the metabolic activity.
 - the action of adenylate kinase.
 - the action of creatine phosphokinase.
 - all of the above.
 - none of the above.

13. The nerve impulse that initiates muscular contraction:

- A. begins with the binding of acetylcholine to receptors in the sarcoplasmic reticulum.
- B. causes both the plasma membrane and the transverse tubules to undergo hyperpolarization.
- C. causes opening of calcium channels, which leads to an increase in calcium concentration within the sarcomere.
- D. prevents Na^+ from entering the sarcomere.
- E. prevents Ca^{2+} from binding to troponin C.

14. Platelet aggregation:

- A. is initiated at the site of an injury by conversion of fibrinogen to fibrin.
- B. is inhibited in uninjured blood vessels by the secretion of prostacyclin by intact vascular endothelium.
- C. causes morphological changes and a release of the vasodilator, serotonin.
- D. is inhibited by the release of ADP and thromboxane A_2 .
- E. is inhibited by von Willebrand factor (vWF).

15. In the formation of a blood clot:

- A. proteolysis of γ -carboxyglutamate residues from fibrinogen to form fibrin is required.
- B. the clot is stabilized by the cross-linking of fibrin molecules by the action of factor XIII, transglutaminase.
- C. antagonists of vitamin K inhibit the formation of γ -carboxyglutamate residues in various proteins, thus facilitating the clotting process.
- D. tissue factor, factor III, must be inactivated for the clotting process to begin.
- E. the role of calcium is primarily to bind fibrin molecules together to form the clot.

16. Factor Xa, necessary for conversion of prothrombin to thrombin, is formed by the action of the TF–VII– Ca^{2+} complex on factor X:

- A. only in the extrinsic pathway for blood clotting.
- B. only in the intrinsic pathway for blood clotting.
- C. as part of both the extrinsic and intrinsic pathways.
- D. only if the normal blood clotting cascade is inhibited.

17. Lysis of a fibrin clot:

- A. is in equilibrium with formation of the clot.
- B. begins when plasmin binds to the clot.
- C. requires the hydrolysis of plasminogen into heavy and light chains.
- D. is regulated by the action of protein inhibitors on plasminogen.
- E. requires the conversion of plasminogen to plasmin by t-PA (tissue plasminogen activator).

Answers

1. B This is the mechanism for impulse propagation. A: The potential becomes less negative. C: It is unidirectional. D: "Voltagegated" channels do have a finite recovery time so the amplitude remains constant. E: This describes dendrites. Astrocytes are glial cells that are involved in processes isolating the CNS from the external environment (pp. 921–923).
2. B This is true for neuropeptides, but many nonpeptide neurotransmitters are synthesized in the presynaptic terminal (pp. 923–924). A: This is a difference between electrical and chemical signals (p. 921). C: What is the role of synapsin I in this process (p. 925)? E: Make sure you know the three types of processes involved (p. 927).
3. B GABA is an inhibitory neurotransmitter. All the others are excitatory ones that cause depolarization of the cells (p. 931).
4. C Methylation by catecholamine-*O*-methyltransferase is an important part of the metabolism of the catecholamines. A: Acetylcholinesterase terminates the action of this (p. 928). B: GABA is converted into an intermediate of the TCA cycle (p. 931). D: Monoamine oxidase is the primary enzyme responsible for terminating serotonin's action (p. 930).
5. A The enzyme is acetylcholinesterase (p. 928).
6. C Make sure you understand the role of glutathione in protecting against harmful by-products from atmospheric oxygen (p. 933). A: Most of the ATP (85%) in the lens is generated by glycolysis (p. 934). B: Controlling glucose reduces sorbitol formation (p. 935). D: Its metabolism is similar to that of other eye tissues directly involved in the visual process. Thus its major source of energy is from glycolysis (p. 935). E: Lens has no blood supply. In diabetic cataracts there is increased aggregation of lens proteins because of increasing sorbitol (p. 935).
7. E This causes the conformational change of the protein that affects the resting membrane potential and initiates the rest of the events. A: Cones have the same prosthetic group but different proteins, so rhodopsin is in rods only (p. 937). B: This is the precursor of the prosthetic group 11-*cis*-retinal (p. 938). C: Isomerization of the prosthetic group leads to hyperpolarization (p. 939 Figure 22.20). D: Rhodopsin is a transmembrane protein (p. 937).
8. C The transducin complex activates the phosphodiesterase, thus lowering [cGMP] (p. 942). A: This is an example of a second messenger type chemical synapse. B and D: Transducin meets the criteria for a typical G-protein. E: The enzymes are regulated in opposite directions by Ca^{2+} , thus controlling [cGMP] (p. 943).
9. A Rods are responsible for low light vision. C: All three pigments have 11-*cis*-retinal; the proteins differ and are responsible for the slightly different spectra (pp. 937 and 944). D: The biochemical events are believed to be the same in rods and cones (p. 944). E: Cones are better suited for rapid events because their response rate is about four times faster than rods, even though their sensitivity to light is much less (p. 945).
10. D This occurs because of association–dissociation of actin and myosin (pp. 948 and 957). A: Depolarization in the transverse tubules may be involved in transmission of the signal but not directly in the contractile process (p. 954). B: The filaments do not change in length, but slide past each other (p. 948). C: This is not physiological. E: Cross-linking occurs in the H band of the sarcomere but does not change during the contractile process (p. 953).
11. B A: See Figure 22.28. C: Note that the role of ATP in contraction is to favor dissociation, not formation, of the actin–myosin

- complex (p. 957). D. and E: Tropomyosin, troponin, and actin are the three major proteins of the filament. Their actions are closely interconnected (pp. 951–953).
12. D Make sure you know the reactions catalyzed by these two enzymes (pp. 954–957).
13. C A: Acetylcholine receptors are on the plasma membrane. B: The impulse results in depolarization of both of these structures. D: Both Ca^{2+} and Na^{2+} enter the sarcomere when the channels open. E: Binding of Ca^{+2} to Tn-C initiates contraction (p. 954).
14. B The "ying–yang" nature of PGI_2 and TXA_2 help to control platelet aggregation until there is a need for it. A: Initiation is by contact with an activated receptor at the site of injury. Clot formation requires activation of various enzymes (pp. 960–961). C: Serotonin is a vasoconstrictor. Vasodilation would be contraindicated in this situation (p. 967). D: TXA_2 facilitates aggregation. E: vWF forms a link between the receptor and platelets, promoting aggregation (p. 967).
15. B The cross-linking occurs between a glutamine and a lysine (Figure 22.46). A and E: γ -Carboxyglutamate residues are on various enzymes; they bind calcium and facilitate the interaction of these proteins with membranes that form the sites for initiation of reaction (pp. 968–969). C: Vitamin K is an activator for the γ -carboxylation reaction, which is a necessary posttranslational modification of some of the enzymes involved in clot formation (p. 970). D: TF, factor III, is the primary receptor for initiation of the clotting process (p. 963).
16. A Tissue factor and factor VII are unique to the extrinsic pathway. B,C: The membrane interaction with the intrinsic pathway is with high-molecular-weight kininogen and pre-kallikrein (p. 961).
17. E The clot is solubilized by plasmin. A: Both formation and lysis of clots are unidirectional. B: Both plasminogen and t-PA bind to the clot. C and D: Both of these refer to t-PA (pp. 975–976).

Chapter 23— Biotransformations: The Cytochromes P450

Richard T. Okita and Bettie Sue Siler Masters

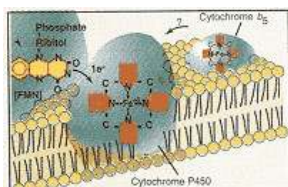

23.1 Overview	982
23.2 Cytochromes P450: Nomenclature and Overall Reaction	982
23.3 Cytochromes P450: Multiple Forms	984
Multiplicity of Genes Produces Many Forms of Cytochrome P450	984
Substrate Specificity	985
Induction of Cytochromes P450	985
Polymorphisms	986
23.4 Inhibitors of Cytochromes P450	986
23.5 Cytochrome P450 Electron Transport Systems	987
NADPH–Cytochrome P450 Reductase Is the Flavoprotein Donor in the Endoplasmic Reticulum	988
NADPH–Adrenodoxin Reductase Is the Flavoprotein Donor in Mitochondria	989
23.6 Physiological Functions of Cytochromes P450	989
Cytochromes P450 Participate in Synthesis of Steroid Hormones and Oxygenation of Eicosanoids	990
Cytochromes P450 Oxidize Exogenous Lipophilic Substrates	992
23.7 Other Hemoprotein- and Flavoprotein-Mediated Oxygenations: The Nitric Oxide Synthases	995
Three Distinct Nitric Oxide Synthase Gene Products Display Diverse Physiological Functions	995
Structural Aspects of Nitric Oxide Synthases	996
Bibliography	997
Questions and Answers	998
Clinical Correlations	
23.1 Consequences of Induction of Drug-Metabolizing Enzymes	986
23.2 Genetic Polymorphisms of Drug-Metabolizing Enzymes	987
23.3 Deficiency of Cytochrome P450 Steroid 21-Hydroxylase (CYP21A2)	992
23.4 Steroid Hormone Production during Pregnancy	993
23.5 Clinical Aspects of Nitric Oxide Production	996

23.1— Overview

The term **cytochrome P450** refers to a family of **heme proteins** present in all mammalian cell types, except mature red blood cells and skeletal muscle cells, which catalyze oxidation of a wide variety of structurally diverse compounds. Cytochrome P450 also occurs in prokaryotes. Substrates for this enzyme system include endogenously synthesized compounds, such as steroids and fatty acids (including prostaglandins and leukotrienes), and exogenous compounds, such as drugs, food additives, or industrial by-products that enter the body through food sources, injection, inhalation from the air, or absorption through the skin. The cytochrome P450 system has far-reaching effects in medicine. It is involved in (1) inactivation or activation of therapeutic agents; (2) conversion of chemicals to highly reactive molecules, which may produce unwanted cellular damage, cell death, or mutations; (3) production of steroid hormones; and (4) metabolism of fatty acids and their derivatives. Other heme-binding, cysteine thiolate-containing proteins also exist, including thromboxane, prostacyclin, and allene oxide synthases, as well as the **nitric oxide synthases**. This chapter will address the cytochromes P450 in detail and will introduce the isoforms of nitric oxide synthase. Clinical implications of these oxygenation systems will be presented.

23.2— Cytochromes P450: Nomenclature and Overall Reaction

Designation of a particular protein as a cytochrome P450 originated from its spectral properties before its catalytic function was known. This group of proteins has a unique absorbance spectrum that is obtained by adding a reducing agent, such as sodium dithionite, to a suspension of **endoplasmic reticulum** vesicles, frequently referred to as **microsomes**, followed by bubbling of carbon monoxide gas into the solution. Carbon monoxide is bound to the reduced heme protein and produces an absorbance spectrum with a peak at approximately 450 nm (Figure 23.1); thus the name P450 for a pigment with an absorbance at 450 nm. Specific forms of cytochrome P450 differ in their maximum absorbance wavelengths, with a range between 446 and 452 nm. The many forms of cytochrome P450 are classified, according to their sequence similarities, into various **gene subfamilies**; this system of **nomenclature** is being adopted almost universally. Individual cytochrome P450 forms are given an Arabic number to designate a specific family, followed by a capital letter to identify its subfamily, followed by another Arabic number designating the individual P450 form, for example, 1A2 or 2D6. The term **CYP**, which represents the first two letters of cytochrome and the first letter in P450, is used as a preface to designate a gene or protein as a cytochrome P450 form. Thus cytochromes P450 1A2 and P450 2D6 are designated CYP1A2 and CYP2D6 in this nomenclature system. Members of the same family share at least 40% amino acid sequence homology and members of the same subfamily share at least 55% sequence homology. Table 23.1 lists several human cytochrome P450 forms. In certain families several subfamilies have been identified such as in CYP2 (CYP2A and CYP2B) and CYP4 (CYP4A and CYP4B), whereas in others only a single gene has been reported (CYP17, CYP19, and CYP21).

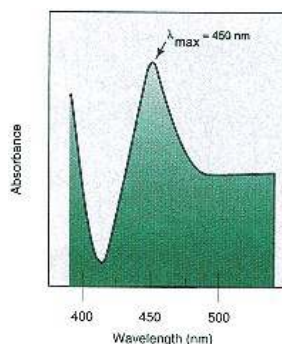
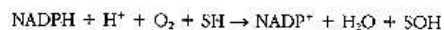

Figure 23.1
Absorbance spectrum of the carbon monoxide-bound cytochrome P450.
The reduced form of this heme protein binds carbon monoxide to produce a maximum absorbance at approximately 450 nm. Hence this cytochrome was designated P450.

The general reaction catalyzed by cytochrome P450 is written as follows:



where the substrate (S) may be a steroid, fatty acid, drug, or other chemical that has an alkane, alkene, aromatic ring, or heterocyclic ring substituent that can serve as a site for oxygenation. The reaction is referred to as a monooxygenation and the enzyme as a **monooxygenase** because only one of the two oxygen atoms is incorporated into the substrate. In mammalian cells, cytochromes P450

TABLE 23.1 Human Cytochrome P450 Forms

<i>Cytochrome P450 Subfamilies</i>							
<i>CYP1</i>	<i>CYP2</i>	<i>CYP3</i>	<i>CYP4</i>	<i>CYP11</i>	<i>CYP17</i>	<i>CYP19</i>	<i>CYP21</i>
<i>Individual Forms</i>							
1A1	2A6	3A3	4A9	11A1			21A2
1A2	2A7	3A4	4A11	11B1			
	2B6	3A5	4B1	11B2			
	2C8	3A7	4F2				
	2C9		4F3				
	2C10						
	2C18						
	2C19						
	2D6						
	2E1						

serve as terminal electron acceptors in **electron transport systems**, which are present either in the endoplasmic reticulum or **inner mitochondrial membrane**. The cytochrome P450 proteins contain a single iron **protoporphyrin IX** prosthetic group (see p. 1009), which binds oxygen, and the resulting heme protein contains binding sites for the substrate. Heme iron of all known cytochromes P450 is bound to the four pyrrole nitrogen atoms of the porphyrin ring and two axial ligands, one of which is a sulfhydryl group from a cysteine residue located toward the carboxyl end of the molecule (Figure 23.2). Heme iron may exist in two different spin states: (1) a hexa-coordinated low-spin

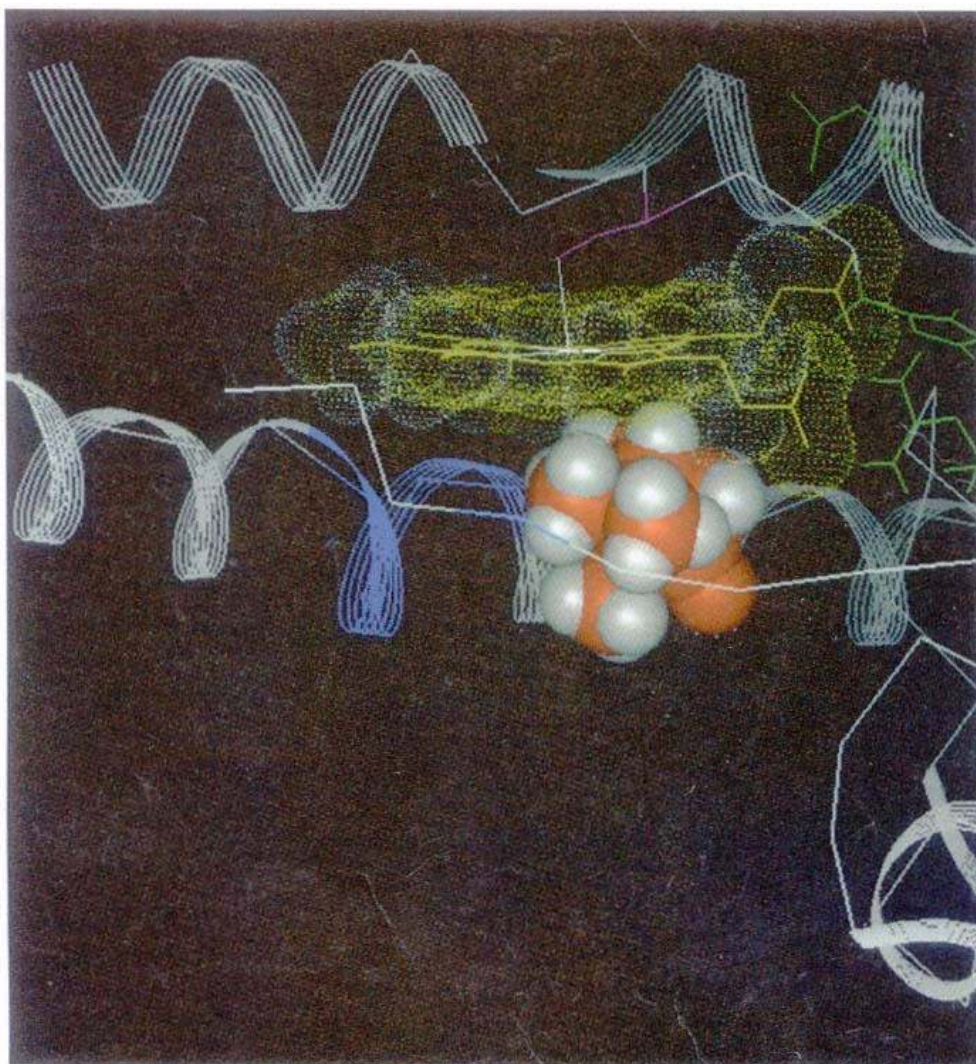

Figure 23.2

Binding of protoporphyrin IX prosthetic group of cytochromes P450.

The cysteine thiolate ligand (Cys 357) liganded to the heme iron is shown in the top of the figure and the space-filling model shows the camphor in the active site of the cytochrome P450_{cam}. Generated by Dr. John Salerno from Dr. Tom Poulos' P450_{cam} structure using Biosym's Insight program run on a Silicon Graphics Indigo Extreme platform.

iron or (2) a penta-coordinated high-spin state. Low- and high-spin states are descriptions of the electronic shells within the iron atom. When a cytochrome P450 molecule binds a substrate, there is a perturbation of the structure surrounding heme iron such that a more positive reduction potential (−170 mV) results than in the absence of substrate (−270 mV). This accelerates the rate at which cytochrome P450 may be reduced by electrons donated from NADPH through the flavoprotein enzyme **NADPH–cytochrome P450 reductase** (Figure 23.3). In order for **hydroxylation** (monooxygenation) to occur, heme iron must be reduced from the ferric (Fe^{3+}) to its ferrous (Fe^{2+}) state so that oxygen may bind to the heme iron. A total of two electrons is required for the **mono-oxygenation reaction**. Electrons are transferred to the cytochrome P450 molecule individually, the first to allow oxygen binding and the second to cleave the oxygen molecule to generate the active oxygen species for insertion into the reaction site of the substrate.

**23.3—
Cytochromes P450:
Multiple Forms**

Since the mid-1950s it has been known that one atom of molecular O_2 is inserted into a substrate being metabolized. This process of monooxygenation is also performed by other specialized proteins such as flavoprotein monooxygenases (hydroxylases). None of the other proteins classified as **oxygenases**, however, displays the versatility of the members of the cytochrome P450 family. In the past decade, information on the sequence and structure of cytochromes P450 has led to a further understanding of their evolution and regulation.

Multiplicity of Genes Produces Many Forms of Cytochrome P450

Many cytochrome P450 forms have emerged due to **gene duplication** events occurring in the last 5–50 million years. The different forms of cytochrome P450 among various animal species have likely arisen from the selective pressure of environmental influences, such as dietary habits or exposure to environmental agents. It is logical that the primordial genes gave rise to those cytochromes P450 that metabolized endogenous substrates. Examination of the phylogenetic tree, generated by comparing amino acid sequences and assuming a constant evolutionary change rate, leads to the conclusion that the earliest cytochromes P450 evolved to metabolize cholesterol and fatty acids. Therefore they may have played a role in the maintenance of membrane integrity in early eukaryotes.

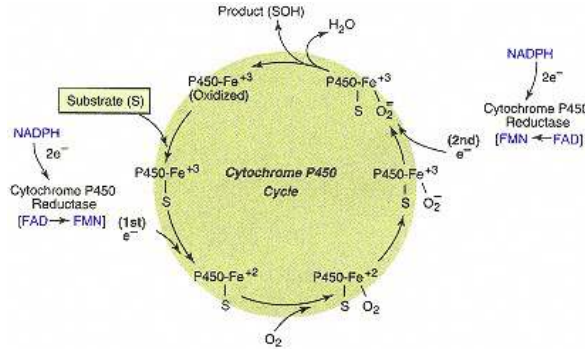

Figure 23.3
Sequence of reactions at cytochrome P450.
Diagram demonstrates the binding of substrate, transfer of the first and second electrons from NADPH–cytochrome P450 reductase, and binding of molecular oxygen.

Substrate Specificity

By the mid-1990s, nucleotide sequences for over 300 cytochrome P450 genes, coding for different proteins catalyzing the oxygenation of a variety of endogenous and exogenous substrates, had been characterized. There remain other members of this **gene superfamily** for which sequences have not yet been determined. One of the ways of characterizing these enzymes is the determination of **substrate specificity**. While this has been possible with many of the members of this family, the similarity of molecular weights and other molecular properties has made purification of individual cytochromes P450 from the same organ or even the same subcellular organelle very difficult, if not impossible. One way of determining the substrate specificity of a cytochrome P450 has been to express the cDNA for the particular protein via an expression vector in an appropriate cellular **expression system** in which that specific cytochrome P450 form is not expressed constitutively. This has been achieved in bacterial, insect, yeast, and mammalian cell systems and permits the unequivocal determination of substrate specificity uncomplicated by impurities of protein purification. The assumption is that knowing the nucleotide sequences of the expressed genes leaves little doubt as to the source of enzyme activity expressed in those cells.

Induction of Cytochromes P450

Induction of various cytochromes P450 by both endogenous and exogenous compounds has been known since the mid-1960s. The mechanisms of induction of cytochromes P450 have been demonstrated to be at either the **transcriptional** or **posttranscriptional** level and it is not possible to predict the mode of induction based on the inducing compound. For example, a single cytochrome P450 can be induced by different mechanisms. In one case, induction occurs at the transcriptional level and, in the other, it involves posttranscriptional events, that is, stabilization of mRNA. An example of the complexity of the induction process occurs with rat CYP2E1 as a result of treatment with small organic molecules, such as ethanol, acetone, or pyrazole, or during fasting or diabetic conditions. Administration of these small organic compounds produces larger amounts of the CYP2E1 protein without affecting the levels of mRNA. While the mechanism is not completely understood, pyrazole may stabilize this specific cytochrome P450 from proteolytic degradation. However, in diabetic rats the sixfold induction of CYP2E1 protein is accompanied by a tenfold increase in mRNA in the absence of an increase in gene transcription, suggesting stabilization of the mRNA.

The role of specific cytosolic receptor proteins has been indicated in the case of some of the known inducing agents. One of the most extensively studied is the interaction of **2,3,7,8-tetrachlorodibenzo-*p*-dioxin (TCDD)** with its cytosolic receptor, called the **aryl hydrocarbon (or Ah) receptor**, which functions in the induction of CYP1A1 and CYP1A2 forms. **Polycyclic aromatic hydrocarbons** serve as ligands which bind to the Ah receptor, producing a complex that is translocated to the nucleus and is involved in binding to the upstream regulatory regions (specific **response elements**) of cytochrome P450 genes. A second protein called the **Ah receptor nuclear translocator** or **Arnt protein** was found to interact with the ligand bound Ah receptor. The Arnt protein was essential for enabling this ligand–Ah receptor complex to recognize and bind to its specific DNA response element. Utilizing cytochrome P450 gene transfection and expression vector technology, it has been possible to express those portions of the cytochrome P450 genomic DNA representing the RNA polymerase II promoter region and the upstream DNA sequences in conjunction with another gene coding for an enzyme that is not expressed constitutively in eukaryotes. In an assay of the prokaryotic enzyme activity, for example, chloramphenicol acetyltransferase (CAT) in the expression system, it is possible to determine which specific nucleotide sequences of DNA are involved in

CLINICAL CORRELATION 23.1**Consequences of Induction of Drug-Metabolizing Enzymes**

Induction of the cytochrome P450 system may result in altered efficacy of therapeutic drugs, as the accelerated rate of hydroxylation will increase the inactivation and/or enhance the excretion rate of drugs. Induction of this protein system may also produce unexpected and unwanted side effects of therapeutic agents due to increased formation of toxic metabolites that may cause cell injury if produced in large enough concentrations. The induction of different cytochrome P450 forms by a drug may stimulate the metabolism of itself or other drugs that are substrates for the cytochrome P450 system. Clinical problems may develop as a consequence of cytochrome P450 induction.

The increase in clearance of oral contraceptives by rifampicin, an antituberculosis drug and CYP3A4 inducer, has been shown to decrease the effectiveness of the contraceptive agent and increase the incidence of pregnancy in women who are prescribed both drugs. Fatalities have been reported in patients who are simultaneously treated with phenobarbital, a long-acting sedative and potent cytochrome P450 inducer, and warfarin, an anticoagulant, which is prescribed to patients with clotting disorders. Higher doses of warfarin are required in these patients to maintain the same effective concentration of the drug to delay coagulation because warfarin is a substrate for the cytochrome P450 induced by phenobarbital. Consequently, the drug is metabolized and cleared at a faster rate, which reduces its therapeutic efficacy. Clinical problems are created when phenobarbital is removed from the treatment regimen with no corresponding decrease in warfarin levels. With time, cytochrome P450 levels decrease to the noninduced state but the high concentrations of warfarin, proper under conditions of accelerated metabolism and clearance, are in excess and produce unwanted hemorrhaging.

Induction of CYP2E1 by chronic alcohol use has led to a warning for consumers of acetaminophen, a common over-the-counter analgesic agent, because this cytochrome P450 will metabolize acetaminophen to a toxic metabolite that may lead to liver cell damage. These represent classic examples of cytochrome P450–drug interactions that can lead to unwanted and unexpected clinical problems.

regulating these genes. These nucleotide sequences are referred to as **xenobiotic regulatory elements** or XREs.

Another much studied inducer of cytochrome P450 genes is **phenobarbital**, which increases the transcription rate of certain cytochrome P450 forms. A receptor that binds phenobarbital has not been described, but a specific DNA response element that is essential for phenobarbital-mediated induction has been identified in the upstream regulatory region of *CYP2B2* and *CYP3A1* genes. Although the mechanism by which phenobarbital increases transcription is unknown, the intracellular messenger, adenosine 2',3'-cyclic monophosphate (cAMP), is a negative modifier, suppressing phenobarbital-mediated cytochrome P450 gene expression. An increase in cAMP levels in rat hepatocytes was found to prevent the phenobarbital-directed induction of *CYP2B2* and *CYP3A1* by activating protein kinase A activity. Some clinical consequences of induction of drug-metabolizing enzymes are presented in Clin. Corr. 23.1.

Polymorphisms

In addition to exposure to different inducing agents, individuals may differ in their rates of metabolism of a particular drug because of differences in the cytochrome P450 genes they possess. Different forms of a cytochrome P450 gene may exist in a given population, which will alter the functional activity of the complement of cytochromes P450. These **genetic polymorphisms** may be present in a small percentage of the population and cause an individual to be unable to metabolize a drug at a sufficient rate, thereby producing significantly elevated drug levels. These "**poor metabolizers**" may be at risk for a dose-dependent toxicity if the unmetabolized form of the drug is pharmacologically active. Examples of genetic polymorphisms in drug metabolism are described in Clin. Corr. 23.2.

23.4—**Inhibitors of Cytochromes P450**

Due to the many forms of cytochrome P450, it is of interest to examine the metabolic roles of these various enzymes in the organs in which they function. Several inhibitors have been utilized to demonstrate that cytochrome(s) P450 may be involved in a metabolic pathway, for example, the metabolism of steroids in the adrenal or specific reproductive organs. As has been discussed, the detection of cytochrome P450 in most tissues can be ascertained by the reduced-**carbon monoxide difference spectrum**. Carbon monoxide (CO) binds to the heme iron, in lieu of oxygen, with a much higher binding affinity and thereby is a potent inhibitor of its function. The identity of a cytochrome P450 in the catalysis of a putative substrate in a metabolic pathway rested on the reversal of CO inhibition by light at 450 nm, corresponding to the reduced-CO absorption maximum. This was first demonstrated for steroids as substrates for adrenal mitochondrial cytochromes P450 and later for drugs metabolized by liver microsomal cytochromes P450. However, this is a nonspecific inhibition characteristic of most cytochromes P450 and does not differentiate among the various forms.

More specific inhibitors are needed that can determine the role of a specific cytochrome P450 in a particular metabolic pathway. Although monospecific polyclonal and monoclonal antibodies have been developed to a number of cytochromes P450, it is not always possible to determine that a single form is responsible because of inhibition of a given reaction. The strong structural homology among the various forms may allow cross-reactivity among cytochromes P450. This is particularly true of members of the same gene family that exhibit immune cross-reactivity.

Recently, efforts have been directed to develop **mechanism-based inhibitors**, so-called **suicide substrates**, which bear strong resemblance to the sub-

CLINICAL CORRELATION 23.2

Genetic Polymorphisms of Drug-Metabolizing Enzymes

Genetic polymorphisms of cytochromes P450 result in the expression of cytochromes P450 that are nonfunctional or exhibit lower enzymatic activities. This may result in unwanted side effects because of the inability to eliminate the active form of the drug, causing elevated concentrations in the body. It may also result in the absence of a therapeutic effect because the active form of a drug is not formed.

The discovery of an individual who suffered exaggerated hypotensive effects when administered the antihypertensive drug, debrisoquine, led to the characterization of individuals who metabolized substrates catalyzed by the CYP2D6 form inefficiently. Approximately 5–10% of the Caucasian population, 2% of the Asian, and 1% of the Arabic populations were deficient for the catalytically active CYP2D6 form. In addition to debrisoquine, other drugs that are metabolized by CYP2D6 are sparteine, amitriptyline, dextromethorphan, and codeine. In the case of codeine, CYP2D6 catalyzes the *O*-demethylation of codeine to morphine. Approximately 10% of the dose of codeine is metabolized to morphine in individuals who have a normal CYP2D6 and this metabolism is responsible for the analgesic effects of this drug. Individuals who lack the normal gene for CYP2D6 are unable to catalyze this reaction and are unable to achieve the analgesic effects associated with codeine.

Another genetic polymorphism was demonstrated in individuals who were poor metabolizers of the drug mephenytoin. This drug is used in the treatment of epilepsy. Poor metabolizers of this drug suffer greater sedative effects at normal dosages. The 4-hydroxylation of the *S*-enantiomer of mephenytoin is carried out by CYP2C19. Approximately 14–22% of the Asian population are reported to be poor metabolizers of the *S*-isomer of mephenytoin whereas only 3–6% of the Caucasian population are affected. These genetic polymorphisms may explain some of the interindividual or interracial differences in the way individuals respond to therapeutic drugs.

Eichelbaum, M., and Gross, A. S. The genetic polymorphism of debrisoquine/sparteine metabolism—clinical aspects. In: W. Kalow (Ed.), *Pharmacogenetics of Drug Metabolism*. New York: Pergamon Press, 1992, Chap. 21, p. 625; and Meyer, U. A., Skoda, R. D., Zanger, U. M., Heim, M., and Broly, F. The genetic polymorphism of debrisoquine/sparteine metabolism—molecular mechanism. In: W. Kalow (Ed.), *Pharmacogenetics of Drug Metabolism*. New York: Pergamon Press, 1992, Chap. 20, p. 609.

strate(s) of the specific cytochrome P450, but which during catalytic turnover form an irreversible inhibition product with the enzyme prosthetic group or protein. Because of their structural resemblance to the substrate(s), these inhibitors become highly specific for that particular form of cytochrome P450. These inhibitors contain functional groups that are metabolized to intermediates that result in their covalent binding to the enzymes, thereby accounting for their irreversibility. This represents a possible tactical approach to drug design.

23.5— Cytochrome P450 Electron Transport Systems

Although cytochrome P450-catalyzed reactions require two electrons to accomplish the tasks of heme iron reduction, oxygen binding, and oxygen cleavage, a basic mechanistic problem is the direct and simultaneous transfer of electrons from NADPH to the cytochrome P450. Pyridine nucleotides are two electron donors (see p. 250), but cytochrome P450, with its single heme prosthetic group, may only accept one electron at a time. Thus a protein that serves to transfer electrons from NADPH to the cytochrome P450 molecule must have the capacity to accept two electrons but serve as a one-electron donor. This problem is solved by the presence of a NADPH-dependent flavoprotein reductase, which accepts two electrons from NADPH simultaneously but transfers the electrons individually either to an intermediate **iron–sulfur protein** (mitochondria) or directly to cytochrome P450 (endoplasmic reticulum). The active redox group of the flavin moiety is the isoalloxazine ring (see p. 251). The isoalloxazine nucleus is uniquely suited to perform this chemical task since it can exist in oxidized and one- and two-electron reduced states (Figure 23.4). The transfer of electrons from NADPH to cytochrome P450 is accomplished by two distinct electron transport systems that reside almost exclusively in either mitochondria or endoplasmic reticulum.

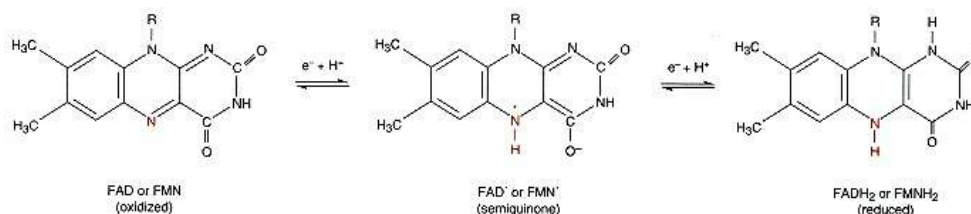

Figure 23.4

Isoalloxazine ring of FMN or FAD in its oxidized, semiquinone ($1e^-$ reduced), or fully reduced ($2e^-$ reduced) states.

NADPH–Cytochrome P450 Reductase Is the Flavoprotein Donor in the Endoplasmic Reticulum

In the endoplasmic reticulum, NADPH donates electrons to a flavoprotein called NADPH–cytochrome P450 reductase. The rat enzyme has a mass of 76,962 Da and contains both flavin adenine dinucleotide (FAD) and flavin mononucleotide (FMN) as prosthetic groups. Until the recent characterization of nitric oxide synthases, it was the only mammalian flavoprotein known to contain both FAD and FMN. A significant number of residues at the amino end of the molecule are hydrophobic, and this segment of the protein is embedded in the endoplasmic reticulum (Figure 23.5). FAD serves as the entry point for electrons from NADPH, and FMN serves as the exit point, transferring electrons individually to cytochrome P450. Because the flavin molecule may exist as one- or two-electron-reduced forms and two flavin molecules are bound per reductase molecule, the enzyme may receive electrons from NADPH and store them between the two flavin molecules before transferring them individually to the cytochrome P450.

In certain reactions catalyzed by the microsomal cytochrome P450, the transfer of the second electron may not be directly from **NADPH–cytochrome P450 reductase** but may occur from **cytochrome b_5** , a small heme protein of molecular mass 15,330 Da. Cytochrome b_5 is reduced either by NADPH–cytochrome P450 reductase or another microsome-bound flavoprotein, **NADH–cytochrome b_5 reductase**. It is not known why reactions catalyzed by specific cytochromes P450 apparently require cytochrome b_5 for optimal enzymatic activity. In addition, NADH–cytochrome b_5 reductase and cytochrome b_5 constitute the electron transfer system for NADH to the iron–sulfur protein, **fatty acid desaturase**, which catalyzes the formation of double bonds in fatty acids (see p. 372).

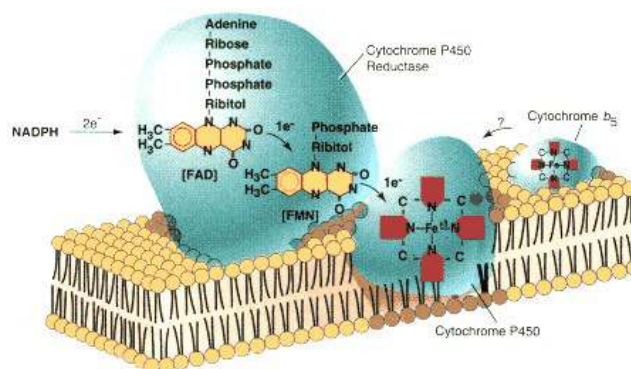

Figure 23.5

Components of the endoplasmic reticulum (microsomal) cytochrome P450 system. NADPH–cytochrome P450 reductase is bound by its hydrophobic tail to the membrane, whereas cytochrome P450 is deeply embedded in the membrane. Also shown is cytochrome b_5 , which may participate in selected cytochrome P450-mediated reactions.

NADPH–Adrenodoxin Reductase Is the Flavoprotein Donor in Mitochondria

In mitochondria, a flavoprotein reductase also acts as the electron acceptor from NADPH. This protein is referred to as **NADPH–adrenodoxin reductase** because its characteristics were described for the flavoprotein first isolated from the adrenal gland. This protein contains only FAD and the bovine NADPH–adrenodoxin reductase has a mass of 50,709 Da. Adrenodoxin reductase is only weakly associated with its membrane milieu, unlike NADPH–cytochrome P450 reductase of endoplasmic reticulum. Adrenodoxin reductase cannot directly transfer either the first or second electron to heme iron of cytochrome P450 (Figure 23.6). A small molecular weight protein, called **adrenodoxin** (12,500 Da), serves as an intermediate between the adrenodoxin reductase and **mitochondrial cytochrome P450**. The adrenodoxin molecule is also weakly associated with the inner mitochondrial membrane through interaction with the membrane-bound cytochrome P450. Adrenodoxin contains two iron–sulfur clusters, which serve as redox centers for this molecule and function as an electron shuttle between the adrenodoxin reductase and the mitochondrial cytochromes P450. One adrenodoxin molecule receives an electron from its mitochondrial flavoprotein reductase and interacts with a second adrenodoxin, which then transfers its electron to the cytochrome P450 (Figure 23.6). Components of the mitochondrial cytochrome P450 system are synthesized in the cytosol as larger molecular weight precursors, transported into mitochondria, and processed by proteases into smaller molecular weight, mature proteins.

23.6—

Physiological Functions of Cytochromes P450

Cytochromes P450 metabolize a variety of lipophilic compounds of endogenous or exogenous origin. These enzymes may catalyze simple hydroxylations of the carbon atom of a methyl group, insertion of a hydroxyl group into a methylene carbon of an alkane, hydroxylation of an aromatic ring to form a phenol, or addition of an oxygen atom across a double bond to form an **epoxide**. In dealkylation reactions, the oxygen is inserted into the carbon–hydrogen bond, but the resulting product is unstable and rearranges to the primary alcohol, amine, or sulfhydryl compound. Oxidation of nitrogen, sulfur, and phosphorus atoms and dehalogenation reactions are also catalyzed by cytochromes P450. Reactions catalyzed by cytochrome P450 forms are shown in Figure 23.7.

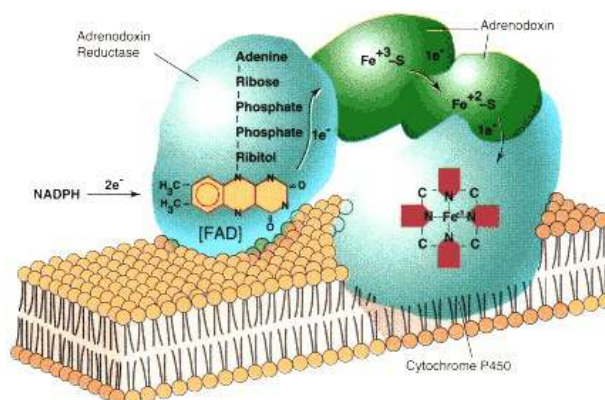

Figure 23.6

Components of mitochondrial cytochrome P450 system.

Cytochrome P450 is an integral protein of the inner mitochondrial membrane. NADPH–adrenodoxin reductase and adrenodoxin (ADR) are peripheral proteins and are not embedded in the membrane.

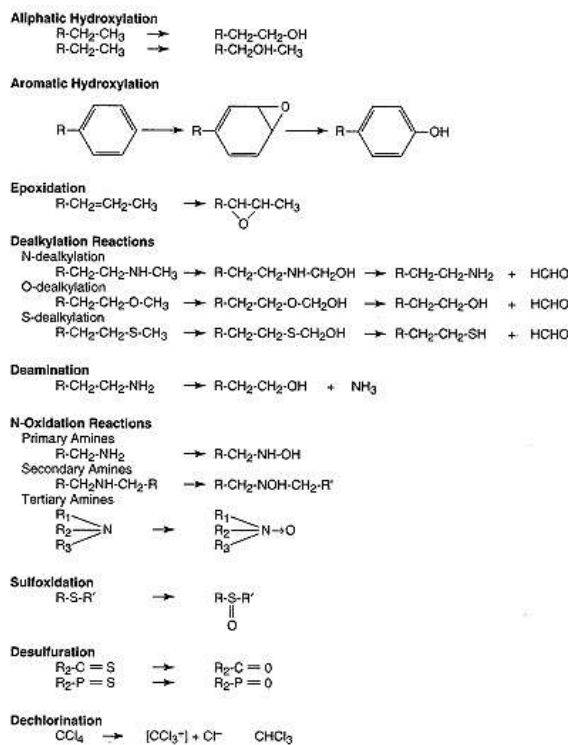

Figure 23.7
 Reaction types catalyzed by cytochromes P450.

Cytochromes P450 Participate in Synthesis of Steroid Hormones and Oxygenation of Eicosanoids

The importance of cytochrome P450-catalyzed reactions is illustrated by the synthesis of **steroid hormones** from cholesterol in the adrenal cortex and sex organs. Mitochondrial and endoplasmic reticulum cytochrome P450 systems are required to metabolize cholesterol stepwise into **aldosterone** and **cortisol** in adrenal cortex, **testosterone** in testes, and **estradiol** in ovaries.

Cytochromes P450 are responsible for several steps in the adrenal synthesis of aldosterone, the mineralocorticoid responsible for regulating salt and water balance, and cortisol, the glucocorticoid that governs protein, carbohydrate, and lipid metabolism. In addition, adrenal cytochromes P450 catalyze the synthesis of small quantities of the androgen, **androstenedione**, a precursor of both estrogens and testosterone (see p. 900). Production of androstenedione regulates secondary sex characteristics. Figure 23.8 presents a summary of these pathways.

In adrenal mitochondria, a cytochrome P450 (CYP11A1) catalyzes the **side chain cleavage** converting cholesterol to pregnenolone, a committed step in steroid synthesis. The removal of isocaproic aldehyde results from a cytochrome P450-catalyzed reaction involving sequential hydroxylation at C-22 and C-20 to produce 22-hydroxycholesterol and then 20,22-dihydroxycholesterol (Figure 23.9). An additional P450-catalyzed step is necessary to cleave the bond between C-20 and C-22 to produce pregnenolone. This reaction sequence, which requires

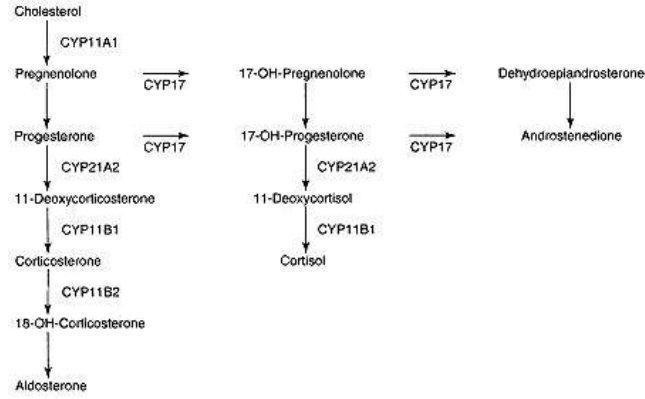

Figure 23.8
Steroid hormone synthesis in the adrenal gland.
 The reactions catalyzed by cytochromes P450 (CYP) are indicated.

3 NADPH and 3 O₂ molecules, results in the breakage of a carbon–carbon bond and is catalyzed by a single cytochrome P450 enzyme, CYP11A1. After pregnenolone is produced in mitochondria, it is transported into the cytosol where it is oxidized by 3β-hydroxysteroid dehydrogenase/ 4,5-isomerase to progesterone. Progesterone is metabolized to **11-deoxycorticosterone(DOC)** by an endoplasmic reticulum cytochrome P450 (**CYP21**), which catalyzes the 21-hydroxylation reaction. DOC is hydroxylated by an additional mitochondrial

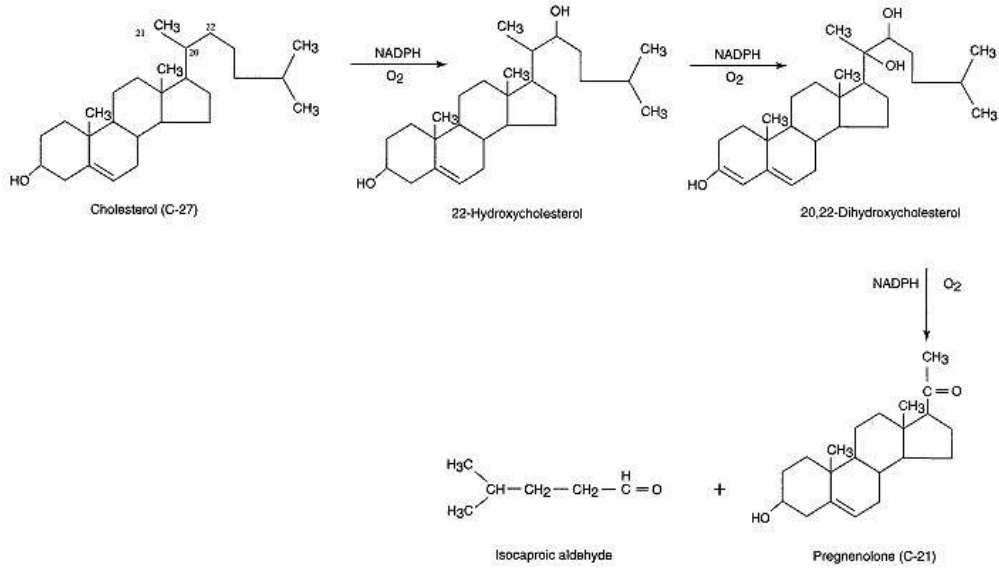

Figure 23.9
Side chain cleavage reaction of cholesterol.
 Three sequential reactions are catalyzed by cytochrome P450 to produce pregnenolone and isocaproic aldehyde.

CLINICAL CORRELATION 23.3**Deficiency of Cytochrome P450 Steroid 21-Hydroxylase (CYP21A2)**

The adrenal cortex is a major site of steroid hormone production during fetal and adult life. The adrenal gland is metabolically more active in fetal life and may produce 100–200 mg of steroids per day in comparison to the 20–30 mg produced per day in the non-stressed adult adrenal gland. A number of enzymes are required for the production of cortisol, and enzyme deficiencies have been reported at all steps of cortisol production. Diseases associated with insufficient cortisol production are referred to as congenital adrenal hyperplasias (CAHs). The enzyme deficiency that is most common in CAH is the cytochrome P450-dependent 21-hydroxylase or CYP21A2. A deficiency in a functional 21-hydroxylase enzyme prevents the metabolism of 17α -hydroxyprogesterone to 11-deoxycortisol and subsequently to cortisol. This causes an increase in ACTH secretion, the pituitary hormone that regulates adrenal cortex production of cortisol. Prolonged periods of elevated ACTH levels causes adrenal hyperplasia and an increased production of the androgenic hormones, DHEA and androstenedione. Clinical problems arise because the additional production of androgenic steroids causes virilization in females, precocious sex organ development in prepubertal males, or diseases related to salt imbalance because of decreased levels of aldosterone. Clinical consequences of severe 21-hydroxylase deficiency may be recognizable at birth, particularly in females, because the excessive buildup of androgenic steroids may cause obvious irregular development of their genitalia. In male newborns, a deficiency in 21-hydroxylase activity may be overlooked, because male genitalia will appear normal, but there will be precocious masculinization and physical development. In late onset CAH, individuals are born without obvious signs of prenatal exposure to excessive androgen levels, and clinical symptoms may vary considerably from early development of pubic hair, early fusion of epiphyseal growth plates causing premature cessation of growth, or male baldness patterns in females.

Donohoue, P. A., Parker, K., and Migeon, C. J. Congenital adrenal hyperplasia. In: C. S. Scriver, A. L. Beaudet, W. S. Sly, and D. Valle (Eds.), *The Metabolic and Molecular Bases of Inherited Disease*, 7th ed., Vol. II. New York; McGraw-Hill, 1995, Chap. 94, p. 2929.

cytochrome P450 (**CYP11B2**), which catalyzes both the 11β -hydroxylase and 18-hydroxylase activities to form the mineralocorticoid, aldosterone, in the zona glomerulosa (Chapter 21, p. 899).

Synthesis of cortisol proceeds from either pregnenolone or progesterone and involves a cytochrome P450 (**CYP17**), an endoplasmic reticulum cytochrome P450, which catalyzes the 17α -hydroxylation reaction. Hydroxylation of the C-21 of 17α -hydroxyprogesterone by CYP21 produces 11-deoxycortisol, which is transported into mitochondria where it is hydroxylated at carbon atom 11 by **CYP11B1** to form cortisol. These reactions occur primarily in the zona fasciculata of the adrenal cortex. The consequences of a genetic polymorphism in CYP21 is presented in Clin. Corr. 23.3.

Synthesis of steroids containing 19 carbon atoms from 17α -hydroxypregnenolone or 17α -hydroxyprogesterone is the result of the loss of the acetyl group at C-17. This reaction is catalyzed by CYP17, identified as the same cytochrome P450 that hydroxylates C-17. Thus cleavage of the bond between C-17 and C-20 with loss of the acetyl group is also catalyzed by a cytochrome P450 molecule. The factors that determine whether this cytochrome P450 performs only a single hydroxylation step to produce the 17-OH product or proceeds further to cleave the C-17–C-20 bond has not been determined. The products are **dehydroepiandrosterone** (DHEA) from 17α -hydroxypregnenolone or androstenedione from 17α -hydroxyprogesterone. DHEA in the sex organs may be metabolized by dehydrogenation of the 3-OH group to androstenedione, a potent androgenic steroid that serves as the immediate precursor of testosterone.

Another physiologically important reaction catalyzed by cytochromes P450 is synthesis of estrogens from androgens, collectively called **aromatization** because an aromatic ring is introduced into the product. This is a complex reaction not unlike the side chain cleavage of cholesterol in which multiple hydroxylation reactions are carried out by a single cytochrome P450 enzyme to form the aromatic ring and remove the methyl group at C-19. Figure 23.10 outlines the aromatization reaction of ring A. Two cytochrome P450-mediated hydroxylation reactions at the methyl carbon atom at position 19 introduce an aldehyde group. It has been proposed that the final step involves a peroxidative attack at C-19 with loss of the methyl group and elimination of the hydrogen atom to produce the aromatic ring. The reaction steps of this sequence are catalyzed by the same cytochrome P450 and the enzyme is called aromatase or P450_{arom}. P450_{arom} is a member of the CYP19 subfamily. The complexity of steroid hormone production and the role of cytochromes P450 are illustrated in Clin. Corr. 234.

Other cytochromes P450 metabolize **vitamin D₃** to produce the **1,25-dihydroxy vitamin D₃**, which is the active form of this important hormone (see p. 907), leukotriene B₄ to produce 20-hydroxy-leukotriene B₄, which is the less active form of this chemotactic agent (see p. 438), and arachidonic acid to produce epoxides, hydroxy and dihydroxy derivatives of arachidonic acid, which may have important regulatory functions (see p. 433).

Cytochromes P450 Oxidize Exogenous Lipophilic Substrates

Exogenous substrates are often referred to as **xenobiotics**, meaning "foreign to life." They include therapeutic drugs, chemicals used in the workplace, industrial by-products that become environmental contaminants, and food additives. Cytochromes P450 oxidize a variety of xenobiotics, particularly lipophilic compounds. The addition of a hydroxyl group makes the compound more polar and thus more soluble in the aqueous environment of the cell. Many exogenous compounds are highly lipophilic and accumulate within cells, interfering with cellular function over a period of time. Examples of xenobiotics that are oxidized by cytochromes P450 are presented in Tables 23.2 and 23.3 (p. 994). In many cases the action of the cytochromes P450 leads to a compound

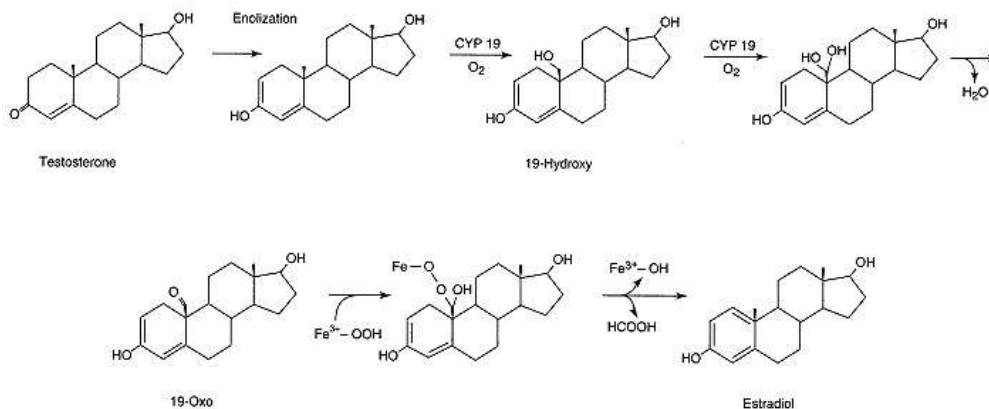

Figure 23.10
Sequence of reactions leading to aromatization of androgens to estrogens.
 Adapted from Graham-Lorence, S., Amarneh,
 B., White, R. E., Peterson, J. A., and Simpson E. R. *Protein Sci.* 4:1065, 1995.

with reduced pharmacological activity or toxicity, which can readily be excreted in the urine or bile. Modified and unmodified xenobiotics can be altered chemically by a variety of conjugating enzyme systems forming products that are even less toxic and that can readily be eliminated from the body. A list of enzymes that metabolize xenobiotics is presented in Table 23.3; many occur primarily in the liver.

One xenobiotic that has received considerable attention is **benz[a]pyrene**, a common environmental contaminant produced from the burning of

CLINICAL CORRELATION 23.4

Steroid Hormone Production during Pregnancy

Steroid hormone production increases dramatically during pregnancy and, at term, the pregnant woman produces 15–20 mg of estradiol, 50–100 mg of estrion, and approximately 250 mg of progesterone per 24-h period. The amount of estrogens synthesized during pregnancy far exceeds the amount synthesized by nonpregnant women. For example, the pregnant woman at the end of gestation produces 1000 times more estrogen than premenopausal women per day.

Production of progesterone and estrogens in pregnant women is decidedly different from that in the nonpregnant woman. The corpus luteum of the ovary is the major site for estrogen production in the first few weeks of pregnancy, but at approximately 4 weeks of gestation, the placenta begins synthesizing and secreting progesterone and estrogens. After 8 weeks of gestation, the placenta becomes the dominant source for the synthesis of progesterone. An interesting difference between the steroid hydroxylating systems in the placenta and the ovary is that the human placenta lacks the cytochrome P450 (CYP11A1) that catalyzes the 17 β -hydroxylation reaction and the cleavage of the 17,20 carbon–carbon bond (see Chapter 21, p. 898, for details of synthesis of steroid hormones). Thus the placenta cannot, by itself, synthesize estrogens from cholesterol. The placenta catalyzes the side chain cleavage reaction to form pregnenolone from cholesterol and oxidizes pregnenolone to progesterone but releases this hormone into the maternal circulation. How then does the placenta produce estrogens if it cannot synthesize DHEA or androstenedione from progesterone? This is accomplished in the fetal adrenal gland, which represents a significant proportion of the total fetal weight compared to its adult state. The fetal adrenal gland catalyzes the synthesis of DHEA from cholesterol and releases it into the fetal circulation. A large proportion of the fetal DHEA is metabolized by the fetal liver to 16 α -hydroxy-DHEA, and this product is aromatized in the placenta to the estrogen, estrion. This is an elegant demonstration of the cooperativity of the cytochrome P450-mediated hydroxylating systems in the fetal and maternal organ systems leading to the progressive formation of estrogens during the gestational development of the human fetus.

Cunningham, F. G., MacDonald, P. C., Gant, N. F., Leveno, K. J., and Gilstrap, L. C. The placental hormones. In: *Williams Obstetrics*, 19th ed. East Norwalk, CT: Appleton & Lange, 1993, Chap. 6, p. 139.

TABLE 23.2 Xenobiotics Metabolized by Cytochromes P450

<i>Reaction</i>	<i>Examples</i>
Aliphatic hydroxylation	Valproic acid, pentobarbital
Aromatic hydroxylation	Debrisoquine, acetanilide
Epoxidation	Benzene, benzo[<i>a</i>]pyrene
Dealkylation	Aminopyrine, phenacetin, 6-methyl-thiopurine
Oxidative deamination	Amphetamine
Nitrogen or sulfur oxidation	2-Acetylaminofluorene, chlorpromazine
Dehalogenation	Halothane
Alcohol oxidation	Ethanol

coal, from the combustion of plant materials in tobacco, from food barbecued on charcoal, and as an industrial by-product. Benzo[*a*]pyrene binds to the **aryl hydrocarbon receptor** and induces cytochromes P450 in the 1A subfamily, thus increasing its own metabolism. Several sites of the molecule may be hydroxylated by different forms of cytochrome P450. Benzo[*a*]pyrene is metabolized to a **carcinogen** in animals and a mutagen in bacteria, prompting considerable work in identifying the enzymes involved in this process. The product found to represent the ultimate carcinogen is **benzo[*a*]pyrene-7,8-dihydrodiol-9,10-epoxide**, the formation of which is illustrated in Figure 23.11. The initial step involves a cytochrome P450-catalyzed epoxidation at the 7,8 position, hydrolysis by **epoxide hydrolase** to the vicinal hydroxylated compound, benzo[*a*]pyrene-7,8-dihydrodiol, and then another epoxidation reaction to form benzo[*a*]pyrene-7,8-dihydrodiol-9,10-epoxide. The parent compound, benzo[*a*]pyrene, is a weak carcinogen and, like most carcinogens that have been characterized, requires metabolic activation to its more potent carcinogenic form.

In a number of cases, the cytochrome P450 system is responsible for generation of the ultimate carcinogen. Formation of toxic compounds by the cytochrome P450 system, however, does not mean that cell damage or cancer will occur, because many other factors will determine whether or not the toxic metabolite will cause cell injury. These include the involvement of detoxification enzyme systems, the status of the immune system, nutritional state, genetic predisposition, and environmental factors. One may ask why the body should possess an enzyme system that would create highly toxic compounds? As indi-

TABLE 23.3 Xenobiotic-Metabolizing Enzymes

<i>Type of Reaction</i>	<i>Enzyme</i>	<i>Representative Substrate</i>
Oxidation	Cytochrome P450	Toluene
	Alcohol dehydrogenase	Ethyl alcohol
	Flavin-containing monooxygenase	Dimethylaniline
Reduction	Ketone reductase	Metyrapone
Hydration	Epoxide hydrolase	Benzo[<i>a</i>]pyrene-7,8-epoxide
Hydrolysis	Esterase	Procaine
Conjugation	UDP-glucuronyltransferase	Acetaminophen
	Sulfotransferase	β -Naphthol
	<i>N</i> -acetyltransferase	Sulfanilamide
	Methyltransferase	Thiouracil
	Glutathionetransferase	Acetaminophen

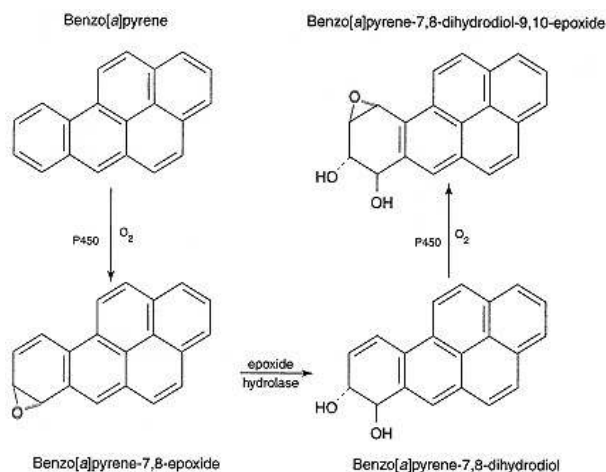

Figure 23.11

Metabolism of benzo[a]pyrene by cytochrome P450 and epoxide hydrolase to form benzo[a]pyrene-7,8-dihydrodiol-9,10-epoxide.

cated, the purpose of the cytochrome P450 system is to add or expose functional groups making the molecule more polar and/or more susceptible to attack by additional detoxification enzyme systems. In addition, many of these compounds resemble hormones that are our natural communication signals and would interfere with cell–cell or organ–organ communication.

Thus the cytochrome P450 system plays a significant role in the health and disease of humans. Different cytochromes P450 are responsible for generation of essential steroid hormones, the regulation of blood levels of therapeutic agents, the removal of unwanted chemicals that would accumulate because of their lipophilicity, and the generation of potentially toxic metabolites that may cause acute cell injury or damage to genetic material and lead to production of tumors.

23.7—

Other Hemoprotein- and Flavoprotein-Mediated Oxygenations:

The Nitric Oxide Synthases

Three Distinct Nitric Oxide Synthase Gene Products Display Diverse Physiological Functions

Release of nitric oxide from therapeutic drugs has been used as a treatment for angina pectoris since 1867, when Sir Thomas Lauder Brunton reported the use of nitroglycerin and amyl nitrate in his patients. However, it was not known until the 1980s that **nitric oxide**, or NO[•], was the active agent in the dilation of blood vessels. The demonstration that this free radical diatomic gas was the primary endogenous vasodilator released by the vascular endothelium led to the search for an enzymatic source of NO[•]. The source of NO[•] is the guanidino group of the naturally occurring amino acid, L-arginine. The reaction catalyzed by the enzymes responsible for the conversion of L-arginine to L-citrulline and NO[•] is shown below:

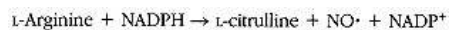

Nitric oxide synthases have been examined in whole animals, tissues, and cells for functional properties and recently three genes have been identified for

CLINICAL CORRELATION 23.5

Clinical Aspects of Nitric Oxide Production

Although the role of NO⁻ in the tumoricidal and bactericidal functions of macrophages is essential in these cells, the overproduction of NO⁻ (from the inducible isoform of nitric oxide synthase, iNOS or NOS-II) has been implicated in septic/cytokine-induced circulatory shock in humans through the activation of guanylate cyclase. This mechanism is responsible for profound hypotension in patients after abdominal surgery or abdominal trauma complicated by bacterial infections that produce endotoxins, as well as in patients with neoplasias treated by IL-2 chemotherapy. Hypotension in these patients is often refractory to treatment with conventional vasoconstrictor drugs. Therapeutic interventions using NOS inhibitors are being examined in gastrointestinal inflammatory diseases, such as pancreatitis and ulcerative colitis, and in arthritis. Administration of NOS inhibitors (e.g., specific to iNOS) might be a treatment of choice in such patients.

The endothelial isoform of nitric oxide synthase, eNOS or NOS-III, is thought to play a critical role in maintaining a basic vasotonus in hemodynamic regulation such that an imbalance in the production of NO⁻ could result in hypertension, thrombosis, or atherosclerosis. Direct application of NO⁻ gas may also be beneficial in the treatment of pulmonary hypertension. In addition, recent experiments with mice in which the gene for the neuronal isoform of nitric oxide synthase, nNOS or NOS-I, has been deleted have resulted in animals with distended stomachs due to constriction of the pyloric sphincter. This work has unexpectedly produced a model for the clinical disease, infantile hypertrophic pyloric stenosis. It has also been shown that these nNOS-deficient mice are resistant to brain damage as a result of ischemic injury usually resulting in vascular strokes. While the direct connection to human disease has not yet been made, in this instance, it presents a paradigm that can now be examined in clinical and pathological settings.

The development of potent, specific inhibitors of the isoforms of nitric oxide synthase is an active area of research being pursued collaboratively by investigators in academia and the pharmaceutical industry.

the isoforms responsible for the activities in various tissues. Accordingly, the respective enzymes have been designated as **neuronal (NOS-I)**, **macrophage or induced (NOS-II)**, or **endothelial (NOS-III)**. Any tissue or cell may contain more than one isoform of nitric oxide synthase, thus contributing to the production of NO⁻ under various physiological circumstances. Studies of the macrophage type of nitric oxide synthase led to the conclusion that, upon treatment of animals with cytokines or lipopolysaccharide, the increase in production of NO⁻ was due to this isoform, since it is quantitatively the major source of NO⁻. Subsequently, L-arginine was shown to be the precursor of NO⁻ in both endothelial and neuronal cells. Production of NO⁻ is necessary for maintenance of vascular tone, platelet aggregation, neural transmission, and bacterial and/ or tumor cytotoxicity (see Clin. Corr. 23.5).

As further evidence of the importance of heme enzymes, signaling events require binding to the heme prosthetic group of guanylate cyclase of NO⁻ produced in neuronal and endothelial cells for activation of signaling events. The formation of cGMP leads to the subsequent downregulation of intracellular Ca²⁺ concentrations and to a cellular response appropriate to the specific cell involved. For example, the production of cGMP in vascular smooth muscle cells resulting from NO⁻ production leads to the lowering of Ca²⁺ concentrations, resulting in vasodilatation due to smooth muscle relaxation.

Structural Aspects of Nitric Oxide Synthases

Although the written reaction does not reveal the overall stoichiometry, it is representative of a monooxygenation reaction and the mechanism is similar to that catalyzed by cytochromes P450. The oxygen atoms incorporated into both L-citrulline and NO⁻ are derived from atmospheric oxygen. It was originally assumed that oxygenation was occurring through mediation of **tetrahydrobiopterin (BH₄)**, a required cofactor for the overall reaction, analogous to the phenylalanine hydroxylase reaction (see p. 464). The discovery that **heme** (iron protoporphyrin IX) is a functional prosthetic group associated with all three isoforms of nitric oxide synthase has directed subsequent studies to include interactions between the flavoprotein and hemoprotein domains of these enzymes. These complex proteins must now be understood from the standpoint of the roles of the flavins, heme, and BH₄, under the control of Ca²⁺/calmodulin in the case of the neuronal (NOS-I) and endothelial (NOS-II) isoforms. Figure 23.12 shows the overall structural organization of the neuronal NOS isoform. In addition to the various protein modules or domains of NOS-I which are involved in electron transfer, substrate binding, oxygen activation, and calcium binding, a four-amino acid motif (glycine–leucine–glycine–phenylalanine, GLGF) has been identified in the amino terminal region of NOS-I. Although the function of this amino acid motif in NOS-I has not been established, studies on other proteins containing this motif indicate that it may serve to target proteins to specific sites in the cell.

The flow of electrons is assumed to occur in an analogous fashion to that of cytochrome P450-mediated electron systems. The electron donor is NADPH, which donates two electrons to the enzyme-bound entry FAD, which, in turn, reduces the exit FMN. It is the latter flavin that reduces the heme iron prosthetic group to Fe²⁺ to which oxygen can now bind for the oxygenation of the substrate, L-arginine. The overall reaction is inhibited by carbon monoxide and enzyme activity is totally dependent on bound calmodulin, which requires high concentrations of Ca²⁺ for the neuronal and endothelial isoforms. **Calmodulin** is involved in the control of electron flow between the flavin prosthetic groups and between the exit flavin, FMN, and the heme prosthetic group in the oxygenase module. While the precise residues constituting the binding site of BH₄ have not been identified, its location has been narrowed to the

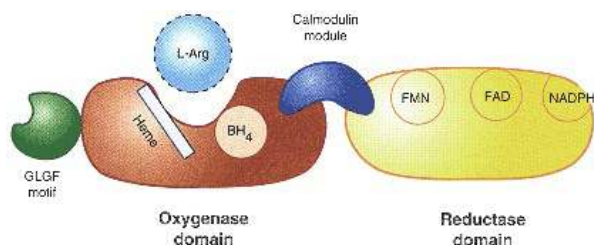

Figure 23.12
Modular structure of neuronal nitric oxide synthase showing approximate locations of prosthetic groups and cofactors.
 Adapted from Masters, B.S.S., McMillan, K., Sheta, E. A., Nishimura, J. S. et al. *FASEB J.*,10:552, 1996.

oxygenase module in the vicinity of the heme-binding site. The analogy between the systems synthesizing nitric oxide and the cytochrome P450-mediated systems is remarkable, but the differences are significant and the oxygenase module probably represents an example of convergent evolution with the cytochromes P450. The three-dimensional structures of mammalian representatives of either the cytochromes P450 or the nitric oxide synthases are yet to be determined.

Bibliography

Drug Metabolism and Cytochrome P450

Eichelbaum, M., and Gross, A. S. The genetic polymorphism of debrisoquine/sparteine metabolism—clinical aspects. In: W. Kalow (Ed.), *Pharmacogenetics of Drug Metabolism*. New York: Pergamon Press, 1992, Chap. 21, p. 625.

Gibson, G. G., and Skett, P. *Introduction to Drug Metabolism*, 2nd ed. London: Blackie Academic & Professional, 1994.

Guengerich, F. J. Reactions and significance of cytochrome P-450 enzymes. *J. Biol. Chem.* 266:10019, 1991.

Meyer, U. A., Skoda, R. C., Zanger, U. M., Heim, M., and Broly, F. The genetic polymorphism of debrisoquine/sparteine metabolism—molecular mechanism. In: W. Kalow (Ed.), *Pharmacogenetics of Drug Metabolism*. New York: Pergamon Press, 1992, Chap. 20, p. 609.

Nelson, D. R., Koymans, L., Kamataki, T., Stegeman, J. J., Feyereisen, R., Waxman, D. J., Waterman, M. R., Gotoh, O., Coon, M. J., Estabrook, R. W., Gunsalus, I. C., and Nebert, D. W. The P450 superfamily: update on new sequences, gene mapping, accession numbers and nomenclature. *Pharmacogenetics* 6:1, 1996.

Parkinson, A. Biotransformation of xenobiotics In: C. D. Klassen (Ed.), *Casarett and Doull's Toxicology: The Basic Science of Poisons*. New York: McGraw-Hill, 1996, Chap. 6, p. 113.

Wilkinson, G. R., Guengerich, F. P., and Branch, R. A. Genetic polymorphism of *S*-mephenytoin hydroxylation. In: W. Kalow (Ed.), *Pharmacogenetics of Drug Metabolism*. New York: Pergamon Press, 1992, Chap. 23, p. 657.

Electron Transport and Cytochrome P450

Estabrook, R. W., Cooper, D. Y., and Rosenthal, O. The light reversible carbon monoxide inhibition of the steroid C21-hydroxylase system of the adrenal cortex. *Biochem. Zeit.* 338:741, 1963.

Peterson, J. A., and Prough, R. A. Cytochrome P-450 reductase and cytochrome *b₅* in cytochrome P-450 catalysis. In: P. R. Ortiz de Montellano (Ed.), *Cytochrome P-450 Structure, Mechanism, and Biochemistry*. New York: Plenum Press, 1986, Chap. 4, p. 89.

Induction of Cytochrome P450

Denison, M. S., and Whitlock, J. P. Xenobiotic-inducible transcription of cytochrome P450 genes. *J. Biol. Chem.* 270:18175, 1995.

Sidhu, J. S., and Omiecinski, C. J. cAMP-associated inhibition of phenobarbital-inducible cytochrome P450 gene expression in primary rat hepatocyte cultures. *J. Biol. Chem.* 270:12762, 1995.

Endogenous Substrates and Cytochrome P450

Cunningham, F. G., MacDonald, P. C., Gant, N. F., Leveno, K. J., and Gilstrap, L. C. The placental hormones. In: *Williams Obstetrics*, 19th ed. East Norwalk, CT: Appleton & Lange, 1993, Chap. 6, p. 139.

Donohoue, P. A., Parker, K., and Migeon, C. J. Congenital adrenal hyperplasia. In: C. R. Scriver, A. L. Beaudet, W. S. Sly, and D. Valle (Eds.), *The Metabolic and Molecular Bases of Inherited Disease*, 7th ed., Vol. II. New York: McGraw-Hill, 1995, Chap. 94, p. 2929.

Graham-Lorence, S., Amareh, B., White, R. E., Peterson, J. A., and Simpson, E. R. A three-dimensional model of aromatase cytochrome P450. *Protein Sci.* 4:1065, 1995.

Masters, B. S. S., Muerhoff, A. S., and Okita, R. T. Enzymology of extrahepatic cytochromes P450. In: F. P. Guengerich (Ed.), *Mammalian Cytochromes P450*. Boca Raton, FL: CRC Press, 1987, Chap. 3, p. 107.

Waterman, M. R., John, M. E., and Simpson, E. R. Regulation of synthesis and activity of cytochrome P-450 enzymes in physiological pathways. In: P. R. Ortiz de Montellano (Ed.), *Cytochrome P-450. Structure, Mechanism, and Biochemistry*. New York: Plenum Press, 1986, Chap. 10, p. 315.

Biochemistry and Physiology of Nitric Oxide Formation

Bredt, D. S., and Snyder, S. H. Nitric oxide: a physiological messenger molecule. *Annu. Rev. Biochem.* 63:175, 1994.

Garthwaite, J., and Boulton, C. L. Nitric oxide signalling in the central nervous system. *Annu. Rev. Physiol.* 57:683, 1995.

Griffith, O. W., and Stuehr, D. J. Nitric oxide synthases—properties and catalytic mechanism. *Annu. Rev. Physiol.* 57:707, 1995.

Ignarro, L. J., Buga, G. M., Wood, K. S., Byrns, R. E., and Chaudhuri, G. Endothelium-derived relaxing factor produced and released from artery and vein is nitric oxide. *Proc. Natl. Acad. Sci. USA* 84:9265, 1987.

Khan, M. T., and Furchgott, R. F. Additional evidence that endothelium-derived relaxing factor is nitric oxide. In: M. J. Rand and C. Raper (Eds.), *Pharmacology*. Amsterdam: Elsevier, 1987, p. 341.

Marletta, M. A. Approaches toward selective inhibition of nitric oxide synthase. *J. Med. Chem.* 37:1899, 1994.

Masters, B. S. S. Nitric oxide synthases: Why so complex? *Annu. Rev. Nutr.* 14:131, 1994.

Masters, B. S. S., McMillan, K., Sheta, E. A., Nishimura, J. S., Roman, L. J., and Martasek, P. Neuronal nitric oxide synthase, a modular enzyme formed by convergent evolution: structure studies of a cysteine thiolate-liganded heme protein that hydroxylates L-arginine to produce NO as a cellular signal. *FASEB J.* 10:552, 1996.

Palmer, R. M. J., Ferrige, A. G., and Moncada, S. Nitric oxide release accounts for the biological activity of endothelium-derived relaxing factor. *Nature* 327:524, 1987.

Questions

C. N. Angstadt and J. Baggott

- All of the following are correct about a molecule designated as a cytochrome P450 EXCEPT:
 - it contains a heme as a prosthetic group.
 - it catalyzes the hydroxylation of a hydrophobic substrate.
 - it may accept electrons from a substance such as NADPH.
 - it undergoes a change in the heme iron upon binding a substrate.
 - it comes from the same gene family as all other molecules designated as cytochromes P450.
- Known roles for cytochromes P450 include all of the following EXCEPT:
 - synthesis of steroid hormones.
 - conversion of some chemicals to mutagens.
 - hydroxylation of an amino acid.
 - inactivation of some hydrophobic drugs.
 - metabolism of fatty acid derivatives.
- The induction of cytochromes P450:
 - occurs only by endogenous compounds.
 - occurs only at the transcriptional level.
 - necessarily results from increased transcription of the appropriate mRNA.
 - necessitates the formation of an inducer–receptor protein complex.
 - may occur by posttranscriptional processes.
- Flavoproteins are usually intermediates in the transfer of electrons from NADPH to cytochrome P450 because:
 - NADPH cannot enter the membrane.
 - flavoproteins can accept two electrons from NADPH and donate them one at a time to cytochrome P450.
 - they have a more negative reduction potential than NADPH and so accept electrons more readily.
 - as redox proteins, they can directly reduce cytochromes P450 while the nonprotein NADPH cannot.
 - they contain iron–sulfur centers.
- NADPH–cytochrome P450 reductase:
 - uses both FAD and FMN as prosthetic groups.
 - is found in mitochondria.
 - requires an iron–sulfur center for activity.
 - always passes its electrons to cytochrome b_5 .
 - can use NADH as readily as NADPH.
- The system necessary for the formation of double bonds in fatty acids:
 - is the cytochrome P450 electron transport system in the endoplasmic reticulum.
 - is the cytochrome P450 electron transport system in the mitochondria.
 - contains NADH–cytochrome b_5 reductase.
 - uses NADPH–adrenodoxin reductase to reduce cytochrome b_5 .
 - uses both FAD and FMN as prosthetic groups.
- NADPH–adrenodoxin reductase:
 - is located in the endoplasmic reticulum
 - passes its electrons to a protein with iron–sulfur centers.
 - has a stretch of hydrophobic amino acid residues at the N-terminal end.
 - reacts directly with cytochrome P450.
 - reacts directly with cytochrome b_5 .
- Cytochrome P450 systems are able to oxidize:
 - CH₂— groups.
 - benzene rings.
 - nitrogen atoms in an organic compound.
 - sulfur atoms in an organic compound.
 - all of the above.
- In the conversion of cholesterol to steroid hormones in the adrenal gland:
 - all of the cytochrome P450 oxidations occur in the endoplasmic reticulum.
 - all of the cytochrome P450 oxidations occur in the mitochondria.
 - side chain cleavage of cholesterol to pregnenolone is one of the cytochrome P450 systems that uses adrenodoxin reductase.
 - cytochrome P450 is necessary for the formation of aldosterone and cortisol but not for the formation of the androgens and estrogens.
 - aromatization of the first ring of the steroid does not use cytochrome P450 because it involves removal of a methyl group, not a hydroxylation.
- Many xenobiotics (exogenous substrates) are oxidized by cytochromes P450 in order to:
 - make them carcinogenic.
 - increase their solubility in an aqueous environment.
 - enhance their deposition in adipose tissue.
 - increase their pharmacological activity.
 - all of the above.
- Benzof[a]pyrene, a xenobiotic produced by combustion of a variety of substances:
 - induces the synthesis of cytochrome P450.
 - undergoes epoxidation by a cytochrome P450.
 - is converted to a potent carcinogen in animals by cytochrome P450.
 - would be rendered more water-soluble after the action of cytochrome P450.
 - all of the above.

12. Phenobarbital is a potent inducer of cytochrome P450. Warfarin, an anticoagulant, is a substrate for cytochrome P450 with the result that the drug is metabolized and cleared from the body more rapidly than normal. If phenobarbital is added to the therapeutic regimen of a patient, with no change in the dosage of warfarin, the expected consequence would be:

- A. no change in the clinical results.
- B. an increased possibility of clot formation.
- C. an increased possibility of hemorrhaging.

13. Nitric oxide:

- A. is formed spontaneously by a reduction of NO_2 .
- B. is synthesized only in macrophages.
- C. is synthesized from arginine.
- D. acts as a potent vasoconstrictor.
- E. has three isoforms.

14. Nitric oxide synthase:

- A. catalyzes a dioxygenase reaction.
- B. is similar mechanistically to phenylalanine hydroxylase since it requires tetrahydrobiopterin.
- C. accepts electrons from NADH.
- D. uses a flow of electrons from NADPH to FAD to FMN to heme iron.
- E. is inhibited by Ca^{2+} .

Answers

1. E Several gene families are known. The number after CYP designates the family. B: The types of substrates are hydrophobic. It is classified as a monooxygenase. C: See Figure 23.3. D: The change from hexa to penta coordinated gives the compound a more positive reduction potential (pp. 982–984).
2. C Cytochromes P450 are not the only hydroxylases and other types are active with amino acids (pp. 982, 989–995).
3. E There may be a stabilization of mRNA (as seen in diabetic rats) or decrease in the degradation of the protein, which may be a mechanism for pyrazole (p. 985). A: One of the roles of cytochromes P450 is in the metabolism of exogenous substances. B and C: Transcriptional modification is only one of the mechanisms of induction (see E). D: This has been shown with induction by some compounds, but with others, like phenobarbital, this is not so (p. 985).
4. B Heme can accept only one electron at a time while NADPH always donates two at a time. A: NADPH passes only electrons; it does not have to enter the membrane. C: If this were true, the flow of electrons would not occur in the way it does. D: Protein–protein binding is not known to play a role here. E: Iron–sulfur centers play a role in some, but not all, systems. Flavoproteins are not the only system with iron–sulfur centers (p. 987).
5. A This enzyme is one of two mammalian proteins known to do so. B: This is in the endoplasmic reticulum. C: Some reductases do so but not this one. D: Only certain reactions catalyzed by the enzyme do. E: There are NADH-dependent reductases but they are different enzymes (p. 988).
6. C This enzyme reduces desaturase. A: Desaturase does not react with cytochrome P450. B: Desaturase is in the endoplasmic reticulum. D: This is a mitochondrial system. E: This is not one of the two enzymes that use both flavins (p. 988).
7. B The iron–sulfur protein is adrenodoxin, which passes the electron to cytochrome P450. A and C: This is a mitochondrial enzyme. D and E: See B (p. 989).
8. E See Figure 23.7, p. 989.
9. C This is a mitochondrial process (Figure 23.8, p. 990). A and B: Hormone synthesis involves a series of reactions that move back and forth between mitochondria and endoplasmic reticulum (p. 991). D and E: Removal of side chains frequently begins with oxidation reactions (p. 992).
10. B The types of xenobiotics oxidized by cytochrome P450 are usually highly lipophilic but must be excreted in the aqueous urine or bile. A: This may happen but is certainly not the purpose. C: They do that prior to oxidation. D: Oxidation tends to reduce pharmacological activity (p. 992).
11. E A: It is not uncommon for xenobiotics to induce synthesis of something that will enhance their own metabolism. B and C: Epoxidation is the first step in the conversion of this compound to one that is carcinogenic—again, a common occurrence (p. 994). D: Benzo[a]pyrene, with its four fused benzene rings, is highly hydrophobic; introducing oxygens increases water solubility (p. 993).
12. B If warfarin is metabolized and cleared more rapidly by cytochrome P450, its therapeutic efficiency is decreased. Therefore, at the same dosage, it will be less effective as an anticoagulant. Think what would happen if the warfarin dosage were adjusted for a proper response, and then phenobarbital were withdrawn without adjusting the warfarin dose (see Clin. Corr. 23.1).
13. C The other product is citrulline. A and E: Three isoforms of nitric oxide synthase have been identified. B: One of the isoforms of NO synthase has been found in macrophages but neuronal and endothelial isoforms also exist. D: Nitric oxide is a vasodilator, which is the basis for the use of nitroglycerin in angina pectoris (p. 995).
14. D This is the second mammalian enzyme known to use both FAD and FMN. A: The reaction is a monooxygenation. B: BH_4 is required but the action of the enzyme is similar to a cytochrome P450-mediated system. C: The donor is NADPH. E: The system requires Ca^{2+} –calmodulin, at least the neuronal and endothelial isoforms (p. 996).

Chapter 24— Iron and Heme Metabolism

William M. Awad, Jr.

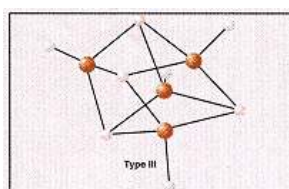

24.1 Iron Metabolism: Overview	1002
24.2 Iron-Containing Proteins	1003
Transferrin Transports Iron in Serum	1003
Lactoferrin Binds Iron in Milk	1003
Ferritin Is a Protein Involved in Storage of Iron	1004
Other Nonheme Iron-Containing Proteins Are Involved in Enzymatic Processes	1004
24.3 Intestinal Absorption of Iron	1005
24.4 Molecular Regulation of Iron Utilization	1006
24.5 Iron Distribution and Kinetics	1007
24.6 Heme Biosynthesis	1009
Enzymes in Heme Biosynthesis Occur in Both Mitochondria and Cytosol	1011
Aminolevulinic Acid Synthase	1011
ALA Dehydratase	1012
Porphobilinogen Deaminase	1013
Uroporphyrinogen Decarboxylase	1014
Coproporphyrinogen Oxidase	1015
Protoporphyrinogen Oxidase	1016
Ferrochelatase	1016
ALA Synthase Catalyzes Rate-Limiting Step of Heme Biosynthesis	1017
24.7 Heme Catabolism	1017
Bilirubin Is Conjugated to Form Bilirubin Diglucuronide in Liver	1018
Intravascular Hemolysis Requires Scavenging of Iron	1020
Bibliography	1021
Questions and Answers	1022
Clinical Correlations	
24.1 Iron Overload and Infection	1003
24.2 Duodenal Iron Absorption	1005
24.3 Mutant Iron-Responsive Element	1007
24.4 Ceruloplasmin Deficiency	1008
24.5 Iron-Deficiency Anemia	1009
24.6 Hemochromatosis: Molecular Genetics and the Issue of Iron-Fortified Diets	1011
24.7 Acute Intermittent Porphyrria	1013
24.8 Neonatal Isoimmune Hemolysis	1020
24.9 Bilirubin UDP-Glucuronosyltransferase Deficiency	1020
24.10 Elevation of Serum Conjugated Bilirubin	1021

24.1—

Iron Metabolism:**Overview**

Iron is closely involved in the metabolism of oxygen, permitting the transportation and participation of oxygen in a variety of biochemical processes. The common **oxidation states** are either **ferrous** (Fe^{2+}) or **ferric** (Fe^{3+}); higher oxidation levels occur as short-lived intermediates in certain redox processes. Iron has an affinity for electronegative atoms such as oxygen, nitrogen, and sulfur, which provide the electrons that form the bonds with iron. These can be of very high affinity when favorably oriented on macromolecules. In forming complexes, no bonding electrons are derived from iron. There is an added complexity to the structure of iron: the nonbonding electrons in the outer shell of the metal (the incompletely filled $3d$ orbitals) can exist in two states. Where bonding interactions with iron are weak, the outer nonbonding electrons will avoid pairing and distribute throughout the $3d$ orbitals. Where bonding electrons interact strongly with iron, however, there will be pairing of the outer nonbonding electrons, favoring lower-energy $3d$ orbitals. These two different distributions for each oxidation state of iron can be determined by electron spin resonance measurements. Dispersion of $3d$ electrons to all orbitals leads to the high-spin state, whereas restriction of $3d$ electrons to lower energy orbitals, because of electron pairing, leads to a low-spin state. Some iron–protein complexes reveal changes in spin state without changes in oxidation during chemical events (e.g., binding and release of oxygen by hemoglobin).

At neutral and alkaline pH ranges, the redox potential for iron in aqueous solutions favors the Fe^{3+} state; at acid pH values, the equilibrium favors the Fe^{2+} state. In the Fe^{3+} state iron slowly forms large polynuclear complexes with hydroxide ion, water, and other anions that may be present. These complexes can become so large as to exceed their solubility products, leading to their aggregation and precipitation with pathological consequences.

Iron can bind to and influence the structure and function of various macromolecules, with deleterious results to the organism. To protect against such reactions, several iron-binding proteins function specifically to store and transport iron. These proteins have both a very high affinity for the metal and, in the normal physiological state, also have incompletely filled iron-binding sites. The interaction of iron with its ligands has been well characterized in some proteins (e.g., hemoglobin and myoglobin), whereas for others (e.g., transferrin) it is presently in the process of being defined. The major area of ignorance in the biochemistry of iron lies in the *in vivo* transfer processes of iron from one macromolecule to another. Several proposed mechanisms may explain the process of iron transfer. Two are supported by excellent model studies but have varying degrees of relevance to the physiological state. The proposed processes are the following. First, the redox change of iron has been an attractive mechanism because it is supported by selective *in vitro* studies and because in some cases macromolecules have a very selective affinity for Fe^{3+} , binding Fe^{2+} poorly. Thus reduction of iron would permit ferrous ions to dissociate, and reoxidation would allow the iron to redistribute to appropriate macromolecules. Redox mechanisms have only been defined in a very few settings, some of which will be described below. An alternative hypothesis involves chelation of ferric ions by specific small molecules with high affinities for iron; this mechanism has been supported also by selective *in vitro* studies. The chelation mechanism suffers from the lack of a demonstrably specific *in vivo* chelator. Because the redox potential strongly favors ferric ion at almost all tissue sites and because Fe^{3+} binds so strongly to liganding groups, the probability is that there are cooperating mechanisms regulating the intermolecular transfer of iron.

CLINICAL CORRELATION 24.1**Iron Overload and Infection**

If an individual is overloaded with iron by any of several causes, the serum transferrin value can be close to saturation, making small amounts of free serum iron available. Microorganisms that are usually nonpathogenic, because they are iron dependent and cannot compete against partially saturated transferrin in the normal individual, can now become pathogenic under these circumstances. For example, *Vibrio vulnificus*, a marine halophile, is found in a small percentage of oysters and commercial shellfish. Individuals who are iron overloaded can develop a rapidly progressive infection, with death ensuing within 24 h after ingestion of the offending meal, whereas normal individuals consuming the same food are entirely free of symptoms.

Muench, K. H. Hemochromatosis and infection: alcohol and iron, oysters and sepsis. *Am. J. Med.* 87:3, 1989.

24.2—**Iron-Containing Proteins**

Iron binds to proteins either by incorporation into a **protoporphyrin IX** ring (see below) or by interaction with other protein ligands. Ferrous- and ferric-protoporphyrin IX complexes are designated **heme** and **hematin**, respectively. Heme-containing proteins include those that transport (e.g., hemoglobin) and store (e.g., myoglobin) oxygen, and certain enzymes that contain heme as part of their prosthetic groups (e.g., catalase, peroxidases, tryptophan pyrrolase, prostaglandin synthase, guanylate cyclase, NO synthase, and the microsomal and mitochondrial cytochromes.). Discussions on structure–function relationships of heme proteins are presented in Chapters 6 and 25.

Nonheme proteins include transferrin, ferritin, a variety of redox enzymes that contain iron at the active site, and iron–sulfur proteins. A significant body of information has been acquired that relates to the structure–function relationships of some of these molecules.

Transferrin Transports Iron in Serum

The protein in serum involved in the transport of iron is **transferrin**, a β 1-glycoprotein synthesized in the liver, consisting of a single polypeptide chain of 78,000 Da with two noncooperative iron-binding sites. The protein is a product of gene duplication derived from a putative ancestral gene coding for a protein binding only one atom of iron. Several metals bind to transferrin; the highest affinity is for Fe^{3+} ; Fe^{2+} ion is not bound. The binding of each Fe^{3+} ion is absolutely dependent on the coordinate binding of an anion, which in the physiological state is carbonate as indicated below:

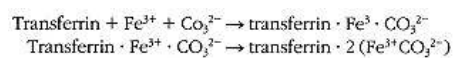

Estimates of the association constants for the binding of Fe^{3+} to transferrins from different species range from 10^{19} to 10^{31} M^{-1} , indicating for practical purposes that wherever there is excess transferrin free ferric ions will not be found. In the normal physiological state, approximately one-ninth of all transferrin molecules are saturated with iron at both sites; four-ninths of transferrin molecules have iron at either site; and four-ninths of circulating transferrin are free of iron. Unsaturated transferrin protects against infections (see Clin. Corr. 24.1). The two iron-binding sites show differences in sequences and in affinities for other metals. Transferrin binds to specific cell surface receptors that mediate the internalization of the protein.

The **transferrin receptor** is a transmembrane protein consisting of two subunits of 90,000 Da each, joined by a disulfide bond. Each subunit contains one transmembrane segment and about 670 residues that are extracellular and bind a transferrin molecule, favoring the diferric form. Internalization of the receptor–transferrin complex is dependent on receptor phosphorylation by a Ca^{2+} –calmodulin–protein kinase C complex. Release of the iron atoms occurs within the acidic milieu of the lysosome after which the receptor–apotransferrin complex returns to the cell surface where the apotransferrin is released to be reutilized in the plasma.

Lactoferrin Binds Iron in Milk

Milk contains iron that is bound almost exclusively to a glycoprotein, **lactoferrin**, closely homologous to transferrin, with two sites binding the metal. The iron content of the protein varies, but it is never saturated. Studies on the function of lactoferrin have been directed toward its antimicrobial effect, protecting the newborn from gastrointestinal infections. Microorganisms require iron for

replication and function. Presence of incompletely saturated lactoferrin results in the rapid binding of any free iron, leading to the inhibition of microbial growth by preventing a sufficient amount of iron from entering these microorganisms. Other microbes, such as *Escherichia coli*, which release competitive iron chelators, are able to proliferate despite the presence of lactoferrin, since the chelators transfer the iron specifically to the microorganism. Lactoferrin is present in granulocytes being released during bacterial infections. It is also present in mucous secretions. Besides its bacteriostatic function it is believed to facilitate iron transport and storage in milk. Lactoferrin has been found in urine of premature infants fed human milk.

Ferritin Is a Protein Involved in Storage of Iron

Ferritin is the major protein involved in the storage of iron. The protein consists of an outer polypeptide shell 130 Å in diameter with a central ferric-hydroxide-phosphate core 60 Å across. The apoprotein, **apoferritin**, consists of 24 subunits of a varying mixture of H subunits (178 amino acids) and L subunits (171 amino acids) that provide various isoprotein forms. H subunits predominate in nucleated blood cells and heart, L subunits in liver and spleen. Synthesis of the subunits is regulated mainly by the concentration of free intracellular iron. The bulk of iron storage occurs in hepatocytes, reticuloendothelial cells, and skeletal muscle. The ratio of iron to polypeptide is not constant, since the protein has the ability to gain and release iron according to physiological needs. With a capacity of 4500 iron atoms, the molecule contains usually less than 3000. Channels from the surface permit the accumulation and release of iron. When iron is in excess, the storage capacity of newly synthesized apoferritin may be exceeded. This leads to iron deposition adjacent to ferritin spheres. Histologically, such amorphous iron deposition is called **hemosiderin**. The H chains of ferritin oxidize ferrous ions to the ferric state. Ferritins derived from different tissues of the same species differ in electrophoretic mobility in a fashion analogous to the differences noted with isoenzymes. In some tissues ferritin spheres form lattice-like arrays, which are identifiable by electron microscopy. Plasma ferritin (low in iron, rich in L subunits) has a half-life of 50 h and is cleared by reticuloendothelial cells and hepatocytes, and its concentration, although very low, correlates closely to the size of the body iron stores.

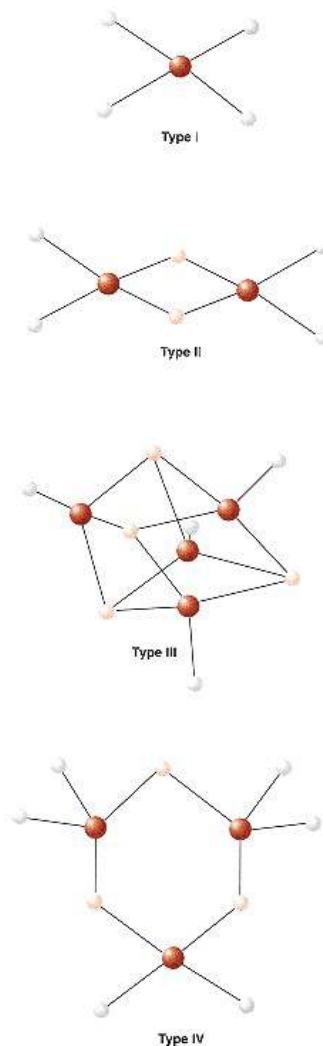

Figure 24.1

Structure of ferredoxins.

Dark red circles represent iron atoms; light red circles represent the inorganic sulfur atoms; and small gray circles represent the cysteinyl sulfur atoms derived from the polypeptide chain. Variation in type IV ferredoxins can occur where one of the cysteinyl residues can be substituted by a solvent oxygen atom of an OH group.

Other Nonheme Iron-Containing Proteins Are Involved in Enzymatic Processes

Many iron-containing proteins are involved in enzymatic processes, most of which are related to oxidation mechanisms. The structural features of the ligands binding the iron are not well known, except for a few components involved in mitochondrial electron transport. These latter proteins, termed **ferredoxins**, are characterized by iron being bonded, with one exception, only to sulfur atoms. Four major types of such proteins are known (see Figure 24.1). The smallest, type I (e.g., nebreodoxin), found only in microorganisms, consists of a small polypeptide chain with a mass of about 6000 and contains one iron atom bound to four cysteine residues. Type II consists of ferredoxins found in both plants and animal tissues where two iron atoms are found, each liganding to two separate cysteine residues and sharing two sulfide anions. The most complicated of the iron-sulfur proteins are the bacterial ferredoxins, type III, which contain four atoms of iron, each of which is linked to single separate cysteine residues but also shares three sulfide anions with neighboring iron molecules to form a cube-like structure. In some anaerobic bacteria, a family of ferredoxins may contain two type III iron-sulfur groups per macromolecule. Type IV ferredoxins contain structures with three atoms of iron, each linked to two separate cysteine residues and each sharing two sulfide anions, forming a

CLINICAL CORRELATION 24.2**Duodenal Iron Absorption**

Mucin in the duodenal lumen helps to solubilize ferric ions with presentation of the metal to an integrin, a transmembrane protein consisting of a heterodimer of 230 kDa. The cytosolic surface of the integrin interacts with a 56-kDa protein known as mobilferrin. The integrin transfers the iron from the luminal to cytoplasmic surface of the cell, where it is bound by mobilferrin. Mobilferrin acts as a cytosolic shuttle, transferring iron either to cytosolic ferritin or to the opposite pole of the duodenal cell where the iron is transported by an as yet undefined mechanism to capillaries to be picked up by transferrin.

Conrad, M. D., and Umbreit, J. N. Iron absorption—the mucin–mobilferrin–integrin pathway. A competitive pathway for metal absorption. *Am. J. Hematol.* 42:67, 1993.

planar ring. In one example of this ferredoxin type, an exception of iron atoms being liganded only to sulfur atoms was found where the sulfur of a cysteinyl residue was substituted by a solvent oxygen atom. The redox potential afforded by these different ferredoxins varies widely and is in part dependent on the environment of the surrounding polypeptide chain that envelops these iron–sulfur groups. In nebreodoxin the iron undergoes ferric–ferrous conversion during electron transport. With the plant and animal ferredoxins (type II iron–sulfur proteins) both irons are in the Fe^{3+} form in the oxidized state; upon reduction only one iron goes to Fe^{2+} . In the bacterial ferredoxin (type III iron–sulfur protein) the oxidized state can be either $2 \text{Fe}^{3+} \cdot 2 \text{Fe}^{2+}$ or $3 \text{Fe}^{3+} \cdot \text{Fe}^{2+}$, with corresponding reduced forms of $\text{Fe}^{3+} \cdot 3 \text{Fe}^{2+}$ or $2 \text{Fe}^{3+} \cdot 2 \text{Fe}^{2+}$.

24.3—**Intestinal Absorption of Iron**

The high affinity of iron for both specific and nonspecific macromolecules leads to the absence of significant formation of free iron salts, and thus this metal is not lost via usual excretory routes. Rather, excretion of iron occurs only through the normal sloughing of tissues that are not reutilized (e.g., epidermis and gastrointestinal mucosal cells). In the healthy adult male the loss is about 1 mg day^{-1} . In premenopausal women, the normal physiological events of menses and parturition substantially augment iron loss. A wide variation of such loss exists, depending on the amounts of menstrual flow and the multiplicity of births. In the extremes of the latter settings, a premenopausal woman may require an amount of iron that is four to five times that needed in an adult male for prolonged periods of time. The postmenopausal woman who is not iron-deficient has an iron requirement similar to that of the adult male. Children and patients with blood loss naturally have increased iron requirements.

Cooking of food facilitates the breakdown of ligands attached to iron, increasing the availability of the metal in the gut. The low pH of stomach contents permits the reduction of Fe^{3+} to Fe^{2+} , facilitating dissociation from ligands. The latter requires the presence of an accompanying **reductant**, which is usually achieved by adding **ascorbate** to the diet. The absence of a normally functioning stomach reduces substantially the amount of iron that is absorbed. Some iron-containing compounds bind the metal so tightly that it is not available for assimilation. Contrary to popular belief, spinach is a poor source of iron because of an earlier erroneous record of the iron content and because some of the iron is bound to phytate (inositol hexaphosphate), which is resistant to the chemical actions of the gastrointestinal tract. Specific protein cofactors derived from the stomach or pancreas have been suggested as being facilitators of iron absorption in the small intestine.

The major site of **absorption of iron** is in the small intestine, with the largest amount being absorbed in the duodenum and a gradient of lesser absorption occurring in the more distal portions of the small intestine. The metal enters the mucosal cell either as the free ion or as heme; in the latter case the metal is split off from the porphyrin ring in the mucosal cytoplasm. The large amount of bicarbonate secreted by the pancreas neutralizes the acidic material delivered by the stomach and thus favors the oxidation of Fe^{2+} to Fe^{3+} . The major barrier to the absorption of iron is not at the luminal surface of the duodenal mucosal cell. Whatever the requirements of the host are, in the face of an adequate delivery of iron to the lumen, a substantial amount of iron will enter the mucosal cell. Regulation of iron transfer occurs between the mucosal cell and the capillary bed (see Figure 24.2 and Clin. Corr. 24.2). In the normal state, certain processes define the amount of iron that will be transferred. Where there is **iron deficiency**, the amount of transfer increases; where there is **iron overload** in the host, the amount transferred is curtailed substantially. One mechanism that has been demonstrated to regulate this transfer of iron across the mucosal–capillary

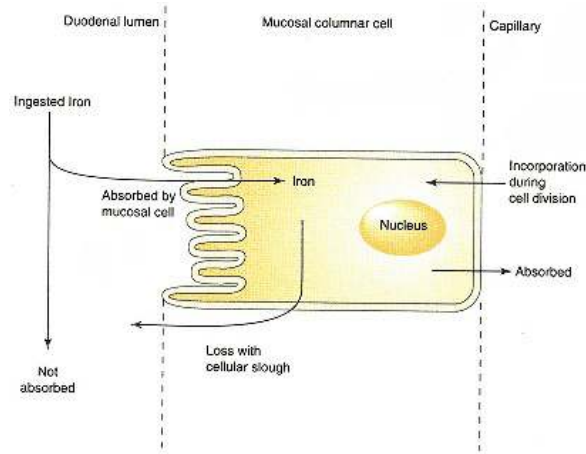

Figure 24.2

Intestinal mucosal regulation of iron absorption.

The flux of iron in the duodenal mucosal cell is indicated. A fraction of the iron that is potentially acceptable is transferred from the intestinal lumen into the epithelial cell. A large portion of ingested iron is not absorbed, in part because it is not presented in a readily acceptable form. Some iron is retained within the cell, bound by apoferritin to form ferritin. This iron is sloughed into the intestinal lumen with the normal turnover of the cell. A portion of the iron within the mucosal cell is absorbed and transferred to the capillary bed to be incorporated into transferrin. During cell division, which occurs at the bases of the intestinal crypts, iron is incorporated for cellular requirements. These fluxes change dramatically in iron-depleted or iron-excess states.

interface is the synthesis of apoferritin by the mucosal cell. In situations in which little iron is required by the host, a large amount of apoferritin is synthesized to trap the iron within the mucosal cell and prevent transfer to the capillary bed. As the cells turn over (within a week), their contents are extruded into the intestinal lumen without absorption occurring. In situations in which there is iron deficiency, virtually no apoferritin is synthesized so as not to compete against the transfer of iron to the deficient host. There are other as yet undefined positive mechanisms that increase the rate of iron absorption in the iron-deficient state. Iron transferred to the capillaries is trapped exclusively by transferrin.

24.4— Molecular Regulation of Iron Utilization

Cytosol contains at least two proteins that respond to changes in iron concentration. They act as effector molecules controlling the translation of mRNAs, which are important in iron metabolism. These **iron regulatory proteins (IRPs)** bind to specific **stem-loop structures** on certain mRNAs. IRP-1 is the best defined of these proteins. It contains an Fe_4S_4 cubane group when the cellular concentration of iron is high. This prosthetic group activates IRP-1 so that it possesses an **aconitase** activity. However, since neither citrate nor isocitrate is present in significant amounts in the cytosol, the activity is only a potential

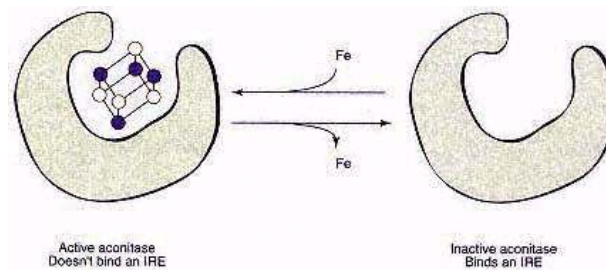

Figure 24.3

Iron-responsive protein-1.

Dark blue circles represent iron atoms and open circles inorganic sulfur atoms.

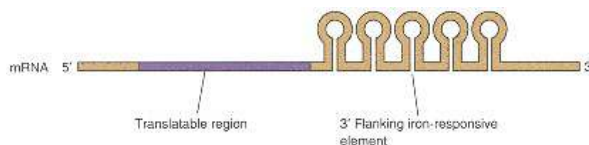

Figure 24.4
Structure of transferrin receptor mRNA.

CLINICAL CORRELATION 24.3

Mutant Iron-Responsive Element

Single mutations have been described of two adjacent bases in the loop segment of the iron-responsive element of ferritin light chain mRNA with an increased amount of apoferritin being synthesized but without an increase in total body iron. This mutation leads to a 28-fold lower affinity for IRP-1 in one case and perhaps an even lower affinity in the other. The reason why these patients have cataracts is unknown. The gene for MP-19, an abundant protein in the lens, which is very close to the light chain gene on chromosome 19, might possibly be affected by the regulatory process on the mRNA. However, it is more probable that a greatly increased synthesis of ferritin in the lens leads to an increased amount of iron-catalyzed reactions with well-described oxidative lenticular damage.

Girelli, D., Corrocher, R., Bisceglia, L., et al. Molecular basis for the recently described hereditary hyperferritinemia–cataract syndrome: a mutation in the iron-responsive elements of ferritin L-subunit gene (the "Verona mutation"). *Blood* 86:4050, 1995; and Beaumont, C., Leneuve, P., Devaux, I., Scoazec, J. Y., et al. Mutation in the iron responsive element of the L ferritin mRNA in a family with dominant hyperferritinaemia and cataract. *Nature Genet.* 11:444, 1995.

one. At low iron concentrations, the cubane structure collapses, dissociating from the protein and leaving an apoenzyme without catalytic activity. However, it can now bind to specific mRNA stem–loop structures, known as **iron-responsive elements (IREs)** (Figure 24.3). Five mRNAs are known to contain IREs: those for the light and heavy chains of ferritin, the erythrocytic form of amino-levulinic acid synthase, the mitochondrial form of aconitase, and transferrin receptor. (Mitochondrial aconitase, the physiologically active isozyme, has no IRP function.) The first four mRNAs have single IREs in the 5' flanking region, which bind a single IRP. In contrast, the transferrin receptor has five tandem IREs that bind IRPs in the 3' flanking region. The binding of the 5' and 3' flanking IREs leads to different translational effects. In the iron-deprived state, binding to the 3' IRE of transferrin receptor (Figure 24.4) leads to stabilization of the mRNA with reduced turnover and, therefore, an increased number of receptor-specific RNA molecules, thereby leading to the increased synthesis of receptor protein. The single 5' stem–loop of ferritin mRNA (Figure 24.5) is homologous to the 3' stem–loops of the transferrin receptor mRNA. However, in the former case, binding of the IRP leads to a decreased rate of translation of the mRNA and, thereby, to a decreased concentration of ferritin molecules. Note that the molecular events that are controlled are different in the syntheses of transferrin receptor and apoferritin (see Clin. Corr. 24.3).

In summary, low iron concentrations lead to activation of an IRP that binds to the mRNAs for transferrin receptor and ferritin. In the former case, more receptor is synthesized, while in the latter case less apoferritin is synthesized. The net effect is utilization of iron by proliferating cells. In contrast, high iron concentrations lead to loss of binding by the IRPs to IREs, with a shift of iron from uptake by proliferating cells to storage in the liver.

IRP-1 is regulated by its change from active to inactive states in mRNA-binding properties as noted above. **IRP-2**, a second regulatory protein, also responds to varying concentrations of iron, but in this case, the protein is regulated by increased synthesis at low iron concentrations and increased degradation by a proteasome at high iron concentrations. In addition to the effects of changed iron concentration, increased production of NO (see p. 995) also acts to regulate IRPs.

24.5—

Iron Distribution and Kinetics

A normal 70-kg male has 3–4 g of iron, of which only 0.1% (3.5 mg) is in the plasma. Approximately 2.5 g are in hemoglobin. Table 24.1 lists the distribution

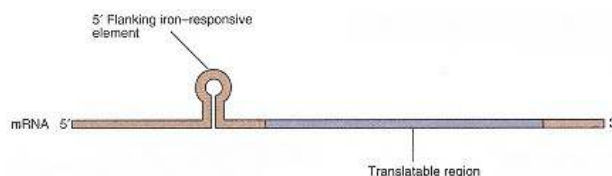

Figure 24.5
Structure of apoferritin H-subunit mRNA.

CLINICAL CORRELATION 24.4**Ceruloplasmin Deficiency**

A deficiency of ceruloplasmin, a copper-containing protein, but not its absence, is associated with Wilson's disease in which there is progressive hepatic failure and degeneration of the basal ganglia, associated with a characteristic copper deposition in the cornea (Kayser–Fleischer rings). Because there was no evidence for significant impairment of mobilization of iron in Wilson's disease, it was originally thought that the ferroxidase activity of ceruloplasmin was not physiologically important. However, a recently discovered very rare genetic defect in ceruloplasmin biosynthesis, where the protein was virtually absent in serum, leads to a marked elevation of liver-iron content and serum ferritin levels. These patients develop diabetes, retinal degeneration, and central nervous system findings. The diabetes and central nervous system findings are associated with increased iron in the pancreas and brain, respectively. Thus, in contrast to earlier considerations, it appears that ceruloplasmin has a significant role in iron metabolism.

Harris, E. D. The iron–copper connection: the link to ceruloplasmin grows stronger. *Nutr. Rev.* 53:226, 1995.

of iron in humans. Normally about 33% of the sites on transferrin contain iron. Iron picked up from the intestine is delivered primarily to the marrow for incorporation into the hemoglobin of red blood cells. The mobilization of iron from the mucosa and from storage sites involves in part the reduction of iron to the ferrous state and its reoxidation to the ferric form. The reduction mechanisms have not been well described. On the other hand, conversion of the Fe^{2+} back to Fe^{3+} state is regulated by serum enzymes called ferroxidases as indicated below:

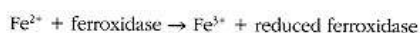

TABLE 24.1 Approximate Iron Distribution: 70-kg Man

	<i>g</i>	%
Hemoglobin	2.5	68
Myoglobin	0.15	4
Transferrin	0.003	0.1
Ferritin, tissue	1.0	27
Ferritin, serum	0.0001	0.004
Enzymes	0.02	0.6
Total	3.7	100

Ferroxidase I is also known as **ceruloplasmin** (see Clin. Corr. 24.4). Another serum protein, **ferroxidase II**, appears to be the major serum component that oxidizes ferrous ions. In any disease process in which iron loss exceeds iron repletion, a sequence of physiological responses occurs. The initial events are without symptoms to the subject and involve depletion of iron stores without compromise of any physiological function. This depletion will be manifested by a reduction or absence of iron stores in the liver and in the bone marrow and also by a decrease in the content of the very small amount of ferritin that is normally present in plasma. Serum ferritin levels reflect slow release from storage sites during the normal cellular turnover that occurs in the liver; measurements are made by radioimmunoassays. Serum ferritin is mostly apoferritin in form, containing very little iron. During this early phase, the level and percentage saturation of serum transferrin are not distinctly abnormal. As the iron deficiency progresses, the level of hemoglobin begins to fall and morphological changes appear in the red blood cells. Concurrently, the serum iron falls with a rise in the level of total serum transferrin, the latter reflecting a physiological adaptation in an attempt to absorb more iron from the gastrointestinal tract. At this state of iron depletion a very sensitive index is the percentage saturation of serum transferrin with iron (normal range, 21–50%). At this point the patient usually comes to medical attention, and the diagnosis of iron deficiency is made. In countries in which iron deficiency is severe without available corrective medical measures, a third and severe stage of iron deficiency can occur, where a depletion of iron-containing enzymes leads to very pronounced metabolic effects (see Clin. Corr. 24.5).

Iron overload can occur in patients so that the iron content of the body can be elevated to values as high as 100 g. This may happen for a variety of reasons. Some patients have a recessive heritable disorder associated with a marked inappropriate increase in iron absorption. In such cases the serum transferrin can be almost completely saturated with iron. This state, which is known as **idiopathic hemochromatosis**, is more commonly seen in men because women with the abnormal gene are protected somewhat by menstrual and childbearing events. The accumulation of iron in the liver, pancreas, and heart can lead to cirrhosis and liver tumors, diabetes mellitus, and cardiac failure, respectively. Treatment for these patients is periodic withdrawals of large amounts of blood, where the iron is contained in the hemoglobin. Another group of patients has severe anemias, among the most common of which are the thalassemias, a group of hereditary **hemolytic anemias**. In these cases the subjects require transfusions throughout their lives, leading to the accumulation of large amounts of iron derived from the transfused blood. Clearly bleeding would be an inappropriate measure in these cases; rather, the patients are treated by the administration of iron chelators, such as desferrioxamine, which leads to the excretion of large amounts of complexed iron in the urine. Rarely, a third group of patients will acquire excess iron because they ingest large amounts of both iron and ethanol, the latter promoting iron absorption. In these cases excess stored iron can be removed by bleeding (see Clin. Corr. 24.6).

CLINICAL CORRELATION 24.5**Iron-Deficiency Anemia**

Microscopic examination of a blood smear in patients with iron-deficiency anemia usually reveals the characteristic findings of microcytic (small in size) and hypochromic (underpigmented) red blood cells. These changes in the red cell result from decreased rates of globin synthesis when heme is not available. A bone marrow aspiration will reveal no storage iron to be present and serum ferritin values are virtually zero. The serum transferrin value (expressed as the total iron-binding capacity) will be elevated (upper limits of normal: 410 g dL^{-1}) with a serum iron saturation of less than 16%. Common causes for iron deficiency include excessive menstrual flow, multiple births, and gastrointestinal bleeding that may be occult. The common causes of gastrointestinal bleeding include medications that can cause ulcers or erosion of the gastric mucosa (especially aspirin or cortisone-like drugs), hiatal hernia, peptic ulcer disease, gastritis associated with chronic alcoholism, and gastrointestinal tumor. The management of such patients must include both a careful examination for the cause and source of bleeding and supplementation with iron. The latter is usually provided in the form of oral ferrous sulfate tablets; occasionally, intravenous iron therapy may be required. Where the iron deficiency is severe, transfusion with packed red blood cells may also be indicated.

Finch, C. A., and Huebers, H. Perspectives in iron metabolism. *N. Engl. J. Med.* 306:1520, 1982.

24.6—**Heme Biosynthesis**

Heme is produced in virtually all mammalian tissues. Its synthesis is most pronounced in the bone marrow and liver because of the requirements for incorporation into hemoglobin and the cytochromes, respectively. As depicted in Figure 24.6, heme is largely a planar molecule. It consists of one ferrous ion and a tetrapyrrole ring, **protoporphyrin IX**. The diameter of the iron atom is a little too large to be accommodated within the plane of the porphyrin ring, and thus the metal puckers out to one side as it coordinates with the apical nitrogen atoms of the four pyrrole groups. Heme is one of the most stable compounds, reflecting its strong resonance features.

Figure 24.7 depicts the pathway for heme biosynthesis. The following are the important aspects to be noted. First, the initial and last three enzymatic steps are catalyzed by enzymes that are in the mitochondrion, whereas the intermediate steps take place in the cytoplasm. This is important in considering the regulation by heme of the first biosynthetic step; this aspect is discussed below. Second, the organic portion of heme is derived totally from eight residues each of glycine and succinyl CoA. Third, the reactions occurring on the side groups attached to the tetrapyrrole ring involve the colorless intermediates known as **porphyrinogens**. The latter compounds, though exhibiting reso-

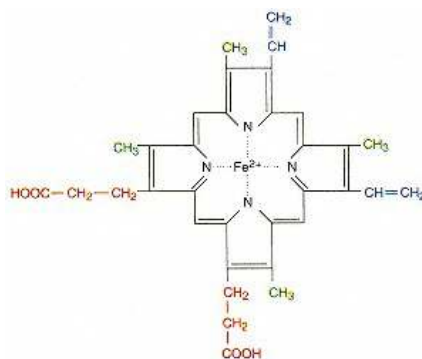

Figure 24.6
Structure of heme.

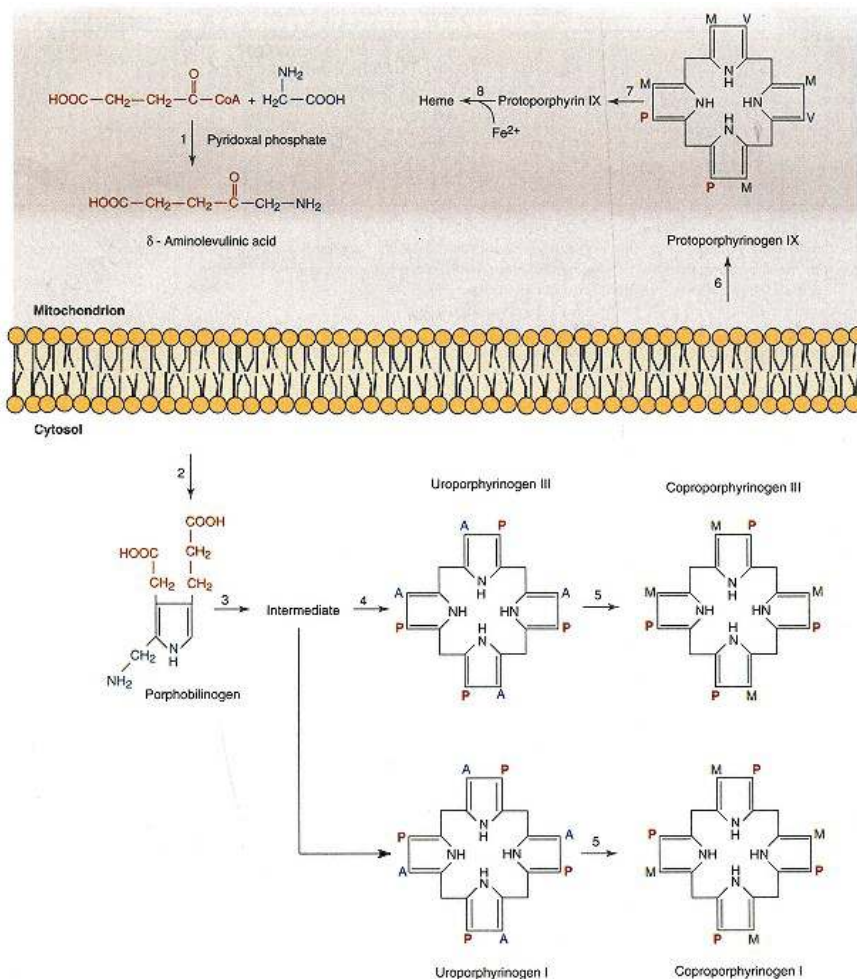

Figure 24.7

Pathway for heme biosynthesis.

Numbers indicate enzymes involved in each step as follows: 1, ALA synthase; 2, ALA dehydratase; 3, porphobilinogen deaminase; 4, uroporphyrinogen III cosynthase; 5, uroporphyrinogen decarboxylase; 6, coproporphyrinogen III oxidase; 7, protoporphyrinogen IX oxidase; 8, ferrochelatase. Pyrrole ligands are indicated as follows: P, propionic (β -carboxyethyl); A, acetic (carboxymethyl); M, methyl; V, vinyl.

nance features within each pyrrole ring, do not demonstrate resonance between the pyrrole groups. As a consequence, the porphyrinogens are unstable and can readily be oxidized, especially in the presence of light, by nonenzymatic means to their stable **porphyrin** products. In the latter cases resonance between pyrrole groups is established by oxidation of the four methylene bridges. Figure 24.8 depicts the enzymatic conversion of protoporphyrinogen to protoporphyrin

CLINICAL CORRELATION 24.6**Hemochromatosis: Molecular Genetics and the Issue of Iron-Fortified Diets**

The hemochromatosis gene is heterozygous in about 9% of the population. The disease is expressed primarily in the homozygous state; about 0.25% of all individuals are at risk. Normal individuals have a major histocompatibility complex class-1 gene (HLA-H) with unknown function that encodes for the α -chain, containing three immunoglobulin-like domains. The normal gene product has a structure that cannot present an antigen. Most individuals with hemochromatosis are homozygous for a Cys₂₈₂-Tyr mutation which prevents the normal conformation of an immunoglobulin domain.

A controversy has developed as to whether food should be fortified with iron because of the prevalence of iron-deficiency anemia, especially among premenopausal women. It was suggested that dietary iron deficiency would be reduced if at least 50 mg of iron was incorporated per pound of enriched flour. Others suggested that toxicity from excess iron absorption through iron fortification was too great. Sweden has mandated iron fortification for 45 years and about 42% of the average daily intake of iron is derived from these sources. However, 5% of males had elevation of serum iron values, with 2% having iron stores consonant with the distribution found in early stages of hemochromatosis, pointing out the danger of iron-fortified diets. In countries where iron deficiency is widespread, however, fortification may still be the most appropriate measure.

McLaren, C. E., Gorddeuk, V. R., Looker, A. C., et al. Prevalence of heterozygotes for hemochromatosis in the white population of the United States. *Blood* 86:2021, 1995; Feder, J. N., Gnirki, A., Thomas, W., et al. A novel MHC class 1-like gene is mutated in patients with hereditary haemochromatosis. *Nature Genetics* 13:399, 1996; Olsson, K. S., Heedman, P. A., and Staugard, F. Preclinical hemochromatosis in a population on a high-iron-fortified diet. *J. Am. Med. Assoc.* 239:1999, 1978; Olsson, K. S., Marsell, R., Ritter, B., Olander, B., et al. Iron deficiency and iron overload in Swedish male adolescents. *J. Intern. Med.* 237:187, 1995.

by this oxidation mechanism. This is the only known porphyrinogen oxidation that is enzyme regulated in humans; all other porphyrinogen porphyrin conversions are nonenzymatic and catalyzed by light rather than catalyzed by specific enzymes. Fourth, once the tetrapyrrole ring is formed, the order of the R groups as one goes clockwise around the tetrapyrrole ring defines which of the four possible types of **uro-** or **coproporphyrinogens** are being synthesized. These latter compounds have two different substituents, one each for every pyrrole group. Going clockwise around the ring, the substituents can be arranged as ABABABAB (where A is one substituent and B the other), forming a type I porphyrinogen, or the arrangement can be ABABABBA, forming a type III porphyrinogen. In principle, two other arrangements can occur to form porphyrinogens II and IV, and these can be synthesized chemically; however, they do not occur naturally. In protoporphyrinogen and protoporphyrin there are three types of substituents, and the classification becomes more complicated; type IX is the only form that is synthesized naturally.

Derangements of porphyrin metabolism are known clinically as the **porphyrias**. This family of diseases is of great interest because it has revealed that the regulation of heme biosynthesis is complicated. The clinical presentations of the different porphyrias provide a fascinating exposition of biochemical regulatory abnormalities and their relationship to pathophysiological processes. Table 24.2 lists the details of the different porphyrias (see Clin. Corr. 24.7).

Enzymes in Heme Biosynthesis Occur in Both Mitochondria and Cytosol**Aminolevulinic Acid Synthase**

Aminolevulinic acid (ALA) synthase controls the rate-limiting step of heme synthesis in all tissues studied. Synthesis of the enzyme is not directed by mitochondrial DNA but occurs rather in the cytosol, being directed by mRNA derived from the nucleus. The enzyme is incorporated into the matrix of the mitochondrion. Succinyl CoA is one of the substrates and is found only in the mitochondrion. This protein has been purified to homogeneity from rat liver mitochondria. The cytosolic protein is a dimer of a 71,000-Da subunit, containing a basic N-terminal signaling sequence that directs the enzyme into the mitochondrion. An ATP-dependent 70,000-Da cytosolic component, known as a chaperone protein, maintains ALA synthase in the unfolded extended state, the only form that can pass through the mitochondrial membrane. Thereafter, the N-

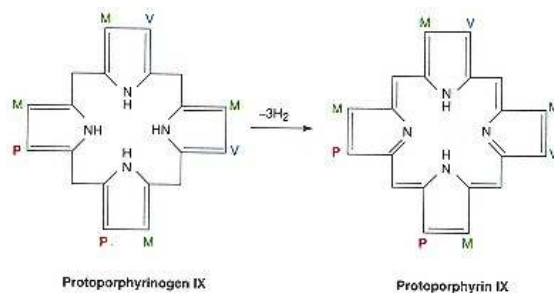

Figure 24.8

Action of protoporphyrinogen IX oxidase, an example of the conversion of a porphyrinogen to a porphyrin.

terminal signaling sequence is cleaved by a metal-dependent protease in the mitochondrial matrix, yielding an ALA synthase with subunits of 65,000 Da each. Within the matrix another oligomeric chaperone protein, of 14 subunits of 60,000 Da each, catalyzes the correct folding of the protein in a second ATP-dependent process (Figure 24.9, p. 1014). The ALA synthase has a short biological half-life (~60 min). Both the synthesis and activity of the enzyme are subject to regulation by a variety of substances; 50% inhibition of activity occurs in the presence of 5 mM of hemin, and virtually complete inhibition is noted at a 20-mM concentration. The enzymatic reaction involves the condensation of a **glycine** residue with a residue of **succinyl CoA**. The reaction has an absolute requirement for **pyridoxal phosphate**. Two isoenzymes exist for ALA synthase; only the erythrocytic form contains an IRE.

ALA Dehydratase

Aminolevulinic acid dehydratase (280 Da) (or porphobilinogen synthase) is a cytosol component consisting of eight subunits, of which only four interact with the substrate. This protein also interacts with the substrate to form a Schiff base, but in this case the α -amino group of a lysine residue binds to the ketonic carbon of the substrate molecule (Figure 24.10, p. 1015). Two molecules of

TABLE 24.2 Derangements in Porphyrin Metabolism

<i>Disease State</i>	<i>Genetics</i>	<i>Tissue</i>	<i>Enzyme</i>	<i>Activity</i>	<i>Organ Pathology</i>
Acute intermittent porphyria	Dominant	Liver	1. ALA synthase	Increase	Nervous system
			2. Porphobilinogen deaminase	Decrease	
			3. $4\text{-}5\alpha\text{-Reductase}$	Decrease	
Hereditary coproporphyria	Dominant	Liver	1. ALA synthase	Increase	Nervous system; skin
			2. Coproporphyrinogen oxidase	Decrease	
Variegate porphyria	Dominant	Liver	1. ALA synthase	Increase	Nervous system; skin
			2. Protoporphyrinogen oxidase	Decrease	
Porphyria cutanea tarda	Dominant	Liver	1. Uroporphyrinogen decarboxylase	Decrease	Skin, induced by liver disease
Hereditary protoporphyria	Dominant	Marrow	1. Ferrochelatase	Decrease	Gallstones, liver disease, skin
Erythropoietic porphyria	Recessive	Marrow	1. Uroporphyrinogen III cosynthase	Decrease	Skin and appendages; reticuloendothelial system
Lead poisoning	None	All tissues	1. ALA dehydrase	Decrease	Nervous system; blood; others
			2. Ferrochelatase	Decrease	

CLINICAL CORRELATION 24.7**Acute Intermittent Porphyria**

A 40-year-old woman appears in the emergency room in an agitated state, weeping and complaining of severe abdominal pain. She has been constipated for several days and has noted marked weakness in the arms and legs and that "things do not appear to be quite right." Physical examination reveals a slightly rapid heart rate (100/min) and moderate hypertension (blood pressure of 160/110 mmHg). There have been earlier episodes of severe abdominal pain; operations undertaken on two occasions revealed no abnormalities. The usual laboratory tests are normal. The neurological complaints are not localized to an anatomical focus. The decision is made that the present symptoms are largely psychiatric in origin and have a functional rather than an organic basis. The patient is sedated with 60 mg of phenobarbital; a consultant psychiatrist agrees by telephone to see the patient in about 4 h. The staff notices a marked deterioration; generalized weakness rapidly appears, progressing to a compromise of respiratory function. This ominous development leads to immediate incorporation of a ventilatory assistance regimen, with transfer to intensive care for physiological monitoring. Her condition deteriorates and she dies 48 h later. A urine sample of the patient is reported later to have a markedly elevated level of porphobilinogen. This patient had acute intermittent porphyria, a disease of incompletely understood derangement of heme biosynthesis. There is a dominant pattern of inheritance associated with an overproduction of the porphyrin precursors, ALA and porphobilinogen. Three enzyme abnormalities are noted in the cases that have been studied carefully. These include (1) a marked increase in ALA synthase, (2) a reduction by one-half of activity of porphobilinogen deaminase, and (3) a reduction of one-half of the activity of steroid 4 -5 α -reductase. The change in content of the second enzyme is consonant with a dominant expression. The change in content of the third enzyme is acquired and not apparently a heritable expression of the disease. It is believed that a decrease in porphobilinogen deaminase leads to a minor decrease in content of heme in liver. The lower concentration of heme leads to a failure both to repress the synthesis and to inhibit the activity of ALA synthase. Almost never manifested before puberty, the disease is thought to appear only with the induction of 4 -5 β -reductase at adolescence. Without a sufficient amount of 4 -5 α -reductase, the observed increase in the 5 β steroids is due to a shunting of 4 steroids into the 5 β -reductase pathway. The importance of abnormalities of this last metabolic pathway in the pathogenesis of porphyria is controversial. Pathophysiologically, the disease poses a great riddle: the derangement of porphyrin metabolism is confined to the liver, which anatomically appears normal, whereas the pathological findings are restricted to the nervous system. In the present case, involvement of (1) the brain led to the agitated and confused state and the respiratory collapse, (2) the autonomic system led to the hypertension, increased heart rate, constipation, and abdominal pain, and (3) the peripheral nervous system and spinal cord led to the weakness and sensory disturbances. Experimentally, no known metabolic intermediate of heme biosynthesis can cause the pathology noted in acute intermittent porphyria. There should have been a greater suspicion of the possibility of porphyria early in the patient's presentation. The analysis of porphobilinogen in the urine is a relatively simple test. The treatment would have been glucose infusion, the exclusion of any drugs that could cause elevation of ALA synthase (e.g., barbiturates), and, if her disease failed to respond satisfactorily despite these measures, the administration of intravenous hematin to inhibit the synthesis and activity of ALA synthase. Acute hepatic porphyria is of historic political interest. The disease has been diagnosed in two descendants of King George III, suggesting that the latter's deranged personality preceding and during the American Revolution could possibly be ascribed to porphyria.

Meyer, U. A., Strand, L. J., Doss, M., et al. Intermittent acute porphyria: demonstration of a genetic defect in porphobilinogen metabolism. *N. Engl. J. Med.* 286:1277, 1972; and Stein, J. A., and Tschudy, D. D. Acute intermittent porphyria: a clinical and biochemical study of 46 patients. *Medicine (Baltimore)* 49:1, 1970.

ALA condense asymmetrically to form **porphobilinogen**. The ALA dehydratase is a sulfhydryl enzyme and is very sensitive to inhibition by heavy metals. A characteristic finding of **lead poisoning** is the elevation of ALA in the absence of an elevation of porphobilinogen.

Porphobilinogen Deaminase

Synthesis of the porphyrin ring is a complicated process. A sulfhydryl group on porphobilinogen deaminase forms a thioether bond with a porphobilinogen residue through a deamination reaction. Thereafter, five additional porphobilinogen residues are deaminated successively to form a linear hexapyrrole adduct with the enzyme. The adduct is cleaved hydrolytically to form both an enzyme–dipyrromethane complex and the linear tetrapyrrole, hydroxymethylbilane. The enzyme–dipyrromethane complex is then ready for another cycle of addition of four porphobilinogen residues to generate another tetrapyrrole. Thus dipyrromethane is the covalently attached novel cofactor for the enzyme. Porphobilinogen deaminase has no ring-closing function; hydroxymethylbilane closes in an enzyme-independent step to form uroporphyrinogen I if no additional factors are present. However, the deaminase is closely associated with a second protein,

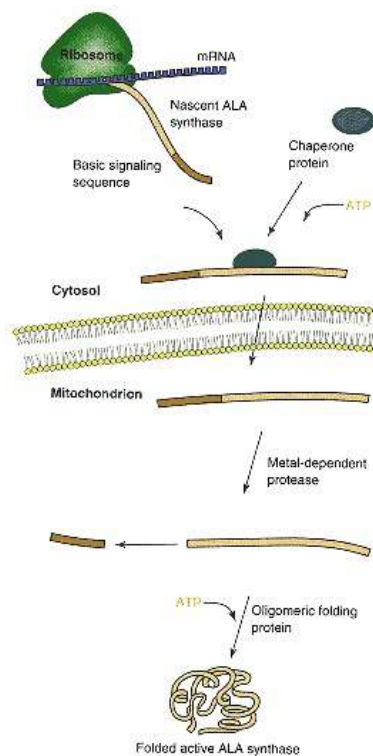

Figure 24.9
Synthesis of δ -aminolevulinic acid synthase.

uroporphyrinogen III cosynthase, which directs the synthesis of the III isomer. The formation of the latter involves a spiro intermediate generated from hydroxymethylbilane; this allows inversion of one of the pyrrole groups (Figure 24.11, p. 1016). In the absence of the cosynthase, uroporphyrinogen I is synthesized slowly; in its presence, the III isomer is synthesized rapidly. A rare recessively inherited disease, **erythropoietic porphyria**, associated with marked cutaneous light sensitization, is due to an abnormality of red blood cell cosynthase. Here, large amounts of the type I isomers of uroporphyrinogen and coproporphyrinogen are synthesized in the bone marrow. Two isoenzymes exist for porphobilinogen deaminase due to alternative splicing of exon 1 or exon 2 to the rest of the mRNA.

Uroporphyrinogen Decarboxylase

This enzyme acts on the side chains of the uroporphyrinogens to form the coproporphyrinogens. The protein catalyzes the conversion of both I and III isomers of uroporphyrinogen to the respective coproporphyrinogen isomers. Uroporphyrinogen decarboxylase is inhibited by iron salts. Clinically, the most common cause of porphyrin derangement is associated with patients who have a single gene abnormality for this enzyme, leading to 50% depression of the enzyme's activity. This disease, which shows cutaneous manifestations primarily with sensitivity to light, is known as **porphyria cutanea tarda**. The condition

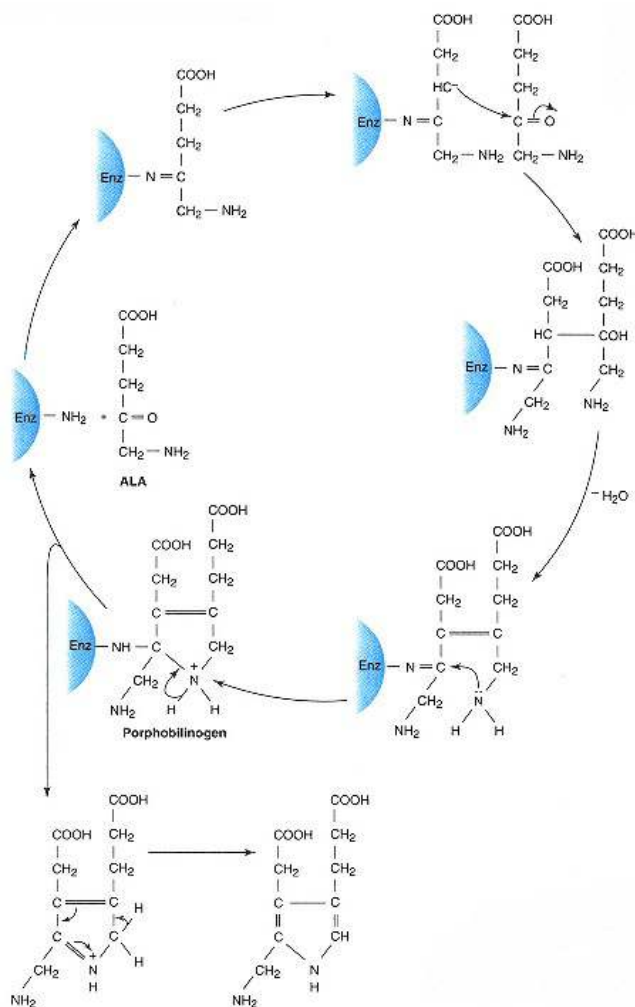

Figure 24.10
Synthesis of porphobilinogen.

is not expressed unless patients either take drugs that cause an increase in porphyrin synthesis or drink large amounts of alcohol, leading to the accumulation of iron, which then acts to inhibit further the activity of uroporphyrinogen decarboxylase.

Coproporphyrinogen Oxidase

This mitochondrial enzyme is specific for the type III isomer of coproporphyrinogen, not acting on the type I isomer. Coproporphyrinogen III enters the mitochondrion and is converted to protoporphyrinogen IX. The mechanism of action is not understood. A dominant disease associated with a deficiency of this

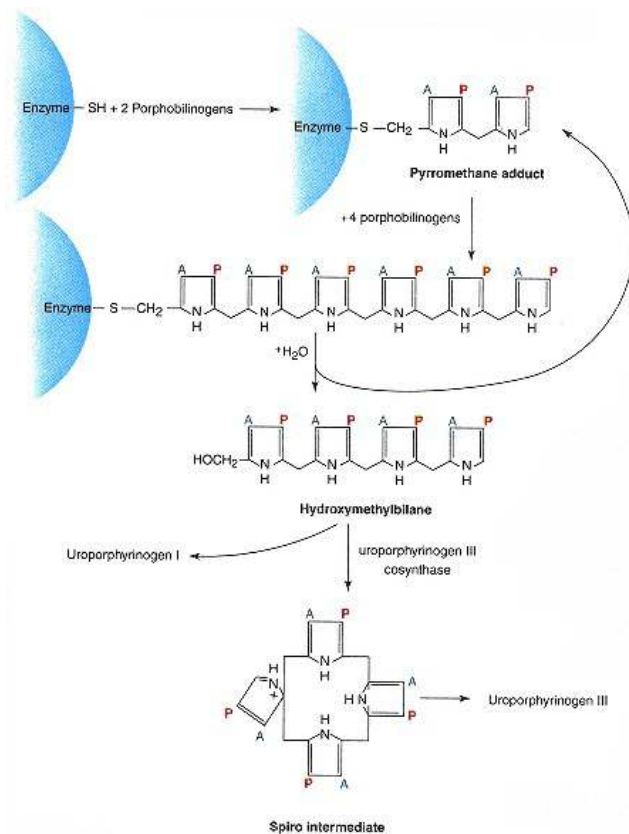

Figure 24.11
Synthesis of uroporphyrinogens I and III.
 Enzyme in blue is uroporphyrinogen I synthase.

enzyme leads to a form of hereditary hepatic porphyria, known as **hereditary coproporphyria**.

Protoporphyrinogen Oxidase

This mitochondrial enzyme generates a product, protoporphyrin IX, which, in contrast to the other heme precursors, is very water-insoluble. Excess amounts of protoporphyrin IX that are not converted to heme are excreted by the biliary system into the intestinal tract. A dominant disease, **variegate porphyria**, is due to a deficiency of protoporphyrinogen oxidase.

Ferrochelatase

Ferrochelatase inserts ferrous iron into protoporphyrin IX in the final step of the synthesis of heme. The protein is sensitive to the effects of heavy metals (especially lead) and, of course, to iron deprivation. In these latter instances, zinc instead of iron is incorporated to form a zinc–protoporphyrin IX complex. In contrast to heme, the zinc–protoporphyrin IX complex is brilliantly fluorescent and easily detectable in small amounts. The enzyme contains an Fe_2S_2 group and has been proposed as an IRP-3 that controls translation of the erythrocytic ALA synthase mRNA.

ALA Synthase Catalyzes Rate-Limiting Step of Heme Biosynthesis

ALA synthase controls the rate-limiting step of heme synthesis in all tissues. Succinyl CoA and glycine are substrates for a variety of reactions. The modulation of the activity of ALA synthase determines the quantity of the substrates that will be shunted into heme biosynthesis. Heme (and also hematin) acts both as a repressor of the synthesis of ALA synthase and as an inhibitor of its activity. Since heme resembles neither the substrates nor the product of the enzyme's action, it is probable that the latter inhibition occurs at an allosteric site. Almost 100 different drugs and metabolites can cause induction of ALA synthase; for example, a 40-fold increase is noted in the rat after treatment with 3,5-dicarboxy-1,4-dihydrocollidine. The effect of pharmacological agents has led to the important clinical feature where some patients with certain kinds of porphyria have had exacerbations of their condition following the inappropriate administration of certain drugs (e.g., barbiturates). ALA dehydratase is also inhibited by heme; but this is of little physiological consequence, since the activity of ALA dehydrase is about 80-fold greater than that of ALA synthase, and thus heme-inhibitory effects are reflected first in the activity of ALA synthase.

Glucose or a proximal metabolite serves to inhibit heme biosynthesis in a mechanism that is not yet defined. This is of clinical relevance, since some patients manifest their porphyric state for the first time when placed on a very low caloric (and therefore glucose) intake. Other regulators of porphyrin metabolism include certain steroids. Steroid hormones (e.g., oral contraceptive pills) with a double bond in ring A between C-4 and C-5 atoms can be reduced by two different reductases. The product of 5α -reduction has little effect on heme biosynthesis; however, the product of 5α -reduction serves as a stimulus for the synthesis of ALA synthase.

24.7—

Heme Catabolism

Catabolism of heme-containing proteins presents two requirements to the mammalian host: (1) development of a means of processing the hydrophobic products of porphyrin ring cleavage and (2) retention and mobilization of the contained iron so that it may be reutilized. Red blood cells have a life span of approximately 120 days. Senescent cells are recognized by their membrane changes and removed and engulfed by the reticuloendothelial system at extravascular sites. The globin chains denature, releasing heme into the cytoplasm. The globin is degraded to its constituent amino acids, which are reutilized for general metabolic needs.

Figure 24.12 depicts the events of heme catabolism. Heme is degraded primarily by a microsomal enzyme system in reticuloendothelial cells that requires molecular oxygen and NADPH. **Heme oxygenase** is substrate inducible and catalyzes the cleavage of the α -methene bridge, which joins the two pyrrole residues containing the vinyl substituents. The α -methene carbon is converted quantitatively to carbon monoxide. The only endogenous source of **carbon monoxide** in humans is the α -methene carbon. A fraction of the carbon monoxide is released via the respiratory tract. Thus the measurement of carbon monoxide in an exhaled breath provides an index to the quantity of heme that is degraded in an individual. The oxygen present in the carbon monoxide and in the newly derivatized lactam rings are generated entirely from molecular oxygen. The stoichiometry of the reaction requires 3 mol of oxygen for each ring cleavage. Heme oxygenase will only use heme as a substrate, with the iron possibly participating in the cleavage mechanism. Thus free protoporphyrin IX is not a substrate. The linear tetrapyrrole **biliverdin IX** is the product formed by the action of heme oxygenase. Biliverdin IX is reduced by **biliverdin reductase** to bilirubin IX.

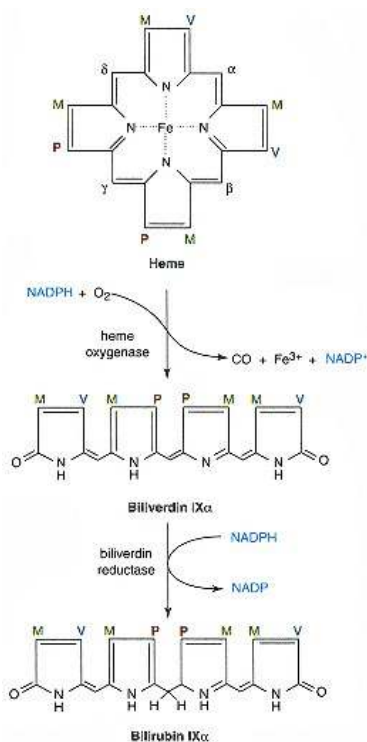

Figure 24.12
Formation of bilirubin from heme.
 Greek letters indicate the labeling of the methene carbon atoms in heme.

Bilirubin Is Conjugated to Form Bilirubin Diglucuronide in Liver

Bilirubin is derived not only from senescent red cells but also from the turnover of other heme-containing proteins, such as the cytochromes. Studies with labeled glycine as a precursor have revealed that an early-labeled bilirubin, with a peak within 1–3 h, appears a very short time after a pulsed administration of the labeled precursor. A larger amount of bilirubin appears much later at about 120 days, reflecting the turnover of heme in red blood cells. Early-labeled bilirubin can be divided into two parts: an early–early part, which reflects the turnover of heme proteins in the liver, and a late–early part, which consists of both the turnover of heme-containing hepatic proteins and the turnover of bone marrow heme, which is either poorly incorporated or easily released from red blood cells. The latter is a measurement of ineffective erythropoiesis and can be very pronounced in disease states such as pernicious anemia (see Chapter 28) and the thalassemias.

Bilirubin is poorly soluble in aqueous solutions at physiological pH values. When transported in plasma, it is bound to serum albumin with an association constant greater than 10^6 M^{-1} . Albumin contains one such high-affinity site and another with a lesser affinity. At the normal albumin concentration of 4 g dL^{-1} , about 70 mg of bilirubin per deciliter of plasma can be bound on the two sites. However, bilirubin toxicity (**kernicterus**), which is manifested by the transfer of bilirubin to membrane lipids, commonly occurs at concentrations greater than 25 mg dL^{-1} . This suggests that the weak affinity of the second site does not allow it to serve effectively in the transport of bilirubin. Bilirubin on serum albumin is rapidly cleared by the liver, where there is a free bidirectional flux of the tetrapyrrole across the sinusoidal–hepatocyte interface. Once in the hepatocyte, bilirubin is bound to several cytosolic proteins, of which only one has been well characterized. The latter component, **ligandin**, is a small basic component making up to 6% of the total cytosolic protein of rat liver. Ligandin has been purified to homogeneity from rat liver and characterized as having two subunits with molecular masses of 22 kDa and 27 kDa. Each subunit contains glutathione *S*-epoxidtransferase activity, a function important in detoxification mechanisms of aryl groups. The stoichiometry of binding is one bilirubin molecule per complete ligandin molecule. The functional role of ligandin and other hepatic bilirubin-binding proteins remains to be defined.

Once in the hepatocyte the propionyl side chains of bilirubin are conjugated to form a diglucuronide (Figure 24.13). The reaction utilizes uridine diphosphoglucuronate derived from the oxidation of uridine diphosphoglucose. The former serves as a glucuronate donor to bilirubin. In normal bile, the diglucuronide is the major form of excreted bilirubin, with only small amounts of the monoglucuronide or other glycosidic adducts present. **Bilirubin diglucuronide** is much more water-soluble than free bilirubin, and thus the transferase facilitates excretion of the bilirubin into bile. Bilirubin diglucuronide is poorly absorbed by the intestinal mucosa. The glucuronide residues are released in the terminal ileum and large intestine by bacterial hydrolases; the released free bilirubin is reduced to the colorless linear tetrapyrroles known as **urobilinogens**. Urobilinogens can be oxidized to colored products known as **urobilins**, which are excreted in the feces. A small fraction of urobilinogen can be reabsorbed by the terminal ileum and large intestine to be removed by hepatic cells and resecreted in bile. When urobilinogen is reabsorbed in large amounts in certain disease states, the kidney serves as a major excretory site.

In the normal state, plasma bilirubin concentrations are $0.3\text{--}1 \text{ mg dL}^{-1}$, and this is almost all in the unconjugated state. In the clinical setting, conjugated bilirubin is expressed as **direct bilirubin** because it can be coupled readily with diazonium salts to yield azo dyes; this is the direct **van den Bergh reaction**. Unconjugated bilirubin is bound noncovalently to albumin and will not react until it is released by the addition of an organic solvent such as

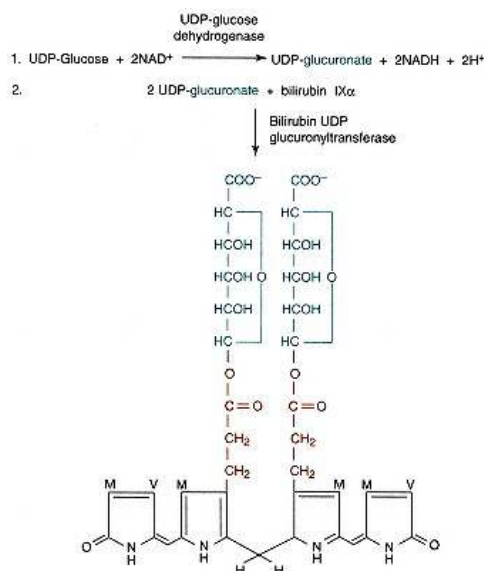

Figure 24.13
Biosynthesis of bilirubin diglucuronide.

ethanol. The reaction with diazonium salts yielding the azo dye after the addition of ethanol is the indirect van den Bergh reaction, and this measures the **indirect bilirubin** or the unconjugated bilirubin. Unconjugated bilirubin binds so tightly to serum albumin and lipid that it does not diffuse freely in plasma and therefore does not lead to an elevation of bilirubin in the urine. Unconjugated bilirubin has a high affinity for membrane lipids, which leads to the impairment of cell membrane function, especially in the nervous system. In contrast, conjugated bilirubin is relatively water-soluble, and elevations of this bilirubin form lead to high urinary concentrations with the characteristic deep yellow-brown color. The deposition of conjugated and unconjugated bilirubin in skin and the sclera gives the yellow to yellow-green color seen in patients with jaundice.

A third form of plasma bilirubin occurs only with hepatocellular disease in which a fraction of the bilirubin binds so tightly that it is not released from serum albumin by the usual techniques and is linked covalently to the protein. In some cases up to 90% of total bilirubin can be in this covalently bound form.

The normal liver has a very large capacity to conjugate and mobilize the bilirubin that is delivered. As a consequence, **hyperbilirubinemia** due to excess heme destruction, as in hemolytic diseases, rarely leads to bilirubin levels that exceed 5 mg dL^{-1} , except in situations in which functional derangement of the liver is present (see Clin. Corr. 24.8). Thus marked elevation of unconjugated bilirubin reflects primarily a variety of hepatic diseases, including those that are heritable and those that are acquired (see Clin. Corr. 24.9).

Elevations of conjugated bilirubin level in plasma are attributable to liver and/or biliary tract disease. In simple uncomplicated biliary tract obstruction, the major component of the elevated serum bilirubin is the diglucuronide form, which is released by the liver into the vascular compartment. Biliary tract disease may be extrahepatic or intrahepatic, the latter involving the canaliculi and biliary ductules (see Clin. Corr. 24.10).

CLINICAL CORRELATION 24.8**Neonatal Isoimmune Hemolysis**

Rh-negative women pregnant with Rh-positive fetuses will develop antibodies to Rh factors. These antibodies will cross the placenta to hemolyze fetal red blood cells. Usually this is not of clinical relevance until about the third Rh-positive pregnancy, in which the mother has had antigenic challenges with earlier babies. Antenatal studies will reveal rising maternal levels of IgG antibodies against Rh-positive red blood cells, indicating that the fetus is Rh-positive. Before birth, placental transfer of fetal bilirubin occurs with excretion through the maternal liver. Because hepatic enzymes of bilirubin metabolism are poorly expressed in the newborn, infants may not be able to excrete the large amounts of bilirubin that can be generated from red cell breakdown. At birth these infants usually appear normal; however, the unconjugated bilirubin in the umbilical cord blood is elevated up to 4 mg dL^{-1} ; due to the hemolysis initiated by maternal antibodies. During the next 2 days the serum bilirubin rises, reflecting continuing isoimmune hemolysis, leading to jaundice, hepatosplenomegaly, ascites, and edema. If untreated, signs of central nervous system damage can occur, with the appearance of lethargy, hypotonia, spasticity, and respiratory difficulty, constituting the syndrome of kernicterus. Treatment involves exchange transfusion with whole blood, which is serologically compatible with both the infant's blood and maternal serum. The latter requirement is necessary to prevent hemolysis of the transfused cells. Additional treatment includes external phototherapy, which facilitates the breakdown of bilirubin. The entire problem can be prevented by treating Rh-negative mothers with anti-Rh globulin. These antibodies recognize the fetal red cells, block the Rh antigens, and cause them to be destroyed without stimulating an immune response in the mothers.

Mauer, H. M., Shumway, C. N., Draper, D. A., and Hossaini, A. A. Controlled trial comparing agar, intermittent phototherapy, and continuous phototherapy for reducing neonatal hyperbilirubinemia. *J. Pediatr.* 82:73, 1973; and Bowman, J. J. Management of Rh-isoimmunization. *Obstet. Gynecol.* 52:1, 1978.

Intravascular Hemolysis Requires Scavenging of Iron

In certain diseases destruction of red blood cells occurs in the intravascular compartment rather than in the extravascular reticuloendothelial cells. In the former case the appearance of free hemoglobin and heme in the plasma potentially could lead to the excretion of these substances through the kidney with a substantial loss of iron. To prevent this occurrence, specific plasma proteins are involved in scavenging mechanisms. Transferrin binds free iron and thus permits its reutilization. Free hemoglobin, after oxygenation in the pulmonary capillaries, dissociates into α, β dimers, which are bound to a family of circulating

CLINICAL CORRELATION 24.9**Bilirubin UDP-Glucuronosyltransferase Deficiency**

Bilirubin UDP-glucuronosyltransferase has two isoenzyme forms, derived from alternative mRNA splicing between variable forms of exon 1 and common exons 2, 3, 4, and 5. The latter exons define the part of the protein that binds the UDP-glucuronate, whereas the various exons 1 have defined specificities for either bilirubin or other acceptors, such as phenol. Two exons have bilirubin specificity leading to two forms of bilirubin UDP-glucuronosyltransferase forms. Two major families of diseases are seen with deficiencies of the enzyme. Crigler-Najjar syndrome is seen in infants and is associated with extraordinarily high serum unconjugated bilirubin due to an autosomal recessive inheritance of mutations on both alleles in exons 2, 3, 4, or 5. Gilbert's syndrome is also associated with a deficiency of the enzyme's activity, but only to about 25% of normal. The patients appear jaundiced but without other clinical symptoms. The major complication is an exhaustive search by the physician looking for some serious liver disease and failing to recognize the benign condition. Two different findings that may be restricted to different populations account for the condition. In Japan a dominant pattern of inheritance is noted with a mutation on only one allele. The 75% reduction of activity is ascribed to the fact that the enzyme exists as an oligomer, where mutant and normal monomers might associate to form heterooligomers. The explanation is that not only is the mutant monomer inactive, but it forces conformational effects on the normal subunit, reducing its activity substantially. In contrast, in the Western world the condition is due largely to a homozygous expansion of the bases in the promoter region with less efficient transcription of the gene.

Aono, S., Adachi, Y., Uyama, S., et al. Analysis of genes for bilirubin UDP-glucuronosyltransferase in Gilbert's syndrome. *Lancet* 345:958, 1995; and Bosma, P. J., Chowdhury, J. R., Bakker, C., et al. The genetic basis of the reduced expression of bilirubin UDP-glucuronosyltransferase 1 in Gilbert's syndrome. *N. Engl. J. Med.* 333:1171, 1995.

CLINICAL CORRELATION 24.10**Elevation of Serum Conjugated Bilirubin**

Elevations of serum conjugated bilirubin are attributable to liver and/or biliary tract disease. In simple uncomplicated biliary tract obstruction, the major component of the elevated serum bilirubin is the diglucuronide form, which is released by the liver into the vascular compartment. Biliary tract disease may be extrahepatic or intrahepatic, the latter involving the canaliculi and biliary ductules. Dubin–Johnson syndrome is an autosomal recessive disease involving a defect in the biliary secretory mechanisms in liver. Excretion through the biliary tract of a variety of (but not all) organic anions is affected. Retention of melanin-like pigment in the liver in this disorder leads to a characteristic gray-black color of this organ. A second heritable disorder associated with elevated levels of serum conjugated bilirubin is Rotor's syndrome. In this poorly defined disease no hepatic pigmentation occurs.

Kitamura, T., Alroy, J., Gatmaitan, Z., et al. Defective biliary excretion of epinephrine metabolites in mutant (TR-) rats: relation to the pathogenesis of black liver in the Dubin–Johnson syndrome and Corriedale sheep with an analogous excretory defect. *Hepatology* 15:1154, 1992.

plasma proteins, the **haptoglobins**, having a high affinity for the oxyhemoglobin dimer. Since deoxyhemoglobin does not dissociate into dimers in physiological settings, it is not bound by haptoglobin. The stoichiometry of binding is two α,β -oxyhemoglobin dimers per haptoglobin molecule. Interesting studies have been made with rabbit antihuman-hemoglobin antibodies on the haptoglobin–hemoglobin interaction. Human haptoglobin interacts with a variety of hemoglobins from different species. The binding of human haptoglobin with human hemoglobin is not affected by the binding of rabbit antihuman-hemoglobin antibody. These studies suggest that haptoglobin binds to sites on hemoglobin that are highly conserved in evolution and therefore are not sufficiently antigenic to generate antibodies. The most likely site for the molecular interaction of hemoglobin and haptoglobin is the interface of the α and β globins of the tetramer that dissociates to yield α,β dimers. Sequence determinations have indicated that these contact regions are highly conserved in evolution.

The haptoglobins are **α_2 -globulins**. Synthesized in the liver, they consist of two pairs of polypeptide chains (α being the lighter and β the heavier). The genes for the α and β chains are linked so that a single mRNA is synthesized, generating a single polypeptide chain that is cleaved to form the two different chains. The β chains are glycopeptides of 39 kDa and are invariant in structure; α chains are of several kinds. The haptoglobin peptide chains are joined by disulfide bonds between the α and β chains and between the two α chains.

Interaction of haptoglobin with hemoglobin forms a complex that is too large to be filtered through the renal glomerulus. Free hemoglobin (appearing in renal tubules and in urine) will occur during intravascular hemolysis only when the binding capacity of circulating haptoglobin has been exceeded. Haptoglobin delivers hemoglobin to the reticuloendothelial cells. The heme in free hemoglobin is relatively resistant to the action of heme oxygenase, whereas the heme residues in an α,β dimer of hemoglobin bound to haptoglobin are very susceptible.

The measurement of serum haptoglobin is used clinically as an indication of the degree of intravascular hemolysis. Patients who have significant intravascular hemolysis will have little or no levels of haptoglobin because of the removal of haptoglobin–hemoglobin complexes by the reticuloendothelial system. Haptoglobin levels can also be low in severe extravascular hemolysis, in which the large load of hemoglobin in the reticuloendothelial system leads to the transfer of free hemoglobin into plasma.

Free heme and heme appearing in plasma are bound by a β -globulin, **hemopexin** (57 kDa). One heme residue binds per hemopexin molecule. Hemopexin transfers heme to liver, where further metabolism by heme oxygenase occurs. Normal plasma hemopexin contains very little bound heme, whereas in intravascular hemolysis, the hemopexin is almost completely saturated by heme and is cleared with a half-life of about 7 h. In the latter instance, excess heme binds to albumin, with newly synthesized hemopexin serving as a mediator for the transfer of the heme from albumin to the liver. Hemopexin also binds free protoporphyrin.

Bibliography

Battersby, A. R. The Bakerian Lecture, 1984. Biosynthesis of the pigments of life. *Proc. R. Soc. Lond. B Biol. Sci.* 225:1, 1985.

Bothwell, T. H., Charlton, R. W., and Motulsky, A. G. Hemochromatosis. In: C. R. Scriver, A. L. Beaudet, W. S. Sly, and D. Valle (Eds.), *The Metabolic and Molecular Bases of Inherited Disease*, 7th ed., Vol. II. New York: McGraw-Hill, 1995, p. 2237.

Braig, K., Otwinowski, Z., Hegde, R., Boisvert, D. C., Joachimiak, A., Horwich, A. L., and Sigler, P. B. The crystal structure of the bacterial chaperonin GroEL at 2.8 Å. *Nature* 371:578, 1994.

Casey, J. L., Hentze, M. W., Koeller, D. H., Caughman, S., Rouault, T. A., Klausner, R. D., and Harford, J. B. Iron-responsive elements: regulatory RNA sequences that control mRNA levels and translation. *Science* 240:924, 1988.

Chowdhury, J. R., Wolkoff, A. W., Chowdhury, N. R., and Arias, I. M. Hereditary jaundice and disorders of bilirubin metabolism. In: C. R. Scriver, A. L. Beaudet, W. S. Sly, and D. Valle (Eds.), *The Metabolic and Molecular Bases of Inherited Disease*, 7th ed., Vol. II. New York: McGraw-Hill, 1995, p. 2161.

- Fenton, W. A., Kashi, Y., Furtak, K., and Horwich, A. L. Residues in chaperonin GroEL required for polypeptide binding and release. *Nature* 371:614, 1994.
- Ferreira, G. C. Ferrochelatase binds the iron-responsive element present in the erythroid 5-aminolevulinic synthase mRNA. *Biochem. Biophys. Res. Commun.* 214:875, 1995.
- Fleet, J. C. A new role for lactoferrin: DNA binding and transcription activation. *Nutr. Rev.* 53:226, 1995.
- Guo, B., Phillips, J.D., Yu, Y., and Leibold, E.A. Iron regulates the intracellular degradation of iron regulatory protein 2 by the proteasome. *J. Biol. Chem.* 270:21645, 1995.
- Hartl, F. U. Molecular chaperones in cellular protein folding. *Nature* 381:571, 1996.
- Huebers, H. A., and Finch, C. A. Transferrin: physiologic behavior and clinical implications. *Blood* 64:763, 1984.
- Kappas, A., Sassa, S., Galbraith, R. A., and Nordmann, Y. The porphyrias. In: C. R. Scriver, A. L. Beaudet, W. S. Sly, and D. Valle (Eds.), *The Metabolic and Molecular Bases of Inherited Disease*, 7th ed., Vol. II. New York: McGraw-Hill, 1995, p. 2103.
- Lustbader, J. W., Arcoletto, J. P., Birken, S., and Greer, J. Hemoglobin-binding site on haptoglobin probed by selective proteolysis. *J. Biol. Chem.* 258:1227, 1983.
- Maeda, N., Yang, F., Barnett, D. R., Bowman, B. H., and Smithies, O. Duplication within the haptoglobin *Hp2* gene. *Nature* 309:131, 1984.
- Mascotti, D. P., Rup, D., and Thach, R. E. Regulation of iron metabolism: translational effects mediated by iron, heme, and cytokines. *Annu. Rev. Nutr.* 15:239, 1995.
- May, W. S., Sahyoun, N., Jacobs, S., Wolf, M., and Cuatrecasas, P. Mechanism of phorbol-diester-induced regulation of surface transferrin receptor involves the action of activated protein kinase C and an intact cytoskeleton. *J. Biol. Chem.* 260:9419, 1985.
- Melefors, O., and Hentze, M. W. Iron regulatory factor—the conductor of cellular iron regulation. *Blood Rev.* 7:251, 1993.
- Osterman, J., Horwich, A. L., Neupert, W., and Hartl, F.-U. Protein folding in mitochondria requires complex formation with hsp60 and ATP hydrolysis. *Nature* 341:125, 1989.
- Pantopoulos, K., Gray, N. K., and Hentze, M. W. Differential regulation of two related RNA-binding proteins, iron regulatory protein (IRP) and IRP_B. *RNA* 1:155, 1995.
- Pantopoulos, K., and Hentze, M. W. Nitric oxide signalling to iron-regulatory protein: direct control of ferritin mRNA translation and transferrin receptor mRNA stability in transfected fibroblasts. *Proc. Natl. Acad. Sci. USA* 92:1267, 1995.
- Weiss, J. S., Gautam, A., Lauff, J. J., et al. The clinical importance of a protein-bound fraction of serum bilirubin in patients with hyperbilirubinemia. *N. Engl. J. Med.* 309:147, 1983.
- Yamashiro, D. J., Tycko, B., Fluss, S. R., and Maxfield, F. R. Segregation of transferrin to a mildly acidic (pH 6.5) para-golgi compartment in the recycling pathway. *Cell* 37:789, 1984.

Questions

C. N. Angstadt and J. Baggott

Refer to the following for Questions 1–3:

- A. ferritin
- B. ferredoxin
- C. hemosiderin
- D. lactoferrin
- E. transferrin

1. A type of protein in which iron is specifically bound to sulfur.
2. Exhibits an antimicrobial effect in the intestinal tract of newborns because of its ability to bind iron.
3. Delivers iron to tissues by binding to specific cell surface receptors.
4. In the intestinal absorption of iron:
 - A. the presence of a reductant like ascorbate enhances the availability of iron.
 - B. regulation of uptake occurs between the lumen and mucosal cells.
 - C. the amount of apoferritin synthesized in the mucosal cell is directly related to the need for iron by the host.
 - D. iron bound tightly to a ligand, such as phytate, is more readily absorbed than free iron.
 - E. low pH in the stomach inhibits absorption by favoring Fe³⁺.
5. Which of the following statements about iron distribution is correct?
 - A. Iron overload cannot occur because very efficient excretory mechanisms are available.
 - B. Cells cannot regulate their uptake of iron with changing iron content.
 - C. Transferrin decreases in iron deficiency to facilitate storage of iron.
 - D. Iron homeostasis is maintained in part by iron regulatory proteins binding to iron-responsive elements in mRNA.
 - E. In the early stages of iron depletion, serum ferritin levels rise rapidly as iron is released from storage forms.
6. The biosynthesis of heme requires all of the following EXCEPT:
 - A. propionic acid.
 - B. succinyl CoA.
 - C. glycine.
 - D. ferrous ion.
7. Uroporphyrin III:
 - A. is an intermediate in the biosynthesis of heme.
 - B. does not contain a tetrapyrrole ring.
 - C. differs from coproporphyrin III in the substituents around the ring.
 - D. is formed from uroporphyrinogen III by an oxidase.
 - E. formation is the primary control step in heme synthesis.
8. Aminolevulinic acid synthase:
 - A. requires NAD for activity.
 - B. is allosterically activated by heme.
 - C. synthesis is inhibited by steroids.
 - D. is synthesized in mitochondria.
 - E. synthesis can be induced by a variety of drugs.
9. Lead poisoning would be expected to result in an elevated level of:
 - A. aminolevulinic acid.
 - B. porphobilinogen.
 - C. protoporphyrin I.
 - D. heme.
 - E. bilirubin.

10. Ferrochelatase:
- A. is an iron-chelating compound.
 - B. releases iron from heme in the degradation of hemoglobin.
 - C. binds iron to sulfide ions and cysteine residues.
 - D. is inhibited by heavy metals.
 - E. is involved in the cytoplasmic portion of heme synthesis.
11. Heme oxygenase:
- A. can oxidize the methene bridge between any two pyrrole rings of heme.
 - B. requires molecular oxygen.
 - C. produces bilirubin.
 - D. produces carbon dioxide.
 - E. can use either heme or protoporphyrin IX as substrate.
12. The substance deposited in skin and sclera in jaundice is:
- A. biliverdin.
 - B. only unconjugated bilirubin.
 - C. only direct bilirubin.
 - D. both bilirubin and bilirubin diglucuronide.
 - E. hematin.
13. Hepatic disease leads to major elevation of the blood level of:
- A. heme.
 - B. biliverdin.
 - C. bilirubin.
 - D. bilirubin diglucuronide.
 - E. direct bilirubin.
14. Biliary obstruction leads to major elevation of the blood level of:
- A. only direct bilirubin.
 - B. only indirect bilirubin.
 - C. both direct and indirect bilirubin.
 - D. heme but not bilirubin.
 - E. biliverdin but not bilirubin.
15. Acute intermittent porphyria is accompanied by an increased urinary level of:
- A. biliverdin.
 - B. direct bilirubin.
 - C. heme.
 - D. indirect bilirubin.
 - E. porphobilinogen.
16. Haptoglobin binds:
- A. a globin monomer.
 - B. an oxyhemoglobin molecule.
 - C. α,β -oxyhemoglobin dimers.
 - D. a deoxyhemoglobin molecule.
 - E. α,β -deoxyhemoglobin dimers.
17. Haptoglobin:
- A. helps prevent loss of iron following intravascular red blood cell destruction.
 - B. levels in serum are elevated in severe intravascular hemolysis.
 - C. inhibits the action of heme oxygenase.
 - D. binds heme and hematin as well as hemoglobin.
 - E. is a β -globulin.

Answers

1. B Animal ferredoxins, also known as nonheme iron-containing proteins, have two irons bound to two cysteine residues and sharing two sulfide ions (p. 1004).
2. D As long as lactoferrin is not saturated, its avid binding of iron diminishes the amount available for growth of microorganisms (p. 1003).
3. E Internalization of the receptor–transferrin complex is mediated by a Ca^{2+} –calmodulin–protein kinase C complex. Internalization is followed by release of the iron and recycling of the apotransferrin to the plasma (p. 1003). Ferritin and hemosiderin (p. 1004) are storage forms of iron.
4. A A and D: Ascorbate facilitates reduction to the ferrous state and, therefore, dissociation from ligands and absorption. B: Substantial iron enters the mucosal cell regardless of need, but the amount transferred to the capillary beds is controlled. C: Iron bound to apoferritin is trapped in mucosal cells and not transferred to the host. E: Oxidation to Fe^{3+} is favored by higher pH (p. 1005).
5. D B and D: In the presence of low iron this mechanism leads to increased synthesis of transferrin receptor and decreased synthesis of apoferritin. A: The high affinity of many macromolecules for iron prevents efficient excretion. C: Transferrin increases in iron deficiency to improve absorption. E: Serum ferritin is normally small and decreases (pp. 1007–1008).
6. A B and C: The organic portion of heme comes totally from glycine and succinyl CoA; the propionic acid side chain comes from the succinate. D: The final step of heme synthesis is the insertion of the ferrous ion (p. 1010, Figure 24.7).
7. C A, B, and D: The tetrapyrrole porphyrins (except for protoporphyrin IX) are not intermediates but end products formed from the porphyrinogens nonenzymatically. E: Synthesis of aminolevulinic acid is the rate-limiting step (p. 1010, Figure 24.7).
8. E The enzyme is induced in response to need (many drug detoxifications are cytochrome P450-dependent). A: The mechanism involves a Schiff base with glycine. B: Heme both allosterically inhibits and suppresses synthesis of the enzyme. C: One reduction product of catabolic steroids stimulates synthesis. D: The gene for this enzyme is on nuclear DNA (pp. 1009–1012).
9. A A–D: Lead inhibits ALA dehydratase so it inhibits synthesis of porphobilinogen and subsequent compounds. Heme certainly would not be elevated, because lead also inhibits ferrochelatase. E: Bilirubin is a breakdown product of heme, not an intermediate in synthesis (p. 1013).
10. D This enzyme, in the mitochondria, catalyzes the last step of heme synthesis, the insertion of Fe^{2+} , and is sensitive to the effects of heavy metals (p. 1016).
11. B Oxygenases usually use O_2 . A: The enzyme is specific for the methene between the two rings containing the vinyl groups (α -methene bridge). C and D: The products are biliverdin and CO; the measurement of CO in the breath is an index of heme degradation. E: Iron is necessary for activity (p. 1017).
12. D Both conjugated (direct) and unconjugated (indirect) bilirubin are deposited (p. 1019).

13. C Since the liver is responsible for conjugating bilirubin, hepatic disease leads to the elevation of unconjugated (indirect) bilirubin in blood. A and B: Catabolism of heme to bilirubin occurs in reticuloendothelial cells. D and E: These are the same and require conjugation by the liver (p. 1019).
14. A Conjugated (direct) bilirubin is excreted in the bile. B and C: As long as the liver is functioning, bilirubin (indirect) will be conjugated. D and E: These occur in the reticuloendothelial cells so bilirubin will be formed (pp. 1020–1021).
15. E The disease is characterized by increased ALA synthase and decreased porphobilinogen deaminase activities. A, B, and E: These all represent heme catabolism. D: Heme synthesis is reduced (p. 1013).
16. C Haptoglobin binds dimers, two per haptoglobin molecule, specifically the oxyhemoglobin dimers since deoxyhemoglobin does not dissociate to dimers physiologically (p. 1021).
17. A Haptoglobin is part of the scavenging mechanism to prevent urinary loss of heme and hemoglobin from intravascular degradation of red blood cells. B: Since the scavenged complex is taken up by the reticuloendothelial system, the haptoglobin levels in serum are low. C: Heme residues in the dimers bound to haptoglobin are more susceptible than free heme to oxidation by heme oxygenase. D and E: Heme and hemein are bound by a β -globulin, while haptoglobin is an α -globulin (p. 1021).

Chapter 25— Gas Transport and pH Regulation

James Baggott

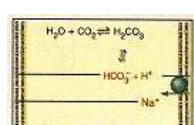

25.1 Introduction to Gas Transport	1026
25.2 Need for a Carrier of Oxygen in Blood	1026
Respiratory System Anatomy Affects Blood Gas Concentration	1027
A Physiological Oxygen Carrier Must Have Unusual Properties	1027
The Steep Part of the Curve Lies in the Physiological Range	1028
25.3 Hemoglobin and Allosterism: Effect of 2,3-Bisphosphoglycerate	1029
25.4 Other Hemoglobins	1030
25.5 Physical Factors That Affect Oxygen Binding	1031
High Temperature Weakens Hemoglobin's Oxygen Affinity	1031
Low pH Weakens Hemoglobin's Oxygen Affinity	1031
25.6 Carbon Dioxide Transport	1031
Blood CO_2 Is Present in Three Major Forms	1031
Bicarbonate Formation	1032
Carbaminohemoglobin Formation	1032
Two Processes Regulate $[H^+]$ Derived from CO_2 Transport	1033
Buffering	1033
Isohydric Mechanism	1034
HCO_3^- Distribution between Plasma and Erythrocytes	1035
25.7 Interrelationships among Hemoglobin, Oxygen, Carbon Dioxide, Hydrogen Ion, and 2,3-Bisphosphoglycerate	1036
25.8 Introduction to pH Regulation	1036
25.9 Buffer Systems of Plasma, Interstitial Fluid, and Cells	1036
25.10 The Carbon Dioxide–Bicarbonate Buffer System	1038
The Chemistry of the System	1038
The Equilibrium Expression Involves an Anhydride Instead of an Acid	1038
The Carbon Dioxide–Bicarbonate Buffer System is an Open System	1039
Graphical Representation: The pH–Bicarbonate Diagram	1040
25.11 Acid–Base Balance and Its Maintenance	1041
The Kidney Plays a Critical Role in Acid–Base Balance	1043
Urine Formation Occurs Primarily in the Nephron	1043
The Three Fates of Excreted H^+	1043
Total Acidity of the Urine	1045
25.12 Compensatory Mechanisms	1046
Principles of Compensation	1046
The Three States of Compensation Defined	1046
Specific Compensatory Processes	1047
Respiratory Acidosis	1047
Respiratory Alkalosis	1047
Metabolic Acidosis	1048
Metabolic Alkalosis	1048
25.13 Alternative Measures of Acid–Base Imbalance	1049
25.14 The Significance of Na^+ and Cl^- in Acid–Base Imbalance	1050
Bibliography	1052
Questions and Answers	1052
Clinical Correlations	
25.1 Diaspirin Hemoglobin	1026
25.2 Cyanosis	1028
25.3 Chemically Modified Hemoglobins: Methemoglobin and Sulfhemoglobin	1030
25.4 Hemoglobins with Abnormal Oxygen Affinity	1032
25.5 The Case of the Variable Constant	1039
25.6 The Role of Bone in Acid–Base Homeostasis	1042
25.7 Acute Respiratory Alkalosis	1047
25.8 Chronic Respiratory Acidosis	1048
25.9 Salicylate Poisoning	1049
25.10 Evaluation of Clinical Acid–Base Data	1051
25.11 Metabolic Alkalosis	1052

CLINICAL CORRELATION 25.1**Diaspirin Hemoglobin**

Shock is a condition of inadequate tissue perfusion due, for example, to loss of blood. Hemorrhagic shock is a major cause of death following trauma. Rapid blood transfusion can be life-saving, but cross-matching must be done before transfusing blood, and transfusion is associated with a significant risk of disease. In addition, blood (or blood of the correct type) may be in short supply under certain circumstances. Hence there is considerable interest in developing a safe, effective blood substitute.

Hemoglobin in plasma has a very short lifetime. It rapidly dissociates into dimers, which bind to the plasma protein, haptoglobin, and are removed from circulation. Hemoglobin can be specifically cross-linked with bis(3,5-dibromosalicyl) fumarate at the Lys 99 of the α chains; the product is called diaspirin cross-linked hemoglobin (DCLHb). DCLHb has a longer lifetime in plasma than hemoglobin, and its lifetime can be extended still further by polymerizing the DCLHb. DCLHb has performed well as a blood replacement in experimental animals, and the possibility of using it in humans is being pursued.

25.1—**Introduction to Gas Transport**

Large organisms, especially terrestrial ones, require a relatively tough, impermeable outer covering to help shield them from dust, twigs, nonisotonic fluids like rain and seawater, and other elements in the environment that might be harmful to living cells. One of the consequences of being large and having an impermeable covering is that individual cells of the organism cannot exchange gases directly with the atmosphere. Instead there must exist a specialized exchange surface, such as a lung or a gill, and a system to circulate the gases (and other materials, such as nutrients and waste products) in a manner that will meet the needs of every living cell in the body.

The existence of a system for the transport of gases from the atmosphere to cells deep within the body is not merely necessary, it has definite advantages. Oxygen is a good oxidizing agent, and at its partial pressure in the atmosphere, about 160 mmHg or 21.3 kPa, it would oxidize and inactivate many components of the cells, such as essential sulfhydryl groups of enzymes. By the time O_2 gets through the transport system of the body its partial pressure is reduced to a much less damaging 20 mmHg (2.67 kPa) or less. In contrast, CO_2 is relatively concentrated in the body and becomes diluted in transit to the atmosphere. In the tissues, where it is produced, its partial pressure is 46 mmHg (6.13 kPa) or more. In the lungs it is 40 mmHg (5.33 kPa), and in the atmosphere only 0.2 mmHg (0.03 kPa), less abundant than the rare gas, argon. Its relatively high concentration in the body permits it to be used as one component of a physiologically important buffering system, a system that is particularly useful because, upon demand, the concentration of CO_2 in the extracellular fluid can be varied over a rather wide range. This is discussed in more detail later in the chapter.

Oxygen and CO_2 are carried between the lungs and the other tissues by the blood. In the blood some of each gas is present in simple physical solution, but mostly each is involved in some sort of interaction with hemoglobin, the major protein of the red blood cell. There is a reciprocal relation between hemoglobin's affinity for O_2 and CO_2 , so that the relatively high level of O_2 in the lungs aids the release of CO_2 , which is to be expired, and the high CO_2 level in other tissues aids the release of O_2 for their use. Thus a description of the physiological transport of O_2 and CO_2 is the story of the interaction of these two compounds with hemoglobin.

25.2—**Need for a Carrier of Oxygen in Blood**

An O_2 carrier is needed in blood because O_2 is not soluble enough in blood plasma to meet the body's needs. At 38°C, 1 L of plasma dissolves only 2.3 mL of O_2 . Whole blood, because of its **hemoglobin**, has a much greater oxygen capacity (see Clin. Corr. 25.1). One liter of blood normally contains about 150 g of hemoglobin (contained within the erythrocytes), and each gram of hemoglobin can combine with 1.34 mL of O_2 . Thus the hemoglobin in 1 L of blood can carry 200 mL of O_2 , 87 times as much as plasma alone would carry. Without an O_2 carrier, the blood would have to circulate 87 times as fast to provide the same amount of O_2 . As it is, the blood makes a complete circuit of the body in 60 s under resting conditions, and in the aorta it flows at the rate of about 18.6 m s⁻¹. An 87-fold faster flow would require a fabulous high-pressure pump, would produce tremendously turbulent flow and high shear forces in the plasma, would result in uncontrollable bleeding from wounds, and would not even allow the blood enough time in the lungs to take up O_2 . The availability of a carrier not only permits us to avoid these impracticalities, but also gives us a way of controlling oxygen delivery, since the O_2 affinity of the carrier is responsive to changing physiological conditions.

Respiratory System Anatomy Affects Blood Gas Concentration

The respiratory system includes the trachea, in the neck, which bifurcates in the thorax into right and left bronchi, as shown schematically in Figure 25.1. The bronchi continue to bifurcate into smaller and smaller passages, ending with tiny bronchioles, which open into microscopic gas-filled sacs called alveoli. It is in the alveoli that gas exchange takes place with the alveolar capillary blood.

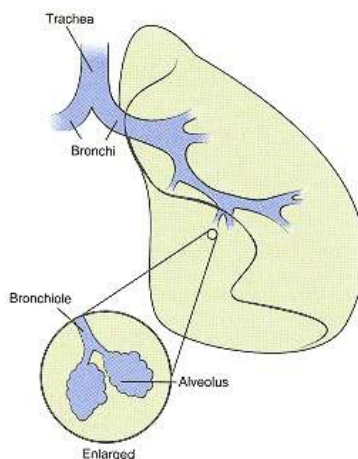

Figure 25.1
Diagram showing the respiratory tract.

As we inhale and exhale, the alveoli do not appreciably change in size. Rather, it is the airways that change in length and diameter as the air is pumped into and out of the lungs. Gas exchange between the airways and the alveoli then proceeds simply by diffusion. These anatomical and physiological facts have two important consequences. In the first place, since the alveoli are at the ends of long tubes that constitute a large dead space, and the gases in the alveoli are not completely replaced by fresh air with each breath, the gas composition of the alveolar air differs from that of the atmosphere, as shown in Table 25.1. Oxygen concentration is lower in the alveoli because it is removed by the blood. Carbon dioxide concentration is higher because it is added. Since we do not usually breathe air that is saturated with water vapor at 38°C, water vapor is generally added in the airways. The concentration of nitrogen is lower in the alveoli, not because it is taken up by the body, but simply because it is diluted by the CO₂ and water vapor.

A second consequence of the existence of alveoli of essentially constant size is that the blood that flows through the pulmonary capillaries during expiration, as well as the blood that flows through during inspiration, can exchange gases. This would not be possible if the alveoli collapsed during expiration and contained no gases, in which case the composition of the blood gases would fluctuate widely, depending on whether the blood passed through the lungs during an inspiratory or expiratory phase of the breathing cycle.

A Physiological Oxygen Carrier Must Have Unusual Properties

We have seen that an O₂ carrier is necessary. Clearly this carrier would have to be able to bind oxygen at an O₂ tension of about 100 mmHg (13.3 kPa), the partial pressure of oxygen in the alveoli. The carrier must also be able to release O₂ to the extrapulmonary tissues. The O₂ tension in the capillary bed of an active muscle is about 20 mmHg (2.67 kPa). In resting muscle it is higher, but during extreme activity it is lower. These O₂ tensions represent the usual limits within which an oxygen carrier must work. An efficient carrier would be nearly fully saturated in the lungs but should be able to give up most of this to a working muscle.

Let us first see whether a carrier that binds O₂ in a simple equilibrium represented by

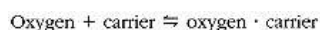

TABLE 25.1 Partial Pressures of Important Gases Given in Millimeters of Hg (kPa)

Gas	In the Atmosphere		In the Alveoli of the Lungs	
	mmHg	kPa	mmHg	kPa
O ₂	159	21.2	100	13.3
N ₂	601	80.1	573	76.4
CO ₂	0.2	0.027	40	5.33
H ₂ O	0	0	47	6.27
Total	760	101	760	101

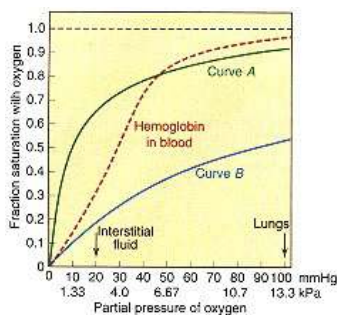

Figure 25.2
Oxygen saturation curves for two hypothetical oxygen carriers and for hemoglobin.

Curve *A*: Hypothetical carrier with hyperbolic saturation curve (a simple carrier), 90% saturated in the lungs and 66% saturated at the partial pressure found in interstitial fluid. Curve *B*: Hypothetical carrier with hyperbolic saturation curve (another simple carrier), 56% saturated in the lungs and 20% saturated at the partial pressure found in interstitial fluid. Dashed curve: Hemoglobin in whole blood.

CLINICAL CORRELATION 25.2

Cyanosis

Cyanosis is a condition in which a patient's skin or mucous membrane appears gray or (in severe cases) purple-magenta. It is due to an abnormally high concentration of deoxyhemoglobin below the surface, which is responsible for the observed color. The familiar blue of superficial veins is due to their deoxyhemoglobin content and is a normal manifestation of this color effect.

Cyanosis is most commonly caused by diseases of the cardiac or pulmonary systems, resulting in inadequate oxygenation of the blood. It can also be caused by certain hemoglobin abnormalities. Severely anemic individuals cannot become cyanotic; they do not have enough hemoglobin in their blood for the characteristic color of its deoxy form to be apparent.

Albert, R. K. Approach to the patient with cyanosis and/or hypoxemia. In: W. N. Kelley (Ed.), *Textbook of Internal Medicine*. Philadelphia: Lippincott, 1989, pp. 2041–2044.

would be satisfactory. For this type of carrier the dissociation constant would be given by the simple expression

$$K_d = \frac{[\text{oxygen}][\text{carrier}]}{[\text{oxygen} \cdot \text{carrier}]}$$

and the saturation curve would be a **rectangular hyperbola**. This model would be valid even for a carrier with several oxygen-binding sites per molecule, which we know is the case for hemoglobin, as long as each site were independent and not influenced by the presence or absence of O_2 at adjacent sites.

If such a carrier had a dissociation constant that permitted 90% saturation in the lungs, then, as shown in Figure 25.2, curve *A*, at a partial pressure of 20 mmHg (2.67 kPa) it would still be 66% saturated and would have delivered only 24% of its O_2 load. This would not be very efficient.

What about some other simple carrier, one that bound O_2 less tightly and therefore released most of it at low partial pressure, so that the carrier was, say, only 20% saturated at 20 mmHg (2.67 kPa)? Again, as shown in Figure 25.2, curve *B*, it would be relatively inefficient; in the lungs this carrier could fill only 56% of its maximum O_2 capacity and would deliver only 36% of what it could carry. It appears then that the mere fivefold change in O_2 tension between the lungs and the unloading site is not compatible with efficient operation of a simple carrier. Simple carriers are not sensitive enough to respond massively to a signal as small as a fivefold change.

Figure 25.2 also shows the oxygen-binding curve of hemoglobin in normal blood. The curve is **sigmoid**, not hyperbolic, and it cannot be described by a simple equilibrium expression. Hemoglobin, however, is a very good physiological O_2 carrier. It is 98% saturated in the lungs and only about 33% saturated in the working muscle. Under these conditions it delivers about 65% of the O_2 it can carry.

It can be seen in Figure 25.2 that hemoglobin is 50% saturated with O_2 , at a partial pressure of 27 mmHg (3.60 kPa). The partial pressure corresponding to 50% saturation is called the P_{50} . The term P_{50} is the most common way of expressing hemoglobin's O_2 affinity. By analogy with K_m for enzymes, a relatively high P_{50} corresponds to a relatively low O_2 affinity.

The Steep Part of the Curve Lies in the Physiological Range

Note that the steep part of hemoglobin's saturation curve lies in the range of O_2 tensions that prevail in the extrapulmonary tissues. This means that relatively small decreases in oxygen tension in these tissues will result in large increases in O_2 delivery, this effect becoming more pronounced as the partial pressure of O_2 diminishes within the physiological range. Furthermore, small shifts of the curve to the left or right will also strongly influence O_2 delivery. In Sections 25.3, 25.5, and 25.6 we see how physiological signals effect such shifts and result in enhanced delivery under conditions of increased O_2 demand. Small decreases of O_2 tension in the lungs, however, such as occur at moderately high altitudes, do not seriously compromise hemoglobin's ability to bind oxygen. This will be true as long as the alveolar partial pressure of O_2 remains in a range that corresponds to the relatively flat region of hemoglobin's O_2 dissociation curve (see Clin. Corr. 25.2).

Finally, we can see from Figure 25.2 that the binding of oxygen by hemoglobin is cooperative. At very low O_2 tension the hemoglobin curve tends to follow the hyperbolic curve, which represents relatively weak O_2 binding, but at higher tensions it actually rises above the hyperbolic curve that represents tight binding. Thus hemoglobin binds O_2 weakly at low oxygen tension and tightly at high tension. The binding of the first O_2 to each hemoglobin molecule enhances the binding of subsequent O_2 molecules.

Hemoglobin's ability to bind O_2 cooperatively is reflected in its **Hill coefficient**, which has a value of about 2.7. (The Hill equation is derived and interpreted on p. 119.) Since the maximum value of the Hill coefficient for a system at equilibrium is equal to the number of cooperating binding sites, a value of 2.7 means that hemoglobin, with its four oxygen-binding sites, is more cooperative than would be possible for a system with only two cooperating binding sites, but it is not as cooperative as it could be.

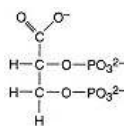

Figure 25.3
2,3-Bisphosphoglycerate (BPG).

25.3— Hemoglobin and Allostereism: Effect of 2,3-Bisphosphoglycerate

Hemoglobin's binding of O_2 was the original example of a **homotropic effect** (cooperativity and allosterism are discussed in Chapter 4), but hemoglobin also exhibits a **heterotropic effect** of great physiological significance. This involves its interaction with **2,3-bisphosphoglycerate (BPG)** (Figure 25.3), which is closely related to the glycolytic intermediate, 1,3-bisphosphoglycerate, from which it is biosynthesized.

It had been known for many years that hemoglobin in the red cell bound oxygen less tightly than purified hemoglobin could (Figure 25.4). It had also been known that the red cell contained high levels of BPG, nearly equimolar with hemoglobin. Finally, the appropriate experiment was done to demonstrate the relationships between these two facts. It was shown that the addition of BPG to purified hemoglobin produced a shift to the right of its oxygen-binding curve, bringing it into congruence with the curve observed for whole blood. Other organic polyphosphates, such as ATP and inositol pentaphosphate, also have this effect. Inositol pentaphosphate is the physiological effector in birds, where it replaces BPG, and ATP plays a similar role in some fish.

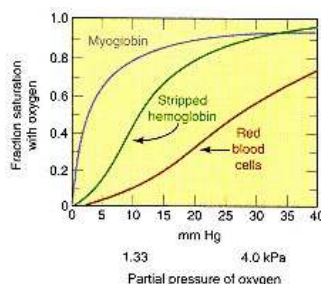

Figure 25.4
Oxygen dissociation curves for myoglobin, for hemoglobin that has been stripped of CO_2 and organic phosphates, and for whole red blood cells.

Data from Brenna, O., Luzzana, M., Pace, M., et al.
Adv. Exp. Biol. Med. 28:19, 1972.
Adapted from McGilvery, R. W.
Biochemistry: A Functional Approach, 2nd ed. Philadelphia: Saunders, 1979, p. 236.

Monod's model of allosterism explains heterotropic interaction. Applying this model to hemoglobin, in the deoxy conformation (the **T state**) a cavity large enough to admit BPG exists between the β chains of hemoglobin. This cavity is lined with positively charged groups and firmly binds one molecule of the negatively charged BPG. In the oxy conformation (the **R state**) this cavity is smaller, and it no longer accommodates BPG as easily. The result is that the binding of BPG to oxyhemoglobin is much weaker. Since BPG binds preferentially to the T state, the presence of BPG shifts the R–T equilibrium in favor of the T state; the deoxyhemoglobin conformation is thus stabilized over the oxyhemoglobin conformation (Figure 25.5). For oxygen to overcome this and bind to hemoglobin, a higher concentration of oxygen is required. Oxygen tension in the lungs is sufficiently high under most conditions to saturate hemoglobin almost completely, even when BPG levels are high. The physiological effect of BPG can, therefore, be expected to be upon release of oxygen to the extrapulmonary tissues, where O_2 tensions are low.

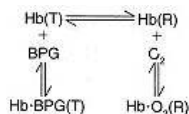

Figure 25.5
Schematic representation of equilibria among BPG, O_2 , and the T and R states of hemoglobin.

The significance of a high BPG concentration is that the efficiency of O_2 delivery is increased. Concentrations of BPG in the red cell rise in conditions associated with **tissue hypoxia**, such as various anemias, cardiopulmonary insufficiency, and high altitude. These high levels of BPG enhance the formation of deoxyhemoglobin at low partial pressures of oxygen; hemoglobin then delivers more of its O_2 to the tissues. This effect can result in a substantial increase in the amount of O_2 delivered because the venous blood returning to the heart of a normal individual is (at rest) at least 60% saturated with O_2 . Much of this O_2 can dissociate in the peripheral tissues if the BPG concentration rises.

The BPG mechanism works very well as a compensation for tissue hypoxia as long as the partial pressure of oxygen in the lungs remains high enough that oxygen binding in the lungs is not compromised. Since, however, BPG shifts the oxygen-binding curve to the right, the mechanism will not compensate for tissue hypoxia when the partial pressure of O_2 in the lungs falls too low. Then

CLINICAL CORRELATION 25.3

Chemically Modified Hemoglobins: Methemoglobin and Sulfhemoglobin

Methemoglobin is a form of hemoglobin in which the iron is oxidized from the iron (II) state to the iron (III) state. A tendency for methemoglobin to be present in excess of its normal level of about 1% may be due to a hereditary defect of the globin chain or to exposure to oxidizing drugs or chemicals. Sulfhemoglobin is a species that forms when a sulfur atom is incorporated into the porphyrin ring of hemoglobin. Exposure to certain drugs or to soluble sulfides produces it. Sulfhemoglobin is green. Hemoglobin subunits containing these modified hemes do not bind oxygen, but they change the oxygen-binding characteristics of the normal subunits in hybrid hemoglobin molecules containing some normal subunits and one or more modified subunits. The accompanying figure shows the oxygen-binding curve of normal HbA, 15% methemoglobin and 12% sulfhemoglobin. The presence of methemoglobin shifts the curve to the left, impairing the delivery of the decreased amount of bound oxygen. In contrast, the sulfhemoglobin curve is shifted to the right, a BPG-like effect. As a result, oxygen delivery is enhanced, partially compensating for the inability of the sulfur-modified hemes to bind oxygen.

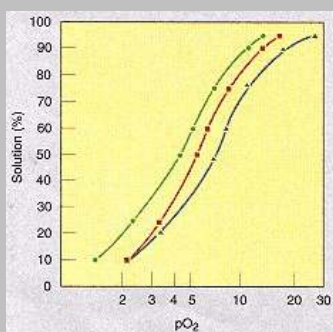

Oxygenation curves of unmodified hemoglobin A (squares) of a 15% oxidized hemolysate (circles) and of a hemolysate containing 12% sulfhemoglobin (triangles) in 0.1 M phosphate, pH 7.35, at 20°C. Data from Park, C. M., and Nagel, R. L., *N. Engl. J. Med.* 310:1579, 1984.

the increased efficiency of O₂ unloading to the tissues is counterbalanced by a decrease in the efficiency of loading in the lungs. This may be a factor in determining the maximum altitude at which people choose to establish permanent dwellings, which is about 18,000 ft (~5500 m). There is evidence that a better adaptation to extremely low ambient partial pressures of O₂ would be a shift of the curve to the left.

25.4— Other Hemoglobins

Although hemoglobin A is the major form of hemoglobin in adults and in children over seven months of age, accounting for about 90% of their total hemoglobin, it is not the only normal hemoglobin species. Normal adults also have 2–3% of **hemoglobin A₂**, which is composed of two α chains like those in hemoglobin A and two δ chains. It is represented as $\alpha_2\delta_2$. The δ chains differ in amino acid sequence from the β chains and are under independent genetic control. Hemoglobin A₂ does not appear to be important in normal individuals.

Several species of modified hemoglobin A also occur normally. These are designated A_{1a1}, A_{1a2}, A_{1b}, and A_{1c}. They are adducts of hemoglobin with various sugars, such as glucose, glucose 6-phosphate, and fructose 1,6-bisphosphate. The quantitatively most significant is **hemoglobin A_{1c}**, formed by covalent binding of a glucose residue to the N terminal of the β chain at a rate that depends on the concentration of glucose. As a result, hemoglobin A_{1c} forms more rapidly in uncontrolled diabetics and can comprise up to 12% of their total hemoglobin. Hemoglobin A_{1c} or total glycosylated hemoglobin levels are a useful measure of how well diabetes has been controlled during the days and weeks before the measurement is taken; measurement of blood glucose only indicates how well diabetes is under control when the blood sample is taken. Chemical modification of hemoglobin A can also occur from interaction with drugs or environmental pollutants (see Clin. Corr. 25.3).

Fetal hemoglobin, **hemoglobin F**, is the major hemoglobin in newborn infants. It contains two γ chains in place of the β chains and is represented as $\alpha_2\gamma_2$. Shortly before birth γ -chain synthesis diminishes and β -chain synthesis is initiated, and by the age of seven months well over 90% of the infant's hemoglobin is hemoglobin A.

Hemoglobin F is adapted to the environment of the fetus, who gets oxygen from maternal blood, a source that is far poorer than the atmosphere. To compete with the maternal hemoglobin for O₂, fetal hemoglobin must bind O₂ more tightly; its oxygen-binding curve is thus shifted to the left relative to hemoglobin A. This is accomplished through a difference in the influence of BPG upon the maternal and fetal hemoglobins. In hemoglobin F two of the groups that line the BPG-binding cavity have neutral side chains instead of the positively charged ones that occur in hemoglobin A. Consequently, hemoglobin F binds BPG less tightly and thus binds oxygen more tightly than hemoglobin A does. Also, about 15–20% of the hemoglobin F is acetylated at the N terminals; this is referred to as hemoglobin F₁. Hemoglobin F₁ does not bind BPG, and its affinity for oxygen is not affected at all by BPG. The postnatal change from hemoglobin F to hemoglobin A, combined with a rise in red cell BPG that peaks three months after birth, results in a gradual shift to the right of the infant's oxygen-binding curve (Figure 25.6). The result is greater delivery of oxygen to the tissues at this age than at birth, in spite of a 30% decrease in the infant's total hemoglobin concentration.

In many inherited anomalies of hemoglobin synthesis there is formation of a structurally abnormal hemoglobin; these are called **hemoglobinopathies**. They may involve the substitution of one amino acid in one type of polypeptide chain for some other amino acid or they may involve absence of one or more amino acid residues of a polypeptide chain. In some cases the change is clinically insignificant, but in others it causes serious disease (see Clin. Corr. 25.4).

25.5—

Physical Factors That Affect Oxygen Binding**High Temperature Weakens Hemoglobin's Oxygen Affinity**

Temperature has a significant effect on O₂ binding by hemoglobin (Figure 25.7). At below-normal temperatures the binding is tighter, resulting in a leftward shift of the curve; at higher temperatures the binding becomes weaker, and the curve is shifted to the right. The effect of elevated temperature is like that of high levels of BPG, in that both enhance unloading of oxygen. The temperature effect is physiologically useful, as it makes additional O₂ available to support the high metabolic rate found in fever or in exercising muscle with its elevated temperature. The relative insensitivity to temperature of O₂ binding at high partial pressure of oxygen minimizes compromise of O₂ uptake in the lungs under these conditions.

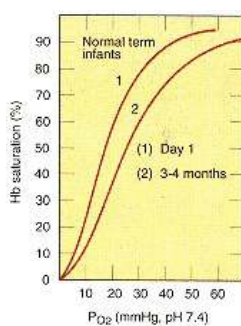

Figure 25.6

Oxygen dissociation curves after birth.

Adapted from Oski, F. A., and Delivoria-Papadopoulos, M. *J. Pediatr.* 77:941, 1970.

The tighter binding of O₂ that occurs in hypothermic conditions is not important in hypothermia induced for surgical purposes. Decreased O₂ utilization by the body and increased solubility of O₂ in plasma at lower temperatures, as well as the increased solubility of CO₂, which acidifies the blood, compensate for hemoglobin's diminished ability to release O₂.

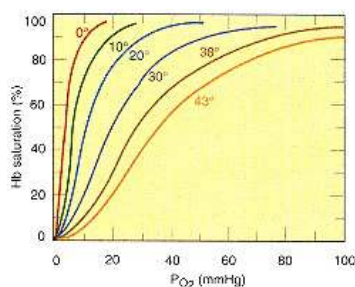

Figure 25.7

Oxygen dissociation curve for whole blood at various temperatures.

From Lambertson, C. J. In: P. Bard (Ed.), *Medical Physiology*, 11th ed. St. Louis, MO: Mosby, 1961, p. 596.

Low pH Weakens Hemoglobin's Oxygen Affinity

Hydrogen ion concentration influences hemoglobin's O₂ binding. As shown in Figure 25.8, low pH shifts the curve to the right, enhancing O₂ delivery, whereas high pH shifts the curve to the left. It is customary to express O₂ binding by hemoglobin as a function of plasma pH because it is this value, not the pH within the erythrocyte, that is usually measured. Erythrocyte cell sap pH is lower than the plasma pH, but these two fluids are in equilibrium, and changes in one reflect changes in the other.

The influence of pH upon O₂ binding is physiologically significant, since a decrease in pH is often associated with increased oxygen demand. Increased metabolic rate increases production of carbon dioxide and, as in muscular exercise and hypoxic tissue, lactic acid. These acids produced by metabolism help release oxygen to support that metabolism.

The increase in acidity of hemoglobin as it binds O₂ is known as the **Bohr effect**; an equivalent statement is that the Bohr effect is the increase in basicity of hemoglobin as it releases oxygen. The effect may be expressed by the equation

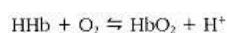

This equation gives the same information as Figure 25.8—that increases in hydrogen ion concentration favor formation of free oxygen from oxyhemoglobin, and conversely, that oxygenation of hemoglobin lowers the pH of the solution.

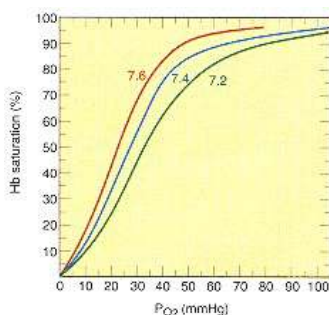

Figure 25.8

Oxygen dissociation curve for whole blood at various values of plasma pH.

Adapted from Lambertson, C. J. In: P. Bard (Ed.), *Medical Physiology*, 11th ed. St. Louis, MO: Mosby, 1961, p. 596.

25.6—

Carbon Dioxide Transport

The carbon dioxide we produce is excreted by the lungs, to which it is transported by the blood. Carbon dioxide transport is closely tied to hemoglobin and to the problem of maintaining a constant pH in the blood, a problem that will be discussed subsequently.

Blood CO₂ Is Present in Three Major Forms

Carbon dioxide is present in the blood in three major forms, as dissolved CO₂, as HCO₃⁻ (formed by ionization of H₂CO₃ produced when CO₂ reacts with H₂O), and as carbaminohemoglobin (formed when CO₂ reacts with amino groups of protein). Each of these is present both in arterial blood and in venous blood

(see the top three lines of Table 25.2). Net transport to the lungs for excretion is represented by the concentration difference between arterial and venous blood, shown in the last column. Note that for each form of carbon dioxide the arterial–venous difference is only a small fraction of the total amount present; venous blood contains only about 10% more **total carbon dioxide** (total CO_2 is the sum of HCO_3^- , dissolved CO_2 , and carbaminohemoglobin) than arterial blood.

After carbon dioxide enters the bloodstream for transport, it generates hydrogen ions. Most come from formation of bicarbonate ion, which occurs in the following manner.

Bicarbonate Formation

Carbon dioxide enters the blood and diffuses into erythrocytes, whose membranes, like most biological membranes, are freely permeable to dissolved CO_2 . Within the erythrocytes most of the carbon dioxide is acted on by the intracellular enzyme, **carbonic anhydrase**, which catalyzes the reaction

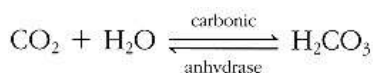

This reaction proceeds in the absence of a catalyst, as is well known to all who drink carbonated beverages. Without the catalyst, however, it is too slow to meet the body's needs, taking over 100 s to reach equilibrium. Recall that at rest the blood makes a complete circuit of the body in 60 s. Carbonic anhydrase is a very active enzyme, having a turnover number of the order of 10^6 , and inside the erythrocytes the reaction reaches equilibrium within 1 s, less than the time spent by the blood in the capillary bed. The enzyme contains zinc and accounts in part for our dietary requirement for this metal.

The ionization of carbonic acid, $\text{H}_2\text{CO}_3 \rightleftharpoons \text{H}^+ + \text{HCO}_3^-$, is a rapid, spontaneous reaction. It produces equivalent amounts of H^+ and HCO_3^- . Since, as shown in the last column of line 2 in Table 25.2, 1.69 meq of bicarbonate was added to each liter of blood by this process, 1.69 meq of H^+ must also have been generated per liter of blood. Addition of this much acid, over 10^{-3} equiv of H^+ , to 1 L of water would give a final pH below 3. Since the pH of venous plasma averages 7.37, most of the H^+ generated during HCO_3^- production must be consumed by buffer action and/or other processes. This is discussed below.

Because of the compartmentalization of carbonic anhydrase, essentially all conversion of CO_2 to H_2CO_3 , and ultimately to HCO_3^- , occurs inside the erythrocyte. Negligible amounts of CO_2 react nonenzymatically in the plasma. Thus virtually all of the increase in HCO_3^- in venous as compared to arterial blood is generated in erythrocytes. Most of this diffuses into the plasma, so that venous plasma HCO_3^- is higher than the arterial, but the erythrocyte was the site of its formation.

Carbaminohemoglobin Formation

It has been observed that in the presence of carbonic anhydrase inhibitors, such as acetazolamide or cyanide, blood will still take up a certain amount of carbon dioxide rapidly. This is due to the reaction of carbon dioxide with amino groups of proteins within erythrocytes to form **carbamino groups** (Figure 25.9). Hemoglobin is quantitatively the most important protein involved in this reaction. Deoxyhemoglobin forms **carbamino hemoglobin** more readily than oxyhemoglobin. Oxygenation causes release of CO_2 in carbaminohemoglobin.

Carbaminohemoglobin formation occurs only with uncharged aliphatic amino groups, not with the charged form, R-NH_3^+ . The pH within erythrocytes is normally about 7.2, somewhat more acidic than the plasma. Since protein amino groups have pK values well to the alkaline side of 7.2, they will be mostly in the charged (undissociated acid) form. Removal of some of the un-

CLINICAL CORRELATION 25.4

Hemoglobins with Abnormal Oxygen Affinity

Some abnormal hemoglobins have an altered affinity for oxygen. If oxygen affinity is increased (P_{50} decreased), oxygen delivery to the tissues will be diminished unless some sort of compensation occurs. Typically, the body responds by producing more erythrocytes (polycythemia) and more hemoglobin. Hb Rainier is an abnormal hemoglobin in which the P_{50} is 12.9 mmHg, far below the normal value of 27 mmHg.

In the accompanying figure the oxygen content in volume percent (mL of O_2 per 100 mL of blood) is plotted versus partial pressure of oxygen, both for normal blood (curve *a*) and for the blood of a patient with Hb Rainier (curve *b*). Obviously, the patient's blood carries more oxygen; this is because it contains 19.5 g of Hb per 100 mL instead of the usual 15 g per 100 mL.

Since the partial pressure of oxygen in mixed venous blood is about 40 mmHg, the volume of oxygen the blood of each individual can deliver may be obtained from the graph by subtracting the oxygen content of the blood at 40 mmHg from its oxygen content at 100 mmHg. As shown in the figure, the blood of the patient with Hb Rainier delivers nearly as much oxygen as normal blood does, although Hb Rainier delivers a significantly smaller fraction of the total amount it carries. Evidently, polycythemia is an effective compensation for this condition, at least in the resting state.

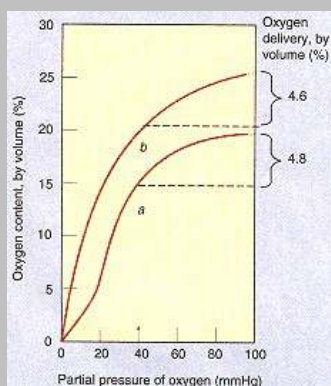

Oxygen content plotted against partial pressure of oxygen.

(continued)

(Table continued from previous page)

Curve *a* shows the oxygen dissociation curve of normal blood with a hemoglobin of 15 g dL⁻¹, P_{50} 27 mmHg, n 2.8, at pH 7.4, 37°C. Curve *b* shows that of blood from a patient with Hb Rainier, having a hemoglobin of 19.5 g dL⁻¹, P_{50} 12.9 mmHg, n 1.2, at the same pH and temperature. (1 mmHg = 133.3 Pa.) On the right is shown the oxygen delivery. The compensatory polycythemia and hyperbolic curve of Hb Rainier result in practically normal arterial and venous oxygen tensions. Arrow indicates normal mixed venous oxygen tension. From Bellingham, A. J. Br. Med. Bull. 32:234, 1976.

charged form via carbamino group formation shifts the equilibrium, generating more uncharged amino groups and an equivalent amount of H⁺, as shown in Figure 25.10. Carbamination, like HCO₃⁻ formation, generates H⁺.

The N-terminal α -amino groups of proteins have pK values in the range of 7.6–8.4. The N terminals of hemoglobin's polypeptide chains are the principal sites of carbamination. If they are blocked chemically by reaction with cyanate, carbamino formation does not occur.

The N-terminal amino groups of the β -globin chains are part of the binding site for BPG. Since they cannot bind BPG and also form carbamino groups, a competition arises. Carbon dioxide diminishes the effect for BPG and, conversely, BPG diminishes the ability of hemoglobin to form carbaminohemoglobin. Ignorance of the latter interaction led to a major overestimation of the role of carbaminohemoglobin in carbon dioxide transport. Prior to the discovery of the BPG effect, careful measurements were made of the capacity of purified hemoglobin (no BPG present) to form carbaminohemoglobin. The results were assumed to be applicable to hemoglobin in the erythrocyte, leading to the erroneous conclusion that carbaminohemoglobin accounted for 25–30% or more of CO₂ transport. It now appears that 13–15% of CO₂ transport is via carbaminohemoglobin. Table 25.3 summarizes the contribution of each major form of blood carbon dioxide to overall CO₂ transport.

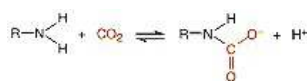

Figure 25.9
Carbamino formation from a free amino group and carbon dioxide.

Two Processes Regulate [H⁺] Derived from CO₂ Transport

Buffering

Hemoglobin, besides carrying O₂ and CO₂ in the covalently bound form of a carbamino group, also plays the major role in handling the H⁺ produced in CO₂ transport. It does this by buffering and by the isohydric mechanism (discussed below). **Hemoglobin's buffering** power resides in its ionizable groups with pK values close to the intracellular pH. These include the four N-terminal amino groups and the imidazole side chains of the histidine residues. There are 38 histidines per hemoglobin tetramer; these provide most of hemoglobin's buffering ability.



Figure 25.10
Dissociation of an ammonium ion to yield a free amino group and H⁺.

In whole blood, buffering takes up about 60% of the acid generated in normal carbon dioxide transport. Although hemoglobin is by far the most important nonbicarbonate buffer in blood, the organic phosphates in the eryth-

TABLE 25.2 Properties of Blood of Humans at Rest^a

	Arterial			Venous			A-V Difference		
	Serum	Cells	Blood	Serum	Cells	Blood	Serum	Cells	Blood
Hb carbamino groups (meq L ⁻¹ of blood)		1.13	1.13		1.42	1.42		+0.29	+0.29
HCO ₃ ⁻ (meq L ⁻¹ of blood)	13.83	5.73	19.56	14.84	6.41	21.25	+1.01	+0.68	+1.69
Dissolved CO ₂ (meq L ⁻¹ of blood)	0.71	0.48	1.19	0.82	0.56	1.38	+0.11	+0.08	+0.19
Total CO ₂ (meq L ⁻¹ of blood)	14.54	7.34	21.88	15.66	8.39	24.05	+1.12	+1.05	+2.17
Free O ₂ (mmol L ⁻¹ of blood)			0.10			0.04			-0.06
Bound O ₂ (mmol L ⁻¹ of blood)			8.60			6.01			-2.59
Total O ₂ (mmol L ⁻¹ of blood)			8.70			6.05			-2.65
P_{O_2} (mmHg)			88.0			37.2			-50.8
P_{CO_2} (mmHg)			41.0			47.5			+6.5
pH	7.40	7.19		7.37	7.17		-0.03	-0.02	
Volume (cc L ⁻¹ of blood)	551.7	448.3	1000	548.9	451.1	1000	-2.8	+2.8	0.0
H ₂ O (cc L ⁻¹ of blood)	517.5	322.8	840.0	514.7	325.6	840.0	-2.8	+2.8	0.0
Cl ⁻ (meq L ⁻¹ of blood)	57.71	24.30	82.01	56.84	25.17	82.01	-0.88	+0.88	0.0

Source: From Baggott, J. *Trends Biochem. Sci* 3:N207, 1978, with permission of the publisher.

^a Hemoglobin, 9 mM; serum protein, 39.8 g L⁻¹ of blood; respiratory quotient, 0.82.

TABLE 25.3 Major Forms of Carbon Dioxide Transport

Species	Transport (%)
HCO_3^-	78
CO_2 (dissolved)	9
Carbaminohemoglobin	13

TABLE 25.4 Processes occurring at the N Terminals of the α Chains and β Chains of Hemoglobin

Process	N Terminals	
	α Chains	β Chains
Carbamino formation	Yes	Yes
BPG binding	No	Yes
H^+ binding in the Bohr effect	Yes	No

TABLE 25.5 Control of the Excess H^+ Generated During Normal Carbon Dioxide Transport

Buffering	
By hemoglobin	50%
By other buffers	10%
Isohydric mechanism (hemoglobin)	40%

rocytes, the plasma proteins, and so on also make a significant contribution. Buffering by these compounds accounts for about 10% of the H^+ , leaving about 50% of acid control specifically attributable to buffering by hemoglobin. These buffer systems minimize the change in pH that occurs when acid or base is added but do not altogether prevent that change. A small difference in pH between arterial and venous blood is therefore observed.

Isohydric Mechanism

The remainder of the H^+ arising from carbon dioxide is taken up by hemoglobin, but not by buffering. Recall that when hemoglobin becomes oxygenated it becomes a stronger acid and releases H^+ (the Bohr effect). In the capillaries, where O_2 is released, the opposite occurs:

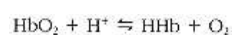

Simultaneously, CO_2 enters the capillaries and is hydrated:

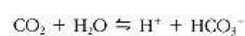

Addition of these two equations gives

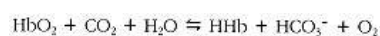

revealing that to some extent this system can take up H^+ arising from CO_2 , and can do so without a change in H^+ concentration (i.e., with no change in pH). Hemoglobin's ability to do this, through the operation of the Bohr effect, is referred to as the **isohydric carriage of CO_2** . As already pointed out, there is a small A–V difference in plasma pH. This is because the isohydric mechanism cannot handle all the acid generated during normal CO_2 transport; if it could, no such difference would occur. Figure 25.11 is a schematic representation of

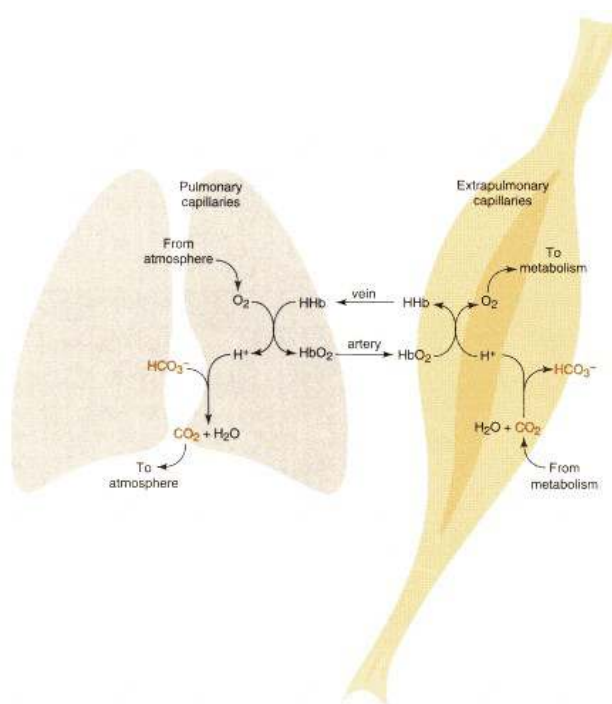

Figure 25.11
Schematic representation of oxygen transport and the isohydric carriage of CO_2 by hemoglobin.

In the lungs (left) O_2 from the atmosphere reacts with deoxyhemoglobin, forming oxyhemoglobin and H^+ . The H^+ combines with the HCO_3^- to form H_2O and CO_2 .

The CO_2 is exhaled. Oxyhemoglobin is carried to extrapulmonary tissues (right), where it dissociates in response to low P_{O_2} . The O_2 is used by metabolic processes, and CO_2 is produced. CO_2 combines with H_2O to give HCO_3^- and H^+ . H^+ can then react

with deoxyhemoglobin to give HHb, which returns to the lungs, and the cycle repeats.

O₂ transport and the isohydric mechanism, showing what happens in the lungs and in the other tissues.

Estimates of the importance of the isohydric mechanism in handling normal respiratory acid production have changed upward and downward over the years. The older, erroneous estimates arose out of a lack of knowledge of the multiple interactions in which hemoglobin participates. The earliest experiments, titrations of purified oxyhemoglobin and purified deoxyhemoglobin, revealed that oxygenation of hemoglobin resulted in release of an average of 0.7 H⁺ for every O₂ bound. This figure still appears in textbooks, and much is made of it. Authors point out that with a Bohr effect of this magnitude the isohydric mechanism alone could handle all of the acid produced by the metabolic oxidation of fat (RQ of fat is 0.7), and buffering would be unnecessary. Unfortunately, the experimental basis for this interpretation is physiologically unrealistic; the titrations were done in the total absence of carbon dioxide, which we now know binds to some of the Bohr groups, forming carbamino groups and diminishing the effect. When later experiments were carried out in the presence of physiological amounts of carbon dioxide, there was a drastic diminution of the Bohr effect, so much so that at pH 7.45 the isohydric mechanism was able to handle only the amount of acid arising from carbamino group formation. This work, however, was done prior to our appreciation of the competition between BPG and CO₂ for the same region of the hemoglobin molecule (see Table 25.4). Finally, in 1971, careful titrations of whole blood under presumably physiological conditions were carried out, yielding a value of 0.31 H⁺ released per O₂ bound. This value is the basis of the present assertion that the isohydric mechanism accounts for about 40% of the H⁺ generated during normal carbon dioxide transport. The quantitative contributions of various mechanisms to the handling of H⁺ arising during carbon dioxide transport are summarized in Table 25.5. The major role of hemoglobin in handling this acid is obvious.

HCO₃⁻ Distribution between Plasma and Erythrocytes

We have seen that essentially all of HCO₃⁻ formation is intracellular, catalyzed by carbonic anhydrase, and that the vast bulk of the H⁺ generated by CO₂ is handled within the erythrocyte. These two observations bear upon the final distribution of HCO₃⁻ between plasma and the erythrocyte.

Intracellular formation of HCO₃⁻ increases its intracellular concentration. Since HCO₃⁻ and Cl⁻ exchange freely across the erythrocyte membrane, HCO₃⁻ will diffuse out of the erythrocyte, increasing the plasma HCO₃⁻ concentration. Electrical neutrality must be maintained across the membrane as this happens. Maintenance of neutrality can be accomplished in principle either by having a positively charged ion accompany HCO₃⁻ out of the cell or by having some other negatively charged ion enter the cell in exchange for the HCO₃⁻. Since the distribution of the major cations, Na⁺ and K⁺, is under strict control, it is the latter mechanism that is seen, and the ion that is exchanged for HCO₃⁻ is Cl⁻. Thus as HCO₃⁻ is formed in red cells during their passage through the capillary bed, it moves out into the plasma and Cl⁻ comes in to replace it. The increase in intracellular Cl⁻ is shown in the last line of Table 25.2. In the lungs, all events that occur in the peripheral capillary beds are reversed; HCO₃⁻ enters the erythrocytes to be converted to CO₂ for exhalation, and Cl⁻ returns to the plasma. The exchange of Cl⁻ and HCO₃⁻ between the plasma and the erythrocyte is called the **chloride shift** (Figure 25.12).

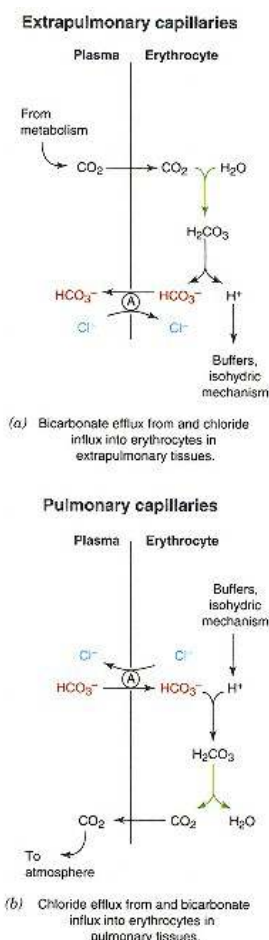

Figure 25.12
Schematic representation of the chloride shift.

- (a) In the capillaries of the extrapulmonary tissues, CO₂ produced by tissue metabolism is converted to HCO₃⁻ in the erythrocytes. This HCO₃⁻ exits the erythrocytes in exchange for Cl⁻.
- (b) In the capillaries of the lungs, HCO₃⁻ enters the erythrocytes in exchange for Cl⁻. Within the erythrocytes HCO₃⁻ is converted to CO₂. CO₂ subsequently diffuses out of the erythrocytes and is exhaled.

The intraerythrocytic buffering of H⁺ from carbon dioxide causes these cells to swell, giving venous blood a slightly (0.6%) higher hematocrit than arterial blood. (Hematocrit is the volume percent of red cells in the blood.) This occurs because the charge on the hemoglobin molecule becomes more positive with every H⁺ that binds to it. Each bound positive charge requires an accompanying negative charge to maintain neutrality. Thus as a result of buffering there is a net accumulation of HCO₃⁻ or Cl⁻ inside the erythrocyte.

An increase in the osmotic pressure of the intracellular fluid results from this increase in concentration of particles. As a consequence, water enters the cells, causing them to swell slightly. Typically, an arterial hematocrit might be 44.8 and a venous hematocrit 45.1, as shown in Table 25.2 by the line labeled "volume (cc L⁻¹ of blood)."

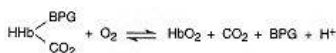

Figure 25.13

Interaction of H⁺, BPG, CO₂, and O₂ with hemoglobin.

This is a schematic, intended to denote the direction of the equilibrium, not the stoichiometry of the reaction.

25.7—

Interrelationships among Hemoglobin, Oxygen, Carbon Dioxide, Hydrogen Ion, and 2,3-Bisphosphoglycerate

By now it should be clear that multiple interrelationships of physiological significance exist among the ligands of hemoglobin. These interrelationships are summarized schematically in Figure 25.13. This equation shows that changes in the concentration of H⁺, BPG, or CO₂ have similar effects on O₂ binding. The equation will help you remember the effect of changes in any one of these variables upon hemoglobin's O₂ affinity.

BPG levels in the erythrocytes are controlled by product inhibition of its synthesis and by pH. Hypoxia results in increased levels of deoxyhemoglobin on a time-averaged basis. Since deoxyhemoglobin binds BPG more tightly, in hypoxia there is less free BPG to inhibit its own synthesis, and so BPG levels will rise due to increased synthesis. The effect of pH is that high pH increases BPG synthesis and low pH decreases BPG synthesis; this reflects the influence of pH on the activity of **BPG mutase**, the enzyme that catalyzes BPG formation. Since changes in BPG levels take many hours to become complete, this means that the immediate effect of a decrease in blood pH is to enhance oxygen delivery by the Bohr effect. If the acidosis is sustained (most causes of chronic metabolic acidosis are not associated with a need for enhanced oxygen delivery), diminished BPG synthesis leads to a decrease in intracellular BPG concentration, and hemoglobin's oxygen affinity returns toward normal (Figure 25.14). This system can respond appropriately to acute conditions, such as vigorous exercise, but when faced with a prolonged abnormality of pH, it readjusts to restore normal (and presumably optimal) oxygen delivery.

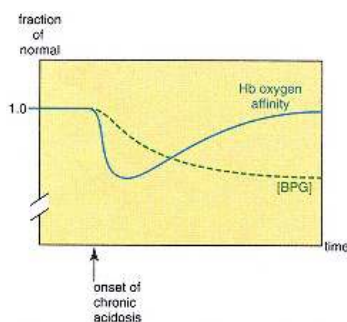

Figure 25.14

In chronic acidosis, BPG concentration decreases, returning hemoglobin's oxygen affinity toward normal.

This schematic diagram illustrates the rapid decrease in hemoglobin's oxygen affinity due to decreased pH. Lowering pH immediately lowers the activity of BPG mutase. In consequence, the concentration of BPG gradually diminishes as normal degradation proceeds. As BPG concentration diminishes, hemoglobin's oxygen affinity rises.

25.8—

Introduction to pH Regulation

We have noted the large amount of H⁺ generated by carbon dioxide transport, and we considered the ways in which the blood pH is controlled. This is important because changes in blood pH will affect intracellular pH, which in turn may profoundly alter metabolism. Protein conformation is affected by pH, as is enzyme activity. In addition, the equilibria of important reactions that consume or generate hydrogen ions, such as any of the oxidation–reduction reactions involving pyridine nucleotides, are shifted by changes in pH.

Normal arterial plasma pH is 7.40 ± 0.05 ; the pH range compatible with life is about 6.8–7.8. Intracellular pH varies with cell type; that of the erythrocyte is nearly 7.2, but that of most other cells is lower, about 7.0. Values as low as 6.0 have been reported for skeletal muscle.

It is fortunate for both diagnosis and treatment of diseases that the acid–base status of intracellular fluid influences and is influenced by the acid–base status of the blood. Blood is readily available for analysis, and when alteration of body pH becomes necessary, intravenous administration of acidifying or alkalinizing agents is efficacious.

25.9—

Buffer Systems of Plasma, Interstitial Fluid, and Cells

Each body water compartment is defined spatially by one or more differentially permeable membranes. Each contains characteristic kinds and concentrations

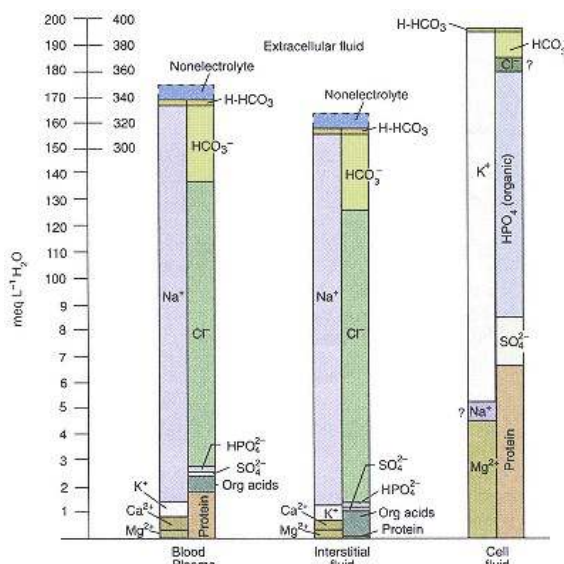

Figure 25.15

Chief chemical constituents of the three fluid compartments.

Height of left half of each column indicates total concentration of cations; that of right half, concentration of anions. Both are expressed in milliequivalents per liter (meq L^{-1}) of water. Note that chloride and sodium values in cell fluid are questioned. It is probable that, at least in muscle, the intracellular phase contains some sodium but no chloride.

Adapted from Gregersen, M. I. In: P. Bard (Ed.), *Medical Physiology*, 11th ed. St. Louis, MO: Mosby, 1961, p. 307.

of solutes, some of which are buffers in the physiological range of pH. Although the solutes in each type of cell are different, most cells are similar enough to be considered together for purposes of acid–base balance. Thus there are, from this point of view, three major body water components: plasma, within the circulatory system; interstitial fluid, the fluid that bathes the cells; and intracellular fluid.

The compositions of these fluids are given in Figure 25.15. In plasma the major cation is Na^+ ; small amounts of K^+ , Ca^{2+} , and Mg_2^+ are also present. The two dominant anions are HCO_3^- and Cl^- ; smaller amounts of protein, phosphate, and SO_4^{2-} are also present, along with a mixture of organic anions (amino acids, etc.), each of which would be insignificant if taken separately. The sum of the anions equals, of course, the sum of the cations. It is apparent at a glance that the composition of interstitial fluid is very similar. The major difference is that interstitial fluid contains much less protein than plasma contains (capillary endothelium is not normally permeable to plasma proteins) and, correspondingly, a lower cation concentration. Plasma and interstitial fluid together comprise the extracellular fluid, and low molecular weight components equilibrate fairly rapidly between them. For example, H^+ equilibrates between the plasma and interstitial fluid within about 1/2 h. The composition of intracellular fluid is strikingly different. The major cation is K^+ , while organic phosphates (ATP, BPG, glycolytic intermediates, etc.) and protein are the major anions.

TABLE 25.6 Acid Dissociation Constants of Major Physiological Buffers

Buffer System	pK
$\text{HCO}_3^-/\text{CO}_2$	6.1
Phosphate	
$\text{HPO}_4^{2-}/\text{H}_2\text{PO}_4^-$	6.7–7.2
Organic phosphate esters	6.5–7.6
Protein	
Histidine side chains	5.6–7.0
N-terminal amino groups	7.6–8.4

Because of these differences among the fluid compartments, each fluid makes a different contribution to buffering. The major buffer of extracellular fluid, for example, is the $\text{HCO}_3^-/\text{CO}_2$ system. Since its pK is 6.1 (Table 25.6 lists the major physiological buffers and their pK values), extracellular fluid at a pH of 7.4 is not very effective in resisting changes in pH arising from changes in P_{CO_2} changes. We have already seen the importance of buffering by hemoglobin and organic phosphates within erythrocytes. On the other hand, for reasons that will be explained

in Section 25.10, the bicarbonate buffer system is quite effective in controlling pH changes from causes other than changes in P_{CO_2} . Extracellular and intracellular fluids share almost equally in buffering strong organic or inorganic acids (see Table 25.7). Plasma is therefore an excellent indicator of the whole body's capacity to handle additional loads of these acids.

TABLE 25.7 Buffering of Metabolic Acids

Tissue	Buffering (%)
Extracellular fluids	42
Red cells	6
Tissue cells	52

Since acid–base imbalance arising from metabolic production of organic acids is common and potentially life-threatening, and since plasma is such a good indicator of the whole body's capacity to handle further metabolic acid loads, plasma composition is of major clinical concern. It is hydrogen ion concentration that must be kept within acceptable limits, but measuring pH alone is like walking on thin ice while observing merely whether or not you are still on the surface. Knowledge of $[\text{HCO}_3^-]$ tells you how close the ice is to the breaking point and how deep the water is underneath.

Because of the importance of the bicarbonate buffer system and its interaction with the other buffers of blood and other tissues, we will consider blood as a buffer in some detail. We will begin with a brief consideration of a model buffer.

Every buffer consists of a weak acid, HA, and its **conjugate base**, A^- . Examples of conjugate base/weak acid pairs are acetate⁻/acetic acid, $\text{NH}_3/\text{NH}_4^+$, and $\text{HPO}_4^{2-}/\text{H}_2\text{PO}_4^-$. Note that the weak acid may be neutral, positively charged, or negatively charged, and that its conjugate base must (since a H^+ has been lost) have one less positive charge (or one more negative charge) than the weak acid. The degree of ionization of a weak acid depends on the concentration of free hydrogen ions. This may be expressed in the form of the **Henderson–Hasselbalch equation** (derived on p. 9) as follows:

$$\text{pH} = \text{p}K + \log \frac{[\text{conjugate base}]}{[\text{acid}]}$$

This is a mathematical rearrangement of the fundamental equilibrium equation. It states that there is a direct relationship between pH and the ratio $[\text{conjugate base}]/[\text{acid}]$. It is important to realize that this ratio, not the absolute concentration of any particular species, is the factor that is related to pH. Use of this equation will help you to understand the operation of and to predict the effects of various alterations upon acid–base balance in the body.

Blood plasma is a mixed buffer system; in the plasma the major buffers are $\text{HCO}_3^-/\text{CO}_2$, $\text{HPO}_4^{2-}/\text{H}_2\text{PO}_4^-$, and protein/Hprotein. The pH is the same throughout the plasma, so each of these buffer pairs distributes independently according to its own Henderson–Hasselbalch equation, shown in Figure 25.16. Because each pair has a different pK, the $[\text{conjugate base}]/[\text{acid}]$ ratio is also different for each. Note, though, that if the ratio is known for any given buffer pair, information about the others can be calculated (assuming the pK values are known).

25.10— The Carbon Dioxide–Bicarbonate Buffer System

As we have seen, the major buffer of plasma and interstitial fluid is the **bicarbonate buffer system**. The bicarbonate system has two peculiar properties that make its operation unlike that of typical buffers. We will examine this important buffer in some detail, since a firm understanding of it is the key to a grasp of acid–base balance.

$$\begin{aligned} \text{pH} &= \text{p}K_1 + \log \frac{[\text{HCO}_3^-]}{[\text{CO}_2]} \\ &= \text{p}K_2 + \log \frac{[\text{HPO}_4^{2-}]}{[\text{H}_2\text{PO}_4^-]} \\ &= \text{p}K_3 + \log \frac{[\text{protein}^-]}{[\text{Hprotein}]} \end{aligned}$$

Figure 25.16
Some of the Henderson–Hasselbalch equations that are obeyed simultaneously in plasma.

The Chemistry of the System

The Equilibrium Expression Involves an Anhydride Instead of an Acid

In the first place, the component that we consider to be the acid in this buffer system is CO_2 , which is an acid anhydride, not an acid. It reacts with water to

CLINICAL CORRELATION 25.5

The Case of the Variable Constant

In clinical laboratories plasma pH and P_{CO_2} are commonly measured with suitable electrodes, and plasma $[\text{HCO}_3^-]$ is then calculated from the Henderson–Hasselbalch equation using $\text{p}K = 6.1$. Although this procedure is generally satisfactory, there have been several reports of severely erroneous results in patients whose acid–base status was changing rapidly.* Clinicians who are attuned to this phenomenon urge that direct measurements of all three variables be made in acutely ill patients.

The clinical literature discusses this problem in terms of departure of the value of $\text{p}K$ from 6.1. Studies of model systems suggest that this interpretation is incorrect; $\text{p}K$ does change with ionic strength, temperature, and so on, and so does α , but not enough to account for the magnitude of the clinical observations.

Astute commentators have speculated that the real basis of the phenomenon is disequilibrium. The detailed nature of the putative disequilibrium has not yet been established, but it is probably related to the difference in pH across the erythrocyte membrane. Normally, the pH of the erythrocyte is about 7.2, and the plasma pH is 7.4. If the plasma pH changes rapidly in an acute illness, the pH of the erythrocyte will also change, but the rate of change within the erythrocyte is not known. If the change within the erythrocyte lags sufficiently behind the change in the plasma, the system would indeed be in gross disequilibrium, and equilibrium calculations would not apply.

*See Hood, I., and Campbell, E. J. M. *N Engl. J. Med.* 306:864, 1982.

form carbonic acid, which is indeed a typical weak acid:

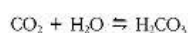

Carbonic acid rapidly ionizes to give H^+ and HCO_3^- :

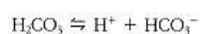

If these two equations are added, H_2CO_3 cancels out, and the sum is

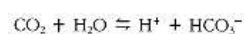

Elimination of H_2CO_3 from formal consideration is realistic, since not only does it simplify matters, but H_2CO_3 is, in fact, quantitatively insignificant. Because the equilibrium of the reaction,

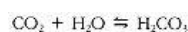

lies far to the left, H_2CO_3 is present only to the extent of 1/200 of the concentration of dissolved CO_2 . Since the concentration of H_2O is virtually constant, it need not be included in the equilibrium expression for the reaction, and we may write:

$$K = \frac{[\text{H}^+][\text{HCO}_3^-]}{[\text{CO}_2]}$$

The value of K is 7.95×10^{-7} .

The concentration of a gas in solution is proportional to its partial pressure. Thus we measure partial pressure of CO_2 (P_{CO_2}) multiplied by a **conversion factor**, α , gives the millimolar concentration of dissolved CO_2 .

$$\alpha P_{\text{CO}_2} = \text{meq L}^{-1}$$

α has a value of $0.03 \text{ meq L}^{-1} \text{ mmHg}^{-1}$ (or $0.225 \text{ meq L}^{-1} \text{ kPa}^{-1}$) at 37°C . The equilibrium expression thus becomes

$$K = \frac{[\text{H}^+][\text{HCO}_3^-]}{0.03 \cdot P_{\text{CO}_2}}$$

and the Henderson–Hasselbalch equation for this buffer system becomes

$$\text{pH} = 6.1 + \log \frac{[\text{HCO}_3^-]}{0.03 \cdot P_{\text{CO}_2}}$$

with $[\text{HCO}_3^-]$ expressed in units of meq L^{-1} (see Clin. Corr. 25.5).

The Carbon Dioxide–Bicarbonate Buffer System Is an Open System

We said earlier that the bicarbonate buffer system, with a $\text{p}K$ of 6.1, is not effective against carbonic acid in the pH range of 7.8–6.8 but is effective against noncarbonic acids. The usual rules of chemical equilibrium dictate that a buffer is not very useful in a pH range more than about one unit beyond its $\text{p}K$. Thus we need to explain how the bicarbonate system can be effective against noncarbonic acids; its failure to buffer carbonic acid is expected. The way it buffers noncarbonic acids in a pH range far from its $\text{p}K$ is the second unusual property of this buffer system. Note that the explanation of this property in the following paragraph involves the flow of materials in a living system, and so departs from mere equilibrium considerations.

Consider first a typical buffer, consisting of a mixture of a weak acid and its conjugate base. When a strong acid is added, most of the added H^+ combines with the conjugate base. As a result, $[\text{weak acid}]$ increases and simultaneously $[\text{conjugate base}]$ diminishes. The ratio $[\text{conjugate base}]/[\text{weak acid}]$ changes, and so does the pH, but much less than if there were no buffer present. Now imagine that the weak acid, as it is generated by reaction of added strong acid with conjugate base, is somehow removed so that while $[\text{conjugate base}]$ diminishes, $[\text{weak acid}]$ remains nearly constant. In this case the ratio of $[\text{conjugate base}]/[\text{weak acid}]$ would change much less for a given addition of strong acid, and the pH would also change much less. This is exactly what happens with the body's bicarbonate buffer system. As strong acid is added, $[\text{HCO}_3^-]$

diminishes and CO_2 is formed. But the excess CO_2 is exhaled, so that the ratio of P_{CO_2} changes strikingly, and the bicarbonate system would be relatively ineffective, in keeping with the prediction of chemical equilibrium.

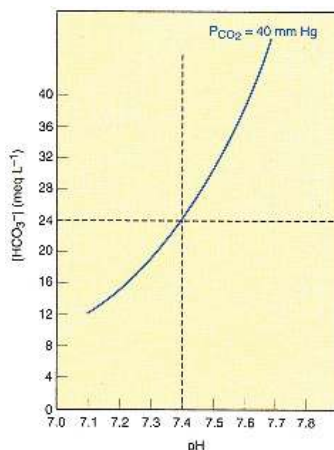

Figure 25.17
pH-Bicarbonate diagram including the 40-mmHg (5.33-kPa) CO_2 isobar, and showing the normal values of plasma pH and bicarbonate ion concentration.

Graphical Representation: The pH-Bicarbonate Diagram

A graphical representation of the Henderson-Hasselbalch equation for the bicarbonate buffer system assists in learning and understanding how this system reflects the body's acid-base status. A common representation is the **pH-bicarbonate diagram**, shown in Figure 25.17. $[\text{HCO}_3^-]$ up to 40 meq L^{-1} is shown on the ordinate; enough to deal with most situations. Since plasma pH does not exceed 7.8 or (except transiently) fall below 7.0 in living patients, the abscissa is limited to 7.0–7.8. The normal plasma $[\text{HCO}_3^-]$, 24 meq L^{-1} , and the normal plasma pH, 7.4, are indicated. The third variable, CO_2 , can be shown on a two-dimensional graph by assigning a fixed value to P_{CO_2} ; is 40 mmHg (5.33-kPa), pH and $[\text{HCO}_3^-]$ must be somewhere on that line.

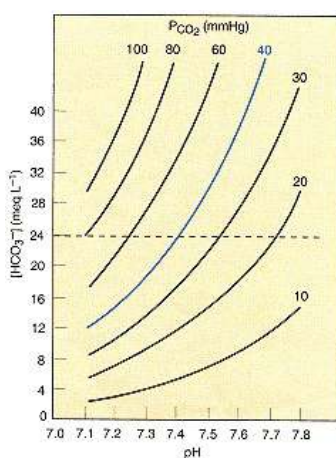

Figure 25.18
pH-Bicarbonate diagram showing CO_2 isobars from 10 to 100 mmHg.

Similarly, we can plot isobars for various abnormal values of P_{CO_2} (Figure 25.18). The range of values given covers those found in patients. Any point on the graph gives the values of the three variables of the Henderson-Hasselbalch equation for the bicarbonate system at that point. Since only two variables are needed to locate a point, the third can be read directly from the graph.

Let us now see how the bicarbonate buffer system behaves when it is in the presence of other buffers, as it is in whole blood. First, let us acidify the system by increasing the concentration of the acid-producing component, CO_2 . For every CO_2 that reacts with water to produce a H^+ , one HCO_3^- forms. Most of the H^+ , however, is buffered by protein and phosphate. As a result, $[\text{HCO}_3^-]$ rises much more than $[\text{H}^+]$. Similarly, if acid is removed from this system by decreasing P_{CO_2} is the only variable that is changed, the response of the system is confined to movements along this line.

The slope of the buffering line depends on the concentration of the nonbicarbonate buffers. If they were more concentrated, they would better resist changes in pH. An increase in P_{CO_2} to 80 mmHg (10.7 kPa) would then cause a smaller drop in pH, and since the more concentrated buffers would react with more hydrogen ions (produced by the ionization of carbonic acid), $[\text{HCO}_3^-]$ would rise higher. Thus the slope of the buffering line would be steeper.

Hemoglobin is quantitatively the second most important blood buffer, exceeded only by the bicarbonate buffer system. Since hemoglobin concentration in the blood can fluctuate widely in various disease states, it is the most important physiological determinant of the slope of the blood buffer line. Figure 25.20 shows how this slope varies with hemoglobin concentration.

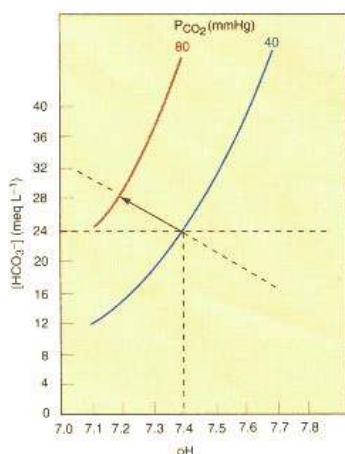

Figure 25.19

The buffering line of blood.

This pH–bicarbonate diagram shows the changes in pH that occur in whole blood in vitro when P_{CO_2} is changed. Note that the relationship between pH and $[\text{HCO}_3^-]$ is described by a straight line with a nonzero slope.

Having now seen how the bicarbonate buffer system in blood responds to changes in P_{CO_2} , are represented by points confined to the CO₂ isobar.

The effects on blood of changing P_{CO_2} or of adding acid or alkali, as we have just described, are realistic qualitative models of what happens in certain disease states. We next see how these changes occur in the body and how the body compensates for them.

**25.11—
Acid–Base Balance and Its Maintenance**

It should come as no surprise that mechanisms exist whereby the body normally rids itself of excess acid or alkali. The physiological implication is that if a patient is in a state of continuing **acidosis** (excess acid or deficiency of alkali in the body) or **alkalosis** (excess alkali or deficiency of acid in the body), there must be a continuing cause of the imbalance. In such a situation the body's first task is to somehow compensate so plasma pH does not exceed the limits compatible with life. Assistance from the physician is sometimes necessary. The body's second task is to eliminate the primary cause of the imbalance, that is, to cure the disease, so that a normal acid–base status can be reestablished. Again, intervention by the physician may be needed.

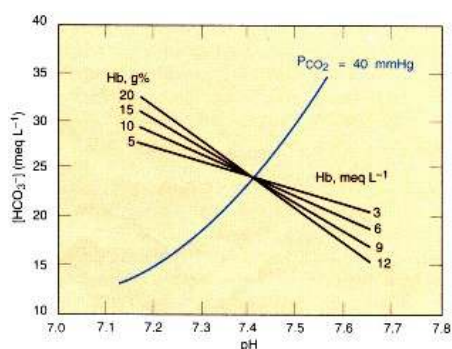

Figure 25.20

Slope of the buffering line of blood as it varies with hemoglobin concentration.

From Davenport, H. W. *The ABC of Acid–Base Chemistry*, 6th ed. revised. Chicago: University of Chicago Press, 1974, p. 55.

CLINICAL CORRELATION 25.6**The Role of Bone in Acid–Base Homeostasis**

The average adult skeleton contains 50,000 meq of Ca^{2+} in the form of salts that are alkaline relative to the pH of plasma. In chronic acidosis this large reservoir of base is drawn upon to help control the plasma pH. Thus people with chronic kidney disease and severely impaired renal acid excretion do not experience a continuous decline in plasma pH and $[\text{HCO}_3^-]$. Rather, the pH and $[\text{HCO}_3^-]$ stabilize at some below-normal level. The resulting change in bone composition is not inconsequential, and clinical and roentgenologic evidence of rickets or osteomalacia often appear. Bone healing has been shown in these patients after prolonged administration of alkali in the form of sodium bicarbonate or citrate sufficient to restore plasma $[\text{HCO}_3^-]$.

Lemann, J. Jr. and Lennon, E. J. Kidney Int. 1:275, 1972.

All individuals, in sickness or in health, produce large amounts of acids every day. The major acid is CO_2 , the amount depending on the individual's caloric expenditure, and ranging between 12,500 and nearly 50,000 meq day^{-1} . In an average young adult male, about 22,000 meq of CO_2 are produced daily. This acid is volatile and is normally excreted by the lungs. Inability of the lungs to do this adequately leads to **respiratory acidosis** or alkalosis. Respiratory acidosis is the result of hypoventilation of the alveoli, so that CO_2 accumulates in the body. Alveolar hypoventilation occurs when the depth or rate of respiration diminishes. Airway obstruction, neuromuscular disorders, and diseases of the central nervous system are common causes of acute respiratory acidosis. Chronic respiratory acidosis is seen in patients with chronic obstructive lung disease, such as emphysema. Obviously, since the common element in all these conditions is increased alveolar P_{CO_2} , would also cause respiratory acidosis.

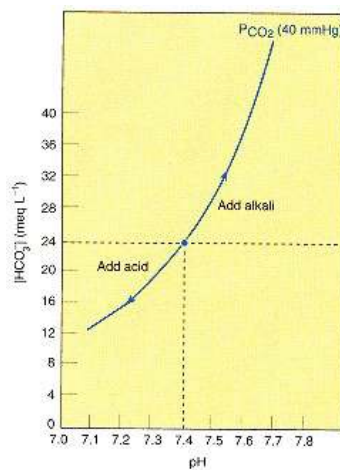

Figure 25.21
Effect of adding noncarbonic acid or alkali to whole blood with P_{CO_2} fixed at 40 mmHg.

Respiratory alkalosis, on the other hand, arises from decreased alveolar P_{CO_2} also falls, producing chronic respiratory alkalosis.

Nonvolatile acids are also produced by the body. The diet and physiological state of the individual determine the kinds and amounts of these acids. Oxidation of sulfur-containing amino acids produces H^+ and SO_4^{2-} , the equivalent of sulfuric acid. Hydrolysis of phosphate esters is equivalent to the formation of phosphoric acid. The contribution of these processes depends on the amount of acid precursors ingested; on an average American diet, net acid production is about 60 meq day^{-1} .

Metabolism normally produces lactic acid, acetoacetic acid, and β -hydroxybutyric acid. In some physiological or pathological states these are produced in excess, and accumulation of the excess causes acidosis. When an ammonium salt of a strong acid, such as ammonium chloride or lysine hydrochloride is administered, it is converted to urea, and the corresponding strong acid (HCl) is synthesized. Ingestion of salicylates, methyl alcohol, or ethylene glycol results in production of strong organic acids. Accumulation of any of these nonvolatile acids leads to **metabolic acidosis**.

While it is obvious that excess acid production can cause acidosis, the same net effect can arise from abnormal loss of base, as predicted from the Henderson-Hasselbalch equation for the bicarbonate buffer system. Renal tubular acidosis is a condition in which this occurs. Abnormal amounts of HCO_3^- escape from the blood into the urine, leaving the body acidotic (see Clin. Corr. 25.6). A more common cause of bicarbonate depletion is severe diarrhea. In this chapter it will be assumed that kidney function is normal.

Mammals do not synthesize alkaline compounds from neutral starting materials. **Metabolic alkalosis** therefore arises from intake of excess alkali or abnormal loss of acid. A commonly ingested alkali is sodium bicarbonate. A less obvious source of alkali is the salt of any metabolizable organic acid. Sodium lactate is often administered to combat acidosis; normal metabolism converts it to sodium bicarbonate. The net reaction is as follows:

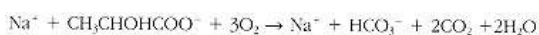

Most dietary fruits and vegetables have a net alkalizing effect on the body for this reason. They contain a mixture of organic acids, which are metabolized to CO_2 and H_2O , and therefore have no long-term effect on acid–base balance, and salts of organic acids, which give rise to bicarbonate. Abnormal loss of acid, as occurs in prolonged vomiting or gastric lavage, causes alkalosis. Alkalosis may also be produced by rapid loss of body water, as in diuresis, which may temporarily increase $[\text{HCO}_3^-]$ in the plasma and extracellular fluid. Table 25.8 summarizes the causes of acid–base imbalances.

The Kidney Plays a Critical Role in Acid-Base Balance

Excess nonvolatile acid and excess bicarbonate are excreted by the kidney. As a result, urine pH varies as a function of the body's need to excrete these materials. For an individual on a typical American diet, urine pH is about 6, indicating a net acidification as compared to plasma. This is consistent with our knowledge that the typical diet results in a net production of acid. Urine pH can range from 4.4 to 8.0.

A typical daily urine volume is about 1.2 L. At the minimum urine pH of 4.4, $[H^+]$ is only 0.04 meq L^{-1} , and it would take 1250 L of urine to excrete 50 meq of acid as free hydrogen ions. Clearly, most of the acid we excrete must be in a form other than H^+ . A form that can be excreted in a reasonable concentration, such as $H_2PO_4^-$ or NH_4^+ , is needed.

TABLE 25.8 Causes of Acid-Base Imbalance Summarized

Acidosis
Respiratory
Alveolar hypoventilation
Metabolic
H^+ overproduction
HCO_3^- overexcretion
Alkalosis
Respiratory
Alveolar hyperventilation
Metabolic
Alkali ingestion
H^+ overexcretion

Urine Formation Occurs Primarily in the Nephron

Let us now see how the kidney accomplishes the excretion of acid or base. Figure 25.22 shows the fundamental functioning unit of the kidney, a nephron. Each human kidney contains at least a million, which first filter the blood and then modify the filtrate into urine.

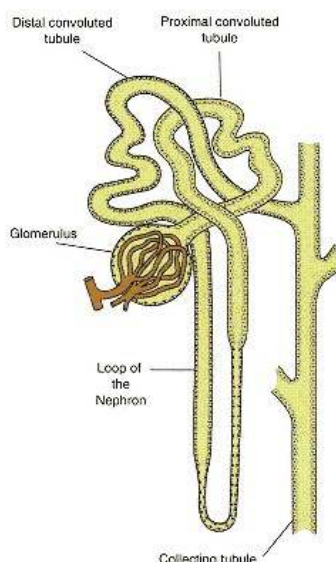

Figure 25.22
Essential features of a typical nephron in the human kidney.
Reprinted with permission from Smith, H. W. *The Physiology of the Kidney*. London: Oxford University Press, 1937, p. 6.

Filtration occurs in the glomerulus, a tuft of capillaries enclosed by an epithelial envelope called the glomerular capsule (formerly Bowman's capsule). Water and low molecular weight solutes, such as inorganic ions, urea, sugars, and amino acids (but not normally substances with molecular weights above 70,000, such as plasma proteins), pass from these capillaries into the capsular space. This ultrafiltrate of plasma then passes through the proximal convoluted tubule, where most of the water and solutes are reabsorbed. The tubule fluid continues through the loop of the nephron (loop of Henle) and through the distal convoluted tubule, where further reabsorption of some solutes or secretion of others occurs. The tubule fluid then passes into the collecting tubule, where additional concentration can occur if necessary. The fluid may now be called urine; it contains 1% or less of the water and solutes of the original glomerular filtrate.

The kidney regulates acid–base balance by controlling bicarbonate reabsorption and by secreting acid. Both processes depend on formation of H^+ and HCO_3^- from CO_2 and H_2O within the tubule cells, shown in Figure 25.23a. The H^+ formed in this reaction is actively secreted into the tubule fluid in exchange for Na^+ . Na^+ uptake by the tubule cell is partly passive, with Na^+ flowing down the electrochemical gradient, and partly active, via a Na^+ , H^+ -antiport system. At this point Na^+ has been reabsorbed in exchange for H^+ , and sodium bicarbonate has been generated within the tubule cell. The sodium bicarbonate is then transported out of the cell into the interstitial fluid, which equilibrates with the plasma.

The Three Fates of Excreted H^+

The H^+ that has been secreted into the tubule fluid can now experience one of three fates. First, it can react with a HCO_3^- , as shown in Figure 25.23b, to form CO_2 and H_2O . The overall net effect of this process is to move sodium bicarbonate from the tubule fluid back into the interstitial fluid. The name given to this is **reabsorption of sodium bicarbonate**.

As reabsorption of sodium bicarbonate proceeds, the tubule fluid becomes depleted of HCO_3^- , and the pH drops from its initial value, which was identical to the pH of the plasma from which it was derived. As HCO_3^- becomes less available and the pH comes closer to the pK of the $HPO_4^{2-}/H_2PO_4^-$ buffer system, more and more of the H^+ will be taken up by this buffer. **Buffering** is the second fate of H^+ , represented in Figure 25.23c. $H_2PO_4^-$ is not readily reabsorbed by the kidney. It passes out in the urine, and its loss represents net excretion of H^+ .

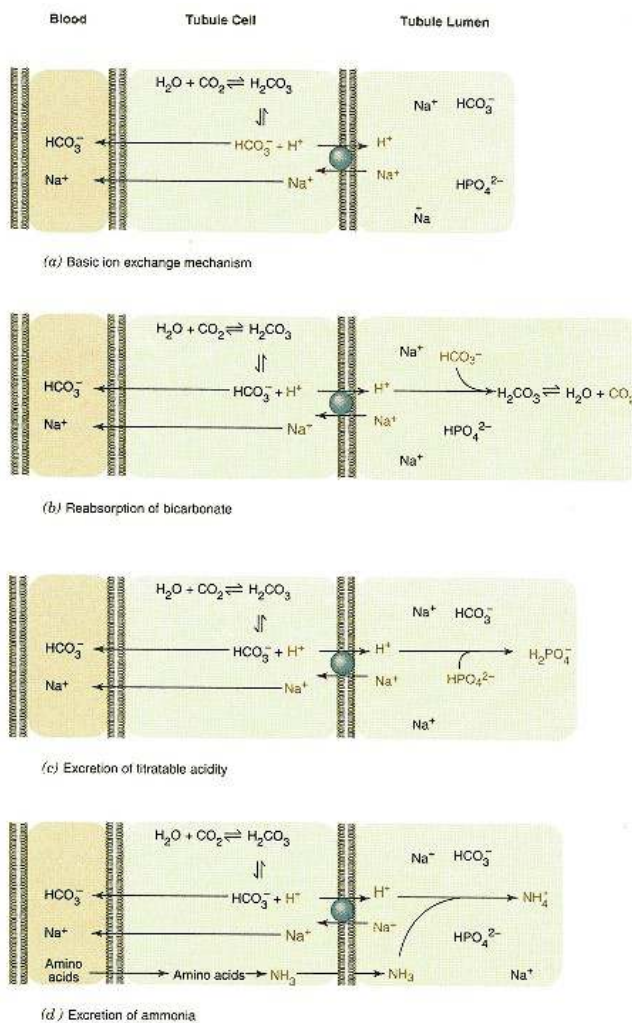

Figure 25.23

Role of the exchange of tubular cell H^+ ions in tubular fluid in renal regulation of acid–base balance.

- (a) Basic ion exchange mechanism
 (b) Reabsorption of bicarbonate.
 (c) Excretion of titratable acid.
 (d) Excretion of ammonia.

Adapted from Pitts, R. E. *N. Engl. J. Med.* 284:32, 1971, with permission of the publisher.

Although phosphate is normally the most important buffer in the urine, other ions can become significant. For example, in diabetic ketoacidosis, plasma levels of acetoacetate and β -hydroxybutyrate are elevated. These pass into the glomerular filtrate and appear in the tubule fluid. Since acetoacetic acid has a $pK = 3.6$ and β -hydroxybutyric acid has a $pK = 4.7$, as the urine pH approaches its minimum of 4.4, these begin to serve as buffers.

The effect of buffering is not only to excrete acid but to regenerate the bicarbonate that was lost when the acid was first neutralized. Let us consider a situation in which the metabolic defect of a diabetic patient has produced the elements of β -hydroxybutyric acid. The protons are neutralized by sodium

bicarbonate, leaving sodium β -hydroxybutyrate. In the kidney, then, β -hydroxybutyrate appears in the filtrate, it is converted to β -hydroxybutyric acid, which is excreted, and sodium bicarbonate returns to the extracellular fluid. Net acid excretion and bicarbonate regeneration occur no matter what anion in the tubule fluid acts as the H^+ acceptor.

The amount of acid excreted as the acid component of a urinary buffer is measured by titrating the urine back to the normal pH of the plasma, 7.4. The amount of base required is identical to the amount of acid excreted in this form and is called the **titratable acidity** of the urine.

The formation of titratable acidity accounts for about one-third to one-half of our normal daily acid excretion. It is thus an important mechanism for acid excretion and can put out as much as 250 meq of acid daily. There is, however, a limit to the amount of acid that can be excreted in this manner. Titratable acidity can be increased only by lowering the pH of the urine or by increasing the concentration of buffer in the urine, and neither of these processes can proceed indefinitely. The urine pH cannot go below about 4.4; evidently the Na^+/H^+ exchange mechanism is incapable of pumping H^+ out of the tubule cells against more than a 1000-fold concentration gradient. Buffer excretion is limited not only by the solubility of the buffer, but by limitations to the supply of the buffer ion and of the cations that are necessarily part of the important buffer systems. If a 600 meq day^{-1} of acid were excreted as NaH_2PO_4 , the body would be totally depleted of sodium in less than one week.

The third fate that H^+ can experience in the tubule fluid is neutralization by NH_3 . Tubule cells produce NH_4^+ from amino acids, particularly glutamine, as shown in Figure 25.23d. **Elimination of NH_4^+** in the urine contributes to net acid excretion.

NH_4^+ is normally a major urinary acid. Typically, one-half to two-thirds of our daily acid load is excreted as NH_4^+ . For three reasons it becomes even more important in acidosis. In the first place, since the pK of NH_4^+ is 9.3, acid can be excreted in this form without lowering the pH of the urine, whereas formation of titratable acidity requires a decrease in urine pH. Second, enormous amounts of acid can be excreted in this form. Ammonia is readily available from amino acids, and in prolonged acidosis the NH_4^+ excretion system becomes activated. This activation, however, takes several days; it does not begin to adapt until after 2–3 days, and the process is not complete until 5–6 days after the onset of acidosis. Once complete, though, amounts of acid in excess of 500 meq can be excreted daily as NH_4^+ . The third role of NH_4^+ in acidosis is that it spares the body's stores of Na^+ and K^+ . Excretion of titratable acid, such as $H_2PO_4^-$, and of the anions of strong acids, such as acetate, requires simultaneous excretion of a cation to maintain electrical neutrality. At the onset of acidosis this is Na^+ , but as the body's Na^+ stores become depleted, K^+ excretion rises. If NH_4^+ were not available, even a moderate acidosis could quickly become fatal.

Total Acidity of the Urine

Total acid excretion, the **total acidity of the urine**, is the sum of titratable acidity and NH_4^+ . Strictly speaking, we should subtract from this sum the urinary HCO_3^- , but this is seldom done in practice, since in severe metabolic acidosis, where the total acid excretion would be of greatest interest, the urine would be so acidic that $[HCO_3^-]$ would be nil.

In alkalosis the kidney's role is simply to allow HCO_3^- to escape. Metabolic alkalosis is therefore seldom long-lasting unless alkali is continuously administered or HCO_3^- elimination is somehow prevented. HCO_3^- elimination may be restricted if the kidney receives a strong signal to conserve Na^+ at a time when there is a deficiency of an easily reabsorbable anion, such as Cl^- , to be reabsorbed with it. Some diuretics cause this. The first renal response is to put out K^+ in exchange for Na^+ from the tubule fluid. When K^+ stores are depleted, H^+ is exchanged for Na^+ . This results in the production of an acidic urine by

an alkalotic patient. If NaCl is administered, alkalosis associated with volume and Cl⁻ depletion may correct itself.

25.12—

Compensatory Mechanisms

We have defined four primary types of acid–base imbalances and we have seen their chemical causes. Respiratory acidosis arises from an increased plasma P_{CO_2} . In metabolic acidosis addition of strong organic or inorganic acid (or loss of HCO₃⁻) results in decreased plasma [HCO₃⁻]. Conversely, in metabolic alkalosis loss of acid from the body or ingestion of alkali raises the plasma [HCO₃⁻]. Recall that in an acute respiratory acid–base imbalance, as long as there is no attempt to compensate, pH will be abnormal, and [HCO₃⁻] will be somewhere on the buffer line. In an acute metabolic acid–base imbalance, if there is no attempt to compensate, pH will be abnormal and [HCO₃⁻] will be somewhere on the 40-mmHg (5.33-kPa) isobar.

Principles of Compensation

When the plasma pH deviates from the normal range, various compensatory mechanisms begin to operate. The general principle of compensation is that, since an abnormal condition has directly altered one term of the [HCO₃⁻]/[CO₂] ratio, plasma pH can be readjusted back toward normal by a compensatory alteration of the other term. For example, if a diabetic patient becomes acidotic due to excess production of ketone bodies, plasma [HCO₃⁻] will decrease. Compensation would involve decreasing plasma [CO₂] so that the [HCO₃⁻]/[CO₂] ratio, and therefore the pH, is readjusted back toward normal. Note that compensation does not involve a return of [HCO₃⁻] and [CO₂] toward normal. Rather, compensation is a secondary alteration in one of these that counteracts the primary alteration in the other. The result is that the plasma pH is readjusted toward normal. That this is necessarily so is evident from the Henderson–Hasselbalch equation.

$$\text{pH} = 6.1 + \log \frac{[\text{HCO}_3^-]}{0.03 \cdot P_{\text{CO}_2}}$$

If [HCO₃⁻] changes, the only way to restore the original [HCO₃⁻]/[CO₂] ratio is to change P_{CO_2} , the original ratio can be restored only by altering [HCO₃⁻] in the same direction.

The Three States of Compensation Defined

Although some compensatory mechanisms begin to operate rapidly and produce their effects rapidly, others are slower and show stages of compensation. First is the acute stage, before any significant degree of compensation could possibly occur. After the acid–base imbalance has been in effect for a period of time the patient may become **compensated**. This means the compensatory mechanisms have come into play in a normal manner, as expected on the basis of experience with other individuals with an acid–base imbalance of similar type and degree. The "compensated state" does not necessarily imply that the plasma pH is within the normal range. Alternatively, the patient may show no sign of compensation and may be in the **uncompensated** state; this occurs because compensation cannot occur due to some other abnormality. Finally, there is an intermediate state where compensation is occurring but is not yet as complete as it should be. This is the **partially compensated** state. Factors that limit the compensatory processes will be discussed at the end of this section.

Specific Compensatory Processes

Respiratory Acidosis

Let us now follow the course of acute onset of each type of acid–base imbalance and of the compensatory process. Each of these will be schematically illustrated in a pH–bicarbonate diagram. Imagine an individual in normal acid–base balance who goes into acute respiratory acidosis from breathing a gas mixture containing a high level of CO_2 . As P_{CO_2} will occur. The abnormal condition has fixed this patient on an abnormally high CO_2 isobar. If the condition is returned to normal, he/she can drop back to the 40-mmHg (5.33-kPa) isobar and all will be well, but until that time all compensatory processes are confined to the higher CO_2 isobar.

Compensation, of course, consists of renal excretion of H^+ . Since this is a bicarbonate-producing process, $[\text{HCO}_3^-]$ should rise, even though it is already above normal. This could have been predicted from the pH– HCO_3^- diagram with no knowledge of the renal mechanism of compensation. Since it is assumed that the individual is fixed on the high CO_2 isobar by the abnormal condition, the only way the pH can possibly be adjusted toward normal is by sliding up the isobar to point *B* in Figure 25.24. This movement is necessarily linked to an increase in $[\text{HCO}_3^-]$. Thus the correct analysis of this compensation could be made either from an understanding of the nature of the compensatory mechanism or from an appreciation of the physical chemistry of the bicarbonate buffer system as expressed in the pH– HCO_3^- diagram.

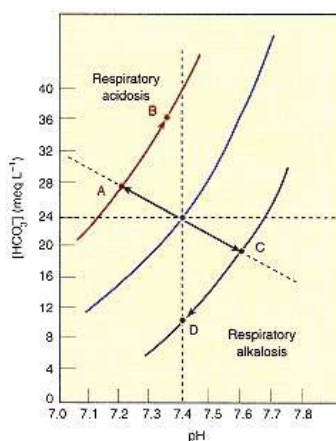

Figure 25.24
pH–Bicarbonate diagram
showing compensation for respiratory
acidosis (normal state to point *B*) and for
respiratory alkalosis (normal state to point *D*).

Although the path we have described, up the buffer line to point *A* and then up the isobar to point *B*, is a real possibility, it is also possible that a respiratory acidosis would develop gradually, with compensation occurring simultaneously. The points describing this progress would fall on a curved line from the normal state to point *B*.

Respiratory Alkalosis

In sudden onset respiratory alkalosis (P_{CO_2}), and the plasma pH

CLINICAL CORRELATION 25.7

Acute Respiratory Alkalosis

An anesthetized surgical patient with a urethral catheter in place was hyperventilated as an adjunct to the general anesthesia. Prior to hyperventilation normal values of plasma P_{CO_2} was 25 mmHg and the pH was 7.55. Plasma HCO_3^- was not directly measured, but interpolation from a pH–bicarbonate diagram (e.g., Figure 25.17) or calculation from the Henderson–Hasselbalch equation reveals that the plasma $[\text{HCO}_3^-]$ decreased to 21.2 meq L^{-1} . Analysis of the urine showed negligible loss of HCO_3^- through the kidneys. It can be concluded that the decrease in $[\text{HCO}_3^-]$ was due to titration of bicarbonate by the acid components of the body's buffer systems. The point representing the patient's new steady-state condition clearly must be on the buffering line that represents whole body buffering. (Since the buffers of the whole body are not identical in type or concentration to the blood buffers, the buffer line for the whole body will be analogous, but not identical, to the blood buffer line.)

Magarian, G. J. *Medicine*(Baltimore) 61:219, 1982.

CLINICAL CORRELATION 25.8**Chronic Respiratory Acidosis**

H.W. was admitted to the hospital with marked dyspnea, cyanosis, and signs of mental confusion. As his acute problems were relieved by appropriate treatment, his symptoms disappeared except for a continuing dyspnea. Blood gas analysis performed eight days later yielded the following data: pH, 7.32; P_{CO_2} , 70 mmHg; $[\text{HCO}_3^-]$, 34.9 meq L⁻¹. This is a typical compensation for this degree of chronic respiratory acidosis.

Another patient, C.Q., with chronic obstructive lung disease was found to have arterial plasma pH, 7.40; $[\text{HCO}_3^-]$, 35.9 meq L⁻¹; and P_{CO_2} of 60 mmHg, a plasma pH of 7.4 lies outside the 95% probability range. Close questioning of the patient revealed that he had surreptitiously been taking a relative's thiazide diuretic, which superimposed a metabolic alkalosis upon respiratory acidosis.

Rastegar, A., and Thier, S. O. *Chest* 63:355, 1972.

decreases toward normal. This is described in Figure 25.24 by movement along the isobar from point C to point D. With a gradual onset of respiratory alkalosis, the bicarbonate buffer system would follow points along the curved line from the normal state to point D.

Metabolic Acidosis

In metabolic acidosis two mechanisms are usually available for dealing with the excess acid. One is that kidneys increase their H⁺ excretion, but this is slow and inadequate to return $[\text{HCO}_3^-]$ and pH to normal. The other, which begins to operate almost instantly, is respiratory compensation. Acidosis stimulates the respiratory system to hyperventilate, decreasing the P_{CO_2} but also a further small decrease in $[\text{HCO}_3^-]$. This is due to the same factor that causes the buffer line to have a slope: titration of nonbicarbonate buffers. The inevitability and magnitude of the further decrease in $[\text{HCO}_3^-]$ can be seen clearly in the pH–bicarbonate diagram.

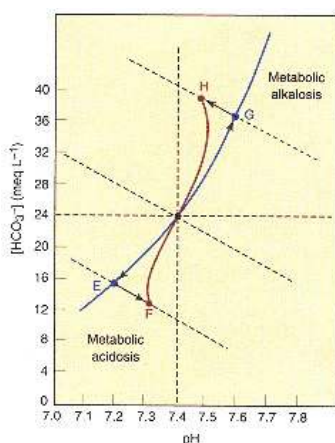

Figure 25.25
pH–Bicarbonate diagram showing compensation for metabolic acidosis (normal state to point F) and for metabolic alkalosis (normal state to point H).

Metabolic Alkalosis

The principles governing compensation for metabolic alkalosis are like those for metabolic acidosis, but operate in the opposite direction. In metabolic alkalosis the primary defect is an increase in plasma $[\text{HCO}_3^-]$; it rises from the normal state to point G in Figure 25.25. The immediate physiological response is hypoventilation, followed by increased renal excretion of HCO_3^- . As a result of hypoventilation P_{CO_2} increases along the line from G to H, and a further small rise in $[\text{HCO}_3^-]$ occurs.

The respiratory response to metabolic acid–base imbalance is rapid, and the bicarbonate buffer system would in most cases be expected to follow points along the curved line from the normal state to the compensated state. An acute metabolic imbalance will not generally be seen outside the experimental laboratory. Indeed, if a physician sees a patient whose plasma pH, $[\text{HCO}_3^-]$, and P_{CO_2} would be abnormal.

How complete can compensation be? Can the body totally compensate (bring the pH back to the normal range) for any imbalance? Generally, the answer is no. The compensatory organs, the lungs and kidneys, do not exist exclusively to deal with acid–base imbalance. There is a limit to how much one can hyperventilate; it is simply impossible to move air into and out of the lungs at an indefinitely high rate for an indefinitely long time. Also, one cannot suspend respiration merely to raise P_{CO_2} , rises above 70 mmHg (9.33 kPa) in respiratory acidosis, renal mechanisms for reabsorbing HCO_3^- fail to keep pace, and further increases in plasma $[\text{HCO}_3^-]$ are only about what could be expected from titration of nonbicarbonate buffers (see Clin. Corr. 25.8). In respiratory alkalosis renal excretion of excess HCO_3^- can, with time, be sufficient to return plasma pH to within the normal range. Individuals who dwell at high altitude are typically

CLINICAL CORRELATION 25.9

Salicylate Poisoning

Salicylates are the most common cause of poisoning in children. A typical pathway of salicylate intoxication is plotted in the accompanying figure. The first effect of salicylate overdose is stimulation of the respiratory center, resulting in respiratory alkalosis. Renal compensation occurs, lowering the

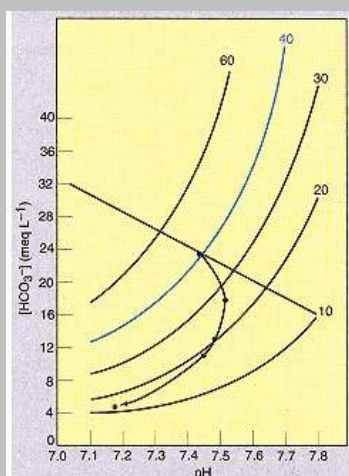

A typical pathway of salicylate intoxication.
Data replotted from Singer, R. B. *Medicine*
(Baltimore) 33:1, 1954.

plasma $[\text{HCO}_3^-]$. A second, delayed effect of salicylate may then appear, metabolic acidosis. Since $[\text{HCO}_3^-]$ had been lowered by the previous compensatory process, the victim is at a particular disadvantage in dealing with the metabolic acidosis. In addition, but not shown in the graph, respiratory stimulation sometimes persists after the acidosis has run its course. Rational management of salicylate intoxication requires knowledge of the plasma pH and the plasma $[\text{HCO}_3^-]$ or its equivalent throughout the course of the condition.

in compensated respiratory alkalosis, with their plasma pH within the normal range. For the other types of acid–base imbalance, the exact degree of compensation expected of a patient with a given clinical picture is well worked out, but a detailed discussion is beyond the scope of this chapter. Suffice it to say that if a patient is compensating, but not as well as expected, this is taken to mean that the patient cannot compensate appropriately and must therefore have a mixed acid–base disturbance.

25.13—

Alternative Measures of Acid–Base Imbalance

Modern clinical laboratories generally report plasma bicarbonate concentration, and the value is used by physicians just as we have used it here. Some laboratories, however, report **total plasma CO_2** , that is, the sum of bicarbonate and dissolved CO_2 , and this is always slightly higher than $[\text{HCO}_3^-]$. At pH 7.4, for example, the ratio of $[\text{HCO}_3^-]$ to $[\text{CO}_2]$ is 20 : 1 (dissolved CO_2 is only 1 : 21 of the total CO_2); if $[\text{HCO}_3^-]$ is 24 meq L^{-1} , $[\text{CO}_2]$ is 1.2 meq L^{-1} and total CO_2 is 25.2 meq L^{-1} . At pH 7.1, HCO_3^- is still 10 times as concentrated as dissolved CO_2 . Because the major contributor to total CO_2 is HCO_3^- , total CO_2 is often used in the same manner as bicarbonate to make clinical judgments. Strictly speaking, total CO_2 also includes that in carbamino proteins, but current clinical laboratory practice is to ignore this when making a blood gas and pH report. If it were included in a total CO_2 measurement, it would not change the interpretation of the measurement, since the CO_2 in carbamino proteins, like dissolved CO_2 , represents only a small fraction of the total CO_2 .

The clinical importance of bicarbonate as a gauge of the whole body's ability to buffer further loads of metabolic acid (see Clin. Corr. 25.9) has led to several ways of expressing what the $[\text{HCO}_3^-]$ would be if there were no respiratory component or respiratory compensation involved in a patient's condition. **Base excess** is one of these expressions. It is defined as the amount of acid that would have to be added to blood to titrate it to pH 7.4 at a P_{CO_2} , only the metabolic contribution to acid–base imbalance (primary metabolic imbalance and nonrespiratory compensatory processes) would be measured. If a blood sample were acidic under the conditions of the titration, alkali would have to be added instead of acid, and the base excess would be negative.

The concept and the quantitation of base excess are most easily understood from the pH–bicarbonate diagram. In our discussion of the blood buffer line we saw how increasing the P_{CO_2} in blood, where other buffers are present, would result in a rise in $[\text{HCO}_3^-]$ and a virtually identical decrease in the concentration of other buffer bases. This was because equivalent amounts of the other buffer bases were consumed as they buffered carbonic acid. Since virtually all the carbonic acid formed was buffered, for every HCO_3^- formed one conjugate base of some other system was consumed. In this situation the total base in the blood is not measurably changed; only the distribution of HCO_3^- and nonbicarbonate buffer conjugate base is changed. Thus, as long as one remains on the blood buffer line, $[\text{HCO}_3^-]$ can change but total base will not. There will be no positive or negative base excess.

If, however, renal activity, diet, or some metabolic process adds or removes HCO_3^- , then a positive or negative base excess will occur. The patient's status will no longer be described by a point on the buffer line, and the base excess will be the difference between the observed plasma $[\text{HCO}_3^-]$ and the $[\text{HCO}_3^-]$ on the buffer line at the same pH (Figure 25.26). To calculate this difference, the position of the buffer line, which can be determined from knowledge of the slope and the point representing the normal state, must be known. In the

clinical laboratory it can be estimated from hemoglobin concentration and assuming that it is the major nonbicarbonate buffer.

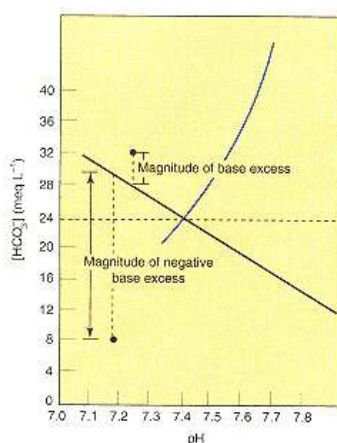

Figure 25.26
Calculation of base excess for a point above the blood buffer line, and calculation of negative base excess for a point below the blood buffer line.
 Base excess is $32 - 28 = 4$ meq L^{-1} . Negative base excess is $30 - 8 = 22$ meq L^{-1} .

The buffer line, then, is the dividing line between positive and negative base excess. Any point above it is in the region of positive base excess, and any point below it is in the region of negative base excess. This gives rise to situations that may seem peculiar at first. In Figure 25.27 the $[HCO_3^-]$ at point A is normal, but the patient has a negative base excess. A positive or negative base excess occurs as a result of compensation for a respiratory acid–base imbalance or directly from a metabolic one. Respiratory compensation for a metabolic acid–base imbalance, since it involves movement along a line parallel to the buffer line (Figure 25.25), would cause no further change in the value of the base excess. Clinical Correlation 25.10 involves consideration of base excess.

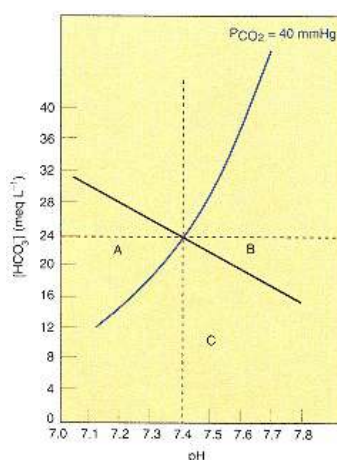

Figure 25.27
Examples showing the sign of the base excess at various points.
 At points A and C there is a negative base excess. At point B the base excess is positive.

25.14— The Significance of Na^+ and Cl^- in Acid–Base Imbalance

An important concept in diagnosing certain acid–base disorders is the **anion gap**. Most clinical laboratories routinely measure plasma Na^+ , K^+ , Cl^- , and HCO_3^- . A glance at the graph in Figure 25.15 confirms that in the plasma of a normal individual the sum of the concentrations of Na^+ and K^+ is greater than the sum of the concentrations of Cl^- and HCO_3^- . This difference is called A, the anion gap; it represents the other plasma anions (Figure 25.15), which are not routinely measured. It is calculated as follows:

$$A = (Na^+ + K^+) - (Cl^- + HCO_3^-)$$

The normal value of A is in the range of 12–16 meq L^{-1} . In some clinical laboratories K^+ is not measured; then the normal value is 8–12 meq L^{-1} . The gap is changed only by conditions that change the sum of the cations or the sum of the anions, or by conditions that change both sums by different amounts. Thus administration or depletion of sodium bicarbonate would not change the anion gap because $[Na^+]$ and $[HCO_3^-]$ would be affected equally. Metabolic acidosis due to HCl or NH_4Cl administration would also leave the anion gap unaffected; here $[HCO_3^-]$ would decrease, but $[Cl^-]$ would increase by an equivalent amount, and the sum of $[HCO_3^-]$ plus $[Cl^-]$ would be unchanged. In contrast, diabetic ketoacidosis or methanol poisoning involves production of organic acids, which react with HCO_3^- , decreasing its concentration. But since the $[HCO_3^-]$ is replaced by some organic anion, the sum of $[HCO_3^-]$ plus $[Cl^-]$ decreases, and the anion gap increases.

The anion gap is most commonly used to establish a differential diagnosis for metabolic acidosis. In a metabolic acidosis with an increased anion gap, H^+ must have arisen in the body with some anion other than chloride. Metabolic acidosis without an increased anion gap must be due either to accumulation of H^+ with chloride or to a decrease in the concentration of sodium bicarbonate. Thus, on the basis of the anion gap, certain diseases can be ruled out, while others would have to be considered. This information can be especially important in dealing with patients who cannot give good histories due to language barriers, unconsciousness, and so on.

Electrolytes of body fluids interact in a multitude of ways. One important way involves the capacity of K^+ and H^+ to substitute for one another under certain circumstances. This can occur in cells, where K^+ is the major cation. In acidosis intracellular $[H^+]$ rises, and it replaces some of the intracellular K^+ . The displaced K^+ appears in plasma and is excreted by the kidneys. This leaves the patient with normal plasma $[K^+]$ (normokalemia), but with seriously depleted body K^+ stores (hypokalemia). Subsequent excessively rapid correction of the acidosis may then reverse events. As plasma pH rises, K^+ flows back into the cells, and plasma $[K^+]$ may decline to the point where muscular weakness sets in and respiratory insufficiency may become life-threatening.

CLINICAL CORRELATION 25.10

Evaluation of Clinical Acid–Base Data

In a 1972 study of total parenteral nutrition of infants, it was found that infants who received amino acids in the form of a hydrolysate of the protein fibrin maintained normal acid–base balance. In contrast, infants receiving two different mixtures of synthetic amino acids, FreAmine and Neoaminosol, became acidotic. Both synthetic mixtures contained adequate amounts of all the essential amino acids, but neither contained aspartate or glutamate. The fibrin hydrolysate contained all of the common amino acids.

The accompanying figure shows the blood acid–base data from these infants. Note that the normal values for infants, given by the dashed lines, are not quite the same as normal values for adults. (A child is *not* a small adult.) The blood pH data show that the infants receiving synthetic mixtures were clearly acidotic. The low $[\text{HCO}_3^-]$ of the Neoaminosol group immediately suggests a metabolic acidosis, and the P_{CO_2} values indicate respiratory acidosis should be associated with a slightly elevated $[\text{HCO}_3^-]$. The absence of this finding in most of the infants indicates that the acidosis must also have a metabolic component. This is confirmed by the observation that all the infants receiving FreAmine have a significant negative base excess.

The infants with mixed acid–base disturbances did, in fact, have pneumonia or respiratory distress syndrome. The metabolic acidosis, which all the infants receiving synthetic mixtures experienced, was due to synthesis of aspartic acid and glutamic acid from a neutral starting material (presumably glucose). Subsequent incorporation of these acids into body protein imposed a net acid load on the body. Addition of aspartate and/or glutamate to the synthetic mixtures was proposed as a solution of the problem.

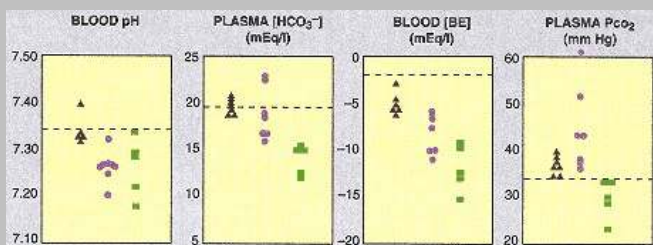

Blood acid–base data of patients receiving fibrin hydrolysate (▲) and of those receiving synthetic L-amino acid mixtures, FreAmine (■).

Values are those observed at the time of the lowest blood base excess. Dashed lines represent accepted normal values for infants. Adapted from W. C. Heird, *N. Engl. J. Med.* 287:943, 1972.

In kidneys the reciprocal relationship between K^+ and H^+ results in an association between metabolic alkalosis and hypokalemia. If hypokalemia arises from long-term insufficiency of dietary potassium or long-term diuretic therapy, intracellular K^+ levels diminish, and intracellular $[\text{H}^+]$ will increase. This leads to increased acid excretion, acidic urine, and an alkaline arterial plasma pH. We have already seen how in an alkalotic individual a hormonal signal to absorb Na^+ can lead to K^+ loss and then to an exacerbation of the metabolic alkalosis (p. 1045). The opposite also occurs, with alkalosis leading to hypokalemia. In this case increased amounts of $\text{Na}^+ + \text{HCO}_3^-$ are presented to the distal convoluted tubules, where all K^+ secretion normally takes place (all filtered K^+ is reabsorbed; K^+ loss is due to distal tubular secretion). The distal tubules take up some Na^+ but since HCO_3^- does not readily follow across that membrane, the increased Na^+ uptake is linked to increased K^+ secretion. K^+ excretion is complicated, being controlled by a variety of hormones and other

CLINICAL CORRELATION 25.11**Metabolic Alkalosis**

Prolonged gastric lavage produces a metabolic alkalosis that is a good experimental model of the metabolic alkalosis that results from repeated vomiting. The following table gives plasma and urine acid–base and electrolyte data from a healthy volunteer on a low-sodium diet who, after a control period, was subjected to gastric lavage for two days. After a five day recovery period, he was placed on a low-potassium diet and given a sodium (130 meq day⁻¹) and chloride (121 meq day⁻¹) supplement. During the control period the data are within normal limits. After gastric lavage that selectively removed HCl (Na₊, K₊, and H₂O lost with the gastric juice were restored), an uncomplicated metabolic alkalosis developed. Note that the subject excreted an alkaline urine, containing a substantial amount of HCO₃⁻. The Na₊ excretion increased, depleting the body's Na₊ stores. Plasma P_{CO_2} was not measured, but plotting the values of pH and [HCO₃⁻] on a pH-bicarbonate diagram (e.g., Figure 25.18) allows one to interpolate a value of about 47 mmHg. Clearly, respiratory compensation was occurring. Plasma [K₊] was decreased. Plasma [Cl⁻] decreased, but no more than would be expected on the basis of the changes in [Na₊], [K₊], and [HCO₃⁻].

When the subject was placed on a low-potassium diet the alkalosis grew worse, and plasma [HCO₃⁻] rose. Additional compensatory hypoventilation evidently prevented a further rise in plasma pH. Note, though, that the urine became acidic, in spite of the increased severity of the alkalosis. The Na₊ was conserved, not in exchange for K₊, but in exchange for H₊. After several days of Na₊ and Cl⁻ administration, however, the subject was able to restore the depleted Cl⁻, excrete the excess HCO₃⁻, and repair the acid–base imbalance with no other treatment.

	<i>Control</i>	<i>After Lavage</i>	<i>Low KCl</i>	<i>After NaCl</i>
Plasma				
pH	7.4	7.50	7.48	7.41
HCO ₃ ⁻	29.3	35.3	38.1	26.1
Na ⁺ (meq L ⁻¹)	138	134	141	144
K ⁺ (meq L ⁻¹)	4.2	3.2	2.9	3.2
Cl ⁻ (meq L ⁻¹)	101	88	85	108
Urine				
pH				
HCO ₃ ⁻ (meq/day ⁻¹)	6.12	7.48	5.70	7.19
	3	51	1	17
NH ₄ ⁺ (meq/day ⁻¹)	22	4	36	14
Titrateable acidity (meq/day ⁻¹)	10	0	14	1
Total acidity (meq/day ⁻¹)	29	-49	49	-2
Na ⁺ (meq/day ⁻¹)	2	28	1	95

Source: Data from Kassirer, J. P., and Schwartz, W. B., *Am. J. Med.* 40:10, 1966.

factors. The end result, however, is that metabolic alkalosis and hypokalemia go hand in hand, so that the term "hypokalemic alkalosis" is often used synonymously with metabolic alkalosis. Clinical Correlation 25.11 discusses a case of experimental metabolic alkalosis in which this occurred.

Bibliography**Gas Transport**

Bunn, H. F., and Forget, B. G. *Hemoglobin: Molecular, Genetic, and Clinical Aspects*. Philadelphia: Saunders, 1986.

Bunn, H. F., Gabbay, K. H., and Gallop, P. M. The glycosylation of hemoglobin: relevance to diabetes mellitus. *Science* 200:21, 1978.

Kilmartin, J. V. Interaction of haemoglobin with protons, CO₂ and 2,3-diphosphoglycerate. *Br. Med. Bull.* 32:209, 1976.

Perutz, M. F., and Lehmann, H. Molecular pathology of human haemoglobin. *Nature* 219:902, 1968.

Steffes, M. W., and Mauer, S. M. Toward a basic understanding of diabetic complications. *N. Engl. J. Med.* 325:883, 1991.

pH Regulation

Davenport, H. W. *The ABC of Acid–Base Chemistry*, 6th ed. Chicago: University of Chicago Press, 1974.

Gabow, P. A., Kaehny, W. D., Fennessey, P. V., et al. Diagnostic importance of an increased serum anion gap. *N. Engl. J. Med.* 303:854, 1980.

Gamble, J. L. Jr., and Bettice, J. A. Acid-base relationships in the different body compartments: the basis for a simplified diagnostic approach. *Johns Hopkins Med. J.* 140:213, 1977.

Masoro, E.J., and Siegel, P. D. *Acid–Base Regulation: Its Physiology, Patho-physiology and the Interpretation of Blood–Gas Analysis*, 2nd ed. Philadelphia: Saunders, 1977.

Siggaard-Andersen, O. *The Acid–Base Status of the Blood*, 4th ed. Baltimore: Williams & Wilkins, 1974.

Questions

J. Baggott and C. N. Angstadt

1. During a breathing cycle:

- the alveolar gases are completely exchanged for atmospheric gases.
- gas exchange between the alveoli and the capillary blood can occur at all times.
- gas exchange with the capillary blood occurs at the surface of all the airways.
- there is net uptake of nitrogen by the blood.
- atmospheric water vapor is taken up by the lungs.

2. From an oxygen saturation curve for normal blood we can determine that:

- A. P_{50} is in the P_{CO_2} range found in extrapulmonary tissues.
- B. oxygen binding is hyperbolic.
- C. an oxygen carrier is necessary.
- D. tighter oxygen binding occurs at lower P_{CO_2} .
- E. shifts of the curve to the left or right would have little effect on oxygen delivery.

Refer to the following for Questions 3–5.

- A. hemoglobin α -chains
- B. hemoglobin β -chains
- C. hemoglobin γ -chains
- D. hemoglobin δ -chains
- E. hemoglobin ϵ -chains

3. Found in HbA, HbA₂, and HbF.

4. Modified in HbA_{1c}.

5. Form the major binding sites for 2,3-bisphosphoglycerate (BPG).

6. At a P_{CO_2} of 30 mmHg hemoglobin's percent saturation will:

- A. increase with increasing temperature.
- B. increase with decreasing pH.
- C. increase with increasing P_{CO_2} .
- D. increase with increasing 2,3-bisphosphoglycerate concentration.
- E. none of the above.

7. Significant contributors to the total carbon dioxide of whole blood include all of the following EXCEPT:

- A. bicarbonate ion.
- B. dissolved carbon dioxide (CO₂).
- C. carbaminohemoglobin.
- D. carbonic acid (H₂CO₃).

8. 2,3-Bisphosphoglycerate (BPG):

- A. is absent from the normal erythrocyte.
- B. is a homotropic effector for hemoglobin.
- C. binds more tightly to HbF than to HbA.
- D. synthesis increases when hemoglobin's T ↔ R equilibrium is shifted in favor of the T state.
- E. synthesis decreases when the erythrocyte pH rises.

9. Which of the following buffer systems is far less effective in controlling changes in physiological pH due to CO₂ than changes due to metabolic acids, like acetoacetic acid?

- A. bicarbonate
- B. inorganic phosphate
- C. organic phosphate esters
- D. intracellular protein
- E. extracellular protein

10. The slope of the blood buffer line is most sensitive to pathological changes in the blood concentration of:

- A. plasma bicarbonate.
- B. plasma phosphate.
- C. hemoglobin.
- D. plasma proteins.
- E. organic phosphates of the erythrocyte.

11. As P_{CO_2} is increased in a normal individual:

- A. the plasma [CO₂] remains unchanged.
- B. plasma bicarbonate increases.
- C. the slope of the blood buffer line changes.
- D. the base excess increases.
- E. the base excess decreases.

12. All of the following produce H⁺ EXCEPT:

- A. formation of bicarbonate ion from CO₂ and water.
- B. formation of carbaminohemoglobin from CO₂ and hemoglobin.
- C. binding of oxygen by hemoglobin.
- D. oxidation of sulfur-containing amino acids.
- E. metabolism of sodium lactate.

13. A substantial fraction of the urinary titratable acidity of a normal individual consists of:

- A. H₂CO₃.
- B. NH₄⁺.
- C. acetoacetic acid.
- D. H₂PO₄⁻.
- E. HCO₃⁻.

14. In a patient with diabetic ketoacidosis of long duration:

- A. the major urinary acid is H₂PO₄⁻.
- B. hemoglobin's oxygen dissociation curve would be shifted to the right.
- C. the distribution of hemoglobin species would be the same as in a normal individual.
- D. 1 mol of bicarbonate is regenerated for every mole of H₂PO₄⁻ formed in the renal tubule.
- E. hypoventilation would be expected.

15. The following laboratory data are obtained from a patient: $P_{\text{CO}_2} = 60$ mmHg, $\text{HCO}_3^- = 27$ meq L⁻¹, pH = 7.28. These values define a point on the patient's blood buffer line. We conclude:

- A. The patient has an acute condition.
- B. The condition would lead to production of an alkaline urine.
- C. Of the blood buffers, the bicarbonate buffer system is the most important in resisting this pH change.
- D. Increasing the alveolar P_{CO_2} could restore the plasma to normal.
- E. Hyperventilation due to anxiety could cause this.

16. During compensation for a metabolic acid-base imbalance, which of the following would become increasingly abnormal?

- A. plasma pH
- B. blood P_{CO_2}
- C. base excess
- D. total hemoglobin
- E. none of the above

17. In respiratory alkalosis:

- A. the acute state is associated with an abnormally low plasma [HCO₃⁻].
- B. the mechanism of compensation causes an increase in the plasma HCO₃⁻.
- C. the plasma pH never returns to the normal range in the fully compensated state.
- D. in the partially compensated state, there will be a negative base excess equal to the difference between 24 meq L⁻¹ and the actual plasma HCO₃⁻.
- E. compensation involves changing P_{CO_2} .

18. Hypokalemia can be expected to:

- A. occur if the plasma pH is rapidly raised.
- B. lead to increased urine acidity.
- C. be associated with a high plasma $[\text{HCO}_3^-]$.
- D. decrease the value of the anion gap slightly.
- E. all of the above.

Answers

1. B A and C: The alveoli, where gas exchange with the blood occurs, are of constant size and exchange gases with the airways by diffusion. D and E: Water vapor and CO_2 are added to the alveolar gases by the lung tissue, diluting the nitrogen (p. 1027).
2. A P_{O_2} (p. 1028, Figure 25.2). C: If O_2 were soluble enough in plasma, no carrier would be necessary (p. 1026). E: Shifts profoundly affect delivery (p. 1028).
3. A It is the non- α -chain that differs among these (p. 1030).
4. B The β -chains are nonenzymatically glycosylated in HbA_{1c} (p. 1030).
5. B BPG binds between the N terminals of the β -chains (p. 1029).
6. E All effects are opposite to those proposed in the question. A-C: High temperature, low pH (and therefore high P_{CO_2}) favor dissociation; that is, decreased saturation (p. 1031). D: High BPG has the same effect (p. 1029).
7. D Carbonic acid is present in very small amounts; the equilibrium strongly favors CO_2 and H_2O (p. 1033, Table 25.2; see also p. 1039).
8. D A and B: BPG is a normal component of the red cell, where it serves as a heterotropic effector of HbA (p. 1029, Figure 25.4). C: It binds weakly or not at all to the HbF (p. 1030). D and E: BPG binds to the T state, relieving product inhibition of BPG synthesis; BPG synthesis is inhibited by low pH (p. 1036).
9. A The bicarbonate system is a major extracellular buffer; with a pK of 6.1 it is ineffective toward CO_2 . The other buffers (phosphates and protein) are, effective (p. 1037, Table 25.6). All of these buffers, however, are effective against noncarbonic acids. The bicarbonate buffer system is included here because the response of the respiratory system to low pH, exhaling CO_2 , compensates for the innate ineffectiveness of this system at a pH fairly distant from its pK (p. 1039).
10. C The slope of the blood buffer line is determined by the concentration of the nonbicarbonate buffers. Of these, hemoglobin is quantitatively the most important and is susceptible to change (i.e., anemias from any cause) (p. 1040).
11. B This is because the resulting H_2CO_3 is buffered by various nonbicarbonate buffers, producing HCO_3^- (p. 1040).
12. E Metabolism of sodium lactate produces sodium bicarbonate and is used clinically to control acidosis (p. 1042). A and B are reactions whose products include H^+ (pp. 1032–1033). C is the Bohr effect (p. 1031). D is a major source of acid in the typical American diet (p. 1042).
13. D A: The level of H_2CO_3 is very low. B: NH_4^+ is an important urinary acid, but its pK is too high to be titrated at pH 7.4, the endpoint. C: Acetoacetic acid would appear only in some kinds of severe acidosis. E: HCO_3^- is physiologically a base; its dissociable H^+ has a pK that is far above the physiological range (pp. 1043 and 1045).
14. D See pp. 1043–1045. A: After adaptation to acidosis NH_4^+ excretion rises enormously, becoming the major urinary acid (p. 1045). B: True only in acidosis of short duration; decreasing BPG in prolonged acidosis tends to restore the normal position (p. 1036). C: Large amounts of HbA_{1c} would be expected (p. 1030). E: Hyperventilation, to expel CO_2 , would be expected (p. 1048).
15. A High P_{CO_2} , low pH point on the blood buffer line define an acute respiratory acidosis. Buffering by nonbicarbonate buffer systems and excretion of acid in the urine would be the physiological responses (p. 1047).
16. B P_{CO_2} would decrease during compensation for acidosis or rise during compensation for alkalosis. A: Plasma pH would be restored. C: Base excess would be unchanged. D: Hemoglobin would participate in buffering, but its total concentration would not be expected to change (pp. 1048–1050, Figures 25.25 and 25.26).
17. A A and B: See p. 1047, Figure 25.24. C: This is the only acid-base abnormality in which compensation is expected to restore the plasma pH to 7.4 (p. 1047). D: There is a negative base excess equivalent to the difference between the patient's $[\text{HCO}_3^-]$ and the $[\text{HCO}_3^-]$ of the point on the blood buffer line at the same pH, a point that will be less than 24 meq L^{-1} (p. 1050, Figure 25.26). E: This would either be a cure or an exacerbation, depending on the direction of the change; it would not be compensation.
18. E A, B, and C: See p. 1050. D: Decreasing K^+ would lower the anion gap by a small amount (p. 1050).

Chapter 26— Digestion and Absorption of Basic Nutritional Constituents

Ulrich Hopfer

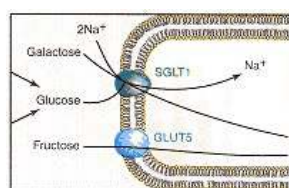

26.1 Overview	1056
Gastrointestinal Organs Have Multiple Functions in Digestion	1057
26.2 Digestion: General Considerations	1059
Pancreas Supplies Enzymes for Intestinal Digestion	1059
Digestive Enzymes Are Secreted as Proenzymes	1059
Regulation of Secretion Occurs through Secretagogues	1060
26.3 Epithelial Transport	1063
Solute Transport May Be Transcellular or Paracellular	1063
NaCl Absorption Has Both Active and Passive Components	1064
NaCl Secretion Depends on Contraluminal Na ⁺ ,K ⁺ -ATPase	1066
Concentration Gradients or Electrical Potentials Drive Transport of Nutrients	1067
Gastric Parietal Cells Secrete HCl	1069
26.4 Digestion and Absorption of Proteins	1070
Mixture of Peptidases Assures Efficient Protein Digestion	1070
Pepsins Catalyze Gastric Digestion of Protein	1070
Pancreatic Zymogens Are Activated in Small Intestine	1071
Intestinal Peptidases Digest Small Peptides	1072
Free Amino Acids and Dipeptides Are Absorbed by Carrier-Mediated Transport	1072
Fetus and Neonate Can Absorb Intact Proteins	1073
26.5 Digestion and Absorption of Carbohydrates	1073
Di- and Polysaccharides Require Hydrolysis	1073
Monosaccharides Are Absorbed by Carrier-Mediated Transport	1076
26.6 Digestion and Absorption of Lipids	1077
Lipid Digestion Requires Overcoming the Limited Water Solubility of Lipids	1077
Lipids Are Digested by Gastric and Pancreatic Lipases	1078
Bile Acid Micelles Solubilize Lipids during Digestion	1078
Most Absorbed Lipids Are Incorporated into Chylomicrons	1082
26.7 Bile Acid Metabolism	1083
Bibliography	1085
Questions and Answers	1085
Clinical Correlations	
26.1 Cystic Fibrosis	1067
26.2 Bacterial Toxigenic Diarrheas and Electrolyte Replacement Therapy	1068
26.3 Neutral Amino Aciduria (Hartnup Disease)	1073
26.4 Disaccharidase Deficiency	1075
26.5 Cholesterol Stones	1081
26.6 A-β-Lipoproteinemia	1082

26.1— Overview

Secretion of digestive fluids and digestion of food were some of the earliest biochemical events to be investigated at the beginning of the era of modern science. Major milestones were the discovery of hydrochloric acid secretion by the stomach and enzymatic hydrolysis of protein and starch by gastric juice and saliva, respectively. The discovery of gastric HCl production goes back to the American physician William Beaumont (1785–1853). In 1822 he treated a patient with a stomach wound. The patient recovered from the wound, but retained a gastric fistula (abnormal opening through the skin). Beaumont seized the opportunity to obtain and study gastric juice at different times during and after meals. Chemical analysis revealed, to the surprise of chemists and biologists, the presence of the inorganic acid HCl. This discovery established the principle of unique secretions into the gastrointestinal tract, which are elaborated by specialized glands.

Soon thereafter, the principle of enzymatic breakdown of food was recognized. In 1836 Theodor Schwann, a German anatomist and physiologist (1810–1882), noticed that gastric juice degraded albumin in the presence of dilute acid. He recognized that a new principle was involved and coined the word pepsin from the Greek *pepsis*, meaning digestion. Today the process of secretion of digestive fluids, digestion of food, and absorption of nutrients and of electrolytes can be described in considerable detail.

The basic nutrients fall into the classes of proteins, carbohydrates, and fats. Many different types of food can satisfy the nutritional needs of humans, even though they differ in the ratios of proteins to carbohydrates and to fats and in the ratio of digestible to nondigestible materials. Unprocessed plant products are especially rich in **fibrous material** that can be neither digested by human enzymes nor easily degraded by intestinal bacteria. The fibers are mostly carbohydrates, such as **cellulose** (β -1,4-glucan) or **pectins** (mixtures of methyl esters of polygalacturonic acid, polygalactose, and polyarabinose). High-fiber diets enjoy a certain popularity nowadays because of a postulated preventive effect on development of colonic cancer.

26.1 describes average contributions of different food classes to the diet of North Americans. The intake of individuals may substantially deviate from the average, as food consumption depends mainly on availability and individual tastes. The ability to utilize a wide variety of food is possible because of the great adaptability and digestive reserve capacity of the gastrointestinal tract.

Knowledge of the nature of proteins and carbohydrates in the diet is important from a clinical point of view. Certain proteins and carbohydrates, although good nutrients for most humans, cannot be properly digested by some individuals and produce gastrointestinal ailments. Omission of the offending

TABLE 26.1 Contribution of Major Food Groups to Daily Nutrient Supplies in the United States

Type of Nutrient	Total Daily Consumption (g)	Dairy Products, Except Butter (%)	Meat, Poultry, Fish (%)	Eggs (%)	Fruits, Nuts, Vegetables (%)	Flour, Cereal (%)	Sugar Sweeteners (%)	Fats, Oils (%)
Protein	100	22	42	6	12	18	0	0
Carbohydrate	381	7	0.1	0.1	19	36	37	0
Fat	155	13	35	3	4	1	0	42

material and change to another diet can eliminate these gastrointestinal problems. Examples of food constituents that can be the cause of gastrointestinal disorders are **gluten**, one of the protein fractions of wheat, and **lactose**, the disaccharide in milk.

Gastrointestinal Organs Have Multiple Functions in Digestion

The bulk of ingested nutrients consists of large **polymers** that have to be broken down to **monomers** before they can be absorbed and made available to all cells of the body. The complete process from food intake to absorption of nutrients into the blood consists of a complicated sequence of events, which at the minimum includes (Figure 26.1):

1. Mechanical homogenization of food and mixing of ingested solids with fluids secreted by the glands of the gastrointestinal tract.
2. Secretion of digestive enzymes that hydrolyze macromolecules to oligomers, dimers, or monomers.
3. Secretion of electrolytes, acid, or base to provide an appropriate environment for optimal enzymatic digestion.
4. Secretion of bile acids as detergents to solubilize lipids and facilitate their absorption.
5. Hydrolysis of nutrient oligomers and dimers by enzymes on the intestinal surface.
6. Transport of nutrient molecules and of electrolytes from the intestinal lumen across the epithelial cells into blood or lymph.

To accomplish these functions, the gastrointestinal tract contains specialized glands and surface epithelia:

Organ	Major Function in Digestion and Absorption
Salivary glands	Elaboration of fluid and digestive enzymes
Stomach	Elaboration of HCl and proteases
Pancreas	Elaboration of NaHCO ₃ and enzymes for intraluminal digestion
Liver	Elaboration of bile acids
Gallbladder	Storage and concentration of bile
Small intestine	Terminal digestion of food, absorption of nutrients and electrolytes
Large intestine	Absorption of electrolytes

The **pancreas** and **small intestine** are essential for digestion and absorption of all basic nutrients. Fortunately, both organs have large reserve capacities. For example, maldigestion due to pancreatic failure becomes a problem only when the pancreatic secretion rate of digestive enzymes drops below one-tenth of the normal rate. The secretion of the liver (**bile**) is important for efficient lipid absorption, which depends on the presence of bile acids. In contrast, gastric digestion of food is nonessential for adequate nutrition, and loss of this function can be compensated for by the pancreas and the small intestine. Yet normal gastric digestion greatly increases the smoothness and efficiency of the total digestive process. The stomach aids in the digestion through its reservoir function, its churning ability, and initiation of protein hydrolysis, which, although small, is important for stimulation of pancreatic and gallbladder output. Peptides and amino acids liberated in the stomach stimulate the coordinated release of pancreatic juice and bile into the lumen of the small intestine, thereby ensuring efficient digestion of food.

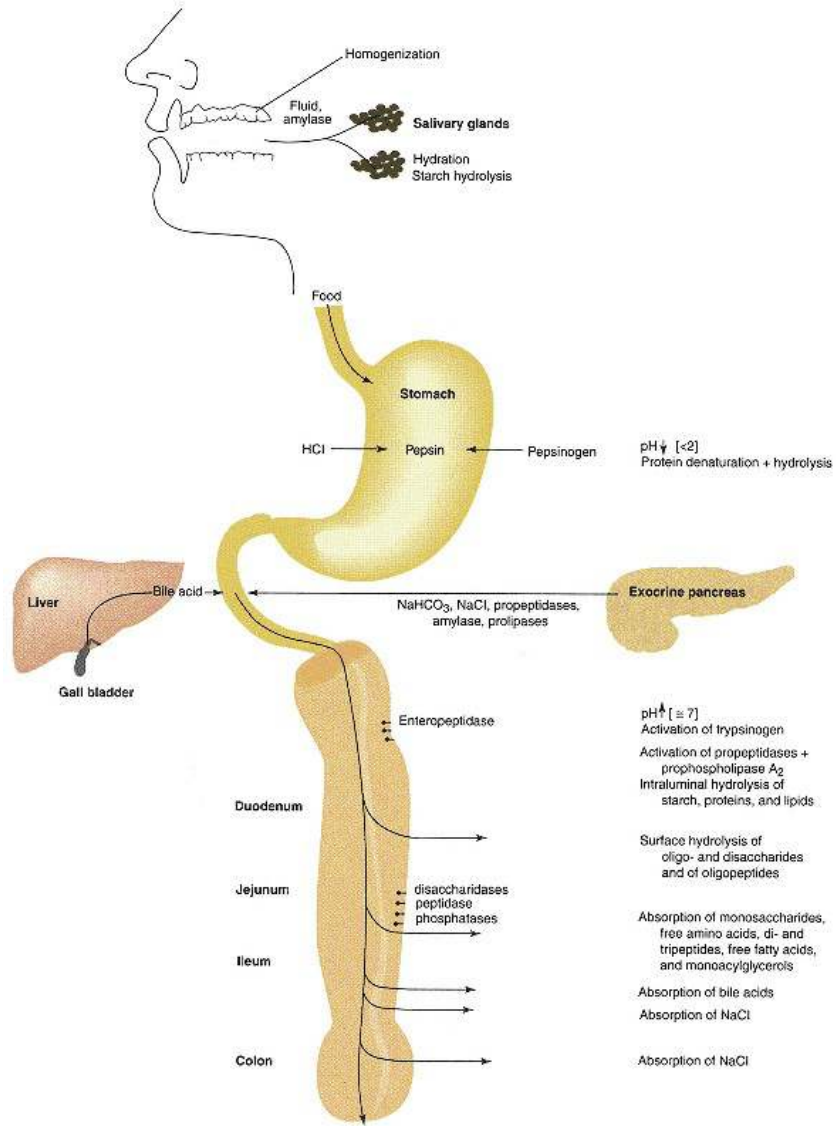

Figure 26.1
Gastrointestinal organs and their functions.

26.2—

Digestion:**General Considerations*****Pancreas Supplies Enzymes for Intestinal Digestion***

Most of the breakdown of food is catalyzed by soluble enzymes and occurs within the lumen of the stomach or small intestine. The **pancreas**, not the stomach, is the major organ that synthesizes and secretes the large amounts of enzymes needed for digestion. Secreted enzymes amount to at least 30 g of protein per day in a healthy adult. The **pancreatic enzymes** together with bile are poured into the lumen of the second (descending) part of the duodenum, so that the bulk of the **intraluminal digestion** occurs distal to this site in the small intestine. However, pancreatic enzymes cannot completely digest all nutrients to forms that can be absorbed. Even after exhaustive contact with pancreatic enzymes, a substantial portion of carbohydrates and amino acids are present as dimers and oligomers that depend for final digestion on enzymes present on the luminal surface or within the chief epithelial cells that line the lumen of the small intestine (**enterocytes**).

The luminal plasma membrane of enterocytes is enlarged by a regular array of projections, termed microvilli, which give it the appearance of a brush and have led to the name **brush border** for the luminal pole of enterocytes. This membrane contains many **di- and oligosaccharidases, amino- and dipeptidases**, as well as **esterases** (Table 26.2). Many of these enzymes protrude up to 100 Å into the intestinal lumen, attached to the plasma membrane by an anchoring polypeptide that itself has no role in the hydrolytic activity. The substrates for these enzymes are the oligomers and dimers that result from pancreatic digestion. The surface enzymes are glycoproteins that are relatively stable against digestion by pancreatic proteases or the effects of detergents.

A third site of digestion is the cytoplasm of enterocytes. **Intracellular digestion** is of some importance for the hydrolysis of di- and tripeptides, which can be absorbed across the luminal plasma membrane.

Digestive Enzymes Are Secreted as Proenzymes

Salivary glands, gastric mucosa, and pancreas contain specialized cells that synthesize and store digestive enzymes until the enzymes are needed during

TABLE 26.2 Digestive Enzymes of the Small Intestinal Surface

<i>Enzyme (Common Name)</i>	<i>Substrate</i>
Maltase	Maltose
Sucrase/isomaltase	Sucrose/ α -limit dextrin
Glucoamylase	Amylose
Trehalase	Trehalose
β -Glucosidase	Glucosylceramide
Lactase	Lactose
Endopeptidase 24.11	Protein (cleavage at internal hydrophobic amino acids)
Aminopeptidase A	Oligopeptide with acidic NH ₂ terminus
Aminopeptidase N	Oligopeptide with neutral NH ₂ terminus
Dipeptidyl aminopeptidase IV	Oligopeptide with X-Pro or X-Ala at NH ₂ terminus
Leucine aminopeptidase	Peptides with neutral amino acid at NH ₂ terminus
γ -Glutamyltransferase	Glutathione + amino acid
Enteropeptidase (enterokinase)	Trypsinogen
Alkaline phosphatase	Organic phosphates

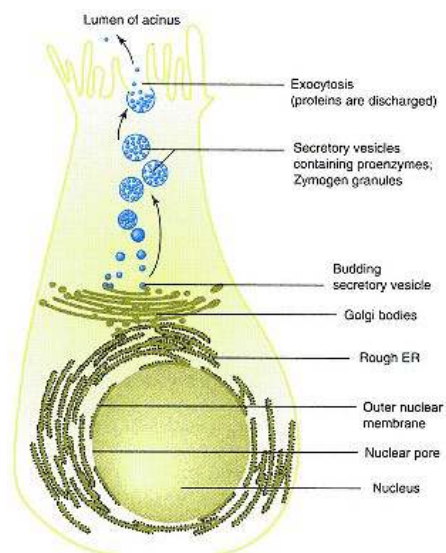

Figure 26.2

Exocrine secretion of digestive enzymes.

Redrawn with permission from Jamieson, J. D. Membrane and secretion. In: G. Weissmann and R. Claiborne (Eds.), *Cell Membranes: Biochemistry, Cell Biology and Pathology*. New York: HP Publishing Co., 1975. Figure by B. Tagawa.

a meal. The enzymes are then released into the lumen of the gastrointestinal tract (Figure 26.2). This secretion is termed **exocrine** because of its direction toward the lumen. Proteins destined for secretion are synthesized on the polysomes of the rough endoplasmic reticulum (see p. 739 for synthesis and glycosylation of membrane and secreted proteins) and transported via the Golgi complex to storage vesicles in the apical cytoplasm. The storage vesicles (**zymogen granules**) have a diameter of about 1 μm . Most digestive enzymes are produced and stored as inactive **proenzymes (zymogens)** (see p. 101). The zymogen granules are bounded by a typical cellular membrane. When an appropriate stimulus for secretion is received by the cell, the granules move closer to the luminal plasma membrane, where their membranes fuse with the plasma membrane and release the contents into the lumen (**exocytosis**). Activation of proenzymes occurs only after they are released from the cells.

Regulation of Secretion Occurs through Secretagogues

The processes involved in the secretion of enzymes and electrolytes are regulated and coordinated. Elaboration of electrolytes and fluids simultaneously with that of enzymes is required to flush any discharged digestive enzymes out of the gland into the gastrointestinal lumen. The physiological regulation of secretion occurs through **secretagogues** that interact with receptors on the surface of the **exocrine cells** (Table 26.3). Neurotransmitters, hormones, pharmacological agents, and certain bacterial toxins can be secretagogues. Different exocrine cells, for example, in different glands, usually possess different sets of receptors. Binding of the secretagogues to receptors sets off a chain of signaling events that ends with fusion of zymogen granules with the plasma membrane. Two major signaling pathways have been identified (Figure 26.3): (1) activation of phosphatidylinositol-specific **phospholipase C** with liberation of **inositol 1,4,5-triphosphate** and **diacylglycerol** (see p. 862); in turn, triggering Ca^{2+} release into the cytosol and activation of protein kinase C, respec-

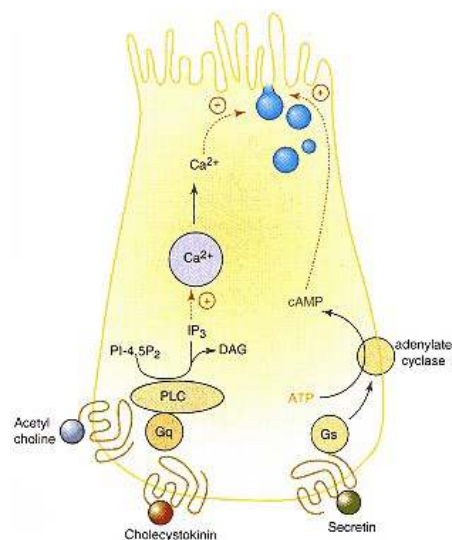

Figure 26.3

Cellular regulation of exocrine secretion in the pancreas.Abbreviations: PI-4,5P₂, phosphatidylinositol-4,5-bisphosphate;DG, diacylglycerol; IP₃, inositol-1,4,5-trisphosphate; PLC,phospholipase C. Adapted from Gardner, J. D. *Annu. Rev.**Physiol.* 41:63, 1979.

Copyright © 1979 by Annual Reviews, Inc.

tively; and (2) activation of **adenylylate** or **guanylate cyclase**, resulting in elevated cAMP or cGMP levels, respectively (see p. 859). Secretion can be stimulated through either pathway.

Acetylcholine (Figure 26.4) elicits salivary, gastric, and pancreatic enzyme and electrolyte secretion. It is the major neurotransmitter for stimulating secretion, with input from the central nervous system in salivary and gastric glands, or via local reflexes in gastric glands and the pancreas. The acetylcholine receptor of exocrine cells is of the muscarinic type; that is, it can be blocked by atropine (Figure 26.5). Most people have experienced the effect of atropine because it is used by dentists to "dry up" the mouth for dental work.

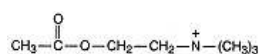

Figure 26.4

Acetylcholine.

Another class of secretagogues are the **biogenic amines**, consisting of **histamine** and **5-hydroxytryptamine**. **Histamine** (Figure 26.6) is a potent stimulator of HCl secretion. It interacts with a gastric-specific histamine receptor, also referred to as the H₂ receptor, on the contraluminal plasma membrane of parietal cells. Histamine is normally secreted by specialized regulatory cells in the stomach wall (**enterochromaffin-like cells, ECC**). Histamine analogs that are antagonists at the H₂ receptor are used medically to decrease HCl output during treatment for peptic ulcers. **5-Hydroxytryptamine (serotonin)** is pres-

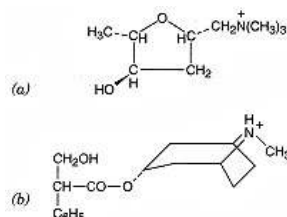

Figure 26.5

(a) L(+)-Muscarine and (b) atropine.

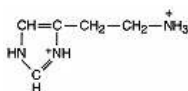

Figure 26.6

Histamine.

TABLE 26.3 Physiological Secretagogues

Organ	Secretion	Secretagogue
Salivary gland	NaCl, amylase	Acetylcholine, (catecholamines?)
Stomach	HCl, pepsinogen	Acetylcholine, histamine, gastrin
Pancreas—acini	NaCl, digestive enzymes	Acetylcholine, cholecystokinin (secretin)
Pancreas—duct	NaHCO ₃ , NaCl	Secretin
Small intestine	NaCl	Acetylcholine, serotonin, vasoactive intestinal peptide (VIP), guanylin

ent in relatively high amounts in the gastrointestinal tract (Figure 26.7). It stimulates secretion of NaCl by the small intestinal mucosa.

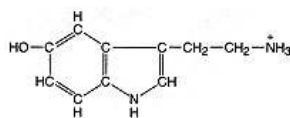

Figure 26.7
5-OH-Tryptamine (serotonin).

A third class of secretagogues consists of peptide-neurotransmitters and -hormones (Table 26.4). The intestinal nerve cells are rich in peptide-neurotransmitters that stimulate NaCl secretion. **Vasoactive intestinal peptide (VIP)** is a particularly potent one in this respect in the intestines and pancreas. Furthermore, the gastrointestinal tract contains many specialized epithelial cells that produce biologically active amines and peptides. The peptides are localized in granules, usually close to the contraluminal pole of these cells, and are released into the blood. Hence these cells are classified as **epithelial endocrine cells**. Of particular importance are the peptides gastrin, cholecystokinin (pancreozymin), and secretin. In contrast, a recently identified peptide—namely, **guanylin**—is released into the lumen and stimulates NaCl secretion by binding to a brush border receptor that activates guanylate cyclase and thus elevates cGMP levels.

Gastrin occurs as either a peptide of 34 amino acids (G-34) or one of 17 residues (G-17) from the COOH terminus of G-34. The functional portion of gastrin resides mainly in the last five amino acids of the COOH terminus. Thus pentagastrin, an artificial pentapeptide containing only the last five amino acids, can be used specifically to stimulate gastric HCl and pepsin secretion. Gastrin as well as cholecystokinin have an interesting chemical feature, a **sulfated tyrosine**, which considerably enhances the potency of both hormones.

Cholecystokinin and **pancreozymin** denote the same peptide. The different names allude to the different functions elicited by the peptide and had been coined before purification. The peptide stimulates gallbladder contraction (cholecystokinin) as well as secretion of pancreatic enzymes (pancreozymin). It is secreted by epithelial endocrine cells of the small intestine, particularly in the duodenum, and this secretion is stimulated by luminal amino acids and peptides, usually derived from gastric proteolysis, by fatty acids, and by an acid pH. Cholecystokinin and gastrin are thought to be related in an evolutionary sense, as both share an identical amino acid sequence at the COOH terminus.

TABLE 26.4 Structure of Human Intestinal Peptide Hormones

Vasoactive intestinal peptide (VIP)	
His-Ser-Asp-Ala-Val-Phe-Thr-Asp-Asn-Tyr-Thr-Arg-Leu-Arg-Lys-Gln-Met-Ala-Val-Lys	
	Asn-Leu-Ile-Ser-Asn-Leu-Tyr-Lys
Secretin	
His-Ser-Asp-Gly-Thr-Phe-Thr-Ser-Glu-Leu-Ser-Arg-Leu-Arg-Glu-Gly-Ala-Arg-Leu-Gln	
	^c NH ₂ -Val-Leu-Gly-Gln-Leu-Leu-Arg
Guanylin	
Pro-Gly-Thr-Cys-Glu-Ile-Cys-Ala-Tyr-Ala-Ala-Cys-Thr-Gly-Cys	
Gastrin G-34-II* G-17-II	
^a Glp-Leu-Gly-Pro-Gln-Gly-Pro-Pro-His-Leu-Val-Ala-Asp-Pro-Ser-Lys-Lys-Gln	
	^c NH ₂ -Phe-Asp-Met-Trp-Gly-Tyr(SO ₃ H)-Ala-(Glu) ₃ -Leu-Trp-Pro-Gly
Cholecystokinin	
Lys-Ala-Pro-Ser-Gly-Arg-Met-Ser-Ile-Val-Lys-Asn-Leu-Gln-Asn-Leu-Asp-Pro	
	^c NH ₂ -Phe-Asp-Met-Trp-Gly-Met-Tyr(SO ₃ H)-Asp-Arg-Asp-Ser-Ile-Arg-His-Ser

Source: Yanaihara, C. In: B. B. Rauner, G. M. Makhlof, and S. G. Schultz (Eds.), *Handbook of Physiology, Section 6: Alimentary Canal, Vol. II: Neural and Endocrine Biology*. Bethesda, MD: American Physiological Society, 1989, pp. 45–62.

*Gastrin I is not sulfated.

^aGlp = pyrrolidino carboxylic acid, derived from Glu through internal amide formation.

^cNH₂ = amide of carboxy-terminal amino acid.

Secretin is a polypeptide of 27 amino acids. This peptide is secreted by yet other endocrine cells of the small intestine. Its secretion is stimulated particularly by luminal pH less than 5. The major biological activity of secretin is stimulation of secretion of pancreatic juice rich in NaHCO_3 . Pancreatic NaHCO_3 is essential for neutralization of gastric HCl in the duodenum. Secretin also enhances pancreatic enzyme release, acting synergistically with cholecystokinin.

26.3— Epithelial Transport

Solute Transport May Be Transcellular or Paracellular

Solute movement across an epithelial cell layer is determined by the properties of epithelial cells, particularly their plasma membranes, and by the intercellular tight junctional complexes (Figure 26.8). The **tight junctions** extend in a belt-like manner around the perimeter of each epithelial cell and connect neighboring cells. Therefore the tight junctions constitute part of the barrier between the two extracellular spaces on either side of the epithelium, that is, the lumen of the gastrointestinal tract and the intercellular (interstitial) space on the other (blood or serosal) side. The tight junction marks the boundary between the luminal and contraluminal region of the plasma membrane of epithelial cells.

Two potentially parallel pathways for **solute transport** across epithelial cell layers can be distinguished: through the cells (**transcellular**) and through the tight junctions between cells (**paracellular**) (Figure 26.8). The transcellular route in turn consists mainly of two barriers in series, formed by the luminal and contraluminal plasma membranes. Because of this combination of different barriers in parallel (cellular and paracellular pathways) and in series (luminal and contraluminal plasma membranes), biochemical and biophysical information on all three barriers as well as their mutual influence is required for understanding the overall transport properties of the epithelium.

A major function of gastrointestinal epithelial cells is **active transport** of nutrients, electrolytes, and vitamins. The cellular basis for this vectorial solute movement lies in the different properties of the luminal and contraluminal regions of the plasma membrane. The small intestinal cells provide a prominent example of the differentiation and specialization of the two types of membrane. The luminal and contraluminal plasma membranes differ in morphological appearance, enzymatic composition, chemical composition, and transport functions (Table 26.5). The luminal membrane is in contact with the nutrients in the chyme (the semifluid mass of partially digested food) and is specialized for terminal digestion of nutrients through its digestive enzymes and for nutrient absorption through transport systems that accomplish concentrative uptake. Transport systems are present for monosaccharides, amino acids, peptides, and electrolytes. In contrast, the contraluminal plasma membrane, which is in contact with the intercellular fluid, capillaries, and lymph, has properties similar to the

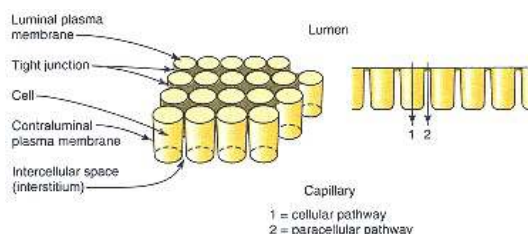

Figure 26.8
Pathways for transport across epithelia.

TABLE 26.5 Characteristic Differences Between Luminal and Contraluminal Plasma Membrane of Small Intestinal Epithelial Cells

<i>Parameter</i>	<i>Luminal</i>	<i>Contraluminal</i>
Morphological appearance	Microvilli in ordered arrangement (brush border)	Few microvilli
Enzymes	Di- and oligosaccharidases	Na ⁺ ,K ⁺ -ATPase
	Aminopeptidase	Adenylyl cyclase
	Dipeptidases	
	γ-Glutamyltransferase	
	Alkaline phosphatase	
	Guanylate cyclase	
Transport systems	Na ⁺ -monosaccharide cotransport (SGLT1)	Facilitated monosaccharide transport (GLUT2)
	Facilitated fructose transport (GLUT5)	Facilitated neutral amino acid transport
	Na ⁺ -neutral amino acid cotransport	
	Na ⁺ -bile acid cotransport	

plasma membrane of most cells. It possesses receptors for hormonal or neuronal regulation of cellular functions, a Na⁺,K⁺-ATPase for removal of Na⁺ from the cell, and transport systems for the entry of nutrients for consumption by the cell. In addition, the contraluminal plasma membrane contains the transport systems necessary for exit of the nutrients derived from the lumen so that the digested food can become available to all cells of the body. Some of the transport systems in the contraluminal plasma membrane may fulfill both the function of catalyzing exit when the intracellular nutrient concentration is high after a meal and that of mediating their entry when the blood levels are higher than those within the cell.

NaCl Absorption Has Both Active and Passive Components

Transport of Na⁺ plays a crucial role not only for epithelial NaCl absorption or secretion, but also in the energization of nutrient uptake. The **Na⁺,K⁺-ATPase** provides the dominant mechanism for transduction of chemical energy in the form of ATP into osmotic energy of a concentration (chemical) or a combined concentration and electrical (electrochemical) ion gradient across the plasma membrane. In epithelial cells this enzyme is located exclusively in the contraluminal plasma membrane (Figure 26.9). The stoichiometry of the Na⁺,K⁺-ATPase reaction is 1 mol of ATP coupled to the outward pumping of 3 mol of Na⁺ and the simultaneous inward pumping of 2 mol of K⁺. The Na⁺,K⁺-ATPase maintains the high K⁺ and low Na⁺ concentrations in the cytosol and is directly or indirectly responsible for an electrical potential of about -60 mV of the cytoplasm relative to the extracellular solution. The direct contribution comes from the charge movement when 3Na⁺ ions are replaced by 2K⁺; the indirect contribution is by way of the K⁺ gradient, which becomes the dominant force for establishing the potential by the movement of K⁺ through K⁺ channels.

Transepithelial NaCl movements are produced by the combined actions of the Na⁺,K⁺-ATPase and additional "passive" transport systems in the plasma membrane, which allow the entry of Na⁺ or Cl⁻ into the cell. NaCl absorption results from Na⁺ entry into the cell across the luminal plasma membrane and its extrusion by the Na⁺,K⁺-ATPase across the contraluminal membrane. Epithelial cells of the lower portion of the large intestine possess a luminal **Na⁺ channel (epithelial Na⁺ channel or ENaC)** that allows the uncoupled entry of Na⁺ down its electrochemical gradient (Figure 26.10). This Na⁺ flux is **electrogenic**; that is, it is associated with an electrical current, and it can be inhibited by

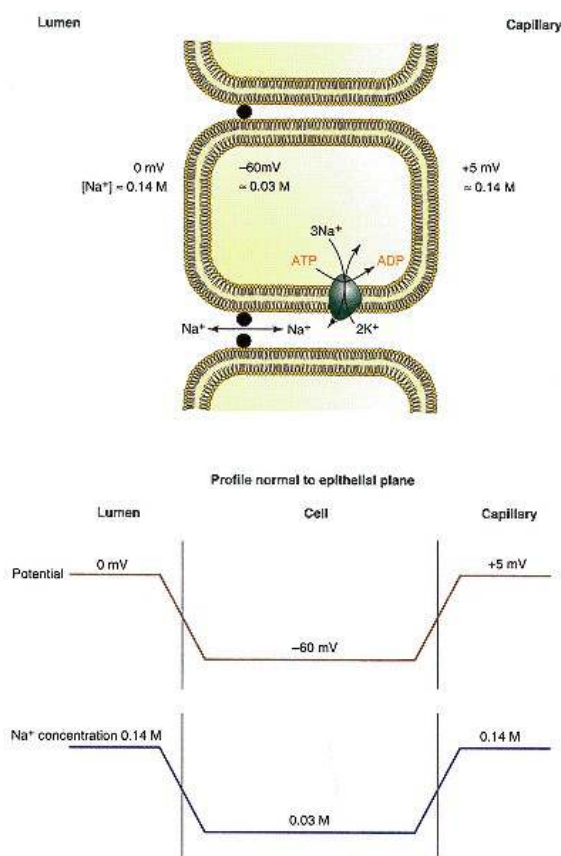

Figure 26.9

Na⁺ concentrations and electrical potentials in enterocytes.

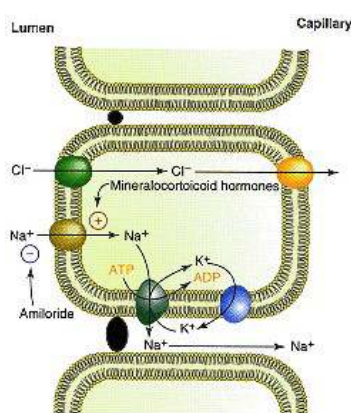
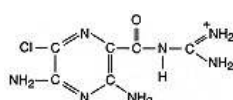

Figure 26.10

Model for electrogenic NaCl absorption in the lower intestine.

the diuretic drug amiloride at micromolar concentrations (Figure 26.11). The presence of this transport system, and hence NaCl absorption, is regulated by mineralocorticoid hormones of the adrenal cortex.

Figure 26.11
Amiloride.

Epithelial cells of the small intestine possess a transport system in the brush border membrane, which catalyzes an electrically neutral Na⁺/H⁺ exchange (Na/H exchanger or NHE) (Figure 26.12). The exchange is not affected by low concentrations of amiloride and not regulated by mineralocorticoids. The Na⁺ absorption secondarily drives Cl⁻ absorption through a specific Cl⁻/HCO₃⁻ exchanger (anion exchanger or AE) in the luminal plasma membrane, as illustrated in Figure 26.12. The necessity for two types of NaCl absorption may arise from the different functions of upper and lower intestine, which require different regulation. The upper intestine reabsorbs the bulk of NaCl from the diet and from secretions of the exocrine glands after each meal, while the lower intestine participates in the fine regulation of NaCl retention, depending on the overall electrolyte balance of the body.

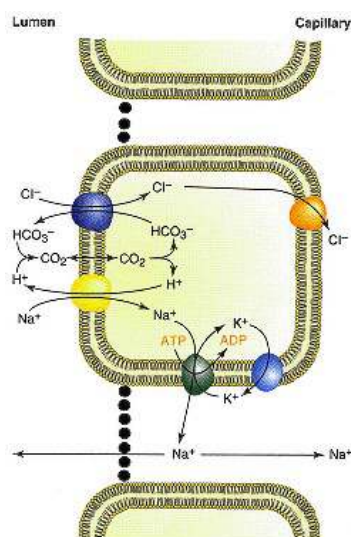

Figure 26.12

Model for electrically neutral NaCl absorption in the small intestine.

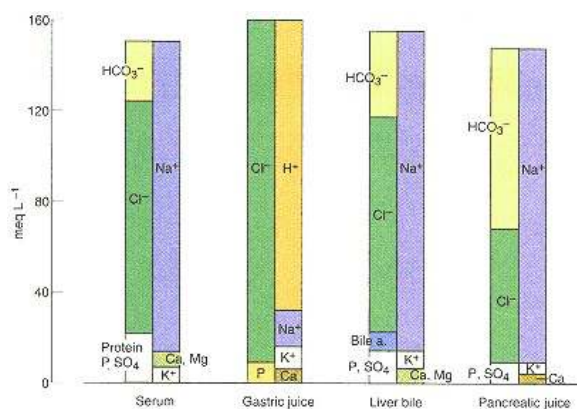

Figure 26.13

Ionic composition of secretions of the gastrointestinal tract.

Serum included for comparisons. Note the high H^+ concentration in gastric juice (pH + 1) and the high HCO_3^- concentration in pancreatic juice. P, organic and inorganic phosphate; SO_4 inorganic and organic sulfate;

Ca, calcium; Mg, magnesium; bile a., bile acids.

Adapted from *Biological Handbooks. Blood and Other Body Fluids*. Federation of American Societies for Experimental Biology, 1961.

NaCl Secretion Depends on Contraluminal Na^+, K^+ -ATPase

The epithelial cells of most regions of the gastrointestinal tract have the potential for electrolyte and fluid secretions. The major secreted ions are Na^+ and Cl^- . Water follows passively because of the osmotic forces exerted by any secreted solute. Thus NaCl secretion secondarily results in fluid secretion. The fluid may be either hypertonic or isotonic, depending on the contact time of the secreted fluid with the epithelium and the tissue permeability to water. The longer the contact and the greater the water permeability, the closer the secreted fluid gets to osmotic equilibrium, that is, isotonicity. Ionic compositions of gastrointestinal secretions are presented in Figure 26.13.

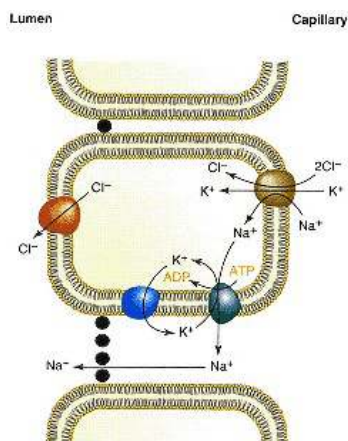

Figure 26.14

Model for epithelial NaCl secretion.

The cellular mechanisms for NaCl secretion involve the Na^+, K^+ -ATPase located in the contraluminal plasma membrane of epithelial cells (Figure 26.14). The enzyme is implicated because cardiac glycosides, inhibitors of this enzyme, abolish salt secretion. However, the involvement of Na^+, K^+ -ATPase does not provide a straightforward explanation for a NaCl movement from the capillary side to the lumen because the enzyme extrudes Na^+ from the cell toward the capillary side. Thus the active step of Na^+ transport across one of the plasma membranes has a direction opposite to that of overall transepithelial NaCl movements. The apparent paradox is resolved by an electrical coupling of Cl^- secretion across the luminal plasma membrane and Na^+ movements via the paracellular route, illustrated in Figure 26.14. The Cl^- secretion depends on coupled uptake of 2 Cl^- ions with Na^+ and K^+ via a specific cotransporter in the contraluminal plasma membrane and specific luminal Cl^- channels. The $Na^+, K^+, 2 Cl^-$ -cotransporter, which can be identified by specific inhibitors such as the common diuretic **furosemide** (Figure 26.15), utilizes the energy of the Na^+ gradient to accumulate Cl^- within the cytoplasmic compartment above its electrochemical equilibrium concentration. Subsequent opening of luminal Cl^- channels allows efflux of Cl^- together with a negative charge (see Clin. Corr. 26.1 and 26.2).

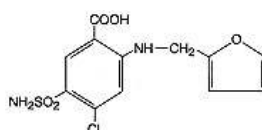

Figure 26.15

Furosemide.

In the pancreas a fluid rich in Na^+ and Cl^- is secreted by acinar cells. This fluid provides the vehicle for the movement of digestive enzymes from the acini, where they are released, to the lumen of the duodenum. The fluid is modified in the ducts by the additional secretion of $NaHCO_3$ (Figure 26.16). The HCO_3^- concentration in the final pancreatic juice can reach concentrations of up to 120 mM.

The permeability of the tight junction to H_2O , Na^+ or other ions modifies

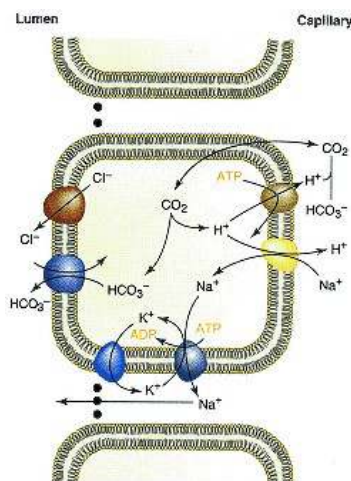

Figure 26.16

Model for epithelial NaHCO_3 secretion.

Note that two different mechanisms for H^+ secretion exist in the contraluminal plasma membrane: (1) Na^+/H^+ exchange and (2) H^+-ATPase .

CLINICAL CORRELATION 26.1**Cystic Fibrosis**

Cystic fibrosis is an autosomal recessive inherited disease due to a mutation in the cystic fibrosis transmembrane regulatory (CFTR) protein. This protein contains 1480 amino acids organized into two membrane-spanning portions, which contain six transmembrane regions each, two ATP-binding domains, and a regulatory domain that undergoes phosphorylation by cAMP-dependent protein kinase. Some 400 mutations have been discovered since the gene was cloned in 1989.

The normal form of this protein is a Cl^- channel that is found in the luminal plasma membrane of epithelial cells in many tissues. The channel is normally closed but opens when phosphorylated by protein kinase A, thus providing regulated Cl^- and fluid secretion. The most common and severe mutation lacks one amino acid (F508 CFTR), which prevents the protein from properly maturing and reaching the plasma membrane. People who inherit this mutant CFTR from both parents lack Cl^- and fluid secretion in tissues that depend on CFTR for this function. Failure to secrete fluid, in turn, can lead to gross organ impairment due to partial or total blockage of passageways, for example, the ducts in the pancreas, the lumen of the intestine, or airways. (See Clin. Corr. 26.2 for activation of the CFTR Cl^- channel.)

active transepithelial solute movements. For example, a high permeability is necessary to allow Na^+ to equilibrate between extracellular solutions of the intercellular and luminal compartments during NaCl or NaHCO_3 secretion. Different regions of the gastrointestinal tract differ not only with respect to the transport systems that determine the passive entry (see above for amiloride-sensitive Na^+ channel and Na^+/H^+ exchange), but also with respect to the permeability characteristics of the tight junction. The distal portion (colon) is much tighter so as to prevent leakage of Na^+ from blood to lumen, in accordance with its function of scavenging of NaCl from the lumen.

Concentration Gradients or Electrical Potentials Drive Transport of Nutrients

Many solutes are absorbed across the intestinal epithelium against a concentration gradient. Energy for this "active" transport is directly derived from the Na^+ concentration gradient or the electrical potential across the luminal plasma membrane, rather than from the chemical energy of a covalent bond change, such as ATP hydrolysis. Glucose transport provides an example of uphill solute transport that is driven directly by the electrochemical Na^+ gradient and only indirectly by ATP (Figure 26.17).

Glucose is absorbed from the intestinal lumen into the blood against a concentration gradient. This vectorial transport is the combined result of several separate membrane events (Figure 26.18): (1) ATP-dependent Na^+ transport out of the cell at the contraluminal pole that establishes an electrochemical Na^+ gradient across the plasma membrane; (2) K^+ channels that convert a K^+ gradient into a membrane potential; (3) asymmetric insertion of two different transport systems for glucose into the luminal and contraluminal plasma membranes; and (4) coupling of Na^+ and glucose transport across the luminal membrane.

The luminal plasma membrane contains a transport system that facilitates a tightly coupled movement of Na^+ and D-glucose or structurally similar sugars

CLINICAL CORRELATION 26.2

Bacterial Toxicogenic Diarrheas and Electrolyte Replacement Therapy

Voluminous, life-threatening intestinal electrolyte and fluid secretion (diarrhea) occurs in patients with cholera, an intestinal infection by *Vibrio cholerae*. Certain strains of *E. coli* also cause (traveler's!) diarrhea that can be serious in infants. The secretory state is a result of enterotoxins produced by the bacteria. The mechanisms of action of some of these enterotoxins are well understood at the biochemical level. Cholera toxin activates adenylyl cyclase by causing ADP-ribosylation of the G_{α_s} -protein, which stimulates the cyclase (see p. 859). Elevated cAMP levels in turn activate protein kinase A, which opens the luminal CFTR Cl^- channel and inhibits the Na^+/H^+ exchanger by protein phosphorylation. The net result is gross $NaCl$ secretion. *Escherichia coli* produces a heat-stable toxin that binds to the receptor for the physiological peptide "guanylin," namely, the brush border guanylyl cyclase. When the receptor is occupied on the luminal side by either guanylin or the heat-stable *E. coli* toxin, the guanylyl cyclase domain of the protein on the cytosolic side is activated and cGMP levels rise. Elevated cGMP levels have the same effect on Cl^- secretion as elevated cAMP levels, except that a cGMP-activated protein kinase is involved in protein phosphorylation.

Modern, oral treatment of cholera takes advantage of the presence of Na^+ -glucose cotransport in the intestine, which is not regulated by cAMP and remains fully active in this disease. In this case, the presence of glucose allows uptake of Na^+ to replenish body $NaCl$. Composition of solution for oral treatment of cholera patients is glucose 110 mM, Na^+ 99 mM, Cl^- 74 mM, HCO_3^- 29 mM, and K^+ 4 mM. The major advantages of this form of therapy are its low cost and ease of administration when compared with intravenous fluid therapy.

Carpenter, C. C. J. In: M. Field, J. S. Fordtran, and S. G. Schultz (Eds.), *Secretory Diarrhea*. Bethesda, MD: American Physiological Society, 1980, pp. 67–83.

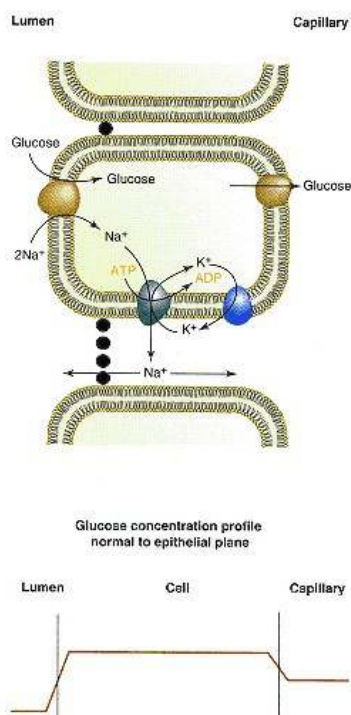

Figure 26.17

Model for epithelial glucose absorption.

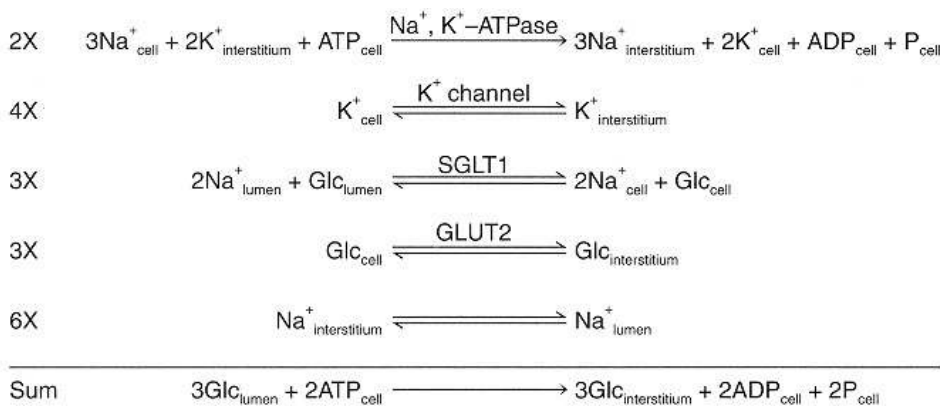

Figure 26.18

Transcellular glucose transport as translocation reactions across the plasma membranes and the tight junction.

SGLT1 (sodium glucose transporter 1) and GLUT2 (glucose transporter 2) are specific intestinal gene products mediating Na^+ -glucose cotransport and facilitated glucose transport, respectively. Numbers in the left column indicate the minimal turnover of individual reactions to balance the overall reaction.

(Sodium Glucose Transporter or SGLT). The most common intestinal sodium-glucose cotransporter is **SGLT1** and it couples the movement of 2 Na⁺ ions with that of 1 glucose molecule. It mediates glucose and Na⁺ transport equally well in both directions. However, because of the higher Na⁺ concentration in the lumen and the negative potential within the cell, the observed direction is from lumen to cell, even if the cellular glucose concentration is higher than the luminal one. In other words, downhill Na⁺ movement normally supports concentrative glucose transport. Concentration ratios of up to 20-fold between intracellular and extracellular glucose have been observed *in vitro* under conditions of blocked efflux of cellular glucose. In some situations Na⁺ uptake via this route is actually more important than glucose uptake (see Clin. Corr. 26.2).

The contraluminal plasma membrane contains a member of the **GLucose Transporter** (or **GLUT**) family, which facilitates glucose exit and entry. The intestine contains the **GLUT2** transporter, which accepts many monosaccharides, including glucose. The direction of net flux is determined by the sugar concentration gradient. The two glucose transport systems SGLT1 and GLUT2 in the luminal and contraluminal plasma membranes, respectively, share glucose as substrate, but otherwise differ considerably in terms of amino acid sequence, secondary protein structure, Na⁺ as cosubstrate, specificity for other sugars, sensitivity to inhibitors, or biological regulation. Since both SGLT and GLUT are not inherently directional, "active" transepithelial glucose transport can be maintained under steady-state conditions only if the Na⁺,K⁺-ATPase continues to move Na⁺ out of the cell. Thus the active glucose transport is indirectly dependent on a supply of ATP and an active Na⁺,K⁺-ATPase.

The advantage of an electrochemical Na⁺ gradient serving as intermediate is that the Na⁺,K⁺-ATPase can energize the transport of many different nutrients. The only requirement is presence of a transport system catalyzing cotransport of the nutrient with Na⁺.

Gastric Parietal Cells Secrete HCl

The parietal (oxyntic) cells of gastric glands are capable of secreting HCl into the gastric lumen. Luminal H⁺ concentrations of up to 0.14 M (pH 0.8) have been observed (see Figure 26.13). As the plasma pH = 7.4, the parietal cell transports protons against a concentration gradient of 10^{6.6}. The free energy required for **HCl secretion** under these conditions is minimally 9.1 kcal mol⁻¹ of HCl (= 38 J mol⁻¹ of HCl), as calculated from

$$\Delta G' = -RT 2.3 \log 10^{6.6} \quad RT = 0.6 \text{ kcal mol}^{-1} \text{ at } 37^\circ\text{C}$$

A K⁺-activated ATPase (**K⁺,H⁺-ATPase**) is intimately involved in the mechanism of active HCl secretion. This enzyme is unique to the parietal cell and is found only in the luminal region of the plasma membrane. It couples the hydrolysis of ATP to an electrically neutral obligatory exchange of K⁺ for H⁺, secreting H⁺ and taking K⁺ into the cell. The stoichiometry appears to be 1 mol of transported H⁺ and K⁺ for each mole of ATP.

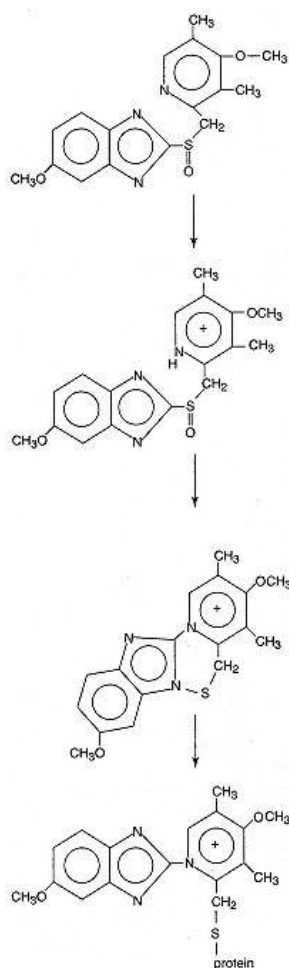

Figure 26.19

Omeprazole, an inhibitor of K⁺,H⁺-ATPase.

This drug accumulates in an acidic compartment (pK_a ~ 4) and is converted to a reactive sulfenamide, which reacts with cysteine SH groups.

From Sachs, G. The gastric H,K-ATPase. In: L. R. Johnson (Ed.), *Physiology of the Gastrointestinal Tract*. New York: Raven Press, 1994, p. 1133.

As the K⁺,H⁺-ATPase generates a very acidic solution, protein reagents that are activated by acid can become specific inhibitors of this enzyme. Figure 26.19 shows an example of such a reagent used to treat peptic ulcers. In the steady state, HCl can be elaborated by K⁺, H⁺-ATPase only if the luminal membrane is permeable to K⁺ and Cl⁻ and the contraluminal plasma membrane catalyzes an exchange of Cl⁻ for HCO₃⁻ (Figure 26.20). The exchange of Cl⁻ for HCO₃⁻ is essential to resupply the cell with Cl⁻ and to prevent accumulation of base within the cell. Thus, under steady-state conditions, secretion of HCl into the gastric lumen is coupled to movement of HCO₃⁻ into the plasma.

26.4— Digestion and Absorption of Proteins

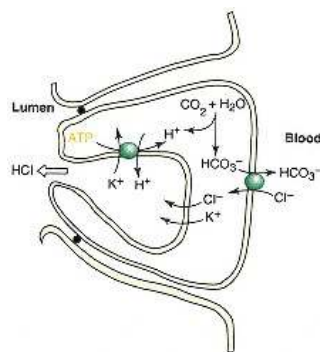

Figure 26.20
Model for secretion of hydrochloric acid.

Mixture of Peptidases Assures Efficient Protein Digestion

The total daily protein load to be digested consists of about 70–100 g of dietary proteins and 35–200 g of endogenous proteins from digestive enzymes and sloughed-off cells. Digestion and absorption of proteins are very efficient processes in healthy humans, since only about 1–2 g of nitrogen are lost through feces each day, which is equivalent to 6–12 g of protein.

Except for a short period after birth, oligo- and polypeptides (proteins) are not absorbed intact in appreciable quantities by the intestine. Proteins are broken down by hydrolases with specificity for the peptide bond, that is, by peptidases. This class of enzymes is divided into **endopeptidases** (proteases), which attack internal bonds and liberate large peptide fragments, and **exopeptidases**, which cleave off one amino acid at a time from either the COOH (**carboxypeptidases**) or the NH₂ terminus (**aminopeptidases**). Endopeptidases are important for an initial breakdown of long polypeptides into smaller products, which can then be attacked more efficiently by exopeptidases. The final products are free amino acids and di- and tripeptides, which are absorbed by epithelial cells (Figure 26.21).

The process of protein digestion can be divided into a gastric, a pancreatic, and an intestinal phase, depending on the source of peptidases.

Pepsins Catalyze Gastric Digestion of Protein

Gastric juice is characterized by the presence of HCl and therefore a low pH less than 2 as well as the presence of proteases of the pepsin family. The acid serves to kill off microorganisms and also to **denature proteins**. Denaturation makes proteins more susceptible to hydrolysis by proteases. **Pepsins** are unique in that they are acid stable; in fact, they are active at acid but not at neutral pH. The catalytic mechanism that is effective for peptide hydrolysis at the acid pH depends on two carboxylic groups at the active site of the enzymes. Pepsin A, the major gastric protease, prefers peptide bonds formed by the amino group of aromatic acids (Phe, Tyr) (Table 26.6).

Active pepsin is generated from the proenzyme **pepsinogen** by the removal of 44 amino acids from the NH₂ terminus (pig enzyme). Cleavage between residues 44 and 45 of pepsinogen occurs as either an intramolecular reaction (**autoactivation**) below pH 5 or by active pepsin (autocatalysis). The liberated peptide from the NH₂ terminus remains bound to pepsin and acts as "pepsin

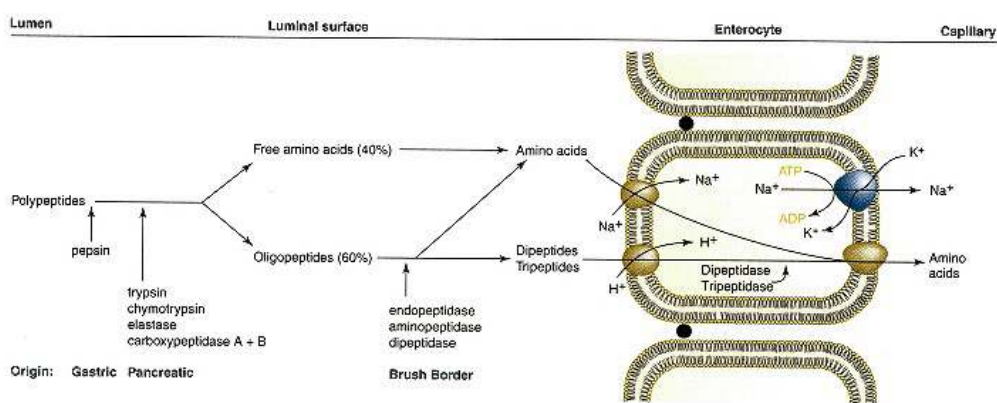

Figure 26.21
Digestion and absorption of proteins.

TABLE 26.6 Gastric and Pancreatic Peptidases

Enzyme	Proenzyme	Activator	Cleavage Point	R
CARBOXYL PROTEASES Pepsin A	Pepsinogen A	Autoactivation, pepsin	$\begin{array}{c} \text{R} \quad \text{R}' \\ \quad \\ \text{---CO---NHCHCO---NHCHCO---} \\ \downarrow \quad \downarrow \end{array}$	Tyr, Phe, Leu
SERINE PROTEASES Trypsin	Trypsinogen	Enteropeptidase, trypsin	$\begin{array}{c} \text{R} \quad \text{R}' \\ \quad \\ \text{---CO---NHCHCO---NHCHCO---} \\ \downarrow \quad \end{array}$	Arg, Lys
Chymotrypsin	Chymotrypsinogen	Trypsin	$\begin{array}{c} \text{R} \quad \text{R}' \\ \quad \\ \text{---CO---NHCHCO---NHCHCO---} \\ \downarrow \quad \end{array}$	Tyr, Trp, Phe, Met, Leu
Elastase	Proelastase	Trypsin	$\begin{array}{c} \text{R} \quad \text{R}' \\ \quad \\ \text{---CO---NHCHCO---NHCHCO---} \\ \downarrow \quad \end{array}$	Ala, Gly, Ser
ZINC PEPTIDASES Carboxypeptidase A	Procarboxypeptidase A	Trypsin	$\begin{array}{c} \text{R} \\ \\ \text{---CO---NHCHCOO}^- \\ \downarrow \end{array}$	Val, Leu, Ile, Ala
Carboxypeptidase B	Procarboxypeptidase B	Trypsin	$\begin{array}{c} \text{R} \\ \\ \text{---CO---NHCHCOO}^- \\ \downarrow \end{array}$	Arg, Lys

inhibitor" above pH 2. This inhibition is released either by a drop of the pH below 2 or further degradation of the peptide by pepsin. Thus, once favorable conditions are reached, pepsinogen is converted to pepsin by autoactivation and subsequent autocatalysis at an exponential rate.

The major products of pepsin action are large peptide fragments and some free amino acids. The importance of gastric protein digestion does not lie so much in its contribution to the breakdown of ingested macromolecules, but rather in the generation of peptides and amino acids that act as stimulants for **cholecystokinin** release in the duodenum. The gastric peptides therefore are instrumental in the initiation of the pancreatic phase of protein digestion.

Pancreatic Zymogens Are Activated in Small Intestine

Pancreatic juice is rich in proenzymes of **endopeptidases** and **carboxypeptidases** (Figure 26.22), which are activated after they reach the lumen of the small intestine. **Enteropeptidase** (old name: enterokinase), a protease produced by duodenal epithelial cells, activates pancreatic **trypsinogen** to **trypsin** by scission of a hexapeptide from the NH₂ terminus. Trypsin in turn autocatalytically activates more trypsinogen to trypsin and also acts on the other proenzymes, thus liberating the endopeptidases chymotrypsin and elastase and the **carboxypeptidases A and B**. Since trypsin plays a pivotal role among pancreatic enzymes in the activation process, pancreatic juice normally contains a small-molecular-weight peptide that acts as a **trypsin inhibitor** and neutralizes any trypsin formed prematurely within the pancreatic cells or pancreatic ducts.

Trypsin, chymotrypsin, and elastase have different substrate specificity, as shown in Table 26.6. They are active only at neutral pH and depend on pancreatic NaHCO₃ for neutralization of gastric HCl. Their mechanism of catalysis involves an **essential serine residue** (see p. 97) and is thus similar to serine esterases, such as acetyl choline esterase. Reagents that interact with serine and modify it, inactivate serine esterases and peptidases. A prominent example of such a reagent is the highly toxic diisopropylphosphorofluoridate, which was developed originally for chemical warfare (neurotoxic because of inhibition of acetyl choline esterase).

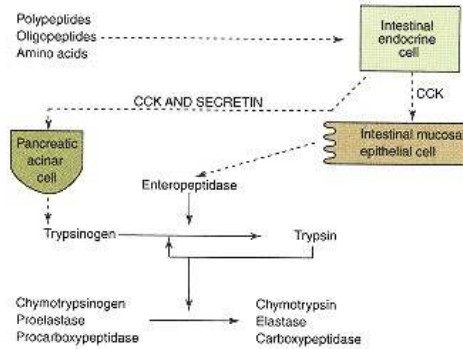

Figure 26.22

Secretion and activation of pancreatic enzymes.

Abbreviation: CCK, cholecystokinin.

Reproduced with permission from Freeman, H. J., and

Kim, Y. S. *Annu. Rev. Med.* 29:102, 1978.

Copyright © 1978 by Annual Reviews, Inc.

Polypeptides generated from ingested proteins are degraded within the small intestinal lumen by **carboxypeptidases A and B**. The **pancreatic carboxypeptidases** are **Zn²⁺** metalloenzymes and possess a different type of catalytic mechanism than the carboxyl or serine peptidases. The combined action of pancreatic peptidases results in the formation of free amino acids and small peptides of 2–8 residues. Peptides account for about 60% of the amino nitrogen at this point.

Intestinal Peptidases Digest Small Peptides

Since pancreatic juice does not contain appreciable aminopeptidase activity, final digestion of di- and oligopeptides depends on small intestinal enzymes. The luminal surface of epithelial cells is particularly rich in endopeptidase and aminopeptidase activity, but also contains dipeptidases (Table 26.2). The end products of the cell surface digestion are free amino acids and di- and tripeptides, which are absorbed via specific **amino acid** or **peptide transport systems**. Transported di- and tripeptides are generally hydrolyzed within the cytoplasmic compartment before they leave the cell. The cytoplasmic dipeptidases explain why practically only free amino acids are found in the portal blood after a meal. The virtual absence of peptides had previously been taken as evidence that luminal protein digestion had to proceed all the way to free amino acids before absorption could occur. However, it is now established that a large portion of dietary amino nitrogen is absorbed in the form of small peptides with subsequent intracellular hydrolysis. However, di- and tripeptides containing proline and hydroxyproline or unusual amino acids, such as β -alanine as carnosine (β -alanylhistidine) or anserine (β -alanyl 1-methylhistidine), are absorbed without intracellular hydrolysis because they are not good substrates for the intestinal cytoplasmic dipeptidases. β -Alanine is present in chicken meat.

Free Amino Acids and Dipeptides Are Absorbed by Carrier-Mediated Transport

The small intestine has a high capacity to absorb free amino acids and small peptides. Most L-amino acids can be transported across the epithelium against a concentration gradient, although the need for concentrative transport *in vivo* is not obvious, since luminal concentrations are usually higher than the plasma levels of 0.1–0.2 mM. Amino acid and peptide transport in the small intestine has all the characteristics of carrier-mediated transport, such as discrimination between D- and L-amino acids and energy and temperature dependence. In addition, genetic defects are known to occur in humans (see Clin. Corr. 26.3).

CLINICAL CORRELATION 26.3**Neutral Amino Aciduria (Hartnup Disease)**

Transport functions, like enzymatic functions, are subject to modification by mutations. An example of a genetic lesion in epithelial amino acid transport is Hartnup disease, named after the family in which the disease entity resulting from the defect was first recognized. The disease is characterized by the inability of renal and intestinal epithelial cells to absorb neutral amino acids from the lumen. In the kidney, in which plasma amino acids reach the lumen of the proximal tubule through the ultrafiltrate, the inability to reabsorb amino acids manifests itself as excretion of amino acids in the urine (amino aciduria). The intestinal defect results in malabsorption of free amino acids from the diet. Therefore the clinical symptoms of patients with this disease are mainly those due to essential amino acid and nicotinamide deficiencies. The pellagra-like features (see p. 1121) are explained by a deficiency of tryptophan, which serves as precursor for nicotinamide. Investigations of patients with Hartnup disease revealed the existence of intestinal transport systems for di- or tripeptides, which are different from the ones for free amino acids. The genetic lesion does not affect transport of peptides, which remains as a pathway for absorption of protein digestion products.

Silk, D. B. A. Disorders of nitrogen absorption. In: J. T. Harries (Ed.), *Clinics in Gastroenterology: Familial Inherited Abnormalities*, Vol. 11: London: Saunders, 1982, pp. 47–73.

On the basis of genetics, transport experiments, and expression cloning, at least seven **brush border specific transport systems** for the uptake of L-amino acids or small peptides in the luminal membrane can be distinguished: (1) for neutral amino acids with short or polar side chains (Ser, Thr, Ala); (2) for neutral amino acids with aromatic or hydrophobic side chains (Phe, Tyr, Met, Val, Leu, Ile); (3) for imino acids (Pro, Hyp); (4) for β -amino acids (β -Ala, taurine); (5) for basic amino acids and cystine (Lys, Arg, Cys-Cys); (6) for acidic amino acids (Asp, Glu); and (7) for dipeptides (Pept1) (Gly-sarcosine).

The concentration mechanisms for neutral L-amino acids appear to be similar to those discussed for D-glucose (see Figure 26.17). **Na⁺-dependent transport systems** have been identified in the luminal (brush border) membrane and **Na⁺-independent transporters** in the contraluminal plasma membrane of small intestinal epithelial cells. Similarly, as for active glucose transport, the energy for concentrative amino acid transport is derived directly from the electrochemical Na⁺ gradient and only indirectly from ATP. Amino acids are not chemically modified during membrane transport, although they may be metabolized within the cytoplasmic compartment. The brush border transport for the other amino acids is energized in more complicated ways. For example, the **acidic amino acid transporter** mediates cotransport of the amino acid with 2 Na⁺ ions and counter transport with 1 K⁺ ion.

Neutral dipeptides are cotransported across the brush border membrane with a proton and thus are energized through the proton electrochemical gradient across this membrane. However, because of the Na⁺/H⁺ exchange, both gradients tend to be similar and interdependent. The dipeptide transporter also accepts β -lactam antibiotics (aminopenicillins) and is important for absorption of orally administered antibiotics of this class.

Fetus and Neonate Can Absorb Intact Proteins

The fetal and neonatal small intestines can absorb intact proteins. The uptake occurs by endocytosis, that is, the internalization of small vesicles of plasma membrane, which contain ingested macromolecules. The process is also termed **pinocytosis** because of the small size of vesicles. The small intestinal pinocytosis of protein is thought to be important for the transfer of maternal antibodies (γ -globulins) to the offspring, particularly in rodents. The pinocytotic uptake of proteins is not important for nutrition, and its magnitude usually declines after birth. Persistence of low levels of this process beyond the neonatal period may, however, be responsible for absorption of sufficient quantities of macro-molecules to induce antibody formation.

26.5—**Digestion and Absorption of Carbohydrates****Di- and Polysaccharides Require Hydrolysis**

Dietary carbohydrates provide a major portion of the daily caloric requirement. They consist of mono-, di-, and polysaccharides (Table 26.7). **Monosaccharides** need not be hydrolyzed for absorption. Disaccharides require the small intestinal surface enzymes for hydrolysis into monosaccharides, while polysaccharides depend on **pancreatic amylase** for degradation (Figure 26.23).

Starch, a major nutrient, is a plant polysaccharide with a molecular mass of more than 100 kDa. It consists of a mixture of linear chains of glucose molecules linked by α -1,4-glucosidic bonds (**amylose**) and of branched chains with branch points made up by α -1,6 linkages (**amylopectin**). The ratio of 1,4- to 1,6-glucosidic bonds is about 20 : 1. **Glycogen** is an animal polysaccharide similar in structure to amylopectin. The two compounds differ in terms of the number of branch points, which occur more frequently in glycogen.

TABLE 26.7 Dietary Carbohydrates

Carbohydrate	Typical Source	Structure	Chemical Structure
Amylopectin	Potatoes, rice, corn, bread	α -Glc(1-4) _n Glc with α -Glc(1-6) branches	
Amylose	Potatoes, rice, corn, bread	α -Glc(1-4) _n Glc	
Sucrose	Table sugar, desserts	α -Glc(1-2) β -Fru	
Trehalose	Young mushrooms	α -Glc(1-1) α -Glc	
Lactose	Milk, milk products	β -Gal(1-4)Glc	
Fructose	Fruit, honey	Fru	
Glucose	Fruit, honey, grape	Glc	
Raffinose	Leguminous seeds	α -Gal(1-6) α -Glc(1-2) β -Fru	

Hydrated starch and glycogen are attacked by the endosaccharidase **α -amylase** present in saliva and pancreatic juice (Figure 26.24). Hydration of the polysaccharides occurs during heating and is essential for efficient digestion. Amylase is specific for internal α -1,4-glycosidic bonds; α -1,6 bonds are not attacked, nor are α -1,4 bonds of glucose units that serve as branch points. The pancreatic isoenzyme is secreted in large excess relative to starch intake and

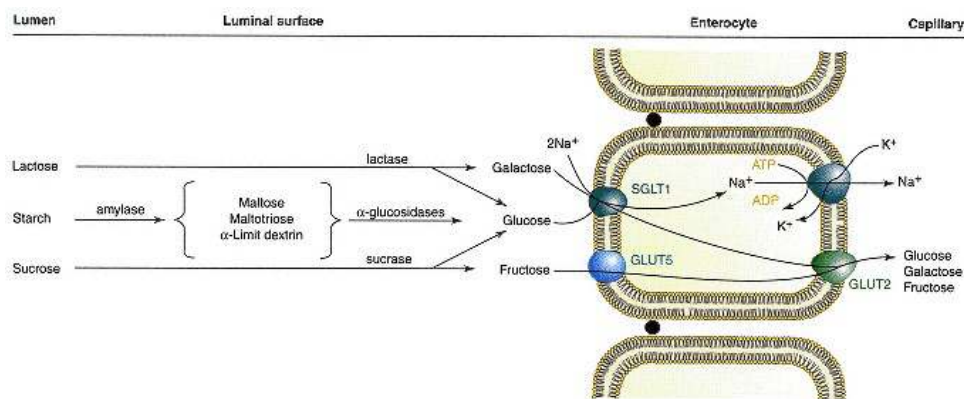

Figure 26.23
Digestion and absorption of carbohydrates.

CLINICAL CORRELATION 26.4

Disaccharidase Deficiency

Intestinal disaccharidase deficiencies are encountered relatively frequently in humans. Deficiency can be present in one enzyme or several enzymes for a variety of reasons (genetic defect, physiological decline with age, or the result of "injuries" to the mucosa). Of the disaccharidases, lactase is the most common enzyme with an absolute or relative deficiency, which is experienced as milk intolerance. The consequences of an inability to hydrolyze lactose in the upper small intestine are inability to absorb lactose and bacterial fermentation of ingested lactose in the lower small intestine. Bacterial fermentation results in the production of gas (distension of gut and flatulence) and osmotically active solutes that draw water into the intestinal lumen (diarrhea). The lactose in yogurt has already been partially hydrolyzed during the fermentation process of making yogurt. Thus individuals with lactase deficiency can often tolerate yogurt better than unfermented dairy products. The enzyme lactase is commercially available to pretreat milk so that the lactose is hydrolyzed.

Buller, H. A., and Grant, R. G. Lactose intolerance. *Annu. Rev. Med.* 41:141, 1990.

is more important than the salivary enzyme from a digestive point of view. The products of the digestion by α -amylase are mainly the **disaccharide maltose**, the **trisaccharide maltotriose**, and so-called **α -limit dextrins** containing on average eight glucose units with one or more α -1,6-glucosidic bonds.

Final hydrolysis of di- and oligosaccharides to monosaccharides is carried out by surface enzymes of the small intestinal epithelial cells (Table 26.8). Most of the surface oligosaccharidases are exoenzymes that cleave off one monosaccharide at a time from the nonreducing end. The capacity of the **α -glucosidases** is normally much greater than that needed for completion of the digestion of starch. Similarly, there is usually excess capacity for sucrose (table sugar) hydrolysis relative to dietary intake. In contrast, **β -galactosidase (lactase)** can be rate-limiting in humans for hydrolysis and utilization of lactose, the major milk carbohydrate (see Clin. Corr. 26.4).

Di-, oligo-, and polysaccharides that are not hydrolyzed by α -amylase and/or intestinal surface enzymes cannot be absorbed; therefore they reach the lower tract of the intestine, which from the lower ileum on contains bacteria. Bacteria can utilize many of the remaining carbohydrates because they possess many more types of saccharidases than humans. Monosaccharides that are released as a result of **bacterial enzymes** are predominantly metabolized anaerobically by the bacteria themselves, resulting in degradation products such as short-chain fatty acids, lactate, hydrogen gas (H_2), methane (CH_4), and carbon

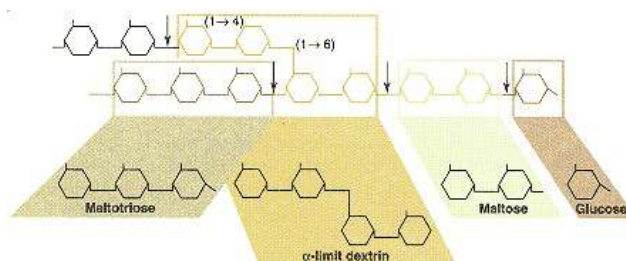

Figure 26.24
Digestion of amylopectin by salivary and pancreatic α -amylase.

TABLE 26.8 Saccharidases of the Surface Membrane of the Small Intestine

Enzyme	Specificity	Natural Substrate	Product
<i>exo</i> -1,4- α -Glucosidase (glucoamylase)	α -(1-4)Glucose	Amylose	Glucose
Oligo-1,6-glucosidase (isomaltase)	α -(1-6)Glucose	Isomaltose, α -dextrin	Glucose
α -Glucosidase (maltase)	α -(1-4)Glucose	Maltose, maltotriose	Glucose
Sucrose- α -Glucosidase (sucrase)	α -Glucose	Sucrose	Glucose, fructose
α, α -Trehalase	α -(1-1)Glucose	Trehalose	Glucose
β -Glucosidase	β -Glucose	Glucosylceramide	Glucose, ceramide
β -Galactosidase (lactase)	β -Galactose	Lactose	Glucose, galactose

dioxide (CO₂). These compounds can cause fluid secretion, increased intestinal motility, and cramps, either because of increased intraluminal osmotic pressure, and distension of the gut, or a direct irritant effect of the bacterial degradation products on the intestinal mucosa.

The well-known problem of flatulence after ingestion of leguminous seeds (beans, peas, and soya) is caused by oligosaccharides, which cannot be hydrolyzed by human intestinal enzymes. The leguminous seeds contain modified sucrose to which one or more galactose moieties are linked. The glycosidic bonds of galactose are in the α configuration, which can only be split by bacterial enzymes. The simplest sugar of this family is **raffinose** (see Table 26.7).

Trehalose, a disaccharide that occurs in young mushrooms, requires a special disaccharidase, **trehalase**.

Monosaccharides Are Absorbed by Carrier-Mediated Transport

The major monosaccharides that result from digestion of di- and polysaccharide are D-glucose, D-galactose, and D-fructose. Absorption of these and other minor monosaccharides are carrier-mediated processes that exhibit such features as substrate specificity, stereospecificity, saturation kinetics, and inhibition by specific inhibitors.

At least two types of monosaccharide transporters catalyze monosaccharide uptake from the lumen into the cell: (1) a **Na⁺-monosaccharide cotransporter**, existing probably as a tetramer of 75-kDa peptides, has high specificity for D-glucose and D-galactose and catalyzes "active" sugar absorption (SGLT); and (2) a **Na⁺-independent, facilitated-diffusion** type of monosaccharide transport system with specificity for D-fructose (GLUT5). In addition, a **Na⁺-independent monosaccharide transporter** (GLUT2), consisting of 57-kDa peptide(s), which accepts all three monosaccharides, is present in the contraluminal plasma membrane. GLUT2 is also located in the liver and kidney, and other members of the GLUT family of glucose transporters are found in all cells. All GLUT transporters mediate uncoupled D-glucose flux down its concentration gradient. GLUT2 of gut, liver, and kidney moves D-glucose out of the cell into the blood under physiological conditions, while in other tissues GLUT1 (in erythrocytes and brain) or the insulin-sensitive GLUT4 (in fat and muscle tissue) are mainly involved in D-glucose uptake. Properties of intestinal SGLT1 and of GLUT2 are compared in Table 26.9, and their role in transepithelial glucose absorption is illustrated in Figure 26.18.

TABLE 26.9 Characteristics of Glucose Transport Systems in the Plasma Membranes of Enterocytes

Characteristic	Luminal	Contraluminal
Designation	SGLT1	GLUT2
Subunit molecular weight (kDa)	75	57
Effect of Na ⁺	Cotransport with Na ⁺	None
Good substrates	D-Glc, D-Gal, α -methyl-D-Glc	D-Glc, D-Gal, D-Man, 2-deoxy-D-Glc
Inhibitor	Phlorizin (Figure 26.25)	Cytochalasin B (Figure 26.26)

26.6— Digestion and Absorption of Lipids

Lipid Digestion Requires Overcoming the Limited Water Solubility of Lipids

An adult man ingests about 60–150 g of lipid per day. **Triacylglycerols** constitute more than 90% of the dietary fat. The rest is made up of phospholipids, cholesterol, cholesterol esters, and free fatty acids. In addition, 1–2 g of cholesterol and 7–22 g of phosphatidylcholine (lecithin) are secreted into the small intestine lumen as constituents of bile.

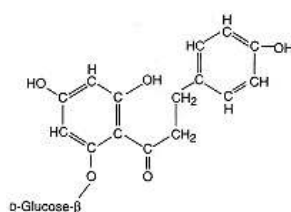

Figure 26.25
Phlorizin (phloretin-2-O-glucoside).

Lipids are defined by their good solubility in organic solvents and their sparing or lack of solubility in aqueous solutions. The poor water solubility presents problems for digestion because the substrates are not easily accessible to the digestive enzymes in the aqueous phase. In addition, even if ingested lipids are hydrolyzed into simple constituents, the products tend to aggregate to larger complexes that make poor contact with the cell surface and therefore are not easily absorbed. These problems are overcome by (1) increases in the interfacial area between the aqueous and lipid phase and (2) "solubilization" of lipids with **detergents**. Thus changes in the physical state of lipids are intimately connected to chemical changes during digestion and absorption.

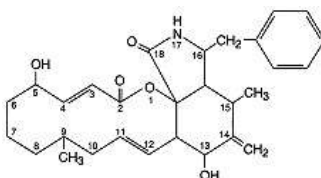

Figure 26.26
Cytochalasin B.

At least five different phases can be distinguished (Figure 26.27): (1) hydrolysis of triacylglycerols to free fatty acids and monoacylglycerols; (2) solubilization by detergents (bile acids) and transport from the intestinal lumen toward the cell surface; (3) uptake of free fatty acids and monoacylglycerols into the cell and resynthesis to triacylglycerols; (4) packaging of newly synthesized triacylglycerols into special lipid-rich globules, called chylomicrons, and (5) exocytosis of chylomicrons from cells and release into lymph.

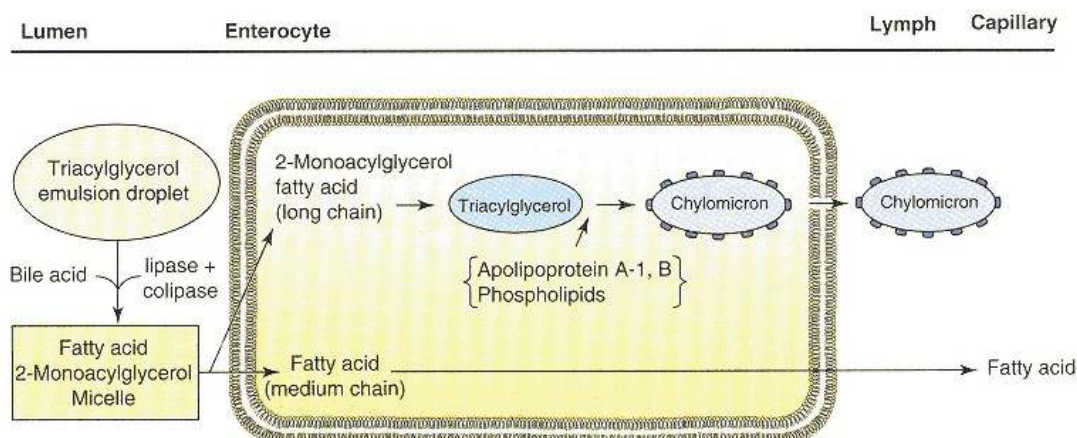

Figure 26.27
Digestion and absorption of lipids.

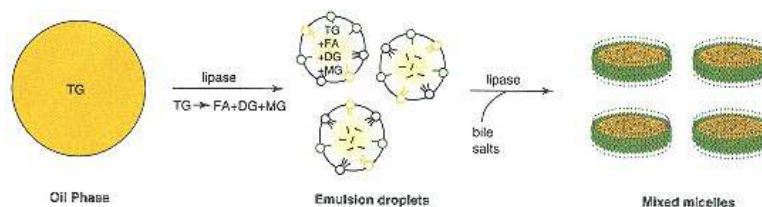

Figure 26.28

Changes in physical state during triacylglycerol digestion.

Abbreviations: TG, triacylglycerol; DG, diacylglycerol; MG, monoacylglycerol; FA, fatty acid.

Lipids Are Digested by Gastric and Pancreatic Lipases

Digestion of lipids is initiated in the stomach by an **acid-stable lipase**, most of which is thought to originate from glands at the back of the tongue. However, the rate of hydrolysis is slow because the ingested triacylglycerols form a separate lipid phase with a limited water–lipid interface. The lipase adsorbs to that interface and converts triacylglycerols into fatty acids and diacylglycerols (Figure 26.28). The importance of the initial hydrolysis is that some of the water-immiscible triacylglycerols are converted to products that possess both polar and nonpolar groups. Such surfactive products spontaneously adsorb to water–lipid interfaces and confer a hydrophilic surface to lipid droplets thereby providing a stable interface with the aqueous environment. At constant volume of the lipid phase, any increase in interfacial area produces dispersion of the lipid phase into smaller droplets (emulsification) and provides more sites for adsorption of more lipase molecules.

The major enzyme for triacylglycerol hydrolysis is the **pancreatic lipase** (Figure 26.29). This enzyme is specific for esters in the α -position of glycerol and prefers long-chain fatty acids with more than ten carbon atoms. Hydrolysis by the pancreatic enzyme also occurs at the water–lipid interface of emulsion droplets. The products are **free fatty acids** and **β -monoacylglycerols**. The purified form of the enzyme is strongly inhibited by the bile acids that normally are present in the small intestine during lipid digestion. The problem of inhibition is overcome by **colipase**, a small protein (12 kDa) that binds to both the water–lipid interface and to lipase, thereby anchoring and activating the enzyme. It is secreted by the pancreas as procolipase and depends on tryptic removal of a NH_2 -terminal decapeptide for full activity.

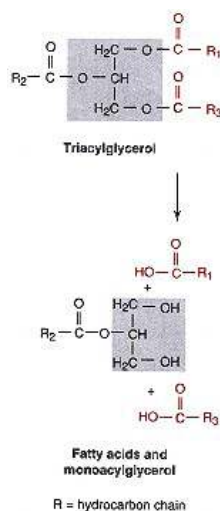

Figure 26.29

Mechanism of action of lipase.

Pancreatic juice also contains another less **specific lipid esterase**, which acts on cholesterol esters, monoglycerides, or other lipid esters, such as esters of vitamin A with carboxylic acids. In contrast to triacylglycerol lipase, this lipid esterase requires bile acids for activity.

Phospholipids are hydrolyzed by specific phospholipases. Pancreatic secretions are especially rich in the proenzyme for **phospholipase A₂** (Figure 26.30). As other pancreatic proenzymes, this one is also activated by trypsin. Phospholipase A₂ requires bile acids for activity.

Bile Acid Micelles Solubilize Lipids during Digestion

Bile acids are biological detergents that are synthesized by the liver and secreted as conjugates of **glycine** or **taurine** with the bile into the duodenum. At physiological pH values, they are present as anions, which have detergent

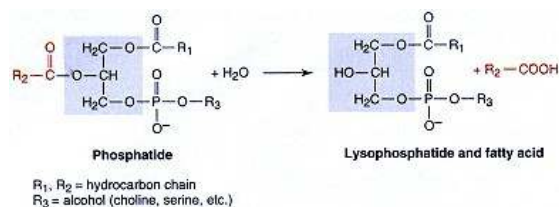

Figure 26.30

Mechanism of action of phospholipase A_2 .

properties. Therefore the terms **bile acids** and **bile salts** are often used interchangeably (Figure 26.31). Bile acids at pH values above the pK (Table 26.10) reversibly form aggregates at concentrations above 2–5 mM. These aggregates are called **micelles**, and the minimal concentration necessary for micelle formation is the **critical micellar concentration** (Figure 26.32). The bile acids in micelles are in equilibrium with those free in solution. Thus micelles, in contrast to emulsified lipids, are equilibrium structures with well-defined sizes that are much smaller than emulsion droplets. Micelle sizes typically range between 40 and 600 nm depending on bile acid concentration and the ratio of bile acids to lipids.

The arrangements of bile acids in micelles is such that the hydrophobic portions are removed from contact with water, while hydrophilic groups remain exposed to the water. The hydrophobic region of bile acids is formed by one surface of the fused ring system, while the carboxylate or sulfonate ion and the hydroxyl groups on the other side of the ring system are hydrophilic. Since the major driving forces for micelle formation are the removal of apolar, hydrophobic groups from and the interaction of polar groups with water molecules, the distribution of polar and apolar regions places some constraints on the stereochemical arrangements of bile acid molecules within a micelle. Four bile acid molecules are sufficient to form a very simple micelle as shown in Figure 26.33. Bile salt micelles can solubilize other lipids, such as phospholipids and fatty acids. These **mixed micelles** have disk-like shapes, whereby the phospholipids and fatty acids form a bilayer and the bile acids occupy the edge positions, rendering the edge of the disk hydrophilic (Figure 26.34). Within the mixed phospholipid–bile acid micelles, other water-insoluble lipids, such as cholesterol, can be accommodated and thereby "solubilized" (for potential problems see Clin. Corr. 26.5).

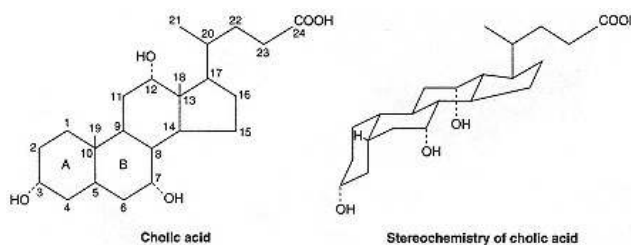

Figure 26.31

Cholic acid, a bile acid.

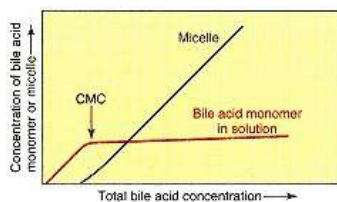

Figure 26.32
 Solubility properties of bile acids in aqueous solutions. Abbreviation: CMC, critical micellar concentration.

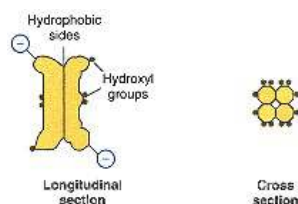
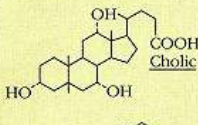
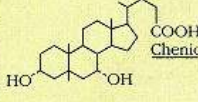
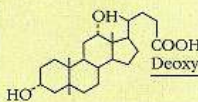

Figure 26.33
Diagrammatic representation of a Na^+ cholate micelle. Adapted from Small, D. M. *Biochim. Biophys. Acta* 176: 178, 1969.

TABLE 26.10 Effect of Conjugation on the Acidity of Cholic, Deoxycholic, and Chenodeoxycholic Acids

Bile Acid	Ionized Group	pK _a
Unconjugated bile acids	—COO ⁻ of cholestanic acid	≈5
Glycoconjugates	—COO ⁻ of glycine	≈3.7
Tauroconjugates	—SO ₃ ⁻ of taurine	≈1.5

Primary		$\begin{array}{c} \text{R}-\text{C}(=\text{O})-\text{N}-\text{CH}_2\text{COO}^- \\ \\ \text{H} \end{array}$	{ Cholyglycine Chenylglycine Deoxycholyglycine
			
Secondary		$\begin{array}{c} \text{NH}_3^+\text{CH}_2\text{COO}^- \\ \\ \text{NH}_3^+(\text{CH}_2)_2\text{SO}_3^- \\ \\ \text{R}-\text{C}(=\text{O})-\text{N}-(\text{CH}_2)_2\text{SO}_3^- \\ \\ \text{H} \end{array}$	{ Cholytaurine Chenyltaurine Deoxycholytaurine

Source: Reproduced with permission from Hofmann, A. F. *Handbook of Physiology* 5:2508, 1968.

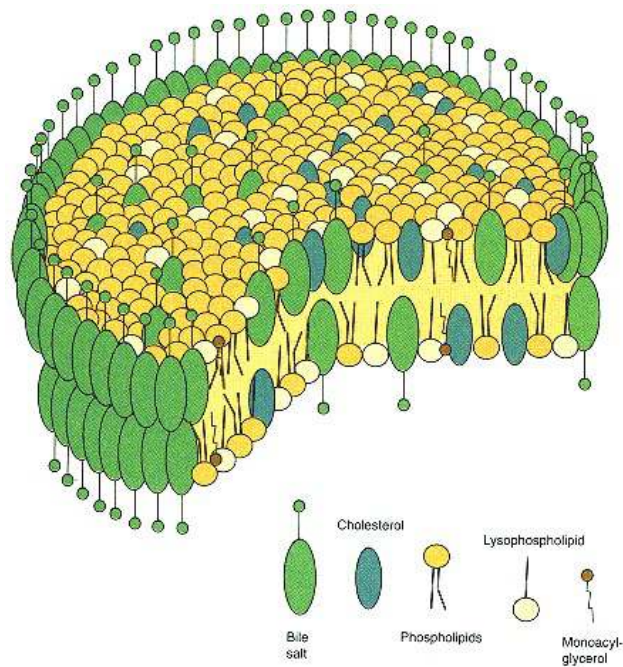

Figure 26.34

Proposed structure of the intestinal mixed micelle.

The bilayer disk has a band of bile salt at its periphery and other, more hydrophobic components (fatty acids, monoacylglycerol, phospholipids, and cholesterol) protected within its interior.

Redrawn based on figure from Carey, M. C. In: A. M. Arias, H. Popper, D. Schachter, et al. (Eds.), *The Liver: Biology and Pathology*, New York: Raven Press, 1982.

CLINICAL CORRELATION 26.5

Cholesterol Stones

Liver secretes phospholipids and cholesterol together with bile acids into the bile. Because of the limited solubility of cholesterol, its secretion in bile can result in cholesterol stone formation in the gallbladder. Stone formation is a relatively frequent complication; up to 20% of North Americans will develop stones during their lifetime.

Cholesterol is practically insoluble in aqueous solutions. However, it can be incorporated into mixed phospholipid–bile acid micelles up to a mole ratio of 1:1 for cholesterol/phospholipids and thereby "solubilized" (see accompanying figure). The liver can produce supersaturated bile with a higher ratio than 1:1 of cholesterol/phospholipid. This excess cholesterol has a tendency to come out of solution and to crystallize. Such bile with excess cholesterol is considered lithogenic, that is, stoneforming. Crystal formation usually occurs in the gallbladder, rather than the hepatic bile ducts, because contact times between bile and any crystallization nuclei are greater in the gallbladder. In addition, the gallbladder concentrates bile by absorption of electrolytes and water. The bile salts chenodeoxycholate and ursodeoxycholate are now available for oral use to dissolve gallstones. Ingestion of these bile salts reduces cholesterol excretion into the bile and allows cholesterol in stones to be solubilized.

The tendency to secrete bile supersaturated with respect to cholesterol is inherited and found more frequently in females than in males, often associated with obesity. Supersaturation also appears to be a function of the size and nature of the bile acid pool as well as the secretion rate.

Schoenfield, L. J., and Lachin, J. M. Chenodiol (chenodeoxycholic acid) for dissolution of gallstones: The National Cooperative Gallstone Study. A controlled trial of safety and efficacy. *Ann. Intern. Med.* 95:257, 1981; and Carey, M. C., and Small, D. M. The physical chemistry of cholesterol solubility in bile. *J. Clin. Invest.* 61:998, 1978.

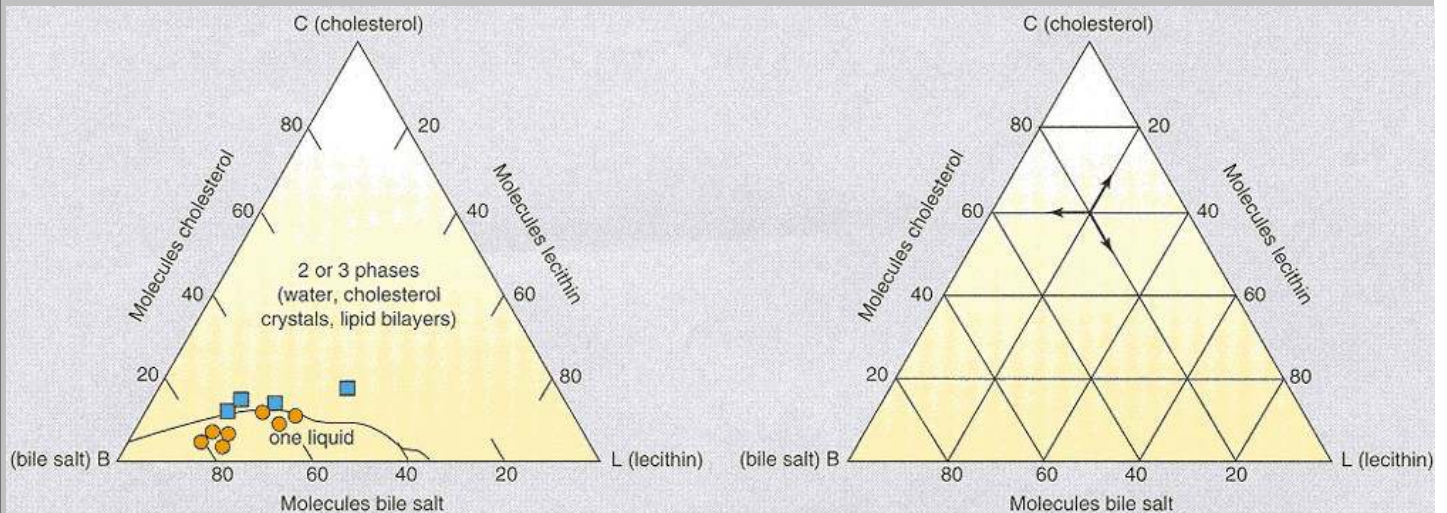

Diagram of the physical states of mixtures of 90% water and 10% lipid. The 10% lipid is made up of bile acids, lecithin, and cholesterol, and the triangle represents all possible ratios of the three lipid constituents. Each point within the triangle corresponds to a particular composition of the three components, which can be read off the graph as indicated; each point on one of the sides corresponds to a particular composition of just two components. The left triangle contains the composition of gallbladder bile samples from patients without stones (red ■). Lithogenic bile has a composition that falls outside the "one liquid" area in the lower left corner. Redrawn from Hofmann, A. F., and Small, D. M. *Annu. Rev. Med.* 18:362, 1967. Copyright © 1967 by Annual Reviews, Inc.

During triacylglycerol digestion, free fatty acids and monoacylglycerols are released at the surface of fat emulsion droplets. In contrast to triacylglycerols, which are water-insoluble, free fatty acids and monoacylglycerols are slightly water-soluble, and molecules at the surface equilibrate with those in solution. The latter in turn become incorporated into bile acid micelles. Thus the products of triacylglycerol hydrolysis are continuously transferred from emulsion droplets to the micelles (see Figure 26.27).

Micelles provide the major vehicle for moving lipids from the intestinal lumen to the cell surface where absorption occurs. Because the fluid layer next to the cell surface is poorly mixed, the major transport mechanism for solute

CLINICAL CORRELATION 26.6**A- β -Lipoproteinemia**

A- β -lipoproteinemia is an autosomal recessive disorder characterized by the absence of all lipoproteins containing apo- β -lipoprotein, that is, chylomicrons, very low density lipoproteins (VLDLs), and low density lipoproteins (LDLs). Serum cholesterol is extremely low. This defect is associated with severe malabsorption of triacylglycerol and lipid-soluble vitamins (especially tocopherol and vitamin E) and accumulation of apo B in enterocytes and hepatocytes. The defect does not appear to involve the gene for apo B, but rather one of several proteins involved in processing of apo B in liver and intestinal mucosa, or in assembly and secretion of triacylglycerol-rich lipoproteins, that is, chylomicrons and VLDLs from these tissues, respectively.

Kane, J. P. Apolipoprotein B: structural and metabolic heterogeneity. *Annu. Rev. Physiol.* 45:673, 1983; and Kane, J. P., and Havel, R. J. In: C. R. Scriver, A. L. Beaudet, W. S. Sly, and D. Valle (Eds.), *The Metabolic and Molecular Bases of Inherited Disease*, Vol. 1, 7th ed. New York: McGraw-Hill, 1995, p. 1853.

flux across this "unstirred" fluid layer is diffusion down the concentration gradient. With this type of transport mechanism, the delivery rate of nutrients at the cell surface is proportional to their concentration difference between luminal bulk phase and cell surface. Obviously, the unstirred fluid layer presents problems for sparingly soluble or insoluble nutrients, in that reasonable delivery rates cannot be achieved. Bile acid micelles overcome this problem for lipids by increasing their effective concentration in the unstirred layer. The increase in transport rate is nearly proportional to the increase in effective concentration and can be 1000-fold over that of individually solubilized fatty acids, in accordance with the different solubility of fatty acids as micelles or as individual molecules. This relationship between flux and effective concentration holds because the diffusion constant, another parameter that determines the flux, is only slightly smaller for the mixed micelles as compared to lipid molecules free in solution. Thus efficient lipid absorption depends on the presence of sufficient bile acids to "solubilize" the ingested and hydrolyzed lipids in micelles. In the absence of bile acids, the absorption of triacylglycerols does not completely stop, although the efficiency is drastically reduced. The residual absorption depends on the slight water solubility of the free fatty acids and monoacylglycerols. Unabsorbed lipids reach the lower intestine where a small part can be metabolized by bacteria. The bulk of unabsorbed lipids, however, is excreted with the stool (this is called **steatorrhea**).

Micelles also transport cholesterol and the lipid-soluble vitamins A, D, E, and K through the unstirred fluid layers. Bile acid secretion is absolutely essential for their absorption.

Most Absorbed Lipids Are Incorporated into Chylomicrons

Uptake of lipids by the epithelial cells occurs by diffusion through the plasma membrane. Absorption is virtually complete for fatty acids and monoacylglycerols, which are slightly water-soluble. It is less efficient for water-insoluble lipids. For example, only 30–40% of the dietary cholesterol is absorbed.

Within the intestinal cells, the fate of absorbed fatty acids depends on chain length. **Fatty acids of medium chain length** (6–10 carbon atoms) pass through the cell into the portal blood without modification. Long-chain fatty acids (>12 carbon atoms) become bound to a cytosolic, specifically **intestinal fatty acid-binding protein** (I-FABP) and are transported to the endoplasmic reticulum, where they are resynthesized into triacylglycerols. Glycerol for this process is derived from the absorbed 2-monoacylglycerols and, to a minor degree, from glucose. The resynthesized triacylglycerols form lipid globules to which surface-active phospholipids and special proteins, termed **apolipoproteins**, adsorb. The lipid globules migrate within membrane-bounded vesicles through the Golgi to the basolateral plasma membrane. They are finally released into the intercellular space by fusion of the vesicles with the basolateral plasma membrane. Because the lipid globules can be several micrometers in diameter and because they leave the intestine via lymph vessels, they are called **chylomicrons** (chyle = milky lymph that is present in the intestinal lymph vessels, lacteals, and the thoracic duct after a lipid meal; chyle is derived from the Greek *chylos*, which means juice). The intestinal apolipoproteins are distinctly different from those of the liver and are designated A-1 and B. **Apolipoprotein B** is essential for chylomicron release from enterocytes (see Clin. Corr. 26.6).

While dietary medium-chain fatty acids reach the liver directly with the portal blood, the long-chain fatty acids bypass the liver by being released in the form of chylomicrons into the lymphatics. The intestinal lymph vessels drain into the large body veins via the thoracic duct. Blood from the large veins first reaches the lungs and then the capillaries of the peripheral tissues, including adipose tissue and muscle, before it comes into contact with the liver. Fat and

muscle cells in particular take up large amounts of dietary lipids for storage or metabolism. The bypass of the liver may have evolved to protect this organ from a lipid overload after a meal.

The differential handling of medium- and long-chain fatty acids by intestinal cells can be specifically exploited to provide the liver with high-caloric nutrients in the form of fatty acids. Short- and medium-chain fatty acids are not very palatable; however, triacylglycerols synthesized from these fatty acids are quite palatable and can be used as part of the diet.

26.7—

Bile Acid Metabolism

All bile acids are synthesized within the liver from cholesterol but can be modified by bacterial enzymes in the intestinal lumen. **Primary bile acids** synthesized by the liver are **cholic** and **chenodeoxycholic** (or chenic) acid. The **secondary bile acids** are derived from the primary bile acids by bacterial dehydroxylation in position 7 of the ring structure, resulting in **deoxycholate** and **lithocholate**, respectively (Figure 26.35).

Primary and secondary bile acids are reabsorbed by the intestine into the portal blood, taken up by the liver, and then resecreted into bile. Within the liver, primary as well as secondary bile acids are linked to either glycine or

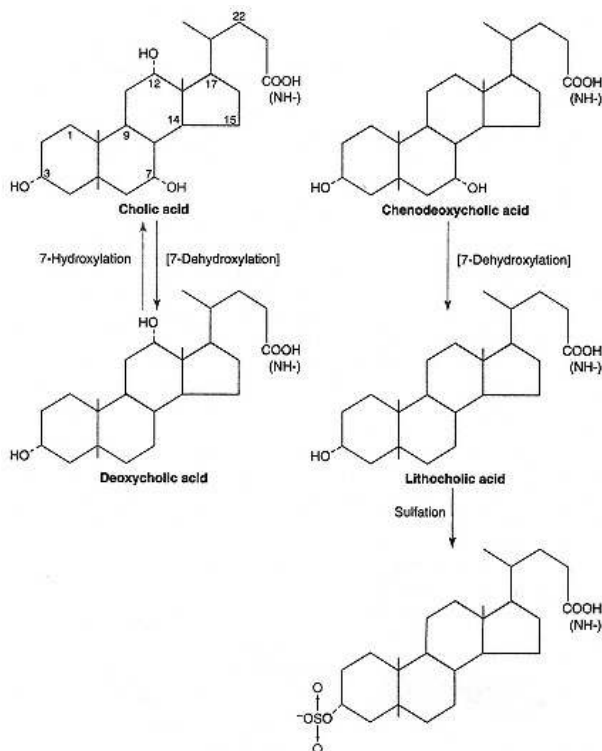

Figure 26.35

Bile acid metabolism in the rat.

Green and black arrows indicate reactions catalyzed by liver enzymes; red arrows indicate those of bacterial enzymes within the intestinal lumen. (NH—), glycine or taurine conjugate of the bile acids.

taurine via an isopeptide bond. These derivatives are called **glyco-** and **tauro-conjugates**, respectively, and constitute the forms that are secreted into bile. With the conjugation, the carboxyl group of the unconjugated acid is replaced by an even more polar group. The pK values of the carboxyl group of glycine and of the sulfonyl group of taurine are lower than that of unconjugated bile acids, so that conjugated bile acids remain ionized over a wider pH range (see Table 26.10). The conjugation is partially reversed within the intestinal lumen by hydrolysis of the isopeptide bond.

The total amount of conjugated and unconjugated bile acids secreted per day by the liver is 16–70 g for an adult. As the total body pool is only 3–4 g, bile acids have to recirculate 5–14 times each day between the intestinal lumen and the liver. Reabsorption of bile acids is important to conserve the pool. Most of the uptake is probably by passive diffusion along the entire small intestine. In addition, the lower ileum contains a specialized **Na⁺-bile acid cotransport system** for concentrative reuptake. Thus during a meal, bile acids from the gallbladder and liver are released into the lumen of the upper small intestine, pass with the chyme down the small intestinal lumen, are reabsorbed by the epithelium of the lower small intestine into the portal blood, and are then extracted from the portal blood by the liver parenchymal cells. The process of secretion and reuptake is referred to as the **enterohepatic circulation** (Figure 26.36). Reabsorption of bile acids by the intestine is quite efficient as only about 0.5 g of bile acids escapes reuptake each day and is secreted with the feces. Serum levels of bile acids normally vary with the rate of reabsorption and therefore are highest during a meal.

Cholate, deoxycholate, chenodeoxycholate, and their conjugates continuously participate in the enterohepatic circulation. In contrast, most of the **lithocholic acid** that is produced by bacterial enzymes is sulfated during the next passage through the liver. The sulfate ester of lithocholic acid is not a substrate for the bile acid transport system in the ileum and therefore is excreted in the feces.

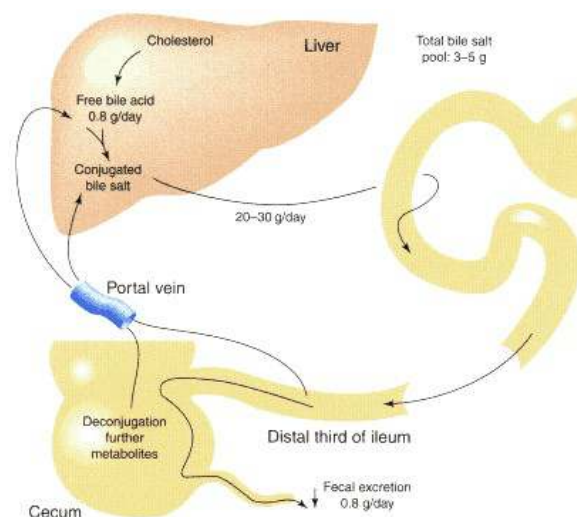

Figure 26.36

Enterohepatic circulation of bile acids.

Redrawn from Clark, M. L., and Harries, J. T. In: I. McColl and G. E. Sladen (Eds.), *Intestinal Absorption in Man*. New York: Academic Press, 1975, p. 195.

Bibliography

- Cristofaro, E., Mottu, F., and Wuhmann, J. J. Involvement of the raffinose family of oligosaccharides in flatulence. In: H. L. Sipple and K. W. McNutt (Eds.), *Sugars in Nutrition*. New York: Academic Press, 1974, p. 314.
- Field, M., and Semrad, C. E. Toxigenic diarrheas, congenital diarrheas, and cystic fibrosis. *Annu. Rev. Physiol.* 55:631–655, 1993.
- Hediger, M. A., and Rhoads, D. B. Molecular physiology of sodium-glucose cotransporters. *Physiol. Rev.* 74:993–1026, 1994.
- Johnson, L. R. (ed.-in-chief). *Physiology of the Gastrointestinal Tract*, Vols. 1 and 2, 2nd and 3rd eds. New York: Raven Press, 1987, 1994.
- Mathews, D. M. *Protein Absorption*. New York: Wiley-Liss, 1991.
- Pandol, S., and Raybauld, H. E. Integrated response to a meal. The Undergraduate Teaching Project in Gastroenterology and Liver Disease. Unit #29. American Gastroenterological Assoc. Timonium, MD: Milner-Fenwick, Inc., 1995.
- Porter, R., and Collins, G. M. *Brush Border Membranes*. Volume 95, Ciba Foundation Symposium. London: Pitman, 1983.
- Schultz, S. G. (section ed.). *Handbook of Physiology. Section 6: The Gastrointestinal System. Vol. IV. Intestinal Absorption and Secretion* (M. Field and R. A. Frizzell, Eds.). Bethesda, MD: American Physiological Society, 1991
- Sleisenger, M. H. Malabsorption and nutritional support. *Clin. Gastroenterol.* 12:323, 1983.
- Thomson, A. B. R., Schoeller, C., Keelan, M., Smith, L., and Clandinin, M. T. Lipid absorption: passing through the unstirred layers near the brush border membrane, and beyond. *Can. J. Physiol. Pharmacol.* 71:531–555, 1993.

Questions

J. Baggott and C. N. Angstadt

Refer to the following for Questions 1–5:

- liver
 - pancreas
 - spleen
 - stomach
 - none of the above
- Has no role in digestion.
 - Synthesizes an essential emulsifier of lipids.
 - Participates in a nonessential manner in protein digestion.
 - Transports HCO_3^- from the cytoplasm across the contraluminal plasma membrane.
 - Site of chymotrypsinogen synthesis.
 - Active forms of enzymes that digest food may normally be found in all of the following EXCEPT:
 - in soluble form in the lumen of the stomach.
 - in the saliva.
 - attached to the luminal surface of the plasma membrane of intestinal epithelial cells.
 - dissolved in the cytoplasm of intestinal epithelial cells.
 - in zymogen granules of pancreatic exocrine cells.
 - Histamine is a physiologically important secretagogue of:
 - amylase by the salivary glands.
 - HCl by the stomach.
 - gastrin by the stomach.
 - hydrolytic enzymes by the pancreas.
 - NaHCO_3 by the pancreas.
 - The contraluminal membranes of small intestinal epithelial cells contain:
 - aminopeptidases.
 - Na^+, K^+ -ATPase.
 - disaccharidases.
 - GLUT5.
 - Na^+ -monosaccharide transport (SGLT1).
 - Oral administration of large amounts of tyrosine could be expected to interfere with the intestinal absorption of:
 - leucine.
 - lysine.
 - glycine.
 - aspartate.
 - none of the above.
 - Which of the following has two carboxyl groups essential for peptidase activity?
 - carboxypeptidase
 - chymotrypsin
 - elastase
 - pepsin
 - trypsin
 - Starch digestion is more efficient after heating the starch with water because heating:
 - hydrates the starch granules, making them more susceptible to pancreatic amylase.
 - converts α -1,4 links to β -1,4 links, which are more susceptible to attack by mammalian amylases.
 - partly hydrolyzes α -1,6 links.
 - converts the linear amylose to branched amylopectin, which resembles glycogen.
 - inactivates amylase inhibitors, which are common in the tissues of starchy plants.
 - In the cytoplasm of intestinal cells:
 - all di- and tripeptides are hydrolyzed.
 - aminopeptidases are especially active.
 - during the neonatal period ingested proteins may be found.
 - most disaccharides are hydrolyzed.
 - raffinose and related sugars are degraded to yield hydrogen, methane, and carbon dioxide.
 - In the digestion and absorption of triacylglycerols:
 - a pancreatic lipase initiates the process.
 - an important colipase is activated by tryptic hydrolysis.
 - hydrolysis occurs in the interior of the lipid droplets.
 - most of the triacylglycerol hydrolysis is carried out by a lipase of gastric origin.
 - efficiency is greatly increased if bile acids are absent.

14. Micelles:

- A. are the same as emulsion droplets.
- B. form from bile acids at all bile acid concentrations.
- C. although they are formed during lipid digestion, do not significantly enhance utilization of dietary lipid.
- D. always consist of only a single lipid species.
- E. are essential for the absorption of vitamins A and K.

15. In the metabolism of bile acids:

- A. the liver synthesizes the primary bile acids, cholic, and deoxycholic acids.
- B. secondary bile acids are produced by conjugation of primary bile acids to glycine or taurine.
- C. physiologically active bile acids are formed from primary bile acids by intestinal bacteria.
- D. daily bile acid secretion by the liver is approximately equal to daily bile acid synthesis.
- E. conjugation reduces the polarity of bile acids, enhancing their ability to interact with lipids.

Answers

1. C The spleen has no role in the digestion of food, though it does participate in other degradation processes.
2. A Bile acids are synthesized in the liver and are stored in the gallbladder (p. 1057).
3. D Loss of the stomach function can be compensated for by the intestinal processes (p. 1057).
4. D This occurs in the parietal (oxyntic) cells during HCl secretion (p. 1069).
5. B
6. E Zymogen granules contain inactive proenzymes or zymogens, which are not activated until after release from the cell (p. 1060).
7. B Stimulation of H₂ receptors of the stomach causes HCl secretion (p. 1061).
8. B. Only the contraluminal surface contains the Na⁺,K⁺-ATPase. All other activities are associated with the luminal surface (Table 26.5, p. 1064).
9. A Tyrosine shares a transport system with Val, Leu, Met, Phe, and Ile (p. 1073).
10. D The carboxylic acid groups are involved in the mechanism that depends on an acid pH (p. 1070).
11. A α -Amylase attacks hydrated starch more readily than unhydrated; heating hydrates the starch granules (p. 1074).
12. C They are taken up by pinocytosis (p. 1073).
13. B This colipase is required to overcome bile acid inhibition of pancreatic lipase, the major enzyme of lipid digestion. The colipase is secreted by the pancreas as a procolipase and must be activated by tryptic cleavage (p. 1078). A: Lipid digestion is initiated in the stomach by acid-stable lipase (p. 1078).
14. E The lipid-soluble vitamins must be dissolved in mixed micelles as a prerequisite for absorption (p. 1082). A: Micelles are of molecular dimensions and are highly ordered structures; emulsion droplets are much larger and are random (p. 1078, Figure 26.28; p. 1080, Figure 26.34). B: Micelle formation occurs only above the critical micellar concentration (CMC); below that concentration the components are in simple solution (p. 1079, Figure 26.32). C: See item 13. D: Micelles may consist of only one component, or they may be mixed (p. 1079.)
15. C The primary bile acids (cholic and chenodeoxycholic acids) are synthesized in the liver. In the intestine they may be dehydroxylated by bacteria to form the secondary bile acids—deoxycholate and lithocholate. Only a small fraction of the bile acid escapes reuptake; this must be replaced by synthesis. Both are reabsorbed and recirculated (enterohepatic circulation). Both are conjugated to glycine or taurine, increasing their polarity (p. 1078).

Chapter 27— Principles of Nutrition I: Macronutrients

Stephen G. Chaney



27.1 Overview	1088
27.2 Energy Metabolism	1088
Energy Content of Food Is Measured in Kilocalories	1088
Energy Expenditure Is Influenced by Four Factors	1088
27.3 Protein Metabolism	1089
Dietary Protein Serves Many Roles Including Energy Production	1089
Nitrogen Balance Relates Intake of Nitrogen to Its Excretion	1090
Essential Amino Acids Must Be Present in the Diet	1090
Protein Sparing Is Related to Dietary Content of Carbohydrate and Fat	1091
Normal Adult Protein Requirements Depend on Diet	1091
Protein Requirement Increases during Growth and Recovery from Illness	1092
27.4 Protein-Energy Malnutrition	1093
27.5 Excess Protein-Energy Intake	1094
Obesity Has Dietary and Genetic Components	1094
Metabolic Consequences of Obesity Have Significant Health Implications	1094
27.6 Carbohydrates	1095
27.7 Fats	1097
27.8 Fiber	1097
27.9 Composition of Macronutrients in the Diet	1098
Composition of the Diet Affects Serum Cholesterol	1098
Effects of Refined Carbohydrate in the Diet Are Not Straightforward	1100
Mixed Vegetable and Animal Proteins Meet Nutritional Protein Requirements	1101
An Increase in Fiber from Varied Sources Is Desirable	1101
Current Recommendations Are for a "Prudent Diet"	1101
Bibliography	1103
Questions and Answers	1104
Clinical Correlations	
27.1 Vegetarian Diets and Protein–Energy Requirements	1091
27.2 Low-Protein Diets and Renal Disease	1092
27.3 Providing Adequate Protein and Calories for the Hospitalized Patient	1093
27.4 Carbohydrate Loading and Athletic Endurance	1096
27.5 High-Carbohydrate Versus High-Fat Diets for Diabetics	1096
27.6 Polyunsaturated Fatty Acids and Risk Factors for Heart Disease	1099
27.7 Metabolic Adaptation: The Relationship between Carbohydrate Intake and Serum Triacylglycerols	1100

27.1—

Overview

Nutrition is best defined as the utilization of foods by living organisms. Since the process of food utilization is biochemical, the major thrust of the next two chapters is a discussion of basic nutritional concepts in biochemical terms. Simply understanding basic nutritional concepts is no longer sufficient. Nutrition attracts more than its share of controversy in our society, and a thorough understanding of nutrition almost demands an understanding of the issues behind these controversies. These chapters also explore the biochemical basis for some of the most important nutritional controversies.

Study of human nutrition can be divided into three areas: undernutrition, overnutrition, and ideal nutrition. **Undernutrition** is not a primary concern in this country because nutritional deficiency diseases are now quite rare. **Overnutrition** is a particularly serious problem in developed countries. Current estimates suggest that between 15% and 30% of the U.S. population is obese, and obesity is known to have a number of serious health consequences. Finally, there is increasing interest today in the concept of ideal or **optimal nutrition**. This is a concept that has meaning only in an affluent society. Only when food supply becomes abundant enough so that deficiency diseases are a rarity does it become possible to consider long-range effects of nutrients on health. This is probably the most exciting area of nutrition today.

27.2—

Energy Metabolism

Energy Content of Food Is Measured in Kilocalories

You should be well acquainted with the energy requirements of the body. Much of the food we eat is converted to ATP and other high-energy compounds, which are utilized to drive biosynthetic pathways, generate nerve impulses, and power muscle contraction. We generally describe the energy content of foods in terms of **calories**. Technically speaking, we are actually referring to **kilocalories** of heat energy released by combustion of that food in the body. Some nutritionists prefer the term kilojoule (a measure of mechanical energy), but since the American public is likely to be counting calories rather than joules in the foreseeable future, we will restrict ourselves to that term. Caloric values of protein, fat, carbohydrate, and alcohol are roughly 4, 9, 4, and 7 kcal g⁻¹, respectively. Given these data and the composition of the food, it is simple to calculate the caloric content (input) of the foods we eat. Calculating caloric content of foods does not appear to be a major problem in this country. Millions of Americans are able to do it with ease. The problem lies in balancing caloric input with caloric output. Where do these calories go?

Energy Expenditure Is Influenced by Four Factors

There are four principal factors that affect individual energy expenditure: surface area (which is related to height and weight), age, sex, and activity level. (1) The effects of surface area are thought to be simply related to the rate of heat loss by the body—the greater the surface area, the greater the rate of heat loss. While it may seem surprising, a lean individual actually has a greater surface area, and thus a greater energy requirement, than an obese individual of the same weight. (2) Age may reflect two factors: growth and lean muscle mass. In infants and children more energy expenditure is required for rapid growth, and this is reflected in a higher **basal metabolic rate** (rate of energy utilization in resting state). In adults (even lean adults), muscle tissue is gradually replaced with fat and water during the aging process, resulting in a 2% decrease

in basal metabolic rate (BMR) per decade of adult life. (3) As for sex, women tend to have a lower BMR than men due to a smaller percentage of lean muscle mass and the effects of female hormones on metabolism. (4) The effect of activity levels on energy requirements is obvious. However, most of us overemphasize the immediate, as opposed to the long-term, effects of exercise. For example, one would need to jog for over an hour to burn up the calories found in one piece of apple pie.

Yet, the effect of a regular **exercise** program on energy expenditure can be quite beneficial. Regular exercise increases lean muscle mass, which has a higher basal metabolic rate than adipose tissue, allowing one to burn up calories more rapidly 24 hours a day. A regular exercise program should be designed to increase lean muscle mass and should be repeated 3–5 days a week but need not be aerobic exercise to have an effect on basal metabolic rate. For an elderly or infirm individual, even daily walking may, with time, help to increase basal metabolic rate slightly.

Hormone levels are important also, since thyroxine, sex hormones, growth hormone, and, to a lesser extent, epinephrine and cortisol increase BMR. The effects of epinephrine and cortisol probably explain in part why severe stress and major trauma significantly increase energy requirements. Finally, energy intake itself has an inverse relationship to expenditure in that during periods of **starvation** or semistarvation BMR can decrease up to 50%. This is of great survival value in cases of genuine starvation, but not much help to the person who wishes to lose weight on a calorie-restricted diet.

27.3—

Protein Metabolism

Dietary Protein Serves Many Roles Including Energy Production

Protein carries a certain mystique as a "body-building" food. While it is true that protein is an essential structural component of all cells, protein is equally important for maintaining the output of essential secretions such as digestive enzymes and peptide or protein hormones. Protein is also needed to synthesize plasma proteins, which are essential for maintaining osmotic balance, transporting substances through the blood, and maintaining immunity. However, the average adult in this country consumes far more protein than needed to carry out these essential functions. Excess protein is treated as a source of energy, with the glucogenic amino acids being converted to glucose and the ketogenic amino acids converted to fatty acids and keto acids. Both kinds of **amino acids** will eventually be converted to triacylglycerol in adipose tissue if fat and carbohydrate supplies are already adequate to meet energy requirements. Thus for most of us the only body-building obtained from high-protein diets is in adipose tissue.

It has always been popular to say that the body has no storage depot for protein, and thus adequate dietary protein must be supplied with every meal. However, in actuality, this is not quite accurate. While there is no separate class of "storage" protein, there is a certain percentage of body protein that undergoes a constant process of breakdown and resynthesis. In the fasting state the breakdown of this store of body protein is enhanced, and the resulting amino acids are utilized for glucose production, synthesis of nonprotein nitrogenous compounds, and synthesis of the essential secretory and plasma proteins described above (see also Chapter 14). Even in the fed state, some of these amino acids are utilized for energy production and as biosynthetic precursors. Thus the turnover of body protein is a normal process—and an essential feature of what is called nitrogen balance.

Nitrogen Balance Relates Intake of Nitrogen to Its Excretion

Nitrogen balance (Figure 27.1) is a comparison between intake of nitrogen (chiefly in the form of protein) and excretion of nitrogen (chiefly in the form of undigested protein in the feces and urea and ammonia in urine). A normal adult is in nitrogen equilibrium, with losses just balanced by intake. Negative nitrogen balance results from inadequate dietary intake of protein, since amino acids utilized for energy and biosynthetic reactions are not replaced. It also occurs in injury when there is net destruction of tissue and in major trauma or illness when the body's adaptive response causes increased catabolism of body protein stores. Positive nitrogen balance is observed whenever there is a net increase in the body protein stores, such as in growing children, pregnant women, or convalescing adults.

Essential Amino Acids Must Be Present in the Diet

In addition to the amount of protein in the diet, several other factors must be considered. One is the complement of essential amino acids present in the diet. **Essential amino acids** are those amino acids that cannot be synthesized by the body (Chapter 11). If just one of these essential amino acids is missing from the diet, the body cannot synthesize new protein to replace the protein lost due to normal turnover, and a negative nitrogen balance results (Figure 27.1).

(a) Positive nitrogen balance (growth, pregnancy, lactation and recovery from metabolic stress).

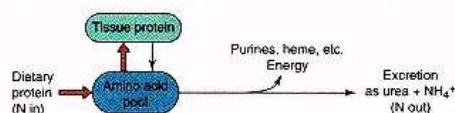

(b) Negative nitrogen balance (metabolic stress).

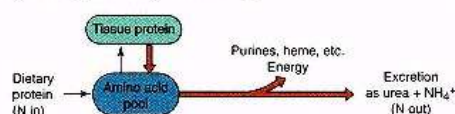

(c) Negative nitrogen balance (inadequate dietary protein).

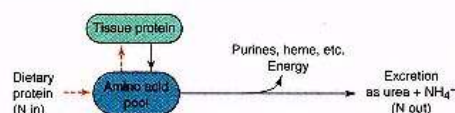

(d) Negative nitrogen balance (lack of an essential amino acid).

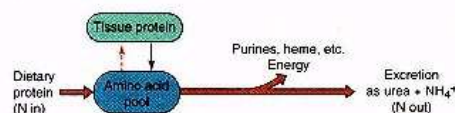

Figure 27.1

Factors affecting nitrogen balance.

Schematic representations

of the metabolic interrelationship involved in determining nitrogen balance. Each figure represents the nitrogen balance resulting from a particular set of metabolic conditions. The dominant pathways in each situation are indicated by heavy red arrows.

Obviously then, the complement of essential amino acids in any dietary protein will determine how well it can be used by the body.

Generally, most animal proteins contain all essential amino acids in about the quantities needed by the human body. Vegetable proteins, on the other hand, often lack one or more essential amino acids and may, in some cases, be more difficult to digest. Even so, **vegetarian diets** can provide adequate protein provided enough extra protein is consumed to provide sufficient quantities of the essential amino acids and/or two or more different proteins are consumed together, which complement each other in amino acid content. For example, if corn (which is deficient in lysine) is combined with legumes (deficient in methionine but rich in lysine), the efficiency of utilization for the combination of the two vegetable proteins approaches that of animal protein. The adequacy of vegetarian diets with respect to protein and calories is discussed more fully in Clin. Corr. 27.1, and the need for high-quality protein in low-protein diets in renal disease is discussed in Clin. Corr. 27.2.

Protein Sparing Is Related to Dietary Content of Carbohydrate and Fat

Another factor that must be considered in determining protein requirements is dietary intake of fat and carbohydrate. If these components are present in insufficient quantities, some dietary protein must be used for energy generation and is unavailable for building and replacing tissue. Thus as energy (calorie) content of the diet from carbohydrate and fat increases, the need for protein decreases. This is referred to as **protein sparing**. Carbohydrate is somewhat more efficient at protein sparing than fat—presumably because carbohydrate can be used as an energy source by almost all tissues, whereas fat cannot.

Normal Adult Protein Requirements Depend on Diet

Assuming adequate calorie intake and 75% efficiency of utilization, which is typical of mixed protein in the average American diet, the **recommended**

CLINICAL CORRELATION 27.1

Vegetarian Diets and Protein–Energy Requirements

One of the most important problems of a purely vegetarian diet (as opposed to a lacto-ovo vegetarian diet) is the difficulty in obtaining sufficient calories and protein. Potential caloric deficit results from the fact that the caloric densities of fruits and vegetables are much less than the meats they replace (30–50 cal per 100 g versus 150–300 cal per 100 g). The protein problem is generally threefold: (1) most plant products contain much less protein (1–2 g of protein per 100 g versus 15–20 g per 100 g); (2) most plant protein is of low biological value; and (3) some plant proteins are incompletely digested. Actually, well-designed vegetarian diets usually provide enough calories and protein for the average adult. In fact, the reduced caloric intake may well be of benefit because strict vegetarians do tend to be lighter than their nonvegetarian counterparts.

However, whereas an adult male may require about 0.8 g of protein and 40 cal kg⁻¹ of body weight, a young child may require 2–3 times that amount. Similarly, a pregnant woman needs an additional 10 g of protein and 300 cal day⁻¹ and a lactating woman an extra 15 g of protein and 500 cal. Thus both young children and pregnant and lactating women run a risk of protein–energy malnutrition. Children of vegetarian mothers generally have a lower birth weight than children of mothers consuming a mixed diet. Similarly, vegetarian children generally have a slower rate of growth through the first 5 years, but generally catch up by age 10.

It is possible to provide sufficient calories and protein even for these high-risk groups provided the diet is adequately planned. Three principles should be followed to design a calorie–protein–sufficient vegetarian diet for young children: (1) whenever possible, include eggs and milk in the diet; they are both excellent sources of calories and high-quality protein; (2) include liberal amounts of those vegetable foods with high-caloric density in the diet, including nuts, grains, dried beans, and dried fruits; and (3) include liberal amounts of high-protein vegetable foods that have complementary amino acid patterns. It used to be thought that these complementary proteins must be present in the same meal. Recent animal studies, however, suggest that a meal low in (but not devoid of) an essential amino acid may be supplemented by adding the limiting amino acid at a subsequent meal.

First International Congress on Vegetarian Nutrition. *Proc. Am. J. Clin. Nutr.* 48(Suppl. 1):707, 1988; and Saunders, T. A. B. Vegetarian diets and children. *Pediatr. Nutr.*, 42:955, 1995.

CLINICAL CORRELATION 27.2

Low-Protein Diets and Renal Disease

Chronic renal failure is characterized by the buildup of the end products of protein catabolism, mainly urea. Some degree of dietary protein restriction is usually necessary because these toxic end products are responsible for many of the symptoms associated with renal failure. The amount of protein restriction is dependent on the severity of the disease. It is easy to maintain patients in nitrogen balance for prolonged periods on diets containing as little as 40 g of protein/day if the diet is calorically sufficient. Diets containing less than 40 g/day pose problems. Protein turnover continues and a balance must be found between enough protein to avoid negative nitrogen balance and little enough to avoid buildup of waste products.

The strategy employed in such diets is twofold: (1) provide a minimum of protein, primarily protein of high BV, and (2) provide the rest of the daily calories as carbohydrates and fats. The goal is to provide just enough essential amino acids to maintain positive nitrogen balance. In turn, the body should be able to synthesize the nonessential amino acids from other nitrogen-containing metabolites. Enough carbohydrate and fat are provided so that essentially all dietary protein can be spared from energy metabolism. With this type of diet, it is possible to maintain a patient on 20 g of protein per day for considerable periods. Because of the difficulty in maintaining nitrogen equilibrium at such low-protein intakes, the patient's protein status should be monitored. This can be done by measuring parameters such as serum albumin and transferrin.

Moreover, such diets are extremely monotonous and difficult to follow. A typical 20-g protein diet is shown below:

1. One egg plus 3/4 cup milk or 1 additional egg or 1 oz of meat.
2. One-half pound of deglutenized (low-protein) wheat bread; all other breads and cereals must be avoided—this includes almost all baked goods.
3. A limited amount of low-protein, low-potassium fruits and vegetables.
4. Sugars and fats to make up the rest of the needed calories; however, cakes, pies, and cookies need to be avoided.

The palatability of these diets can be improved considerably by starting with a vegan diet and supplementing it with a mixture of essential amino acids and ketoacid analogs of the essential amino acids. Recent studies indicate that this technique will help preserve renal function and allow a somewhat greater variety of foods.

Goodship, T. H. J., and Mitch, W. E. Nutritional approaches to preserving renal function. *Adv. Intern. Med.* 33:377, 1988; Dwyer, J. Vegetarian diets for treating nephrotic syndrome. *Nutr. Rev.* 51:44, 1993; and Barsotti, G., Morrell, E., Cupisti, A., Bertoncini, P., and Giovannetti, S. A special supplemented "vegan" diet for nephrotic patients. *Am. J. Nephrol.* 11:380, 1991.

protein intake is 0.8 g/kg^{-1} (body weight) day^{-1} . This amounts to about 58 g protein day^{-1} for a 72-kg (160-lb) man and about 44 g day^{-1} for a 55-kg (120-lb) woman. These recommendations would need to be increased on a vegetarian diet if overall efficiency of utilization were less than 75%.

Protein Requirement Increases during Growth and Recovery from Illness

Because dietary protein is essential for synthesis of new body tissue, as well as for maintenance and repair, the need for protein increases markedly during periods of rapid growth. Such growth occurs during pregnancy, infancy, childhood, and adolescence.

Once growth requirements have been considered, age does not seem to have much effect on protein requirements. If anything, the protein requirement may decrease slightly with age. However, older people need and generally consume less calories, so high-quality protein should provide a larger percentage of their total calories. Furthermore, some older people may have special protein requirements due to malabsorption problems.

Illness, major trauma, and surgery all cause a major **catabolic response**. Energy needs are very large, and the body responds by increasing production of glucagon, glucocorticoids, epinephrine, and certain cytokines. In these situations breakdown of body protein is greatly accelerated and a negative nitrogen balance results unless protein intake is increased (Figure 27.1). Although this increased protein requirement is of little significance in short-term illness, it can be vitally important in the recovery of hospitalized patients as discussed in the next section (see also Clin. Corr. 27.3).

CLINICAL CORRELATION 27.3**Providing Adequate Protein and Calories for the Hospitalized Patient**

The normal metabolic response to infection, trauma, and surgery is a complex and carefully balanced catabolic state. As discussed in the text, epinephrine, glucagon, cortisol, and cytokines are released, greatly accelerating the rates of lipolysis, proteolysis, and gluconeogenesis. The net result is an increased supply of fatty acids, amino acids, and glucose to meet the increased energy demands of such major stress. The high serum glucose results in elevation of circulating insulin levels, which is more than counterbalanced by increased levels of epinephrine and other hormones. Skeletal muscle, for example, uses very little of the serum glucose but continues to rely on free fatty acids and its own catabolized protein as a primary source of energy. It also continues to export amino acids, primarily alanine, for use elsewhere in the body, resulting in a very rapid depletion of body protein stores.

A highly catabolic hospitalized patient may require 35–45 kcal kg⁻¹ day⁻¹ and 2–3 g of protein kg⁻¹ day⁻¹. A patient with severe burns may require even more. A physician has a number of options available to provide this postoperative patient with sufficient calories and protein to ensure optimal recovery. When the patient is simply unable to ingest enough food, it may be adequate to supplement the diet with high-calorie–high-protein preparations, which are usually mixtures of homogenized cornstarch, egg, milk protein, and flavorings. When the patient is unable to ingest solid food or unable to digest complex mixtures of foods adequately, elemental diets are usually administered via a nasogastric tube. Elemental diets consist of small peptides or purified amino acids, glucose and dextrans, some fat, vitamins, and electrolytes. These diets are sometimes sufficient to meet most of the short-term caloric and protein needs of a moderately catabolic patient. When a patient is severely catabolic or unable to digest and absorb foods normally, parenteral (intravenous) nutrition is necessary. The least invasive method is to use a peripheral, slow-flow vein in a manner similar to any other i.v. infusion. The main limitation of this method is hypertonicity. However, a solution of 5% glucose and 4.25% purified amino acids can be used safely. This solution will usually provide enough protein to maintain positive nitrogen balance but will rarely provide enough calories for long-term maintenance of a catabolic patient.

The most aggressive nutritional therapy is total parenteral nutrition. Usually an indwelling catheter is inserted into a large fast-flow vessel such as the superior vena cava, so that the very hypertonic infusion fluid can rapidly be diluted. This allows solutions of up to 60% glucose and 4.25% amino acids to be used, providing sufficient protein and most of the calories for long-term maintenance. Intravenous lipid infusion is often added to boost calories and provide essential fatty acids. All of these methods can prevent or minimize the negative nitrogen balance associated with surgery and trauma. The actual choice of method depends on the patient's condition. As a general rule it is preferable to use the least invasive technique.

Streat, S. J., and Hill, G. L. Nutritional support in the management of critically ill patients in surgical intensive care. *World J. Surg.* 11:194, 1987; and The Veterans Affairs Total Parenteral Nutrition Cooperative Study Group. Perioperative total parenteral nutrition in surgical patients. *N. Engl. J. Med.* 325:25, 1991.

27.4—**Protein–Energy Malnutrition**

The most common form of malnutrition in the world is **protein–energy malnutrition (PEM)**. In developing countries inadequate intake of protein and energy is all too common, and it is usually the infants and young children who suffer most. While the symptoms of protein–energy insufficiency vary widely from case to case, it is common to classify most cases as either marasmus or kwashiorkor. **Marasmus** is usually defined as inadequate intake of both protein and energy. **Kwashiorkor** is defined as inadequate intake of protein with adequate energy intake. Often the diets associated with marasmus and kwashiorkor may be similar, with the kwashiorkor being precipitated by conditions of increased protein demand such as infection. The marasmic infant will have a thin, wasted appearance and will be small for his/her age. If PEM continues long enough the child will be permanently stunted in both physical and mental development. In kwashiorkor the child will often have a deceptively plump appearance due to edema. Other telltale symptoms associated with kwashiorkor are dry, brittle hair, diarrhea, dermatitis of various forms, and retarded growth. Perhaps the most devastating result of both marasmus and kwashiorkor is reduced ability of the afflicted individuals to fight off infection. They have a reduced number of T lymphocytes (and thus diminished cell-mediated immune response) as well as defects in the generation of phagocytic cells and production of immuno-globulins, interferon, and other components of the immune system. Many of

these individuals die from secondary infections, rather than from the starvation itself.

The most common form of PEM seen in the United States occurs in the hospital setting. A typical course of events is as follows: The patient has not been eating well for several weeks or months prior to entering the hospital due to chronic or debilitating illness. He/she enters the hospital with major trauma, severe infection, or for major surgery, all of which cause a large negative nitrogen balance. This is often compounded by difficulties in feeding the patient or by the necessity of fasting in preparation for surgery or diagnostic tests. The net result is PEM as measured by low levels of serum albumin and other serum proteins or by decreased cellular immunity tests. Recent studies have shown that hospitalized patients with demonstrable PEM have delayed wound healing, decreased resistance to infection, increased mortality, and increased length of hospitalization. Most major hospitals have programs to monitor the nutritional status of their patients and to intervene where necessary to maintain a positive nitrogen and energy balance (see Clin. Corr. 27.3).

27.5—

Excess Protein–Energy Intake

Much has been said in recent years about the large amount of protein that the average American consumes. Certainly most consume far more than needed to maintain positive nitrogen balance. An average American currently consumes 99 g of protein, 68% from animal sources. However, most studies show that a healthy adult can consume that amount of protein with no apparent harm. Concern has been raised about possible effects of high-protein intake on calcium requirements. Some studies suggest that high-protein intake increases urinary loss of calcium and may accelerate bone demineralization associated with aging. However, this issue is far from settled.

Obesity Has Dietary and Genetic Components

Perhaps the more serious nutritional problem is excessive energy consumption. In fact, **obesity** is the most frequent nutritional disorder in the United States. It would, however, be unfair to label obesity as simply a problem of excess consumption. Overeating plays an important role in many individuals, as does inadequate exercise, but there is also a strong genetic component as well. While the biochemical mechanisms for this genetic predisposition are unclear, investigators have recently identified an obesity gene in mice that appears to regulate obesity through effects on both appetite and deposition of fat. A similar gene exists in humans, but its metabolic function is still not known (see p. 378). Detailed characterization of this and other genes that predispose to obesity in animals may yield valuable clues to the causes and treatment of obesity in humans.

Metabolic Consequences of Obesity Have Significant Health Implications

A discussion of the treatment of obesity is clearly beyond the scope of this chapter, but it is worthwhile to consider some of the metabolic consequences of obesity. One striking clinical feature of overweight individuals is a marked elevation of serum free fatty acids, cholesterol, and triacylglycerols irrespective of the dietary intake of fat. Why is this? Obesity is obviously associated with an increased number and/or size of adipose cells. These cells contain fewer **Insulin receptors** and thus respond more poorly to insulin, resulting in increased activity of the **hormone-sensitive lipase**. The increased lipase activity

along with the increased mass of adipose tissue is probably sufficient to explain the increase in circulating **free fatty acids**. These excess fatty acids are carried to the liver and metabolized to acetyl CoA, a precursor for triacylglycerol and cholesterol synthesis. Excess triacylglycerol and cholesterol are released as **very low density lipoprotein particles**, leading to higher circulating levels of both triacylglycerol and cholesterol (see Chapters 9 and 10).

A second striking finding in obese individuals is higher fasting blood sugar levels and decreased glucose tolerance. Fully 80% of **adult-onset diabetics** are overweight. Again the culprit appears to be the decrease in insulin receptors, since many adult-onset diabetics have higher than normal insulin levels. This hyperinsulinemia appears to stimulate the sympathetic nervous system, leading to sodium and water retention and vasoconstriction, which tend to increase blood pressure. Because of these metabolic changes, obesity is a primary risk factor in coronary heart disease, hypertension, and diabetes. This is nutritionally significant because all of these metabolic changes are reversible. Quite often reduction to ideal weight is the single most important aim of nutritional therapy. Furthermore, when the individual is at ideal body weight, the composition of the diet becomes a less important consideration in maintaining normal serum lipid and glucose levels.

Any discussion of weight reduction regimens should include a mention of one other metabolic consequence of obesity. As discussed above, obesity can lead to increased retention of both sodium and water. As the fat stores are metabolized, they produce water (which is denser than the fat), and the water may largely be retained. In fact, some individuals may actually observe short-term weight gain on certain diets, even though the diet is working perfectly well in terms of breaking down their adipose tissue. This metabolic fact of life can be psychologically devastating to dieters, who expect quick results for all their sacrifice.

27.6—

Carbohydrates

The chief metabolic role of carbohydrates in the diet is for energy production. Any carbohydrate in excess of that needed for energy is converted to glycogen and triacylglycerol for long-term storage. The body can adapt to a wide range of carbohydrate levels in the diet. Diets high in carbohydrate result in higher steady-state levels of glucokinase and some of the enzymes involved in the hexose monophosphate shunt and triacylglycerol synthesis. Diets low in carbohydrate result in higher steady-state levels of some of the enzymes involved in gluconeogenesis, fatty acid oxidation, and amino acid catabolism. **Glycogen stores** are also affected by the carbohydrate content of the diet (see Clin. Corr. 27.4).

The most common nutritional problems involving carbohydrates are seen in those individuals with various **carbohydrate intolerances**. The most common form of carbohydrate intolerance is **diabetes mellitus**, caused either by lack of insulin production or lack of insulin receptors. This causes an intolerance to glucose and sugars that can readily be converted to glucose. Dietary treatment of diabetes is discussed in Clinical Correlation 27.5. **Lactase insufficiency** is also a common disorder of carbohydrate metabolism affecting over 30 million people in the United States alone. It is most prevalent among blacks, Asians, and Hispanics. Without the enzyme lactase, the lactose is not significantly hydrolyzed or absorbed. It remains in the intestine where it acts osmotically to draw water into the gut and serves as a substrate for conversion to lactic acid, CO₂, and H₂S by intestinal bacteria. The end result is bloating, flatulence, and diarrhea—all of which can be avoided simply by eliminating milk and milk products from the diet (see p. 1075).

CLINICAL CORRELATION 27.4**Carbohydrate Loading and Athletic Endurance**

The practice of carbohydrate loading dates back to observations made in the early 1960s that endurance during vigorous exercise was limited primarily by muscle glycogen stores. Of course, the glycogen stores are not the sole energy source for muscle. Free fatty acids are present in the blood during vigorous exercise and are utilized by muscle along with the glycogen stores. Once the glycogen stores have been exhausted, however, muscle cannot rely entirely on free fatty acids without tiring rapidly. This is probably related to the fact that muscle becomes partially anaerobic during vigorous exercise. While glycogen stores are utilized equally well aerobically or anaerobically, fatty acids can only be utilized aerobically. Under those conditions, fatty acids cannot provide ATP rapidly enough to serve as the sole energy source.

Thus the practice of carbohydrate loading to increase glycogen stores was devised for track and other endurance athletes. Originally, it was thought that it would be necessary to trick the body into increasing glycogen stores. The original carbohydrate loading regimen consisted of a 3–4-day period of heavy exercise while on a low-carbohydrate diet, followed by 1–2 days of light exercise while on a high-carbohydrate diet. The initial low-carbohydrate–high-energy demand period caused a depletion of muscle glycogen stores. Apparently, the subsequent change to a high-carbohydrate diet resulted in a slight rebound effect, with the production of higher than normal levels of insulin and growth hormone. Under these conditions glycogen storage was favored and glycogen stores reached almost twice the normal amounts. This practice did increase endurance significantly. In one study, test subjects on a high-fat and high-protein diet had less than 1.6 g of glycogen per 100 g of muscle and could perform a standardized workload for only 60 min. When the same subjects then consumed a high-carbohydrate diet for 3 days, their glycogen stores increased to 4 g per 100 g of muscle and the same workload could be performed for up to 4 h.

While the technique clearly worked, the athletes often felt lethargic and irritable during the low-carbohydrate phase of the regimen, and the high-fat diet ran counter to current health recommendations. Fortunately, recent studies show that regular consumption of a high complex-carbohydrate–low-fat diet during training increases glycogen stores without the need for tricking the body with sudden dietary changes. Current recommendations are for endurance athletes to consume a high-carbohydrate diet (with emphasis on complex carbohydrates) during training. Then carbohydrate intake is increased further (to 70% of calories) and exercise tapered off during the 2–3 days just prior to an athletic event. This procedure increases muscle glycogen stores to levels comparable to the original carbohydrate loading regimen.

Conlee, R. K. Muscle glycogen and exercise endurance: a twenty-year perspective. *Exerc. Sport Sci. Rev.* 15:1, 1987; Ivey, J. L., Katz, A. L., Cutler, C. L., Sherman, W. M., and Cayle, E. F. Muscle glycogen synthesis after exercise: effect of time of carbohydrate ingestion. *J. Appl. Physiol.* 64:1480, 1988; and Probart, C. K., Bird, P. J., and Parker, K. A. Diet and athletic performance. *Med. Clin. North Am.* 77:757, 1993.

CLINICAL CORRELATION 27.5**High-Carbohydrate Versus High-Fat Diets for Diabetics**

For years the American Diabetes Association has recommended diets that were low in fat and high in complex carbohydrates and fiber for diabetics. The logic of such a recommendation seemed to be inescapable. Diabetics are prone to hyperlipidemia with attendant risk of heart disease, and low-fat diets appeared likely to reduce risk of hyperlipidemia and heart disease. In addition, numerous clinical studies had suggested that the high-fiber content of these diets resulted in improved control of blood sugar. This recommendation has proved to be controversial. An understanding of the controversies involved illustrates the difficulties in making dietary recommendations for population groups rather than individuals. In the first place, it is very difficult to make any major changes in dietary composition without changing other components of the diet. In fact, most of the clinical trials of the high-carbohydrate–high-fiber diets have resulted in significant weight reduction, either by design or because of the lower caloric density of the diet. Since weight reduction improves diabetic control, it is not entirely clear whether the improvements seen in the treated group were due to the change in diet composition *per se* or because of the weight loss. Second, there is significant individual variation in how diabetics respond to these diets. Many diabetic patients appear to show poorer control (as evidenced by higher blood glucose levels, elevated VLDL and/or LDL levels, and reduced HDL levels) on the high-carbohydrate–high-fiber diets than they do on diets high in monounsaturated fatty acids. However, diets high in monounsaturated fatty acids tend to have higher caloric density and are inappropriate for overweight individuals with type 2 (non-insulin dependent) diabetes. Thus a single diet may not be equally appropriate for all diabetics. Even the "glycemic index" concept (Table 27.2) may also turn out to be difficult to apply to the diabetic population as a whole, because of individual variation. Thus in 1994 the American Diabetes Association abandoned the concept of a single diabetic diet. Instead, their recommendations focus on achievement of glucose, lipid, and blood pressure goals, with weight reduction and dietary recommendations based on individual preferences and what works best to achieve metabolic control in that individual.

Anderson, J. W., Gustafson, N.J., Bryant, C. A., and Tietyen-Clark, J. Dietary fiber and diabetes: a comprehensive review and practical application. *J. Am. Diet Assoc.* 87:1189, 1987; Jenkins, D. J. A., Wolener, T. M. S., Jenkins, A. L., and Taylor, R. H. Dietary fiber, carbohydrate metabolism and diabetes. *Mol. Aspects Med.* 9:97, 1987; Garg, A., Grundy, S. M., and Unger, R. H. Comparison of the effects of high and low carbohydrate diets on plasma lipoproteins and insulin sensitivity in patients with mild NIDDM. *Diabetes* 41:1278, 1992; and American Diabetes Association. Nutritional recommendations and principles for people with diabetes. *Diabetes Care* 17:519, 1994.

27.7—

Fats

Triacylglycerols, or fats, are directly utilized by many tissues of the body as an energy source and, as phospholipids, are an important part of membrane structure. Excess fat in the diet can only be stored as triacylglycerol. As with carbohydrate, the body adapts to a wide range of fat intakes. However, problems develop at the extremes (either high or low) of fat consumption. At the low end, **essential fatty acid (EFA)** deficiencies may become a problem. The fatty acids linoleic, linolenic, and arachidonic acid cannot be made by the body and thus are essential components of the diet. These EFAs are needed for maintaining the function and integrity of membrane structure, for fat metabolism and transport, and for synthesis of **prostaglandins**. The most characteristic symptom of essential fatty acid deficiency is a scaly dermatitis. EFA deficiency is very rare in the United States, occurring primarily in low-birth-weight infants fed artificial formulas lacking EFA and in hospitalized patients maintained on total parenteral nutrition for long periods of time. At the high end of the scale, there is concern that excess dietary fat causes elevation of serum lipids and thus an increased risk of heart disease. Recent studies also suggest that high-fat intakes are associated with increased risk of colon, breast, and prostate cancer, but it is not yet certain whether the cancer risk is associated with fat intake *per se* or with the excess calories associated with a high-fat diet. To the extent that fat intake is associated with cancer risk, animal studies suggest that polyunsaturated fatty acids of the ω -6 series may be more tumorigenic than other unsaturated fatty acids. The reason for this is not known, but it has been suggested that prostaglandins derived from the ω -6 fatty acids may stimulate tumor progression.

27.8—

Fiber

Dietary fiber is defined as those components of food that cannot be broken down by human digestive enzymes. It is incorrect, however, to assume that fiber is indigestible since some fibers are, in fact, at least partially broken down by intestinal bacteria. Knowledge of the role of fiber in human metabolism has expanded significantly in the past decade. Our current understanding of the metabolic roles of dietary fiber is based on three important observations: (1) there are several different types of dietary fiber, (2) they each have different chemical and physical properties, and (3) they each have different effects on human metabolism, which can be understood, in part, from their unique properties.

The major types of fiber and their properties are summarized in Table 27.1. **Cellulose** and most **hemicelluloses** increase stool bulk and decrease transit time. These are the types of fiber that should most properly be associated with the effects of fiber on regularity. They decrease intracolonic pressure and appear to play a beneficial role with respect to diverticular diseases. By diluting out potential carcinogens and speeding their transit through the colon, they may also play a role in reducing the risk of colon cancer. **Lignins** have a slightly different role. In addition to their bulk-enhancing properties, they adsorb organic substances such as cholesterol and appear to have a cholesterol-lowering effect. **Mucilaginous fibers**, such as pectin and gums, tend to form viscous gels in the stomach and intestine and slow the rate of gastric emptying, thus slowing the rate of absorption of many nutrients. The most important clinical role of these fibers is to slow the rate at which carbohydrates are digested and absorbed. Thus both the rise in blood sugar and the subsequent rise in insulin levels are significantly decreased if these fibers are ingested along with carbohydrate-containing foods. **Water-soluble fibers** (pectins, gums, some hemicelluloses, and storage polysaccharides) also help to lower serum cholesterol levels in most people. Whether this is due to their effect on insulin levels (insulin

TABLE 27.1 Major Types of Fiber and Their Properties

<i>Type of Fiber</i>	<i>Major Source in Diet</i>	<i>Chemical Properties</i>	<i>Physiological Effects</i>
Cellulose	Unrefined cereals	Nondigestible	Increases stool bulk
	Bran	Water insoluble	Decreases intestinal transit time
	Whole wheat	Absorbs water	Decreases intracolonic pressure
Hemicellulose	Unrefined cereals	Partially digestible	Increases stool bulk
	Some fruits and vegetables	Usually water insoluble	Decreases intestinal transit time
	Whole wheat	Absorbs water	Decreases intracolonic pressure
Lignin	Woody parts of vegetables	Nondigestible	Increases stool bulk
		Water insoluble	Bind cholesterol
		Absorbs organic substances	Bind carcinogens
Pectin	Fruits	Digestible	Decreases rate of gastric emptying
		Water soluble	Decreases rate of sugar uptake
		Mucilaginous	Decreases serum cholesterol
Gums	Dried beans	Digestible	Decreases rate of gastric emptying
		Water soluble	Decreases rate of sugar uptake
		Mucilaginous	Decreases serum cholesterol

stimulates cholesterol synthesis and export) or to other metabolic effects (perhaps caused by end products of partial bacterial digestion) is unknown. Vegetables, wheat, and most grain fibers are the best sources of the water-insoluble cellulose, hemicellulose, and lignin. Fruits, oats, and legumes are the best source of the water-soluble fibers. Obviously, a balanced diet should include food sources of both soluble and insoluble fiber.

27.9—

Composition of Macronutrients in the Diet

From the foregoing discussion it is apparent that there are relatively few instances of macronutrient deficiencies in the American diet. Thus much of the interest in recent years has focused on whether there is an ideal diet composition consistent with good health. It would be easy to pass off such discussions as purely academic, yet our understanding of these issues could well be vital. Heart disease, stroke, and cancer kill many Americans each year, and if some experts are even partially correct, many of these deaths could be preventable with prudent diet.

Composition of the Diet Affects Serum Cholesterol

With respect to heart disease, the current discussion centers around two key issues: (1) Can serum cholesterol and triacylglycerol levels be controlled by diet? (2) Does lowering serum cholesterol and triacylglycerol levels protect against heart disease? The controversies centered around dietary control of cholesterol levels illustrate perfectly the trap one falls into by trying to look too closely at each individual component of the diet instead of the diet as a whole. For example, there are at least four dietary components that can be identified as having an effect on serum cholesterol: cholesterol itself, **polyunsaturated fatty acids (PUFAs)**, **saturated fatty acids (SFAs)**, and fiber. It would seem that the more cholesterol one eats, the higher the serum cholesterol should be. However, cholesterol synthesis is tightly regulated via a feedback control at the hydroxymethylglutaryl-CoA reductase step, so decreases in dietary cholesterol have relatively little effect on serum cholesterol levels (see p. 415). One can obtain a more significant reduction in cholesterol and triacylglycerol levels by

increasing the ratio of PUFA/SFA in the diet. Finally, some plant fibers, especially the water-soluble fibers, appear to decrease cholesterol levels significantly.

While the effects of various lipids in the diet can be dramatic, the biochemistry of their action is still uncertain. Saturated fats inhibit receptor-mediated uptake of LDL, but the mechanism is complex. Palmitic acid (saturated, C16) raises cholesterol levels while stearic acid (saturated, C18) is neutral. Polyunsaturated fatty acids lower both LDL and HDL cholesterol levels, while oleic acid (monounsaturated, C18) appears to lower LDL without affecting HDL levels. Furthermore, the ω -3 and ω -6 polyunsaturated fatty acids have slightly different effects on lipid profiles (see Clin. Corr. 27.6). However, these mechanistic complexities do not significantly affect dietary recommendations. Most foods high in saturated fats contain both palmitic and stearic acid and are atherogenic. The data showing oleic acid lowers LDL levels mean that olive oil, and possibly peanut oil, may be considered as beneficial as polyunsaturated oils.

There is very little disagreement with respect to these data. The question is, what can be done with the information? Much of the disagreement arises from the tendency to look at each dietary factor in isolation. For example, it is debatable whether it is worthwhile placing a patient on a highly restrictive 300-mg cholesterol diet (1 egg = 213 mg of cholesterol) if his serum cholesterol is lowered by only 5–10%. Likewise, changing the **PUFA/SFA ratio** from 0.3 (the current value) to 1.0 would either require a radical change in the diet by elimination of foods containing saturated fat (largely meats and fats) or an addition of large amounts of rather unpalatable polyunsaturated fats to the diet. For many Americans this would be unrealistic. Fiber is another good example. One could expect, at the most, a 5% decrease in serum cholesterol by adding any reasonable amount of fiber to the diet. (Very few people would eat the

CLINICAL CORRELATION 27.6

Polyunsaturated Fatty Acids and Risk Factors for Heart Disease

Recent studies confirming that reduction of elevated serum cholesterol levels can reduce risk of heart disease have rekindled interest in the effects of diet on serum cholesterol levels and other risk factors for heart disease. We have known for years that one of the most important dietary factors regulating serum cholesterol levels is the ratio of polyunsaturated fats (PUFAs) to saturated fats (SFAs) in the diet. One of the most interesting recent developments is the discovery that different types of polyunsaturated fatty acids have different effects on lipid metabolism and on other risk factors for heart disease. As discussed in Chapter 9, there are two families of polyunsaturated essential fatty acids—the ω -6, or linoleic family, and the ω -3, or linolenic family. Recent clinical studies have shown that the ω -6 PUFAs (chief dietary source is linoleic acid from plants and vegetable oils) primarily decrease serum cholesterol levels, with only modest effects on triacylglycerol levels. The ω -3 PUFAs (chief dietary source is eicosapentaenoic acid from certain ocean fish and fish oils) cause modest decreases in serum cholesterol levels and significantly lower triacylglycerol levels. The biochemical mechanism behind these different effects on serum lipid levels is unknown.

The ω -3 PUFAs have yet another unique physiological effect that may decrease the risk of heart disease—they decrease platelet aggregation. The mechanism of this effect is a little clearer. Arachidonic acid (ω -6 family) is known to be a precursor of thromboxane A_2 (TXA₂), which is a potent proaggregating agent, and prostaglandin I₂ (PGL₂), which is a weak antiaggregating agent (see p. 436). The ω -3 PUFAs are thought to act by one of two mechanisms: (1) Eicosapentaenoic acid (ω -3 family) may be converted to thromboxane A₃ (TXA₃), which is only weakly proaggregating, and prostaglandin I₃ (PGI₃), which is strongly antiaggregating. Thus the balance between proaggregation and antiaggregation would be shifted toward a more antiaggregating condition as the ω -3 PUFAs displace ω -6 PUFAs as a source of precursors to the thromboxanes and prostaglandins. (2) The ω -3 PUFAs may also act by simply inhibiting the conversion of arachidonic acid to TXA₂.

The unique potential of eicosapentaenoic acid and other ω -3 PUFAs in reducing the risk of heart disease is being tested in numerous clinical trials. Although the results may affect dietary recommendations in the future, it is well to keep in mind that no long-term clinical studies of the ω -3 PUFAs have been carried out. No major health organization has recommended that we replace ω -6 with ω -3 PUFAs in the American diet.

Holub, B. J. Dietary fish oils containing eicosapentaenoic acid and the prevention of atherosclerosis and thrombosis. *Can. Med. Assoc. J.* 139:377, 1988; Simopoulos, A. P. Omega-3 fatty acids in health and disease and in growth and development. *Am. J. Clin. Nutr.* 54:438, 1991; and Gapinski, J. P., Van Ruiswyk, J. V., Heudebert, G. R., and Schectman, G. S. Preventing restenosis with fish-oils following coronary angioplasty. A meta-analysis. *Arch. Intern. Med.* 153:1595, 1993.

ten apples per day needed to lower serum cholesterol by 15%.) Are we to conclude then that any dietary means of controlling cholesterol levels is useless? Only if each element of the diet is examined in isolation. For example, recent studies have shown that vegetarians, who have lower cholesterol intakes plus higher PUFA/SFA ratios and higher fiber intakes, may average 25–30% lower cholesterol levels than their nonvegetarian counterparts. Perhaps, more to the point, diet modifications of the type acceptable to the average American have been shown to cause a 10–15% decrease in cholesterol levels in long-term studies. A 7-year clinical trial sponsored by the National Institutes of Health has proved conclusively that lowering serum cholesterol levels reduces the risk of heart disease in men. It is important to keep in mind that serum cholesterol is just one of many risk factors.

Effects of Refined Carbohydrate in the Diet Are Not Straightforward

Much of the nutritional dispute in the area of carbohydrates centers around the amount of *refined carbohydrate* in the diet. In the past, simple sugars (primarily sucrose) have been blamed for almost every ill from tooth decay to heart disease and diabetes. In the case of tooth decay, these assertions were clearly correct. In the case of heart disease, however, the linkage is more obscure (see Clin. Corr. 27.7). The situation with respect to diabetes is probably even less direct. Whereas restriction of simple sugars is often desirable in patients who already have diabetes, recent studies show less than expected correlation between the type of carbohydrate ingested and the subsequent rise in serum glucose levels (Table 27.2). Ice cream, for example, causes a much smaller increase in serum glucose levels than either potatoes or whole wheat bread. It turns out that other components of food—such as protein, fat, and the soluble fibers—are much more important than the type of carbohydrate present in determining how rapidly glucose will enter the bloodstream.

CLINICAL CORRELATION 27.7

Metabolic Adaptation: The Relationship between Carbohydrate Intake and Serum Triacylglycerols

In evaluating the nutrition literature, it is important to be aware that most clinical trials are of rather short duration (2–6 weeks), while some metabolic adaptations may take considerably longer. Thus even apparently well-designed clinical studies may lead to erroneous conclusions that will be repeated in the popular literature for years to come. For example, several studies carried out in the 1960s and 1970s tried to assess the effects of carbohydrate intake on serum triacylglycerol levels. Typically, young college-age males were given a diet in which up to 50% of their fat calories were replaced with sucrose or other simple sugars for a period of 2–3 weeks. In most cases serum triacylglycerol levels increased markedly (up to 50%). This led to the tentative conclusion that high intake of simple sugars, particularly sucrose, might increase the risk of heart disease, a notion that was popularized by nutritional best sellers such as "Sugar Blues" and "Sweet and Dangerous." Unfortunately, while the original conclusions were promoted in the lay press, the experiments themselves were questioned. Subsequent studies showed that if these trials were continued for longer periods of time (3–6 months), the triacylglycerol levels usually normalized. The nature of this slow metabolic adaptation is unknown.

It should be noted that while the interpretation of the original clinical trials may have been faulty, the ensuing dietary recommendations may not have been entirely incorrect. Many of the snack and convenience foods in the American diet that are high in sugar are also high in fat and in caloric density. Thus removing some of these foods from the diet can aid in weight control, and being overweight is known to contribute to hypertriacylglycerolemia. Also, some individuals exhibit carbohydrate-induced hypertriacylglycerolemia. Triacylglycerol levels in these individuals respond dramatically to diets that substitute foods containing complex carbohydrates and fiber for these foods containing primarily simple sugars as a carbohydrate source.

MacDonald, I. Effects of dietary carbohydrates on serum lipids. *Prog. Biochem. Pharmacol.* 8:216, 1973; and Vrana, A., and Fabry, P. Metabolic effects of high sucrose or fructose intake. *World Rev. Nutr. Diet* 42:56, 1983.

TABLE 27.2 Glycemic Index^a of Some Selected Foods

Grain and cereal products		Root vegetables	
Bread (white)	69 ± 5	Beets	64 ± 16
Bread (whole wheat)	72 ± 6	Carrots	92 ± 20
Rice (white)	72 ± 9	Potato (white)	70 ± 8
Sponge cake	46 ± 6	Potato (sweet)	48 ± 6
Breakfast cereals		Dried legumes	
All bran	51 ± 5	Beans (kidney)	29 ± 8
Cornflakes	80 ± 6	Beans (soy)	15 ± 5
Oatmeal	49 ± 8	Peas (blackeye)	33 ± 4
Shredded wheat	67 ± 10		
Vegetables		Fruits	
Sweet corn	59 ± 11	Apple (Golden Delicious)	39 ± 3
Frozen peas	51 ± 6	Banana	62 ± 9
		Oranges	40 ± 3
Dairy products		Sugars	
Ice cream	36 ± 8	Fructose	20 ± 5
Milk (whole)	34 ± 6	Glucose	100
Yogurt	36 ± 4	Honey	87 ± 8
		Sucrose	59 ± 10

Source: Data from Jenkins, D. A., et al. Glycemic index of foods: a physiological basis for carbohydrate exchange. *Am. J. Clin. Nutr.* 34:362, 1981.

^a Glycemic index is defined as the area under the blood glucose response curve for each food expressed as a percentage of the area after taking the same amount of carbohydrate as glucose (mean: 5–10 individuals).

Mixed Vegetable and Animal Proteins Meet Nutritional Protein Requirements

Concern has been voiced recently about the type of protein in the American diet. Epidemiologic data and animal studies suggest that consumption of animal protein is associated with increased incidence of heart disease and various forms of cancer. One could assume that it is probably not the animal protein itself that is involved, but the associated fat and cholesterol. What sort of protein should we consume? Although the present diet may not be optimal, a strictly vegetarian diet may not be acceptable to many Americans. Perhaps a middle road is best. Clearly, there are no known health dangers associated with a mixed diet that is lower in animal protein than the current American standard.

An Increase in Fiber from Varied Sources Is Desirable

Because of our current knowledge about effects of fiber on human metabolism, most suggestions for a prudent diet recommend an increase in dietary fiber. The main question is: "How much is enough?" The current fiber content of the American diet is about 14–15 g per day. Most experts feel that an increase to at least 25–30 g would be safe and beneficial. Since we know that different fibers have different metabolic roles, this increase in fiber intake should come from a wide variety of fiber sources—including fresh fruits, vegetables, and legumes as well as the more popular cereal sources of fiber (which are primarily cellulose and hemicellulose).

Current Recommendations Are for a "Prudent Diet"

Several private and governmental groups have made specific recommendations with respect to the ideal dietary composition for the American public in recent years. This movement was spearheaded by the Senate Select Committee on Human Nutrition, which first published its *Dietary Goals for the United States*

in 1977. The Senate Select Committee recommended that the American public reduce consumption of total calories, total fat, saturated fat, cholesterol, simple sugars, and salt to "ideal" goals more compatible with good health (Figure 27.2). In recent years the USDA, the American Heart Association, the American Diabetes Association, the National Research Council, and the Surgeon General all have published similar recommendations, and the USDA has used these recommendations to design revised recommendations for a balanced diet (Figure 27.3). These recommendations have become popularly known as the **prudent diet**. How valid is the scientific basis of the recommendations for a prudent diet? Is there evidence that a prudent diet will improve the health of the general public? These remain controversial questions.

An important argument against such recommendations is that we presently do not have enough information to set concrete goals. We might be creating some problems while solving others. For example, the goals of reducing total fat and saturated fat in the diet are best met by replacing animal protein with vegetable protein. This might reduce the amount of available iron and vitamin B₁₂ in the diet. It is also quite clear that the same set of guidelines do not apply for every individual. For example, exercise is known to raise serum HDL cholesterol and obesity is known to elevate cholesterol and triacylglycerols and reduce glucose tolerance. Thus the very active individual who maintains ideal body weight can likely tolerate higher fat and sugar intakes than an obese individual.

On the "pro" side, however, it clearly can be argued that all of the dietary recommendations are in the right direction for reducing nutritional risk factors in the general population. Besides, similar diets have been consumed by our ancestors and by people in other countries with no apparent harm. Whatever

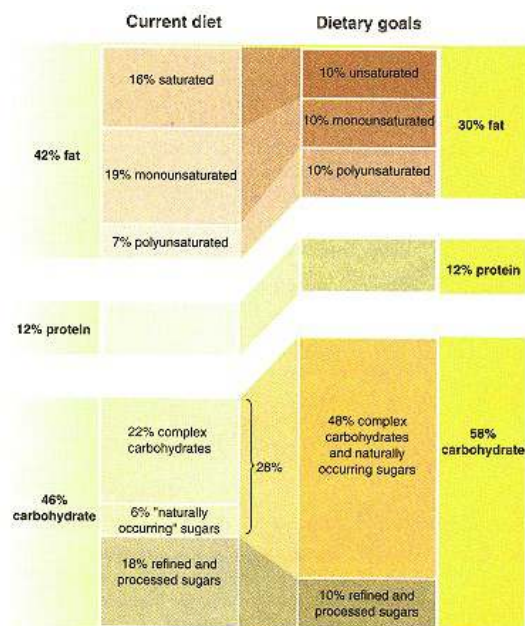

Figure 27.2

United States dietary goals.

Graphical comparison of the composition of the current U.S. diet and the dietary goals for the U.S. population suggested by the Senate Select Committee on Human Nutrition.

From *Dietary Goals for the United States*, 2nd ed.
Washington, DC: U.S. Government Printing Office, 1977.

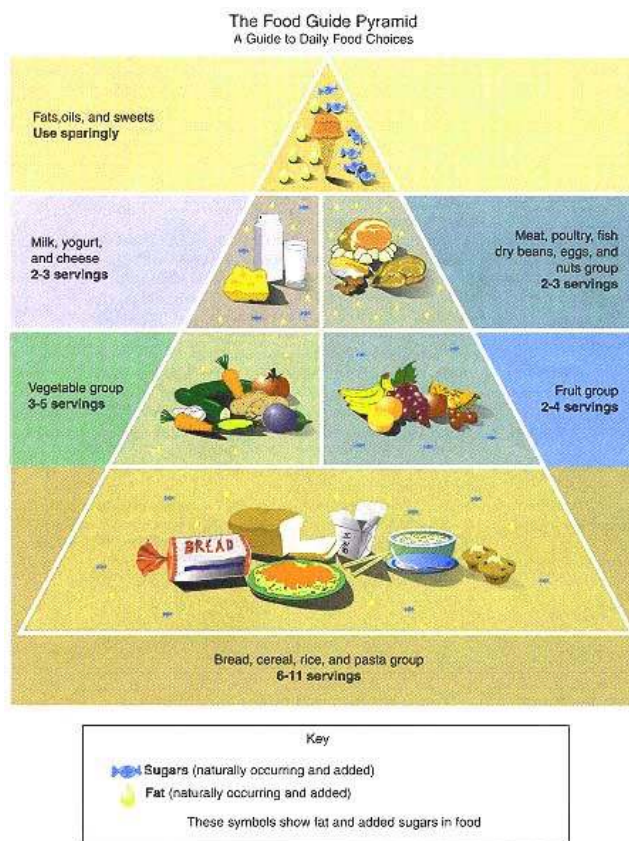

Figure 27.3
USDA food pyramid.

Graphical representation of USDA recommendations for a balanced diet.
HG Bulletin #252. Washington, DC: U.S. Government Printing Office, 1992.

the outcome of this debate, it will undoubtedly shape much of our ideas concerning the role of nutrition in medicine.

Bibliography

Protein Energy Malnutrition in Hospitalized Patients

The Veterans Affairs Total Parenteral Nutrition Cooperative Study Group. Perioperative total parenteral nutrition in surgical patients. *N. Engl. J. Med.* 325:525, 1991.

Metabolic Consequences of Obesity

Hershcopf, R. J., and Bradlow, H. L. Obesity, diet, endogenous estrogens, and the risk of hormone-sensitive cancer. *Am. J. Clin. Nutr.* 45:283, 1987.

Maxwell, M. H., and Waks, A. U. Obesity and hypertension. *Bibl. Cardiol.* 41:29, 1987.

Pi-Sunyer, F. X. Health implications of obesity. *Am. J. Clin. Nutr.* 53:1595S, 1991.

Simopoulos, A. P. Obesity and carcinogenesis: historical perspective. *Am. J. Clin. Nutr.* 45:271, 1987.

Metabolic Predisposition to Obesity

Bjorntorp, P. Fat cell distribution and metabolism. *Ann. N.Y. Acad. Sci.* 499:66, 1987.

Bray, G. A. Obesity—a disease of nutrient or energy balance? *Nutr. Rev.* 45:33, 1987.

Campfield, L. A., Smith, F. J., Guisez, Y., Devos, R., and Burn, P. Recombinant mouse OB protein: evidence for a peripheral signal linking adiposity and central neural networks. *Science* 269:546, 1995.

Dulloo, A. G., and Miller, D. S. Obesity: a disorder of the sympathetic nervous system. *World Rev. Nutr. Diet.* 50:1, 1987.

Halaas, J. L., Gajiwala, K. S., Maffei, M., Cohen, S. L., Chait, B. T., Rabinowitz, D., Lallone, R. L., Burley, S. K., and Friedman, J. M. Weight-reducing effects of the plasma protein encoded by the obese gene. *Science* 269:543, 1995.

Complex Carbohydrates and Fiber

Anderson, J. W. Fiber and health: an overview. *Am. J. Gastroenterol.* 81:892, 1986.

Eastwood, M. Dietary fiber and the risk of cancer. *Nutr. Rev.* 45:193, 1987.

Miller, J. C. B. Importance of glycemic index in diabetes. *Am. J. Clin. Nutr.* 59(Suppl.):747S, 1994.

Shankar, S., and Lanza, E. Dietary fiber and cancer prevention. *Hematol. Oncol. Clin. North Am.* 5:25, 1991.

Wolever, T. M. S., Jenkins, D. J. A., Jenkins, A. L., and Josse, R. G. The glycemic index: methodology and clinical implications. *Am. J. Clin. Nutr.* 54:846, 1991.

Macronutrient Composition and Health

Gardener, C. D., and Kraemer, H. C. Monounsaturated versus polyunsaturated dietary fat and serum lipids. *Arterioscler. Thromb. Vasc. Biol.* 15:1917, 1995.

Gorlin, R. The biological actions and potential clinical significance of dietary ω -3 fatty acids. *Arch. Intern. Med.* 148:2043, 1988.

Grundey, S. M. Monounsaturated fatty acids, plasma cholesterol, and coronary heart disease. *Am. J. Clin. Nutr.* 45:1168, 1987.

Grundey, S. M., et al. Rationale of the diet—heart statement of the American Heart Association, news from the American Heart Association. *Circulation* 65:839A, 1982.

Kisselbah, A., and Schetman, G. Polyunsaturated and saturated fat, cholesterol, and fatty acid supplementation. *Diabetes Care* 11:129, 1988.

Kritchevsky, D., and Klurfeld, D. M. Caloric effects in experimental mammary tumorigenesis. *Am. J. Clin. Nutr.* 45:236, 1987.

Rasmussen, O. W., Thomsen, C., Hansen, K. W., Vesterland, M., Winther, E., and Hermansen, K. Effects on blood pressure, glucose, and lipid levels of a high monounsaturated fat diet compared with a high-carbohydrate diet in NIDDM subjects. *Diabetes Care* 16:156S, 1993.

Simopoulos, A. P. Omega-3 Fatty Acids in Health and Disease and in Growth and Development. *Am. J. Clin. Nutr.* 54:438, 1991.

Welsh, C. W. Enhancement of mammary tumorigenesis by dietary fat: review of potential mechanisms. *Am. J. Clin. Nutr.* 45:191, 1987.

Dietary Recommendations

American Heart Association. *Recommendations for Treatment of Hyperlipidemia in Adults*. Dallas: American Heart Association, 1984.

Food and Nutrition Board of the National Academy of Sciences. *Towards Healthful Diets*. Washington, DC: U.S. Government Printing Office, 1980.

National Research Council. *Diet, Nutrition and Cancer*. Washington, DC: National Academy Press, 1982.

Senate Select Committee on Human Nutrition. *Dietary Goals for the United States*, 2nd ed., Stock No. 052-070-04376-8. Washington, DC: U.S. Government Printing Office, 1977.

Truswell, A. S. Evolution of dietary recommendations, goals, and guidelines. *Am. J. Clin. Nutr.* 45:1060, 1987.

U.S. Department of Agriculture. *Nutrition and Your Health, Dietary Guidelines for Americans*, Stock No. 017-001-00416-2. Washington, DC: U.S. Government Printing Office, 1980.

U.S. Department of Agriculture. *The Food Guide Pyramid*, Stock No. HSG-252. Hyattsville, MD: Human Nutrition Information Service, 1992.

U.S. Department of Health and Human Services. *The Surgeon General's Report on Nutrition and Health*, Stock No. 017-001-00465-1. Washington, DC: U.S. Government Printing Office, 1988.

Questions

C. N. Angstadt and J. Baggott

- Of two people with approximately the same weight, the one with the higher basal energy requirement would most likely be:
 - taller.
 - female if the other were male.
 - older.
 - under less stress.
 - all of the above.
- Basal metabolic rate:
 - is not influenced by energy intake.
 - increases in response to starvation.
 - may decrease up to 50% during periods of starvation.
 - increases in direct proportion to energy expenditure.
 - is not responsive to changes in hormone levels.
- The primary effect of the consumption of excess protein beyond the body's immediate needs will be:
 - excretion of the excess as protein in the urine.
 - an increase in the "storage pool" of protein.
 - an increased synthesis of muscle protein.
 - an enhancement in the amount of circulating plasma proteins.
 - an increase in the amount of adipose tissue.
- Which of the following individuals would most likely be in nitrogen equilibrium?
 - a normal, adult male
 - a normal, pregnant female
 - a growing child
 - an adult male recovering from surgery
 - a normal female on a very low protein diet
- Vegetarian diets:
 - cannot meet the body's requirements for all of the essential amino acids.
 - contain only protein that is very readily digestible.
 - are adequate as long as two different vegetables are consumed in the same meal.
 - would require less total protein than meat proteins to meet the requirement for all of the essential amino acids.
 - require that proteins consumed have essential amino acid contents that complement each other.
- In which of the following circumstances would a protein intake of 0.8 g of protein kg⁻¹ (body weight) day⁻¹ probably be adequate?
 - vegetarian diet
 - infancy
 - severe burn
 - about 85–90% of total calories supplied by carbohydrate and fat
 - pregnancy
- Kwashiorkor is:
 - the most common form of protein–calorie malnutrition in the United States.
 - characterized by a thin, wasted appearance.
 - an inadequate intake of food of any kind.

- D. an adequate intake of total calories but a specific deficiency of protein.
- E. an adequate intake of total protein but a deficiency of the essential amino acids.
8. An excessive intake of calories:
- usually does not have adverse metabolic consequences.
 - leads to metabolic changes that are usually irreversible.
 - frequently leads to elevated serum levels of free fatty acids, cholesterol, and triglycerides.
 - is frequently associated with an increased number of insulin receptors.
 - is the only component of obesity.
9. A diet very low in carbohydrate:
- would cause weight loss because there would be no way to replenish citric acid cycle intermediates.
 - would result in no significant metabolic changes.
 - could lead to a chronic ketosis.
 - would lead to water retention.
 - would be the diet of choice for a diabetic.
10. Lactase insufficiency:
- is a more serious disease than diabetes mellitus.
 - has no clinical symptoms.
 - causes an intolerance to glucose.
 - causes an intolerance to milk and milk products.
 - affects utilization of milk by the liver.
11. Dietary fat:
- is usually present, although there is no specific need for it.
 - if present in excess, can be stored as either glycogen or adipose tissue triacylglycerol.
 - should include linoleic and linolenic acids.
 - should increase on an endurance training program in order to increase the body's energy stores.
 - if present in excess, does not usually lead to health problems.
12. Which of the following statements about dietary fiber is/are correct?
- Water-soluble fiber helps to lower serum cholesterol in most people.
 - Mucilaginous fiber slows the rate of digestion and absorption of carbohydrates.
 - Insoluble fiber increases stool bulk and decreases transit time.
 - All of the above are correct.
 - None of the above is correct.
13. Which one of the following dietary regimens would be *most* effective in lowering serum cholesterol?
- restrict dietary cholesterol
 - increase the ratio of polyunsaturated to saturated fatty acids
 - increase fiber content
 - restrict cholesterol and increase fiber
 - restrict cholesterol, increase PUFA/SFA, increase fiber
14. Most nutrition experts currently agree that an excessive consumption of sugar causes:
- tooth decay.
 - diabetes.
 - heart disease.
 - permanently elevated triacylglycerol levels.
 - all of the above.

Refer to the following for Questions 15 and 16:

- 10% of total calories
 - 12% of total calories
 - 30% of total calories
 - 48% of total calories
 - 58% of total calories
15. The dietary goal recommended by the Senate Select Committee on Human Nutrition for Polyunsaturated fatty acids.
16. The dietary goal recommended by the Senate Select Committee on Human Nutrition for complex carbohydrates and naturally occurring sugars.
17. A complete replacement of animal protein in the diet by vegetable protein:
- would be expected to have no effect at all on the overall diet.
 - would reduce the total amount of food consumed for the same number of calories.
 - might reduce the total amount of iron and vitamin B₁₂ available.
 - would be satisfactory regardless of the nature of the vegetable protein used.
 - could not satisfy protein requirements.

Answers

- A A taller person with the same weight would have a greater surface area. B: Males have higher energy requirements than females. C: Energy requirements decrease with age. D: Stress, probably because of the effects of epinephrine and cortisol, increase energy requirements (pp. 1088–1089).
- C This is part of the survival mechanism in starvation. A and B: BMR decreases when energy intake decreases. D: BMR as defined (p. 1088) is independent of energy expenditure. Only when the exercise is repeated on a daily basis so that lean muscle mass is increased does BMR also increase. E: Many hormones increase BMR (p. 1089).
- E Excess protein is treated like any other excess energy source and stored (minus the nitrogen) eventually as adipose tissue fat (p. 1089). A: Protein is not found in normal urine except in very small amounts. The excess nitrogen is excreted as NH₄⁺ and urea, whereas the excess carbon skeletons of the amino acids are used as energy sources. B–D: There is no discrete storage form of protein, and although some muscle and structural protein is expendable, there is no evidence that increased intake leads to generalized increased protein synthesis.

4. A B, C, and D: Although normal, pregnancy is also a period of growth, requiring positive balance, as does a period of convalescence. E: Inadequate protein intake leads to negative balance (p. 1100).
5. E A–E: It is possible to have adequate protein intake on a vegetarian diet provided enough is consumed (protein content is generally low and may be more difficult to digest) and there is a mixture of proteins that supplies all of the essential amino acids since individual proteins are frequently deficient in one or more foods (Clin. Corr. 27.1, p. 1091).
6. D This level of calories from carbohydrate and fat is more than adequate for protein sparing. A: Essential amino acids are low in vegetable protein. B, C, and E: Periods of rapid growth require extra protein, as does major trauma (p. 1092).
7. D A: The most common protein–calorie malnutrition occurs in severely ill, hospitalized patients who would be more likely to have generalized malnutrition. B and C: These are the characteristics of marasmus. E: This would lead to negative nitrogen balance but does not have a specific name (p. 1093).
8. C Probably because an increased number and/or size of adipose cells will contain fewer insulin receptors. A: Excess caloric intake will lead to obesity if continued long enough. B: Fortunately, most of the changes accompanying obesity can be reversed if weight is lost. D: Many of the adverse effects of obesity are associated with an increased number of adipocytes that are deficient in insulin receptors. E: Inadequate exercise and genetic components also play roles in obesity (pp. 1094–1095).
9. C A: This is a popular myth but untrue because many amino acids are glucogenic. B and C: The liver adapts by increasing gluconeogenesis, fatty acid oxidation, and ketone body production. D: Low carbohydrate leads to a depletion of glycogen with its stored water, accounting for rapid initial weight loss on this kind of diet (p. 1095, Clin. Corr. 27.4). E: Diabetic diets need to be individualized. There is currently no generalized recommendation for the carbohydrate content of a diabetic diet (p. 1095 and Clinical Correlation 27.5).
10. D B, D, and E: Lactase insufficiency is an inability to digest the sugar in milk products, causing intestinal symptoms, but is easily treated by eliminating milk products from the diet. A and C: Diabetes, caused by inadequate insulin or insulin receptors, inhibits appropriate utilization of glucose (p. 1095).
11. C A and C: Linoleic and linolenic acids are essential fatty acids and so must be present in the diet. B and D: Excess carbohydrate can be stored as fat but the reverse is not true. D: Carbohydrate loading has been shown to increase endurance. E: High-fat diets are associated with many health risks (p. 1096, Clin. Corr. 27.5).
12. D These each illustrate the different properties and roles of the common kinds of fiber (p. 1097).
13. E Any of the measures alone would decrease serum cholesterol slightly, but to achieve a reduction of more than 15% requires all three (pp. 1098–1100).
14. A This is the only direct linkage shown. B and C: There may be an association with these conditions but not a direct cause–effect relationship. D: Transient elevations may occur on an isocaloric switch from a high-starch to a high-simple-sugar diet but not a permanent elevation (p. 1100).
15. A See Figure 27.2, p. 1102.
16. D See Figure 27.2, p. 1102.
17. C A and C: This would reduce the amount of fat, especially saturated fat, but could also reduce the amount of necessary nutrients that come primarily from animal sources. B: The protein content of vegetables is quite low, so much larger amounts of vegetables would have to be consumed. D and E: It is possible to satisfy requirements for all of the essential amino acids completely if vegetables with complementary amino acid patterns, in proper amounts, are consumed (p. 1101, Clin. Corr. 27.1).

Chapter 28— Principles of Nutrition II: Micronutrients

Stephen G. Chaney



28.1 Overview	1108
28.2 Assessment of Malnutrition	1108
28.3 Recommended Dietary Allowances	1109
28.4 Fat-Soluble Vitamins	1109
Vitamin A Is Derived from Plant Carotenoids	1109
Vitamin D Synthesis in the Body Requires Sunlight	1111
Vitamin E Is a Mixture of Tocopherols	1114
Vitamin K Is a Quinone Derivative	1116
28.5 Water-Soluble Vitamins	1118
28.6 Energy-Releasing, Water-Soluble Vitamins	1119
Thiamine (Vitamin B ₁) Forms the Coenzyme Thiamine Pyrophosphate (TPP)	1119
Riboflavin Is Part of FAD and FMN	1121
Niacin Is Part of NAD and NADP	1121
Pyridoxine (Vitamin B ₆) Forms the Coenzyme Pyridoxal Phosphate	1121
Pantothenic Acid and Biotin Are Also Energy-Releasing Vitamins	1122
28.7 Hematopoietic Water-Soluble Vitamins	1123
(Folic Acid (Folacin) Functions As Tetrahydrofolate in One-Carbon Metabolism	1123
Vitamin B ₁₂ (Cobalamin) Contains Cobalt in a Tetrapyrrole Ring	1125
28.8 Other Water-Soluble Vitamins	1127
Ascorbic Acid Functions in Reduction and Hydroxylation Reactions	1127
28.9 Macrominerals	1128
Calcium Has Many Physiological Roles	1128
Magnesium Is Another Important Macromineral	1129
28.10 Trace Minerals	1130
Iron Is Efficiently Reutilized	1130
Iodine Is Incorporated into Thyroid Hormones	1130
Zinc Is a Cofactor for Many Enzymes	1131
Copper Is also a Cofactor for Important Enzymes	1131
Chromium Is a Component of Glucose Tolerance Factor	1132
Selenium Is a Scavenger of Peroxides	1132
Manganese, Molybdenum, Fluoride, and Boron Are Other Trace Elements	1132
28.11 The American Diet: Fact and Fallacy	1132
28.12 Assessment of Nutritional Status in Clinical Practice	1133
Bibliography	1135
Questions and Answers	1135
Clinical Correlations	
28.1 Nutritional Considerations for Cystic Fibrosis	1112
28.2 Renal Osteodystrophy	1113
28.3 Nutritional Considerations in the Newborn	1117
28.4 Anticonvulsant Drugs and Vitamin Requirements	1118
28.5 Nutritional Considerations in the Alcoholic	1120
28.6 Vitamin B ₆ Requirements for Users of Oral Contraceptives	1124
28.7 Diet and Osteoporosis	1129
28.8 Nutritional Considerations for Vegetarians	1134
28.9 Nutritional Needs of Elderly Persons	1134

28.1—

Overview

Micronutrients play a vital role in human metabolism, being involved in almost every known biochemical reaction and pathway. However, the biochemistry of these nutrients is of little interest unless we also know if dietary deficiencies are likely. The American diet is undoubtedly the best it has ever been. Our current food supply provides us with an abundant variety of foods all year long and deficiency diseases have become medical curiosities. However, our diet is far from optimal. The old adage that we get everything we need from a balanced diet is true only if we eat a balanced diet. Unfortunately, most Americans do not consume a balanced diet. Foods of high caloric density and low nutrient density (often referred to as empty calories or junk food) are an abundant and popular part of the American diet, and our nutritional status suffers because of these food choices. Obviously then, neither alarm nor complacency is justified. We need to know how to evaluate the adequacy of our diet.

28.2—

Assessment of Malnutrition

There are three increasingly stringent criteria for measuring **malnutrition**.

1. **Dietary intake studies**, which are usually based on a 24-hour recall, are the least stringent. The 24-hour recalls almost always tend to overestimate the number of people with deficient diets. Also, poor dietary intake alone is usually not a problem in this country unless the situation is compounded by increased need.
2. **Biochemical assays**, either direct or indirect, are a more useful indicator of the nutritional status of an individual. At their best, they indicate **subclinical nutritional deficiencies** that can be treated before actual deficiency diseases develop. However, all biochemical assays are not equally valid—an unfortunate fact that is not sufficiently recognized. Changes in biochemical parameters due to stress need to be interpreted with caution. The distribution of many nutrients in the body changes dramatically in a stress situation such as illness, injury, and pregnancy. A drop in level of a nutrient in one tissue compartment (usually blood) need not signal a deficiency or an increased requirement. It could simply reflect a normal metabolic adjustment to stress.
3. The most stringent criterion is the appearance of **clinical symptoms**. However, it is desirable to intervene long before symptoms became apparent.

The question remains: When should dietary surveys or biochemical assays be interpreted to indicate the necessity of nutritional intervention? The following general guidelines are useful. Dietary surveys are seldom a valid indication of general malnutrition unless the average intake for a population group falls significantly below the standard (usually two-thirds of the Recommended Dietary Allowance) for one or more nutrients. However, by looking at the percentage of people within a population group who have suboptimal intake, it is possible to identify high-risk population groups that should be monitored more closely. Biochemical assays can definitely identify subclinical cases of malnutrition where nutritional intervention is desirable provided (a) the assay has been shown to be reliable, (b) the deficiency can be verified by a second assay, and (c) there is no unusual stress situation that may alter micronutrient distribution. In assessing nutritional status, it is important for the clinician to be aware of those population groups at risk, the most reliable biochemical assays for monitoring nutritional status, and the symptoms of deficiencies if they should occur.

28.3—

Recommended Dietary Allowances

Recommended Dietary Allowances are the levels of intake of essential nutrients considered by the Food and Nutrition Board of the National Research Council to be adequate to meet the nutritional needs of practically all healthy persons. Optimally, the RDAs are based on daily intake sufficient to prevent the appearance of nutritional deficiency in at least 95% of the population. This determination is relatively easy to make for those nutrients associated with dramatic deficiency diseases, for example, vitamin C and scurvy. In other instances more indirect measures must be used, such as tissue saturation or extrapolation from animal studies. In some cases, such as vitamin E, in which no deficiency symptoms are known to occur in the general population, the RDA is defined as the normal level of intake in the American diet. There is no set of criteria that can be used for all micronutrients, and there are always some uncertainty and debate as to the correct criteria. The criteria are constantly changed by new research. The Food and Nutrition Board normally meets every 6 years to consider currently available information and update its recommendations.

RDAs serve as a useful general guide in evaluating adequacy of diets. However, the RDAs have several limitations that should be kept in mind. Important limitations are as follows:

1. RDAs represent an ideal average intake for groups of people and are best used for evaluating nutritional status of population groups. RDAs are not meant to be standards or requirements for individuals. Some individuals would have no problem with intakes below the RDA, whereas a few may develop deficiencies on intakes above the RDA.
2. RDAs are designed to meet the needs of healthy people and do not take into account special needs arising from infections, metabolic disorders, or chronic diseases.
3. Since present knowledge of nutritional needs is incomplete, there may be unrecognized nutritional needs. To provide for these needs, the RDAs should be met from as varied a selection of foods as possible. No single food can be considered complete, even if it meets the RDA for all known nutrients. This is important, especially in light of the current practice of fortifying foods of otherwise low nutritional value.
4. As currently formulated, RDAs do not define the "optimal" level of any nutrient, since optimal levels are difficult to define. Because of information suggesting that optimal intake of certain micronutrients (e.g., vitamins A, C, and E) may reduce heart disease and cancer risk, some experts feel that the focus of the RDAs should shift from preventing nutritional deficiencies to defining optimal levels that may reduce the risk of other diseases.

28.4—

Fat-Soluble Vitamins*Vitamin A Is Derived from Plant Carotenoids*

The active forms of vitamin A are **retinol**, **retinal** (retinaldehyde), and **retinoic acid**. These substances are synthesized by plants as the more complex **carotenoids** (Figure 28.1), which are cleaved to retinol by most animals and stored in the liver as retinol palmitate. Liver, egg yolk, butter, and whole milk are good sources of the preformed retinol. Dark green and yellow vegetables are generally good sources of the carotenoids. Conversion of carotenoids to retinol is rarely 100%, so that the vitamin A potency of various foods is expressed in terms of retinol equivalents (1 RE is equal to 1 mg retinol, 6 mg β -carotene,

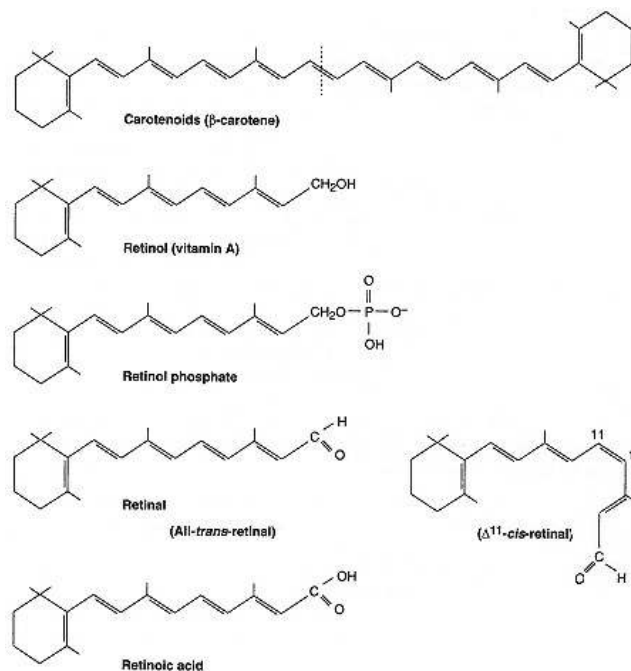

Figure 28.1
Structures of vitamin A and related compounds.

and 12 mg of other carotenoids). β -Carotene and other carotenoids are major sources of vitamin A in the American diet. These carotenoids are first cleaved to retinol and converted to other vitamin A metabolites in the body (Figure 28.1).

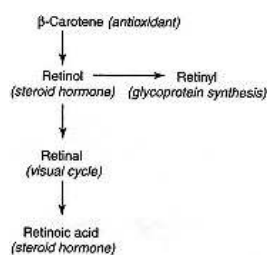

Figure 28.2
Vitamin A metabolism and function.

Vitamin A serves a number of functions in the body. Only in recent years has its biochemistry become well understood (Figure 28.2). **β -Carotene** and some other carotenoids have recently been shown to have an important role as **antioxidants**. At the low oxygen tensions prevalent in the body, β -carotene is a very effective antioxidant and may be expected to reduce the risk of those cancers initiated by free radicals and other strong oxidants. Several retrospective clinical studies have suggested that adequate dietary β -carotene may be important in reducing the risk of lung cancer, especially in people who smoke. However, supplemental β -carotene did not provide any detectable benefit and may have actually increased cancer risk in two recent multicenter prospective studies.

Retinol is converted to **retinyl phosphate** in the body. The retinyl phosphate appears to serve as a **glycosyl donor** in the synthesis of some glycoproteins and mucopolysaccharides in much the same manner as dolichol phosphate (see p. 738). Retinyl phosphate is essential for the synthesis of certain glycoproteins needed for normal growth regulation and for mucus secretion. Both retinol and retinoic acid bind to specific intracellular receptors, which then bind to chromatin and affect the synthesis of proteins involved in the regulation of cell growth and differentiation. Thus both retinol and retinoic acid can be considered to act like **steroid hormones** in regulating growth and differentiation.

Finally, in the Δ^{11} -*cis*-retinal form, vitamin A becomes reversibly associated with the **visual proteins**. When light strikes the retina, a number of complex

biochemical changes take place, resulting in the generation of a nerve impulse, conversion of the retinal to the all-trans form, and its dissociation from the visual protein (see p. 943). Regeneration of more visual pigments requires isomerization back to the Δ^{11} -*cis* form (Figure 28.3).

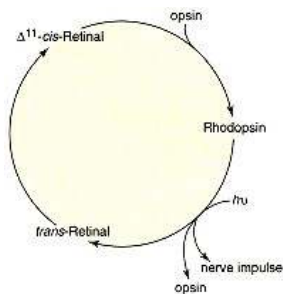

Figure 28.3
Role of vitamin A in vision.

Based on what is known about the biochemical mechanisms of vitamin A action, its biological effects are easier to understand. For example, vitamin A is required for the maintenance of healthy epithelial tissue. Retinol and/or retinoic acid are required to prevent the synthesis of high molecular weight forms of **keratin** and retinyl phosphate is required for the synthesis of glycoproteins (an important component of the mucus secreted by many epithelial tissues). The lack of mucus secretion leads to a drying of these cells, and the excess keratin synthesis leaves a horny keratinized surface in place of the normal moist and pliable epithelium. Vitamin A deficiency can lead to **anemia** caused by impaired mobilization of iron from the liver because retinol and/or retinoic acid are required for the synthesis of the iron transport protein transferrin.

Finally, vitamin A-deficient animals are more susceptible to both infections and cancer. Decreased resistance to infections is thought to be due to keratinization of mucosal cells lining the respiratory, gastrointestinal, and genitourinary tracts. Under these conditions fissures readily develop in the mucosal membranes, allowing microorganisms to enter. Vitamin A deficiency may impair the immune system as well. The protective effect of vitamin A against many forms of cancer probably results from the antioxidant potential of β -carotene and the effects of retinol and retinoic acid in regulating cell growth.

Since vitamin A is stored in the liver, deficiencies of this vitamin can develop only over prolonged periods of inadequate uptake. Mild **vitamin A deficiencies** are characterized by **follicular hyperkeratosis** (rough keratinized skin resembling "goosebumps"), anemia (biochemically equivalent to iron deficiency anemia, but in the presence of adequate iron intake), and increased susceptibility to infection and cancer. **Night blindness** is also an early symptom of vitamin A deficiency. Severe vitamin A deficiency leads to a progressive keratinization of the cornea of the eye known as xerophthalmia in its most advanced stages. In the final stages, infection usually sets in, with resulting hemorrhaging of the eye and permanent loss of vision.

For most people (unless they happen to eat liver) the dark green and yellow vegetables are the most important dietary source of vitamin A. Unfortunately, these are the foods most often missing from the American diet. Nationwide, dietary surveys indicate that between 40% and 60% of the population consumes less than two-thirds of the RDA for vitamin A. Clinical symptoms of vitamin A deficiency are rare in the general population, but vitamin A deficiency is a fairly common consequence of severe liver damage or diseases that cause fat malabsorption (see Clin. Corr. 28.1).

Vitamin A accumulates in the liver and over prolonged periods large amounts of this vitamin can be toxic. Doses of 25,000–50,000 RE per day over months or years will prove to be toxic for many children and adults. The usual symptoms include bone pain, scaly dermatitis, enlargement of liver and spleen, nausea, and diarrhea. It is, of course, virtually impossible to ingest toxic amounts of vitamin A from normal foods unless one eats polar bear liver (6000 RE/g) regularly. Most instances of **vitamin A toxicity** are due to the use of massive doses of vitamin A supplements. Fortunately, this practice is relatively rare because of increased public awareness of vitamin A toxicity.

Vitamin D Synthesis in the Body Requires Sunlight

Technically, vitamin D should be considered a hormone rather than a vitamin. **Cholecalciferol (D₃)** is produced in skin by UV irradiation of 7-dehydrocholesterol (Figure 28.4). Thus, as long as the body is exposed to adequate sunlight,

CLINICAL CORRELATION 28.1**Nutritional Considerations for Cystic Fibrosis**

Patients with malabsorption diseases often develop malnutrition. As an example, let us examine the nutritional consequences of one disease with malabsorption components. Cystic fibrosis (CF) involves a generalized dysfunction of the exocrine glands that leads to formation of a viscid mucus, which progressively plugs the ducts. Obstruction of the bronchi and bronchioles leads to pulmonary infections, which are usually the direct cause of death. In many cases, however, the exocrine glands of the pancreas are also affected, leading to a deficiency of pancreatic enzymes and sometimes a partial obstruction of the common bile duct.

The deficiency (or partial deficiency) of pancreatic lipase and bile salts leads to severe malabsorption of fat and fat-soluble vitamins. Calcium tends to form insoluble salts with the long-chain fatty acids, which accumulate in the intestine. While these are the most severe problems, some starches and proteins are also trapped in the fatty bolus of partially digested foods. This physical entrapment, along with the deficiencies of pancreatic amylase and pancreatic proteases, can lead to severe protein-calorie malnutrition as well. Excessive mucus secretion on the luminal surfaces of the intestine may also interfere with the absorption of several nutrients, including iron.

Fortunately, microsphere preparations of pancreatic enzymes are now available that can greatly alleviate many of these malabsorption problems. With these preparations, protein and carbohydrate absorption rates are returned to near normal. Fat absorption is improved greatly but not normalized, since deficiencies of bile salts and excess mucus secretion persist. Because dietary fat is a major source of calories, these patients have difficulty obtaining sufficient calories from a normal diet. This is complicated by increased protein and energy needs resulting from the chronic infections often seen in these patients. Thus many experts recommend energy intakes ranging from 120–150% of the RDA.

Since inadequate energy intake results in poor growth and increased susceptibility to infection, inadequate caloric intake is of great concern for cystic fibrosis patients. Thus the current recommendations are for high-energy-high-protein diets without any restriction of dietary fat (50% carbohydrate, 15% protein, and 35% fat). If caloric intake from the normal diet is inadequate, dietary supplements or enteral feedings may be used. The dietary supplements most often contain easily digested carbohydrates and milk protein mixtures. Medium-chain triglycerides are sometimes used as a partial fat replacement since they can be absorbed directly through the intestinal mucosa in the absence of bile salts and pancreatic lipase.

Since some fat malabsorption is present, deficiencies of the fat-soluble vitamins often occur. Children aged 2–8 years need a standard adult multiple-vitamin preparation containing 400 IU of vitamin D and 5000 IU of vitamin A per day. Older children, adolescents, and adults need a standard multivitamin at a dose of 1–2 per day. If serum vitamin A levels become low, water-miscible vitamin A preparations should be used. For vitamin E the recommendations are: ages 0–6 mo, 25 IU day⁻¹; 6–12 mo, 50 IU day⁻¹; 1–4 years, 100 IU day⁻¹; 4–10 years, 100–200 IU day⁻¹; and >10 years, 200–400 IU day⁻¹; in water-soluble form. Vitamin K deficiency has not been adequately studied, but the current recommendations are: ages 0–12 mo, 2.5 mg week⁻¹ or 2.5 mg twice a week if on antibiotics; ages >1 year, 5.0 mg twice weekly when on antibiotics or if cholestatic liver disease is present. Iron deficiency is fairly common in cystic fibrosis patients but iron supplementation is not usually recommended because of concern that higher iron levels in the blood might encourage systemic bacterial infections. Calcium levels in the blood are usually normal. However, since calcium absorption is probably suboptimal, it is important to make certain that the diet provides at least RDA levels of calcium.

Littlewood, J. M., and MacDonald, A. Rationale of modern dietary recommendations in cystic fibrosis. *J. R. Soc. Med.* 80(Suppl. 15):16, 1987; and Ramsey, B. W, Farrell, P. M., and Pencharz, P. Nutritional assessment and management in cystic fibrosis; a consensus report. *Am J. Clin. Nutr.* 55:108, 1992.

there is little or no dietary requirement for vitamin D. The best dietary sources of vitamin D₃ are saltwater fish (especially salmon, sardines, and herring), liver, and egg yolk. Milk, butter, and other foods are routinely fortified with **ergocalciferol (D₂)** prepared by irradiating ergosterol from yeast. Vitamin D potency is measured in terms of milligrams of cholecalciferol (1 mg cholecalciferol or ergocalciferol = 40 IU).

Both cholecalciferol and ergocalciferol are metabolized identically. They are carried to the liver where the 25-hydroxy derivative is formed. **25-Hydroxy-cholecalciferol** [25-(OH)D] is the major circulating derivative of vitamin D, and it is in turn converted into the biologically active **1- α ,25-dihydroxycholecalciferol** (also called calcitriol) in the proximal convoluted tubules of kidney (see Clin. Corr. 28.2).

The compound 1,25-(OH)₂D acts in concert with **parathyroid hormone (PTH)**, which is also produced in response to low serum calcium. Parathyroid hormone plays a major role in regulating the activation of vitamin D. High PTH levels stimulate the production of 1,25-(OH)₂D, while low PTH levels induce formation of an inactive 24,25-(OH)₂D. Once formed, the 1,25-(OH)₂D acts

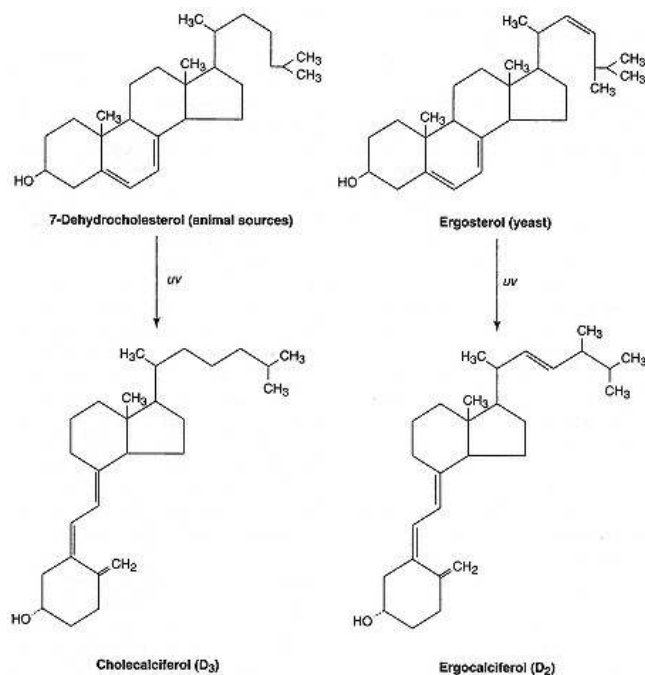

Figure 28.4
Structures of vitamin D and related compounds.

CLINICAL CORRELATION 28.2

Renal Osteodystrophy

In chronic renal failure, a complicated chain of events leads to a condition known as renal osteodystrophy. The renal failure results in an inability to produce $1,25\text{-(OH)}_2\text{D}$, and thus bone calcium becomes the only important source of serum calcium. In the later stages of renal failure, the situation is complicated further by increased renal retention of phosphate and resulting hyperphosphatemia. The serum phosphate levels are often high enough to cause metastatic calcification (i.e., calcification of soft tissue), which tends to lower serum calcium levels further (the solubility product of calcium phosphate in the serum is very low and a high serum level of one component necessarily causes a decreased concentration of the other). The hyperphosphatemia and hypocalcemia stimulate parathyroid hormone secretion, and the resulting hyperparathyroidism further accelerates the rate of bone loss. One ends up with both bone loss and metastatic calcification. In this case, simple administration of high doses of vitamin D or its active metabolites would not be sufficient since the combination of hyperphosphatemia and hypercalcemia would only lead to more extensive metastatic calcification. The readjustment of serum calcium levels by high calcium diets and/or vitamin D supplementation must be accompanied by phosphate reduction therapies. The most common technique is to use phosphate-binding antacids that make phosphate unavailable for absorption. Orally administered $1,25\text{-(OH)}_2\text{D}$ is effective at stimulating calcium absorption in the mucosa but does not enter the peripheral circulation in significant amounts. Thus patients with severe hyperparathyroidism may need to be treated with intravenous $1,25\text{-(OH)}_2\text{D}$.

Johnson, W. J. Use of vitamin D analogs in renal osteodystrophy. *Semin. Nephrol.* 6:31, 1986; McCarthy, J. T., and Kumar, R. Behavior of the vitamin D endocrine system in the development of renal osteodystrophy. *Semin. Nephrol.* 6:21, 1986; and Delmez, J. M., and Siatopolsky, E. Hyperphosphatemia: its consequences and treatment in patients with chronic renal disease. *Am. J. Kidney Dis.* 19:303, 1992.

alone as a typical steroid hormone in intestinal mucosal cells, where it induces synthesis of a protein, calbindin, required for calcium transport. In the bone $1,25\text{-(OH)}_2\text{D}$ and PTH act synergistically to promote bone resorption (demineralization) by stimulating osteoblast formation and activity. Finally, PTH and $1,25\text{-(OH)}_2\text{D}$ inhibit calcium excretion in the kidney by stimulating calcium reabsorption in the distal renal tubules. The overall response of calcium metabolism to several different physiological situations is summarized in Figure 28.5. The response to low serum calcium levels is characterized by elevation of PTH and $1,25\text{-(OH)}_2\text{D}$, which act to enhance calcium absorption and bone resorption and to inhibit calcium excretion (Figure 28.5a). High serum calcium levels block production of PTH. The low PTH levels allow 25-(OH)D to be metabolized to $24,25\text{-(OH)}_2\text{D}$ instead of $1,25\text{-(OH)}_2\text{D}$. In the absence of PTH and $1,25\text{-(OH)}_2\text{D}$ bone resorption is inhibited and calcium excretion is enhanced. High levels of serum calcium and phosphate increase the rate of bone mineralization (Figure 28.5b). Thus bone is a very important reservoir of the calcium and phosphate needed to maintain homeostasis of serum levels. When vitamin D and dietary calcium are adequate, no net loss of bone calcium occurs. However, when dietary calcium is low, PTH and $1,25\text{-(OH)}_2\text{D}$ will cause net demineralization of bone to maintain normal serum calcium levels. Vitamin D deficiency also causes net demineralization of bone due to elevation of PTH (Figure 28.5c).

The most common symptoms of **vitamin D deficiency** are **rickets** in young children and **osteomalacia** in adults. Rickets is characterized by continued formation of osteoid matrix and cartilage, which are improperly mineralized, resulting in soft, pliable bones. In the adult demineralization of preexisting bone takes place, causing the bone to become softer and more susceptible to fracture. This osteomalacia is easily distinguishable from the more common osteoporosis, by the fact that the osteoid matrix remains intact in the former, but not in the latter. Vitamin D may be involved in more than regulation of calcium homeostasis. Receptors for $1,25\text{-(OH)}_2\text{D}$ have been found in many tissues including parathyroid gland, islet cells of pancreas, keratinocytes of skin, and myeloid stem cells in bone marrow. The role of vitamin D in these tissues is the subject of active investigation.

Because of fortification of dairy products with vitamin D, dietary deficiencies are very rare. The cases of dietary vitamin D deficiency that do occur are most often seen in low-income groups, the elderly (who often also have minimal exposure to sunlight), strict vegetarians (especially if their diet is also low in calcium and high in fiber), and chronic alcoholics. Most cases of vitamin D deficiency, however, are a result of diseases causing **fat malabsorption** or severe liver and kidney disease (see Clin. Corr. 28.1 and 28.2). Certain drugs also interfere with vitamin D metabolism. For example, corticosteroids stimulate the conversion of vitamin D to inactive metabolites and have been shown to cause bone demineralization when used for long periods of time.

Vitamin D can also be toxic in doses 10–100 times the RDA. The mechanism of **vitamin D toxicity** is summarized in Figure 28.5d. Enhanced calcium absorption and bone resorption cause hypercalcemia, which can lead to metastatic calcification. The enhanced bone resorption also causes bone demineralization similar to that seen in vitamin D deficiency. Finally, the high serum calcium leads directly to hypercalciuria, which predisposes the patient to formation of renal stones.

Vitamin E Is a Mixture of Tocopherols

For many years **vitamin E** was described as the "vitamin in search of a disease." While vitamin E deficiency diseases are still virtually unknown, its metabolic role in the body has become better understood in recent years. Vitamin E occurs in the diet as a mixture of several closely related compounds, called tocopherols.

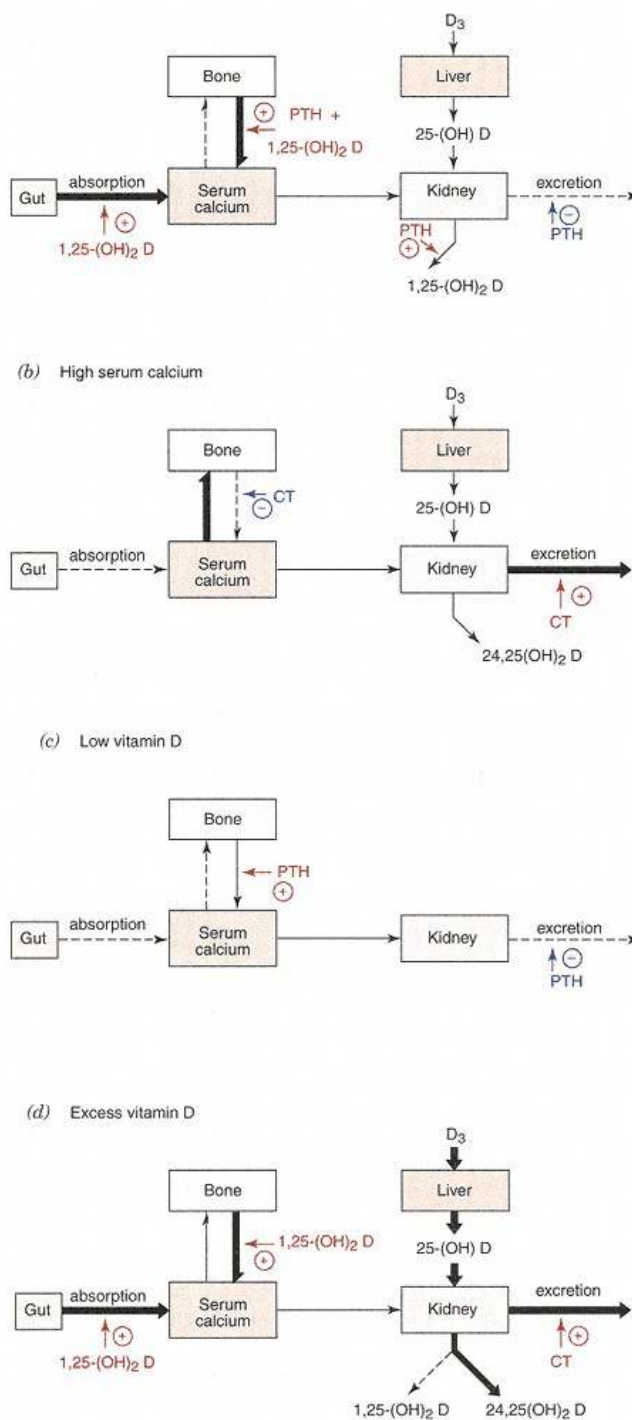

Figure 28.5

Vitamin D and calcium homeostasis.

Dominant pathways of calcium metabolism under each set of metabolic conditions are shown with heavy arrows. The effect of various hormones on these pathways is shown by red arrows for stimulation or blue arrows for repression. PTH, parathyroid hormone; D, cholecalciferol; $25-(OH)D$, 25-hydroxycholecalciferol; and $1,25-(OH)_2D$, 1- α ,25-dihydroxycholecalciferol.

α -Tocopherol is the most potent and is used as the measure of vitamin E potency (1 α -tocopherol equiv = 1 mg α -tocopherol).

First and foremost, vitamin E is an important naturally occurring **antioxidant**. Due to its lipophilic character it accumulates in circulating lipoproteins, cellular membranes, and fat deposits, where it reacts very rapidly with molecular oxygen and free radicals. It acts as a scavenger for these compounds, protecting unsaturated fatty acids (especially those in the membranes) from peroxidation reactions. Vitamin E appears to play a role in cellular respiration, either by stabilizing coenzyme Q or by helping transfer electrons to coenzyme Q. It also appears to enhance heme synthesis by increasing the levels of δ -aminolevulinic acid (ALA) synthetase and ALA dehydratase. Most of these vitamin E effects are thought to be an indirect effect of its antioxidant potential, rather than its actual participation as a coenzyme in any biochemical reactions. For example, an important role of vitamin E in humans is to prevent oxidation of **LDL**, since it appears to be the oxidized form of LDL that is atherogenic. Finally, neurological symptoms have been reported following prolonged vitamin E deficiency associated with malabsorption diseases.

Studies on the recommended levels of vitamin E in the diet have been hampered by the difficulty of producing severe vitamin E deficiency in humans. In general, it has been assumed that the vitamin E levels in the American diet are sufficient, since no major vitamin E deficiency diseases have been found. However, vitamin E requirements increase as intake of polyunsaturated fatty acids (PUFAs) increases. While the recent emphasis on high PUFA diets to reduce serum cholesterol may be of benefit in controlling heart disease, the propensity of PUFA to form free radicals on exposure to oxygen may lead to an increased cancer risk. Thus it appears only prudent to increase vitamin E intake in high PUFA diets.

Premature infants fed on formulas low in vitamin E sometimes develop a form of hemolytic anemia that can be corrected by vitamin E supplementation. Adults suffering from fat malabsorption show a decreased red blood cell survival time. Hence vitamin E supplementation may be necessary with premature infants and in cases of fat malabsorption. In addition, recent studies have suggested that supplementation with at least 100 mg day⁻¹ of vitamin E may decrease the risk of heart disease. This is well above the current RDA and is far greater than can be obtained from even a very well balanced diet. These findings have rekindled the debate as to whether dietary recommendations should consider optimal levels of nutrients rather than the levels needed to prevent deficiency diseases. As a fat-soluble vitamin, E has the potential for toxicity. However, it does appear to be the least toxic of the fat-soluble vitamins. No instances of toxicity have been reported at doses of 1600 mg day⁻¹ or less.

Vitamin K Is a Quinone Derivative

Vitamin K is found naturally as **K₁** (phytylmenaquinone) in green vegetables and **K₂** (methylmenaliquinone), which is synthesized by intestinal bacteria. The body converts synthetically prepared menaquinone (menadione) and a number of water-soluble analogs to a biologically active form of vitamin K. Dietary requirements are measured in terms of micrograms of vitamin K₁ with the RDA for adults being in the range of 60–80 μ g day⁻¹.

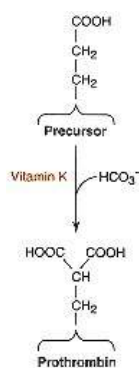

Figure 28.6
Function
of
vitamin K.

Vitamin K₁ is required for the conversion of several **clotting factors** and **prothrombin** to the active state. The mechanism of this action has been most clearly delineated for prothrombin (see p. 970). Prothrombin is synthesized as an inactive precursor called preprothrombin. Conversion to the active form requires a vitamin K-dependent **carboxylation** of specific glutamic acid residues to **γ -carboxyglutamic acid** (Figure 28.6). The γ -carboxyglutamic acid residues are good chelators and allow prothrombin to bind calcium. The prothrombin-Ca²⁺ complex in turn binds to the phospholipid membrane, where

proteolytic conversion to thrombin can occur *in vivo*. The mechanism of the carboxylation reaction has not been fully clarified but appears to involve the intermediate formation of a 2,3-epoxide derivative of vitamin K. **Dicumarol**, a naturally occurring anticoagulant, inhibits the reductase, which converts the epoxide back to the active vitamin.

Recently, vitamin K has been shown to be essential for the synthesis of γ -carboxyglutamic acid residues in the protein **osteocalcin**, which accounts for 15–20% of the noncollagen protein in the bone of most vertebrates. As with prothrombin, the γ -carboxyglutamic acid residues are responsible for most of the calcium-binding properties of osteocalcin. Because osteocalcin synthesis is controlled by vitamin D and osteocalcin is thought to play an important role in bone remodeling, vitamin K may be important for bone formation.

The only readily detectable symptom of **vitamin K deficiency** in humans is increased coagulation time, but some studies have suggested that vitamin K deficiency may be a factor in **osteoporosis** as well. Since vitamin K is synthesized by bacteria in the intestine, deficiencies have long been assumed to be rare. However, recent studies have suggested that intestinally synthesized vitamin K may not be efficiently absorbed and marginal vitamin K deficiencies may be more common than originally thought. The most common deficiency occurs in newborn infants (see Clin. Corr. 28.3), especially those whose mothers have been on anticonvulsant therapy (see Clin. Corr. 28.4). Vitamin K deficiency also occurs in patients with **obstructive jaundice** and other diseases leading to severe **fat malabsorption** (see Clin. Corr. 28.1) and patients on long-term **antibiotic therapy** (which may destroy vitamin K-synthesizing organisms in the intestine). Finally, vitamin K deficiency is sometimes seen in the elderly,

CLINICAL CORRELATION 28.3

Nutritional Considerations in the Newborn

Newborn infants are at special nutritional risk. In the first place, this is a period of very rapid growth, and needs for many nutrients are high. Some micronutrients (such as vitamins E and K) do not cross the placental membrane well and tissue stores are low in the newborn infant. The gastrointestinal tract may not be fully developed, leading to malabsorption problems (particularly with respect to the fat-soluble vitamins). The gastrointestinal tract is also sterile at birth and the intestinal flora that normally provide significant amounts of certain vitamins (especially vitamin K) take several days to become established. If the infant is born prematurely, the nutritional risk is slightly greater, since the gastrointestinal tract will be less well developed and the tissue stores will be less.

The most serious nutritional complications of newborns appear to be hemorrhagic disease. Newborn infants, especially premature infants, have low tissue stores of vitamin K and lack the intestinal flora necessary to synthesize the vitamin. Breast milk is also a relatively poor source of vitamin K. Approximately 1 out of 400 live births shows some signs of hemorrhagic disease. One milligram of the vitamin at birth is usually sufficient to prevent hemorrhagic disease.

Iron is another potential problem. Most newborn infants are born with sufficient reserves of iron to last 3–4 months (although premature infants are born with smaller reserves). Since iron is present in low amounts in both cow's milk and breast milk, iron supplementation is usually begun at a relatively early age by the introduction of iron-fortified cereal. Vitamin D levels are also somewhat low in breast milk and supplementation with vitamin D is usually recommended. However, some recent studies have suggested that iron in breast milk is present in a form that is particularly well utilized by the infant and that earlier studies probably underestimated the amount of vitamin D available in breast milk. Other vitamins and minerals appear to be present in adequate amounts in breast milk as long as the mother is getting a good diet. Recent studies have suggested that in situations in which infants must be maintained on assisted ventilation with high oxygen concentrations, supplemental vitamin E may reduce the risk of bronchopulmonary dysplasia and retrolental fibroplasia, two possible side effects of oxygen therapy. Studies have also suggested that anemia of prematurity may respond to supplemental folate and vitamin B₁₂.

In summary, most infants are provided with supplemental vitamin K at birth to prevent hemorrhagic disease. Breast-fed infants are usually provided with supplemental vitamin D, with iron being introduced along with solid foods. Bottle-fed infants are provided with supplemental iron. If infants must be maintained on oxygen, supplemental vitamin E may be beneficial.

Barnes, L. A. Pediatrics. In: H. Schneider, C. E. Anderson, and D. B. Coursin (Eds.), *Nutritional Support of Medical Practice*, 2nd ed. New York: Harper & Row, 1983, pp. 541–561; Huysman, M. W., and Sauer, P. J. The vitamin K controversy. *Curr. Opin. Pediatr.* 6:129, 1994; Worthington-White, D. A., Behnke, M., and Gross, S. Premature infants require additional folate and vitamin B₁₂ to reduce the severity of anemia of prematurity. *Am. J. Clin. Nutr.* 60:930, 1994; and Mueller, D. P. R. Vitamin E therapy in retinopathy of prematurity. *Eye* 6:221, 1992.

CLINICAL CORRELATION 28.4

Anticonvulsant Drugs and Vitamin Requirements

Anticonvulsant drugs such as phenobarbital or diphenylhydantoin (DPH) present an excellent example of the type of drug–nutrient interactions that are of concern to the physician. Metabolic bone disease appears to be the most significant side effect of prolonged anticonvulsant therapy. Whereas children and adults on these drugs seldom develop rickets or severe osteomalacia, as many as 65% of those on long-term therapy will have abnormally low serum calcium and phosphorus and abnormally high serum alkaline phosphatase. Some bone loss is usually observed in these cases. While the cause of the hypocalcemia and bone loss is thought to be an effect of the anticonvulsant drugs on vitamin D metabolism, not all of the studies have shown decreased levels of 25-(OH) D and 1,25-(OH)₂D in patients on these drugs. However, supplemental vitamin D in the range of 2000–10,000 units per day appears to correct both the hypocalcemia and osteopenia. Anticonvulsants also tend to increase needs for vitamin K, leading to an increased incidence of hemorrhagic disease in infants born to mothers on anticonvulsants. In addition, anticonvulsants appear to increase the need for folic acid and B₆. Low serum folate levels are seen in 75% of patients on anticonvulsants and megaloblastic anemia may occur in as many as 50% without supplementation. By bio-chemical parameters, 30–60% of the children on anticonvulsants exhibit some form of B₆ deficiency. Clinical symptoms of B₆ deficiency are rarely seen, however. From 1 to 5 mg of folic acid and 10 mg of vitamin B₆ appear to be sufficient for most patients on anticonvulsants. Since folates may speed up the metabolism of some anticonvulsants, it is important that excess folic acid not be given.

Moslet, U., and Hansen, E. S. A review of vitamin K, epilepsy and pregnancy. *Acta Neurol. Scand.* 85:39, 1992; Rivery, M. D., and Schottelius, D. D. Phenytoin-folic acid: a review. *Drug Intelligence Clin. Pharm.* 18:292, 1984; and Tjellesen, L. Metabolism and action of vitamin D in epileptic patients on anticonvulsant treatment and healthy adults. *Dan. Med. Bull.* 41:139, 1994.

who are prone to poor liver function (reducing preprothrombin synthesis) and fat malabsorption. Clearly, vitamin K deficiency should be suspected in patients demonstrating easy bruising and prolonged clotting time.

28.5—

Water-Soluble Vitamins

Water-soluble vitamins differ from fat-soluble vitamins in several important aspects. Most are readily excreted once their concentration surpasses the renal threshold. Thus toxicities are rare. Deficiencies of these vitamins occur relatively quickly on an inadequate diet. Their metabolic stores are labile and depletion can often occur in a matter of weeks or months. Since the water-soluble vitamins are coenzymes for many common biochemical reactions, it is often possible to assay vitamin status by measuring one or more enzyme activities in isolated red blood cells. These assays are especially useful if one measures both the endogenous enzyme activity and the stimulated activity following addition of the active coenzyme derived from that vitamin.

Most of the water-soluble vitamins are converted to coenzymes, which are utilized either in the pathways for energy generation or hematopoiesis. Deficiencies of the energy-releasing vitamins produce a number of overlapping symptoms. In many cases the vitamins participate in so many biochemical reactions that it is impossible to pinpoint the exact biochemical cause of any given symptom. However, it is possible to generalize that because of the central role these vitamins play in energy metabolism, deficiencies show up first in rapidly growing tissues. Typical symptoms include **dermatitis**, **glossitis** (swelling and reddening of the tongue), **cheilitis** at the corners of the lips, and **diarrhea**. In many cases nervous tissue is also involved due to its high energy demand or specific effects of the vitamin. Some of the common neurological symptoms include **peripheral neuropathy** (tingling of nerves at the extremities), depression, mental confusion, lack of motor coordination, and **malaise**. In some cases demyelination and degeneration of nervous tissues also occur. These deficiency symptoms are so common and overlapping that they can be

considered as properties of the energy-releasing vitamins as a class, rather than being specific for any one.

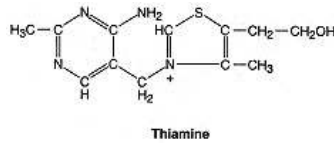

Figure 28.7
Structure of thiamine.

28.6— Energy-Releasing Water-Soluble Vitamins

Thiamine (Vitamin B₁) Forms the Coenzyme Thiamine Pyrophosphate (TPP)

Thiamine (Figure 28.7) is rapidly converted to the coenzyme **thiamine pyrophosphate (TPP)**, which is required for the key reactions catalyzed by pyruvate dehydrogenase complex and α -ketoglutarate dehydrogenase complex (Figure 28.8). Cellular energy generation is severely compromised in thiamine deficiency. TPP is also required for the transketolase reactions of the pentose phosphate pathway. While the pentose phosphate pathway is not quantitatively important in terms of energy generation, it is the sole source of ribose for the synthesis of nucleic acid precursors and the major source of NADPH for fatty acid biosynthesis and other biosynthetic pathways. Red blood cell transketolase is also the enzyme most commonly used for measuring thiamine status in the body. TPP appears to function in transmission of nerve impulses. TPP (or a related metabolite, thiamine triphosphate) is localized in peripheral nerve membranes. It appears to be required for acetylcholine synthesis and may also be required for ion translocation reactions in stimulated neural tissue.

Although the biochemical reactions involving TPP are fairly well characterized, it is not clear how these biochemical lesions result in the symptoms of **thiamine deficiency**. The pyruvate dehydrogenase and transketolase reactions are the most sensitive to thiamine levels. Thiamine deficiency appears to selectively inhibit carbohydrate metabolism, causing an accumulation of pyruvate. Cells may be directly affected by lack of available energy and NADPH or

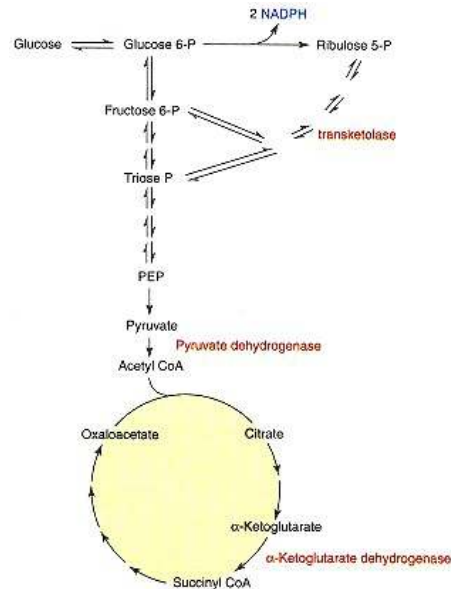

Figure 28.8
Summary of important reactions involving thiamine pyrophosphate.

The reactions involving thiamine pyrophosphate are indicated in red.

may be poisoned by the accumulated pyruvate. Other symptoms of thiamine deficiency involve the neural tissue and probably result from the direct role of TTP in nerve transmission.

Loss of appetite, constipation, and nausea are among the earliest symptoms of **thiamine deficiency**. Mental depression, peripheral neuropathy, irritability, and fatigue are other early symptoms and probably directly relate to the role of thiamine in maintaining healthy nervous tissue. These symptoms of thiamine deficiency are most often seen in the elderly and low-income groups on restricted diets. Symptoms of moderately severe thiamine deficiency include **mental confusion**, **ataxia** (unsteady gait while walking and general inability to achieve fine control of motor functions), and **ophthalmoplegia** (loss of eye coordination). This set of symptoms is usually referred to as **Wernicke–Korsakoff syndrome** and is most commonly seen in chronic **alcoholics** (see Clin. Corr. 28.5). Severe thiamine deficiency is known as **beriberi**. Dry beriberi is characterized primarily by advanced neuromuscular symptoms, including atrophy and weakness of the muscles. When these symptoms are coupled with edema, the disease is referred to as wet beriberi. Both forms of beriberi can be associated with an unusual type of heart failure characterized by high cardiac output. Beriberi is found primarily in populations relying exclusively on polished rice for food, although cardiac failure is sometimes seen in alcoholics as well.

The thiamine requirement is proportional to caloric content of the diet and is in the range of 1.0–1.5 mg per day for the normal adult. This requirement should be raised somewhat if carbohydrate intake is excessive or if the metabolic rate is elevated (due to fever, trauma, pregnancy, or lactation). Coffee and tea

CLINICAL CORRELATION 28.5

Nutritional Considerations in the Alcoholic

Chronic alcoholics run considerable risk of nutritional deficiencies. The most common problems are neurologic symptoms associated with thiamine or pyridoxine deficiencies and hematological problems associated with folate or pyridoxine deficiencies. The deficiencies seen with alcoholics are not necessarily due to poor diet alone, although it is often a strong contributing factor. Alcohol causes pathological alterations of the gastrointestinal tract that often directly interfere with absorption of certain nutrients. The liver is the most important site of activation and storage of many vitamins. The severe liver damage associated with chronic alcoholism appears to interfere directly with storage and activation of certain nutrients.

Up to 40% of hospitalized alcoholics are estimated to have megaloblastic erythropoiesis due to folate deficiency. Alcohol appears to interfere directly with folate absorption and alcoholic cirrhosis impairs storage of this nutrient. Another 30% of hospitalized alcoholics have sideroblastic anemia or identifiable sideroblasts in erythroid marrow cells characteristic of pyridoxine deficiency. Some alcoholics also develop a peripheral neuropathy that responds to pyridoxine supplementation. This problem appears to result from impaired activation and increased degradation of pyridoxine. In particular, acetaldehyde (an end product of alcohol metabolism) displaces pyridoxal phosphate from its carrier protein in the plasma. The free pyridoxal phosphate is then rapidly degraded to inactive compounds and excreted.

The most dramatic nutritionally related neurological disorder is Wernicke–Korsakoff syndrome. The symptoms include mental disturbances, ataxia (unsteady gait and lack of fine motor coordination), and uncoordinated eye movements. Congestive heart failure similar to that seen with beriberi is also seen in a small number of these patients. While this syndrome may only account for 1–3% of alcohol-related neurologic disorders, the response to supplemental thiamine is so dramatic that it is usually worth consideration. The thiamine deficiency appears to arise primarily from impaired absorption, although alcoholic cirrhosis may also affect the storage of thiamine in the liver.

While those are the most common nutritional deficiencies associated with alcoholism, deficiencies of almost any of the water-soluble vitamins can occur and cases of alcoholic scurvy and pellagra are occasionally reported. Chronic ethanol consumption causes an interesting redistribution of vitamin A stores in the body. Vitamin A stores in the liver are rapidly depleted while levels of vitamin A in the serum and other tissues may be normal or slightly elevated. Apparently, ethanol causes both increased mobilization of vitamin A from the liver and increased catabolism of liver vitamin A to inactive metabolites by the hepatic P450 system. Alcoholic patients have decreased bone density and an increased incidence of osteoporosis. This probably relates to a defect in the 25-hydroxylation step in the liver as well as an increased rate of metabolism of vitamin D to inactive products by an activated cytochrome P450 system. Dietary calcium intake is also often poor. In fact, alcoholics generally have decreased serum levels of zinc, calcium, and magnesium due to poor dietary intake and increased urinary losses. Iron-deficiency anemia is very rare unless there is gastrointestinal bleeding or chronic infection. In fact, excess iron is a more common problem with alcoholics. Many alcoholic beverages contain relatively high iron levels, and alcohol appears to enhance iron absorption.

Hayumpa, A. M. Mechanisms of vitamin deficiencies in alcoholism. *Alcohol. Clin. Exp. Res.* 10:573, 1986; and Lieber, C. S. Alcohol, liver and nutrition. *J. Am. Coll Nutr.* 10:602, 1991.

contain substances that destroy thiamine, but this is not a problem for individuals consuming normal amounts of these beverages. Routine enrichment of cereals has assured that most Americans have an adequate intake of thiamine on a normal mixed diet.

Riboflavin Is Part of FAD and FMN

Riboflavin is the precursor of the coenzymes flavin adenine dinucleotide (FAD) and flavin mononucleotide (FMN), both of which are involved in a wide variety of redox reactions. The flavin coenzymes are essential for energy production and cellular respiration. The most characteristic symptoms of **riboflavin deficiency** are angular cheilitis, glossitis, and scaly dermatitis (especially around the nasolabial folds and scrotal areas). The best flavin-requiring enzyme for assaying riboflavin status appears to be erythrocyte glutathione reductase. The recommended riboflavin intake is 1.2–1.7 mg day⁻¹ for the normal adult. Foods rich in riboflavin include milk, meat, eggs, and cereal products. Riboflavin deficiencies are quite rare in this country. When riboflavin deficiency does occur, it is usually seen in chronic **alcoholics**. Hypothyroidism has recently been shown to slow the conversion of riboflavin to FMN and FAD. It is not known whether this affects riboflavin requirements, however.

Niacin Is Part of NAD and NADP

Niacin is not a vitamin in the strictest sense of the word, since some niacin can be synthesized from tryptophan. However, conversion of tryptophan to niacin is relatively inefficient (60 mg of tryptophan is required for the production of 1 mg of niacin) and occurs only after all of the body requirements for tryptophan (protein synthesis and energy production) have been met. Since synthesis of niacin requires thiamine, pyridoxine, and riboflavin, it is also very inefficient on a marginal diet. Thus most people require dietary sources of both tryptophan and niacin. Niacin (nicotinic acid) and niacinamide (nicotinamide) are both converted to the ubiquitous oxidation–reduction coenzymes NAD⁺ and NADP⁺ in the body.

Borderline **niacin deficiencies** are first seen as a glossitis (redness) of the tongue, somewhat similar to riboflavin deficiency. Pronounced deficiencies lead to **pellagra**, which is characterized by the three Ds: dermatitis, diarrhea, and dementia. The dermatitis is characteristic in that it is usually seen only in skin areas exposed to sunlight and is symmetric. The neurologic symptoms are associated with actual degeneration of nervous tissue. Because of food fortification, pellagra is a medical curiosity in the developed world. Today it is primarily seen in **alcoholics**, patients with severe **malabsorption** problems, and **elderly** on very restricted diets. Pregnancy, lactation, and chronic illness lead to increased needs for niacin, but a varied diet will usually provide sufficient amounts.

Since tryptophan can be converted to niacin, and niacin can exist in a free or bound form, the calculation of available niacin for any given food is not a simple matter. For this reason, niacin requirements are expressed in terms of niacin equivalents (1 niacin equiv = 1 mg free niacin). The current recommendation of the Food and Nutrition Board for a normal adult is 13–19 niacin equivalents (NE) per day. The richest food sources of niacin are meats, peanuts and other legumes, and enriched cereals.

Pyridoxine (Vitamin B₆) Forms the Coenzyme Pyridoxal Phosphate

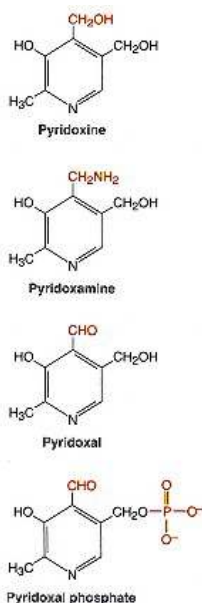

Figure 28.9
Structures of vitamin B₆.

Pyridoxine, pyridoxamine, and pyridoxal are all naturally occurring forms of vitamin B₆ (Figure 28.9). All three forms are efficiently converted by the body to **pyridoxal phosphate**, which is required for the synthesis, catabolism, and interconversion of amino acids. The role of pyridoxal phosphate in amino

acid metabolism has been discussed previously (see p. 449). While pyridoxal phosphate-dependent reactions are legion, there are a few instances in which the biochemical lesion seems to be directly associated with the symptoms of **B₆ deficiency** (Figure 28.10). Pyridoxal phosphate is essential for energy production from amino acids and can be considered an energy-releasing vitamin. Thus some of the symptoms of severe B₆ deficiency are similar to those of the other energy-releasing vitamins. Pyridoxal phosphate is also required for the synthesis of the neurotransmitters **serotonin** and **norepinephrine** and for synthesis of the sphingolipids necessary for myelin formation. These effects are thought to explain the irritability, nervousness, and depression seen with mild deficiencies and the peripheral neuropathy and convulsions observed with severe deficiencies. Pyridoxal phosphate is required for the synthesis of α -aminolevulinic acid, a precursor of heme. B₆ deficiencies occasionally cause **sideroblastic anemia**, which is characteristically a microcytic anemia seen in the presence of high serum iron. Pyridoxal phosphate is also an essential component of glycogen phosphorylase; it is covalently linked to a lysine residue and stabilizes the enzyme. This role of B₆ may explain the decreased glucose tolerance associated with deficiency, although B₆ appears to have some direct effects on the glucocorticoid receptor as well. Vitamin B₆ is also required for the conversion of homocysteine to cysteine, and **hyperhomocysteinemia** appears to be a risk factor for cardiovascular disease. Finally, pyridoxal phosphate is one of the cofactors required for the conversion of tryptophan to NAD. While this may not be directly related to the symptomatology of B₆ deficiency, a tryptophan load test is a sensitive indicator of vitamin B₆ status (see Clin. Corr. 28.6, p. 1124).

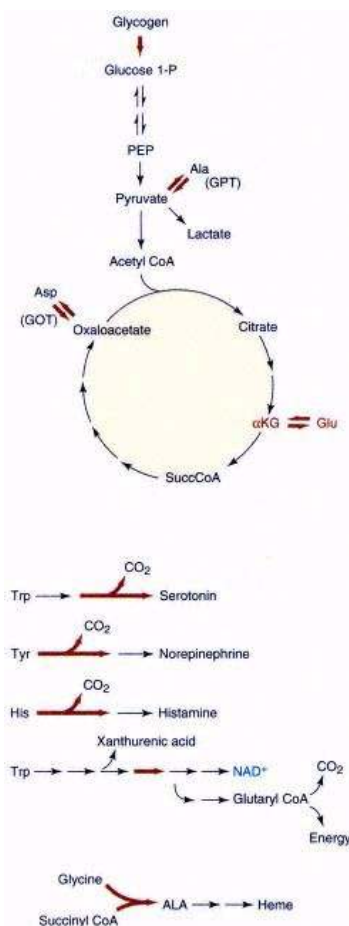

Figure 28.10
Important metabolic roles of pyridoxal phosphate.
 Reactions requiring pyridoxal phosphate are indicated with red arrows. ALA, α -aminolevulinic acid; α KG, α -ketoglutarate; GPT, glutamate pyruvate aminotransferase; and GOT, glutamate oxaloacetate aminotransferase.

The requirement for B₆ in the diet is roughly proportional to the protein content of the diet. Assuming that the average American consumes close to 100 g of protein per day, the RDA for vitamin B₆ has been set at 1.4–2.0 mg day⁻¹ for a normal adult. This requirement is increased during pregnancy and lactation and may increase somewhat with age as well. Vitamin B₆ is fairly widespread in foods, but meat, vegetables, whole-grain cereals, and egg yolks are among the richest sources.

Evaluation of B₆ nutritional status has become a controversial topic in recent years. Some of this controversy is discussed in Clin. Corr. 28.6. It has usually been assumed that the average American diet is adequate in B₆ and it is not routinely added to flour and other fortified foods. However, recent nutritional surveys have cast doubt on this assumption. A significant fraction of the survey population was found to consume less than two-thirds of the RDA for B₆.

Pantothenic Acid and Biotin Are Also Energy-Releasing Vitamins

Pantothenic acid is a component of coenzyme A (CoA) and the phosphopantetheine moiety of fatty acid synthase and thus is required for the metabolism of all fat, protein, and carbohydrate via the citric acid cycle. More than 70 enzymes have been described to date that utilize CoA or its derivatives. In view of the importance of these reactions, one would expect pantothenic acid deficiencies to be a serious concern in humans. This does not appear to be the case for two reasons: (1) pantothenic acid is very widespread in natural foods, probably reflecting its widespread metabolic role, and (2) most symptoms of pantothenic acid deficiency are vague and mimic those of other B vitamin deficiencies.

Biotin is the prosthetic group for a number of carboxylation reactions, the most notable being pyruvate carboxylase (needed for synthesis of oxaloacetate for gluconeogenesis and replenishment of the citric acid cycle), acetyl-CoA carboxylase (fatty acid biosynthesis), and propionyl-CoA carboxylase (methionine, leucine, and valine metabolism). Biotin is found in peanuts, chocolate, and eggs and is synthesized by intestinal bacteria.

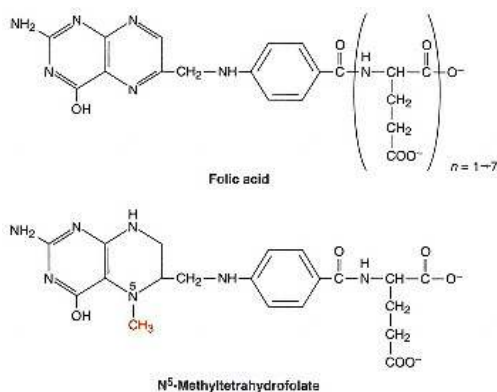

Figure 28.11

Structure of folic acid and N⁵-methyltetrahydrofolate.

28.7—

Hematopoietic Water-Soluble Vitamins**Folic Acid (Folacin) Functions As Tetrahydrofolate in One-Carbon Metabolism**

The simplest form of **folic acid** is pteroylmonoglutamic acid. However, folic acid usually occurs as polyglutamate derivatives with from 2 to 7 glutamic acid residues (Figure 28.11). These compounds are taken up by intestinal mucosal cells and the extra glutamate residues are removed by **conjugase**, a lysosomal enzyme. The free folic acid is then reduced to **tetrahydrofolate** by the enzyme dihydrofolate reductase and circulated in the plasma primarily as the free N⁵-methyl derivative of tetrahydrofolate (Figure 28.11). Inside cells, tetrahydrofolates are found primarily as polyglutamate derivatives, and these appear to be the biologically most potent forms. Folic acid is also stored as a polyglutamate derivative of tetrahydrofolate in the liver.

Various one-carbon tetrahydrofolate derivatives are used in biosynthetic reactions (Figure 28.12). They are required, for example, in the synthesis of choline, serine, glycine, purines, and dTMP. Since adequate amounts of choline and the amino acids can usually be obtained from the diet, the participation of folates in purine and dTMP synthesis appears to be metabolically the most

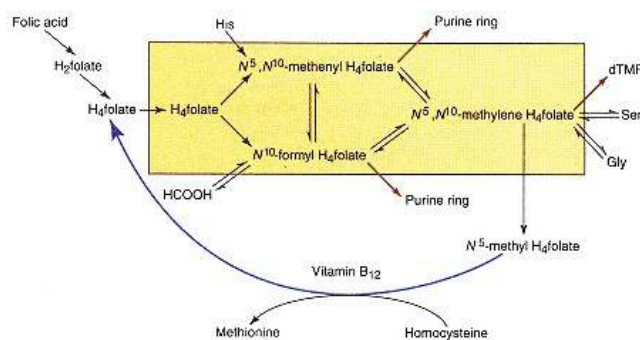

Figure 28.12

Metabolic roles of folic acid and vitamin B₁₂ in one-carbon metabolism.

The metabolic interconversions of folic acid and its derivatives are indicated with black arrows. Pathways relying exclusively on folate are shown with red arrows. The important B₁₂-dependent reaction converting N⁵-methyl H₄folate back to H₄folate is shown with a blue arrow. The box encloses the "pool" of C₁ derivatives of H₄folate.

CLINICAL CORRELATION 28.6

Vitamin B₆ Requirements for Users of Oral Contraceptives

The controversy over B₆ requirements for users of oral contraceptives best illustrates the potential problems associated with biochemical assays. For years, one of the most common assays for vitamin B₆ status had been the tryptophan load assay. This assay is based on the observation that when tissue pyridoxal phosphate levels are low, the normal catabolism of tryptophan is impaired and most of the tryptophan is catabolized by a minor pathway leading to synthesis of xanthurenic acid. Under many conditions, the amount of xanthurenic acid recovered in a 24-h urine sample following ingestion of a fixed amount of tryptophan is a valid indicator of vitamin B₆ status. When the tryptophan load test was used to assess the vitamin B₆ status of oral contraceptive users, however, alarming reports started appearing in the literature. Not only did oral contraceptive use increase the excretion of xanthurenic acid considerably but the amount of pyridoxine needed to return xanthurenic acid excretion to normal was 10 times the RDA and almost 20 times the level required to maintain normal B₆ status in control groups. As might be expected, this observation received much popular attention in spite of the fact that most classical symptoms of vitamin B₆ deficiency were not observed in oral contraceptive users.

More recent studies using other measures of vitamin B₆ have painted a slightly different picture. For example, erythrocyte glutamate pyruvate aminotransferase and erythrocyte glutamate oxaloacetate aminotransferase are both pyridoxal phosphate-containing enzymes. One can also assess vitamin B₆ status by measuring the endogenous activity of these enzymes and the degree of stimulation by added pyridoxal phosphate. These types of assays show a much smaller difference between nonusers and users of oral contraceptives. The minimum level of pyridoxine needed to maintain normal vitamin B₆ status as measured by these assays was only 2.0 mg day⁻¹, which is slightly greater than the RDA and about twice that needed by nonusers.

Why the large discrepancy? For one thing, it must be kept in mind that enzyme activity can be affected by hormones as well as vitamin cofactors. Kynureninase is the key pyridoxal phosphate-containing enzyme of the tryptophan catabolic pathway. The activity of kynureninase is regulated both by pyridoxal phosphate availability and by estrogen metabolites. Even with normal vitamin B₆ status most of the enzyme exists in the inactive apoenzyme form. However, this does not affect tryptophan metabolism because tryptophan oxygenase, the first enzyme of the pathway, is rate limiting. Thus the small amount of active holoenzyme is more than sufficient to handle the metabolites produced by the first part of the pathway. However, kynureninase is inhibited by estrogen metabolites. Thus with oral contraceptive use its activity is reduced to a level where it becomes rate limiting and excess tryptophan metabolites are shunted to xanthurenic acid. Higher than normal levels of vitamin B₆ overcome this problem by converting more apoenzyme to holoenzyme, thus increasing the total amount of enzyme. Since the estrogen was having a specific effect on the enzyme used to measure vitamin B₆ status in this assay, it did not necessarily mean that pyridoxine requirements were altered for other metabolic processes in the body.

Does this mean that vitamin B₆ status is of no concern to users of oral contraceptives? Oral contraceptives do appear to increase vitamin B₆ requirements slightly. Several dietary surveys have shown that a significant percentage of women in the 18-24-year age group consume diets containing less than 1.3 mg of pyridoxine per day. If these women are also using oral contraceptives, they are at some increased risk for developing a borderline deficiency. Thus, while the tryptophan load test was clearly misleading in a quantitative sense, it did alert the medical community to a previously unsuspected nutritional risk.

Bender, D. A. Oestrogens and vitamin B₆—actions and interactions. *World Rev. Nutr. Diet.* 51:140, 1987; and Kirksey, A., Keaton, K., Abernathy, R. P., and Grager, J. L. Vitamin B₆ nutritional status of a group of female adolescents. *Am. J. Clin. Nutr.* 31:946, 1978.

significant of those reactions. In addition, tetrahydrofolate and vitamin B₁₂ are required, along with vitamin B₆, for the conversion of homocysteine to methionine. As mentioned earlier, this may also be significant because **hyperhomocysteinemia** appears to be a risk factor for cardiovascular disease. Methionine, of course, is also converted to *S*-adenosylmethionine, which is used in many methylation reactions.

The most pronounced effect of **folate deficiency** is inhibition of DNA synthesis due to decreased availability of purines and dTMP. This leads to arrest of cells in S phase and a characteristic "megaloblastic" change in size and shape of nuclei of rapidly dividing cells. The block in DNA synthesis slows down maturation of red blood cells, causing production of abnormally large "macrocytic" red blood cells with fragile membranes. Thus a **macrocytic anemia** associated with megaloblastic changes in the bone marrow is characteristic of folate deficiency. In addition, **hyperhomocysteinemia** is fairly common in the elderly population and appears to be due to inadequate intake and/or decreased utilization of folate, vitamin B₆, and vitamin B₁₂. Elevated homocysteine levels usually respond to supplementation with RDA levels of those vitamins.

There are many causes of **folate deficiency**, including inadequate intake, impaired absorption, increased demand, and impaired metabolism. Some dietary surveys have suggested that inadequate intake may be more common than previously supposed. However, as with most other vitamins, inadequate intake is probably not sufficient to trigger symptoms of folate deficiency in the absence of increased requirements or decreased utilization. Perhaps the most common example of increased need occurs during **pregnancy and lactation**. As the blood volume and the number of rapidly dividing cells in the body increase, the need for folic acid increases. By the third trimester the folic acid requirement has almost doubled. In the United States almost 20–25% of otherwise normal pregnancies are associated with low serum folate levels, but actual megaloblastic anemia is rare and is usually seen only after multiple pregnancies. However, recent studies have shown that inadequate folate levels during the early stages of pregnancy increase the risk for **neural tube defects**, a type of birth defect. Normal diets seldom supply the 400 μg of folate needed during pregnancy, so most physicians routinely recommend supplementation for women during the child-bearing years. Folate deficiency is common in **alcoholics** (see Clin. Corr. 28.5). Folate deficiencies are also seen in a number of malabsorption diseases and are occasionally seen in the elderly, due to a combination of poor dietary habits and poor absorption.

There are a number of drugs that also directly interfere with folate metabolism. **Anticonvulsants** and **oral contraceptives** may interfere with folate absorption and anticonvulsants appear to increase catabolism of folates (see Clin. Corr. 28.4). Oral contraceptives and estrogens also appear to interfere with folate metabolism in their target tissue. Long-term use of any of these drugs can lead to folate deficiencies unless adequate supplementation is provided. For example, 20% of patients using oral contraceptives develop megaloblastic changes in the cervicovaginal epithelium, and 20–30% show low serum folate levels.

Vitamin B₁₂ (Cobalamine) Contains Cobalt in a Tetrapyrrole Ring

Pernicious anemia, a megaloblastic anemia associated with neurological deterioration, was invariably fatal until 1926 when liver extracts were shown to be curative. Subsequent work showed the need for both an **extrinsic factor** present in liver and an **intrinsic factor** produced by the body: **vitamin B₁₂** was the extrinsic factor. Chemically, vitamin B₁₂ consists of **cobalt** in a coordination state of six—coordinated in four positions by a tetrapyrrole (or corrin) ring, in one position by a benzimidazole nitrogen, and in the sixth position by one of several different ligands (Figure 28.13). The crystalline forms of B₁₂ used in supplementation are usually hydroxycobalamine or cyanocobalamine. In foods B₁₂ usually occurs bound to protein in the methyl or 5'-deoxyadenosyl forms. To be utilized the B₁₂ must first be removed from the protein by acid hydrolysis in the stomach or trypsin digestion in the intestine. It then must combine with **intrinsic factor**, a protein secreted by the stomach, which carries it to the ileum for absorption.

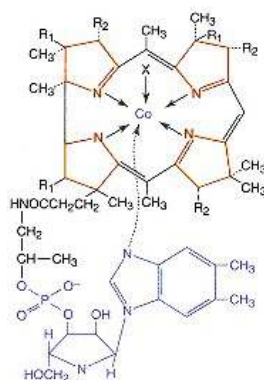

Figure 28.13
Structure of vitamin B₁₂ (cobalamine).

In humans there are two major symptoms of B₁₂ deficiency (hematopoietic and neurological), and only two biochemical reactions in which B₁₂ is known to participate (Figure 28.14). Thus it is very tempting to speculate on exact cause and effect mechanisms. The methyl derivative of B₁₂ is required for conversion of homocysteine to methionine and the 5'-deoxyadenosyl derivative is required for the methylmalonyl-CoA mutase reaction (methylmalonyl CoA \rightarrow succinyl CoA), which is a key step in the catabolism of some branched-chain amino acids. The neurologic disorders seen in B₁₂ deficiency are due to progressive demyelination of nervous tissue. It has been proposed that the

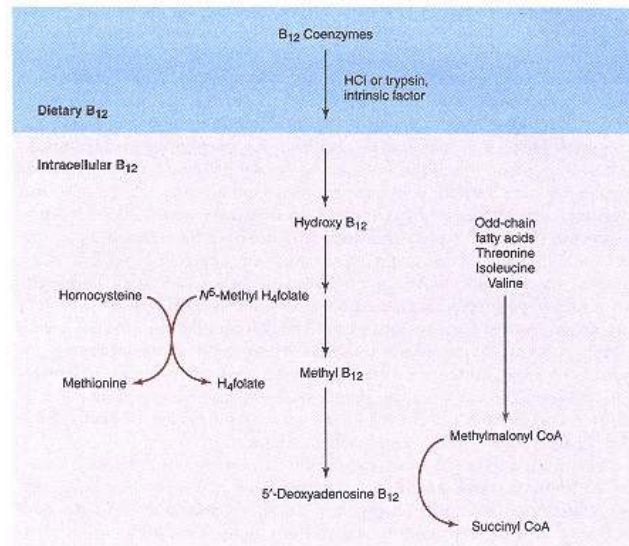

Figure 28.14

Metabolism of vitamin B₁₂.

Metabolic interconversions of B₁₂ are indicated with light arrows, and B₁₂-requiring reactions are indicated with red arrows. Other related pathways are indicated with a blue arrow.

methylmalonyl CoA that accumulates interferes with myelin sheath formation in two ways.

1. Methylmalonyl CoA is a competitive inhibitor of malonyl CoA in fatty acid biosynthesis. Since the myelin sheath is continually turning over, any severe inhibition of fatty acid biosynthesis will lead to its eventual degeneration.
2. In the residual fatty acid synthesis, methylmalonyl CoA can substitute for malonyl CoA in the reaction sequence, leading to branched-chain fatty acids, which might disrupt normal membrane structure. There is some evidence supporting both mechanisms.

Megaloblastic anemia associated with B₁₂ deficiency is thought to reflect the effect of B₁₂ on folate metabolism. The B₁₂-dependent homocysteine to methionine conversion (homocysteine + N⁵-methyl THF → methionine + THF) appears to be the only major pathway by which N⁵-methyltetrahydrofolate can return to the tetrahydrofolate pool (Figure 28.14). Thus in B₁₂ deficiency there is a buildup of N⁵-methyltetrahydrofolate and a deficiency of the tetrahydrofolate derivatives needed for purine and dTMP biosynthesis. Essentially all of the folate becomes "trapped" as the N⁵-methyl derivative. Vitamin B₁₂ also may be required for uptake of folate by cells and for its conversion to the biologically more active polyglutamate forms. High levels of supplemental folate can overcome the megaloblastic anemia associated with B₁₂ deficiencies but not the neurological problems. Hence caution must be taken in using folate to treat megaloblastic anemia.

Vitamin B₁₂ is widespread in foods of animal origin, especially meats. Liver stores up to a 6-year supply of vitamin B₁₂. Thus **deficiencies** of B₁₂ are extremely rare. They are occasionally seen in older people due to insufficient production of intrinsic factor and/or HCl in the stomach. B₁₂ deficiency can also be seen in patients with severe malabsorption diseases and in long-term **vegetarians**.

28.8—

Other Water-Soluble Vitamins*Ascorbic Acid Functions in Reduction and Hydroxylation Reactions*

Vitamin C or ascorbic acid is a six-carbon compound closely related to glucose. Its main biological role is as a reducing agent in several important hydroxylation reactions in the body. Ascorbic acid is required for the hydroxylation of lysine and proline in procollagen. Without this hydroxylation procollagen cannot properly cross-link into normal collagen fibrils. Thus vitamin C is obviously important for maintenance of normal connective tissue and for wound healing, since the connective tissue is laid down first. Vitamin C is also necessary for bone formation, since bone tissue has an organic matrix containing collagen as well as the inorganic, calcified portion. Finally, collagen appears to be a component of the ground substance surrounding capillary walls, so vitamin C deficiency is associated with **capillary fragility**.

Since vitamin C is concentrated in the adrenal gland, especially in periods of stress, it may be required for hydroxylation reactions in synthesis of some corticosteroids. Ascorbic acid has other important properties as a reducing agent, which appear to be nonenzymatic. For example, it aids in **absorption of iron** by reducing it to the ferrous state in the stomach. It spares vitamin A, vitamin E, and some B vitamins by protecting them from oxidation. Also, it enhances the utilization of folic acid, either by aiding the conversion of folate to tetrahydrofolate or the formation of polyglutamate derivatives of tetrahydrofolate. Finally, vitamin C appears to be a biologically important antioxidant. The National Research Council has recently concluded that adequate amounts (RDA levels) of antioxidants such as β -carotene and vitamin C in the diet reduce the risk of **cancer**. The data for other naturally occurring antioxidants such as vitamin E and selenium are not yet conclusive.

Most of the symptoms of **vitamin C deficiency** can be directly related to its metabolic roles. Symptoms of mild vitamin C deficiency include easy bruising and formation of petechiae (small, pinpoint hemorrhages in skin) due to increased capillary fragility and decreased immunocompetence. **Scurvy** is associated with decreased wound healing, osteoporosis, hemorrhaging, and anemia. Osteoporosis results from the inability to maintain the collagenous organic matrix of the bone, followed by demineralization. Anemia results from extensive hemorrhaging coupled with defects in iron absorption and folate metabolism.

Since vitamin C is readily absorbed, deficiencies almost invariably result from poor diet and/or increased need. There is uncertainty over the need for vitamin C in periods of stress. In severe stress or trauma there is a rapid drop in serum vitamin C levels. In these situations most of the body's supply of vitamin C is mobilized to the adrenals and/or the area of the wound. Does this represent an increased demand for vitamin C, or merely a normal redistribution to those areas where it is needed most? Do the lowered serum levels of vitamin C impair its functions in other tissues in the body? The current consensus seems to be that the lowered serum vitamin C levels indicate an increased demand, but there is little agreement as to how much.

Smoking causes lower serum levels of vitamin C. In fact, the 1989 RDAs recommend that smokers consume 100 mg of vitamin C per day instead of the 60 mg day⁻¹ needed by nonsmoking adults. **Aspirin** appears to block uptake of vitamin C by white blood cells. **Oral contraceptives** and **corticosteroids** also lower serum levels of vitamin C. While there is no universal agreement as to the seriousness of these effects, the possibility of marginal vitamin C deficiencies should be considered with any patient using these drugs over a long period of time, especially if dietary intake is less than optimal.

The most controversial question surrounding vitamin C is its use in megadoses to prevent and cure the **common cold**. Ever since this use of vitamin C was first popularized by Linus Pauling in 1970, the issue has generated

considerable controversy. However, some double-blind studies have suggested that while vitamin C supplementation does not appear to be useful in preventing the common cold, it may moderate its symptoms. The mechanism by which vitamin C ameliorates the symptoms of the common cold is not known. It has been suggested that vitamin C is required for normal leukocyte function or for synthesis and release of histamine during stress situations.

While **megadoses of vitamin C** are probably no more harmful than the widely used over-the-counter cold medications, some potential side effects of high vitamin C intake should be considered. For example, oxalate is a major metabolite of ascorbic acid. Thus high ascorbate intakes could theoretically lead to the formation of oxalate kidney stones in predisposed individuals. However, most studies have shown that excess vitamin C is primarily excreted as ascorbate rather than oxalate. Pregnant mothers taking megadoses of vitamin C may give birth to infants with abnormally high vitamin C requirements. Earlier suggestions that megadoses of vitamin C interfered with B₁₂ metabolism have proved to be incorrect.

28.9—

Macrominerals

Calcium Has Many Physiological Roles

Calcium is the most abundant mineral in the body. Most is in bone, but the small amount of calcium outside of bone functions in a number of essential processes. It is required for many enzymes, mediates some hormonal responses, and is essential for **blood coagulation**. It is also essential for muscle contractility and normal neuromuscular irritability. In fact, only a relatively narrow range of serum calcium levels is compatible with life. Since maintenance of constant serum calcium levels is so vital, an elaborate homeostatic control system has evolved (see pp. 862 and 1112). Low serum calcium stimulates formation of 1,25-dihydroxycholecalciferol, which enhances calcium absorption. If dietary calcium intake is insufficient to maintain serum calcium, 1,25-dihydroxycholecalciferol and parathyroid hormone stimulate bone resorption. Long-term dietary calcium insufficiency, therefore, almost always results in net loss of calcium from the bones.

Dietary **calcium requirements**, however, vary considerably from individual to individual due to the existence of other factors that affect availability of calcium. For example, vitamin D is required for optimal utilization of calcium. Excess dietary protein may upset calcium balance by causing more rapid excretion of calcium. Exercise increases the efficiency of calcium utilization for bone formation. Calcium balance studies carried out on Peruvian Indians, who have extensive exposure to sunlight, get extensive exercise, and subsist on low-protein vegetarian diets, indicate a need for only 300–400 mg calcium day⁻¹. However, calcium balance studies carried out in this country consistently show higher requirements and the RDA has been set at 800–1200 mg day²⁺.

The chief symptoms of **calcium deficiency** are similar to those of vitamin D deficiency, but other symptoms such as muscle cramps are possible with marginal deficiencies. A significant portion of low-income children and adult females in this country do not have adequate calcium intake. This is of particular concern because these are the population groups with particularly high needs for calcium. For this reason, the U.S. Congress has established the WIC (Women and Infant Children) program to assure adequate protein, calcium, and iron for indigent families with pregnant/lactating mothers or young infants.

Dietary surveys show that 34–47% of the over-60 population consumes less than one-half the RDA for calcium. This is the group most at risk of developing **osteoporosis**, characterized by loss of bone organic matrix as well as progressive demineralization. Causes of osteoporosis are multifactorial and

largely unknown, but it appears likely that part of the problem has to do with calcium metabolism (see Clin. Corr. 28.7). Recent studies have also suggested that inadequate intake of calcium may result in elevated blood pressure. Although this hypothesis has not been conclusively demonstrated, it is of great concern because most low-sodium diets (which are recommended for patients with high blood pressure) severely limit dairy products, the main source of calcium for Americans.

Magnesium Is Another Important Macromineral

Magnesium is required for many enzyme activities and for neuromuscular transmission. Deficiency is most often observed in conditions of alcoholism, use of certain diuretics, and metabolic acidosis. The main symptoms of magnesium deficiency are weakness, tremors, and cardiac arrhythmia. There is some evidence that supplemental magnesium may help prevent the formation of calcium oxalate stones in the kidney.

CLINICAL CORRELATION 28.7

Diet and Osteoporosis

The controversies raging over the relationships between calcium intake and osteoporosis illustrate the difficulties we face in making simple dietary recommendations for complex biological problems. Based on the TV ads and wide variety of calcium-fortified foods on the market, it would be easy to assume that all an older woman needs to prevent osteoporosis is a diet rich in calcium. However, that may be like closing the barn door after the horse has left. There is strong consensus that the years from age 10 to 35, when the bone density is reaching its maximum, are the most important for reducing the risk of osteoporosis. The maximum bone density obtained during these years is clearly dependent on both calcium intake and exercise and dense bones are less likely to become seriously depleted of calcium following menopause. Unfortunately, most American women are consuming far too little calcium during these years. The RDA for calcium is 1200 mg day⁻¹ (4 glasses of milk per day) for women from age 11 to 24 and 800 mg day⁻¹ (2 glasses of milk per day) for women over 24. The median calcium intake for women in this age range is only about 500 mg day⁻¹. Thus it is clear that increased calcium intake should be encouraged in this group.

But what about postmenopausal women? After all, many of the advertisements seem to be targeted at this group. Do they really need more calcium? The 1994 NIH consensus panel on osteoporosis recommended that postmenopausal women consume up to 1500 mg of calcium per day, but this recommendation has been vigorously disputed by other experts in the field. Let's examine the evidence. Calcium balance studies have shown that many postmenopausal women need 1200–1500 mg of calcium per day to maintain a positive calcium balance (more calcium coming in than is lost in the urine), but that does not necessarily mean that the additional calcium will be stored in their bones. In fact, some recent studies have failed to find a correlation between calcium intake and loss of bone density in postmenopausal women while others have reported a protective effect. All of those studies have been complicated by the discovery that calcium intake may have different effects on different types of bones. Calcium intakes in the range of 1000–1500 mg day⁻¹ appear to slow the decrease in density of cortical bone, such as that found in the hip, hand, and some parts of the forearm. Similar doses, however, appear to have little or no effect on loss of density from the trabecular bone found in the spine, wrist, and other parts of the forearm. At least some of the confusion in the earlier studies appears to have resulted from differences in the site used for measurement of bone density. Thus the effect of high calcium intakes alone on slowing bone loss in postmenopausal women remains controversial at present. It is clear that elderly women should be getting at least the RDA for calcium in their diet. With the recent concern about the fat content of dairy products, calcium intakes in this group appear to be decreasing rather than increasing. Furthermore, even with estrogen replacement therapy, calcium intake should not be ignored. Recent studies have shown that with calcium intakes in the range of 1000–1500 mg day⁻¹, the effective dose of estrogen can be reduced significantly.

While the advertisements and much of the popular literature focus on calcium intake, we also need to remember that bones are not made of calcium alone. If the diet is deficient in other nutrients, the utilization of calcium for bone formation will be impaired. Vitamin C is needed to form the bone matrix and the macrominerals magnesium and phosphorus are an important part of bone structure. Recent research has also shown that vitamin K and a variety of trace minerals, including copper, zinc, manganese, and boron, are important for bone formation. Thus calcium supplements may not be optimally utilized if the overall diet is inadequate. Vitamin D is important for absorption and utilization of calcium. It deserves special mention since it may be a particular problem for the elderly (see Clin. Corr. 28.9). Finally, an adequate exercise program is just as important as estrogen replacement therapy and an adequate diet for preventing the loss of bone density.

Schaafsma, G., Van Berensteyn, E. C. H., Raymakers, J. A., and Dursma, S.A. Nutritional aspects of osteoporosis. *World Rev. Nutr. Diet.* 49:121, 1987; Heaney, R. P. Calcium in the prevention and treatment of osteoporosis. *J. Intern. Med.* 231:169, 1992; and National Institutes of Health. Optimal calcium intake. *NIH Consens. Statement*, 12 (Nov. 4), 1994.

28.10— Trace Minerals

Iron Is Efficiently Reutilized

Iron metabolism is unique in that it operates largely as a closed system, with iron stores being efficiently reutilized by the body. Iron losses are minimal ($<1 \text{ mg day}^{-1}$), but iron absorption is also minimal under the best of conditions. Iron usually occurs in foods in the ferric form bound to protein or organic acids. Before absorption can occur, the iron must be split from these carriers (a process that is facilitated by the acid secretions of the stomach) and reduced to the ferrous form (a process that is enhanced by ascorbic acid). Only 10% of the iron in an average mixed diet is usually absorbed, but the efficiency of absorption can be increased to 30% by severe iron deficiency. Iron absorption and metabolism have been discussed in Chapter 24 and are summarized in Figure 28.15.

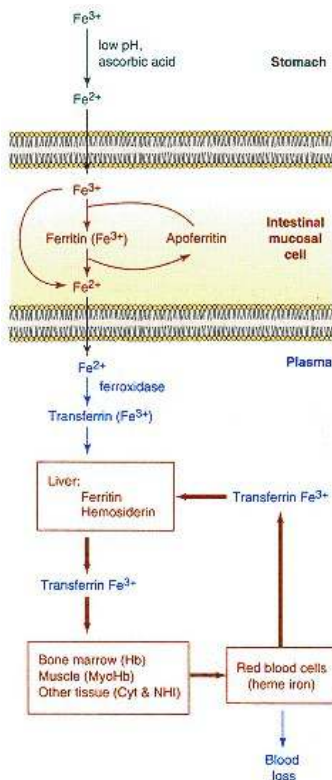

Figure 28.15

Overview of iron metabolism.

This figure reviews some of the features of iron metabolism discussed previously in Chapter 24. The red arrows indicate that most of the body's iron is efficiently reutilized by the pathway shown. Hb, hemoglobin; MyoHb, myoglobin; Cyt, cytochromes; and NHI, nonheme iron.

Iron plays a number of important roles in the body. As a component of hemoglobin and myoglobin, it is required for O_2 and CO_2 transport. As a component of cytochromes and nonheme iron proteins, it is required for oxidative phosphorylation. As a component of the essential lysosomal enzyme myeloperoxidase, it is required for proper phagocytosis and killing of bacteria by neutrophils. The best-known symptom of iron deficiency is a **microcytic hypochromic anemia**. Iron deficiency is also associated with **decreased immunocompetence**.

Assuming a 10–15% efficiency of absorption, the Food and Nutrition Board has set a recommended dietary allowance of 10 mg day^{-1} for normal adult males and 15 mg day^{-1} for menstruating females. For pregnant females this allowance is raised to 30 mg day^{-1} . While 10 mg of iron can easily be obtained from a normal diet, 15 mg is marginal at best and 30 mg can almost never be obtained. The best dietary sources are meats, dried legumes, dried fruits, and enriched cereal products.

Iron-deficiency anemia is considered the most prevalent nutritional disorder in the United States. Young children and pregnant females need enough iron for a continuing increase in blood volume. Menstruating females lose iron through blood loss and lactating females through production of lactoferrin. Thus iron deficiency anemia is primarily a problem for these population groups. This is reflected in dietary surveys, which indicate that 95% or more of children and menstruating females are not obtaining adequate iron in their diet. It is also reflected in biochemical measurements of a 10–25% incidence of iron deficiency anemia in this same group. Iron-deficiency anemia is also occasionally a problem with the elderly due to poor dietary intake and increased frequency of achlorhydria.

Because of the widespread nature of iron-deficiency anemia, government programs of nutritional intervention such as the WIC program have emphasized iron-rich foods. There has also been discussion of more extensive iron fortification of foods. There is concern among some nutritionists that iron deficiency has been overemphasized. Some recent studies suggest that **excess iron** intake may increase the risk of cardiovascular disease. Thus iron supplementation and the consumption of iron-fortified foods may be inappropriate for adult men and postmenopausal women. Excess iron can also lead to a rare condition called **hemochromatosis** in which iron deposits are found in abnormally high levels in many tissues. This can lead to liver, pancreatic, and cardiac dysfunction as well as pigmentation of the skin. This condition is usually only seen in hemolytic anemias and liver disease.

Iodine Is Incorporated into Thyroid Hormones

Dietary **iodine** is efficiently absorbed and transported to the **thyroid** gland, where it is stored and used for synthesis of the thyroid hormones triiodothyro-

nine and thyroxine. These hormones function in regulating the **basal metabolic rate** of adults and the growth and development of children. Saltwater fish are the best natural food sources of iodine and in earlier years population groups living in inland areas suffered from the endemic deficiency disease **goiter**. The most characteristic symptom of goiter is the enlargement of the thyroid gland to the point where a large nodule is visible on the neck. Since iodine has been routinely added to table salt, goiter has become relatively rare. However, in some inland areas, mild forms of goiter may still be seen in up to 5% of the population.

Zinc Is a Cofactor for Many Enzymes

Zinc absorption appears to be proportional to **metallothionein** levels in intestinal mucosa cells. The exact function of metallothionein in zinc transport is uncertain, but it may serve as a buffer for zinc ions as the metal transverse the intestinal cells. Over 300 zinc metalloenzymes have been described to date, including a number of regulatory proteins and both RNA and DNA polymerases. **Zinc deficiencies** in children are usually marked by poor growth and impairment of sexual development. In both children and adults zinc deficiencies result in poor wound healing. Zinc is also present in **gustin**, a salivary polypeptide that appears to be necessary for normal development of taste buds. Thus zinc deficiencies also lead to decreased taste acuity.

The few dietary surveys that have been carried out in this country have indicated that zinc intake may be marginal for many individuals. However, few symptoms of zinc deficiency other than decreased taste acuity can be demonstrated in those individuals. Severe zinc deficiency is seen primarily in **alcoholics** (especially if they have cirrhosis), patients with **chronic renal disease** or severe malabsorption diseases, and occasionally in people after long-term parenteral nutrition (TPN). The most characteristic early symptom of zinc-deficient patients on TPN is dermatitis. Zinc is occasionally used therapeutically to promote wound healing and may be of some use in treating gastric ulcers.

Copper Is Also a Cofactor for Important Enzymes

Copper absorption may also be dependent on the protein **metallothionein**, since excess intake of either copper or zinc interferes with the absorption of the other. Copper is present in a number of important metalloenzymes, including cytochrome *c* oxidase, dopamine β -hydroxylase, superoxide dismutase, lysyl oxidase, and 9 -desaturase. 9 -Desaturase is responsible for converting stearic acid (a C_{18} saturated fatty acid) to oleic acid (a C_{18} monounsaturated fatty acid). This may be responsible for the fact that dietary stearic acid does not have the cholesterol-raising property of the other saturated fatty acids. Lysyl oxidase is necessary for the conversion of certain lysine residues in collagen and elastin to allysine, which is needed for cross-linking. Some of the symptoms of **copper deficiency** include **hypercholesterolemia**, demineralization of bones, leukopenia, anemia, fragility of large arteries, and demyelination of neural tissue. Anemia appears to be due to a defect in iron metabolism. The copper-containing enzyme ferroxidase is necessary for conversion of iron from the Fe^{2+} state (in which form it is absorbed) to the Fe^{3+} state (in which form it can bind to the plasma protein transferrin). The bone demineralization and blood vessel fragility can be traced directly to defects in collagen and elastin formation. The hypercholesterolemia may be related to increases in the ratio of saturated to monounsaturated fatty acids of the C_{18} series due to reduced activity of the C_{18} , 9 -desaturase.

Copper balance studies carried out with human volunteers seem to indicate a minimum requirement of $1.0\text{--}2.6\text{ mg day}^{-1}$. The RDA has been set at $1.5\text{--}3\text{ mg day}^{-1}$. Most dietary surveys find the average American diet provides only 1 mg at $<2000\text{ cal day}^{-1}$. This remains a puzzling problem. Few symptoms of

copper deficiency have been identified in the general public. It is not known whether there exist widespread marginal copper deficiencies, or whether the copper balance studies are inaccurate. Recognizable symptoms of copper deficiency are usually seen only as a result of excess zinc intake and in **Menkes' syndrome**, a relatively rare X-linked hereditary disease associated with a defect in copper transport. **Wilson's disease**, an autosomal recessive disease, is associated with abnormal accumulation of copper in various tissues and can be treated with the naturally occurring copper chelating agent penicillamine.

Chromium Is a Component of Glucose Tolerance Factor

Chromium probably functions primarily as a component of **glucose tolerance factor (GTF)**, a naturally occurring coordination complex between chromium, nicotinic acid, and the amino acids glycine, glutamate, cysteine, or glutathione. GTF potentiates the effects of insulin, presumably by facilitating its binding to cell receptor sites. The chief symptom of **chromium deficiency** is impaired glucose tolerance, a result of the decreased insulin effectiveness. The frequency of chromium deficiency is unknown. The RDA for chromium has been set at 50–200 μg for a normal adult. The best current estimate is that the average consumption of chromium is around 30 $\mu\text{g day}^{-1}$ in the United States. Unfortunately, the range of intakes is very wide (5–100 μg) even for individuals otherwise consuming balanced diets. Those most likely to have marginal or low intakes of chromium are individuals on low-caloric intakes or consuming large amounts of processed foods. Some concern has been voiced that many Americans may be marginally deficient in chromium.

Selenium Is a Scavenger of Peroxides

Selenium functions primarily in the metalloenzyme glutathione peroxidase, which destroys peroxides in the cytosol. Since the effect of vitamin E on peroxide formation is limited primarily to the membrane, both selenium and vitamin E appear to be necessary for efficient scavenging of peroxides. Selenium is one of the few nutrients not removed by the milling of flour and is usually thought to be present in adequate amounts in the diet. The selenium levels are very low in the soil in certain parts of the country, however, and foods raised in these regions will be low in selenium. Fortunately, this effect is minimized by the current food distribution system, which assures that the foods marketed in any one area are derived from a number of different geographical regions.

Manganese, Molybdenum, Fluoride, and Boron Are Other Trace Elements

Manganese is a component of pyruvate carboxylase and probably other metalloenzymes as well. **Molybdenum** is a component of xanthine oxidase. **Fluoride** is known to strengthen bones and teeth and is usually added to drinking water. **Boron** may also play an important role in bone formation.

28.11—

The American Diet:

Fact and Fallacy

Much has been said about the supposed deterioration of the American diet. How serious a problem is this? Clearly Americans are eating much more processed food than their ancestors. These foods differ from simpler foods in that they have a higher caloric density and a lower nutrient density than the foods they replace. However, these foods are almost uniformly enriched with iron, thiamine, riboflavin, and niacin. In many cases they are even fortified (usually as much for sales promotion as for nutritional reasons) with as many as 11–15 vitamins and minerals. Unfortunately, it is simply not practical to replace all of

the nutrients lost, especially the trace minerals. Imitation foods present a special problem in that they are usually incomplete in more subtle ways. For example, imitation cheese and imitation milkshakes that are widely sold in this country usually contain the protein and calcium one would expect of the food they replace, but often do not contain the riboflavin, which one would also obtain from these items. Fast food restaurants have also been much maligned in recent years. Some of the criticism has been undeserved, but fast food meals do tend to be high in calories and fat and low in certain vitamins and trace minerals. For example, the standard fast food meal provides over 50% of the calories the average adult needs for the entire day, while providing <5% of the vitamin A and <30% of biotin, folic acid, and pantothenic acid. Unfortunately, much of the controversy in recent years has centered around whether these trends are "good" or "bad." This simply obscures the issue at hand. Clearly it is possible to obtain a balanced diet which includes processed, imitation, and fast foods if one compensates by selecting foods for the other meals that are low in caloric density and rich in nutrients. Without such compensation the "balanced diet" becomes a myth.

28.12—

Assessment of Nutritional Status in Clinical Practice



Figure 28.16
Factors affecting
individual nutritional status.

Schematic representation of three important risk factors in determining nutritional status. A person on the periphery would have very low risk of any nutritional deficiency, whereas people in the green, orange, purple, or center areas would be much more likely to experience some symptoms of nutritional deficiencies.

Having surveyed the major micronutrients and their biochemical roles, it might seem that the process of evaluating the **nutritional status** of an individual patient would be an overwhelming task. It is perhaps best to recognize that there are three factors that can add to nutritional deficiencies: poor diet, malabsorption, and increased nutrient need. Only when two or three components overlap in the same person (Figure 28.16) do the risks of symptomatic deficiencies become significant. For example, infants and young children have increased needs for iron, calcium, and protein. Dietary surveys show that many of them consume diets inadequate in iron and some consume diets that are low in calcium. Protein is seldom a problem unless the children are being raised as strict vegetarians (see Clin. Corr. 28.8). Thus the chief nutritional concerns for most children are iron and calcium. **Teenagers** tend to consume diets low in calcium, magnesium, vitamin A, vitamin B₆, and vitamin C. Of all these nutrients, their needs are particularly high for calcium and magnesium during the teenage years, so these are the nutrients of greatest concern. **Young women** are likely to consume diets low in iron, calcium, magnesium, vitamin B₆, folic acid, and zinc—and all these nutrients are needed in greater amounts during pregnancy and lactation. **Adult women** often consume diets low in calcium, yet they may have a particularly high need for calcium to prevent rapid bone loss. Finally, the elderly have unique nutritional needs (see Clin. Corr. 28.9) and tend to have poor nutrient intake due to restricted income, loss of appetite, and loss of the ability to prepare a wide variety of foods. They are also more prone to suffer from malabsorption problems and to use multiple prescription drugs that increase nutrient needs (Table 28.1).

TABLE 28.1 Drug-Nutrient Interactions

<i>Drug</i>	<i>Potential Nutrient Deficiencies</i>
Alcohol	Thiamine Folic acid Vitamin B ₆
Anticonvulsants	Vitamin D Folic acid Vitamin K
Cholestyramine	Fat-soluble vitamins Iron
Corticosteroids	Vitamin D and calcium Zinc Potassium
Diuretics	Potassium Zinc
Isoniazid	Vitamin B ₆
Oral contraceptives and estrogens	Vitamin B ₆ Folic acid and B ₁₂

Illness and metabolic stress often cause increased demand or decreased utilization of certain nutrients. For example, diseases leading to fat malabsorption cause a particular problem with absorption of calcium and the fat-soluble vitamins. Other malabsorption diseases can result in deficiencies of many nutrients depending on the particular malabsorption disease. Liver and kidney disease can prevent activation of vitamin D and storage or utilization of many other nutrients including vitamin A, vitamin B₁₂, and folic acid. Severe illness or trauma increases the need for calories, protein, and possibly some micronutrients such as vitamin C and certain B vitamins. Long-term use of many drugs in the treatment of chronic disease states can affect the need for certain micronutrients. Some of these are summarized in Table 28.1.

Who then is at a nutritional risk? Obviously, the answer depends on many

CLINICAL CORRELATION 28.8**Nutritional Considerations for Vegetarians**

A vegetarian diet poses certain problems in terms of micronutrient intake that need to be recognized in designing a well-balanced diet. Vitamin B₁₂ is of special concern, since it is found only in foods of animal origin. Vitamin B₁₂ should be obtained from fortified foods (such as some brands of soybean milk) or in tablet form. However, surprisingly few vegetarians ever develop pernicious anemia, perhaps because an adult who has previously eaten meat will have a 6–10-year store of B₁₂ in their liver.

Iron is another problem. The best vegetable sources of iron are dried beans, dried fruits, whole grain or enriched cereals, and green leafy vegetables. Vegetarian diets can provide adequate amounts of iron provided that these foods are regularly selected and consumed with vitamin C-rich foods to promote iron absorption. However, iron supplementation is usually recommended for children and menstruating women.

When milk and dairy products are absent from the diet, certain other problems must be considered as well. Normally, dietary vitamin D is obtained primarily from fortified milk. While some butters and margarines are fortified with vitamin D, they are seldom consumed in sufficient quantities to supply significant amounts of vitamin D. Although adults can usually obtain sufficient vitamin D from exposure to sunlight, dietary sources are often necessary during periods of growth and for adults with little exposure to sunlight. Vegetarians may need to obtain their vitamin D from fortified foods such as cereals, certain soybean milks, or in tablet form. Riboflavin is found in a number of vegetable sources such as green leafy vegetables, enriched breads, and wheat germ. However, since none of these sources supply more than 10% of the RDA in normal serving sizes, fortified cereals or vitamin supplements may become an important source of this nutrient. The important sources of calcium for vegetarians include soybeans, soybean milk, almonds, and green leafy vegetables. Those green leafy vegetables without oxalic acid (mustard, turnip, and dandelion greens, collards, kale, romaine lettuce, and loose leaf lettuce) are particularly good sources of calcium. None of these sources, however, is equivalent to cow's milk in calcium content, so calcium supplements are usually recommended during periods of rapid growth.

Specker, B. L. Nutritional concerns of lactating women consuming vegetarian diets. *Am. J. Clin. Nutr.* 59:1182S, 1994; Sanders, T. A. B. and Reddy, S. Vegetarian diets and children. *Am. J. Clin. Nutr.* 59:1176S, 1994; Weaver, C. M., and Plawecki, K. L. Dietary calcium: adequacy of a vegetarian diet. *Am. J. Clin. Nutr.* 59:1238S, 1994; Craig, W. J. Iron status of vegetarians. *Am. J. Clin. Nutr.* 59:1233S, 1994; Gibson, R. S. Content and bioavailability of trace elements in the vegetarian diet. *Am. J. Clin. Nutr.* 59:1223S, 1994.

CLINICAL CORRELATION 28.9**Nutritional Needs of Elderly Persons**

If current trends continue, one out of five Americans will be over the age of 65 by the year 2030. With this projected aging of the American population, there has been increased interest in defining the nutritional needs of the elderly. Recent research shows altered needs of elderly persons for several essential nutrients. For example, the absorption and utilization of vitamin B₆ has been shown to decrease with age. Dietary surveys have consistently shown that B₆ is a problem nutrient for many Americans and the elderly appear to be no exception. Many older Americans get less than 50% of the RDA for B₆ from their diet. Vitamin B₁₂ deficiency is also more prevalent in the elderly. Many older adults develop a condition called atrophic gastritis, which results in decreased acid production in the stomach. That along with a tendency toward decreased production of intrinsic factor leads to poor absorption of B₁₂. Recent research has suggested that elevated blood levels of the amino acid homocysteine may be a risk factor for atherosclerosis. Homocysteine is normally metabolized to methionine and cysteine in reactions requiring folic acid, B₁₂ and B₆. Vitamin D can be a problem as well. Many elderly do not spend much time in the sunlight and to make matters worse the conversion of both 7-dehydrocholesterol to vitamin D in the skin and 25-(OH)D to 1,25-(OH)₂D in the kidney decreases with age. These factors often combine to produce significant deficiencies of 1,25-(OH)₂D in the elderly, which can in turn lead to negative calcium balance. These changes do not appear to be the primary cause of osteoporosis but they certainly may contribute to it.

There is some evidence for increased need for chromium and zinc as well. Chromium is not particularly abundant in the American diet and many elderly appear to have difficulty converting dietary chromium to the biologically active glucose tolerance factor. The clinical relevance of these observations is not clear but chromium deficiency could contribute to adult-onset diabetes. Similarly, dietary surveys show that most elderly consume between one-half and two-thirds the RDA for zinc. Conditions such as atrophic gastritis can also interfere with zinc absorption. Symptoms of zinc deficiency include loss of taste acuity, dermatitis, and a weakened immune system. All of these symptoms are common in the elderly population and it has been suggested that zinc deficiency might contribute.

Not all of the news is bad, however. Vitamin A absorption actually increases as we age and the ability of the liver to clear vitamin A from the blood decreases, so it remains in the circulation for a longer time. In fact, not only does the need for vitamin A decrease as we age, but the elderly also need to be particularly careful to avoid vitamin A toxicity. While this does not restrict their choice of foods or multivitamin supplements, they should generally avoid separate vitamin A supplements.

Munro, H. N., Suter, P. M., and Russell, R. M. Nutritional requirements of the elderly. *Annu. Rev. Nutr.* 7:23, 1987; Russell, R. M., and Suter, P. M. Vitamin requirements of elderly people: an update. *Am. J. Clin. Nutr.* 58:4, 1993; Ublink, J. B., Vermoak, W. J., van der Merne, A., and Becker, P. J. Vitamin B₁₂, vitamin B₆ and folate nutritional status in men with hyperhomocysteinemia. *Am. J. Clin. Nutr.* 57:47, 1993; Joosten, E., van der Berg, A., Riezler, R., Neurath, H. J., Linderbaum, J. Stabler, S. P., and Allen, R. H. Metabolic evidence that deficiencies of vitamin B₁₂, folate and vitamin B₆ occur commonly in elderly people. *Am. J. Clin. Nutr.* 58:468, 1993.

factors. Nutritional counseling is an important part of treatment for infants, young children, and pregnant/lactating females. A brief analysis of a dietary history and further nutritional counseling are important when dealing with high-risk patients.

Bibliography

Recommended Dietary Allowances

Food and Nutrition Board of the National Academy of Sciences. *Recommended Daily Allowances*, 10th Edition. Washington, DC: National Academy of Sciences, 1989.

Vitamin A

Goodman, D. S. Vitamin A and retinoids in health and disease. *N. Engl. J. Med.* 310:1023–1031, 1984.

Wolf, G. Multiple functions of vitamin A. *Physiol. Rev.* 64:873–935, 1984.

van Poppel, G., and Goldbohm, R. A. Epidemiologic evidence for β -carotene and cancer prevention. *Am. J. Clin. Nutr.* 62:1393S, 1995.

Vitamin D

Darwish, H., and DeLuca, H. F. Vitamin D—regulated gene expression. *Crit. Rev. Eukaryot. Gene Expr.*, 3:89, 1993.

DeLuca, H. F. The vitamin D story. A collaborative effort of basic science and clinical medicine. *FASEB J.* 2:224–236, 1988.

Vitamin E

Bieri, J. G., Coresh, L., and Hubbard, V. S. Medical uses of vitamin E. *N. Engl. J. Med.* 308:1063–1072, 1983.

Das, S. Vitamin E in the genesis and prevention of cancer. A review. *Acta Oncol.* 33:615, 1994.

Meydani, S. N., Wu, D., Santos, M. S., and Hayek, M. C. Antioxidants and immune response in aged persons: overview of present evidence. *Am. J. Clin. Nutr.* 62:1462S, 1995.

Nyyssonen, K., Porkkala, E., Salonen, R., Korpela, H., and Salonen, J. T. Increase in oxidation resistance of atherogenic serum lipoproteins following antioxidant supplementation: a randomized double-blind placebo-controlled clinical trial. *Eur. J. Clin. Nutr.* 48:633–642, 1994.

Stampfer, M. J., and Rimm, E. B. Epidemiologic evidence for vitamin E in prevention of cardiovascular disease. *Am. J. Clin. Nutr.* 62:1365S, 1995.

Vitamin K

Binkley, N. C., and Suttie, J. W. Vitamin K nutrition and osteoporosis. *J. Nutr.* 125:1812, 1995.

Lipsky, J. J. Nutritional sources of vitamin K. *Mayo Clin. Proc.* 69:462, 1994

Vitamin B₆

Merril, A. H. Jr., and Henderson, J. M. Diseases associated with defects in vitamin B₆ metabolism or utilization. *Annu. Rev. Nutr.* 7:137–156, 1987.

Tully, D. B., Allgood, V. E., and Cidlowski, J. A. Modulation of steroid receptor-mediated gene expression by vitamin B₆. *FASEB J.* 8:343, 1994.

Folate

Blakely, R. L., and Whitehead, V. M. (Eds.). *Folate and Pterins*, Vol 3. New York: Wiley, 1986.

Landgren, F., Israelsson, B., Lindgren, A., Hultsberg, B., Anderson, A., and Brettstrom, L. Plasma homocysteine in acute myocardial infarction: homocysteine-lowering effects of folic acid. *J. Intern. Med.* 237:381, 1995.

Milunsky, A., Jick, H., Jick, S. S., Bruell, C. L., MacLaughlin, D. S., Rothman, K. J., and Willet, W. Multivitamin/folic acid supplementation in early pregnancy reduces the prevalence of neural tube defects. *JAMA* 262:2847, 1989

Vitamin C

Hemila, H. Does vitamin C alleviate the symptoms of the common cold? A review of current evidence. *Scand. J. Infect Dis.* 26:1, 1994.

Third International Conference on Vitamin C. *Ann. N.Y. Acad. Sci.* 498:1–534, 1987.

Simon, J. A. Vitamin C and cardiovascular disease: a review. *J. Am. Coll. Nutr.* 11:107, 1992.

Calcium

Hatton, D. C., and McCarron, D. A. Dietary calcium and blood pressure in experimental models of hypertension. *Hypertension* 23:513, 1994.

National Institutes of Health. Optimal calcium intake. *NIH Consens. Statement*, 12(4), 1994.

Iron

Dollman, P. R. Biochemical basis for the manifestations of iron deficiency. *Annu. Rev. Nutr.* 6:13, 1986.

Chromium

Mertz, W. Chromium in human nutrition: a review. *J. Nutr.* 123:626, 1993

Other Trace Minerals

Symposium on metal metabolism and disease. *Clin. Physiol. Biochem.* 4:1–111, 1986.

Dietary Surveys

Block, G. Dietary guidelines and the results of food consumption surveys. *Am. J. Clin. Nutr.* 53:356S, 1991.

Kritchevsky, D. Dietary guidelines. The rationale for intervention. *Cancer* 72:1011, 1993.

Pao, E. M., and Mickle, S. J. Problem nutrients in the United States. *Food Technol.* 35:58–67, 1981.

Questions

J. Baggott and C. N. Angstadt

1. Recommended dietary allowances (RDAs):

- A. are standards for all individuals.
- B. meet special dietary needs arising from chronic diseases.
- C. include all nutritional needs.
- D. define optimal levels of nutrients.
- E. are useful only as general guides in evaluating the adequacy of diets.

2. The effects of vitamin A may include all of the following EXCEPT:

- A. prevention of anemia.
- B. serving as an antioxidant.
- C. cell differentiation.
- D. the visual cycle.
- E. induction of certain cancers.

3. All of the following organs are associated with vitamin D metabolism or effects of vitamin D on calcium metabolism EXCEPT:

- A. bone.
- B. erythrocytes.
- C. gut.
- D. kidney.
- E. liver.

Refer to the following for Questions 4–8:

- A. vitamin A
- B. vitamin K
- C. niacin
- D. vitamin D
- E. vitamin B₁₂ (cobalamine)

- 4. Requirement may totally be supplied by intestinal bacteria.
- 5. Precursor is synthesized by green plants.
- 6. Tryptophan is a precursor.
- 7. Deficiency may be seen in long-term adherence to a strict vegetarian diet.
- 8. Is required for normal regulation of calcium metabolism.

9. Ascorbic acid may be associated with all of the following EXCEPT:

- A. iron absorption.
- B. bone formation.
- C. acute renal disease when taken in high doses.
- D. wound healing
- E. participation in hydroxylation reactions.

10. In assessing the adequacy of a person's diet:

- A. age of the individual usually has little relevance.
- B. trauma decreases activity, and hence decreases need for calories and possibly some micronutrients.
- C. a 24-h dietary intake history provides an adequate basis for making a judgment.
- D. currently administered medications must be considered.
- E. intestine is the only organ whose health has substantial bearing on nutritional status.

Refer to the following for Questions 11–15:

- A. calcium
- B. iron
- C. iodine
- D. copper
- E. selenium

- 11. Absorption is inhibited by excess dietary zinc.
- 12. Excess dietary protein causes rapid excretion.
- 13. Risk of nutritional deficiency is high in young children.
- 14. Unsupplemented diets of populations living in inland areas may be deficient.
- 15. Essential component of glutathione peroxidase.

Answers

1. E A: RDAs are designed for most individuals; exceptions occur. B: Diseases often change dietary requirements. C: Some nutritional needs may be unknown; the requirements for all known nutrients are not even clear. D: Optimal levels of nutrients are hard to define; it depends on the criterion for optimal. (See pp. 1108–1109.)
2. E Vitamin A deficiency is linked to increased susceptibility to certain cancers. A: Retinyl phosphate serves as a glycosyl donor in the synthesis of certain glycoproteins (p. 1110), including transferrin (p. 1111). B: β -Carotene functions as an antioxidant. See p. 1110. C: Retinol and retinoic acid may function like steroid hormones (p. 1110). D: Retinol cycles between the ¹¹-cis and all-trans forms in the visual cycle (p. 1111).
3. B A: Calcium mobilization from bone is increased by 1,25-(OH)₂D. C: 1,25-(OH)₂D regulates calcium absorption by the gut. D: Kidney converts inactive 25-(OH)D to the active 1,25-(OH)₂D or to the inactive 24,25-(OH)₂D. E: Liver converts D to 25-(OH)D. See Figure 28.5 and p. 1114.
4. B See p. 1117.
5. A β -Carotene, from green plants, is converted to vitamin A (p. 1110).
6. C See p. 1121.
7. E This vitamin is from animal sources (p. 1126).
8. D 1,25-Dihydroxyvitamin D is required for calcium absorption and, along with parathyroid hormone, regulates bone resorption and calcium excretion.
9. C There has been speculation, not borne out by studies designed to shed light on the issue, that high levels of ascorbic acid could lead to oxalate kidney stones. A: Ascorbic acid aids in iron absorption by reducing iron. B: Ascorbic acid is essential for collagen synthesis, which is critical in bone formation. D and E: Ascorbic acid is required for the hydroxylation of lysine and proline residues in procollagen and, therefore is required for wound healing. (See pp. 1127–1128.)
10. D Corticosteroids stimulate vitamin D inactivation. (p. 1114). A: Dramatic differences may occur at different ages. B: Trauma increases caloric requirements and probably requirements for specific micronutrients. C: You cannot be sure that any 24-h diet history is either accurate or representative of the individual's typical diet. E: While the intestine must function well enough to absorb nutrients, further metabolic changes are typically required. The metabolism of vitamin D by the liver and kidney (p. 1115) and the conversion of β -carotene to vitamin A exemplify these interorgan interrelations.
11. D See p. 1131.
12. A See p. 1128.
13. B Rapid growth in children causes high demands for iron (p. 1130).
14. C The problem is rare in the United States due to the common use of iodized salt (p. 1131).
15. E See p. 1132.

Appendix— Review of Organic Chemistry

Carol N. Angstadt

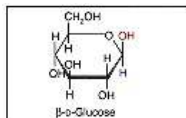

Functional Groups

Alcohols

The general formula of **alcohols** is R–OH, where R equals an alkyl or aryl group. They are classified as *primary*, *secondary*, or *tertiary*, according to whether the hydroxyl (OH)-bearing carbon is bonded to no carbon or one, two, or three other carbon atoms:

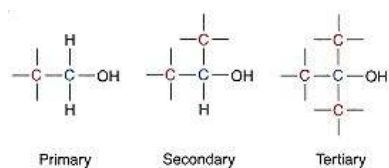

Aldehydes and Ketones

Aldehydes and **ketones** contain a carbonyl group:



Aldehydes are



and a **ketone** has two alkyl groups at the carbonyl group



Acids and Acid Anhydrides

Carboxylic acids contain the functional group



(–COOH). Dicarboxylic and tricarboxylic acids contain two or three carboxyl groups. A carboxylic acid ionizes in water to a negatively charged carboxylate ion:

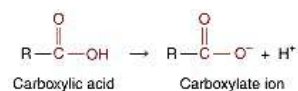

Names of carboxylic acids usually end in *-ic* and the carboxylate ion in *-ate*. **Acid anhydrides** are formed when two molecules of acid react with loss of a molecule of water. An acid anhydride may form between two organic acids, two inorganic acids, or an organic and an inorganic acid:

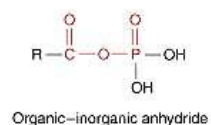
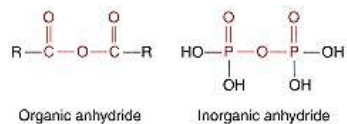

Esters

Esters form in the reaction between a carboxylic acid and an alcohol:

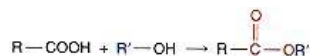

Esters may form between an inorganic acid and an organic alcohol, for example, glucose 6-phosphate.

Hemiacetals, Acetals, and Lactones

A reaction between an aldehyde and an alcohol gives a **hemiacetal**, which may react with another molecule of alcohol to form an **acetal**:

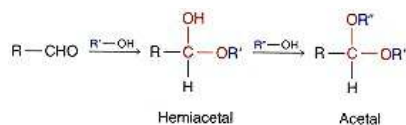

Lactones are cyclic esters formed when an acid and an alcohol group on the same molecule react and usually require that a five- or six-membered ring be formed.

Unsaturated Compounds

Unsaturated compounds are those containing one or more carbon-carbon multiple bonds, for example, a double bond: $-C=C-$

Amines and Amides

Amines, $R-NH_2$, are organic derivatives of NH_3 and are classified as *primary*, *secondary*, or *tertiary*, depending on the number of alkyl groups (R) bonded to the nitrogen. When a fourth substituent is bonded to the nitrogen, the species is positively charged and called a *quaternary ammonium ion*:

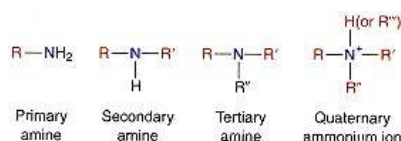

Amides contain the functional group

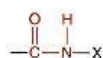

where X can be H (simple) or R (N substituted). The carbonyl group is from an acid, and the N is from an amine. If both functional groups are from amino acids, the amide bond is referred to as a **peptide bond**.

Types of Reactions

Nucleophilic Substitutions at an Acyl Carbon

If the acyl carbon is on a carboxylic group, the leaving group is water. Nucleophilic substitution on carboxylic acids usually

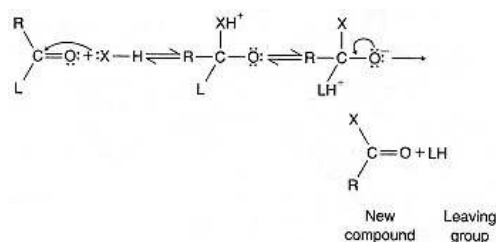

requires a catalyst or conversion to a more reactive intermediate; biologically this occurs via enzyme catalysis. X-H may be an alcohol (R-OH), ammonia, amine (R-NH₂), or another acyl compound. Types of nucleophilic substitutions include *esterification*, *peptide bond* formation, and *acid anhydride* formation.

Hydrolysis and Phosphorolysis Reactions

Hydrolysis is the cleavage of a bond by water:



Hydrolysis is often catalyzed by either acid or base. *Phosphorolysis* is the cleavage of a bond by inorganic phosphate:

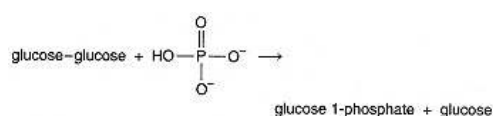

Oxidation-Reduction Reactions

Oxidation is the loss of electrons; **reduction** is the gain of electrons. Examples of oxidation are as follows:

- $Fe^{2+} + \text{acceptor} \rightarrow Fe^{3+} + \text{acceptor} \cdot e^-$
- $S(\text{substrate}) + O_2 + DH_2 \rightarrow S-OH + H_2O + D$
- $S-H_2 + \text{acceptor} \rightarrow S + \text{acceptor} \cdot H_2$

Some of the group changes that occur on oxidation-reduction are:

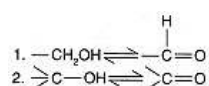

In the Cahn–Ingold–Prelog system, the designations are (*R*) (rectus; right) and (*S*) (sinister, left).

The configuration of monosaccharides is determined by the stereochemistry at the asymmetric carbon furthest from the carbonyl carbon (number 1 for an aldehyde; lowest possible number for a ketone). Based on the *position* of the OH on the highest number asymmetric carbon, a monosaccharide is D if the OH projects to the *right* and L if it projects to the *left*. The D and L monosaccharides with the same name are *enantiomers*, and the substituents on all asymmetric carbon atoms are reversed as in

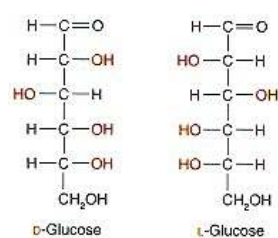

Epimers (e.g., glucose and mannose) are stereoisomers that differ in the configuration about *only one* asymmetric carbon. The relationship of OH groups to *each other* determines the specific monosaccharide. Three aldohexoses and three pentoses of importance are

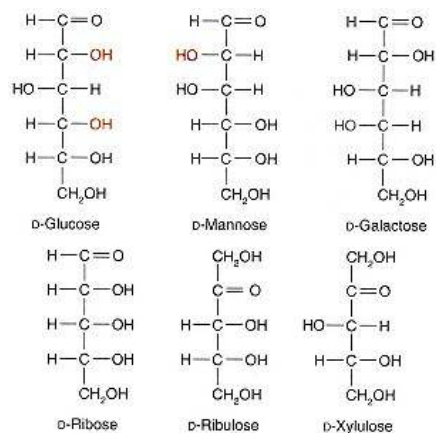

Fructose, a ketohexose, differs from glucose only on carbon atoms 1 and 2:

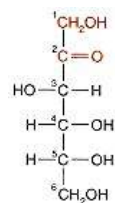

Five- and six-carbon monosaccharides form **cyclic hemiacetals** or *hemiketals* in solution. A new asymmetric carbon is generated so two isomeric forms are possible:

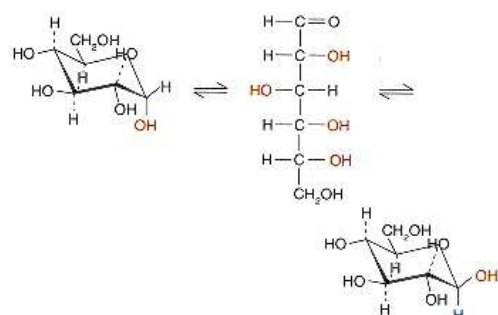

Both five-membered (furanose) and six-membered (pyranose) ring structures are possible, although pyranose rings are more common. A furanose ring is written as follows:

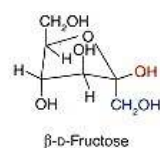

The isomer is designated α if the OH group and the CH₂OH group on the two carbon atoms linked by the oxygen are trans to each other and β if they are cis. The hemiacetal or hemiketal forms may also be written as modified *Fischer projection formulas*: α if OH on the acetal or ketal carbon projects to the same side as the ring and β if on the opposite side:

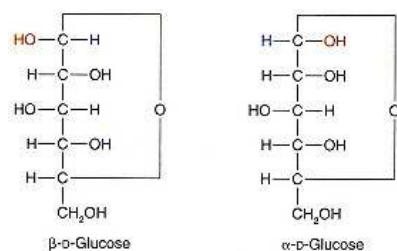

Haworth formulas are used most commonly:

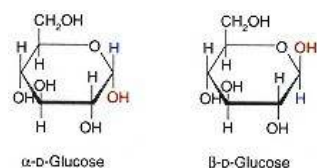

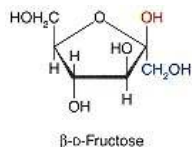

The ring is perpendicular to the plane of the paper with the oxygen written to the back (upper) right, C-1 to the right, and substituents above or below the plane of the ring. The OH at the acetal or ketal carbon is below in the α isomer and above in the β . Anything written to the right in the Fischer projection is written down in the Haworth formula.

The α and β forms of the same monosaccharide are special forms of epimers called *anomers*, differing only in the configuration about the anomeric (acetal or ketal) carbon. Monosaccharides exist in solution primarily as a mixture of the hemiacetals (or hemiketals) but react chemically as aldehydes or ketones. *Mutarotation* is the equilibration of α and β forms through the free aldehyde or ketone. Substitution of the H of the anomeric OH prevents mutarotation and fixes the configuration in either the α or β form.

Monosaccharide Derivatives

A **deoxymonosaccharide** is one in which an OH has been replaced by H. In biological systems, this occurs at C-2 unless otherwise indicated. An **amino monosaccharide** is one in which an OH has been replaced by NH_2 , again at C-2 unless otherwise specified. The amino group of an amino sugar may be *acetylated*:

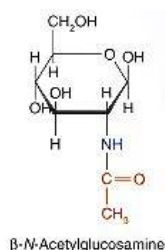

An aldehyde is reduced to a primary and a ketone to a secondary **monosaccharide alcohol (alditol)**. Alcohols are named with the base name of the sugar plus the ending *-itol* or with a trivial name (glucitol = sorbitol). Monosaccharides that differ around only two of the first three carbon atoms yield the same alditol. D-Glyceraldehyde and dihydroxyacetone give glycerol:

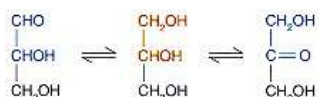

D-Glucose and D-fructose give D-sorbitol; D-fructose and D-mannose give D-mannitol. Oxidation of the terminal CH_2OH , but not of the CHO, yields a **-uronic acid**, a *monosaccharide acid*:

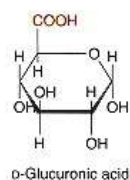

Oxidation of the CHO, but not the CH_2OH , gives an **-onic acid**:

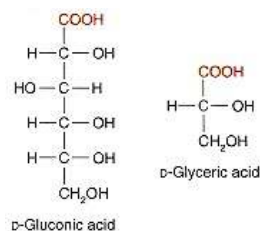

Oxidation of both the CHO and CH_2OH gives an **-aric acid**:

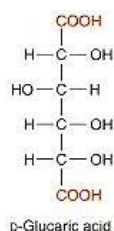

Ketones do not form acids. Both -onic and -uronic acids can react with an OH in the same molecule to form a **lactone** (see p. 1138):

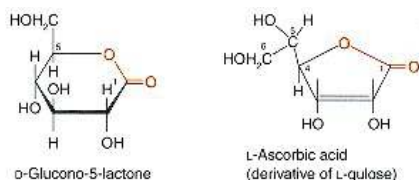

Reactions of Monosaccharides

The most common *esters* of monosaccharides are phosphate esters at carbon atoms 1 and/or 6:

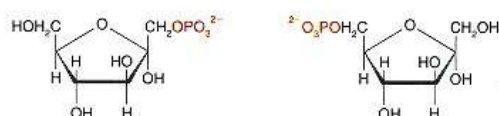

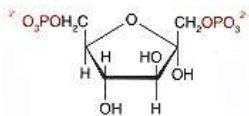

To be a **reducing sugar**, mutarotation must be possible. In alkali, enediols form that may migrate to 2,3 and 3,4 positions:

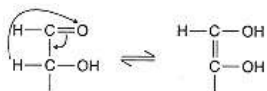

Enediols may be oxidized by O_2 , Cu^{2+} , Ag^+ , and Hg^{2+} . Reducing ability is more important in the laboratory than physiologically. A hemiacetal or hemiketal may react with the OH of another monosaccharide to form a disaccharide (*acetal: glycoside*) (see below):

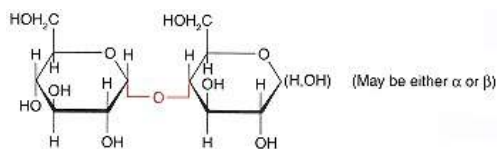

One monosaccharide still has a free anomeric carbon and can react further. Reaction of the anomeric OH may be with any OH on the other monosaccharide, including the anomeric one. The anomeric OH that has reacted is fixed as either α or β and cannot mutarotate or reduce. If the glycosidic bond is not between two anomeric carbon atoms, one of the units will still be free to mutarotate and reduce.

Oligo- and Polysaccharides

Disaccharides have two monosaccharides, either the same or different, in glycosidic linkage. If the glycosidic linkage is between the two anomeric carbon atoms, the disaccharide is nonreducing:

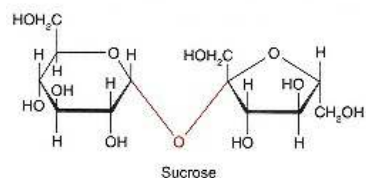
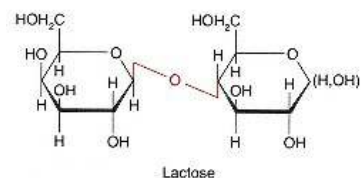
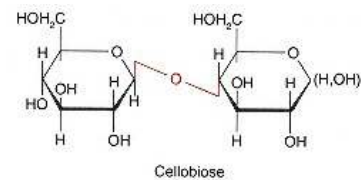
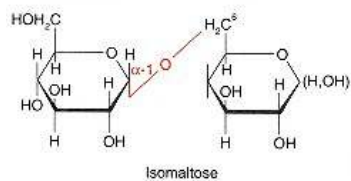
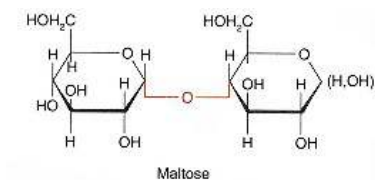

Maltose = 4-*O*-(α -D-glucopyranosyl)D-glucopyranose; reducing

Isomaltose = 6-*O*-(α -D-glucopyranosyl)D-glucopyranose; reducing

Cellobiose = 4-*O*-(β -D-glucopyranosyl)D-glucopyranose; reducing

Lactose = 4-*O*-(β -D-galactopyranosyl)D-glucopyranose; reducing

Sucrose = α -D-glucopyranosyl- β -D-fructofuranoside; non-reducing

As many as thousands of monosaccharides, either the same or different, may be joined by glycosidic bonds to form *polysaccharides*. The anomeric carbon of one unit is usually joined to C-4 or C-6 of the next unit. The ends of a polysaccharide are not identical (reducing end = free anomeric carbon; nonreducing = anomeric carbon linked to next unit; branched polysaccharide = more than one nonreducing end). The most common carbohydrates are homopolymers of glucose; for example, starch, glycogen, and cellulose. Plant starch is a mixture of **amylose**, a linear polymer of maltose units, and **amylopectin**, branches of repeating maltose units (glucose–glucose in α -1,4 linkages) joined via isomaltose linkages. **Glycogen**, the storage form of carbohydrate in animals, is similar to amylopectin, but the branches are shorter and occur more frequently. **Cellulose**, in plant cell walls, is a linear polymer of repeating cellobioses (glucose–glucose in β -1,4 linkages).

Mucopolysaccharides contain amino sugars, free and acetylated, uronic acids, sulfate esters, and sialic acids in addition to the simple monosaccharides. **N-Acetylneur-**

aminic acid, a sialic acid, is

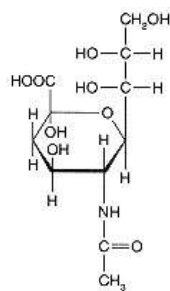

Lipids

Lipids are a diverse group of chemicals related primarily because they are insoluble in water, soluble in nonpolar solvents, and found in animal and plant tissues.

Saponifiable lipids yield salts of fatty acids upon alkaline hydrolysis. *Acylglycerols* = glycerol + fatty acid(s); *phosphoacylglycerols* = glycerol + fatty acids + HPO_4^{2-} + alcohol; *sphingolipids* = sphingosine + fatty acid + polar group (phosphoryl alcohol or carbohydrate); *waxes* = long-chain alcohol + fatty acid. *Nonsaponifiable lipids* (*terpenes*, *steroids*, *prostaglandins*, and related compounds) are not usually subject to hydrolysis. *Amphipathic* lipids have both a polar "head" group and a nonpolar "tail." Amphipathic molecules can stabilize emulsions and are responsible for the lipid bilayer structure of membranes.

Fatty acids are monocarboxylic acids with a short (<6 carbon atoms), medium (8–14 carbon atoms), or long (>14 carbon atoms) aliphatic chain. Biologically important ones are usually linear molecules with an even number of carbon atoms (16–20). Fatty acids are numbered using either arabic numbers (COOH is 1) or the Greek alphabet (COOH is not given a symbol; adjacent carbon atoms are α , β , γ , etc.). **Saturated fatty acids** have the general formula $\text{CH}_3(\text{CH}_2)_n\text{COOH}$. (*Palmitic acid* = C_{16} ; *stearic acid* = C_{18} .) They tend to be extended chains and solid at room temperature unless the chain is short. Both trivial and systematic (prefix indicating number of carbon atoms + *anoic acid*) names are used. $\text{CH}_3(\text{CH}_2)_{14}\text{COOH}$ = palmitic acid or hexadecanoic acid.

Unsaturated fatty acids have one or more double bonds. Most naturally occurring fatty acids have *cis* double bonds and are usually liquid at room temperature. Fatty acids with *trans* double bonds tend to have higher melting points. A double bond is indicated by n , where n is the number of the first carbon of the bond. *Palmitoleic* = 9 -hexadecenoic acid; *oleic* = 9 -octadecenoic acid; *linoleic* = 9,12 -octadecadienoic acid; *linolenic* = 9,12,15 -octadecatrienoic acid; *arachidonic* = 5,8,11,14 -eicosatetraenoic acid. Since fatty acids are elongated *in vivo* from the carboxyl end, biochemists use alternate terminology to assign these fatty acids to families: omega (ω) minus x (or $n - x$), where x is the number of carbon atoms from the methyl end where a double bond is first encountered. *Palmitoleic* is an $\omega - 7$ and *oleic* is an $\omega - 9$ acid, *linoleic* and *arachidonic* are $\omega - 6$ acids, and *linolenic* is an $\omega - 3$ acid. Addition of carbon atoms does not change the family to which an unsaturated fatty acid belongs.

Since the pK values of fatty acids are about 4–5, in physiological solutions, they exist primarily in the ionized form, called salts or "soaps." Long-chain fatty acids are insoluble in water, but soaps form micelles. Fatty acids form esters with alcohols and thioesters with CoA.

The following are biochemically significant reactions of unsaturated fatty acids:

1. Reduction

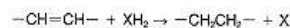

2. Addition of water

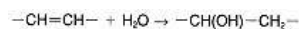

3. Oxidation



Prostaglandins, *thromboxanes*, and *leukotrienes* are derivatives of C_{20} polyunsaturated fatty acids, especially arachidonic acid. Prostaglandins have the general structure:

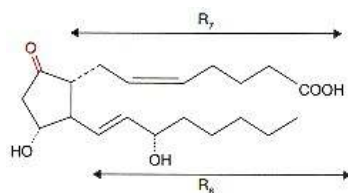

The series differ from each other in the substituents on the ring and whether C-15 contains an OH or O · OH group. The subscript indicates the number of double bonds in the side chains. Substituents indicated by $-(\beta)$ are above the plane of the ring; $-(\alpha)$ below:

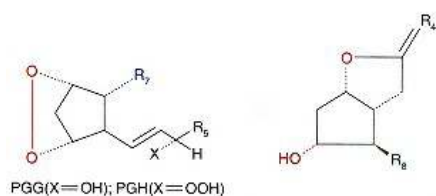
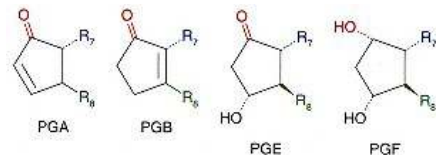

Thromboxanes have an oxygen incorporated to form a six-membered ring:

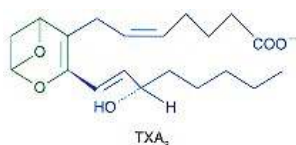

Leukotrienes are substituted derivatives of arachidonic acid in which no internal ring has formed; R is variable:

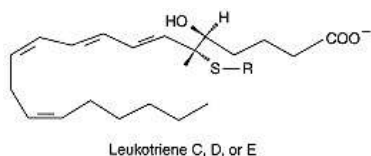

Acylglycerols are compounds in which one or more of the three OH groups of glycerol are esterified. In **triacylglycerols** (triglycerides) all three OH groups are esterified to fatty acids. At least two of the three R groups are usually different. If R₁ is not equal to R₃, the molecule is asymmetric and of the L configuration:

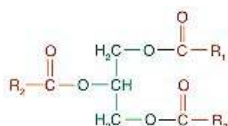

The properties of the triacylglycerols are determined by those of the fatty acids they contain, with *oils* being liquid at room temperature (preponderance of short-chain and/or cis-unsaturated fatty acids) and *fats* being solid (preponderance of long-chain, saturated, and/or trans-unsaturated).

Triacylglycerols are hydrophobic and do not form stable micelles. They may be hydrolyzed to glycerol and three fatty acids by strong alkali or enzymes (lipases). *Mono-* [usually with the fatty acid in the $\beta(2)$ position] and *diacylglycerols* also exist in small amounts as metabolic intermediates. Mono- and diacylglycerols are slightly more polar than triacylglycerols. *Phosphoacylglycerols* are derivatives of L- α -glycerolphosphate (L-glycerol 3-phosphate):

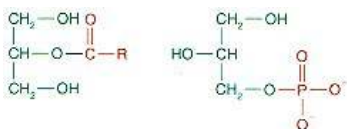

The parent compound, **phosphatidic acid** (two OH groups of L- α -glycerolphosphate esterified to fatty acids), has its phosphate esterified to an alcohol (XOH) to form several series of phosphoacylglycerols. These are amphipathic molecules, but the net charge at pH 7.4 depends on the nature of X-OH.

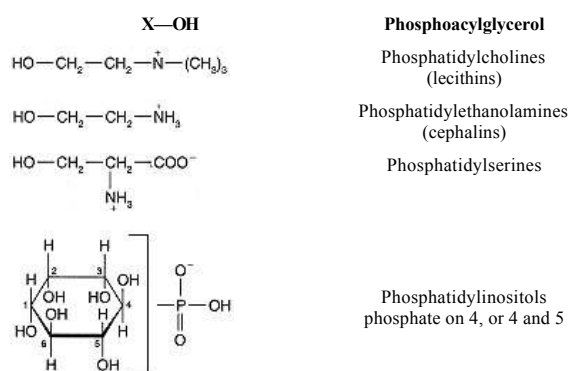

In **plasmalogens**, the OH on C-1 is in *ether*, rather than ester, linkage to an alkyl group. If *one* fatty acid (usually β) has been hydrolyzed from a phosphoacylglycerol, the compound is a *lyso*-compound; for example, lyso-phosphatidylcholine (lysolecithin):

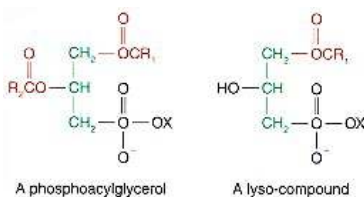

Sphingolipids are complex lipids based on the C-18, unsaturated alcohol, sphingosine. In *ceramides*, a long-chain fatty acid is in amide linkage to sphingosine:

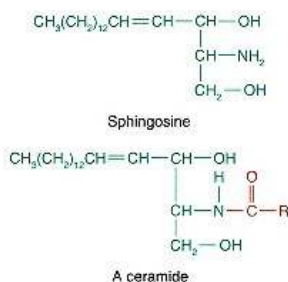

Sphingomyelins, the most common Sphingolipids, are a family of compounds in which the primary OH group of a ceramide is esterified to phosphorylcholine (phosphorylethanolamine):

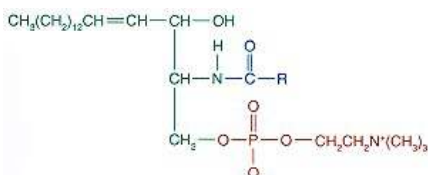

They are amphipathic molecules, existing as zwitterions at pH 7.4 and the only sphingolipids that contain phosphorus. *Glycosphingolipids* do not contain phosphorus but contain carbohydrate in glycosidic linkage to the primary alcohol of a ceramide. They are amphipathic and either neutral or acidic if the carbohydrate moiety contains an acidic group. **Cerebrosides** have a single glucose or galactose linked to a ceramide. *Sulfatides* are galactosylceramides esterified with sulfate at C-3 of the galactose:

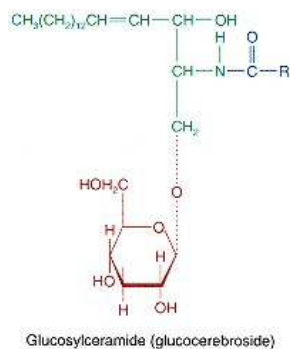

Globosides (ceramide oligosaccharides) are ceramides with two or more neutral monosaccharides, whereas **ganglio-sides** are an oligosaccharide containing one or more sialic acids.

Steroids are derivatives of cyclopentanoperhydrophenanthrene. The steroid nucleus is a rather rigid, essentially planar structure with substituents above or in the plane of the rings designated β (solid line) and those below called α (dotted line):

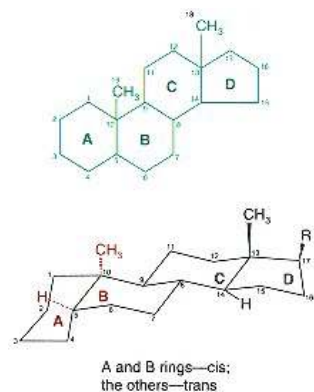

Most steroids in humans have methyl groups at positions 10 and 13 and frequently a side chain at position 17. *Sterols* contain one or more OH groups, free or esterified to a fatty acid. Most steroids are nonpolar. In a liposome or cell membrane, **cholesterol** orients with the OH toward any polar groups; cholesterol esters do not. **Bile acids** (e.g., cholic acid) have a polar side chain and so are amphipathic:

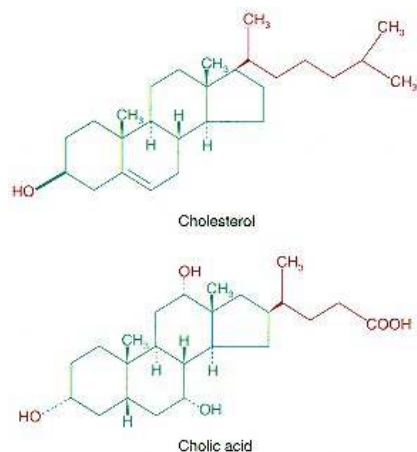

Steroid hormones are oxygenated steroids of 18–21 carbon atoms. *Estrogens* have 18 carbon atoms, an aromatic ring A, and no methyl at C-10. *Androgens* have 19 carbon atoms and no side chain at C-17. *Glucocorticoids* and *mineralocorticoids* have 21 carbon atoms, including a C_{21} of oxygenated side chain at C-17. *Vitamin D₃ (cholecalciferol)* is not a sterol but is derived from 7-dehydrocholesterol in humans:

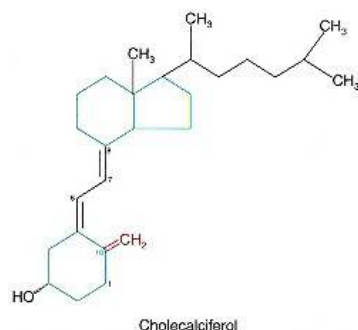

Terpenes are polymers of two or more isoprene units. **Isoprene** is

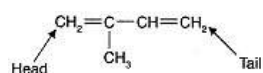

Terpenes may be linear or cyclic, with the isoprenes usually linked head to tail and most double bonds trans (but may be cis as in vitamin A). *Squalene*, the precursor of cholesterol, is a linear terpene of six isoprene units. Fat-soluble *vitamins* (A, D, E, and K) contain isoprene units:

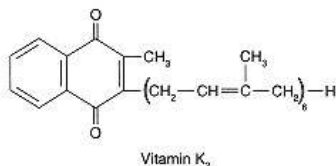
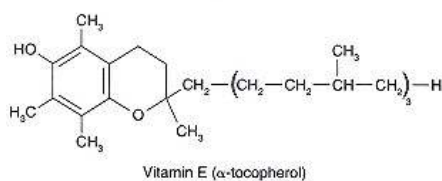
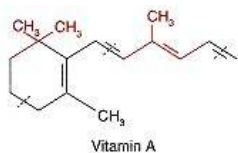

Amino Acids

Amino acids contain both an *amino* (NH_2) and a *carboxylic acid* (COOH) group. Biologically important amino acids are usually α -amino acids with the formula

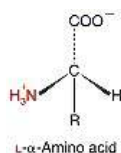

The amino group, with an unshared pair of electrons, is basic, with a $\text{p}K_a$ of about 9.5, and exists primarily as NH_3^+ at pH values near neutrality. The carboxylic acid group ($\text{p}K_a \approx 2.3$) exists primarily as a carboxylate ion. If R is anything but H, the molecule is asymmetric with most naturally occurring ones of the L configuration (same relative configuration as L-glyceraldehyde: see p. 1139).

The *polarity* of amino acids is influenced by their side chains (R groups) (see p. XX for complete structures). *Nonpolar* amino acids include those with large, aliphatic, aromatic, or undissociated sulfur groups (aliphatic = Ala, Ile, Leu, Val; aromatic = Phe, Trp; sulfur = Cys, Met). *Intermediate* polarity amino acids include Gly, Pro, Ser, Thr, and Tyr (undissociated).

Amino acids with ionizable side chains are *polar*. The $\text{p}K$ values of the side groups of arginine, lysine, glutamate, and aspartate are such that these are nearly always charged at physiological pH, whereas the side groups of histidine ($\text{p}K = 6.0$) and cysteine ($\text{p}K = 8.3$) exist as both charged and uncharged species at pH 7.4 (acidic = Glu, Asp, Cys; basic = Lys, Arg, His). Although undissociated cysteine is nonpolar, cysteine in dissociated form is polar.

All amino acids are at least *dibasic acids* because of the presence of both the α -amino and α -carboxyl groups, the ionic state being a function of pH. The presence of another ionizable group will give a tribasic acid as shown for cysteine.

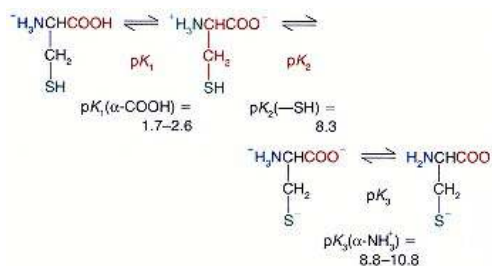

The **zwitterionic form** is the form in which the *net* charge is zero. The *isoelectric point* is the average of the two $\text{p}K$ values involved in the formation of the zwitterionic form. In the above example this would be the average of $\text{p}K_1 + \text{p}K_2$.

Purines and Pyrimidines

Purines and pyrimidines, often called *bases*, are nitrogen-containing heterocyclic compounds with the structures

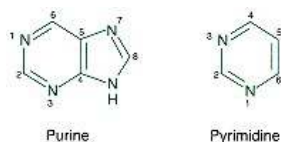

Major bases found in nucleic acids and as cellular nucleotides are the following:

Purines	Pyrimidines
Adenine: 6-amino	Cytosine: 2-oxy, 4-amino
Guanine: 2-amino, 6-oxy	Uracil: 2,4-dioxy
	Thymine: 2,4-dioxy, 5-methyl
Other important bases found primarily as intermediates of synthesis and/or degradation are	
Hypoxanthine: 6-oxy	Orotic acid: 2,4-dioxy, 6-carboxy
Xanthine: 2,6-dioxy	

Oxygenated purines and pyrimidines exist as *tautomeric* structures with the keto form predominating and involved in hydrogen bonding between bases in nucleic acids:

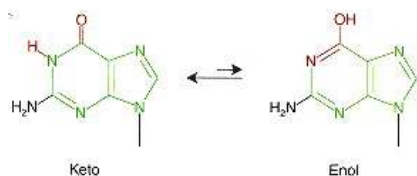

Nucleosides have either β -D-ribose or β -D-2-deoxyribose in an *N*-glycosidic linkage between C-1 of the sugar and N-9 (purine) or N-1 (pyrimidine).

Nucleotides have one or more phosphate groups esterified to the sugar. Phosphates, if more than one are present, are usually attached to each other via phosphoanhydride bonds. Monophosphates may be designated as either the base monophosphate or as an *-ylic acid* (AMP: adenylic acid):

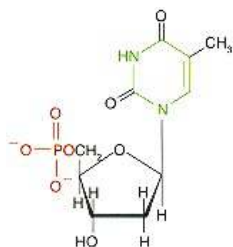

By conventional rules of *nomenclature*, the atoms of the base are numbered 1–9 in purines or 1–6 in pyrimidines and the carbon atoms of the sugar 1–5. A nucleoside with an unmodified name indicates that the sugar is ribose and the phosphate(s) is/are attached at C-5 of the sugar. Deoxy forms are indicated by the prefix d (dAMP = deoxyadenylic acid). If the phosphate is esterified at any position other than 5, it must be so designated [3 -AMP; 3-5 -AMP; (cyclic AMP = cAMP)]. The nucleosides and nucleotides (ribose form) are named as follows:

Base	Nucleoside	Nucleotide
Adenine	Adenosine	AMP, ADP, ATP
Guanine	Guanosine	GMP, GDP, GTP
Hypoxanthine	Inosine	IMP
Xanthine	Xanthosine	XMP
Cytosine	Cytidine	CMP, CDP, CTP
Uracil	Uridine	UMP, UDP, UTP
Thymine	dThymidine	dTMP, dTTP
Orotic acid	Orotidine	OMP

Minor (modified) bases and nucleosides also exist in nucleic acids. *Methylated* bases have a methyl group on an amino group (*N*-methyl guanine), a ring atom (1-methyl adenine), or on an OH group of the sugar (2-*O*-methyl adenine). *Dihydrouracil* has the 5–6 double bond saturated. In *pseudouridine*, the ribose is attached to C-5 rather than to N-1.

In **polynucleotides** (*nucleic acids*), the mononucleotides are joined by phosphodiester bonds between the 3 -OH of one sugar (ribose or deoxyribose) and the 5 -OH of the next (see p. 567 for the structure).

Index

HOW TO USE THIS INDEX. The letter "f" after a page number designates a figure; "t" designates tabular material; "cc" designates a Clinical Correlation **Boldface** page numbers show where terms are explained. "See" cross-references direct the reader to the synonymous term. "See also" cross-references direct the reader to (1) related topics or (2) the synonym under which a more detailed topic breakdown may be found.

A

A band, **948**

A face, **143**

A peptide, **832**, 833

A site, 727

A23187 (calcium ionophore), 212, 212f, 212t

Abetalipoproteinemia, 59cc, 195cc, 380cc, 1082cc

ABP. *See* Androgen binding protein

Absorption of nutrients, 1057, 1058f.

See also Digestion, *specific nutrients*

Abzyme, **164**, 164-165, 165f

ACAT (acyl-CoA:cholesterol acyltransferase), **416**

Acceptor atom, **66**

Acceptor molecule, **80**

Acetaldehyde, 139cc, **280**

Acetals, **1138**

Acetate, **559**

Acetate thiokinase, **227**, **411**

Acetoacetate, **227**, **379**, 379f, 379-380, 388f, 388-389, 389f.

See also Ketone bodies

Acetoacetic acid, 1044

Acetoacetyl CoA, in utilization of ketone bodies, 389

Acetokinase, **411**

Acetone, 380, 388-389.

See also Ketone bodies

Acetyl CoA, **224**, **226**, 226f, 226-231, 231f

in acetoacetate synthesis, 388

in cholesterol synthesis, 410-415

in ketone body formation, 387-390

as source of fatty acids, 366

sources, 227, 231f, 369-370

transfer from mitochondria to cytosol, 369-371

transport, 369-371, 371f

N-Acetyl-5-methoxytryptamine, 476

Acetylcholine, **202**, 904, **1061**, 1061f

in muscle contraction, 954

reactions at synapse, 928, 928f

release, 928

as secretagogue, 1061, 1061t

and stress response, 853, 855f

structure, 202f

synthesis, **928-929**

Acetylcholine receptor(s), **202**, **923**, 954.

See also Nicotinic-acetylcholine channel

Acetylcholinesterase, 928, **928**, 929f

Acetyl-CoA carboxylase, **366**, 366f, 1122

N-Acetylgalactosamine, blood type determined by, 347

N-Acetylglucosamine, 345-346, 353-354, 1141

N-Acetylglucosamine sulfatase deficiency, 352cc

N-Acetylglucosaminidase deficiency, 352cc

N-Acetylglutamate, **454**, 454f, 455

N-Acetylglutamate synthetase, **455**

deficiency, 456cc

Acetylneuraminic acid, **345**, 346, 347f, **426**, 426f, **1142-1143**

N-Acetylserotonin, **866**

N-Acetyltransferase, **866**

Acid(s), 7, 7-12, 1137.

See also Acid-base balance; *specific acid*

acid-base pairs, 8t

-aric, **1141**

biological importance, 7-9

buffering, 10-12

dibasic, 1146

general, **160**

-onic, **1141**

-uronic, **1141**

-ylic, **1147**

Acid anhydrides, **1137**, 1138

Acid-base balance, 32f, 32-33, 1041-1046.

See also Acidosis; Alkalosis, pH

bone in, 1042cc

buffer systems and, 1036-1038

clinical data, evaluation, 1051cc

disorders, 1042, 1043t, 1046-1050

kidneys in, 1043

regulation, 556-559

Acid-base catalysis, 160, 161f

Acid-base pairs, conjugate, 7-10, 8t, **1038**

Acid-base state

compensated, 1046, **1046**, 1047-1049

partially compensated, **1046**

uncompensated, **1046**

Acidosis, 12cc, 380, **556**, **1041**

2,3-bisphosphoglycerate in, 1036, 1036f

metabolic, 390cc, 479cc, **1042**, 1046, 1048, 1048f

blood bicarbonate concentration in, 12cc

renal tubular, 1042

respiratory, **1042**, 1046, 1047, 1047f

chronic, 1048cc

Acid-stable lipase, **1078**

Aciduria, hereditary orotic, 505, 505cc

Aconitase, **233**, **1006**, 1007

cis-Aconitate, 233

Acquired immunodeficiency syndrome. *See* AIDS

ACTH. *See* Adrenocorticotrophic hormone (corticotropin)

Actin, **948**, 948t, **951**

fibrous. *See* F-actin

globular. *See* G-actin

types, 951, 951t

Actin binding site, myosin, 950

Actinin, 948t, 952

Actin-myosin cross-bridges, **953**, 954f

Actin-myosin interaction, 957-959, 958f, 959

Activated glucose, **319**

Activated intermediates, transport, 491

Activation energy (E_a), **159**

Activator site, 152

Active oxygen species, neutralization, **933**

Active site, **129**, 155-158

Active-site direction, **101**

Acute intermittent porphyrin, 1012t, 1013cc

Acute phase reactants, **553**

Acyclovir, **520**, 520f

for herpesvirus infection, **517**

Acyl carrier protein (ACP), **368**

Acyl CoA:dihydroxyacetone phosphate acyltransferase, **408**

Acyl transport, across mitochondrial membrane, 382

Acylated enzyme intermediate, **163**

Acyl-CoA dehydrogenases, **383**

deficiency, 385cc

Acyl-CoA-cholesterol acyltransferase (ACAT), **416**

1-Acylglycerol phosphate acyltransferase, 403

Acylglycerolipids, **397**

Acylglycerols, 363-365, 365f, 1143, 1144

ADA. *See* Adenosine deaminase

ADA-polyethylene glycol (ADA-PEG), 503cc

Adenine, **492**, 679-680

Adenine nucleotide translocator, **245**, 245f

Adenine nucleotides, 492f

Adenosine, 142, 490, 492f

Adenosine deaminase, **501**, 503cc

deficiency, 502

gene therapy, 793cc

Adenosine diphosphate. *See* ADP

Adenosine monophosphate. *See* AMP

Adenosine triphosphate. *See* ATP

Adenosylhomocysteinase, **469**, 470f

S-Adenosylhomocysteine, 405f, **469**

S-Adenosylmethionine, **405**, **469**, **535**, 1124

cysteine synthesis from, 470f

S-Adenosylmethionine

(*continued*)

- in methyltransferase reactions, 471-472, 472f
- in phosphatidylcholine synthesis, 405f
- synthesis, 469f

S-Adenosylmethionine decarboxylase, **460**

Adenovirus DNA, replication, 645, 645f, 658f

Adenylate cyclase, **293, 323, 327, 327f**, 439, 859, 859f, 861f, **1061**

Adenylate kinase, **289, 955-957**

Adenylosuccinate synthetase, **497**

ADH. *See* Antidiuretic hormone

Adipose tissue, 1089

- energy reserves in, 537t
- lipases in, 377
- in starve-feed cycle, 544-545
- white, 375, 376

AdoCys. *See* S-Adenosylhomocysteine

AdoMet. *See* S-Adenosylmethionine

ADP, 219f, 238

ADP-ribosyltransferase, **427**

Adrenal gland, steroid hormone synthesis in, 898, 990, 991f

Adrenal hormones, **894**

Adrenaline. *See* Epinephrine

α -Adrenergic receptor(s), 328

β -Adrenergic receptor(s), **328, 875f**, 875-876, 876f

Adrenocorticotrophic hormone (corticotropin), 842, 846

- actions, 847t, 883t
- in cortisol secretion, 903f, 903t
- source, 847t
- synthesis, 849, 850t

Adrenodoxin, **989**

Adult-onset diabetes, in obesity, **1095**

AE. *See* Anion exchanger

Aerobic exercise, 551-552

Affinity chromatography, 73

Affinity constant (K_a), 137

Age pigment (lipofuscin), **19**

Aggrecan, 356

Agging

- changes that occur in, 547
- mitochondrial mutations and, 617cc
- telomerase activity in, 658cc

Agmatine, **457, 457f**

Agonist, **201**

Agriculture, Department of (USDA), food pyramid, 1102, 1103f

Agriculture, recombinant DNA in, 794-795

Ah receptor, 913, **985**

Ah receptor nuclear translocator, **985**

AIDS, 171, 792-793

- treatment, 661cc

ALA. *See* Aminolevulinic acid

Alamethicin, 212t

Alanine, **25**

- β -Alanine, absorption, 1072
- Alanine cycle, 299-301, 300f, 529-530
- β -Alanylhistidine. *See* Carnosine
- β -Alanylmethylhistidine. *See* Anserine

Albinism, 467cc, **469**

Alcaptonuria, 467cc

Alcohol

- and barbiturates, 281cc
- cytosolic, **387**
- drug-nutrient interactions, 1133t
- effects on liver, 555-556
- energy content of (kcal), 1088
- oxidation, 280

Alcohol dehydrogenase, 129, **154, 280, 555**

- ethanol oxidation by, 129f, 143, 143f
- isoenzymes, with different pH optima, 167cc

Alcoholism

- folate deficiency in, **1125**
- niacin deficiency in, **1121**
- nutritional considerations in, 1120cc
- riboflavin deficiency in, **1121**
- Wernicke-Korsakoff syndrome in, **1120, 1120cc**
- zinc deficiency in, 1131

Alcohols, **1137, 1141**

- primary, 1137
- secondary, 1137
- tertiary, 1137

Aldehyde(s), **1137**

Aldehyde dehydrogenase, **138, 139cc, 280, 387, 555**

- type I, 934t

Alditol, **1141**

Aldohexoses, 1139-1140

Aldolase, reaction catalyzed by, 273f, 275

Aldose reductase, **935**

- and diabetes, 551cc

Aldose-ketose isomerization, **341-342**

Aldosterone, 894, **896**

- excretion pathway, 902t
- functions, 895t
- secretion, 895t, 901, 903t, 904f
- as stress hormone, 905
- structure, 895t
- synthesis, **898, 901-905, 903t, 990**

Aldosterone receptor(s), 894

Alicyclic compound, cholesterol as, 409

Alkaline phosphatase, 1059t

Alkalosis, **558, 1041**

- metabolic, **1042, 1045-1046, 1048-1049, 1051-1052, 1052cc**
- respiratory, **1042, 1046, 1047f, 1047-1048**
 - acute, 1047cc

Alkyl chains, 26f, 363-365

Allele-specific probe, 583cc

Allergy, 440

Allolactose, **806**

Allopurinol, for gout (hyperuricemia), **517**

Allosteric effectors, 491, 497f, **540**

- binding characteristics, 151-152
- changes in, 541f, 545
- control of hepatic metabolism, 541f, 542f
- negative, 153f, 540-541
- positive, 153f, 540-541

Allosteric enzyme(s), 153f

- catalytic subunits, 155, 155f
- K class, **152, 153f**
- polymeric, 153f
- rates, 153
- regulatory subunits, 155, 155f
- sigmoidal kinetics, 152-153
- V class, **152**

Allosteric protein, **807**

Allosteric site, **129, 151**

- vs. substrate binding site, in gout, 152cc

Allosterism, 803

- and cooperativity, 154
- and enzyme activity, 151-155
- hemoglobin and, 1029-1030

Allysine, **54, 54f, 55f, 748**

Alpha (α), conversion factor, **1039**

Alternative transcription initiation sites, **743**

Alternative translation initiation sites, **743**

Alu family, **616, 823**

Amanita phylloides, 691, 692cc

α -Amanitin, 691

American diet, 1132-1133

Amides, **1138**

Amiloride, 1065, 1065f, 1067

Amines, **1138**

- primary, 1138
- secondary, 1138
- tertiary, 1138

Amino acid(s), **1089, 1146**

- abbreviations, 27t
- absolute configuration, 28f
- absorption, 1072-1073
- acid forms, 30-31, 31t
- activation, for protein synthesis, 721-724
- analysis, in diagnosis of disease, 74cc
- aromatic, 25-26, 554
- asymmetric center, 28
- base forms, 30-31, 31t
- basic, **31**
- branched-chain, 453, 476-479, 477f
 - metabolism, diseases, 479cc
- chemistry, 30-39, 39t
- common, 25, **25, 25f**
- degradation, 456-485
- derived, **25, 30**
- disposition in well-fed state, 528f
- epithelial transport, **1072, 1072cc**
- essential, **446, 447t, 1090, 1090-1091**
- free, carrier-mediated transport, 1072-1073
- glucogenic, 304-306, 306t, 1089
- in gluconeogenesis, 530-533
- group translocation, 210
- intermediate polarity, 1146
- interorgan transport, 453, 453f
- ionic form, 32
- ionizable groups, and biological function, 30-39
- ketogenic, 304-305, 306t, 1089
- membrane transport, **209, 1072**
- modification, after incorporation into proteins, 744-746, 745f
- nitrogen incorporation into, 447-452
- nonpolar, 38, 1146
- polar, 38, 1146
- polymerization, 28-29
- residue, **29, 29f**
- separation from proteins based on pI value, 35-36
- sequence homology in serine protease families, 105
- side chains, 25-28, 38, 38f
- structure, 25-28, 26f
- sulfur-containing, 471cc
- synthesis, 456-485
- transport, 209, 211t, 485, 1072

Amino acid metabolism, 445-488

- enzyme deficiency, 465cc
- and ketone bodies, 389f
- by liver, 554
- overview, 446-447, 447f

D-Amino acid oxidase, 156, **452**

L-Amino acid oxidase, **452**, 452*f*

β -Amino acids, 509-511

α -Amino adipic semialdehyde synthase deficiency, 481cc

Amino group transfer, 448, 448*f*

Amino monosaccharide, **1141**

Amino sugar formation, 344-345

Aminoaciduria, 74cc

Amino-acridine, 594cc

Aminoacyl site, 727

Aminoacylation, of transfer RNA, 721-724, 724*f*

Aminoacyl-tRNA synthetase(s), 721, **722**

Aminoacyl-tRNAs, **529**

p-Aminobenzoic acid, 149-150, 150*f*

γ -Aminobutyric acid. *See* GABA

Aminoglycosides, effects on protein synthesis, 733-734, 734*t*

β -Aminoisobutyric acid, **509**

-Aminolevulinate, **236**

-Aminolevulinate synthase, **236**, **1012**, 1017

Aminolevulinic acid, synthesis, 1014*f*

Aminolevulinic acid dehydratase, 1012-1013

Aminolevulinic acid synthase, 1011-1012, 1017

4-Amino-*N*¹⁰-methyl folic acid. *See* Methotrexate

Aminopeptidase(s), **1070**, 1072

Aminopeptidase A, 1059*t*

Aminopeptidase N, 1059*t*

Aminotransferase(s), **131**, 131*f*, **448**, 448*f*, 449-450, 475*f*

Ammonia

- accumulation
 - in liver disease, 554
 - metabolic disorders caused by, 455-456, 456cc
- elimination, 454-455
- excretion, 1044*f*, **1045**
- incorporation, 450-451
- production, 450, 453

AMP, **287**, 287-290, **289**, 491, **494**, 494-497, 496*f*

5 -AMP aminohydrolase, **500**

AMP deaminase, **500**, **501**

Amphipathic molecules, **5**, **183**

Amplification mechanism, in glycogen phosphorylase regulation, 323-324, **324**

α -Amylase, **314**, **1074**, 1075*f*

- pancreatic, **1073**

Amylo- α -1,6-glucosidase, 318

Amylopectin, **1073**, **1142**

- digestion by α -amylase, 1075*f*
- sources, 1074*t*
- structure, 1074*t*

Amylose, 321, **1073**, 1074*t*, **1142**

Amytal, **259**

Anabolic pathways, **218**

Anaerobic exercise, 551-552

Analbuminemia, 380cc

Anaplerotic reactions (anaplerosis), **304**

Androgen(s), 896, 1145

- aromatization, **992**, 993*f*

Androgen binding protein, **908**, 908-909

Androstenedione, **990**

Anemia

- hemolytic, 337, 338cc, **1008**
- iron-deficiency, 1009cc, **1130**
- macrocytic, **1124**
- megaloblastic, 463cc, 1126
- microcytic hypochromic, **1130**
- pernicious, **1125**
- sideroblastic, **1122**
- spur cell, 195cc
- in vitamin A deficiency, **1111**

Anesthesia, and membrane fluidity, 196

ANF. *See* Atrial natriuretic factor

Angina pectoris, 292cc

Angiotensin I, 932*t*

Angiotensin II, 844*t*, **901**, 901-902, 932*t*

- actions, 848*t*, 884*t*
- source, 848*t*

Angiotensin III, 848*t*, 884*t*, 902

Angiotensin receptor, 902, 904*f*

Angiotensinogen, **901**

Anion(s), **5**, 14, 205, 205*f*

Anion channel, erythrocyte, **190**, 191

Anion exchange protein, **204**

Anion exchanger, **1065**, 1065*f*

Anion gap, **1050**

Anion-exchange resins, **70**

Ankyrin, **191**, 191*f*, 191-192

Anomers, **1139**, **1141**

Anserine, **483**, 483*f*, 1072

Anthracycline, 594cc

Anthranilate synthetase, 808

Anti-association factor, **725**

Antibiotic(s)

- absorption, 1073
- for ammonia buildup, 456
- deafness caused by, 734cc
- effects on protein synthesis, 733-735
- resistance to, 670cc
- and RNA polymerase, 691, 692cc
- and vitamin K deficiency, **1117**

Antibiotic ionophores, 212-213

Antibiotic-resistance genes, transposons containing, 816cc, 817

Antibody(ies), 88-97, 89*f*.

- See also* Immunoglobulin(s)
- classes, functions, 92cc
- maternal, transfer to fetus/neonate, 1073
- nicotinic-acetylcholine receptor, in myasthenia gravis, 929cc
- Rh, 1020cc

Anticoagulant drugs, 350cc

Anticodon sequences, 719

Anticodon triplet, **682**

Anticonvulsants

- drug-nutrient interactions, 1133*t*
- and vitamin requirements, 1118cc, 1125

Antidepressants, mechanism of action, 930

Antidiuretic hormone, 848*t*

Antifolates, **518**, 518-519

Antigen(s), **88**

Antimalarials, and hemolytic anemia, 338

Antimetabolites, **149**, 150, 151, 151*f*, **517**, 517-518

Antimycin A, **259**

Antioxidants, **1110**, **1116**, 1127

Antiparallel DNA strands, **574**

Antiport, **200**, 200*f*, 211*t*, 212*t*

- for anion transport, 204*f*, 204-205
- glutamate-aspartate, **303**

Antiporter

- Ca²⁺, Na⁺, 211*t*

Antipyretics, and hemolytic anemia, 338

Antisense nucleic acids, **790**, 790-793

Antisense RNA, **792**

Antisense strand, 692

Antithrombin III, **975**

Antiviral agents, structure, 520*f*

AP endonuclease, **635**

AP site. *See* Apurinic-apyrimidinic site

Apoenzyme, **128**

Apoferitin, **1004**, 1007, 1007*f*

Apolar edge, **54**, 55*f*

Apolipoprotein(s), **56**, 57*t*, 115

- B, **415**, **1082**, 1082cc
- B-100, **416**
- E, **416**
- intestinal, **1082**
- structure, 60*f*

Apoptosis, **19**, **452**, 751, **915**

- in ovarian cycle, 916cc
- steroid hormones and, 915-916

Apparent mineralocorticoid excess syndrome, 911cc

Apurinic-apyrimidinic site, **635**

Aqueous humor, **932**, 933

araC. *See* Cytosine arabinoside

Arachidonic acid, **433**, 1143

- metabolism, 992, 1099cc

Arachidonic acid-specific acyl CoA

- transacylase, **407**

Arginase, **455**

- deficiency, 457cc

Arginine, **27**, 27*f*

- in children, 448
- guanidinium group, 27*f*
- imidazolium group, 27*f*
- synthesis, 455, 457, 534*f*

Arginine vasopressin. *See* Vasopressin

Argininosuccinate, **454**

Argininosuccinate lyase, **455**, 934*t*

- deficiency, 457cc

Argininosuccinate synthetase, **455**

- deficiency, 457cc

Arnt protein, **985**

Aromatic amino acids, 25-26, 554

Aromatization, **992**, 993*f*

Arrestin, 876, **943**, 944*t*

ARS consensus sequence, **656**

Arsenate

- in glycolysis inhibition, 282, 282*f*
- toxicity, 283cc

Arsenic poisoning, 283cc

Arsenite, **228**

Artificial membrane systems, **189**

Aryl hydrocarbon receptor, 913, **985**, **994**

Ascorbate, in iron absorption, **1005**

Ascorbic acid. *See* Vitamin(s), C

L-Ascorbic acid, **344**, 1141

Asians, sensitivity to alcohol, 139cc

Asparaginase, 174, 452, 452*f*

Asparagine, **27**, **350**, 351*f*, 452, 452*f*

Asparagine synthetase-deficient tumors, treatment, 452

Aspartame (NutraSweet), **544**

Aspartate, **27**, 27*f*, 454

Aspartate proteases, **98**

Aspartylglycosylaminuria, 349cc

4-L-Aspartylglycosamine amidohydrolase deficiency, 349cc

Aspirin, 435, 436

effects on vitamin C serum levels, 1127

Assay(s)

biochemical, for assessment of malnutrition, **1108**

coupled, 168-170

for human immunodeficiency virus, 171

Association constant (K_s), 137, 871

Astrocytes, **921**, 931, 931*f*

Ataxia, **1120**

cerebellar, 387cc

spinocerebellar, 602cc

in thiamine deficiency, **1120**

Ataxia telangiectasia, 639cc

Atherogenesis, 471cc

Atherosclerosis, 56, 56cc, 416cc, 417cc, 471cc

ATP, **142**, **220**, **289**

in active mediated transport, 206, 206*f*

as allosteric effector, 142

in carbohydrate metabolism, 281-282

corneal metabolism, 933

as cosubstrate, 142

and energy-producing and energy-utilizing systems, 218-220, 219*f*, 220*f*

expenditure, gluconeogenesis and, 308

hydrolysis, 594

in muscle contraction, 954-957

production, **920**

regulation of 6-phosphofructo-1-kinase by, 287-290

for retina, source, 935-936

role of, 490

source, 17, 551

structure, 219*f*

synthesis, 219, 231, 231*f*, 238

and transmembrane electrical potential in neurons, 921-923

and ubiquitin-dependent protein degradation, 751*f*, 751-752

ATP cycle, in starve-feed cycle, 526, 526*f*

ATP-ADP translocase, **205**, 205*f*, 205-206

ATP-ADP transport, in mammalian cells, 211*t*

ATPase, **206**

Ca²⁺-, **208**, 211*t*

H⁺, K⁺-, **1069**, 1069*f*

Mg²⁺, 146, 146*f*, 959, 959*f*

myosin, 950, 954-957

Na⁺, K⁺-, **206**, 206-207, 207*f*, 211*t*, **1064**

ATP hydrolysis, 207, 207*f*

contraluminal, in NaCl secretion, 1066*f*, 1066-1067

erythrocyte ghost studies, 207-208, 208*f*

inhibition, 207

vacuolar proton pump as, **927**

ATP-citrate lyase, 371

Atractyloside, 205*f*, 205-206

Atrial natriuretic factor

actions, 848*t*, 885-888, 887*f*

source, 848*t*

synthesis, 905

Atrial natriuretic factor receptor, functional domains, 885, 887*f*

Atrial natriuretic factor receptor-guanylate system, **885**

Atrial natriuretic peptide(s), 885-888, 886*f*

Atriopeptin. *See* Atrial natriuretic factor

Atropine, 1061, 1061*f*

Attenuation, 696

Attenuator site, of tryptophan operon, 810*f*, 810-813

AUG codon, 685, **714**, **719**, 727

Autoactivation, **1070**, 1071

Autocrine hormone(s), **841**

Autolysis, **19**, **105**

Autonomously replicating sequence, **656**

Autophagy, 18*f*, **19**

Autophosphorylation, **879**

Autoregulation, of steroid receptors, **915**

Axon, **921**

Azaserine, **519**

Azathioprine, as immunosuppressant, **517**

3 -Azido-3 -deoxythymidine. *See* Azidothymidine

Azidothymidine, **520**

in AIDS treatment, 661 cc

structure, 520*f*

AZI. *See* Azidothymidine

B

B face, **143**

B peptide, **832**, 833

Bacteria

in carbohydrate digestion, **1075**

expression of foreign genes in, 832-835

expression vector, 783, 784*f*

foreign gene expression in, for encoded protein synthesis, 783, 784*f*

infections, diagnosis, 583cc

metabolism, **450**

synthesis of human growth hormone, 834*f*, 834-835

synthesis of human insulin, 832-833, 833*f*

transcription in, 800-802

transformation, with recombinant DNA, 767

transformed

detection, α -complementation for, 772*f*, 772-773

selection, by loss of antibiotic resistance, 770-773, 771*f*

selection techniques, 768

Bacteriophage(s)

as cloning vectors, 778-779, 779*f*

heteroduplex formation in, 584*f*

in site-directed mutagenesis of single nucleotide, 787-790, 789*f*

Bacteriophage λ , 669*f*, **778**, 779*f*

phage library, **779**

Bacteriophage T7 DNA, replication, 659*f*

Bacteriophage X174, 612*f*

Band 3, **204**

Barbiturates, alcohol and, 281cc

Baroreceptor, **881**

Basal metabolic rate, **1088**, 1088-1089, **1131**

Base(s), 7, 7-12, 1146.

See also Acid(s); Purine(s); Pyrimidine(s)

acid-base pairs, 8*t*

chemical modification, 628-629, 629*f*-631*f*

conjugate, **7**, **1038**

hydrophobic qualities, 569

ionized forms, **629**, 631*f*

methylated, 1147

minor (modified), **1147**

nomenclature for, 1147

Base excess, **1049**, 1051cc

negative, 1049-1050, 1050*f*

positive, 1049-1050, 1050*f*

Base excision repair, **635**

Base pairing, 8*t*, 624*f*

between ionized forms of bases, 631*f*

in RNA, 680, 681*f*

wobble rules, 719, 719*t*

Base substitutions, **628**

Base-exchange reaction, 406, 406*f*

BCAA aminotransferase, **477**

BCAAs. *See* Branched-chain amino acids

B-DNA

major grooves, 109*f*

structure, 571*f*, 573*t*

Beads-on-a-string structure, **603**

Becker muscular dystrophy, 821, 822cc

Beer-Lambert relation, **168**

Behenic acid, **421**

Benz[a]pyrene, **993**, 993-994, 995*f*

Benz[a]pyrene-7,8-dihydrodiol-9,10-epoxide, **994**, 995*f*

Beriberi, **1120**

Betaine, **460**, 460*f*

BH₂. *See* Tetrahydrobiopterin

Bicarbonate. *See also* Base excess; pH-bicarbonate diagram

in blood, 1031-1032

conservation, **453**

distribution, between plasma and erythrocytes, 1035-1036

formation, 1032

for lactic acidosis, 291cc

reabsorption of, **1043**, 1044*f*

secretion, in pancreatic juice, 1066

transport, 204*f*, 204-205

Bicarbonate buffer system, 1038-1041

Bidirectional replication, **646-647**, 648*f*

Bifunctional enzyme, **294**

Bile, **1057**

Bile acids, **410**, **1079**, **1145**

and cholesterol, 417-420

conjugated, 1084

detergent action, 1078

enterohepatic circulation of, **1084**, 1084*f*

glycoconjugates, 1079, 1080*t*, **1084**

metabolism, 1083*f*, 1083-1084

micelles, 1078-1082, **1079**

primary, **1083**

secondary, **1083**

significant, 20

solubility in aqueous solutions, 1079, 1079*f*

structure, 418*f*

synthesis, 410

tauroconjugates, 1079, 1080*t*, **1084**

unconjugated, 1080*t*, 1084

Bile salts, **1079**

deficiency, 1112cc

Bilirubin, **1018**

conjugated, serum, elevation, 1021cc

conjugation, 1018-1019

detoxification, **272**

direct, **1018**

excretion, 346cc

formation, from heme, 1017, 1017*f*

indirect, **1019**

toxicity, 1018

transport, in plasma, 1018-1019

unconjugated, 1018-1019

- Bilirubin diglucuronide, **1018**, 1018-1019, 1019*f*
- Bilirubin UDP-glucuronosyltransferase
 deficiency, 1020cc
 isoenzymes, 1020cc
- Biliverdin IX, **1017**
- Biliverdin reductase, **1017**
- Bimolecular leaf, **189**
- Binding site, asymmetry, 158
- Biochemical assays, in malnutrition, **1108**
- Bioenergetics, 217-266
- Biogenic amines, 853, **1061**
- Biological fluids, 7
- Biopterin, **464-465**, 465*f*
 deficiency, 465cc
- Biotin, 211*t*, **1122**
- 1,3-Bisphosphoglycerate, **225**
- 2,3-Bisphosphoglycerate, **277**, 278*f*, **1029**, 1029*f*, 1034-1036, 1036*f*
- 2,3-Bisphosphoglycerate mutase, **1036**
- 4,5-Bisphosphoinositol glycerophospholipids, **182**
- Blindness, 936cc
- Blood
 acetone in, 389
 bicarbonate concentration, in metabolic acidosis, 12cc
 bicarbonate in, 1031-1032
 buffering line of, **1040**, 1041*f*, 1049-1050, 1050*f*
 carbon dioxide in, forms, 1031-1032
 clearance of drugs from, 134
 clot dissolution, 960
 clotting. *See* Blood coagulation
 enzymes, short half-life, 174
 gas concentration in, respiratory anatomy and, 1027
 properties, in humans at rest, 1032, 1033*t*
 steroid hormone transport in, 908-909
- Blood coagulation, 91cc, 436, **960**
 amplification factor and, 963
 autocatalytic action, 963
 calcium in, **1128**
 clot dissolution, 960-961, 961*t*, 975*f*, 975-976.
See also Fibrinolysis
 control, allosteric role of thrombin in, 974*f*, 974-975
 extrinsic (tissue factor) pathway, 960-961, 961*t*, 963*f*, 963-964, 974*f*, 974-975
 factors, 103*f*, 960-961, 961*t*
 and heparin therapy, 350cc
 intrinsic (contact) pathway, 960-961, 961*t*, 961-963, 962*f*
 defects, 963cc
 mechanism, 960-976
 as membrane-mediated process, 960-961
 and plasmin, **172**
 platelets in, 966, 967, 968*f*
 proteins, properties of, 968-969
 signal amplification in, 920
 and streptokinase, **172**
 and tissue plasminogen activator, **172**
- Blood gases, in humans at rest, 1032, 1033*t*
- Blood groups, sugars determining, 347, 348cc
- Blood pressure, **436**, 1129
- Blood-brain barrier, **920**, **921**
- Bloom syndrome, 639cc
- Blue pigment, 937
- BMI. *See* Body mass index
- Body fluids, 537*t*, 1036-1037, 1037*f*
- Body mass index, 378cc
- Body surface area, and energy expenditure, 1088
- Bohr effect, **123**, 123-124, **1031**, 1034, 1035
- Bombesin, 848*t*
- Bone
 in acid-base homeostasis, 1042cc
 demineralization, 1114, 1131
- Bongkreic acid, 205*f*, 205-206
- Boron, **1132**
- Botulinum toxin, binding to vesicle-associated membrane protein, 927
- BPG. *See* 2,3-Bisphosphoglycerate
- BPG mutase, **1036**
- BPG shunt, 278*f*
- Bradykinin, 848*t*
- Brain, **920**
 carbohydrate metabolism in, 269-270, 272
 complex lipids in, **921**
 composition, 920, 921
 energy source for, **920**
 gangliosides in, 426
 protein turnover rate, **921**
- Branch migration, **664**, **667**
- Branched-chain acids, **364**
- Branched-chain amino acids, **226**, 453, 476-479, 477*f*
 metabolism, diseases, 479cc
- Branched-chain α -keto acid dehydrogenase, **544**
- Branching enzyme, **319**, 320*f*
- Breast milk, micronutrients in, 1117cc
- Brevican, 356
- Bronchopulmonary dysplasia, 399
- Brush border, **1059**
 transport systems, **1073**
- Buffering (buffers), **10**, 10-12, 11*f*, 12cc
 acid dissociation constants, 1037, 1037*t*
 bicarbonate, in metabolic acidosis, 12cc
 capacity, **10**
 carbon dioxide-bicarbonate system, 1038-1041
 of cells, 1036-1038
 hemoglobin, **1033**, 1033-1034, 1041, 1041*f*
 hydrogen ion, **1043**, 1044*f*
 of interstitial fluid, 1036-1038
 of metabolic acids, 1038, 1038*t*
 of plasma, 1036-1038
 problems with, 11*f*
 in urine, 1044
- Buffering line of blood, **1040**, 1041*f*, 1049-1050, 1050*f*
- α -Bungarotoxin, **203**
- Burn(s), metabolic effects, 553
- Buthionine sulfoximine, **485**, 485*f*
- Butyrate, **559**
- C**
- C peptide, 743
- C regions, **91**
- Ca²⁺. *See* Calcium
- CAAT box, **699**
- Cachexia, **453**
 cancer, 553cc
- Caffeine, 688-689, 689*f*
- Cahn-Ingold-Prelog system, 1140
- Calbindin, 1114
- Calciferol. *See* Vitamin(s), D₂
- Calcitonin, 849*t*
- Calcitriol. *See* 1- α ,25-Dihydroxycholecalciferol
- Calcium, **1128**
 in aldosterone secretion, 902-904
 binding to calmodulin, 323
 in blood coagulation, 968-969
 and blood pressure, 1129
 deficiency, **1128**
 dietary requirements, and protein intake, 1094
 in glycogenolysis, 328-329, 329*f*
 and hepatic glycogenolysis, 328, 328*f*
 homeostasis, vitamin D in, 1112-1114, 1115*f*
 intracellular, **996**
 as intracellular messengers, **208**
 and membrane fluidity, **195**
 metabolism, 1112-1114, 1115*f*
 in renal osteodystrophy, 1113cc
 in muscle contraction, 954
 and osteoporosis, 1128-1129
 physiological roles, 1128-1129
 primary active transport, 208-209
 in regulation of smooth muscle contraction, 959, 959*f*
 release, from intracellular stores, 862-865, 865*f*
 requirements, **1128**
 as second messenger, **208**, 323
 in steroid synthesis, **896**, 901
 transport, in mammalian cells, 211*t*
- Calcium fluxes, 440
- Calcium ionophore, 212, 212*f*, 212*t*
- Calcium-binding proteins, helix-loop-helix motif, 209, 209*f*
- Calcium-calmodulin complex, 208-209, 209*f*, **926**
- Calcium-calmodulin kinase I/II, **925**
- Calmodulin, **155**, **208**, **323**, **996**
 calcium binding, 208-209, 209*f*
- Calmodulin-like proteins, 950
- Caloric homeostasis, 536-538, **537**
- Calories, 222, **1088**
- CaM kinase. *See* Calcium-calmodulin kinase
- cAMP. *See* Cyclic adenosine monophosphate, **224**, **293**, 490, 540
 and catabolite repression, 807
 control of *lacP* by, 807, 808*f*
 in glycogenolysis, 328-329, 329*f*
 intracellular levels of, increase in, 295
 in protein kinase A activation, 294*f*, 294-295, 862, 862*f*
 in steroid hormone synthesis, **896**
 structure, 293*f*
- cAMP phosphodiesterase, **295**
- cAMP receptor protein, 807
- cAMP response element-binding protein, **312**
- cAMP-dependent protein kinase, **925**.
See also Protein kinase A
- cAMP-response element, **312**
- Camptothecin, 594cc
- Cancer
 colon, 602cc
 diagnosis, 583
 DNA mutation and, 633cc
 mismatch DNA repair and, 641cc
 prevention, **1127**

Cancer

(continued)

- risk, 1097, 1110
- telomerase activity in, 658cc
- treatment, DNA amplification and, 671cc

Cancer cachexia, 553cc

CAP-binding protein, 805*f*, 806-807Capillary electrophoresis, 70-71, 71*f*Capillary fragility, **1127**Carbamation, 1032-1033, 1033*f*Carbamino groups, **1032**Carbaminohemoglobin, 1031, **1032**, 1032-1033, 1033*f*Carbamoyl phosphate, **454**, 454*f*

Carbamoyl phosphate synthetase

- deficiency, 456cc
- I, **454**, **505**
- II, **454**, **505**, **506**, 506*f*

Carbohydrate(s), **1139**.

- See also* Carbohydrate metabolism; Sugar(s)
- complex, biosynthesis, 346-348
- energy content of (kcal), 1088
- in glycoproteins, 348-349
- linkages
 - with glycoproteins, 349-350
 - with protein, 61, 61*f*
- of membranes, 187, 187*f*
- oxidation states, comparison with lipids, 222, 222*f*
- sleep-inducing effect, 476

Carbohydrate, dietary, 1056-1057, 1074*t*, 1095

- absorption, 1073-1076, 1075*f*
- contribution to daily nutrient supply, 1056, 1056*t*
- digestion, 1073-1076, 1075*f*
- intake, 1056*t*
 - and athletic endurance, 1096cc
 - and diabetes mellitus, 1096cc
 - and glycogen stores, 1095, 1096cc
 - and protein sparing, 1091
 - and serum triacylglycerols, 1100, 1100cc
- metabolic fate, 1095
- refined, intake, 1100

Carbohydrate intolerance, **1095**.*See also* Diabetes mellitus

Carbohydrate loading, 551

- and athletic endurance, 1096cc

Carbohydrate metabolism

- clinical correlations
 - aspartylglycosylaminuria, 349
 - blood group substances, 348
 - fructose intolerance, 342
 - galactosemia, 343
 - hemolytic anemia, 338
 - heparin as anticoagulant, 350
 - jaundice, 346
 - mucopolysaccharidoses, 352
 - pentosuria, 345
- and ketone bodies, 389*f*
- major pathways, 267-333
- special pathways, 335-359

Carbon, 1139, 1140

 α -Carbon atom, **25**, 93*f*

Carbon dioxide

- in blood, forms, 1031-1032
- isohydric carriage of, **1034**, 1034*f*, 1034-1035
- partial pressure, 1026, 1027*t*
- total, **1032**
- total plasma, **1049**
- transport, 1026, 1031-1035, 1034*t*

Carbon dioxide-bicarbonate buffer system, 1038-1041, 1039cc

Carbon monoxide, 1017, **1017**

Carbon monoxide difference spectrum, 986

Carbonic acid, **8**, 8-9, 1039Carbonic anhydrase, **144**, **302**, **1032**Carbonylcyanide-*p*-trifluoromethoxy phenylhydrazone, 260-261 γ -Carboxyglutamic acid (Gla), **103**, 103*f*, **1116**, 1116-1117 γ -Carboxyglutamyl protein(s), 961*t*, 963, 968-969, 969*f*, 971-972, 972*f*

Carboxyl groups, 363-365

Carboxylation, 1122

- prothrombin, **1116**, 1116-1117

Carboxylic acids, **1137**Carboxypeptidase(s), **144**, **1070**

- A, 156, **1071**, 1071*t*, **1072**
- B, **1071**, 1071*t*, **1072**
- pancreatic, **1071**, 1072

Carcinogen, **994**

Carcinogenesis, transcription factors and, 701cc

Cardiac enzymes, release after myocardial infarction, 167*f*Cardiolipin, **398**, 398*f*.*See also* Phosphatidylglycerol phosphoglycerideCardiotonic steroids, **207**Carnitine, **535**

- in acyl group transport, 382
- source, 535, 536*f*
- synthesis, 481, 482*f*
- transport, deficiency, 384cc

Carnitine palmitoyltransferase

- deficiency, 384cc
- I and II, 382

Carnosine, **483**, 483*f*, 1072 β -Carotene, **938**, 939*f*, 1110, **1110**Carotenoids, **1109**, 1109-1110

Carrier-mediated transport, 1072-1073, 1076

Catabolic pathways, **218**

- defects in, 427-431

Catabolic response, **1092**

- protein and energy requirements in, 1092, 1093cc, 1094

Catabolite activator protein, **807**Catabolite repression, 807, 807*f*Catalase, 19, **131**, **251**, 390

Catalysis

- acid-base, 160
- covalent, in active site of chymotrypsin, 162*f*
- environmental parameters, 165-166
- mechanism, 159-166
- temperature dependence, 165-166, 166*f*

Catalyst, **128**Catalytic antibody, 165*f*Catalytic constant, **136**

Catalytic subunits, and regulatory subunits, 155

Catalytic triad, of acetylcholinesterase, 928

Cataracts, **934**, 934-935

- diabetic, **935**
- senile, **935**

Catechol oxygenase, **130**, 130*f*Catecholamines, **553**.

- See also* Epinephrine
- activation of pyruvate dehydrogenase, in cardiac tissue, 231
- degradation pathways, 930, 930*f*
- as neurotransmitters, **929**, 930*f*
- synthesis, 466, 466*f*, 468, 929-930

Catechol-*O*-methyltransferase, **930**Catenation, **594**Cation(s), **5**, 14Cation-exchange resins, **70**CBG. *See* Corticosteroid-binding globulin

CD44, 356

CDKs. *See* Cyclin-dependent kinasescDNA. *See* Complementary DNACDP-choline, biosynthesis, from choline, 404*f*CDP-ethanolamine, in phosphatidylethanolamine synthesis, 405*f*CDRs. *See* Complementarity-determining regions

Celiac disease, 463cc

Cell(s)

- animal, structure, 13*f*
- buffering (buffers) of, 1036-1038
- and cellular compartments, 2-4
- cellular environment, 4-12
- chemical composition, 4*t*, 13-15
- coincidental alterations in, **513**
- cycle, **511**, 512*f*
- cytoskeleton, 19-20
- distribution of nucleotides, 491
- division, and nucleotide-metabolizing enzymes, 511-513
- eukaryotic, 1-22, 608
- fluid, chemical constituents, 14*t*
- growth, inhibition, 520
- membrane, **12**
- metabolism, *de novo* pathways, 517-518
- plasma membrane, 16
- rapidly dividing, glutamine catabolism in, 532
- regulation, and hormone secretion, 859-866

Cell death, planned (programmed), **452**.*See also* Apoptosis

Cellobiose, structure, 1142

Cellulose, **1056**, **1097**, 1098*t*, **1142**

Central dogma, of molecular biology, 678

Central nervous system, 426-427, 921.

See also BrainCentromere, **603**

Cephalin(s), 1144.

See also PhosphatidylethanolamineCeramic trihexoside, **425**Ceramide(s), **184**, 184*f*, 421, 421*f*, 422, 422*f*, 1144

Ceramide oligosaccharides, 1145

Cerebellar ataxia, 387cc

Cerebrocan, 356

Cerebrosides, **184**, 184-185, 422-425, 1145Ceruloplasmin, **1008**

- deficiency, 1008cc

cGMP, 942

- role of, 490
- structure, 885, 885*f*
- synthesis, 885

cGMP-activated channel, in phototransduction, 944*t*

Channels

- membrane, **197**, 197*t*, 197-198, 201-204.
- See also* Membrane transport

- functions, 201, 201*f*
- ionophores and, 212, 212*t*
- regulation, 201-203, 202cc
- structure, 201, 201*f*
- voltage-gated, **201, 921, 922**, 923
 - disorders, 956cc-957cc
- Chaperone protein(s), **63**, 1011
- Chaperonins, **63**, 64*f*
- Cheilitis, **1118**
- Chelates, **144**, 145
- Chelation, modes, 145
- Chemical reactions. *See* Reaction(s)
- Chemical synapses, **923**
- Chemical-coupling hypothesis, 261-263
- Chemiosmotic-coupling mechanism, **262**, 262-263, 263*f*
- Chemotaxis, mediation, 439
- Chemotherapeutic agents, 517-521
- Chemotherapy, DNA repair and, 639cc
- Chenic acid. *See* Chenodeoxycholic acid
- Chenodeoxycholic acid, **418**, 1080*r*, **1083**
- Chi form, **664**
- Chi sites, **612**
- Children
 - nitrogen balance in, 448
 - urea synthesis in, 454
- Chiral compounds, 158
- Chloramphenicol, effects on protein synthesis, 734-735
- Chloride
 - in acid-base imbalance, 1050-1052
 - transport, 204*f*, 204-205
- Chloride channels
 - in cystic fibrosis, 201, 202cc, 1067cc.
 - See also* Cystic fibrosis transmembrane conductance regulator
 - intestinal epithelial, 1066
- Chloride shift, **1035**, 1035*f*
- p*-Chloromercuribenzoate, **149**
- Cholanic acid, 418, 418*f*
- Cholecalciferol. *See* Vitamin(s), D₃
- Cholecystokinin, **1062**, **1071**
 - actions, 848*t*
 - as secretagogue, 1061*t*, 1062
 - source, 848*t*
 - structure, 1062, 1062*t*
- Cholera, treatment, 1068cc
 - toxin, 1068cc
- Cholesterol, **186**, **1145**
 - in bile, 409-420
 - and bile acids, 418
 - and bile salts, 410
 - disposal, by liver, 415
 - distribution, in body, 409-420
 - elimination, 417
 - estimation, by Liebermann-Burchard reaction, 409
 - excretion, 410, 417-420
 - feedback inhibition of HMG CoA reductase, 415*f*
 - formation, from farnesyl pyrophosphate, 413-415
 - intake, and serum level, 1098-1100, 1099cc
 - and membrane fluidity, **195**, 195cc
 - in membranes, 186, 410
 - in mixed micelles, 1079, 1081cc
 - plasma/serum levels, 409-420
 - diet and, 1098-1100, 1099cc
 - elevated, **416**
 - esterified, 417
 - tests for, 409
 - vegetarian diets and, 1100
 - side chain cleavage, 896, **990**, 991*f*
 - in steroid hormone synthesis, 410, **894**, 896-901, 899*f*, 900*f*
 - structure, 186, 186*f*, 894*f*
 - synthesis, 410-415, 415*f*, 415-417, 1098
- Cholesterol (5-cholester)-3β-ol, structure, 409*f*
- Cholesterol esters, **409**, 409*f*
- Cholesterol ester-storage disease, 19cc
- Cholesterol gallstones, 1081cc
- Cholestyramine, 416cc
 - drug-nutrient interactions, 1133*t*
- Cholic acid, **418**, 1079*f*, **1083**
 - acidity, effect of conjugation on, 1080*t*
 - structure, 1145
 - transport, in mammalian cells, 211*t*
- Choline, 404*f*, **460**, 460*f*, 1123
- Choline acetyltransferase, **928**
- Choline glycerophospholipid. *See* Phosphatidylcholine
- Choline phosphotransferase reaction, 404*f*
- Choline plasmalogen, 183, 183*f*, 408*f*
- Chondroitin sulfate(s), 354, 355*f*, 356-357
- Chorionic gonadotropin, 847*t*, 870
- Chorionic somatomammotropin, **829**
- Chromaffin granules, **853**
- Chromatin, **16**, **601**, 604, 697
- Chromatosomes, **605**, 605*f*, **607**
- Chromium, **1132**
 - deficiency, **1132**
 - recommended dietary allowances, 1132
- Chromophores, **79**, 79*f*
- Chromosome(s), **601**
 - folded, 609*f*
 - lampbrush, **607**
 - linear, DNA replication at end, 657*f*, 657-660, 658cc
 - polynucleosomes and, 604*f*
 - polytene, **607**
- Chromosome 11, 826
- Chromosome 16, 826
- Chromosome walking, **781**, 781-783, 782*f*
- Chronotropic control, of hormone secretion, 866
- Chylomicrons, **56**, 379, 528, 529, **1082**, 1082-1083
- Chymotrypsin, **75**, 79*f*, 100*t*, 162*f*, 1071, 1071*t*
 - α-Chymotrypsin, 79*f*, 100*t*
- Circular dichroism (CD) spectroscopy, **80.**, 80-81, 81*f*
- Circular DNA, 586, **586**, 587-595
- Cirrhosis, **554**
- Cisternae, **16**
- Citrate, **232**, 234*f*, 244-245, 245*f*, 292
- Citrate synthase, 232, **232**, 232-233, **237**, **306**
- Citric acid cycle. *See* Tricarboxylic acid cycle
- Citrulline, **454**, 455, 534
- Clathrin, **416**, **877**, 877*f*, 877-878
- Cl⁻/HCO₃⁻ exchanger, **204**, **1065**, 1069
- Cloning vector(s), 766
- Closed complex, **695**
- Clotting factors, activation, **1116**
- Cloverleaf, transfer RNA, 682*f*, 683
- CMP-*N*-Acetylneuraminic acid, biosynthesis, 346, 347*f*
- CNS. *See* Central nervous system
- CoA. *See* Coenzyme A
- Coagulation. *See* Blood coagulation
- Coated pits, **877**
- Coated vesicles, **877**, 877*f*
- Cobalamine. *See* Vitamin(s), B₁₂
- Cobalt, in vitamin B₁₂, 1125
- Cobratoxin, **203**
- Cockayne's syndrome (CS), 638cc
- Codon(s), deletion, in cystic fibrosis, 752cc
- Codon-anticodon interactions, 719*f*, 719-721
- Codons
 - in mRNA, 718*t*, 718-719
 - nonsense, **719**
 - nonuniversal usage, 719, 719*t*
 - termination, **719**
 - disorders of, 722cc
 - universal usage, 719
- Coenzyme A, 228*t*, 514-515, 515*f*
- Coenzyme binding-site, mutations, disease caused by, 142
- Coenzyme Q, **253**, 253-255, 255*f*
- Coenzymes, **142**
 - binding, in cystathioninuria, 142cc
 - components, 491
 - derived from B vitamins, 142
 - structure and function, 142-147
- Cofactors, **128**
- Cognate receptors, **840**
- Colestipol, 416cc
- Colicin E3, effects on protein synthesis, 735
- Colipase, **1078**
- Colitis, 559
- Collagen
 - amino acid composition, 50*f*, 50-51, 51*t*
 - chicken, 821
 - covalent cross-link formation, 54, 54*f*, 55*f*
 - distribution in humans, 50
 - and elastin, comparison, 51*t*
 - glycine requirement, 53*f*
 - maturational, 747-748
 - structure, 52-54, 746, 747*f*
 - disorders of, 748*t*
 - synthesis
 - abnormal, 50cc
 - defects, 748*t*, 749cc
 - posttranslational modifications in, 746-748
 - types, 52*t*, 746
- Colon
 - cancer, 602cc
 - energy salvage by, 559
- Color blindness, 945
- Color vision, **944**, 944-945
- Committed step, regulation, **174**
- Common cold, 1127-1128
- Compartmentation of enzymes, **174**
- Compensated acid-base state, **1046**
- Competitive inhibition, 148
- Competitive inhibitors, **148**
- Complement pathway, classical, 91cc
- Complement proteins, 91cc
- Complementarity-determining regions (CDRs), **90**
- Complementary DNA, **777**, **824**
 - globin, cloning, 824-827, 825*f*
 - library, 777-778, 824
 - modification, for cloning, 778, 778*f*

Complementary DNA

*(continued)*synthesis, 777*f*, 777-778using reverse transcriptase PCR, 778, 779*f*Complementary strands, and DNA replication, 642-649, 643*f* α -Complementation, 772, 772*f*, 772-773Complex lipids, in brain, **921**Composite transposons (Tn), **670**Concatemers, **652**Concatenated chromosomes, **652**Cones, **936**, 937*f*, 937-943

in color vision, 944-945

physicochemical properties, 945-946

types, 944

Conformational-coupling hypothesis, **262**Confusion, in thiamine deficiency, **1120**Conjugase, **1123**Conjugate acids and bases, 7-10, 8*t*, **1038**

Connective tissue disease, autoimmunity in, 706cc

Connexin, **203**Consensus sequence, 690, 690*f*

Conservation of energy, in biochemical systems, 220

Conservative site-specific recombination, **662**

Control elements, 801

Convergent evolution, **106**Cooperative hydrogen bonding, **576**Cooperativity, **154**

and allostery, 154

models, 154, 154*f*, 155*f*Cooperativity index, **119**, 119*t*

Copper

absorption, 1131

in activation of molecular oxygen, 147, 147*f*

as cofactor, 1131-1132

deficiency, **1131**, 1132

recommended dietary allowances, 1131

requirements, 1131

Copper metalloenzymes, 1131

Coprotoporphyrinogen oxidase, 1015-1016

Coprotoporphyrinogens, **1011**

Core enzyme, 691

Corepressor, 808, 809

Corepressors, **802**Cori cycle, 299-301, 300*f*, 529, **529**

Cori's disease, 317cc

Cornea, 270, **932**, 933

Corpus luteum, 868-870, 896-898, 906, 916cc

Corticosteroid(s), 435, 1127, 1133*t*Corticosteroid-binding globulin, **908**

Corticotropin-like intermediary peptide, 846

actions, 847*t*source, 847*t*synthesis, 849, 850*t*Corticotropin-releasing hormone, 842, 844*t*actions, 847*t*, 883*t*source, 847*t*structure, 857*t*Cortisol, 842, 894, **896**

actions, 905

excretion pathway, 902*t*functions, 895*t*

and human growth hormone gene expression, 830

secretion, 895*t*structure, 895*t*synthesis, **898**, 903*t*

Cortisol receptor(s), 894

COS cells, foreign gene expression in, 786, 786*f*cos sites, **779**

Cosmid vectors, 780-781

Cot-a-half value, **580**, 581*f*Cotransfection, **785**

Cotransporter(s)

Na⁺,K⁺-2Cl⁻, **1066**Na⁺-monosaccharide, **1076**

Coupled assays, 168-170

Covalent bond, bond strength, 65*t*Covalent catalysis, 162, **163**Covalent modification, **294**, **541**, 541-545C-peptide, **39**, 40*f*C-protein, 948*t*CPT. *See* Carnitine palmitoyltransferaseCreatine, 483, **483**, 534*f*, 535

Creatine (phospho)kinase, 146, 955-957

reactions, **225**, 225*f*types, **172**Creatine phosphate, **225**, 225*f*Creatinine, **483**, 484*f*, **535**

Crigler-Najjar syndrome, 346cc, 1020cc

Cristae, **17**Critical micelle concentration, **187**, **1079**, 1079*f*Cross-linked polyacrylamide, **72**

Cross-links, allysine-generated, 54

Crossover theorem, **287**, 287-290, 288*f*Cross-regulation of enzymes, **175**, 175*f*Cross-stranded intermediate, **663**Crown gall plasmids, **794**CRP. *See* cAMP receptor proteinCrystallins, **933**, 934*t*CTP, 219*f*, 220, 505*f*CTP cyclohydrolase I, **500**CTP synthetase, **505**, 505*f*, 506*f*

Cushing's disease, 378cc

Cushing's syndrome, and obesity, 526cc

Cutis laxa, 748*t*

Cyanide

detoxification, 474*f*

poisoning, 259cc

Cyanogen bromide, **75**

Cyanosis, 1028cc

Cyclic AMP. *See* cAMPCyclic control system, **294**, 295*f*Cyclic GMP. *See* cGMPCyclic hemiacetals, **1140**Cyclin(s), **657**, **751**Cyclin-dependent kinases (CDKs), **657**Cyclooxygenase, **431**, 433*f*, 433-435, **434**Cyclopentanoperhydrophenanthrene, **894**Cyclopentanoperhydrophenanthrene ring, 409*f*CYP, **982**Cystathionase, **470**

catalytic reaction, 142cc

lack, 471cc

reactions catalyzed by, 474

Cystathionine synthase, **470**

deficiency, 471cc

Cystathioninuria, 471cc

Cysteic acids, formation, by oxidation of disulfide bonds, 74*f*Cysteine, **27**

in children, 448

synthesis, 469, 470*f*, 473*f*, 473-474Cysteine proteases, **98**Cysteinesulfinate, **473**, 473*f*Cystic fibrosis, 202cc, **751**, 752cc, 1067cc

chloride channel in, 201, 202cc

nutritional considerations for, 1112cc

Cystic fibrosis transmembrane conductance regulator, 752cc, 1067cc

activation, 1068cc

Cystine aminopeptidase, **858**Cystine, 30, 30*f*

Cystinosis, 471cc

Cystinuria, 212cc, 471cc

Cytochalasin B, 1077*f*, 1077*t*Cytochrome(s), **147**, 252-253*b*₅, **372**, **988***c*, 69*f*, 253*f*, 254*f*Cytochrome *c* oxidase, **129**, 129*f*, **255**, 257*f*, 1131Cytochrome P450, **17**, 981-999, **982**carbon monoxide-bound, absorbance spectrum, 982, 982*f*

cross-reactivity, 986

CYP11B1, **992**CYP11B2, **992**CYP17, **992**CYP21, **991**

CYP21A2, deficiency, 992cc

distribution, 982

in eicosanoid oxygenation, 990-992

electron transport systems, 987-989

exogenous lipophilic substrates, oxidation, 992-995

forms of, 984-986

gene subfamilies, **982**gene superfamily, **985**

genes, 984-986

human, forms, 982, 983*t*induction, **985**, 985-986

drugs and, 986cc

posttranscriptional mechanisms, **985**, 985-986transcriptional mechanisms, **985**, 985-986

inhibitors, 986-987

mitochondrial, **989**, 989*f*

nomenclature, 982-984

physiological functions, 989-995

polymorphisms, 986, 987cc

protoporphyrin IX prosthetic group, **983**, 983*f*reaction catalyzed by, 982, 989, 990*f*sequence of reactions at, 984, 984*f*

in steroid synthesis, 896, 898, 990-992

structural homology, 986

substrate specificity, **985**

substrates, 982

Cytochrome P450 steroid 21-hydroxylase deficiency, 992cc

Cytoglutamic acid, **857**

Cytomegalovirus, human, in expression vector, 785

Cytoplasm, **16**Cytosine, **493**, **628**, 679-680Cytosine arabinoside (araC), 517*f*, **518**, 518*f*Cytoskeleton, **19**, 19-20Cytosol, **20**, 371*f*, 382*f*

D

- DAM methylase, **565, 639, 649**
- DCLHb. *See* Hemoglobin, diaspirin cross-linked
- dCMP deaminase, **509, 509f**
- ddNTP. *See* Dideoxynucleoside triphosphate
- Deacetylases, **356**
- Deafness, antibiotic-induced, 734cc
- Deamination, **226**
- Deamination of cytosine, **628**
- Debranching enzyme, **317-318, 318f**
- Decarboxylase(s), **132**
- Decarboxylation, **344**
- Decoding region, 727
- Degenerative diseases, mitochondrial mutations and, 617cc
- Dehydratase(s), **132**
- Dehydrocholesterol, **420**
- 7-Dehydrocholesterol, photochemical conversion, 419f
- Dehydroepiandrosterone, **896, 992**
- functions, 895f
 - secretion, 895f
 - structure, 895f
 - synthesis, **898**
- Dehydrogenase(s), **129**
- 3 β -ol-Dehydrogenase, **896**
- Dehydrogenation, 336-338, 337f, **381**
- Deletion mutation, 786-787, 788f
- DEM methylase, **565**
- Denaturation, 68f, 577-580, **578, 579f**
- Dendrites, **921**
- Densitometer scans, 173f
- Deoxyadenosine, structure, 492f
- Deoxycholate, **1083**
- Deoxycholic acid, 211f, 1080f, **1083**
- 1-Deoxycorticosterone, **991, 991-992**
- 2-Deoxyglucose, **282, 282f**
- Deoxyhemoglobin
- salt bridges between subunits in, 122f
 - steric hindrance between proximal histidine and porphyrin in, 120f
 - transition to oxyhemoglobin, 122f
- Deoxyhexoses, **344**
- Deoxymonosaccharide, **1141**
- Deoxynucleoside triphosphate, **763, 763f**
- Deoxyribonucleotides, 491, **507, 507-511, 509f**
- Deoxyribopyrimidine nucleosides, 509
- Deoxythymidylate, synthesis, 508-509, 519f, 1123
- Deoxyuridine monophosphate, 508
- Depurination, **629, 635**
- Derepression, 808
- Dermatan sulfate, **354**
- Dermatitis, **1118**
- Desaturase, **372**
- ⁹-Desaturase, 1131
- Desmosine, **55, 55f**
- Detergents, biological, **1077, 1078**.
- See also* Bile acids
- Deuteranopia, **945**
- Dextrins, α -limit, **1075**
- DFP. *See* Diisopropylfluorophosphate
- DHAP, in choline plasmalogen biosynthesis, 408f
- DHEA. *See* Dehydroepiandrosterone
- Diabetes mellitus, 41cc, 62cc, 287cc, 362, **1095**
- adult-onset, in obesity, **1095**
 - complications, 537, 537cc, 551cc
 - dietary treatment, 1096cc
 - and hyperglycemic hyperosmolar coma, 537cc
 - insulin-dependent (IDDM), 550cc, 550-551
 - noninsulin-dependent (NIDDM), **548, 548-549, 549cc**
- Diabetic cataracts, **935**
- Diabetic ketoacidosis, 390, 390cc, 1044
- Diacylglycerol(s), 182, 184, **325, 364, 397-398, 400, 1060, 1144**
- activation of protein kinase C pathway, 865-866
 - formation, **862, 865f**
 - in phosphatidylethanolamine synthesis, 405f
 - in phospholipid synthesis, 404-406
 - as second messenger, 862, 865f
- 1,2-Diacylglycerol 3-phosphate. *See* Phosphatidic acid
- Diagnosis
- of bacterial infections, 583cc
 - of cancer, 583
 - of disease
 - amino acid analysis in, 74cc
 - plasma proteins in, 37cc
 - use of DNA probes in, 583cc
 - of Gaucher's disease, 430f, 430cc
 - of genetic disorders, 583
 - direct DNA sequencing for, 766cc
 - of infectious disease, 583
 - isozyme measurement and, 172
 - of sphingolipidoses, enzyme assays for, 429-431
 - of Tay-Sachs disease, 430
- Diarhea, 427
- bacterial toxigenic, 1068cc
 - electrolyte replacement therapy in, 1068cc
 - in vitamin deficiency, **1118**
- Diaspirin hemoglobin, 1026cc
- Diastereomers, **1139**
- Diazepam, structure, 923, 923f
- 6-Diazo 5-oxo-L-norleucine (DON), 519, 519f
- Dibase monocarboxylic acids, **27**
- Dibasic acids, 1146
- Dicarboxylic acid, **387**
- Dicarboxylic acids, transport, in mammalian cells, 211f
- Dicarboxylic monoamino acids, **27**
- Dicumarol, **971, 1117**
- Dideoxyhexoses, **344**
- Dideoxynucleoside triphosphate, **763, 763f, 763-765, 764f**
- Diet
- American, 1132-1133
 - iron-fortified, hemochromatosis and, 1011cc
 - and nitrogen balance, 447-448
 - and osteoporosis, 1129cc
 - vegetarian. *See* Vegetarian diet(s)
- Dietary fiber, **1097, 1097-1098**
- Dietary Goals for the United States*, 1101-1102, 1102f
- Dietary intake studies, in malnutrition, **1108**
- Diffusion, **196**.
- See also* Membrane transport
 - facilitated, **204**
 - Fick's first law of, **197**
 - of molecules, through membranes, 189, 196-197, 197f
 - of proteins and lipids, in membranes, 193-196
 - rate of, **196, 196-197, 197f**
- Digestion, 1059-1063
- of carbohydrates, 1073-1076, 1075f
 - intracellular, **17, 17-19, 18f, 1059**
 - intraluminal, **1059**
 - knowledge of, historical perspective on, 1056
 - of lipids, 1077f, 1077-1083
 - overview, 1056-1057
 - of peptides, 1072
 - of protein, 1070f, 1070-1073
- Digestive enzyme(s)
- proenzymes, 1059-1060
 - secretion, 1059-1060, 1060f
- Digestive vacuoles, **19**
- Digitalis, **207**
- Dihydrobiopterin reductase deficiency, 465cc
- Dihydrofolate reductase, 150-151, 1123
- gene, as selectable marker for transfected cells, 785
- Dihydrolipoyl dehydrogenase, 234
- Dihydrolipoyl transsuccinylase, **234**
- Dihydropyrimidinase, **511**
- Dihydropyrimidine dehydrogenase, **511**
- Dihydroquinone, formation, 971
- Dihydrosphingosine, **184, 184f, 422**
- Dihydrotestosterone, **901**
- Dihydrouracil, 1147
- 1,25-Dihydroxy vitamin D₃ (1 α ,25-dihydroxycholecalciferol), **907, 1112, 1112-1114**
- excretion pathway, 902f
 - functions, 895f
 - mechanism of action, 907, 907f
 - in renal failure, 1113cc
 - secretion, 895f
 - structure, 895f
 - synthesis, 894, **907, 908, 992**
- Dihydroxyacetone, structure, **339, 1139**
- Dihydroxyacetone phosphate, 375f, 376, 377f
- Dihydroxyacetone phosphate synthase, **408, 408f**
- Dihydroxyphenylalanine (DOPA)
- for Parkinson's disease, 467cc
 - production, 466
- Diisopropylfluorophosphate (DFP), reaction with serine protease, 98f
- Diisopropylphosphofluoridate, 1071
- Dimerization
- photochemical, **629, 632f**
 - of steroid receptor monomers, **912, 912f**
- 2,4-Dinitrophenol, **260**
- Dioxygenase(s), 129, 129f, 130
- Dipalmitoyllecithin, 398-399, 408f
- Dipeptidase(s), **1059, 1072**
- Dipeptide(s), **28**
- carrier-mediated transport, 1072-1073
- Dipeptidyl aminopeptidase IV, 1059f
- Diphenylhydantoin, and vitamin requirements, 1118cc
- Diphosphatidylglycerol, 184f
- See also* Phosphatidylglycerol phosphoglyceride
- Diphtheria toxin, effects on protein synthesis, 735
- Dipole, 4, 4f
- Dipole-dipole interactions, **576**

Dipole-induced dipole interactions, **569**

Direct bilirubin, **1018**

Directional cloning, 766-767, 767*f*

Disaccharidase(s), **1059**

- deficiency, 1075cc

Disaccharides, 1073-1076, 1142

Dissociation, 5-9

Dissociation constant (K_d), 8*r*, **30**, 30-31, 31*r*, 32*r*, 32-33

Dissociation constant (K_d), of

- hormone-receptor complex, 871-872

Distal histidine, **115**

Disulfide bond, **1139**

Disulfide isomerase, 744

Diuretics, drug-nutrient interactions, 1133*r*

Diurnal variations, of hormone secretion, 866

DKA. *See* Diabetic ketoacidosis

D-loop, **663**

DNA, **16**, 678, 708.

- See also* Complementary DNA; Gene(s); Transcription
- A conformation, **570**
- alkaline denaturation, **579**
- Alu family, **616**
- amplification
 - and drug resistance, 671cc
 - by polymerase chain reaction, **759**, 759*f*, 759-760
- anisomorphic, **595**
- annealing, **580**
- antiparallel strands, **574**
- average helical repeat, 589*f*
- B conformation, 108*f*, **570**
- bacterial, cleavage, 610-611
- base composition, **565**
- base pairing, 624*f*
- base-pair stacking energies, 577*f*
- bases, 565, 566*f*.
 - See also* Base(s)
- B-DNA, 109*f*, 571*f*, 573*r*
- bending, **595**, 606
- blunt end, 765
- bZip Gcn4, structure, 111*f*
- C conformation, **570**
- catenates, **586**
- cell content, species differences, 584*r*
- cell transformation by, **564**
- circular, **586**, 587-595
 - evolutionary advantage, 586
- cloning
 - directional, 766-767, 767*f*
 - versus polymerase chain reaction, 768-770
- coding effectiveness, **565**
- complementarity, **570**
- complexity, **585**
- conformations, **570**, 595-601
- conserved sequences, 690
- cruciform, **595**, 595-596, 596*f*
- DAM methylase in, **565**
- damage, reversal, 640-641
- defined, ordered sequence (dos), **595**, **616**
- defined segments, preparation, 761-762
- DEM methylase in, **565**
- denaturation, 577-580, **578**, 579*f*
- depurination, **629**
- dipole-dipole interactions, **576**
- direct repeats, **595**, 596*f*
- discontinuous synthesis, **646**, 646*f*, 646-647
- double helix, **570**, 570-575
 - anti form, **573**, 573-574
 - disruption, 577-580
 - dynamic state, **578**
 - endo form, **573**
 - geometry, **570**
 - major groove, **571**
 - minor groove, **571**
 - structure, 572*f*, **573**, 573-574
 - syn form, **573**, 573-574
 - syn-anti equilibrium, **573**
 - zipper model for, 578*f*
- double-strand
 - circles, 586-587
 - hydrogen bond formation in, 570
 - and temperature, 578*f*
- end-group labeling procedure, 586*f*
- equilibrium centrifugation, 585*f*
- Escherichia coli*, nucleotide sequence, 611*f*
- eukaryotic, 613-614
 - negative supercoiling, 606*f*
 - proteins coded for, 820
 - reassociation kinetics, 581*f*
- flanking regions, study using deletion and insertion mutations, 786-787, 787*f*
- four-stranded, 599*f*, 599-601
- fragments, Southern blotting, 774*f*, 774-775
- function, 564-565, 609-617
- G-quartet, **599**
- G-rich regions, **595**
- helical turns or twists, number (T), **589**
- helix-to-coil transformation, **578**
- helix-turn-helix motif, lac repressor protein association with, 109*f*
- homology, evolutionary relatedness determined by, **582**
- homopurine-homopyrimidine regions, **597**
- homopurine-homopyrimidine sequences, **595**
- hybridization, **582**, 582-583
 - D_f method, **582**
 - R_f method, **582**
 - in situ*, **582**
- hydrogen-bonding specificities, **570**, 570*f*
- hypochromic effect, **579**
- information capacity, 565
- interaction with protein, and lac operon transcription, 807
- interlocking circles, **586**
- interspersion pattern, **615**
- inverted repeats, **595**, 596*f*
- junk, 613
 - , circularization, 587*f*
- linker, **606**
- linking number L , **589**, 589*f*, 592
- London dispersion interactions, **576**
- long interspersed repeats, **615**, 615*f*
- long stretches, analysis, 781-783
- mammalian, organization of genes in, 820-822
- melting curve, **579**
- midpoint temperature, 579*f*
- mirror repeat symmetry, **598**
- mirror repeats, **595**, 596*f*
- mitochondrial, 617, 830-831, 831*f*
 - mutations, 617cc
- mobile elements (transposons), **614**
- mutations, 627*f*, 627-632, **628**, 628*f*, 633cc.
 - See also* Mutations
 - deletion, 786-787, 788*f*
 - expressed, **628**
 - frameshift, 601, 603*f*, **628**, 721, 723*r*
 - phenotypically silent, **628**
- nascent, **647**
- negative spherical form, **648**
- negative superhelical, **587**
- NF- κ B homodimer, structure, 113*f*
- nodule variant, **599**, 599*f*
- nucleosome positioning, **606**
- origin of replication, **603**
- overwinding, **588**
- packing, **603**
- palindromes, **595**, 596*f*
- phased A tracts, **595**
- polynucleotide segment, structure, 567*f*
- precursor fragments, **647**
- prokaryotic
 - coding for specific proteins, 611-613
 - genome size, 614
- quadruplex, **595**, 599*f*, 599-601
 - antiparallel, 601
- radiation damage to, 629-630
- random coils, **569**
- random primer labeling of, 773
- random-coil regions, **579**
- reannealing, 580-582
- reassociation kinetics, 581*f*
- recombinant. *See* Recombinant DNA
- recombination, **661**, 661-670
 - and immunoglobulin genes, 663cc
 - types, 662-663
- characteristics, 662*r*
- regulatory sequences, enzymatic
 - modification, 788, 788*f*
- reiteration of nucleotide sequences, 580, **585**
- relaxed, **587**, 587*f*
- renaturation, 580-582
- REP elements (repeated extragenic palindromic elements), **612**
- repeated sequences, 614-617
- repetitive, **614**
 - in eukaryotes, 822-823
 - highly repetitive, **822**, 822*f*
 - moderately repetitive, **822**, 822-823
- replication, **511**, 642-661
 - bidirectional, **646-647**
 - coordination, 660-661
 - in *E. coli*, 649, 649*f*, 650*f*
 - at end of linear chromosomes, 657*f*, 657-660, 658cc
 - eukaryotic, 653-657, 659-660
 - initiation, 656-657
 - in mammals, 655*f*
 - and mutation, 627*f*
 - prokaryotic, 658*f*, 659, 659*f*
 - rolling circle model, **652**, 652-653, 653*f*
 - semiconservative, 643-644, 644*f*
 - telomerases, 659-660
 - types, 643*f*
- restriction enzyme cleavage sites, 610*r*
- restriction maps, 760-762, **761**, 761*f*
- satellite, **614**
 - sequences, **616**
- sensitivity to shearing forces, 585
- sequences and genetic information, 25*f*

- highly reiterated, **614**, 616
- inverted repeats, **614**, 616-617
- locating, 582
- moderately reiterated, **614**, 615-616
- rates of reassociation, **614**
- satellite, **616**
- single copy, **614**
- sequencing, 671-672, 762-765
 - chemical cleavage method
- (Maxam-Gilbert procedure), 762-763, 763*f*
 - direct, 765
- for diagnosis of genetic disorders, 766cc
 - interrupted enzymatic cleavage method
- (Sanger procedure), 763-765, 764*f*, 765*f*
- short interspersed repeats, **615**, 615*f*
- simple sequence, **616**
- single strand, 587
 - structures, **570**
- single-copy, 615
- size, 584-586
 - determination, 585-586
- slipped, mispaired (SMP-DNA), **601**, 602
- SOS postreplication repair, **634**, 642, 642*f*
- splicing, **613**
- stacking interactions, **576**
- sticky ends, 765
- strands
 - polarity, **574**, 576*f*
 - separation, 647-649
- structure, 133*f*, 565-584, 573*t*, 609-617
 - conformational variations, **571**, 572*f*
 - hairpins, **617**
 - and histones, **603**
 - interwound circular, **591**
 - interwound turn, 591
 - plectonemic coil, **591**
 - secondary, 568-575
 - stability, 575-584
 - stabilization, 575-584
 - symmetry elements, 596*f*
 - toroidal turn, **591**
 - types, 584-609
 - variation of base plane orientation, 573-574
- subcloning, 781
- supercoils, **587**, 587*f*
 - equilibrium in, 591*f*
 - negative, 588
 - (or writhing) number (*W*), **589**
 - positive, 588, **593**
- superhelical, 589*f*, 590*f*
 - geometric description, 589-592
 - linking number *L*, determination, 589*f*
- superhelix, 587-595
- symmetrical inverted repeats, **595**, 596*f*, **610**
- synthesis, 16, 512-513
 - discontinuous, 646*f*, 646-647
 - DNA templates in, 646, 646*f*
 - initiation, 649-651, 650*f*
 - progression, 649-651
 - ribonucleotide reductase in, 508*f*
 - RNA template in, 660
 - termination, 651-652, 653*f*
 - using reverse transcriptase PCR, 778, 779*f*
- tandem arrays, **616**
- telomeres, **599**
- temperature-optical density profile, 579*f*
- template, for RNA synthesis, 689, 690, 690*f*
- topology, **587**
- torsional tension, **587**
- triple helices, 598*f*
- triple repeats, expansion, and disease, 602cc
- triple-stranded, **595**, 596-599, **597**, 597*f*
- triplexes
 - base pairing in, 598*f*
 - therapeutic potential, 600cc
- unwinding, **588**, 689
- wrapping, 606-608
- Z-DNA, **574**
 - structure, 571*f*, 573*t*
- DNA glycosylases, **635**
- DNA ligase, **765**, **832**
 - action, 635*f*, 639cc
- DNA methyltransferase, **656**
- DNA polymerase(s), 622-625
 - α , **644-645**, **655**
 - β , **654**
 - γ , **655**
 - in DNA synthesis, 652*f*
 - DNA-dependent, **622**, 622*t*, 622-625
 - errors, 630-631
 - eukaryotic, 625-627, 626*t*, 654-656
 - I, **624**
 - III, 623*t*, **625**, 626*f*
 - proofreading activity, 624
 - structure, 624-625, 625*f*
 - synthetic activity, 623*f*, 623-624
- DNA probes, **582**, 583, 770, 773-774
 - diagnostic use, 583cc
- DNA repair, 633-642, 639cc
 - coordination, 660-661
 - lesions requiring, 634*t*
 - mismatch, **627**, 630, **638**, 638-640, 640*f*, 641cc
 - postreplication, 641, 641*f*
- DNA topoisomerase(s), properties, 593*t*
- DNA vaccines, 565, 565cc
- dnaA, **649**
- dnaB, **650**
- DNA-binding proteins, **88**, 108-114, 109*f*
 - structural motifs, 108-111
 - Xfin, zinc-finger motif in, 109*f*, 110*f*
- dnaC, **650**
- dnaG, **650**
- DNase I hypersensitivity, 696*f*, **697**
- DNase protection, **806-807**
- DOC. *See* 11-Deoxycorticosterone
- Docking, of synaptic vesicles, **927**
- Docking protein, **735**
- cis-Docosahexaenoic acid, 364*f*
- Dolichol phosphate, **350**, 350-351, **737**
- Domains, **46**, 46-48
 - all- β -domain, **48**, 48*f*
 - β -barrel, **48**, 48*f*
 - α -folded, 48*f*, 49*f*
 - β -folded, **48**, 48*f*, 49*f*
 - Greek key β -barrel, **48**, 48*f*
 - twisted β -sheet, **48**, 48*f*, 49*f*
- DON. *See* 6-Diazo 5-oxo-L-norleucine
- Donor atom, **66**
- Donor molecule, **80**
- Donor site, **669**
- DOPA. *See* Dihydroxyphenylalanine
- DOPA decarboxylase, **466**
- Dopamine, 211*t*, **466**, 467cc, 468*f*, **929-930**
- Dopamine β -hydroxylase, **147**, 853, 1131
- Dopaquinone, production, 468
- Double helix/helices
 - intercalation between base pairs, 632*f*
 - interlocked, separation, 648*f*
 - stretching, 631-632
- Double-reciprocal plot. *See* Lineweaver-Burk plot
- Double-stranded RNA-dependent kinase, **748**
- Drosophila virilis*, repetitive DNA sequences, 822, 822*f*
- Drug(s)
 - antipyretic, 436
 - clearance from blood, 134
 - and cytochrome P450 induction, 986cc
 - delivery, liposomes for, 189cc
 - detoxification, **272**
 - as enzyme inhibitors, 149-151
- Drug resistance. *See also* Multidrug resistance
 - biological basis for, 520-521
 - DNA amplification and, 671cc
- Drug-nutrient interactions, 1133, 1133*t*
- dTMP. *See* Deoxythymidylate
- Dubin-Johnson syndrome, 1021cc
- Duchenne's muscular dystrophy, 821, 822cc
- Ductus arteriosus, 436
- dUMP. *See* 2-Deoxyuridine 5'-monophosphate
- Duodenum, iron absorption in, 1005cc
- Dyad symmetry, **806**
- Dynein, **20**
- Dystonia, 237cc
- Dystrophin
 - gene, 821, 821*f*
 - Duchenne/Becker muscular dystrophy and, 822cc
 - structure, 821, 821*f*
- E**
- E site, 730
- ECC. *See* Enterochromaffin-like cells
- Edema, 398
- Editing, **723**
- Edman cycles, 75
- Edman reaction, **74**, 75*f*
- EF (elongation factors). *See* Elongation factor(s)
- EF hand, **209**
- Effectors, 151
- Ehlers-Danlos syndrome, 748*t*, 749cc
- Eicosanoids, **433**
 - oxygenation, cytochrome P450 in, 990-992
- Eicosapentaenoic acid, **440**, 1099cc
- Eicosatrienoic acids, **440**
- eIF (eukaryotic initiation factor), **725**
- Elastase(s), 1071, 1071*t*
 - reactivity toward substrates, 100*t*
- Elastin, **54**, 54-55
- Elderly
 - niacin deficiency in, **1121**
 - nutritional needs of, 1133, 1134cc
- Electrical synapses, **923**
- Electrogenic sodium flux, **1064**, 1065*f*
- Electrolyte replacement therapy, in diarrhea, 1068cc

Electrolytes, **5**, 5-7

- activity, **6**
- intestinal epithelial secretion, 1066, 1066*f*
- non-, **5**
- weak, **6**, 6-7

Electromotive force, **247**

Electron distribution, **77**

- Electron interactions, 67*f*

Electron microscopy, **585**, 585-586

Electron transport, **241**, **246**

- in inner mitochondrial membrane, 241, 246-261

Electron transport systems, 206, **983**

- cytochrome P450, 987-989

Electron transport-oxidative phosphorylation sequence, 231, 231*f*

Electron-density map, **77**, 78*f*

Electro-osmotic flow, 71*f*

Electrophoresis, **69**, **585**, 585-586

Electrostatic interactions, 66, 66*f*.

- See also* Ionic interactions

α - β -Elimination, 450*f*

ELISA, 171

- in HIV envelope protein detection, 171*f*

Elongation

- in protein synthesis, 727-730, 728*f*-729*f*
- in transcription, **689**, **695-696**

Elongation factor(s), 727-730, 814

- EF-1, 727
 - in elongation cycle, 730, 731*f*
- EF-1 α , 727
- EF-1 , 730, 731*f*
- EF-2, 730, 745, 745*f*
- EF-G, 730, 731*f*, 814
- EF-Ts, 731*f*
- EF-Tu, 730, 731*f*, 814

Elongation reactions, 372-373

- in mammalian fatty acid synthase, 370*f*

ENaC. *See* Epithelial sodium channel

Enantiomers, **1139**, 1140

Encephalomyelopathy, subacute necrotizing, 258cc

Encephalopathy, 237cc

Endergonic reaction, **221**

End-group labeling procedure, 586*f*

Endo conformation, **573**

Endocrine abnormalities, and cancer, 553cc

Endocrine cells, epithelial, **1062**

Endocrine hormone(s), **841**

Endocytosis, **18**, 18*f*, **877**, **878**

Endonuclease, **665**

- RuvC, **667**

Endonuclease(s), **709**.

- See also* Restriction endonuclease(s)
- specificities, 569*t*

Endopeptidase(s), 1059*t*, **98**, **1070**, **1071**, 1072

Endoplasmic reticulum, **16**, 16-17, **982**

- hydroxylases, in steroid synthesis, 898
- membranes, protein topology at, 741-742, 742*f*
- microsomal cytochrome P450 system, 988, 988*f*
- procollagen formation in, 746-747

Endorphin(s), **932**, 932*t*

β -Endorphin, 846, 847*t*, 849, 850*t*

Endothelin, 849*t*

Enediols, 1142

Energy

- dietary sources, 528
- expenditure
 - age-related changes in, 1088
 - exercise and, 1089
 - factors affecting, 1088-1089
 - sex differences in, 1089
 - starvation and, 1089
- free. *See* Free energy
- intake, excess, 1094-1095
- metabolic reserves, 536, 537*t*
- metabolism, 490, 1088-1089
- requirements, in illness and recovery, 1092, 1093cc, 1094
- source, for brain, **920**
- sources, 312-330
- utilization and storage, 361-393
- in work, 220-222

Energy-producing systems, 218-220

- ATP and, 218-220, 219*f*, 220*f*

Energy-rich components, 220-225

- classification, 223*t*
- hydrolysis and, 222-224, 223*t*, 224*f*

Energy-utilizing systems, 218-220

- ATP and, 218-220, 219*f*, 220*f*

Enhancer sequences, 697

Enhancers, **690**, **696**, 697

Enkephalin(s), **932**, 932*t*

- genes encoding, 852
- structure, 852
- synthesis, 852*f*, 852-853

Enol phosphates, as energy rich compounds, 223*t*

Enolase, reaction catalyzed by, 273*f*, 277

Enterochromaffin-like cells, **1061**

Enterocytes, **531**, **1059**

- glucose transport systems in, 1076, 1077*t*

Enterohaptic circulation, **418**, **1084**, 1084*f*

Enterokinase. *See* Enteropeptidase

Enteropeptidase, 1059*t*, **1071**

Entropy, **220**

Entropy effect, 163-164

Enzyme(s), **128**.

- See also* Restriction enzyme(s)
- active site, 129
- allosteric control, 151-155
- allosteric effector, binding, 152
- allosteric site, 129
- bacterial, in carbohydrate digestion, **1075**
- binding site
 - asymmetry, 158
 - lock-and-key model, 156*f*
- cardiac, release after myocardial infarction, 167*f*
- catalysis of reversible reactions, 140
- catalytic ability, comparison, 136
- catalyzed vs. non-catalyzed reactions, energy diagrams for, 159*f*
- in chemical reactors, 174
- classifications, 129-133, 130*t*
- clinical applications, 166
- committed step catalysis, **174**
- compartmentation of, **174**
- competitive inhibitors, **148**
- complementarity with substrate, 156-158
- covalent modification, 149, 541-545
- cross-regulation, **175**, 175*f*
- and decrease of activation energy, 160-164
- deficiency
 - identification and treatment, 169cc
 - in Lesch-Nyhan syndrome, 169cc
 - in orotic aciduria, 169cc
- dephosphorylation, 543*f*, 545
- digestive, 1057, 1059*t*, 1059-1060, 1060*f*
- drug-metabolizing
 - genetic polymorphisms, 987cc
 - induction, 986cc
- feedback inhibition, **175**, 175*f*
- function, 24
- glycation, 538cc
- in gout, 138cc
- immobilized, as reagents, 170
- immunoassays, indicators in, 170-171
- induction in liver
 - in fasting, 546*f*
 - in fed state, 546*f*
- inhibition
 - by covalent modification of active center cysteine, 149*f*
 - in drug therapy, 149-151
- as integral membrane proteins, 191
- interaction with substrate, 136-137.
 - See also* Reaction(s), enzyme-catalyzed
- lipid-hydrolyzing, 17*t*
- long-term changes in, 545-547
- lysosomal, 17*f*
- in gout, 18cc
- sphingolipid catabolism by, 428
- and substrates, 17*f*
- lysosome-targeted, 739-742, 741*f*
- mechanism of action, 137, 139
 - biphasic nature, 138, 138cc
- metal cofactors, 144-147
- modulation by ligands, 151-152
- monomeric, 152
- multisubstrate reactions, 140-142
- mutated, assay of, ambiguity in, 169cc
- nomenclature, 129
- nucleic acid-hydrolyzing, 17*t*
- oligomeric, 152, **152**
- pancreatic, **1059**
 - activation, 1071-1072, 1072*f*
 - deficiency, 1112cc
 - essential serine residue, **1071**
 - secretion, 1071-1072, 1072*f*
- phosphorylation, **294**, 294*f*
- in lipogenic liver, 543*f*
- pH-velocity profile, 166
- plasma
 - activities, time dependence of, 167, 167*f*
 - types, 166
- polysaccharide-hydrolyzing, 17*t*
- product inhibition, 140
- protein-hydrolyzing, 17*t*
- proteolytic, binding characteristics, 101*f*
- rate-limiting, **174**, 175
- in reaction rate enhancement, 165*f*
- RecBCD, **612**
- regulation, 174-175, 540-541
- regulatory protomer, 155
- reversible noncompetitive inhibition,
 - double-reciprocal plot for, 149, 149*f*
- saturation kinetics, 136-140
- secretion, 1059-1060, 1060*f*
- specific activity, **136**

- specificity, 128-129
 - active site, 155-158
- subclasses, 129, 130*t*
- substrate-binding site, 128-129
- symmetrical substrate, three-point
 - attachment to asymmetrical substrate, 159*f*
- temperature vs. velocity, 166, 166*f*
- terminology, 136
- as therapeutic agents, 172-174
- units (U), 136
- velocity vs. temperature, 166, 166*f*
- xenobiotic-metabolizing, 993, 994*t*
- Enzyme-binding site
 - induced fit model, 156, 156*f*
 - lock-and-key model, 156, 156*f*
- Enzyme-linked immunosorbent assay. *See* ELISA
- Eosinophil function, regulation, 439
- Epidermal growth factor
 - actions, 848*t*
 - source, 848*t*
- Epidermal growth factor-like domains, **960**, 969
- Epimerase(s), **133**
 - reactions catalyzed by, 133*f*
- Epimerization, **343**
- Epimers, **1139**, 1140
- Epinephrine, **231**, **533**, **929-930**
 - actions, 323, 327-328, 853, 883*t*, 884*t*
 - activation of pyruvate dehydrogenase, in cardiac tissue, 231
 - in cardiac glycolysis, 296-298
 - formation, 466-467
 - in hepatic glycolysis, 295, 296*f*
 - secretion, 853, 855*f*
 - synthesis, 853, 854*f*, 855*f*
 - urinary excretion products, 468*f*
- Epithelial endocrine cells, **1062**
- Epithelial sodium channel, **1064**
- Epithelial transport, 1063*f*, 1063-1069
 - paracellular, 1063*f*, 1063-1064
 - transcellular, 1063*f*, 1063-1064
- Epoxide, **989**
- Epoxide hydrolase, **994**
- Equilibrium centrifugation, **585**, 585-586
 - of DNA, 585*f*
- Equilibrium constant, **221**
 - and standard free-energy change, 221, 221*t*
- Equilibrium constant(s), **284**
 - for glycolytic enzymes of liver, 284*t*
- Equilibrium constant (K_{eq}), 6, 135, 137
 - equation for, 118
- Equilibrium electrical potential, **921**
- Erabutoxin, **203**
- Ergocalciferol. *See* Vitamin(s), D₂
- Ergosterol, **410**
 - structure, 410*f*
- Erythrocyte(s)
 - anion channel, **190**, 204-205
 - domains, 191
 - band 3, **204**
 - bicarbonate in, 1033*t*, 1035-1036
 - carbohydrate metabolism in, 270-272
 - glucose transport, 204
 - inhibitors, 204, 204*f*
 - life span, 1017
 - oxygen dissociation curve for, 1029, 1029*f*
 - plasma membrane
 - asymmetric distribution of lipids in, 192-193, 194*f*
 - fluidity, cholesterol and, 195cc
 - structure, 192, 193*f*
 - senescent, 1017
 - transketolase, 1119
- Erythrocyte ghosts, **207**
- Erythromycin, effects on protein synthesis, 734*t*, 735
- Erythropoietic porphyria, **1014**
- Erythropoietic protoporphyria, 1012*t*
- Erythropoietin
 - actions, 848*t*
 - source, 848*t*
- Erythrose 4-phosphate, formation, 339
- Escherichia coli*
 - biosynthetic operons, leader peptide
 - sequences, 813*t*
 - chromosome, 609*f*
 - diarrhea caused by, 1068cc
 - DNA replication in, 649, 649*f*
 - termination, 653*f*
 - DNA-dependent DNA polymerases, 622*t*, 622-625
 - excision repair in, 635-636
 - genetic map of, 801*f*
 - heat-stable toxin, 1068cc
 - homologous DNA recombination in, 665-666, 666*f*
 - lactose operon, 802*f*, 802-807
 - large ribosomal subunit, assembly map for, 716, 717*f*
 - primosome, 651*f*
 - protein synthesis in, stringent control of, 815, 815*f*
 - pyruvate dehydrogenase complex derived from, 228, 228*f*
 - RNA polymerase, 691, 691*t*
 - structure, 3*f*
 - synthesis of human growth hormone, 834*f*, 834-835
 - tryptophan operon, 807-813
 - genes of, 808, 809*f*
- Essential amino acid(s), **1090**
 - requirements for, 1090-1091
- Essential fatty acids (EFA), deficiencies, **1097**
- Essential serine residue, **1071**
- Esterase(s), **1059**
- Esterification, 1138
- Esters, **1138**
- 17 β -Estradiol, 894, **896**, **905**
 - excretion pathway, 902*t*
 - functions, 895*t*
 - secretion, 895*t*, 903*t*, 905*f*, 905-906
 - structure, 895*t*
 - synthesis, 903*t*, 905*f*, 905-906, **990**
 - hormonal regulation, 903*t*
- Estradiol, actions, **868**, 868-870
- Estrogen(s), 896, 1145
 - androgen aromatization to, **992**, 993*f*
 - drug-nutrient interactions, 1133*t*
 - and tyrosine metabolism, 467
- Ethanol
 - catabolism, 555
 - ingestion, and gluconeogenesis, **312**, 312cc
 - and membrane fluidity, 195cc
- Ethanolamine, **460**, 460*f*
- Ethanolamine glycerophospholipid. *See* Phosphatidylethanolamine
- Ethanolamine kinase, **405**
- Ethanolamine phosphotransferase, **405**
 - in phosphatidylethanolamine synthesis, 405
- Ethanolamine plasmalogen, 183, 183*f*
- Eukaryotes
 - genes, structure, 613*f*
 - repetitive DNA sequences in, 822-823
 - transcription in, 696-699
- Eukaryotic cells, **2**
 - compartments and functions, 15*t*, 15-20
 - composition, 12-15
 - expression vectors in, 784-786
 - nucleoproteins, 601-608
 - organization, 3*f*, 12-15
 - structure and function, 3*f*, 4*t*, 12-22, 13*f*
 - transfected
 - foreign gene expression in, 786, 786*f*
 - selectable markers, 785-786
- Eukaryotic initiation factor(s), **725**
- Evolution, restriction mapping and, 762cc
- Evolutionary relatedness, determined by DNA homology, **582**
- Excinuclease. *See* Excision nuclease
- Excision nuclease, **636**, 636*t*
- Excision repair, **635**, 636-638
 - base, **635**
 - in *E. coli*, 635-636
 - eukaryotic, 636-638
 - nucleotide. *See* Nucleotide excision repair
- Excitation energy transfers, **80**
- Excitatory neurotransmitters, **923**, 924
- Exciton system, **79**
- Exercise, **551**
 - aerobic, 551-552
 - anaerobic, 551-552
 - and energy expenditure, 1089
 - fuel for, 551-552
 - and glycogenolysis, 313
- Exergonic reaction, **220**
- Exocrine cells, **1060**
- Exocrine secretion, **1060**
 - of digestive enzymes, 1060, 1060*f*
- Exocytosis, **927**, **1060**
 - fusion process, **927**
 - of neurotransmitters, 925, 926*f*
- Exogenous substrates, **992**
- Exon-intron patterns, **104**, 104*f*
- Exons, **613**, **703**, 820
- Exonuclease(s), 569*t*, **709**
- Exopeptidase(s), **98**, **1070**
- Expressed (retained) sequences, **703**.
 - See also* Exons
- Expression system, **985**
- Expression vector(s), 783, **783**, 784*f*, 784-786
- Extended active site, **101**
- Extracellular fluid, 1037, 1037*f*
- Extrinsic factor, **1125**
- Eye(s), 932-946
 - anatomy, 932, 933*f*
 - diseases, 481cc

F

- Fab fragment, **94**, 95*f*
- Fabry's disease, 429*t*, 430
- Facilitated diffusion, **204**
- F-actin, **951**, 951-952

- Factor III, **961**, 961*r*, 964*f*.
- See also* Tissue factor
- Factor V, 965, 966, 968*f*
- Factor VII, 963-964, 969
- Factor VIIa, 964, 965*f*
- Factor VIIIa, 963, 966
- Factor VIII, 966, **967**, 968*f*
- deficiency, 967, 969cc
- Factor IX, activation, 963, 969
- Factor X, 961*r*, 963, 969
- Factor Xa, 965, 965*f*
- Factor Xa-Va, 964-966, 965*f*
- Factor XI, 961*r*, 961-963
- Factor XII, 961, 961*r*, 963
- Factor XIII, 967
- FAD. *See* Flavin adenine dinucleotide
- Familial hyperproinsulinemia, 743cc
- Familial lysinuric protein intolerance, 481cc
- Fanconi's anemia, 639cc
- Farnesyl pyrophosphate
- formation, 412*f*
- mevalonic acid and, 412
- in squalene formation, 413*f*
- Fasciculus, 946, 947*f*
- Fast axonal transport, **931**
- Fast food, 1133
- Fasting state, 530-533, 531*f*.
- See also* Starvation
- early, 529-530, 530*f*
- Fat, dietary, 1097.
- See also* Lipid(s)
- contribution to daily nutrient supply, 1056, 1056*t*
- energy content of (kcal), 1088
- intake, 1056*t*, 1077
- and cancer risk, 1097
- and diabetes mellitus, 1096cc
- excess, 1097
- inadequate, 1097
- and protein sparing, 1091
- Fat malabsorption, **1114**
- and vitamin K deficiency, **1117**
- Fat storage, 321
- Fats, 1144
- Fatty acid desaturase, **988**
- Fatty acid synthase, **366**, 369, 374
- Fatty acids, **362**, **1143**
- abbreviations for, 364*t*
- activation by conversion to fatty Acyl CoA, 381-382
- addition of water, 1143
- asymmetrical distribution, in phospholipids, 406-408
- availability to tissue, 380-381
- bound to serum albumin, 379
- branched chain, 374
- catabolism, 306*f*
- chemical nature, 363-365
- desaturation, positions for, 373*f*
- diet and, 365-366
- elongation and desaturation, specific example, 373
- elongation reactions, 372-373
- mitochondrial elongation, 372*f*
- energy yield from β oxidation of, 383
- essential, deficiencies, **1097**
- free
- in obesity, **1095**
- in triacylglycerol digestion, **1078**, 1081
- function in the body, 362-363
- gluconeogenesis from, 306-307
- in glycerophospholipids, 182, 183*r*
- in human metabolism, 364*t*
- hydroxy, formation, 373-374
- hydroxylation, **387**
- long-chain, 181*f*, 364*f*, 182-183, 183*f*, 1082-1083, 1143-1144
- medium-chain, **1082**, 1082-1083
- metabolism, 362, 384-387
- nomenclature, 364
- omega, 1099cc, 1143
- omega (ω)-oxidation, 387
- α -oxidation, 384-387
- β -oxidation, 384-387
- comparison with palmitate biosynthesis, 383
- genetic impairment in, 385cc
- modification, 384-387
- palmitate, 385*t*
- oxidation, 382*f*, 384-387, 390*f*, 390-391, 532, 1143
- palmitate precursor, 371-374
- patterns, **376**
- in phosphatidylcholine, 182
- in phosphatidylethanolamine, 182
- polyunsaturated, **372**, **1098**
- formation and modification, 372-373
- linoleic, 1099cc
- linolenic, 1099cc
- omega-3, physiologic effects, 1099cc
- omega-6, physiologic effects, 1099cc
- and risk of heart disease, 1099, 1099cc
- and prostaglandin synthesis, 432*f*
- reduction, 1143
- saturated, **1098**, **1143**
- and risk of heart disease, 1099, 1099cc
- short-chain, 1143-1144
- sources, 365-366
- storage, 375-377
- straight chain, β -oxidation, 381-383
- synthesis, **272**
- commitment step, 366-368
- palmitate biosynthesis, 367*t*
- regulation, 367*t*
- release of palmitic acid, 369*f*
- stoichiometry, 369
- transfer through mitochondrial membrane, 382*f*
- triacylglycerols, 364-365, 377*f*
- unsaturated, 1143
- utilization for energy production, 381-387
- Fatty acyl CoA
- in phosphatidic acid synthesis, 402-403
- reduction to fatty alcohols, 374-375
- as source for triacylglycerols, 376
- Fatty alcohols, **375**, 375*f*
- in plasmalogen synthesis, 408-409
- reduction from fatty acyl CoAs, 374-375
- Fe fragment, **94**, 95*f*
- FCCP. *See* Carbonylcyanide-*p*-trifluoromethoxy phenylhydrazone
- Feedback inhibition, **175**, 175*f*, 808
- Feedback loops, in hormonal cascade, **842**, 842-844, 843*f*
- Feedback stimulation, of hormone secretion, 869
- Fermentation, **269**
- Ferredoxin(s), **1004**, 1004*f*, 1004-1005
- Ferritin, **1004**
- Ferrochelatase, **1016**
- Ferroxidase I/II, **1008**
- Fetus, **552**
- nutrient requirements, 552
- protein absorption, 1073
- Fever-inducing agents. *See* Pyrogens
- Fiber, dietary, 1056, **1097**
- intake, 1098-1101
- metabolic fate, 1097-1098
- muclilaginous, **1097**, 1098*t*
- properties, 1097-1098, 1098*t*
- sources, 1097-1098
- types, 1097-1098, 1098*t*
- water-soluble, **1097**, 1097-1098, 1098*t*
- Fibrin, **960**
- formation, 964-966, 965*f*
- in myocardial infarct, 98cc
- soft clot, 966, 967*f*
- Fibrinogen, 964-966, 974*f*
- Fibrinolysis, 975-976.
- See also* Blood coagulation, clot dissolution
- Fibrous material, **1056**.
- See also* Fiber
- Fibrous protein(s), 50-55
- Fick's first law of diffusion, **197**
- FIGLU. *See* Formiminoglutamate
- First order reactions, **134**
- Fischer projection formulas, 1140
- Flagella, bacterial, **818**
- Flagellin gene, of *Salmonella*, 818-819, 819*f*
- Flavin, **251**
- Flavin adenine dinucleotide, **143**, 144*f*, 514-515, 988, 1121
- coenzyme function, in succinic
- dehydrogenase reaction, 143-144, 144*f*
- isoalloxazine ring of, 987, 988*f*
- optical properties, 168-170
- and pyruvate dehydrogenase reaction, 228*t*, **234**
- structure, 251*f*
- synthesis, 514*f*
- Flavin coenzymes, absorption spectrum, 168*f*
- Flavin mononucleotide, **143**, 144*f*, 251*f*, 987, 988, 988*f*, 1121
- Flavin-linked dehydrogenases, 251, 251*r*
- Flip-flop movement, 189, 191, 193
- Fluid compartments, composition, 1036-1037, 1037*f*
- Fluid mosaic model, of membranes, **189**, 190*f*, 196*f*
- Fluid secretion, intestinal epithelial, 1066, 1066*f*
- Fluidity
- membrane, **193**, 194-195
- abnormalities, 195cc
- factors affecting, 195cc, 195-196
- plasma membrane, cholesterol and, 195cc
- Fluorescence spectroscopy, 79-80
- Fluorescent emission, 79, 80*f*
- Fluoride, **282**, **1132**
- 5-Fluoro-2 -deoxyuridine 5 -monophosphate (FdUMP), **518**
- Fluoroacetate, **233**
- Fluorophore, **80**
- 5-Fluorouracil (Fura), 151, **517**, 517*f*
- Fluoxetine hydrochloride (Prozac), 930
- FMN. *See* Flavin mononucleotide

- Folate
- components, 461*f*
 - deficiency, 463cc, 481-482, **1124**, **1125**
 - fully reduced (coenzyme) form, 150
 - metabolism, diseases, 483cc
 - transport, in mammalian cells, 211*r*
- Folic acid, **1123**
- as coenzyme, 150
 - deficiency, 463cc
 - functions, in one-carbon metabolism, 1123-1125
 - metabolic role, in one-carbon metabolism, 1123*f*, 1123-1125
 - requirements, and anticonvulsant therapy, 1118cc, 1125
 - structure, 1123*f*
 - and methotrexate structure, comparison, 518*f*
- Follicle-stimulating hormone, 846, 903*r*, 905-906
- actions, 847*r*, **868**, 868-870, 883*r*
 - hormone-receptor interactions, 872-873
 - secretion, regulation, 883-885, 884*f*
 - source, 847*r*
- Follicular hyperkeratosis, in vitamin A deficiency, **1111**
- Food(s)
- contribution to daily nutrient supplies, 1056, 1056*r*
 - energy content of (kcal), 1088
 - fast, 1133
 - glycemic index, 1096cc, 1101*r*
 - imitation, 1133
- Food pyramid, USDA, 1102, 1103*f*
- Formiminoglutamate (FIGLU), **481**, 481-482
- N*¹⁰-Formyl H₄folate, **494**, 496*f*
- Fourier synthesis, **77**
- Fovea centralis, **935**
- Fragile X syndrome, 602cc, 697cc
- Frameshift mutations, 601, 603*f*, **628**, **631**, 721, 723*r*
- Free energy, **200**, **220**, 220-222
- standard change, 221*r*, 221-222, 222*r*
 - in coupled enzyme reactions, 224-225
 - and equilibrium constant, 221, 221*r*
 - in redox reactions, 248-249
- Free fatty acids, **1078**, 1081, **1095**
- Fructokinase deficiency, 342cc
- Fructolysis, **307**
- Fructose, **286**
- formation, 308*f*
 - gluconeogenesis from, 307, 308*f*
 - intolerance, 285cc, 342cc
 - malabsorption, 212cc
 - sources, 1074*r*
 - structure, 1074*r*, 1140
 - synthesis, 935
 - transport, in mammalian cells, 211*r*
- Fructose 1,6-bisphosphatase, 289, **303**, 303*f*
- Fructose 1-phosphate, **307**
- Fructose 1-phosphate aldolase, 342
- deficiency, 342cc
- Fructose 2,6-bisphosphatase, **544**
- bifunctional nature, 295-296
 - cardiac isoenzyme, 298*f*
 - covalent modification, 295*f*
 - hepatic isoenzyme, 296*f*
 - intracellular concentration, 295, 296*f*
- Fructose 2,6-bisphosphate, **287**, **292**, 292-294, 293*f*, **310**, 310-312
- degradation, 293*f*
 - formation, 293*f*
 - structure, 292*f*
- Fructose 4-phosphate, formation, 339-340
- Fructosuria, essential, 342cc
- FSH. *See* Follicle-stimulating hormone
- Fucosidosis, 349cc, 429*r*
- Fumarase, 132, 132*f*, **237**
- deficiency, 237cc
- Fumarate, **236**, 454, 455*f*
- Functional groups, 1137-1138
- Furanose rings, 1140
- Furosemide, **1066**, 1066*f*
- Fusion proteins, **783**
- G**
- G factor, 730
- G subunit, **325**, 325*f*
- G6P. *See* Glucose-6-phosphate
- GABA (gamma-aminobutyric acid), **457**, 923
- degradation, 931
 - metabolism, 931, 931*f*
 - neurotransmitter function, 931
 - structure, 923, 923*f*
 - synthesis, 457*f*
 - transport, in mammalian cells, 211*r*
- GABA receptor, **923**, 923-924, 924*f*
- GABA shunt, **931**
- G-actin, **951**, 951-952
- G-actin-ATP-Mg²⁺ complex, 951-952
- Galactitol, 343cc
- Galactocerebrosidase deficiency, in Krabbe's disease, 425
- Galactocerebroside(s), **184**, 184-185, 185*f*, **422**, 424*f*, **425**
- Galactocerebroside sulfate, structure, 424*f*
- Galactokinase deficiency, 343cc
- Galactolipid. *See* Galactocerebroside
- Galactose, **307**
- and blood type, 347
 - gluconeogenesis from, 307
 - interconversion, 343, 343cc
 - structure, 1140
- Galactose 1-phosphate, accumulation, 343cc
- Galactose 1-phosphate uridylyltransferase, **307**
- deficiency, 343cc
- Galactosemia, **307**, 343cc
- β -Galactosidase, 611*f*, 800, 807, 807*f*, **1075**, 1076*r*
- Galactosyltransferases, **425**
- Gallbladder, functions, 1057, 1058*f*
- Gallstones, cholesterol, 1081cc
- Ganglioside(s), **185**, **426**, 426*r*, 426-427, **1145**
- in brain, 426
 - receptor function, 427
 - structure, **426**, 426*f*, 426*r*
- Gangliosidosis
- generalized, 429*r*
 - GM₁, 349cc, 427
 - GM₂, **430**
 - variant O, 349cc
- Gap junctions, **203**, 203*f*
- Gardner's syndrome, 639cc
- Gas exchange, pulmonary, 1027
- Gas transport, 1026
- Gastric acid, secretion, **436**
- Gastric juice, 1070
- Gastrin, **1062**
- actions, 848*r*, 1061*r*, 1062
 - source, 848*r*
 - structure, 1062, 1062*r*
- Gastrointestinal tract, 1057, 1058*f*, 1066, 1066*f*
- Gaucher's disease, 429*r*, 430-431
- diagnosis, 430*r*, 430cc
 - gene therapy, 793cc
- GDP, 942
- Gene(s) *See also* DNA; Gene expression
- activation, **699**
 - active, **608**
 - cloning, 824-827
 - intervening sequences (introns) in. *See* Introns
 - inversion, in *Salmonella*, 818-819, 819*f*
 - mitochondrial, 830-831
 - mutations, 169cc.
 - See also* DNA, mutations
 - organization, in mammalian DNA, 820-822
 - regulatory, 801
 - reporter, 787
 - repressed, **608**
 - silencers, 912
 - structural, 613, 801
 - for vision, chromosomal location, 944-945, 946cc
- Gene duplication, **96**, **984**
- Gene expression
- bacterial, of foreign genes, 832-835
 - coordinate, 803
 - foreign, in transfected cells, 786, 786*f*
 - regulation, 799-838
- Gene library, **768**
- Gene superfamily, cytochrome P450, **985**
- Gene therapy, **793**, 793cc, **836**
- General transcription factor TFIIH, **638**
- Genetic code, 718, 718*r*
- breaking of, 720
 - degeneracy, 719
 - four-letter alphabet of, 718, 718*r*
 - punctuation, 719
 - universal, 719
- Genetic complementation groups, **636**
- Genetic disease, 828
- diagnosis, 583
- Genetic diversity, **661**
- Genetic information, transcribed into amino acid sequence, 25*f*
- Genetic polymorphisms, **986**
- of drug-metabolizing enzymes, 987cc
- Genome(s)
- complexity, **580**
 - human, 608, 672cc
 - sequencing, 611
 - intervening sequences, **613**
 - repetitive classes, **580**
- Gentamicin, effects on protein synthesis, 734, 734*r*
- Geranyl pyrophosphate, **412**
- Gilbert's syndrome, 1020cc
- Glaucoma, 936cc
- Glial cells, 921
- Globin(s)
- cDNA, cloning, 824-827, 825*f*
 - chains, production, age-related change in, 114*f*
 - genes, 824-829, 826*f*
 - subunits

- Globin(s)
- (*continued*)
- genes, 824
 - in thalassemia, 828-829
- Globoid leukodystrophy, 425, 429*t*
- Globosides, 425, 1145
- γ_2 -Globulins, **901**, **1021**
- Glomerular filtration rate, 436
- Glossitis, **1118**
- Glucagon, **270**, **533**
- actions, 295, 296*f*, 311, 311*f*, 312, 323, **327**, 848*t*
 - source, 848*t*
 - synthesis, 293
- 1,4- α -Glucan branching enzyme, **319**
- D-Gluconic acid, 1141
- Glucoamylase, 1059*t*, 1076*t*
- Glucocerebrosidase deficiency, in Gaucher's disease, 430cc, 793cc
- Glucocerebrosidase(s), **184**, **422**
- excess, in Gaucher's disease, 425
 - structure, 424*f*
 - synthesis, 424*f*
- Glucocorticoid(s), 894, 911, 1145
- Glucocorticoid receptor(s), 911
- Glucocorticoid response elements, 911, 911*t*
- Glucogenic amino acids, 304-306, 306*t*, 447
- Glucokinase, 131, **142**, 284*t*, 284-286, 286*f*
- reaction catalyzed by, 142, 284
 - specificity, 156
 - substrate saturation curve for, 285*f*
- Gluconeogenesis, **245**, **272**, **299**, 299-312, 300cc, 310*f*, **530**, 530-533
- abbreviated pathway, 299*f*
 - from amino acid carbon chains, 304-306
 - and ATP expenditure, 308
 - ethanol ingestion and, **312**, 312cc
 - from fatty acids, 306-307
 - glycolytic enzymes in, 303-304
 - hormonal regulation, 310-312
 - from lactate, 301, 302*f*
 - regulation sites, 308-310, 310*f*
 - from sugars, 307
- Gluconic acid, 1141
- Glucono-5-lactone, 1141
- Glucosamine, structure, 402*f*
- Glucosamine 6-phosphate, synthesis, 344
- Glucose
- absorption, epithelial, **1067**, 1068*f*
 - activated, **319**
 - blood (serum)
 - factors affecting, 1100
 - and glycemic index of foods, 1101*t*
 - source, 529-530
 - steady-state level, 138
 - and carbohydrate metabolism pathways, 268*f*
 - catalysis, 170
 - conformations, 158, 158*f*
 - dietary sources, 1074*t*
 - disposition, in well-fed state, 528*f*
 - homeostasis, 538, **538**, 539*f*
 - interconversion to galactose, 343
 - intolerance, **546**
 - malabsorption, 212cc
 - membrane transport, **209**, 209*f*, 209-210
 - metabolism, 270*f*-271*f*, 270-272
 - in early refeed state, 533-534
 - as energy source for brain, **920**
 - free-energy changes associated with, 222*t*
 - glycolysis and, 269*f*
 - sodium-dependent transport, 209*f*, 209-210
 - storage, 321
 - structure, 1074*t*, 1140
 - synthesis. *See* Gluconeogenesis
 - transcellular transport, 1067, 1068*f*
 - transport, 204, 204*f*, 211*t*
- UDP-, **307**
- oxidation, 280, 344, 344*f*
 - synthesis, 343
- Glucose 1-phosphate uridylyltransferase, **319**
- Glucose 6-phosphatase, **286**, 286*f*, **316**, **545**
- deficiency, in von Gierke's disease, 498cc
 - reactions catalyzed by, 274, 303*f*, 303-304*f*
- Glucose 6-phosphate, 170, **225**, 304*f*
- complete oxidation, **340**, 340*f*, 340-341
 - dehydrogenation, 336-338, 337*f*
 - in pentose phosphate pathway, 336-338
- Glucose 6-phosphate dehydrogenase, **337**
- deficiency, 338cc
- Glucose dehydrogenase, UDP-, **344**
- Glucose oxidase, **129**, 129*f*
- Glucose permease, **204**
- Glucose tolerance factor, 1132
- Glucose transport protein(s). *See* Glucose transporter(s)
- Glucose transporters(s), 204, **272**, **330**, 1068*f*, **1069**, 1076, 1077*t*
- Glucose-fatty acid cycle, 545
- Glucosidase, **319**
- α -Glucosidase(s), **1075**.
- See also* Maltase
- β -Glucosidase, 1059*t*, 1076*t*
- exo*-1,4- α -Glucosidase. *See* Glucoamylase
- Glucosyltransferase(s), **132**, **425**
- Glucuronic acid, **344**, 344*f*, 345*f*, 1141
- copolymer, 353-354
 - and glucuronide formation, 346cc
 - UDP-, formation, **280**, 344*f*
- Glucuronic acid pathway, **272**
- β -Glucuronidase deficiency, 352cc
- β -Glucuronidase(s), **280**, 280-281
- GLUT. *See* Glucose transporter(s)
- Glutamate, **27**, 34*f*
- in amino acid synthesis, 450, 450*f*, 457-458
 - metabolism, 931, 931*f*
 - ornithine conversion into, 535
 - side chains, 27*f*
 - transport, in mammalian cells, 211*t*
- Glutamate dehydrogenase, 235, **450**, 450*f*, 451, 453
- Glutamate-aspartate antiport, **303**
- Glutamate-oxaloacetate transaminase, 235
- Glutamate-pyruvate aminotransferase reaction, 448*f*
- Glutamic semialdehyde, **458**, 458*f*
- Glutaminase, **450**, 451*f*, **546**
- Glutamine, **27**, **450**
- in acid-base balance, 556-559
 - in ammonia production, 450-451
 - antagonists, 519*f*, 519-520
 - catabolism, 532*f*
 - cycle, **451**, 451*f*, **554**, 558
- Glutamine PRPP amido-transferase, **497**, 497*f*, **500**
- Glutamine synthetase, **450**, 451*f*
- Glutaminolysis, **531**
- γ -Glutamyl cycle, **210**, 210*f*, **485**, 485*f*, 1059*t*
- γ -Glutamylcysteinylglycine. *See* Glutathione
- γ -Glutamyltranspeptidase, **210**, **485**
- Glutaredoxin, **507**
- Glutathione, **210**, 210*f*, **272**, **484**, 484-485, **535**
- composition, 457
 - drug conjugation by, 484, 484*f*
 - production, 535*f*
 - synthesis, 485, 485*f*
- Glutathione peroxidase, **460**, 1132
- Glutathione reductase, **507**, **933**
- Glutathione transhydrogenase, **858**
- Glutathione-dependent peroxidase, **434**
- Gluten, **1057**
- Glycan, **192**
- Glycyrhethinic acid, 911cc
- Glycemic index, 1096cc, 1101*t*
- Glyceraldehyde, structure, 1139
- Glyceraldehyde 3-phosphate, 149*f*, 339-340
- Glyceraldehyde-3-phosphate dehydrogenase
- inactivation, 282, 282*f*
 - mechanism of action, 276*f*
 - and noncompetitive inhibition, 149, 149*f*
 - reaction catalyzed by, 275-276
- D-Glyceric acid, 1141
- Glycerol
- gluconeogenesis from, 307, 308*f*, 530-533
 - stereospecific numbering, 396*f*
 - structure, and sphingosine structure, comparison, 420*f*
- Glycerol 3-phosphate, 376, 376*f*, 403*f*
- L-Glycerol 3-phosphate, structure, 181*f*
- Glycerol ether phospholipids, **183**, 183*f*
- Glycerol kinase, 158, **307**
- Glycerol phosphate shuttle, **243**, **279**, 279*f*
- Glycerol phosphate:acyltransferase, 403
- Glycerol-3-phosphate dehydrogenase, 280
- Glycerophosphate, in phosphatidic acid synthesis, 402-403
- Glycerophospholipids, 180, **181**, 397
- amphipathic, **183**
 - charge on, 183-184, 184*t*
 - fatty acids in, 182, 183*t*
 - structure, 181, 181*f*
- Glycine, **25**, **460**, 461cc, 923, **1078**
- in heme synthesis, 1012
 - metabolism, free-energy changes associated with, 222*t*
 - oxidation, 460, 461*f*
 - structure, 923, **923*f***
 - synthesis, 1123
- Glycine cleavage complex, **460**, 461*f*
- deficiency, 461cc
- Glycine receptor(s), **923**
- Glycocholic acid, **418**, 419*f*
- Glycoconjugates, 1079, 1080*t*, **1084**
- Glycogen, **270**, 316*f*, **1073**, **1142**
- digestion and absorption of, 1073-1074, 1075*f*
 - glucose storage as, 321
 - metabolism, effector control of, 326
 - stores, **313**, **1095**
 - and carbohydrate intake, 1095, 1096cc
 - and food intake, 313, 313*f*
 - synthesis, 132, 132*f*
 - enzymes for, 319, 319*f*
 - negative feedback control of, 326

- primer for, **321**, 321*f*
 - regulation, 322, 326
 - Glycogen branching enzyme, **319**, 320*f*
 - Glycogen debranching enzyme, **317-318**, 318*f*
 - Glycogen phosphorylase, **314**, 314-317, **322**, 322*f*, 322-323, **544**
 - Glycogen storage disease, **316**, 317cc, **318-319**
 - Glycogen synthase, **319**, 319-320, 322, **324**, 324*f*, 324-325
 - Glycogenesis, **269**, **312**, 312-330, **313**
 - Glycogenin, **321**, 321*f*
 - Glycogenolysis, **269**, **299**, **312**, 312-330, 316*f*, 322, 327*f*, 327-328
 - Glycolaldehyde, active, **338**
 - Glycolysis, **268**, 269*f*, 269-283, **921**
 - balanced equation for, 269*f*
 - excessive, 291cc
 - inhibition, 282-283
 - oxidoreduction-phosphorylation stage, **274**, 275-278
 - and pentose phosphate pathway, 336
 - reversible link with, **338**
 - priming stage, **274**, 274-275
 - regulation, 283-299
 - splitting stage, **274**, 275
 - stages, 273*f*, 274
 - Glycolytic intermediates, in pentose phosphate interconversion, 338-340
 - Glycopeptide bonds, 61*f*, 350, **350**, 351*f*
 - Glycophorin, 190, **190**, 191
 - Glycoproteins, **187**, **348**, 348-351
 - carbohydrate in, 348-349
 - and covalently bound carbohydrate, 60-61
 - functions, 348
 - microheterogeneity, **349**
 - N*-linked, synthesis, 350-351
 - structure, 349-350
 - SV-2, 927
 - synthesis, 1110
 - Glycosaminoglycan(s), **352**, 355*f*, 356-357
 - Glycosaminoglycan chain, repeat units, 353*f*
 - Glycosidases, **356**, 737
 - defects in, 349cc, 350cc
 - β -*N*-Glycosidic bond, **492**
 - Glycosidic linkage
 - α -1,4-, 1142
 - N*-, **61**, 61*f*, 737
 - O*-, **61**, 61*f*, 738
 - Glycosphingolipids, **184**, 422-427, 1145
 - N*-Glycosyl bonds, 350
 - O*-Glycosyl bonds, 350
 - Glycosyl donor, **1110**
 - Glycosyl phosphatidylinositol anchors, 192, **192**, 192*f*, 192*t*, **401**, 401-402
 - Glycosylated 5-hydroxycytosine, **565**
 - Glycosylated hemoglobin, 62cc
 - Glycosylation, 736-739
 - N*-linked, **61**, 61*f*, 737
 - O*-linked, **61**, 61*f*, 738
 - Glycosyltransferase(s), 346, **346**, 737, 737*t*
 - Glycyrrhizic acid, 911cc
 - Glyoxalate, **460**
 - GMP. *See* Guanosine 5'-monophosphate
 - GMP reductase, **500**
 - GnRH. *See* Gonadotropin-releasing hormone
 - GnRH-associated peptide, 852
 - Goiter, **1131**
 - Golgi apparatus, **17**
 - procollagen formation in, 746-747
 - Gonadotropes, **868**, **906**
 - Gonadotropin, secretion, 906
 - Gonadotropin release-inhibiting factor, 844*t*
 - Gonadotropin-releasing hormone, 844*t*, 905
 - actions, 847*t*, 867*f*, 867-870, 883-885, 884*t*
 - gene, 852
 - source, 847*t*
 - structure, 857*t*
 - Gout, 152cc, 490, 498, 498cc, 517
 - GPI. *See* Glycosyl phosphatidylinositol anchors
 - G-protein(s), **859**, 859-860, 860*t*, 942
 - subunits, **859**
 - G-quartet DNA, **599**
 - Gramicidin A, 212*t*, **213**
 - Gratuitous inducers, 804
 - Green pigment, 937
 - Group translocation, **198**, **210**, 211*t*
 - Growth hormone, **553**, 829, 846
 - actions, 847*t*
 - deficiency, 830
 - human, synthesis in recombinant bacteria, 834*f*, 834-835
 - rat gene, introduction into mice, 835*f*, 835-836
 - recombinant, therapy with, 830
 - source, 847*t*
 - Growth hormone release inhibiting hormone.
 - See* Somatostatin
 - Growth hormone-like proteins, genes, 824, 829-830
 - Growth hormone-releasing hormone (somatocrinin), 844*t*
 - actions, 847*t*
 - source, 847*t*
 - structure, 857*t*
 - GTF. *See* Glucose tolerance factor
 - GTP-binding proteins, **927**
 - Guanine, **492**, 679-680
 - Guanine nucleotide exchange factor, **727**
 - Guanosine 5'-monophosphate, **494**
 - synthesis, 494-497, 496*f*
 - Guanosine pentaphosphate, synthesis, 815
 - Guanosine tetraphosphate, synthesis, 815
 - Guanosine triphosphate, **219**, 490-491, **500**, 501*f*, 942
 - as energy source, 219, 219*f*
 - Guanylate cyclase, 885, 886*f*, **943**, 944*t*, **1061**
 - Guanylin, 1061*t*, 1062, **1062**, 1062*t*, 1068cc
 - Gums, **1097**, 1098*t*
 - Gustin, **1131**
 - Gyrase(s), **592**, **648**
 - reverse, **593**
- ## H
- H band, **948**
 - Hairpin structure(s), 680
 - Half life of reaction ($t_{1/2}$), 134
 - Half-chair configuration, 161*f*
 - Halothane, and malignant hyperthermia, 291cc
 - Hammerhead ribozyme, 686, 688*f*
 - Hapten, **88**
 - Haptoglobins, **1021**
 - Hartup disease, 212cc, 1072cc
 - Haworth formulas, 1140-1141
 - HbH disease, 828-829
 - HDL. *See* High-density lipoproteins
 - Heart
 - glycogen degradation in, regulation, 328
 - glycolysis in, 296-298, 298*f*
 - Heart attack. *See* Myocardial infarction
 - Heart disease, risk factors for, 1098-1100, 1099cc
 - Heat shock proteins, **63**, **910**, 934*t*
 - Heavy filaments, **948**
 - Heavy meromyosin, **950**
 - Helicase(s), **636**, **648**
 - in homologous recombination, 665, 666*f*
 - II, **648**
 - Helices, **568**
 - α -Helix, 43-44, 44*f*, 55*f*, 79*f*
 - Helix pitch (p), **43**, 43*f*
 - Helix-loop-helix motif, of calcium-binding proteins, 209, 209*f*
 - Helix-turn-helix (HTH) motif, **108**, 109*f*, 912
 - Hematin, **1003**
 - Hematocrit, 1036
 - Heme, **1003**
 - catabolism, 1017*f*, 1017-1021
 - environment, movement of residues in, 122*f*
 - structure, 115*f*, 115-116, 1009, 1009*f*
 - synthesis, 1009-1017
 - enzymes in, 1011-1016
 - pathway, 1009, 1010*f*
 - rate-limiting step, ALA synthase in, 1017
 - Heme a, 252*f*-253*f*, 253
 - Heme b, 253
 - Heme c, 252*f*-253*f*, 253
 - Heme iron, 147, 983-984
 - Heme oxygenase, **1017**
 - Heme proteins, **982**, 983-984, 1003-1005
 - Heme-regulated inhibitor kinase, **748**
 - Hemiacetals, **1138**
 - Hemicellulose, **1097**, 1098*t*
 - Hemiketals, 1140
 - Hemochromatosis, **1130**
 - idiopathic, **1008**
 - and iron-fortified diets, 1011cc
 - molecular genetics, 1011cc
 - Hemoglobin, **88**, **1026**
 - and allosterism, 1029-1030
 - amino acid sequence, 117*t*
 - buffering capacity, **1033**, 1033-1034, 1041, 1041*f*
 - chemically modified, 1030cc
 - diaspirin cross-linked, 1026cc
 - fetal. *See* Hemoglobin F
 - glycosylated, 62cc
 - human, chains, by developmental stage, 114*t*
 - and intravascular hemolysis, 1020-1021
 - isohydric carriage of carbon dioxide, **1034**, 1034*f*, 1034-1035
 - ligands, interrelationships, 1036, 1036*f*
 - α -like genes, 826, 827*f*
 - β -like genes, 826, 827*f*
 - missense mutations, 721cc
 - molecular aspects, 114-124
 - oxygen affinity
 - abnormalities, 1032cc
 - plasma pH and, 1031, 1031*f*
 - temperature and, 1031, 1031*f*
 - oxygen binding, 115-116, 119*f*, 119-124, 1028, 1031, 1031*f*

Hemoglobin

(continued)

- oxygen dissociation curve for, 1029, 1029*f*
 - postnatal changes, 1030, 1031*f*
- oxygen saturation curve, 1028cc, 1028*f*, 1028-1029
- oxygen-binding curve, 119*f*
- oxygen-carrying capacity, 1026
- oxygen-induced changes in, 154
- R state, **1029**, 1029*f*
- structure, 114-124, 115*f*, 121*f*, 122*f*, 824
- subunits
 - genes, 821
 - α -globin, 824
 - β -globin, 824
- T state, **1029**, 1029*f*
- types, 114, 114*t*

Hemoglobin A₁

- β chain, comparison with myoglobin, 118*f*
- Hill plots for, 119*f*

Hemoglobin A_{1c}, **1030**Hemoglobin A₂, **1030**Hemoglobin F, **1030**

- hereditary persistence of (HPFH), 599, 600cc, 829

Hemoglobin Kenya, **829**Hemoglobin Lepore, **828**

Hemoglobin S, 828

- and sickle cell anemia, 42cc, 828, 828cc

Hemoglobinopathy, 721cc, **1030**

Hemolysis, intravascular, iron scavenging with, 1020-1021

Hemolytic anemia, 166cc, **1008**

- drug-induced, 337, 338cc

Hemopexin, **1021**

Hemophilia, 967

- B, diagnosis, direct DNA sequencing for, 766cc
- classic, 969cc

Hemorrhagic disease of the newborn, 1117cc, 1118cc

Hemosiderin, **1004**Hemostasis, **960**, 960-961, 961*t*Henderson-Hasselbalch equation, **9**, 9-10, 12cc, 32*f*, 32-33, **1038**, 1038*f*, 1039, 1046Heparin, **354**

- anticoagulant activity, 350cc
- structure, 353*f*

Heparin binding protein, 968

Heparin sulfamidase deficiency, 352cc

Heparin sulfate, **355**

Hepatic glycogenolysis, 529-530

Hepatocytes

- mitochondria in, 239*f*, 241
- periportal, **558**
- perivenous, **558**

Hepatorenal tyrosinemia, 467cc

Heptose, formation, 338, 339*f*Hereditary coproporphria, 1012*t*, **1016**

Hereditary persistence of fetal hemoglobin, 599, 600cc, 829

Hereditary protoporphyria, 1012*t*Herpes simplex virus, **709**

- type I, glycoprotein D, site-directed mutagenesis, 789cc

Herpesvirus, 517, **520**Heteroduplex DNA, **663-664**, 669Heteroduplexes, **583**, 583-584, 584*f*Heterogeneous nuclear RNA, 678*t*Heterophagy. *See* PhagocytosisHeterotetrameric protein, **942**Heterotropic effect, **1029**Heterotropic interactions, **152**

Heterozygote detection, 430

HETEs. *See* Hydroxyeicosatetraenoic acid(s)Hexokinase(s), **138**, **156**, 273*f*, **274**

- with glucose bound, 47*f*
- glucose-induced conformational change, 157*f*
- properties, 284*t*, 284-286, 285cc
- reaction catalyzed by, 282*f*
- reactions, **225**
- regulatory features, 283, 283*f*
- specificity, 156
- substrate saturation curve for, 285*f*
- unliganded form, 47*f*

Hexosaminidase, 428, 431*f*Hexose(s), 338, 339*f*, 342*f*Hexose monophosphate pathway, **933**Hexose monophosphate shunt, **516**.

See also Pentose phosphate pathway

HGPRase. *See* Hypoxanthine-guanine phosphoribosyltransferaseHigh mobility group protein(s). *See* Protein(s), HMGHigh molecular weight kininogen, 961, 962*f*High-density lipoproteins, **57**, **379**.

See also Lipoproteins

High-energy bonds, **219**, 222, 225, 225*f*

High-performance liquid chromatography, 72-73

Hill coefficient (n_{H}), 119*t*, **1029**Hill equation, **119**Hippurate, **456**, 456*f*Histamine, **482-483**, 483*f*, 1061, **1061**, 1061*t*Histamine H₂-receptor antagonists, 1061Histidase, **481**

- deficiency, 482cc

Histidine, **27**, 27*f*, 481-483

- acid and base forms, 160*f*
- distal, **115**
- guanidinium group, 27*f*
- imidazolium group, 27*f*
- invariant sequences, 105*t*
- metabolism, 481-483, 482*f*
- proximal, **115**

Histidine decarboxylase, **482**

Histidinemia, 482cc

Histone(s)

- and DNA structure, **603**
- messenger RNA, 685
- in nucleoproteins of eukaryotes, 601-608
- structure, 604*t*

Histone acetylase, **608**Histone deacylase, **608**HIV, 520, **520**, 792

- detection, 171, 171*f*
- screening for, polymerase chain reaction and, 760cc

HIV protease, structure, 78*f*HMG proteins. *See* Protein(s), HMGHMWK. *See* High molecular weight kininogenH-NS protein, **609**Holliday intermediate, **669**Holliday junction, **663**, 666, 668*f*Holoenzyme, **128**, 691Holoprotein, **115**

Homeodomain transcription factors, 830

Homocysteine

- accumulation, 471cc
- production, 470-471

Homocysteine desulhydrase, 471, 472*f*Homocysteine methyltransferase, **472**

Homogentisic acid, production, 465

Homologous alignment, **663**, **667**Homologous DNA sequences, pairing, **666**Homologous recombination, **662**, 662-668, 664*f*

- characteristics, 662*t*
- enzymes, 665-668
- proteins in, 662*t*, 665-668

Homotropic interactions, **152**, 1029Hormonal cascade system, **840**, 841*f*, 841-846, 843*f*

- cyclic, 866-871

Hormone(s), **841**

- adrenal, **894**
- amino acid-derived, **840**, 853-856
- autocrine, **841**
- derived from 5-hydroperoxyeicosatetraenoic acids, 437-439
- endocrine, **841**
- gonadotropic, in ovarian cycle, 867*f*, 867-870
- intracellular action, 878-888
- paracrine, **841**
- peptide. *See* Peptide hormone(s)
- polypeptide. *See* Polypeptide hormone(s)
- progesterational, 894, **894**, 896
- release
 - pulsatile, **842**
 - rhythmic cyclical, **842**
- serum levels, 537*t*
- sex, 894, **894**, 896
 - in ovarian cycle, 867*f*, 867-870
 - synthesis, 898, 900*f*
- steroid. *See* Steroid hormones

Hormone response elements, **910**, 911*t*

Hormone-receptor complex, 871

Hormone-receptor interactions, 859-860, 861*f*, 871-874

- multiple hormone subunits in, 872-873

Hormone-sensitive lipase, 545

- activity, in obesity, **1094**

Hormone-sensitive triacylglycerol lipase, in triacylglycerol hydrolysis, 380-381, 381*t*Hot spots, for recombination, **666**HPETEs. *See* 5-Hydroperoxyeicosatetraenoic acidsHPFH. *See* Hereditary persistence of fetal hemoglobinHPLC. *See* High-performance liquid chromatographyHREs. *See* Hormone response elementsHU protein, **609**, **650**Human genome. *See* Genome(s), humanHuman growth hormone, synthesis in recombinant bacteria, 834*f*, 834-835Human growth hormone gene family, 829*f*, **829-830**

Human growth hormone-like proteins, genes, 829-830

Human immunodeficiency virus. *See* HIVHuman serum albumin, titration curve, 35*f*

Hunter disease, 352cc

Huntington's disease, 823cc

Hurler-Scheie disease, 352cc

Hyaluronate, **353**, 353*f*, 353-354

Hydration, **381**

Hydrochloric acid secretion, 1056, **1069**, 1069*f*, 1070*f*

Hydrogen bond(s), **4-5**, 5*f*, **66**, 66*f*, 576-577, **1139**

- bond strength, 65*t*
- of water molecules, 4*f*, 4-5

Hydrogen ions

- in 6-phosphofructo-1-kinase regulation, 290-291
- buffering, **1043**, 1044*f*
- excreted, fates of, 1043-1045
- transport, in mammalian cells, 211*t*

Hydrogen peroxide, **19**

Hydrolase(s), **132**

Hydrolysis, 222-224, 223*r*, 224*f*, 376-377, **1138**

5-Hydroperoxyeicosatetraenoic acids, 437*f*, 437-439, 438*f*

Hydrophobic bond, bond strength, 65*t*

Hydrophobic interaction(s), **64**, 65*f*, 569, 575-584, **1139**

Hydrophobic molecules, **362**

Hydrophobicity, **38**, 38*f*

Hydrops fetalis, **828**

α -Hydroxy fatty acids, **373**

Hydroxy methylglutaryl (HMG) CoA, 388, **411**, 411*f*, **478-479**

Hydroxy methylglutaryl (HMG) CoA reductase, 411*f*, 415*f*

Hydroxy methylglutaryl (HMG) CoA synthase, **389**, 411*f*

25-Hydroxy vitamin D, (25-hydroxycholecalciferol), 907, **907**, **1112**

1,25-Hydroxy vitamin D, synthesis, hormonal regulation, 903*r*

3-L-Hydroxyacyl CoA, **383**

β -Hydroxybutyrate, **227**, 379, 379*f*, 388-389, 1044-1045

β -Hydroxybutyrate dehydrogenase, 191, 250

5-Hydroxycytosine, **565**

- glycosylated, **565**

Hydroxyeicosatetraenoic acid(s), 437*f*, 437-440

Hydroxyindole-*O*-methyltransferase, **866**

Hydroxylalysine, 748

Hydroxylase(s), in steroid synthesis, **898**

α -Hydroxylating enzyme, genetic deficiency, 387cc

Hydroxylation, **984**

5-Hydroxylsine, **350**, 351*f*

p-Hydroxyphenylpyruvate oxidase, **465**

Hydroxyproline, **458**, 458*f*

- synthesis, in scurvy, 749cc

11 β -Hydroxysteroid dehydrogenase, **911**

5-Hydroxytryptamine, **1061**.

- See also* Serotonin
- neurotransmitter function, 930-931
- structure, 1062*f*
- synthesis, 930

Hydroxyurea, **520**, 520*f*

Hyperammonemia, 456cc

Hyperbilirubinemia, **1019**

- hereditary, 346cc
- neonatal, 1020cc

Hypercholesterolemia, 362, **1131**

- familial (genetic), **416**
- treatment, 416cc

Hyperchylomicronemia, **549**

Hyperglycemia, nonketotic, 461cc

Hyperglycemic hyperosmolar coma, 537cc

Hyperhomocystinemia, 471cc, **1122**, **1124**

Hyperkalemic periodic paralysis, 956cc-957cc

Hyperleucine-isoleucinemia, 479cc

Hyperlipidemias, 56cc, 380cc

Hyperlysinemia, 481cc

Hyperphagia, 378cc

Hyperpolarization, **924**

- of rod cell membrane, **941**

Hyperproinsulinemia, familial, 743cc

Hyperthermia, malignant, 291cc

Hypertriglyceridemia, **286**, 549, 549cc, **550**

Hyperuricemia, 499cc

Hypervalemia, 479cc

Hypervariable regions, **90**

Hypoglycemia, 300cc, 385cc

- and alcohol intoxication, 312cc

Hypokalemia, and metabolic alkalosis, 1051-1052

Hypopituitarism, 846cc

Hypotension, 398

Hypothalamic gastrin-releasing peptide, 844*t*

Hypothalamic-pituitary axis, 842, 843*f*, 849-851, 851*f*

Hypothalamus

- and appetite regulation, 526cc, 528
- hormonal systems and, 842, 843*f*
- hormones, 847*t*
- in ovarian cycle, 867*f*, 867-870
- releasing hormones, 842, 844*t*, 845*f*, 857, 857*t*
- tumors, 378cc

Hypothyroidism, 378cc

- and obesity, 526cc

Hypoxanthine, 492

Hypoxanthine-guanine phosphoribosyltransferase deficiency, 499cc, 770cc

Hypoxic injury, 261cc

Hypusine, **473**, 473*f*

I

I band, **948**

IBW. *See* Ideal body weight

I-cell disease, 740, 740cc

IDDM. *See* Diabetes mellitus, insulin-dependent

Ideal body weight, 378cc

Idiopathic hemochromatosis, **1008**

IDL. *See* Intermediate-density lipoprotein(s)

Iduronate sulfatase deficiency, 352cc

L-Iduronic acid, 354

α -L-Iduronidase deficiency, 352cc

I-FABP. *See* Intestinal fatty acid-binding protein

Illness, nutritional considerations in, 1133

Immune system, and protein-energy malnutrition, 1093-1094

Immunization, 92cc

Immunoassays, enzyme-linked, 170-171

Immunocompetence, decreased, in iron deficiency, 1130

Immunoglobulin(s), **88**, 88-97, 89*f*, 90*f*

- A, 90*t*, 92cc
- abzymes, 164-165
- amino acid sequences, 92
- artificially synthesized, 164-165
- classes, 90*t*
- D, 90*t*
- deficiency, 92cc
- DNA recombination and, 663cc
- E, 90*t*, 92cc
- fold, 93, 93*f*, 97
- G, 89*f*, 90*f*, 90*t*, 92*f*, 92cc
- heavy chain, 96*f*
- hydrolysis, 95*f*
- isotopes, **96**
- structure, 93*f*, 94*f*
- genetics, 96-97
- hypervariable loops in, 95*f*
- M, 90*t*, 92*f*, 92cc
- molecular mass, 90*t*
- in mucosal secretions, 92cc
- in plasma, 92cc
- structure, 89-92, 95*f*, 97, 97*f*

Immunological domains, of receptors, **875**, 875*f*

IMP. *See* Inosine 5'-monophosphate

IMP dehydrogenase, **497**

Indicators, in immunoassays, enzymes used as, 170-171

Indirect bilirubin, **1019**

Induced fit model, 156, 156*f*

Inducers, **802**

- gratuitous, 804

Induction, **801**

Infantile bilateral striatal necrosis, 831

Infection(s)

- diagnosis, 583
- iron overload and, 1003cc
- metabolic effects, 553

Inflammation, 435, 440

Inflammatory mediators, 436

Inhibin, 847*t*, **906**

Inhibitor 1, **325**

Inhibitory neurotransmitters, **923**, 924

Inhibitory site, 152

Initial velocity (v_0), of enzyme-catalyzed reaction, **137**, 137*f*

Initiation, **689**, **695**, 725-727, 726*f*

Initiation codon, 685

Initiation complex, 727

Initiation factors, **725**

Initiation sequence, 685

Initiation sites, **63**

Initiator tRNA, **725**

Injury, metabolic effects, 553

Inner mitochondrial membrane, **983**

Inorganic ion transport, in mammalian cells, 211*t*

Inorganic pyrophosphate (PP_i), 404

Inosine 5'-monophosphate, 493, 494-497

Inosinic acid, 719

Inositides, role in signal transduction, 399-401

Inositol, **182**, 400

Inositol triphosphate, **328**, 328*f*, **400**, **1060**

- generation, 400*f*
- intracellular, removal, 401*f*
- as second messenger, 862-865
- in steroid hormone synthesis, **896**

Insertion sequences (IS), **669-670**

- Insertional inactivation, of recombinant plasmids, 770, 771*f*
- Insulin, **39**, 40*f*, **230**, **270**, **286**
 actions, 295-296, 297*f*, 311, 323, 325-326, 329-330, 330*f*, 848*r*
 signal transduction in, 879-880, 880*f*, 881*f*
 activation of pyruvate dehydrogenase, in adipose tissue, 230-231
 effects on protein phosphorylation, 879-880, 880*f*
 human, synthesis in recombinant bacteria, 832-833, 833*f*
 primary structure, 41cc
 source, 848*r*
 structure, species differences, 41*r*, 41cc
 synthesis, 743, 800
- Insulin receptor(s), **879**, 879-880
 in obesity, **1094**
- Insulin resistance, 547-548
- Insulin-like growth factor(s)
 actions, 847*r*
 IGF-I, **554**
 source, 847*r*
- Insulin-response element, **312**
- Integrase (Int), **668-669**
- Integration host factor (IHF), **668**
- Intercalation, **631**
- Intercellular glutamine cycle, **451**, 451*f*
- Interleukin(s), 553, **553**
- Intermediate-density lipoprotein(s), **58**
- Internal promoter, **690**
- International Union of Biochemistry and Molecular Biology (IUBMB), 129
- Interstitial fluid, 1036-1038, 1037*f*
- Intervening sequences, **613**, **703**.
See also Introns
- Intestinal fatty acid-binding protein, **1082**
- Intestinal mucosa, triacylglycerol synthesis, 376
- Intestine(s)
 diseases, 463cc
 function, 457, 529
- Intracellular digestion, **17**, 17-19, 18*f*, **1059**
- Intracellular messengers, calcium ions as, **208**
- Intraluminal digestion, **1059**
- Intrinsic factor, 963, **1125**
- Introns, **613**, 613*f*, **703**
 in eukaryotic genes, 820-822
 group I, 686
 group II, 686
 removal, 700, 702*f*
 self-splicing, 686
- Iodide, in thyroid hormone synthesis, 854-856
- Iodine, dietary, **1130**
- Iodoacetate, **282**
- Ion channels
 isolation, 923
 subunits, transmembrane organization, 956cc-957cc
 voltage-gated, **921**, **922**, 923
 disorders, 956cc-957cc
- Ion exchange chromatography, 70, 70*f*
- Ion product of water, **6**
- Ionic bond, bond strength, 65*r*
- Ionic forces, in DNA stabilization, **577**
- Ionic interactions, **1139**
- Ionic linkages. *See* Electrostatic interactions
- Ionophores, **211**, 211-213, 212*r*
- IP₃. *See* Inositol trisphosphate
- IPTG. *See* Isopropylthiogalactoside
- IREs. *See* Iron-responsive elements
- Iron
 absorption, 1005cc, **1005-1006**, 1006*f*, **1127**
 duodenal, 1005cc
 intestinal, **1005-1006**, 1006*f*
 binding
 to milk, 1003-1004
 to transferrin, 1003
 biochemistry, 1002
 deficiency, **1005**, 1009cc, 1130
 distribution, 1007-1008, 1008*r*
 excretion, 1005
 ferric ions, **1002**
 ferrous ions, **1002**
 metabolism, 1002, 1007-1008, **1130**, 1130*f*
 overload (excess), **1005**, **1130**
 and infection, 1003cc
 oxidation states, **1002**
 physiological roles of, 1130
 recommended dietary allowances, 1130
 requirements, in newborn, 1117cc
 scavenging, with intravascular hemolysis, 1020-1021
 storage, 1004
 transfer, 1002
 transport, in serum, 1003
 utilization, molecular regulation of, 1006-1007
- Iron regulatory proteins, **1006**
 IRP-1, 1006, 1006*f*
 IRP-2, **1007**
- Iron-binding proteins, 1002
- Iron-containing proteins, 1003-1005
- Iron-deficiency anemia, 1009cc, **1130**
- Iron-responsive elements, 750, 1006*f*, **1007**
 mutant, 1007cc
- Iron-sulfur center, 233, 252*f*
- Iron-sulfur protein(s), 146-147, **237**, **987**
- IRPs. *See* Iron regulatory proteins
- Irreversible inhibition, 149, 150
- IS. *See* Insertion sequences
- Isoacceptors, **682**
- Isoalloxazine ring, 987, 988*f*
- Isobutyrate, **559**
- Isocitrate dehydrogenase, **233**, 233-234
- Isodesmosine, **55**
- Isoelectric focusing, **70**, 70*f*
- Isoelectric pH, **33**
- Isoelectric point, 1146
- Isoenzymes. *See* Isozyme(s)
- Isohydic carriage, of carbon dioxide, **1034**, 1034*f*, 1034-1035
- Isoleucine, 26*f*, 453, 476-477, 478*f*.
See also Branched-chain amino acids
- Isomaltase, 1076*r*
- Isomaltose, 1142
^{4,5}-Isomerase, **896**
- Isomerase(s), **133**
cis-trans-prolyl, **63**
 protein disulfide, **63**
- Isomerism, *cis-trans*, **1139**
- Isomerization
 aldose-ketose, **341-342**
 in carbohydrate interconversion, 341-342
 of ribulose 5-phosphate, **338**
- Isomers, 1140-1141
 resonance, **28**
 stereoisomers, **1139**
- Isoniazid, 450, 1133*r*
- Isoprene, **1145**
- Isopropylthiogalactoside, 803-804, 833
- Isovaleric acid, structure, 364*f*
- Isozyme(s), **129**, 172, **172**, 450-451
- IUBMB. *See* International Union of Biochemistry and Molecular Biology
- ## J
- Jaundice
 neonatal, 1020cc
 nonhemolytic, 346cc
 physiological, 346cc
- Junk DNA, 613
- ## K
- K class enzymes, **152**
- k*₁ (rate constant), 134, **134**
- Kallikrein, 963
- Kasugamycin, effects on protein synthesis, 734
- Katal, **136**
- Kennedy syndrome, 602cc
- Keratan sulfate, 353*f*, 355, **355**
- Keratin, 55, 55*f*, **1111**
- Kernicterus, **1018**
 β -Keto acid, formation, 381
- Ketoacidosis, 362, 480cc
 β -Ketoacyl-ACP synthase, **368**
- 3-Ketodihydrospingosine, 420*f*, 421*f*
- Ketogenic amino acids, 304-305, 306*r*, 447
 α -Ketoglutarate, **233**, 233-234
 α -Ketoglutarate dehydrogenase, 234-235, 1119
- Ketone bodies, **227**, **380**, 532
 in diabetic ketoacidosis, 390
 as energy source for brain, **920**
 formation, 387-390
 and lipid, carbohydrate and amino acid metabolism in liver, 389*f*
 as lipid-base energy source, 379-380
 structure, 379*f*
 in triacylglycerol transport, 379
 utilization by nonhepatic tissue, 389
- Ketones, **1137**
- Ketopentose, 1139
- Ketosis, 380, 389-390
 β -Ketothiolase, 388
- Kidney(s)
 in acid-base balance, 1043
 function, 556-557
 medulla, carbohydrate metabolism in, 270
 in metabolic alkalosis, 1045-1046
 in nitrogen metabolism, 453, 457
- Kidney disease
 chronic, zinc deficiency in, 1131
 low-protein diets and, 1092cc
 nitrogen metabolism abnormalities and, 555
- Kilocalories, **1088**
- Kilojoule, 1088
- Kinase(s), **131**, 131*f*, 146*f*, 511
- Kinesin, **20**
- Kinetics, 133-142
- Klenow fragment, **624**, 625*f*, **762**
- K*_m (Michaelis constant), 137-139, 152
 abnormal, 169cc
 changes in, physiological effects, 139cc

determination, using Lineweaver-Burk plot, 137-138

graphic estimation, 137-138, 138*f*

significance, 138

Krabbe's disease, 425, 429*t*

Krebs cycle. *See* Tricarboxylic acid cycle

Kringle domains, 975

Kwashiorkor, 527cc, **1093**

Kynuramine, **476**

Kynureninase, 475*f*, **476**

Kynurenine formamidase, 475*f*

Kynurenine hydroxylase, 475*f*, **476**

L

lac repressor, 803-805

LACI. *See* Lipoprotein-associated coagulation inhibitor

β -Lactam antibiotics, absorption, 1073

Lactase, 1059*t*, **1075**, 1076*t*

insufficiency (deficiency), 1075cc, **1095**

Lactate, 10*f*, 290, 290*f*

gluconeogenesis from, 301, 302*f*

metabolism, free-energy changes associated with, 222*t*

transport, in mammalian cells, 211*t*

Lactate dehydrogenase

in gluconeogenesis, 301

reaction catalyzed by, 273*f*, 278

retinal, 935-936

subunit composition, 172

type B, 934*t*

types, 172

Lactation, **552**, 552-553

folic acid requirements in, 1125

Lactic acidosis, **290**, 291cc

Lactoferrin, **1003**, 1003-1004

Lactone(s), **1138**, **1141**

Lactose, **307**, **552**, **1057**

intolerance, 1075cc, 1095

sources, 1074*t*

structure, 1074*t*, 1142

synthesis, 552-553

Lactose operon, 802*f*, 802-807

control elements, 805*f*, 805-806

control of, 803-805, 804*f*

operator sequence, 805-806

promoter sequence, 805*f*, 806-807

repressor, 803-805

Lactosylceramide, structure, 425*f*

Lagging strand, **647**, 652*f*

phage. *See* Bacteriophage

Lambert-Eaton myasthenic syndrome, 927cc

Lampbrush chromosomes, **607**

Lanosterol, 413*f*, 414*f*

Large intestine, functions, 1057, 1058*f*

Lariat RNA, 706, 707*f*

LCAH. *See* Lipoid congenital adrenal hyperplasia

LDL. *See* Low-density lipoprotein(s)

Lead poisoning, 1012*t*, **1013**

Leader sequence(s), **810**, 810*f*, 811, 813, 813*f*

Leading strand, **647**, 652*f*

Leber's hereditary optic neuropathy, 617cc, 831, 831cc

Lecithin(s), 1144.

See also Phosphatidylcholine

Lecithin-cholesterol acyltransferase, **417**, 417*f*

Lens, crystalline, 932, **933**

age-related changes in, 934, 934*f*, 935*t*

carbohydrate metabolism in, 270

composition of, 933-935

metabolic interrelationships in, 935, 935*f*

Leptin

gene, **528**

in obesity, 378cc

Lesch-Nyhan syndrome, 169cc, **499**, 499cc, 770cc

Leucine, **25**, 26*f*.

See also Branched-chain amino acids

and gluconeogenesis, 304-305

ionic form, 32*f*

metabolism, 453, 476, 478*f*, 478-479

titration curve, 33*f*

Leucine aminopeptidase, 1059*t*

Leucine zipper motif, **110**, 110*f*, 111*f*

Leucovorin, **519**

Leukemia treatment, 174, 517, **517**

Leukocyte(s), carbohydrate metabolism in, 270

Leukotriene(s), 437-439, 1143, **1144**

derived from 5-HPETE, 438

LTA₄, **438**

LTB₄, 992

LTC₄, conversion to LTD and LTE, 439*f*

physiological effects, 439-440

structure, 1144

Levulose, for ammonia buildup, 456

Lewis acid, 144-146

LexA, **642**

LH. *See* Luteinizing hormone

LHON. *See* Leber's hereditary optic neuropathy

Licorice, 911cc

Liebermann-Burchard reaction, 409

Ligand, **151**.

See also Hormone-receptor interactions

Ligand gated receptors, 954

Ligand gated sodium channels, 942

Ligand-binding domains, of receptors, **875**, 875*f*

Ligandin, **1018**

Ligase(s), **133**, 135.

See also DNA ligase

Light meromyosin, **950**

Lignin, **1097**, 1098*t*

Limit dextrins, **317**, **1075**

Lineweaver-Burk plot, **138-139**

Linoleic acid, 366, 366*f*, 433, 1143

Linolenic acid, 366, 366*f*, 1143

Linoleoyl CoA, oxidation, 386*f*

Lipase(s)

acid-stable, **1078**

in adipose tissue, 377

hydrolysis of blood triacylglycerols, 380-381

in lipid digestion, 1078

mechanism of action, 1078, 1078*f*

pancreatic, **1078**, 1078*f*

deficiency, 1112cc

Lipid(s), **362**, **396**, **1143**

absorption, 1077*f*, 1077-1083

amphipathic, 1143

asymmetric distribution, **192**

biological function, 365

complex, in brain, **921**

digestion, 1077*f*, 1077-1083

functions, 362-363

hydrophobicity, 365

membrane, 180, 180*f*, 181-184, 186, 186*f*

asymmetric distribution, **192**

diffusion, 193-196

mobility, 188, 188*f*

transverse movement, 193

metabolism, 361-393, 389*f*, 395-443

nonpolar, **396**

nonsaponifiable, 1143

oxidation states, comparison with carbohydrates, 222, 222*f*

polar, **396**, 396*f*, 396-443

saponifiable, 1143

solubilization during digestion, 1077, 1078-1082

vesicular structures, 187-188.

See also Micelles

Lipid bilayer

fluidity, 188-189, 193-194, 194*f*

integral membrane proteins in, 190-191, 191*f*

phase transition temperature, 194, 194*f*

stability, 188-189

structure, 188, 188*f*

Lipid esterase, specific, **1078**

Lipid storage disorders, 427, **429**, 429*t*

Lipid-energy transport, genetic abnormalities, 380cc

Lipid-hydrolyzing enzymes, 17*t*

Lipid-linked oligosaccharide, **350**, 351*f*

Lipofuscin, **19**

Lipogenesis, 528*f*, **529**

Lipoic acid, 228*t*, **234**

Lipoid congenital adrenal hyperplasia, 896

Lipolysis, **532**

Lipophilin, 187

Lipoprotein lipase, 166, 380cc, 380-381, 381*t*, **529**

Lipoprotein-associated coagulation inhibitor, **975**

Lipoproteins, **56**, 56-60, **187**

blood, 375

chemical composition, 59*t*

density, 57*f*

high-density (HDLs), **57**, **379**

hydrated density classes, and electrophoretic mobility, 57*t*

in hyperlipidemias, 56cc

in hypolipoproteinemias, 59cc

intermediate-density (IDLs), **58**

low-density (LDLs), **57-58B**, **379**

plasma, and triacylglycerol transport, 379

structure, 58*f*

very low density (VLDLs), **58**, **379**, 529

in obesity, **1095**

Liposomes, **188**

for drug delivery, 189cc

preparation, 189

structure, 188*f*, 188-189

β -Lipotropin, 842, 846, 849, 850*t*

γ -Lipotropin, 849, 850*t*

Lipoxygenase, 436-440, 437*f*

Lipoxygenase pathways, **431**

Lithium

and phosphatidylinositol cycle, 863, 865*f*, 893cc

therapy, for manic-depressive illness, 863, 893cc

Lithocholate, **1083**

Lithocholic acid, **1084**

- Liver
- acetyl CoA in, excess, 231
 - in amino acid metabolism, 453, 454
 - bilirubin conjugation in, 1018-1019
 - cirrhosis, **554**
 - Cori cycle in, 552
 - damage, amino acid metabolism and, 448
 - and dietary glucose, 528
 - disease, metabolic derangements caused by, 554
 - energy reserves in, 537*t*
 - enzyme induction in, 546*f*, 547*f*
 - ethanol oxidation in, 555-556
 - glucogenic phosphorylation of enzymes in, 543*f*
 - gluconeogenesis in, 300*f*
 - glycogen granules in, **314**, 315*f*
 - glycogen in, 313, 313*f*
 - glycogenolysis in, 327*f*, 327-328
 - glycolysis in, 293, 293*f*, 295, 296*f*, 297*f*
 - glycolytic enzymes, 284*t*
 - in insulin-dependent diabetes mellitus, 550
 - intercellular glutamine cycle, 558
 - lipogenic phosphorylation of enzymes in, 543*f*
 - metabolism, switching between well-fed and starved state, 539-547
 - phospholipid metabolism in, 409
 - phosphorylase *a* in, 326-327
 - in regulation of blood pH, 558
- Lock-and-key model, 156, 156*f*
- London dispersion forces, **66-67**, 67*f*, 576*f*
- Long-chain fatty acids. *See* Fatty acids, long-chain
- Loop-sheet-helix motif, **112**, 113*f*
- Lovastatin, 416cc
- Low-density lipoprotein(s), **57-58**, **379**.
- See also* Lipoprotein(s)
 - oxidation, **1116**
- Low-density lipoprotein receptor(s), **416**, 973
- downregulation, **416**
- LTA, synthase, **438**
- Luteinizing hormone, 846, 903*t*, 906
- actions, 847*t*, **868**, 868-870, 883*t*
 - hormone-receptor interactions, 872-873, 874*f*
 - secretion, regulation, 883-885, 884*f*
 - source, 847*t*
- Luteinizing hormone-releasing hormone, 932*t*
- Luteolysis, 916cc
- Lyase(s), **132**
- Lymphocytes, **531**
- Lysine, **27**, 55*f*, **479**, 479-481
- and gluconeogenesis, 304-305
 - metabolism
 - disorders, 481cc
 - minor product, 481*f*
- Lysine amino oxidase, **55**
- Lysinuric protein intolerance, familial, 481cc
- Lyso-compounds, 1144
- Lysolecithin exchange, in phosphatidylcholine synthesis, 407*f*
- Lysolecithin-lecithin acyltransferase (LLAT), **407**, 407*f*
- Lysophosphatidylcholine, in phosphatidylcholine synthesis, 407*f*
- Lysosomal acid lipase
- in cholesterol ester-storage disease, 19cc
 - deficiency, 19cc
 - in Wolman's disease, 19cc
- Lysosomal enzymes, 17*f*
- in gout, 18cc
 - sphingolipid catabolism by, 428
- Lysosomal storage diseases, 427-431
- Lysosomes, **17**, 17-19, **857**
- active site, hexasaccharide binding, 158
 - in lipase deficiency, 19cc
 - protein digestion in, 750-751
 - proteins targeted to, 739-742, 741*f*
- Lysozyme, 156-158, 158*f*, 160*f*, 161*f*
- Lysyl hydroxylase deficiency, 749cc
- Lysyl oxidase, 748, 1131
- M**
- Macrominerals, 1128-1129
- Macromolecular binding specificity, **108**
- Macromolecular structures, 1139
- Macronutrients, 1087-1106.
- See also* Carbohydrate(s); Carbohydrate metabolism; Energy; Fiber; Protein; dietary
- Macula degeneration, 936cc
- Magnesium, **1129**
- in active site of kinases, 146*f*
- Malabsorption, 1133
- due to loss of membrane transport systems, 212cc
 - fat, **1114**
 - and vitamin K deficiency, **1117**
 - fructose, 212cc
 - glucose, 212cc
 - niacin deficiency in, **1121**
- Malaise, in vitamin deficiency, **1118**
- Malaria, 828
- Malate, **237**
- Malate dehydrogenase, **237**, **280**, **371**
- Malate-aspartate shuttle, **243**, **279**, 279*f*, **312**
- Malignant hyperthermia, 291cc
- Malnutrition, **1108**.
- See also* Nutrition
 - assessment of, 1108
 - biochemical assays for, **1108**
 - clinical symptoms in, **1108**
 - dietary intake studies, **1108**
 - protein-energy, **1093**, 1093-1094
- Malonate, **237**
- Malonyl CoA, formation, 366-368
- Maltase, 1059*t*, 1076*t*
- Maltose, **1075**, 1142
- Maltotriose, **1075**
- Mammalian fatty acid synthase, 369, 370*f*
- Mammalian synthase, **369**
- Mammary gland, **374**
- Manganese, **1132**
- Manic-depressive illness, lithium therapy for, 863, 893cc
- Mannose, 307, 1140
- Mannose 6-phosphate, 341-342, 740
- Mannosidosis, 349cc
- Marasmus, 527cc, **1093**
- Maroteaux-Lamy disease, 352cc
- Mass-action ratio(s), **284**, 284*t*
- Matrix, **13**
- Maxam-Gilbert procedure, for DNA sequencing, 762-763, 763*f*
- Maximum velocity (V_{max}), **136**
- McArdle's disease, 317cc
- Mechanism-based inhibitors, **986**
- Mechanochemical proteins, **20**
- Mediated transport system, **198**
- Megaloblastic anemia, 463cc
- Melanin, 468*f*, 468-469, **469**
- Melanocyte-stimulating hormone, 846
- actions, 847*t*
 - source, 847*t*
 - synthesis, 849, 850*t*
- Melatonin, **476**
- secretion, 866
 - structure, 476*f*
 - synthesis, 866, 866*f*
- Membrane(s), **12**, 12-13
- asymmetry, 191
 - carbohydrates, 187, 187*f*
 - cellular, 180, 186, 186*f*
 - channels, **197**, 197*t*, 197-198, 201-204
 - functions, 201, 201*f*
 - regulation, 201-203, 202cc
 - structure, 201, 201*f*
 - chemical composition, 180-187
 - cholesterol in, 186
 - depolarization, 328-329
 - diffusion of molecules, 189, 196-197, 197*f*.
 - See also* Membrane transport
 - diffusion of proteins and lipids in, 193-196
 - electron microscopy, 180, 180*f*
 - eukaryotic, 180
 - fluidity, **193**, 194-195
 - abnormalities, 195cc
 - factors affecting, 195cc, 195-196
 - functional role, 15-20
 - hyperpolarization, **941**
 - integral (intrinsic) proteins, **187**
 - domains, 191
 - in lipid bilayer, 190-191, 191*f*
 - transmembrane segment, 190, 191*f*
 - intracellular, 180
 - lipids, 180, 180*f*; 181-184, 186, 186*f*
 - asymmetric distribution, **192**
 - diffusion, 193-196
 - mobility, 188, 188*f*
 - transverse movement, 193
 - molecular movement through, 196-201.
 - See also* Membrane transport
 - facilitated, 197-198
 - movement, 180
 - peripheral (extrinsic) proteins, **186**, **191**, 191-192
 - phase transition temperature, **194**, 194*f*
 - plasma. *See* Plasma membrane(s)
 - pores, **197**, 197*t*, 197-198, 201-204
 - prokaryotic, 180
 - proteins, 180*f*, 189
 - classification, 186-187
 - diffusion, 193-196
 - distribution, 192
 - functions, 187
 - mobility, 196, 196*f*
 - removal, 186-187
 - sphingolipids, 184-185
 - structure, 189-196
 - erythrocyte as model, 192, 193*f*
 - fluid mosaic model, **189**, 190*f*, 196*f*
 - trilaminar appearance, 180, 180*f*
- Membrane potential, 200, **201**
- in neurons, 921-923

Membrane transport, 180, 196-201

- active, 198, **200**
 - mediated, 199*t*, 206-210
 - primary, of calcium ions, 208-209
 - secondary, 209*f*, 209-210
- of amino acids, **209**
- by diffusion, **196**, 196-197, 197*f*
- electrogenic mechanism, 200, 212*r*
- electroneutral (electrically silent)
 - mechanism, 200, 212*r*
- energetics of, 200-201
- free energy change in, **200**
- of glucose, **209**, 209*f*, 209-210
- by group translocation, **198**
- in mammalian cells, 210, 211*r*
- mediated, 199*f*, 199-200
- passive, 198, **200**
- passive mediated, 199*t*, **204**
- rate of diffusion in, **196**, 196-197, 197*f*
- saturation kinetics, 197*f*, **199**
- steps of, 199-200
 - recognition, **199**
 - recovery, **200**
 - release, **200**
 - translocation, **199**, 199*f*
- systems, **197**, 197*t*
 - characteristics, 198-199, 199*r*
 - loss of, diseases caused by, 212cc
 - saturation kinetics, 197*f*, **199**
 - specificity, 199
- transporters for, **198**.
 - See also* Cotransporter(s); Membrane transport, systems; Transporter(s)

Menkes' syndrome, 750cc, **1132**

Menstrual cycle, mood variations during, 467

Menstruation, 868

Mental retardation, 456cc, 461cc

β -Mercaptoethylamine, 226

6-Mercaptopurine, **151**, 151*f*, 517, **517**, 517*f*

MERRF. *See* Myoclonic epilepsy and ragged-red-fiber disease

Messenger RNA, 25*f* 679

- blocking of 5' terminus, 704, 704*f*
- cap structure, 684*f*, 685, 685*f*, 704, 704*f*
- in cDNA library construction, 777
- codons in, 718*r*, 718-719
- cytoplasmic, 678*r*
- enrichment, 777
- eukaryotic, 684, 684*f*, 714
- functions, 678*r*, 684-685, 714-715
- histone, 685
- leader sequence, 685
- mitochondrial, 678*r*, 685-686
- monocistronic, 684, 714
- polycistronic, 684, 714, 800
- poly(A) synthesis, 704, 705*f*
- poly(A) tail, 685
- precursors, intron removal from, 705-706, 706*f*
- processing, 703-708, 704*f*
- prokaryotic, 714
- properties, 678*r*
- synthesis
 - defects in, 705cc
 - promoters for, 699
- synthetic, polypeptide products, 720, 720*r*
- trailer sequence, 685
- turnover, 709

Metabolic disorders

- of branched-chain amino acids, 479cc
- of tyrosine synthesis, 467cc
- of urea synthesis, 455-456

Metabolic stress, nutritional considerations in, 1133

Metabolism

- in acidosis, 557*f*
- bile acid, 1083*f*, 1083-1084
- in ethanol ingestion, 557*f*
- in exercise, 551*f*
- in illness and recovery, 1092, 1093cc, 1094
- in insulin-dependent diabetes mellitus (IDDM), 548*f*
- interorgan interactions in, 534-536
- interrelationship of tissues, 525-562
- of iron, 1002, **1130**, 1130*f*
- in kidney failure, 556*f*
- in lactation, 553*f*
- in liver disease, 555*f*
- in noninsulin-dependent diabetes, 548*f*
- and obesity, 548*f*, 1094-1095
- oxidative. *See* Oxidative metabolism
- pathways, regulation, 540
- in pregnancy, 552*f*
- in stress, 553, 554*f*
- substrate availability and, 540

Metachromatic leukodystrophy, 425, 429*r*

Metal(s)

- in activation of molecular oxygen, 147
- in oxidation and reduction, 146-147
- structural functions, 145-146

Metal cofactors, in enzymes, 144-147

Metal-bridged complexes, 146

Metalloenzymes, **146**

- copper, 1131

- zinc, 1131

Metalloproteases, **98**

Metallothionein, **1131**

Metarhodopsin, **941**

Methemoglobin, 1030cc

Methionine, **27**, 469*f*, 469-472, 472*f*, 1124, 1125

Methionine adenosyltransferase, **469**

Methotrexate, 150, **518**

- inhibition, 519*f*

- mechanism of action, 150

- structure, and folic acid structure, comparison, 518*f*

Methylase(s), **611**

Methylation, **651**, 745

Methylene groups, **363**

N^5,N^{10} -Methylenetetrahydrofolate

- in deoxythymidylate synthesis, 508-509

- production, **460**, 461*f*

- structure, 508*f*

β -Methylglutaryl coenzyme A. *See* HMG CoA

7-Methylguanosine, **714**

Methylmalonate metabolism, diseases, 480cc

Methylmalonyl CoA, **236**, 374, 479*f*, 1125-1126

Methylmalonyl mutase, **479**

N^5 -Methyltetrahydrofolate, **472**, 1123, 1123*f*, 1126

5-Methylthioadenosine, **499**

5-Methylthioadenosine phosphorylase, **499**

5-Methylthioribose-1-phosphate, **499**

O-Methyltransferase, **468**

Mevalonic acid, 411-412, 412*f*

Micelles, **187**

- bile acid, 1078-1082, **1079**

- in cholesterol transport, 1078, 1081cc, 1082

- formation, 187-188, 1143

- mixed, **1079**, 1080*f*

- structure, 187-188, 188*f*

- in vitamin transport, 1082

Michaelis constant. *See* K_m

Michaelis-Menten equation

- derivation, 139-140

- formulation, **137**, 137-138

- linear form, 138-139

Microbodies, **19**

Microcytic hypochromic anemia, **1130**

Microenvironments, **4**

Microheterogeneity, of glycoproteins, **349**

Micronutrients, 1107-1136.

- See also* Minerals; Vitamin(s)

Microsomes, **16**, 717, **982**

Microtubules, **20**

Microvilli, 1059

Milk, iron binding to, 1003-1004

Milk intolerance, 1075cc

Mineralocorticoid receptor(s), 911

Mineralocorticoids, 1145

Minerals

- macrominerals, 1128-1129

- trace, 1130-1132

Mismatch repair, **627**, 630, **638**, 638-640, 640*f*

- and cancer, 641cc

Mispairing, in DNA synthesis, **624**, 624*f*

Missense mutations, **721**, 721cc

Mitochondria, **17**

- anion transport systems, 205, 205*f*

- ATP synthesis in, 231, 231*f*

- ATP-ADP translocase, **205**, 205*f*, 205-206

- biosynthesis in, 369-371

- in cardiac cells, 239*f*, 241

- electron transport in, 241, 246-249
 - Complex I of, **256**
 - Complex II of, **258**
 - Complex III of, **258**
 - Complex IV of, **258**

- flavin-linked dehydrogenases and, 251, 251*f*, 251*r*

- free-energy changes and, 248-249

- inhibition, 259, 259*f*

- as multicomponent system, 249-255

location in inner membrane, 255-258, 256*f*, 258*f*

- NAD-linked dehydrogenases and, 249*f*, 249-250, 250*r*

- oxidation-reduction reactions and, 247-248, 257*f*

- oxidative phosphorylation and, 260*f*, 260-263

- reversal, 259, 260*f*

- elongation of fatty acids in, 372*f*

inner membrane

- adenine nucleotides in, 245, 245*f*

- calcium transport across, 246, 246*f*

- citrate in, 244-245, 245*f*

- composition, 241

- phosphate in, 245, 245*f*

- substrate transportation systems in, 243*f*, 243-244, 244*f*

- in liver cells, 239*f*, 241, 257*f*

- in Luff's disease, 16cc

Mitochondria

(*continued*)

- membrane
 - compartmentation and, 240*f*, 241*t*
 - enzymatic composition, 241*t*
 - separation, 242, 242*f*
 - structure, 238-246
 - transport across, 381-383, 384*cc*
- messenger RNA in, 685-686
- mutation
 - and aging, 617*cc*
 - and degenerative disease, 617*cc*
- protein import to, 742
- protein synthesis in, 733
- transport systems, 205*f*, 205-206

Mitochondrial cytochrome P450, **989**, 989*f*

Mitochondrial DNA, 617, 830-831, 831*f*, 617*cc*

Mitochondrial F₁F₀-ATPase, **262**, 263*f*

Mitochondrial genes, 830-831

Mitochondrial matrix targeting signal, 742

Mitochondrial myopathies, 247*cc*

Mitochondrial receptor, 742

Mitoplast, **242**

Mitosol, **17**

Mixed function oxidases, **372**

Mixed micelles, **1079**, 1080*f*

MLCK. *See* Myosin light chain kinase

Mobile carriers, **212**

Mobilferrin, 1005*cc*

Modifiers, 151

Modulators, 151

Molar absorptivity, **79**

Molar extinction coefficient (ϵ), **79**

Molecular cell biology, 919-979

Molecular dynamics, **68**

Molecular exclusion chromatography, 72, 72*f*

Molecular weight, and Svedberg coefficient, 71*f*

Molten-globular state, **63**

Molybdenum, **1132**

Monensin, 212*t*

Monoacylglycerol hydrolase, in triacylglycerol hydrolysis, 380-381

Monoacylglycerols, **364**, 1078, **1078**, 1081, 1144

Monoamine oxidase, **468**, **930**, 931, 931*f*

Monoamino dicarboxylic acid, titration, 33-34

Monocarboxylic acids, 211*t*, 431-436

Monoenoic acids, formation, 372

Monofluoroacetyl coenzyme A, **233**

Monofluorocitrate, **233**

Monohydroxyeicosatetraenoic acids, 440

Monomeric enzyme, 152, 153*f*

Monomers, **1057**

Monoxygenase(s), 129, 129*f*, 130, 130*f*, **982**

Monoxygenation reaction, **984**

Monophosphate kinase reactions, **220**, 220*f*

Monosaccharide acid, 1141

Monosaccharide alcohol, **1141**

Monosaccharides, **1073**, **1139**

- absorption, 1076
- derivatives, 1141
- esters, 1141-1142
- reactions, 1141-1142
- structure, 1139-1140
 - in sugar transformation, 336

Morquio syndrome, 352*cc*

6-MP. *See* 6-Mercaptopurine

M-protein, 948*t*

mRNA. *See* Messenger RNA

MRP (multidrug resistance protein), 521

MSD. *See* Multiple sulfatase deficiency

MSH. *See* Melanocyte-stimulating hormone

mtDNA (mitochondrial DNA). *See* DNA, mitochondrial

Mucilaginous fibers, **1097**, 1098*t*

Mucopolidosis

- type I, 349*cc*
- type VII, 352*cc*

Mucopolysaccharides, 1142.

- See also* Proteoglycan(s)

Mucopolysaccharidoses, 352*cc*, **356**

Mucosal secretions, immunoglobulins in, 92*cc*

Multidrug resistance, 521

- transmissible, 816*cc*

Multilamellar vesicles, 189

Multiple nonsimilar domains, **101**, 102*f*

Multiple sulfatase deficiency, 352*cc*, 746*cc*

Multiplex strategy, for PCR, **769**, 769*f*

Multiprenylmenaquinone. *See* Vitamin(s), K₂

Muscarine, 1061, 1061*f*

Muscle. *See also* Skeletal muscle

- cells, 947, 948*f*
- contraction, 946-959
 - calcium in, 954
 - electrical to chemical to mechanical path for, 946-948
 - energy for, source, 954-957
 - model for, 957-959, 958*f*
 - sliding filament model, **946**
- energy reserves in, 537*t*
- fibers
 - carbohydrate metabolism in, 270
 - red, **313**, 315*f*
 - white, **313**, 315*f*
- glycogen in, 313

Muscular dystrophy, 821, 822*cc*

Mutagenesis

- inverse PCR, **790**, 791*f*
- site-directed. *See* Site-directed mutagenesis

Mutarotation, 1141, 1142

Mutases, **133**

Mutations, **721**

- cis-dominant, 805
- deletion, 786-787, 788*f*
- disease caused by, 142, 705*cc*, 706, 707*f*, 828-829
- frameshift, 721, 723*t*
- insertion, 786-787, 787*f*
- missense, **721**, 721*cc*
- mitochondrial, 617*cc*
- nonsense, 721
- operator-constitutive, 805
- perpetuated by replication, 627*f*
- point, **721**
- read through, 721, 722*t*, 723
- repressor-constitutive, 804
- silent, **721**
- suppressor, **723**
- in thalassemia, 828-829
- trans-dominant, 805

MutH, **639**

MutL, **639**

MutS, **639**

MutU, **639**

Myasthenia gravis, 929*cc*

Myelin, lipoproteins, 187

Myoblast cells, **946**

Myocardial infarction, 98*cc*, 292*cc*

- atherosclerosis and, 417*cc*
- enzymes released after, 167*f*
- LDH isozymes and, 172*f*, 173*f*
- serum CPK and, 172*f*
- treatment, efficacy, 168, 169*cc*
- troponin subunits as markers for, 954*cc*

Myoclonic epilepsy, 831

Myoclonic epilepsy and ragged-red-fiber disease (MERRF), 617*cc*

Myofibrils, 946, 947*f*, 948*f*

Myoglobin

- amino acid sequences, 117*t*
- binding characteristics, 115, 115*f*
- comparison with β chain of HbA¹, 118*f*
- Hill plots for HbA₁, 119*f*
- molecular aspects, 114-124
- oxygen binding, 117-119, 119*f*
- oxygen dissociation curve for, 1029, 1029*f*
- oxygen-binding curve, 119*f*
- structure, 114-124, 115*f*, 115-117, 118*f*

Myokinase. *See* Adenylate kinase

Myopathy, 247*cc*

Myosin, **20**, **948**, 948*t*, 949, 949*f*

- actin binding, 950-951
- active site, 950
- amino acid sequences, 950
- essential light chain, 950-951
- light chains, 948*t*, **949**
 - in smooth muscle contraction, 959, 959*f*
- regulatory light chain, 950-951
- subfragment 1 (S-1), 950, 950*f*
- symmetrical tail-to-tail aggregate, 950
- in thick filaments, 949-951

Myosin light chain kinase, 959, 959*f*

Myosin phosphatase, 959

Myotonic dystrophy, 602*cc*

Myristic acid, 191*f*, **192**

N

Na⁺. *See* Sodium

nAChR. *See* Nicotinic-acetylcholine channel

NAD. *See* Nicotinamide adenine dinucleotide

NADH, **227**, 249-250, 250*f*, 273*f*, 278-279, 476

- reoxidation, 279-280

NADH peroxidase, 130

NADH-cytochrome *b*₅ reductase, **988**

NAD-linked dehydrogenases, 249*f*, 249-250, 250*t*

NAD⁺/NADH ratio, alteration, 555-556

NADP. *See* Nicotinamide adenine dinucleotide phosphate

NADP-linked malic enzyme, **371**

NADPH

- oxidation, 463
- synthesis, 336-338, 337*f*, 341

NADPH-adrenodoxin reductase, **989**

NADPH-cytochrome *b*₅ reductase, 372

NADPH-cytochrome P450 reductase, **984**, **988**

NADPH-dependent flavoprotein reductase, 987

NADPH:quinone oxidoreductase, 934*t*

NaHCO₃, intestinal epithelial secretion, 1066, 1067*f*

Na⁺:K⁺ pump, **206**, 206-207, 207*f*, 211*t*

Nalidixic acid, **594**

- NANA. *See N-Acetylneuraminic acid*
- Native conformation, **42**
- NDP-sugar. *See Nucleoside diphosphate sugar*
- Near-equilibrium reaction, **284**
- Negative allosteric effectors, 152
- Negative cooperativity, **872**
- Negative feedback
 - in glycogen synthesis, 326
 - in hormonal cascade, **842**, 843*f*
- Negative superhelical DNA, **587**
- Neomycin, effects on protein synthesis, 734, 734*t*
- Neonatal isoimmune hemolysis, 1020cc
- Neonate(s)
 - cerebral lipid synthesis in, 389
 - nutritional considerations in, 1117cc
 - protein absorption, 1073
- Nephron(s), 1043, 1043*f*
- Nernst equation, **248**
- Nerve deafness, 387cc
- Nerve tissue, hydroxy fatty acid formation in, 373-374
- Nervonic acid, 364, 364*f*
- Nervous tissue, **920-932**
- Nested PCR, 760
- Neural tube defects, **1125**
- Neuraminic acid, **426**
- Neurocan, 356
- Neurological impairment, 237cc
- Neuromuscular junction, **954**, 955*f*
- Neuron-neuron interaction, **923**
- Neurons, 921
 - aminergic, **842**
 - motor, 921*f*
 - presynaptic, 924
 - transmembrane electrical potential in, 921-923
- Neuropeptides, 931-932, 932*t*
- Neurophysin, 842, 849
 - type I, synthesis, 851*f*, 851-852
 - type II, synthesis, 851
- Neurotensin, 848*t*, 932*t*
- Neurotoxins, 203
- Neurotransmitters, **554**, 853, 923, 923*t*
 - actions, 924
 - catecholamine, **929**, 930*f*
 - excitatory, **923**, 924
 - inhibitory, **923**, 924
 - peptide, synthesis, **931**
 - release, 924-927
 - storage, 924-927
 - synthesis, 924-927
 - transport, in mammalian cells, 211*t*
 - tryptophan metabolism and, 476
- Neutral amino aciduria, 1072cc
- Neutron beam radiation, **77**
- Neutrophil(s), function, regulation, 439
- N-glycosidic linkage, **61**, 61*f*, 737
- NHE (Na⁺/H⁺ exchanger). *See Sodium/hydrogen exchanger*
- Niacin, 142, **1121**
 - coenzymes, 142-143, 168*f*
 - deficiency, 476, **1121**
 - in alcoholism, **1121**
 - requirements, 1121
 - synthesis, 1121
- Niacin equivalents, 1121
- Nick translation, 773, 773*f*
- Nicotinamide adenine dinucleotide, 129, 129*f*, **142-143**, 143*f*, 514-515
 - and electron transport, in mitochondrion, 249*f*, 249-250
 - in glycolysis, 278-279
 - optical properties, 168-170
 - and pyruvate dehydrogenase reaction, 228*t*
 - synthesis, 475-476, 513*f*, 517
- Nicotinamide adenine dinucleotide phosphate, **143**, **234**
 - optical properties, 168-170
- Nicotinic-acetylcholine channel, **202**
 - inhibitors, 203
 - in muscle contraction, 203
 - regulation, 202-203
 - subunits, 203
- Nicotinic-acetylcholine receptor, **201**, **928**
 - antibodies, in myasthenia gravis, 929cc
- NIDDM. *See Diabetes mellitus, noninsulin-dependent*
- Niemann-Pick disease, 429*t*, 430, 938cc
- Nigericin, **212**, 212*t*, 213*f*
- Night blindness, in vitamin A deficiency, **1111**
- Nitrate(s), for angina pectoris, 292cc
- Nitric oxide, 457, 534*f*, 535, 995, 996cc
- Nitric oxide synthase(s), **982**, 995-997
 - endothelial (NOS-III), 996, **996**, 996cc
 - gene products, 995-996
 - induced (NOS-II), 996
 - neuronal (NOS-I), 996, **996**, 997*f*
 - reaction catalyzed by, 995
 - structure, 996-997
- Nitrogen
 - entry into human diet, 446, 446*f*
 - excretion. *See Urea cycle*
 - incorporation into amino acids, 447-452
 - interorgan transport, 452-453, 453*f*
 - partial pressure, 1027*t*
- Nitrogen balance, **447**, 447-448, 1089, **1090**.
 - See also Protein-energy malnutrition*
 - factors affecting, 1090, 1090*f*, 1092, 1093cc
 - negative, **447**, 447-448
 - positive, **448**
- Nitroglycerin, for angina pectoris, 292cc
- N-linked glycosylation, **61**, 61*f*, 737
- NMR. *See Nuclear magnetic resonance*
- NO. *See Nitric oxide*
- Nodule DNA, **599**, 599*f*
- Nonactin, 212*t*
- Noncompetitive inhibitors, **148**, 148*f*, 148-149
- Noncovalent bonds, bond strength, 65*t*
- Nonequilibrium reaction, **284**
- Nonheme proteins, 146, 1003
- Non-histone proteins, **605**
- Nonketotic hyperglycemia, 461cc
- Nonpolar molecules, **362**
- Nonsense codons, **719**
- Nonsense mutations, 721
- Nonsteroidal antiinflammatory drugs, **435**
 - non-aspirin, 435
- Nontranscribed spacer regions, **697**
- Norepinephrine, 853, **929-930**
 - actions, 883*t*
 - synthesis, 466-467, **1122**
 - transport, in mammalian cells, 211*t*
 - urinary excretion products, 468*f*
- NOS. *See Nitric oxide synthase(s)*
- Novobiocin, **594**
- NSAIDs. *See Nonsteroidal antiinflammatory drugs*
- Nuclear envelope, **16**
- Nuclear magnetic resonance, two-dimensional (2-D), 81*f*, 81-82
- Nuclear membrane pores, **203**, **204**
- Nuclease(s), **501**, **568**
 - and hydrolyzation of phosphodiester bonds, 568
 - and RNA turnover, 708-709
 - specificities, 568*f*
 - types, 569*t*
- Nucleic acid-hydrolyzing enzymes, 17*t*
- Nucleic acids, 1147
 - detection, 773-775
 - identification, 773-775
 - monomeric units, 490
 - as probes for specific DNA or RNA sequences, 773*f*, 773-774
- Nucleofilament(s), **666**
 - structure, 607*f*, 608, 608*f*
- Nucleoids, **609**
- Nucleolar organizer, **697**
- Nucleolus, **16**
- Nucleophilic substitution, at acyl carbon, 1138
- Nucleoproteins, 601-609
- Nucleoside(s), **1147**
 - deoxyribopyrimidine, 509
 - nomenclature for, 1147
 - purine, degradation, in immunodeficiency, 503cc
 - pyrimidine, 493*f*
 - tRNA, 701
- Nucleoside 5'-diphosphate reductase, **507**
- Nucleoside deaminase, **509**
- Nucleoside diphosphate kinase, 219*f*, **220**, **301**, **319**, 497
- Nucleoside diphosphate sugar, 342, 343
- Nucleoside kinases, 511
- Nucleoside monophosphate kinase reactions, 219*f*, **220**
- Nucleosome core, **605**
- Nucleosomes, **605**, 605*f*, 605-606, 697
- Nucleotidase(s), specificity, 501
- Nucleotide(s), **1147**
 - absorption of UV light, 493
 - adenine, 492*f*
 - balance of adenine and guanine, 500
 - chemistry, 492-493
 - coenzymes, synthesis, 514-516
 - conformational variations, 575*f*
 - deoxyribopyrimidine, 509
 - deoxythymidine, synthesis, 508
 - distribution, 491
 - four-letter alphabet of, 718, 718*t*
 - intervening nucleotide sequences (IVSs), **613**, 613*f*
 - metabolic functions, 490-492
 - metabolism, 517-518, 520
 - nomenclature for, 1147
 - overproduction, 498cc
 - properties, 493
 - purine. *See Purine(s)*
 - pyrimidine. *See Pyrimidine(s)*
 - reformation, 506-507
 - regulation, 490
 - in RNA, 679-680

Nucleotide(s)

*(continued)*sequence, of contiguous and overlapping genes, 612*f*

sequencing, 671-672, 672cc

sources, 490

synthesis, 516-517

uracil, 494*f*

5 -Nucleotide derivatives, 491

Nucleotide diphosphokinase, **505**Nucleotide excision repair, **635**, 635-636

defects, 638cc

in *E. coli*, 636*f*of human DNA, 637*f*

Nucleotide kinase(s), 511

Nucleotide-linked sugars

formation, 341-346, 342*f*

functions, 336

in sugar transformations, 342-343

Nucleotide-metabolizing enzymes, 511-513

Nucleus, **16**

Nutrient(s), 1056.

See also Macronutrients; Micronutrientsabsorption, 1057, 1058*f*

intestinal transport, 1067-1069

Nutrition. *See also* Fasting state; Macronutrients, Malnutrition, Starvation

in alcoholism, 1120cc

in cystic fibrosis, 1112cc

definition, 1088

dietary goals for United States and, 1101-1102, 1102*f*

neonatal, 1117cc

optimal, **1088**

prudent diet and, 1102

recommended balanced diet and, 1101-1103

in renal disease, 1092cc

vegetarian diets and, 1133, 1134cc

well-fed state, 528*f*, 547-548Nutritional status, **1133**

assessment, 1133-1135

factors affecting, 1133, 1133*f***O**OB gene. *See* Obesity gene

OB protein, as anti-obesity drug, 526cc

Obesity, 362, 378cc, 526cc, **527**, 547-548, **1094**

dietary considerations, 1094

genetic considerations, 526cc, 1094

health implications, 1094-1095

leptin and, 378cc

metabolic effects, 1094-1095

and noninsulin-dependent diabetes mellitus, 549cc

weight-reduction regimens and, 1095

Obesity gene, 1094

Obstructive jaundice, and vitamin K deficiency, **1117**

Occipital horn syndrome, 749cc-750cc

Oculocutaneous tyrosinemia, 467cc

O-glycosidic linkage, **61**, 61*f*, 738O-glycosylation, **61**, 61*f*, 738

Oils, 1144

Okazaki fragments, **647**

Oleic acid, 1143

Oligo-1,6-glucosidase. *See* IsomaltaseOligomeric enzymes, 152, **152**

Oligomeric protein, interaction between ligand sites, 154

Oligomycin, **260**Oligonucleotides, **567**, 567*f*, **824**Oligosaccharidase(s), **1059**Oligosaccharides, **187**, **1139**, 1142-1143

ceramide, 1145

globosides, 425

N-glycosylation, 737*N*-linkedbiosynthesis, 737, 738*f*complex type, 737, 739*f*, 740*f*high-mannose type, 737, 739*f*, 740*f*structure, 737, 739*f*, 740*f**O*-linked, structure, 740*f*lipid-linked, **350**biosynthesis, 351*f*

modification, 737

processing, 737

Omeprazole, **1069**, 1069*f*OMP decarboxylase, **506**, 506*f*Oncogenes, **888**, 889*t*One-carbon carrier, **460**Open complex, **695**Open system, 1039-1040, **1040**

Operator, 803

Operator-constitutive mutations, 805

Operons, **800-801**, 800-802.*See also* Lactose operon; Tryptophan operon

bacterial, 813-815

biosynthetic, of *E. coli*leader peptide sequences, 813, 813*f*

transcription attenuation, 813

E. coli, ribosomal protein, 813-814, 814*f**his*, 813self-regulation, 814, 815*f*Ophthalmoplegia, **1120**in thiamine deficiency, **1120**Opioid peptides, 847*t*, 883*t*Opsia, **937**Optical rotation, **80**

Optical rotatory dispersion, 80-81

Optimal nutrition, **1088**

Oral contraceptives

drug-nutrient interactions, 1133*t*

effects on vitamin C serum levels, 1127

folate requirements with, 1125

mechanism of action, 907cc

vitamin B₆, requirements with, 1124ccORC. *See* Origin of replication complex

Organelles

functional role, 15-20

protein targeting to, 739-743

Organic anions, transport, in mammalian cells, 211*t*

Organic chemistry, review, 1137-1147

OriC, **612**, **649**Origin of replication complex, **656**Ornithine, **454**decarboxylation, 459*f*

elevated levels, 481cc

synthesis, 458, 458*f*Ornithine transcarbamoylase, **454**, 455*f*

deficiency, 457cc

Orotate, formation, **505**

Orotic aciduria, 169cc

Osmoreceptor, **881**Osteocalcin, **1117**

Osteogenesis imperfecta, 749cc

type 1, 748*t*type 2, 748*t*

Osteomalacia, 1114

Osteoporosis, **1117**, 1127, 1128, 1128-1129

calcium and, 1128-1129

diet and, 1129cc

Ouabain, 207, 207, 207*f*Ovarian cycle, 866, 867, 869*f*

absence of fertilization and, 868-870

fertilization and, 870*f*; 870-871

programmed cell death in, 916cc

regulation by GnRH, 867*f*, 867-870Overnutrition, **1088**Oxalate, **460**

Oxaloacetate, 232-233, 237

Oxalosuccinate, 234

Oxidase(s), 129, 129*f*mixed function, **372**Oxidation, **381**, 1010-1011, 1012*f*, **1138**, 1143 β -Oxidation

and palmitate biosynthesis, comparison, 383

pathway, 383*f*stages, 382-383, 383*f* β -Oxidation sequence, **226**, 226-227Oxidation states, of iron, **1002**Oxidation-reduction potential, **247**, 247*t*, 257*f*Oxidation-reduction reactions, **129**

Oxidative metabolism, 217-266

Oxidative phosphorylation, **238**, 261*f*, 261-263

Oxidoreductase(s), 129-131

5-Oxoproline, **485**

Oxy-eicosatetraenoic acid, 436-440

Oxygen

partial pressure, 1026, 1027*t*

transport, 1026-1029

Oxygen binding, 115-124, 199*f*, 1031, 1031*f*.*See also* Bohr effect

Oxygen carrier, 1026-1029

Oxygen dissociation curve(s), 1029, 1029*f*Oxygen saturation curve(s), 1028cc, 1028*f*, 1028-1029Oxygenase(s), **129**, 129*f*, **984**Oxyhemoglobin, 115*f*, 122*f*Oxytocin, 842, 848*f*, 851*f*, 851-852, 858, 858*t*, 906Oxytocin transhydrogenase, 858*f***P**

P site, 727

*P*₅₀, 1028PABA. *See* *p*-Aminobenzoic acidPAF. *See* Platelet-activating factorPAI. *See* Plasminogen activator-inhibitor

Pain, 435

Palindromes, 609-611, **610**

Palmitate

biosynthesis, 367*t*acetyl CoA transport, 369-371, 371*f*comparison of schemes for, 385*t*regulation, 367*t*, 369metabolism, free-energy changes associated with, 222*t*

modification processes, 371-374

synthesis, 366

Palmitic acid, 191*f*, **192**, **366**, 1143release, from fatty acid synthesis, 369*f*

synthesis, reaction sequence, 368-369

- Palmitoleic acid, **1143**
- Palmitoyl CoA, in 3-ketodihydroxyphosphingosine synthesis, **420f**
- sn*-1 Palmitoyl-lysocleithin, in
dipalmitoyllecithin synthesis, **408f**
- Pancreas, **1057, 1059**
β cells, **529**
production, **550cc**
exocrine secretion in, cellular regulation of, **1060, 1061f**
functions, **1057, 1058f, 1059**
insulin production by, **550**
- Pancreatic amylase, **1073**
- Pancreatic enzyme(s), **1059**
activation, **1071-1072, 1072f**
deficiency, **1112cc**
essential serine residue, **1071**
secretion, **1071-1072, 1072f**
- Pancreatic lipase, **1078, 1078f**
deficiency, **1112cc**
- Pancreozymin, **1062**.
See also Cholecystokinin
- Pantothenic acid, **226, 1122**
- Papain, myosin cleavage by, **949f, 950**
- Papovavirus, in expression vector, **785**
- PAPS. *See* 3-Phosphoadenosine 5-phosphosulfate
- Paracellular epithelial transport, **1063, 1063f**
- Paracrine hormone(s), **841**
- Paramyotonia congenita, **956cc-957cc**
- Parathyroid hormone, **1112, 1112-1114**
actions, **849t**
in renal osteodystrophy, **1113cc**
source, **849t**
- Parkinson's disease, **467cc**
- Paroxetine hydrochloride (Paxil), **930**
- Partial proteolysis, **76, 743**
- Partially compensated acid-base state, **1046**
- Parvalbumin, **209**
- Parvovirus(es), and primer synthesis, **645**
- Pasteur effect, **269, 288**
- Patch recombinant heteroduplexes, **665, 665f**
- Patch recombinants, **667**
- PCNA. *See* Proliferating cell nuclear antigen
- PCR. *See* Polymerase chain reaction
- Pectin(s), **1056, 1097, 1098t**
- Pellagra, **476, 1121**
- PEM. *See* Protein-energy malnutrition
- Pentose phosphate(s), **336-340, 337f, 339f**
- Pentose phosphate pathway, **336, 336-341, 340f, 1119**
distribution, **341**
phases, **336**
reversible link with glycolysis, **338**
- Pentoses, **1139-1140**
- Pentosuria
essential, **344**
idiopathic, **345cc**
- Pepsin(s), **1056, 1070**
- Pepsin A, **1070, 1071t**
- Pepsinogen, **1070, 1071, 1071t**
autoactivation, **1070, 1071**
autocatalysis, **1070, 1071**
- Peptic ulcers, **436**
- Peptidase(s), **132**
gastric, **1070, 1071t**
intestinal, **1072**
pancreatic, **1071t**
in protein digestion, **1070**
- Peptide(s), **24**
biologically active, **30t**
digestion, **1072**
epithelial transport, **1072**
transport, in mammalian cells, **211t**
- Peptide bond(s), **28, 28-29, 1138**
cis configuration, **29, 29f**
cleavage, **132**
electronic isomer structures, **28f**
formation, **28f, 727-730, 1138**
trans configuration, **29, 29f**
- Peptide hormone(s), **840**.
See also Polypeptide hormones
intestinal, **1062, 1062t**
- Peptide neurotransmitters, synthesis, **931**
- Peptidyl site, **727**
- Peptidyltransferase, **727**
- Periodicity, of polynucleotides, **568**
- Peripheral neuropathy, **387cc**
in vitamin deficiency, **1118**
- Peripheral (extrinsic) proteins, in membranes, **186, 191**
attachment, **191-192**
binding to integral protein, **191f, 192**
electrostatic binding, **191f, 192**
hydrophobic amino acid sequence as anchor, **191f, 192**
- Peripherin, structure, **940f**
- Periportal hepatocytes, **451, 558**
- Perivenous hepatocytes, **451, 558**
- Permease, **198**
- Pernicious anemia, **1125**
- Peroxidase(s), **130**
- Peroxisomes, **19, 390f, 390-391**
in Zellweger syndrome, **20cc**
- Petechiae, **1127**
- PG hydroperoxidase reaction, **433f**
- pH, **7, 10f, 11f, 12cc**
and acid p*K*_a, **32t, 32-33**
of biological fluids, **7t**
blood, hepatic regulation of, **558**
buffering (buffers), **10-12, 11f**
in blood, **12cc**
calculation, **7**
versus conjugate acid and bases, **9-10**
and enzyme catalytic activity, **165-166**
intracellular, **1036**
in 6-phosphofructo-1-kinase regulation, **290f, 290-292**
and ionic form of amino acid, **32**
and ionic form of protein, **32**
isoelectric, **32-33**
optimum, **166**
phosphatase reactions and, **167f**
and p*f*, **35f**
plasma, **1036, 1046**
regulation, **7-12, 1036**
relationship to [H⁺], [OH⁻], and pOH, **7t**
- Phage. *See* Bacteriophage(s)
- Phagocytosis, **18, 18f**
- Phase angles, **77**
- Phase transition temperature (*T*_n), **194**
- pH-bicarbonate diagram, **1040, 1040f-1042f, 1049**
- Phenformin, and lactic acidosis, **291cc**
- Phenobarbital
cytochrome P450 induction by, **986**
and vitamin requirements, **1118cc**
- Phenylacetylglutamine, **456, 456f**
- Phenylalanine, **25, 463**
degradation, **463-469**
high levels, **465cc**
products, **465f**
side chains, hydrophobic interaction
between, **65f**
- Phenylalanine hydroxylase, **464, 464f, 544**
- Phenylethanolamine *N*-methyltransferase, **853, 855f**
- Phenylketonuria, **74cc, 465cc, 544**
- phi (ϕ) bond, **43, 43f**
- Phlorizin, **1077f, 1077t**
- Phorbol esters, **325**
- Phosphacan, **356**
- Phosphatase(s), **17t, 167f, 403f**
- Phosphate
and energy transfer between compounds, **225, 225f**
resonance forms, **224, 224f**
steady-state level, **138**
- Phosphate esters, **492, 492-493**
- Phosphatidic acid, **181, 376, 376f, 1144**
biosynthesis, from glycerol 3-phosphate, **403f**
major alcohols esterified to, in formation of glycerophospholipid, **181, 181f**
synthesis, **377f**
in triacylglycerol synthesis, **377f**
- Phosphatidic acid phosphatase, **403, 403f**
- Phosphatidylcholine, **181, 182f, 397, 1144**
charge on, **184t**
fatty acids in, **182**
in sphingomyelin synthesis, **422, 424f**
synthesis, **404, 404f, 405f, 407, 407f**
- Phosphatidylethanolamine, **181, 182f, 397, 1144**
charge on, **184t**
fatty acids in, **182**
in phosphatidylcholine synthesis, **405f**
in phosphatidylserine synthesis, **406f**
synthesis, **405f**
- Phosphatidylethanolamine-*N*-methyltransferase, transfer of methyl groups by, **405**
- Phosphatidylglycerol, **184t, 397, 398f**
- Phosphatidylglycerol phosphoglyceride, **181, 182f**.
See also Diphosphatidylglycerol
- Phosphatidylinositol, **182, 182f, 397, 398f, 1144**
in anchoring proteins to membranes, **192, 192f**
charge on, **184t**
function, **401-402**
synthesis, **406f**
- Phosphatidylinositol 4,5-bisphosphate, **399, 399f, 862**
- Phosphatidylinositol (GPI) anchor, structure, **402f**
- Phosphatidylinositol cycle, **901, 902**
- Phosphatidylinositol pathway, **883-885, 884t**
- Phosphatidylinositol synthase, **406**
- Phosphatidylserine, **397, 1144**
charge on, **184, 184t**
in phosphatidylethanolamine synthesis, **405f**
synthesis, **406f**
- Phosphoacylglycerols, **1143, 1144**
- 3-Phosphoadenosine 5-phosphosulfate, **356, 356f, 425f, 474, 474f**

- Phosphoanhydride bonds, **218**
- Phosphocholine cytidylyltransferase, **404**
- Phosphocreatine, **551**
- Phosphodiester bonds, **566**, *567f*, 568, 622-627
- Phosphodiester bridge, 397-398
- Phosphodiesterase(s), **568**, **942**, *944f*
- Phosphoenolpyruvate, *224f*, *303f*
- Phosphoenolpyruvate (PEP) carboxykinase, **301**, 301-303, *302f*, *311f*, **312**, **545**
- Phosphoenolpyruvate-dependent phosphotransferase system (PTS), 210
- Phosphoethanolamine cytidylyltransferase, **405**
- 6-Phosphofructo-1-kinase, 274-275, **286**
- in glycolysis, 286-287
 - hormonal control, 292-294
 - regulation, 287-292
 - regulatory features, 283, *283f*
- 6-Phosphofructo-2-kinase, **293**
- bifunctional nature, 295-296
 - cardiac isoenzyme, *298f*
 - covalent modification, *295f*
 - hepatic isoenzyme, *296f*
- Phosphoglucokinase, **316**
- Phosphoglucomutase, **314**, 342
- 6-Phosphogluconate dehydrogenase, **338**
- 6-Phosphogluconate pathway. *See* Pentose phosphate pathway
- 6-Phosphoglucono- γ -lactone, formation, **336**, *337f*
- Phosphoglucose isomerase, 274, **303**
- Phosphoglycerate(s), interconversion, *133f*
- Phosphoglycerate kinase, **225**, *225f*, 276-277
- Phosphoglycerate mutase, 133, 277
- Phosphoglycerides. *See* Glycerophospholipids
- Phosphoguanidines, as energy rich compounds, *223f*
- 4-Phosphoinositol glycerophospholipids, 182
- Phospholipase(s), 1078
- A₁, **406**, *407f*
 - A₂, **406**, *407f*, **434**, **1078**, *1079f*
 - C, 862-865, *865f*, **1060**
- Phospholipids, **180**, 397-409
- asymmetrical distribution of fatty acids in, 406-408
 - detergent properties, **399**, 409
 - fatty acyl groups in, conformation, 182-183, *183f*
 - glycerol ether, **183**, *183f*
 - in human tissues, 397
 - hydrolysis, 1078
 - interactions in aqueous medium, 187, *188f*
 - metabolism, in liver, 409
 - role of, 398-402
 - structure, *396f*, *397f*, 397-398
 - synthesis, 402-409, *403f*, 404-406
- Phosphomannose isomerase, **342**
- Phosphopentose epimerase, **338**
- Phosphoprotein phosphatase, 229, **229**, **295**, **322**, **325**, *325f*, 325-326, **542**
- 5-Phosphoribosylamine, **494**
- Phosphoribosylpyrophosphate, 138cc, **497**, *516f*, 516-517
- Phosphoribosylpyrophosphate synthetase, 138cc, 152cc
- Phosphoric acid anhydrides, as energy rich compounds, *223f*
- Phosphoric-carboxylic acid anhydrides, as energy rich compounds, *223f*
- Phosphorolysis, **314**, 314-317, **1138**
- Phosphorylase α , in liver, 326-327
- Phosphorylase kinase, **322**
- Phosphorylation, *282f*, 342, *543f*
- autophosphorylation, **879**
 - enzyme, **294**, *294f*, *543f*
 - oxidative, **238**, 261-263
 - protein, 878-880, *880f*
 - substrate-level, **262**, **276-278**
- Photochemical dimerization, **629**, *632f*
- Photolyase, **640**
- Photophobia, 467cc
- Photoreceptors, 936, *937f*, 937-943
- Phototherapy, for neonatal hyperbilirubinemia, 1020cc
- Phrenosin, **184**
- pH-velocity profile, 166
- Physiological mediators, 490
- Phytanic acid, **306**, 387cc
- Phylomenaquinone. *See* Vitamin(s), K₁
- pI, **33**, 33-37, *34f*, *35f*
- Picolinate carboxylase, *475f*, **476**
- Picolinic acid, **474**
- Pigmentation, skin, 467cc
- Pigmented epithelial layer, of eye, 936, *937f*
- Pigs, stress syndrome in, 291cc
- Ping-pong mechanism, **140**, 140-142, *141f*
- Pinocytosis, **18**, **750**, **1073**
- Pipecolate, **481**, *481f*
- Pituitary gland
- anterior
 - hormone formation in, 849-851, *851f*
 - hormones, 842, *843f*, *847f*
 - polypeptide hormones of, 844-846, *845f*
 - responsiveness, testing, 844cc
 - tropic hormones, **842**, *843f*
 - disorders, 846cc
 - hormones, in ovarian cycle, *867f*, 867-870
 - posterior, hormones, 842, *843f*, 858, *858f*
- pK_a, **7**, *8f*
- PKU. *See* Phenylketonuria
- Placenta, **552**
- Placental lactogen, **552**, *848f*
- Planned cell death. *See* Apoptosis
- Plasma
- bicarbonate in, *1033f*, 1035-1036
 - buffering (buffers) of, 1036-1038
 - chemical constituents, *14f*
 - composition, 1036-1037, *1037f*
 - immunoglobulins in, 92cc
 - lipoproteins. *See* Lipoproteins, plasma
 - pH, compensatory mechanisms and, 1046
- Plasma membrane(s), **2**, 16, 180, *180f*
- anchoring of glycoproteins to, 401-402
 - characteristics, 396
 - erythrocyte
 - asymmetric distribution of lipids in, 192-193, *194f*
 - fluidity, cholesterol and, 195cc
 - structure, 192, *193f*
 - fluidity, cholesterol and, 195cc
 - functions, 180
 - gap junctions, **203**, *203f*
 - glucose transport across, sodium-dependent, *209f*, 209-210
 - glycoproteins, 187
 - lipids in, 186
 - Na⁺, K⁺-exchanging ATPase. *See* ATPase
 - proteins in, distribution, 192
 - of small intestinal epithelial cells
 - contraluminal, 1063-1064, *1064f*
 - luminal, 1063-1064, *1064f*
 - structure and function, 2-4, 16
 - transport systems, **197**
- Plasma proteins, electrophoretic analysis, *36f*, *37f*, 37cc
- Plasmalogen(s), **183**, *183f*, **398**, 1144
- structure, *398f*
 - synthesis, 408-409
- Plasmid(s), 766, 816
- crown gall, **794**
 - insertional inactivation of, 770, *771f*
 - pBR322, **766**, *767f*, 770
 - pSC101, **766**
 - relaxed-control, **766**
 - stringent control, **766**
- Plasmin, 166, **975**
- and blood clots, **172**
 - production, *975f*, 975-976
- Plasminogen, **975**, 975-976
- Plasminogen activator-inhibitor
- type 1, **976**
 - type 2, **976**
- Platelet aggregation, 398, 436, **960**, **966**, **967**
- Platelet plug formation, 967-968, *968f*
- Platelet-activating factor, **398**, *398f*
- Platelets, in blood coagulation, 966, 967, *968f*
- PMN cell chemotaxis, 398
- PNP. *See* Purine nucleoside phosphorylase
- Point mutations, **721**
- Polarity, of DNA strands, **574**, *576f*
- Polyacrylamide gel electrophoresis, 72
- Polyadenylation signal sequence, **704**, *705f*
- Polyamine(s), 458, *473f*, **609**
- Polycloning, **766**
- Polycyclic aromatic hydrocarbons, **985**
- Polycythemia, 722cc
- Polylinker, **766**
- Polymer(s), in food, **1057**
- Polymerase(s)
- RNA. *See* RNA polymerase(s)
 - Polymerase(s), DNA. *See* DNA polymerase(s)
- Polymerase chain reaction, 583cc, **759**, *759f*, 759-760.
- See also* Reverse transcriptase PCR
 - clinical applications, 760
 - versus cloning, 768-770
 - inverse PCR mutagenesis, **790**, *791f*
 - multiplex strategy, **769**, *769f*
 - analysis of HGPRTase gene defects in Lesch-Nyhan syndrome, 770cc
 - nested, 760
 - and screening for HIV, 760cc
- Polymeric allosteric enzyme, *153f*
- Polynucleosomes, *604f*, **605**, 605-608
- Polynucleotide phosphorylase, **720**
- Polynucleotides, **1147**
- conformation, forces determining, 569
 - formation, 566-568
 - helical, single-stranded, conformation, *569f*
 - nomenclature, 567
 - ribose-phosphate backbone, *572f*
 - stabilization, 569
 - stacked conformation, *569f*

- structure, in DNA, 567*f*
- unstacked conformation, 569*f*
- Polyol (aldose) dehydrogenase, **935**
- Polyol pathway, 551cc
- Polypeptide(s), **28**
 - domain structures, 47-48
- Polypeptide bond, 43*f*
- Polypeptide chains, 43*f*
 - antiparallel β -structure, 45*f*
 - noncovalent association, 48
 - β -pleated structure, 45*f*
 - β -structure, 45*f*
- Polypeptide hormone(s). *See also specific hormone*
 - actions, 846-849, 847*t*-849*t*
 - of anterior pituitary, 844*t*, 844-846, 845*f*
 - containing cystine disulfide bridge, 858, 858*t*
 - degradation, 857-858
 - formation, 849-853
 - genes, 849-853
 - inactivation, 857-858
 - intracellular action, 878-888
 - receptor interactions. *See* Hormone-receptor interactions
 - receptors
 - internalization, **859**, 876-878
 - structure, 875*f*, 875-876, 876*f*
 - secretion, cell regulation and, 859-866
 - signal transduction, G-proteins in, 859-860, 860*t*
- Polyphosphate(s), synthesis, 400-401
- Polyprenyl side chain, **927**
- Polyproline type II helix, **52**
- Polysaccharide-hydrolyzing enzymes, 17*t*
- Polysaccharides, **1139**, 1142
 - branched, 1142
 - hydrolysis, 1073-1076
 - nonreducing end, 1142
 - reducing end, 1142
 - synthesis, 346
- Polysomes, **716-717**
- Polytene chromosomes, **607**
- Polyunsaturated acids, **365**
- POMC. *See* Proopiomelanocortin
- Pompe's disease, 317cc
- Poor metabolizers, **986**
- Porcine stress syndrome, 291cc
- Pores
 - membrane, **197**, 197*t*, 197-198, 201-204
 - nuclear, **204**
- Porins, 201, **204**
- Porphobilinogen, 1012, **1013**, 1015*f*
- Porphobilinogen deaminase, 1013-1014
- Porphobilinogen synthase. *See* Aminolevulinic acid dehydratase
- Porphyria(s), **1011**, 1012*t*, 1014
- Porphyria cutanea tarda, 1012*t*, **1014**, 1014-1015
- Porphyrin, **236**, **1010**, 1012*t*
- Porphyrinogen(s), **1009**, 1009-1010
 - oxidation, 1010-1011, 1012*f*
- Positive allosteric effectors, 152, 153*f*
- Positive cooperation, **119**
- Positive modulators, 153
- Postreplication repair, 641, 641*f*
 - of rare lesions, **634**
- Postreplication SOS repair, **634**, 642, 642*f*
- Posttranscriptional cleavage, 823
- Potassium, transport
 - across plasma membrane, erythrocyte ghost studies, 207-208, 208*f*
 - active, 206
- Power stroke, in actin-myosin interaction, 959
- Precursor function, 491
- Precursor RNA molecule, 699
- Pregnancy, **552**
 - blood glucose regulation during, 552
 - folic acid requirements in, 1125
 - hormonal changes during, 552
 - nitrogen balance in, 448
 - starve-feed cycle during, 552
 - steroid hormone production during, 993cc
 - ⁵-Pregnenolone, in steroid synthesis, **896**, 898, 899*f*
- Preinitiation complex, **725**
- Prekallikrein, 961*t*, 961-963
 - deficiency, 963cc
- Preproinsulin, 743, 832
- Presbyopia, **934**
- Presynaptic neurons, **924**
- Pribnow box, 692, 695
- Primary transcript, **699**
- Primase(s), **644**, **655**
- Primer(s), **623**
 - for DNA replication, 644-645
 - RNA, 645*t*
 - synthesis, 644*f*
- Primosome, **650**, 651*f*
- Probes, 582, 583, 773-774
- Processivity, **623**
- Prochiral substrates, **158**
- Procollagen, formation, 746-747
- Product inhibition, **140**
- Proenzyme(s), **101**, 1059-1060, **1060**
- Progestational hormones, 894, **894**, 896
- Progesterone, 894, **896**
 - actions, **868**
 - excretion pathway, 902*t*
 - functions, 895*t*
 - metabolism, 991
 - secretion, 895*t*, 903*t*, 905*f*
 - structure, 895*t*
 - synthesis, **898**, 903*t*, 905*f*
- Programmed cell death. *See* Apoptosis
- Progress curve. *See* Reaction(s), velocity
- Progression-linked cell changes, **513**
- Prohormones, **858**
- Proinsulin, 39, 40*f*, 743, 744*f*
- Prokaryotes
 - definition, **2**, 3*f*
 - DNA, 611-613
 - genome size, 614
 - nucleoproteins, 609
 - organization, 3*f*
 - transcription in, 692-696, 693*f*
- Prokaryotic cells. *See* Prokaryotes
- Prokaryotic replication, 658*f*, 659, 659*f*
- Prolactin, 824, 846, 847*t*
- Prolactin release-inhibiting factor, 844*t*, 847*t*
- Prolactin-releasing factor, 844*t*, 847*t*
- Proliferating cell nuclear antigen (PCNA), **626**, **654**
- Proline, **27**, 458, 458*f*
- Promoter(s), 690, 690*f*, 697-698, 803
 - internal, **690**
 - for mRNA synthesis, 699
 - transcription factor interaction with, 698, 698*f*
- Pronucleus, 835
- Proofreading, **624**, **723**
- Proopiomelanocortin, 849, 850*f*, 850*t*, 851*f*
 - gene, **911**
- Propeller twist, **573**, 573*t*
- Propionate, **306**, 306-307, 307*f*, **559**
 - metabolism, diseases, 480cc
- Propionyl CoA, **384**, 384*f*, **479**
 - interconversion, 479*f*
 - metabolism, 479
 - production, 384
- Propionyl-CoA carboxylase, **479**, 1122
 - defect in, 480cc
- Proportionality constant (k), 134
- Prostacyclin, 883*t*, **968**
- Prostaglandin(s), 431-436, 1143
 - classes, 433
 - dietary precursors, 433
 - metabolism, inhibition, 435
 - PgG₂ conversion to PgH₂, 433*f*, 434
 - PgH₂
 - formation, 433*f*, 434
 - in thromboxane B₂ synthesis, 435, 435*f*
 - PgI₂, 1099cc.
 - See also* Prostacyclin
 - PgI₂, 1099cc
 - physiological effects, 435-436
 - principal, in humans, 433-444
 - structure, 431*f*, 1143
 - synthesis, 432*f*, 433-435, 435*f*, 435-436, **1097**
 - vasodilators, 436
- Prostaglandin synthase, **434**
- Prostaglandin synthase (PGS) complex, **434**
- Prostanoic acid, 432*f*, 433
- Prosthetic group, **115**, **128**
- Protanopia, **945**
- Protease(s), 1070
 - aspartate, **98**
 - cysteine, **98**
 - metallo, **98**
 - serine. *See* Serine protease(s)
- Proteasomes, **751**, 752*f*
- Protein(s), **24**
 - absorption, 1070*f*, 1070-1073
 - fetal, 1073
 - neonatal, 1073
 - acid-base balance and, 32-33
 - acidic, 30-31, **31**, 31*t*
 - amino acid sequence, 25*f*, 25-30
 - cleaving reagents, 75*f*, 75-76
 - determination, 74*f*, 74cc, 74-78, 76*f*
 - basic, 30-31, **31**, 31*t*
 - carbohydrate linkages, 61, 61*f*, 62cc
 - cellular concentrations, 68, 68*f*
 - chaperone, **63**
 - charge, separation by, 69-71
 - chemical properties, 30-39
 - common acid groups, p*K*_a, 31*t*
 - composition, 23-85
 - deficiency, 527cc
 - degradation, 452-453, 750-752
 - premature, in cystic fibrosis, 752cc
 - ubiquitin-dependent, 751*f*, 751-752
 - denaturation, **1070**
 - denatured, 67-68

Protein(s)

(continued)

digestion, 1070*f*, 1070-1073

dissociation constant (K'), **30**, 30-31, 31*r*

families, **88**

fibrous, 50-55

folding (noncovalent interactions), 62-67, 64*f*

function, 24-25

globular, **50**, 79*f*

glycation, 538*cc*

glycosidic linkages to amino acids in, 61*f*

with glycosyl phosphatidylinositol anchors, 192, 192*r*

glycosylation, 736-739

α -helical structure, 43-44

heme-containing, 1003-1005

heterotetrameric, **942**

higher-level organization, 42-49

HMG (high mobility group), **608**

H-NS, **609**

HU, **609**

import to mitochondria, 742

ionic form, 32

ionizable groups, and biological function, 30-39

iron-containing, 1003-1005

mass or size, separation by, 71-72

maturation, 735-739

membrane, 189

- diffusion, 193-196
- distribution, 192
- integral (intrinsic), **187**, 190-191, 191*f*
- mobility, 196, 196*f*
- peripheral (extrinsic), **186**, **191**
- transmembrane segment, 190, 191*f*

multidomain, **46**, 46-48, 47*f*

multifunctional, **494**

native conformation, **42**

non-histone, 601-608, **605**

oligomeric, interaction between ligand sites, 154

phosphorylation-dephosphorylation, 878-880, 880*f*

pI values, 34*r*, 35-36

pinocytosis, **1073**

plasma, Svedberg coefficients, 72*r*

posttranslational modification

- absence of, 746*cc*
- amino acid modification in, 744-746, 745*r*
- incorrect, in cystic fibrosis, 752*cc*

posttranslational modifications, **735**, 743-748

primary structure, **28**, 39-42

quaternary structure, **42**, 48-49

scaffold Sc1 and Sc2, **608**

secondary structure, **42**, 43*f*, 43-44

secretory pathway, 735-736, 736*f*

sequestration, by Golgi apparatus, 17

serine protease inhibitors, 103, 103*r*

sorting, in secretory pathway, 739-742

stability, 62-68

steady-state concentration, 68*f*

β -structure, 44, 45*f*

structure, 23-69

- bond strength, 65*r*
- characterization, 69-82
- conformation, **62**
- dynamic flexibility, **76**
- fluctuation, 65*r*
- purification, 69-74
- spectroscopic determination, 79-82
- stability, 63-67
- study, 69-82

structure-function relationships, 87-126

superfamily, **97**, 97*f*

supersecondary structures, 44, **44**

synaptic vesicle, 925, 925*f*, 925*r*, 926*f*

synthesis, 552-553, 683, 713-755.

See also Translation

- antibiotics and, 733-735
- elongation in, 727-730, 728*f*-729*f*
- in *Escherichia coli*, stringent control of, 815, 815*f*
- initiation, 725-727
- in mitochondria, 733
- termination, 732*f*, 733
- toxins and, 733-735

targeted to lysosomes, 739-742, 741*f*

targeting, signals for, 742-743

tertiary structure, **42**, 44-47, 46*f*

turnover, 447, 750-752, 1089

in visual cycle, 943, 944*r*

Protein, dietary, 1056-1057, **1089**

absorption, 1070*f*, 1070-1073

animal, 1091, 1101

contribution to daily nutrient supply, 1056, 1056*r*

digestion, 1070*f*, 1070-1073

energy content of (kcal), 1088

and energy production, 1089

intake, 1056*r*

- average American, 1094
- and calcium requirements, 1094
- excess, 1094-1095
- recommended, **1091-1092**, 1101

metabolism, 1089-1092

in renal disease, 1092*cc*

requirements, 1089

- and diet, 1091-1092
- growth-related, 1092
- in illness and recovery, 1092, 1093*cc*, 1094
- mixed animal and vegetable sources for, 1101

vegetable, 1091, 1101

in vegetarian diets, 1091, 1091*cc*

Protein C, 961*r*, 969, 970, **972**, 972-974, 974*f*

defects, thrombosis caused by, 971*cc*, 974

recombinant, primary structure, 973*f*

Protein data bank, **77**

Protein families, 87-126

Protein inhibitors, 103, 103*r*Protein kinase(s), **229**

catalytic domains, 879, 879*f*

and hormone action, 878-888

and inactivation of pyruvate dehydrogenase complex, 229

Protein kinase A, **294**, 295, **541-542**, 862, 862*f*Protein kinase A pathway, **862**, 862*f*-864*f*, **878**, 880-883, 883*r*Protein kinase C, **865**, **878**

activation, 865-866

stimulation, 904

subspecies, 885, 885*f*

Protein kinase C pathway, **878**, 883-885, 884*r*Protein kinase G pathway, **878**, 885-888Protein kinase M, **885**Protein malnutrition, 527*cc*Protein S, 970, **974**

deficiency, 974

Protein sparing, **1091**Protein-energy malnutrition, **1093**, 1093-1094Protein-hydrolyzing enzymes, 17*r*Proteoglycan(s), **351-352**, 351-357

clinical correlations, mucopolysaccharidoses, 352

functions, 353

structure, 352-353

synthesis, 355*f*, 356-357

Proteolipids, **187**

Proteolysis, and zymogen activation, 743-744

Proteolytic enzymes, 98-99, 132

Prothrombin, **964**, 964-965, 965*f*, 969

activation, 965, 966*f*, **1116**

carboxylation, **1116**, 1116-1117

Prothrombinase complex, 964-965

Protomers, **152**Proton acceptor, **7**Proton donor, **7**Protoporphyrin IX, **983**, **1003**, **1009**Protoporphyrinogen, conversion to porphyrin, 1010-1011, 1012*f*Protoporphyrinogen IX oxidase, action, 1012*f*

Protoporphyrinogen oxidase, 1016

Protransglutamidase, 967

Proximal histidine, **115**PRPP. *See* 5-Phosphoribosyl-1-pyrophosphatePrudent diet, **1102**

Pseudo-first-order reactions, 135

Pseudogenes, **615**, 826Pseudouridine, **701**, 1147Psi (Ψ) bond, **43**, 43*f*PTH. *See* Parathyroid hormonePUFAs. *See* Fatty acids, polyunsaturatedPUFA/SFA ratio, **1099**, 1099*cc*, 1100Pulmonary surfactant. *See* SurfactantPump(s), **198**

Na⁺, H⁺, 211*r*

Na⁺, K⁺, **206**, 206-207, 207*f*

proton, vacuolar, **927**

Purine(s), 489-523, **1146**

analogs, as anti-viral agents, 520

bases

- salvage, 516
- structure, 492*f*

degradation, 501-502, 502*f*

enzymes, 512-513

in gout, 490

interconversion, 500, 500*f*

in Lesch-Nyhan syndrome, 490

major derivatives, in cells, 492-493

metabolism, 489-503, 517-521

overproduction, 497-498

oxygenated, 1146-1147

in RNA, 679-680

structure, 219*f*, 1146

synthesis, 150, 494, 1123

- de novo*, **493**, 500, 519*f*
- regulation, 497*f*, 497-498

Purine nucleoside(s), degradation, in immunodeficiency, 503*cc*Purine nucleoside phosphorylase, **501**, 503*cc*

deficiency, and T-cell immunity defects, 502

Purine ribonucleotides, *de novo* synthesis, 495*f*

Purine ring, sources of carbon and nitrogen in, 496*f*

Puromycin, effects on protein synthesis, 734, 734*r*, 735*f*

Putrescine, synthesis, 459*f*

Pyranose rings, 1140

Pyridoxal, **1121**

Pyridoxal phosphate, 142, **449**, 449*f*, **1121**

- in aldimine linkage to lysine residue, 449*f*
- in amino acid metabolism, 460
- in heme synthesis, **1012**
- metabolic roles of, 1121-1122, 1122*f*
- in transamination reaction, 449*f*
- in tryptophan metabolism, 476

Pyridoxal-dependent decarboxylase, 450*f*

Pyridoxamine, **1121**

Pyridoxine. *See* Vitamin(s), B₆

Pyrimidine(s), **1146**

- analogs, as anti-viral agents, 520
- bases, 493*f*
- carbon and nitrogen atoms in, sources of, 506*f*
- degradation, 509-511, 510*f*
- in immunodeficiency, 490
- interconversions, 509, 509*f*
- metabolism, 489-507, 517-521
- in orotic aciduria, 490
- oxygenated, 1146-1147
- in RNA, 679-680
- salvage, 506-507, 517
- structure, 219*f*, 1146
- synthesis, 150, 504*f*, 504-506

 - de novo*, 516
 - in hereditary orotic aciduria, 505*cc*
 - regulation, 506, 506*f*, 512-513
 - during S phase, 512-513

Pyrimidine nucleoside(s), 493*f*

Pyrimidine phosphoribosyltransferase, **506**

Pyrogens, 436

Pyroglutamic acid, 857, 857*t*

Pyrophosphatase, **319**, 722

Pyrophosphate, 135, 224, **224**, 224*f*

Pyruvate, 227, 227*f*

Pyruvate carboxylase, 133, 133*f*, **302**, **309**, 1122

Pyruvate dehydrogenase, **227**, 1119

- deficiency, 233*cc*
- from *E. coli*, 228, 228*f*
- reaction, 230*f*, 305, 369-370

 - coenzymes and, 228, 228*r*, 229*f*
 - prosthetic groups and, 228, 228*t*

- regulation, 228-231, 230*f*

Pyruvate dehydrogenase complex, 227-228, 230*f*, **928**

Pyruvate kinase, **146**, **225**, 225*f*, **298**

- deficiency, 299*cc*
- in glycolysis, 298-299
- hepatic, inactivation, 299*f*
- reaction catalyzed by, 147*f*, 273*f*, 278
- regulatory features, 283, 283*f*

Pyruvoyl prosthetic group, enzyme formation with, 461*f*

6-Pyruvoyl-tetrahydropterin synthase, **500**

Q

Quantal event, **925**

Quaternary ammonium ion, 1138

Quencher, **80**

Queuosine, **701**

Quinolinate, as neurotransmitter, 476

Quinoproteins, synthesis, 469

R

R conformational state, **123**, 1029

Rab3, **927**

Racemase(s), **133**, 133*f*

Raffinose, 1074*r*, **1076**

Random coil, **569**

Random primer labeling of DNA, 773

Rate, 133, 134-135

Rate constant k_{11} , 134, **134**

Rate of diffusion, **196**, 196-197, 197*f*

Rate of reaction, **128**, 134-135

Rate-limiting enzymes, **174**

Rates of reassociation, **614**

RDAs. *See* Recommended dietary allowances

RDS. *See* Respiratory distress syndrome

Reaction(s)

- activation energy (E_a), 149
- enzyme-catalyzed

 - initial velocity (v_i), **137**, 137*f*
 - mechanism, 159
 - progress curves, 133*f*
 - substrate saturation curve, 137

- nonequilibrium, **284**
- nucleophilic substitution, 1138
- order, substrate concentration as function of, 168*f*
- oxidation-reduction, 1138-1139
- potential energy barrier, overcoming, 149
- rate, **128**
- reversibility, 135
- stereospecificity, **143**
- types, 1138-1139
- velocity, **128**, 133-135, 136*f*
- zero-order, **135**

Reaction half life ($t_{1/2}$), 134

Read through mutations, 721, 722*t*, 723

Reading frame(s), **720**

RecA protein, **642**, **665**, 666*f*

RecBCD enzyme, **665**, 666*f*

Receptor(s). *See also* Hormone-receptor interactions

- cellular, **840**, 840*f*
- structure, 875-876

Receptor-mediated endocytosis, **416**, **750**

Receptosomes, **877**

RecJ, **639**

Recognition, in membrane transport, **199**, 199*f*

Recognition helix, **108**

Recognition sites, specific, 396

Recombinant DNA, **765**, **824**, 824-827

- in agriculture, 794-795
- bacterial transformation with, 767
- formation, 765*f*, 765-766
- in gene library, 768
- historical perspective on, 758-759
- technologies, **765**, 790-795
- vectors, 766

Recombinase(s), **662**, **668-669**

Recommended dietary allowances, **1109**

Recommended protein intake, **1091-1092**

Recovery, in membrane transport, **200**

Red blood cell(s). *See* Erythrocyte(s)

Red pigment, 937

Redox couples, **247**

Reducing equivalents, **222**

Reducing sugar, **1142**

Reductant, **1005**

5 α -Reductase, **898**, 901

Reduction, **1138**, 1143

Reductive biosynthesis, **338**

Refed state, early, 533-534

Refinement, 77

Refsum's disease, 362, 387*cc*

Regulator protein, recognition site, on lactose operon promoter sequence, 805*f*, 806-807

Regulatory subunits, 155, **155**, 155*f*

Relaxin, 848*t*

Release, in membrane transport, **200**

Release factor(s), **733**

Releasing hormones, **842**, 843*f*, 844*t*, 857, 857*t*

Remodeling reactions, 406-408

Renal failure, and metabolic changes, 553

Renal osteodystrophy, 1113*cc*

Renal tubular acidosis, 1042

Renaturation of DNA, 580-582

Renin, **901**

Renin-angiotensin system, **901**, 905*f*

REP (repeated extragenic palindromic elements), **612**

Rep protein(s), **648**, **651**

Replication, mutation perpetuated by, 627*f*

Replication complex, origin, **656**

Replication factor A (RFA), **656**

Replication factor C (RFC), **654**

Replication origin, **649**

Replication protein A (RPA), **656**

Replicative transposition, **670**

Replicons, **654**, **766**

Replisome, **649**, 649*t*

Reporter gene, 787

Repressed genes, **608**

Repression, **801**

Repressor-constitutive mutations, 804

Reproduction, human, 436

Resolvase, **667**, **670**

Resonance forms, **224**

Resonance isomers, **28**

Respiratory distress syndrome, 399, 400*cc*

Respiratory quotient, 551

Respiratory system, anatomy, 1027, 1027*f*

Response elements, **985**

Resting potential, of rod cell membrane, 941

Restriction digest(s), **611**, **671**

Restriction endonuclease(s), **568**, **609**, 609-611, 758, **760**, 760-762

- in restriction mapping, 760-761
- sites of DNA cleavage by, 610*t*
- type II, 610, 760

Restriction enzyme(s), 824, 825*f*

Restriction fragment length polymorphism, 775

- and clonal origin of tumors, 776*cc*

Restriction maps, **671**, 671-672, 760-762, **761**, 761*f*

- and evolution, 762*cc*

Restriction site bank, **766**

Reticulocytes, **824**

Retina, **932**, **935**

- ATP source for, 935-936

- Retina
- (*continued*)
- carbohydrate metabolism in, 270
 - structure, 937*f*
- Retinal, **1109**, 1110-1111
- isomerization, **936**
- 11-*cis*-Retinal, **937**, 937-938, 939*f*, 941*f*, 944
- all-*trans*-Retinal, 941, 944
- Retinitis pigmentosa, 387cc, 938cc
- peripherin gene mutation in, 940cc-941cc
- Retinoic acid, 894, 914, 914*f*, **1109**, 1110-1111
- Retinoic acid receptor(s), 912, **912**, 912*f*, 914
- Retinoid X receptor, 912, 912*f*
- Retinol, **1109**, 1109-1111
- 11-*cis*-Retinol, 941-942
- all-*trans*-Retinol, 942
- all-*trans*-Retinol dehydrogenase, 942
- Retinol equivalents, 1109
- Retinyl phosphate, **1110**, 1110-1111
- Retrovirus(es), **660**
- Reverse genetics, **792**
- Reverse phase high-performance liquid chromatography (HPLC), **73**, 73*f*
- Reverse transcriptase, **659-660**, **824**
- inhibitors, 661cc
- Reverse transcriptase PCR, 778, 779*f*
- Reverse transcription, 679
- Reversible link, **338**
- Reversible noncompetitive inhibition, 149, 149*f*
- Reye-like syndrome, 385cc
- Reye's syndrome, 533, 533cc
- RFLP. *See* Restriction fragment length polymorphism
- Rh antibody(ies), 1020cc
- Rhodanese, **474**
- Rho-dependent terminators, **696**
- Rhodopsin, **937**, 938*f*, 939*f*, 944*t*
- active, **941**
 - gene, 944-945
 - light activation of, 942
 - regeneration, 943
 - structure, 940*f*
- Rhodopsin kinase, 943, 944*t*
- Rho-independent terminators, **696**, 696*f*
- Riboflavin, 142, **1121**
- coenzyme forms, 143-144
 - deficiency, **1121**
 - in alcoholism, **1121**
- Ribonuclease. *See* RNase
- Ribonucleic acid. *See* RNA
- Ribonucleoprotein particles, 16, 686
- Ribonucleoside 5'-monophosphates, 679-680
- Ribonucleoside diphosphates, reduction, in deoxyribonucleotide synthesis, 507-511
- Ribonucleotide(s)
- in 2'-deoxyribonucleotide synthesis, 507*f*
 - concentrations in cells, 491
 - purine, *de novo* synthesis, 495*f*
- Ribonucleotide reductase, 507*f*, 508*f*
- Ribose, structure, 1140
- Ribose isomerase, **338**
- Ribosomal protein(s)
- operon, *E. coli*, 813-814, 814*f*
 - synthesis, 813-814, 815*f*
- Ribosomal RNA, 679
- cytoplasmic, 678*t*
 - DNA for, repetitive sequence in, 823, 823*f*
 - functions, 678*t*, 683
 - genes, transcription, 697-698
 - mitochondrial, 678*t*
 - mutation, and antibiotic-induced deafness, 734cc
 - processing, 702-703, 703*f*
 - self-cleaving, 686, 687*f*
 - structure, 678*t*, 683, 684*f*
 - synthesis, 678*t*, 683, 815
- Ribosomes, **16**, 683, 813
- classification, 715, 715*t*
 - composition, 715, 715*t*
 - free, 717
 - functional sites, 715, 716*f*
 - membrane-bound, 717
 - mitochondrial, 733
 - in protein synthesis, 715-717
 - self-assembly, 715
 - structure, 715, 716*f*
 - subunits, 715-717, 716*f*, 717*f*
- Ribozymes, **686**
- Ribulose, structure, 1140
- Ribulose 5-phosphate
- disposal mechanism for, **338**
 - interconversion, 339
 - isomerization, **338**
 - synthesis, 338
- Ricin, effects on protein synthesis, 735
- Ricketts, 212cc, **1114**
- Rifampicin, RNA polymerase and, 691, 692cc
- Rigor mortis, 957
- RNA, **16**, 678.
- See also* Transcription
 - antisense, **792**
 - base pairing in, 680, 681*f*
 - binding sites for other molecules, formation, 688-689
 - catalytic activity, 686-688
 - cellular, characteristics, 678*t*
 - classification, 678*t*, 679
 - hairpin structures, 680
 - helical structure, 680, 680*f*
 - heterogeneous nuclear (hnRNA). *See* Heterogeneous nuclear RNA
 - lariat structure, 706, 707*f*
 - messenger (mRNA). *See* Messenger RNA
 - precursor, introns in, 820
 - in ribonucleoprotein particles, 686
 - ribosomal (rRNA). *See* Ribosomal RNA
 - secondary structure, 680, 680*f*-682*f*
 - small cytoplasmic (scRNA). *See* Small cytoplasmic RNA
 - small nuclear (snRNA). *See* Small nuclear RNA
 - splicing, 705, **820**
 - alternate, and protein diversity, 706-708, 708*f*
 - signals, mutations, and disease, 705cc, 706, 707*f*
 - structure, 679-681, 680*f*
 - synthesis, 16, 678*t*, 679, 693*f*, 693-695, 694*f*
 - asymmetry in transcription and, 694, 694*f*
 - template, in DNA synthesis, 660
 - tertiary structure, 680-681
 - transfer (tRNA). *See* Transfer RNA
 - types, 681-689
 - U1, 705, 706*f*
 - U2, 705
 - viral, hammerhead structure, 686, 688*f*
- RNA polymerase(s), 689, 803
- antibiotics and, 691, 692cc
 - E. coli*, 691, 691*t*
 - I, 691, 691*t*
 - II, 691, 691*t*, 698, **698**, 698*f*
 - III, 691, 691*t*, 699, 700*f*
 - mitochondrial, 691, 691*t*
 - in primer synthesis, **644**, 645*t*
 - properties, 691, 691*t*
 - reaction catalyzed by, 690-691
 - recognition site, on lactose operon promoter sequence, 805*f*, 806-807
- RNA probes, 770, 773-774
- RNase, 160*f*, 161*f*, **709**
- RNase P, **686**
- RNPs. *See* Ribonucleoprotein particles
- Rods, **936**, 937*f*, 937-943
- membrane potential, changes after light pulse, 941, 942*f*
 - physicochemical properties, 945-946
 - steady-state potential, 942
- Rolling circle replication, **652**, 652-653, 653*f*
- Rotenone, **259**
- Rotor's syndrome, 1021cc
- Rough endoplasmic reticulum, 16, 735, 736*f*
- Rous sarcoma virus, in expression vector, 785
- rRNA. *See* Ribosomal RNA
- RuvA, **667**
- RuvAB protein, **665**
- RuvAC protein, **665**
- RuvB, **667**
- RuvC endonuclease, **667**
- S
- S1 nuclease, **824**
- Saccharidases, 1075, 1076*t*
- Saccharopine, **481**
- Salicylate poisoning, 1049cc
- Salivary glands, functions, 1057, 1058*f*
- Salmonella*, gene inversion in, 818-819, 819*f*
- Salt bridges, in deoxyhemoglobin, 122*f*
- Salt linkages. *See* Electrostatic interactions
- Salts, **4**, 1143
- SAM. *See* S-Adenosylmethionine
- Sandhoff-Jatzkewitz disease, 349cc, 429*t*
- Sanfilippo, 352cc
- Sanger procedure, of DNA sequencing, 763-765, 764*f*, 765*f*
- α -Sarcin, effects on protein synthesis, 735
- Sarcomeres, 946, 947*f*, 948
- Sarcoplasmic reticulum, **329**, **947**, 948*f*
- SARs (scaffold attachment regions), **608**
- Satellite DNA, **614**
- sequences, **616**
- Saturation kinetics, 197*f*, **199**
- Scaffold attachment regions. *See* SARs
- Scaffold proteins, **608**
- Scatchard analysis, **872**, 872*f*, 873*f*
- Schiff base, **449**, 449*f*, 449-450
- Scurvy, 749cc, **1127**
- Second messenger(s), 180, **208**, 328, **840**, 862-865
- Second order reactions, 134, **135**
- Secondary interactions, **101**
- Secondary structure, regular, **43**, 43*t*
- Secretagogues, **1060**, 1061*t*
- Secretin
- actions, 848*t*
 - as secretagogue, 1061*t*, 1063

- source, 848*t*
- structure, 1062*t*, 1063
- Sedoheptulose, formation, 339
- Selenium, **1132**
- Selenocysteine, **460**, 460*f*
- Semiconservative process, 64*f*, **643**, 643-644
- Senile cataracts, **935**
- Sense strand, 692
- Sepiapterin reductase, **500**
- Sequential induced-fit model, 154
- Sequential mechanism, **142**
- Serine, **27**, **350**, 351*f*, 459-460
 - in 3-ketodihydrospingosine synthesis, 420*f*
 - hydroxymethyltransferase, 461*f*
 - invariant sequences, 105*t*
 - in phosphatidylserine synthesis, 406*f*
 - in protein kinase pathways, 878
 - synthesis, 459, 459*f*, 1123
- Serine dehydratase, 450*f*, 459, **459**, 459*f*, 463
- Serine protease(s), **88**, 97-108, 98*f*
 - amino acid sequences, 103-105
 - binding characteristics, 100*t*, 101*f*, 101-103, 102*f*
 - covalent catalytic mechanism, 163
 - deficiency, 99*t*
 - exon-intron patterns, **104**, 104*f*
 - inhibitors, 103, 103*t*, 975
 - malfunction, 98cc, 99*t*
 - plasma, inhibitors, 975
 - role of, 99*f*
 - structure, 102*f*, 106, 106*t*
 - structure-function relationships, 103-105
 - in tumor cell metastasis, 99cc
 - zymogen, **101**, 101-103
- Serotonin, **476**, **554**.
 - See also* 5-Hydroxytryptamine
 - degradation pathway, 931, 931*f*
 - neurotransmitter function, 930-931
 - oxidative deamination, 931, 931*f*
 - as secretagogue, 1061*t*, 1061-1062
 - and sleepiness, 476
 - structure, 1062*f*
 - synthesis, 468, 476, 476*f*, 866, **1122**
 - urinary excretion products, 468*f*
- Serotonin-specific reuptake inhibitors, 930-931
- Serpin(s), **103**, **975**
- Sertraline hydrochloride (Zoloft), 930
- Serum albumin
 - in bilirubin transport, 1018-1019
 - in fatty acid transport, 379
 - steroid hormone binding to, 908-909
 - in triacylglycerol transport, 379
- Severe combined immunodeficiency
 - adenosine deaminase deficiency and, 502
 - gene therapy, 793cc
- Sex hormone-binding globulin, **908**
- Sex hormones, 894, **894**, 896
 - in ovarian cycle, 867*f*, 867-870
 - synthesis, 898, 900*f*
- SFAs. *See* Fatty acids, saturated
- SGLT. *See* Sodium glucose transporter
- SHBG. *See* Sex hormone-binding globulin
- Shine-Delgarno sequence, **727**
- Shock, 1026cc
- Shuttle vectors, **784**
- Sialic acid(s), **345**, 345-346, 426-427.
 - See also* *N*-Acetylneuraminic acid
- Sialidosis, 349cc
- Sickle cell anemia, 42cc, 827
 - prenatal diagnosis of, 828cc
 - single base pair change in, 828
- Side chain cleavage, of cholesterol, 896, **990**, 991*f*
- Sideroblastic anemia, **1122**
 - factors, 691, 695
 - subunit, 691
- Signal amplification, biochemical mechanisms, 920
- Signal peptidase, 736
- Signal peptide, **735**, 736*f*
- Signal recognition particle, **735**, 736*f*
- Signal recognition particle receptor, **735**
- Signal transduction, **840**
 - biochemical mechanisms, 920
 - inositides in, 399-401
 - in muscle contraction, 946
 - in vision, 936-937
- Silent mutations, **721**
- Simian virus 40, in expression vector, 785
- Single-copy DNA, 615
- Single-strand binding proteins (SSB), **647**, **648**
- Single-strand conformation polymorphism, **775**
- Site-directed mutagenesis, **786**, 786-790
 - of herpes simplex virus type I glycoprotein D, 789cc
 - of single nucleotide, 787-790
- Site-specific recombination, **662**, 662*t*, 668-669, 669*f*
- Skeletal muscle. *See also* Muscle
 - contractile proteins, molecular weights, 948*t*
 - contraction. *See* Muscle contraction
 - glycogen degradation in, regulation, 328-329, 329*f*
 - structure, 946, 947*f*
- Skin pigmentation, 467cc
- Sleep, tryptophan metabolism and, 476
- Sliding filament model, for muscle contraction, **946**
- Slipped, mispaired DNA (SMP-DNA), **601**, 602
- Slow-reacting substance of anaphylaxis (SRS-A), **439**
- Small cytoplasmic RNA, 678*t*
- Small intestine, **1057**
 - amino acid and peptide transport in, 1072cc, 1072-1073
 - functions, 1057, 1058*f*, 1059
 - pancreatic zymogen activation in, 1071-1072
 - saccharidases, 1075, 1076*t*
- Small nuclear ribonucleoproteins, **705**
- Small nuclear RNA, 678*t*
- Small nucleolar ribonucleoprotein complexes, **702**
- Smoking, effects on vitamin C serum levels, 1127
- Smooth endoplasmic reticulum, 16
- Smooth muscle, contraction, regulation, calcium in, 959, 959*f*
- snRNPs. *See* Small nucleolar ribonucleoprotein complexes
- snRNPs. *See* Small nuclear ribonucleoproteins
- Soaps, 1143
- Sodium
 - in acid-base imbalance, 1050-1052
 - active transport, 206
 - in enterocytes, concentrations and electrical potentials of, 1064-1065, 1065*f*
 - secretion, regulation, 436
 - transport across plasma membrane, erythrocyte ghost studies, 207-208, 208*f*
 - intestinal, 1064-1065
 - in mammalian cells, 211*t*
- Sodium, hydrogen (Na⁺, H⁺) pump, 211*t*
- Sodium, potassium (Na⁺, K⁺) pump, **206**, 206-207, 207*f*, 211*t*, **921**
- Sodium bicarbonate reabsorption, **1043**, 1044*f*
- Sodium channel myotonia, 956cc-957cc
- Sodium channels, **201**
 - intestinal epithelial, **1064**
 - ligand gated, 942
 - in nerve impulse transmission, 921, 922*f*
 - of photoreceptors, 942
 - regulation, 201-202
 - structure, 201-202, 202*f*
 - voltage gated, **921**
- Sodium chloride
 - absorption, 1064-1065
 - electrogenic, 1064-1065, 1065*f*
 - secretion, epithelial, 1066*f*, 1066-1067
 - transepithelial movement, **1064**
- Sodium dodecyl sulfate, **72**
- Sodium glucose transporter, 1067, 1068*f*, **1069**, 1076, 1077*t*
 - SGLT1, properties, 1076, 1077*t*
- Sodium lactate, reactions with water, 5*f*
- Sodium-bile acid cotransport system, **1084**
- Sodium-dependent transport systems, **1073**
- Sodium-glucose cotransport, 1067-1068, 1068cc
- Sodium/hydrogen (Na⁺/H⁺) exchange, 1065, **1065**, 1065*f*
- Soft clot, of fibrin, 966, 967*f*
- Solenoid arrangement, **607**
- Solute(s)
 - in cellular environment, 4-12
 - epithelial transport, **1063**, 1063*f*
- Somatocrinin. *See* Growth hormone-releasing hormone
- Somatomedins, **829**
- Somatostatin, 932*t*
 - actions, 847*t*
 - source, 847*t*
 - structure, 858, 858*t*
- Somatotropin, 829
- Sorbitol
 - and diabetes, 551cc
 - formation, 308*f*
 - synthesis, 935
- SOS postreplication repair, **634**, 642, 642*f*
- Southern blot technique, 774*f*, 774-775
- Southern hybridization, 828
- Specific activity, **74**
- Specific drug resistance, 521
- Specificity
 - of biological molecules, factors determining, 347
 - enzyme, 128-129
- Spermidine, synthesis, 458, 472-473
- Spermine, 458, 472-473, **499**
- Sphinganine, **421**, 421*f*
- D-4-Sphinganine. *See* Sphingosine

- Sphingolipid(s), **184**, 420-422, 1143, 1144-1145
- catabolism, pathway, 427-431, 428*f*
 - concentrations, 421
 - diseases related to, 427-431
 - in membranes, 184-185
 - storage, diseases, 429*t*
 - structure, 423*f*
- Sphingolipidoses, 396, 427-431, **429**, 429*t*
- Sphingomyelin, 421-422, 1144-1145
- charge on, 184*t*
 - in Niemann-Pick disease, 422
 - structure, 184, 185*f*, 423*f*
 - synthesis, 422, 424*f*
- Sphingomyelin synthase, **422**
- Sphingomyelinase, 430*f*
- deficiency, **430**
- Sphingosine, **184**
- biosynthesis, 420-421
 - derivatives, 421
 - structure, 184*f*, 420*f*
- Spina bifida, 463cc
- Spinocerebellar ataxia, 602cc
- Splice recombinant heteroduplexes, **665**, 665*f*
- Splice recombinants, **667**
- Spliceosome, 706
- Splicing, of DNA, **613**
- Spur cell anemia, 195cc
- Squalene, **413**, 1145
- in cholesterol synthesis, 413-415
 - formation, 413*f*
 - structure, 413*f*
- Squalene 2,3-epoxide, in lanosterol synthesis, 413*f*
- Squalene oxidocyclase, 414*f*
- Squalene synthase, **413**
- SRP. *See* Signal recognition particle
- SSCP. *See* Single-strand conformation polymorphism
- ssDNA, invasion, **666**
- Stable chair configuration, 161*f*
- Stacked conformation, **569**
- Stacking interactions, **576**
- StAR protein. *See* Steroidogenic acute regulatory protein
- Starch, **270**, **1073**, 1073-1074, 1075*f*
- Start signal, **719**
- Starvation, 527cc, **1089**
- cerebral glucose metabolism and, **920**
 - fuel supply during, 389
 - and ketosis, 389-390
 - and nitrogen balance, 447
 - physiological ketosis in, 390
 - substrate and hormone levels in blood during, 537*t*
- Starve-feed cycle, **526**, 526*f*, 528-538
- Steady state, **137**
- Stearic acid, 1143
- Stearoyl CoA desaturase, 372, **372**
- Steatorrhea, **1082**
- Stem-loop structures, 696*f*, 1006
- Stereo tracing, of HIV protease structure, 78*f*
- Stereochemistry, 1139
- Stereospecificity, **143**
- Steric hindrance, **67**, 120*f*
- Steroid hormone receptor(s), 909-914
- activation, 914-915
 - antigenic domains, **913**
 - autoregulation, **915**
 - DNA-binding domain, **913**, 913*f*
 - DNA-binding form, 909*f*, **910**
 - downregulation, 914-915
 - functional domains, **913**, 913*f*
 - genes, 894, 913, 914*f*
 - ligand-binding domains, **913**, 913*f*
 - model of, 913*f*
 - non-DNA-binding forms, **909**, 909*f*, 914, 915*f*
 - transcriptional effects, positive and negative, 911, 912*f*
 - upregulation, 914-915
- Steroid hormones, **840**, **1110**, 1143, **1145**.
- See also* Corticosteroid(s)
 - action, model for, 909, 909*f*
 - binding, to serum albumin, 908-909
 - binding proteins, 908-909
 - carbon number, 896
 - cardiotonic, **207**
 - classes, 896
 - excretion pathways, 901, 902*t*
 - functions, 895*t*
 - hormone response elements, **910**, 911*t*
 - inhibition of prostaglandin production, 435
 - metabolic inactivation of, 901, 902*t*
 - placental, 552
 - production, during pregnancy, 993cc
 - in programmed cell death, 915-916
 - receptor binding, 909-913
 - release, regulation, cell-cell communication and, 901-908
 - secretion, 895*t*
 - structure, 894-896, 895*t*, 897*f*
 - synthesis, 894, 896-901, 899*f*, 900*f*
 - in adrenal gland, 990, 991*f*
 - in corpus luteum, 896-898
 - cytochrome P450 in, 990-992
 - feedback regulation, 843*f*, 907
 - hormonal regulation, 896, 898*f*, 901-908, 903*t*
 - regulation, cell-cell communication and, 901-908
 - transport, in blood, 908-909
 - X-ray crystallography, 897*f*
- Steroid nucleus, 894*f*
- Steroid antiinflammatory drugs, 435
- Steroidogenic acute regulatory protein, **896**, 898*f*, 901
- Sterols, 231, 1145
- Stomach, functions, 1057, 1058*f*
- Stop codon, 733
- Stop signals, **719**
- Strand displacement, **663**
- Strand invasion, **663**, 666
- Streptokinase, and blood clots, **172**
- Streptomycin, effects on protein synthesis, 733-734, 734*t*
- Stress
- bacterial response to, 815
 - metabolic, nutritional considerations in, 1133
 - metabolic effects, 553, 554*f*
 - response to, 853
- Stress hormone, aldosterone as, 905
- Stringent control, **766**
- Stringent factor, **815**
- Stringent response, **815**
- Structural motifs, **44**
- β -Structure, 44, 45*f*, 79*f*
- Strychnine, 923, **923**, 923*f*
- Subacute cerebellar degeneration, in Lambert-Eaton myasthenic syndrome, 927cc
- Subacute necrotizing encephalomyelopathy, 258cc
- Subclinical nutritional deficiencies, **1108**
- Substance P, 848*t*, **932**, 932*t*
- Substrate(s), **128**
- binding site, **128-129**, 152cc, **155**
 - blood levels, 537*t*
 - complementarity with enzyme, 156-158
 - concentration, and reaction order, 168*f*
 - exogenous, **992**
 - and related enzymes, 17*f*
 - specificity, of enzymes, 156-158
 - strain, **156**, 156*f*, 156-158, 160-163, 161*f*
 - suicide, 150, **986**
- Substrate shuttle mechanisms, across inner mitochondrial membrane, **243**, 244*f*
- Substrate-bridged complexes, 146
- Substrate-level phosphorylation, **262**, **276-278**
- Succinate, **236**
- Succinate dehydrogenase, 148, **148**, **236**
- Succinyl CoA, **234**, 234-236, 236*f*, 479*f*, 1012
- Succinyl CoA synthetase, 235
- Succinylcholine, **203**
- Sucrase, 1076*t*
- Sucrase/isomaltase, 1059*t*
- Sucrose, 1074*t*, 1142
- Sucrose- α -glucosidase. *See* Sucrase
- Sudden infant death syndrome, 385cc
- Sugar(s). *See also* Carbohydrate(s)
- group translocation, in bacteria, 210
 - interconversions, 341-346, 342*f*
 - simple. *See* Monosaccharides
 - transport, in mammalian cells, 211*t*
- Sugar rearrangement system, **338**, 339*f*
- Suicide substrates, 150, **986**
- Sulfá antibiotics, and hemolytic anemia, 338
- Sulfá drugs, 149-150
- Sulfánilamide, 149-150, 150*f*
- Sulfatase(s), 17*t*, **356**
- Sulfate, 473*f*, **474**
- Sulfated tyrosine, **1062**
- Sulfátide(s), **185**, **425**, 1145
- in metachromatic leukodystrophy, 425
 - structure, 185, 185*f*
- Sulfhemoglobin, 1030cc
- Sulfite, **474**
- Sulfogalactocerebroside. *See* Sulfatide
- Sulfur amino acids, diseases, 471cc
- Superhelical structure, **53**, 53*f*
- Superoxide dismutase, 1131
- Suppressor mutation, **723**
- Surfactant, **398**
- in atelectasis prevention, 399*f*
 - deficiency, in respiratory distress syndrome, 400cc
- Surgery, metabolic effects, 553
- SV-2, **927**
- Svedberg coefficient, **71**, 71*f*, 72*t*
- Symport, **200**, 200*f*, 209-210, 211*t*
- Synapses, **663**, 923-924
- chemical, **923**
 - electrical, **923**

Synapsin, **925**, 926*f*

Synaptic function, **924**, 927-931

Synaptic vesicles, **925**, 925*f*

- docking, **927**
- proteins, 925, 925*f*, 925*t*, 926*f*

Synaptobrevin/VAMP, **927**

Synaptophysin, **926**

Synaptotagmin, **926**

Syndecan, 356

Syntaxin, **927**

Synthesis, rate, 68*f*

Synthetase, **133**

T

T-conformational state, **123**, 1029

$t_{1/2}$ (reaction half life), 134

Tangier disease, 59cc

Target cell, **842**

Target site, **669**

TATA box, **699**

- locus, **651**

Taurine, 473*f*, **474**, **1078**

Taurocholic acid, 211*t*, **418**

Tauroconjugates, 1079, 1080*t*, **1084**

Tautomeric structures, 1146-1147

Tay-Sachs disease, 427, 429*t*, 430

TCA cycle. *See* Tricarboxylic acid cycle

TCDD. *See* 2,3,7,8-Tetrachlorodibenzo-*p*-dioxin

Teenagers, nutritional considerations for, 1133

Telomerase(s), **659**, 659-660, 660*f*

- activity, in cancer, 658cc

Telomeres, 599, **603**, **659**, 660*f*

Telopeptides, **54**

Temperature, and enzyme catalytic activity, 165-166, 166*f*

- in hemolytic anemia, 166cc

Template, **623**

10-nm fiber, **607**

Ter locus, **651**

Terminal protein (TP), **659**

Terminal repeat sequences, 816

Termination codons, **719**

- disorders, 722cc

Termination sequence, 685

Terminator utilization substance, **651**

Terpenes, 1143, 1145

Testis, carbohydrate metabolism in, 270

Testosterone, 894, **896**

- excretion pathway, 902*t*
- functions, 895*t*
- secretion, 862, 864*f*, 895*t*
- structure, 895*t*
- synthesis, **898**, 903*t*, 906, **990**

Tetanus toxin, binding to vesicle-associated membrane protein, 927

Tetra-*N*-acetylchitotetrose-*d*-lactone, 160*f*

2,3,7,8-Tetrachlorodibenzo-*p*-dioxin, **985**

Tetracyclines, effects on protein synthesis, 734, 734*t*

Tetrahedral intermediates, 164

Tetrahydrobiopterin, 501*f*, **996**

Tetrahydrobiopterin dependent enzyme, **464**, 465*f*

Tetrahydrofolate(s), **460**, 461*f*, **494**, **1123**

- active center, 462*f*
- in amino acid metabolism, 460-463, 462*f*
- and *de novo* purine and dTMP synthesis, 518-519, 519*f*
- formation, inhibition, 518*f*
- interconversion, 462*f*
- reduction reactions involving, 463*f*

Tetrahydrofolate reductase, site-directed inactivation, 151*f*

Tetrahydrofolic acid, 150*f*

Tetrahymena, rRNA precursor, self-splicing, 686, 687*f*

Tetraiodo-L-thyronine. *See* Thyroxine

Tetrose, formation, 338, 339*f*

TFIIH factor, **638**

α -Thal 1 or 2, 828-829

Thalassemia, 722cc, 827

- α , 828-829
- β -, 704, 705cc, 706, 707*f*, 828-829
- mutations in, 828-829
- prenatal diagnosis, 829cc

Theophylline, 688-689, 689*f*

Thermodynamics, **220**, 220-225

- first law of, **220**
- second law of, **220**

Thermolysin, **144**

THF. *See* Tetrahydrofolate(s)

Thiamine. *See* Vitamin(s), B₁

Thiamine pyrophosphate, 228*t*, **234**, 1119, **1119**, 1119*f*

Thiamine triphosphate, 1119

Thick filaments, myosin in, 949-951

Thin filaments, **948**

Thiocysteine, **474**, 474*f*

Thioesterase(s), **369**, **374**

6-Thioguanine, in leukemia treatment, **517**

Thiol esters, as energy rich compounds, 223*t*

Thiolysis, **381**

Thionyl peptides, actions, 439-440

Thioredoxin, **507**, **971**

Thioredoxin reductase, **507**

Thiosulfate, synthesis, 474*f*

Threonine, **27**, **350**, 351*f*, **463**, 464*f*, 878

Thrombin, 166, 965

- in blood coagulation, 966-967, 974*f*, 974-975
- in coagulation promotion and clot dissolution, dual role of, 972-974
- in fibrin formation, 964-966, 965*f*

α -Thrombin, active site cleft, 965-966, 966*f*

Thrombin receptor, 967

Thrombomodulin, 356, **973**

Thrombosis, and defects of protein C pathway, 971cc, 974

Thromboxane(s), 431-436, **434**, 1143, **1144**

- structure, 1144
- TXA₂, 968, 1099cc
- TXB₂, synthesis, 435, 435*f*

Thromboxane A synthase, **434**

Thudichum, J.L.W., 920

Thymidine kinase, gene, as selectable marker for transfected cells, 785

Thymidylate, synthesis, **463**

Thymidylate synthase, **508**

Thymine, degradation, 510*f*

Thymopoietin, 848*t*

α -Thymosin. *See* Thymopoietin

Thyroglobulin, in thyroid hormone synthesis, 854-856

Thyroid gland, iodine metabolism and, 1130

Thyroid hormone(s), 894

- actions, 847*t*
- iodine in, 1130-1131
- secretion, 862, 863*f*
- source, 847*t*
- structure, 856*f*
- synthesis, 469, 854-856, 856*f*

Thyroid hormone receptor(s), **912**, 914

Thyroid-stimulating hormone, 846

- actions, 847*t*, 862, 883*t*, 884*t*
- hormone-receptor interactions, 872-873, 874*f*
- source, 847*t*

Thyrotropin. *See* Thyroid-stimulating hormone

Thyrotropin-releasing hormone, 844*t*, 932*t*

- actions, 847*t*, 884*t*
- source, 847*t*
- structure, 857*t*

Thyroxine, **533**, 1130-1131

- and human growth hormone gene expression, 830
- release, 856, 857*f*
- structure, 856*f*
- synthesis, 854-856, 856*f*

Tiazofurin, structure, 520*f*

Tiazofurin adenine dinucleotide (TAD), **520**

Tight junctions, **1063**, 1066-1067

Tissue, rapidly growing, characteristics, 512-513

Tissue factor, **961**, 961*t*, 963*f*, 963-964, 964*f*

Tissue hypoxia, **1029**

Tissue plasminogen activator, 975*f*, 975-976

- and blood clots, **172**
- recombinant (rt-PA), 98cc

T_m . *See* Phase transition temperature

TNF. *See* Tumor necrosis factor

α -Tocopherol, **1116**

Topaquinone, **469**, 469*f*

Topoisomerase(s), **588**, 592-595

- in cancer treatment, 594cc
- type I, **592**, 592*f*, **649**
- type II, **592**, 593*f*, **648**, 648*f*

Total carbon dioxide, **1032**

Total parenteral nutrition, and zinc deficiency, 1131

Toxins

- effects on protein synthesis, 733-735
- RNA polymerase and, 691, 692cc

t-PA. *See* Tissue plasminogen activator

TPP. *See* Thiamine pyrophosphate

Trace minerals, 1130-1132

Transaldolase, **338**, 339-340

Transamidation, **344**

Transaminase(s), 141, 141*f*, **163**.

- See also* Aminotransferase(s); Transamination

Transamination, **226**, **448**, 448*f*.

- See also* Aminotransferase(s)

Transcellular epithelial transport, **1063**, 1063*f*

Transcortin, **908**

Transcription, **312**, **689**, 689-699

- in bacteria, 800-802
- elongation, **689**, **695-696**
- in eukaryotes, 696-699
- initiation, **689**, **695**
- in prokaryotes, 692-696, 693*f*
- of ribosomal RNA genes, 697-698
- by RNA polymerase II, 698, 698*f*
- by RNA polymerase III, 699, 700*f*
- termination, **689**, **696**, 696*f*

- Transcription factor(s), **696**, 911
- in carcinogenesis, 701cc
 - for class III eukaryotic gene, 699, 700*f*
 - interaction with promoters, 698, 698*f*
- Transcription factor binding element, **108**
- Transducin, **942**, 944*t*
- Transepithelial NaCl movements, **1064**
- Transfection, **784**, 784-785
- Transfer RNA, 679, **682**, 714
- aminoacylation, 721-724, 724*f*
 - cloverleaf structure, 682*f*, 683
 - cytoplasmic, 678*t*
 - functions, 678*t*, 682-683, 717-718
 - initiator, **725**
 - mitochondrial, 678*t*
 - precursors
 - additions, 700-701, 702*f*
 - cleavage, 700, 702*f*
 - intron removal from, 700, 702*f*
 - size, 678*t*, 683
 - structure, 717-718
 - synthesis, regulation, 815
- Transferase(s), **131-132**, 132*f*
- Transferrin, **1003**, 1020
- Transferrin receptor, **1003**, 1007*f*
- Transformation
- bacterial, with recombinant DNA, 767
 - of cells, by DNA, **564**
- Transformation-linked cell changes, **513**
- Transforming agent, DNA as, **564**, 565
- Transformylase, 733
- Transgenic animals, **794**, 794*f*, 795cc, **835**, 836
- Transglutamidase, 966, 967, 967*f*, 968*f*
- Transition metal, 146
- Transition state (T_s), **159**, 163
- Transition state analogs, **160**, 160*f*
- Transitory spaces, **196**
- Transketolase, **338**, 338-340, 1119
- Translation, **714**
- colinearity with mRNA, 724-725
 - directional, 724-725
 - elongation factors. *See* Elongation factor(s)
 - energy cost of, 733
 - initiation, 725-727, 726*f*
 - regulation, 748-750
- Translation initiation signal, **714**
- Translesion replication, **642**
- Translocase, **198**, 730
- F type, 206
 - P type, 206
 - V (vacuole) type, 206
- Translocation, in membrane transport, **199**, 199*f*
- Translocation mechanism, **198**
- Translocator, **198**
- Translocon, **735**
- Transmembrane domains, of receptors, **875**, 875*f*
- Transmembrane potential, 200, **201**
- in neurons, 921-923
- Transport. *See also* Membrane transport active, 198, **200**
- gastrointestinal, **1063**, 1063*f*
 - passive, 199*t*, **200**
 - mediated, 199*t*, **204**
- Transporter(s)
- acidic amino acid, **1073**
 - active mediated, **206**
 - Ca²⁺, **208**
 - citrulline/ornithine exchange, **455**
 - Cl⁻/HCO₃⁻, 211*t*
 - dopamine, **929**
 - E₁-E₂ type, **207**
 - glucose, 204, **272**, **330**, 1068*f*, **1069**, 1076, 1077*t*
 - H⁺, K⁺, 211*t*
 - membrane, **198**.
 - See also* Cotransporter(s); Membrane transport, systems
 - monosaccharide, **1076**
 - sodium-independent, **1076**
- facilitated-diffusion type, **1076**
- Na⁺, HPO₄²⁻, 211*t*
 - primary active, **206**
 - secondary active, **206**
 - sodium glucose, 1067, 1068*f*, **1069**, 1076, 1077*t*
 - SGLT1, properties, 1076, 1077*t*
 - sodium-independent, **1073**
 - tricarboxylate, **245**
- Types F, P and V, 206
- Transporter system, **198**
- Transposable elements. *See* Transposon(s)
- Transposase(s), **662**, **669**, 816
- Transposition, **662**, 662*t*, 669-670
- Transpositional site-specific recombination. *See* Transposition
- Transposon(s), **614**, **659**, **662**, **669**, **816**, 816-818, 818*f*
- and antibiotic resistance, 670cc
 - composite, **670**
 - direct repeats in, 670*f*
 - genomic rearrangements promoted by, 671*f*
 - structure, 816, 816*f*
 - Tn3*, 816-818, 817*f*
- Transsulfuration, **470**, 471cc
- Transverse tubules, **947**, 947-948, 948*f*
- Trehalase, 1059*t*, **1076**, 1076*t*
- Trehalose, 1074*t*, 1076
- Triacylglycerol(s), **362**, **364**, 364-365, 375-377, 397, **1077**, **1097**, 1144
- blood, hydrolysis, 380-381
 - digestion, 1077, 1078*f*
 - elevation, 380cc
 - hydrolysis, 1078, 1078*f*
 - metabolism, 362, 381*t*
 - mobilization, 376-377
 - serum level, carbohydrate intake and, 1100, 1100cc
 - synthesis, 375*f*, 376, 376*f*, 377*f*, 403*f*, 552-553
 - transport, 379
- Tricarboxylic acid cycle, **231**, 231*f*, 231-238, 453, **920**, 920-921
- acetyl CoA and, oxidation of acetyl group of, 231, 237-238
 - ATP synthesis in, 238
 - enzymatic reactions in, 232*f*, 232-237
 - versus pentose phosphate pathway, 336
 - regulation, 238, 239*f*
- Trichothiodystrophy (TTD), 638cc
- Trihydroxyphenylalanylquinone. *See* Topaquinone
- Triiodothyronine, **533**, 1130-1131
- release, 856, 857*f*
 - structure, 856*f*, 914, 914*f*
 - synthesis, 854-856, 856*f*
- Trimethyllysine, **535**
- Trinucleotide repeat expansions, in Huntington's disease, 823cc
- Triose, formation, 338, 339*f*
- Triose phosphate isomerase, 275
- Tripalmitin, metabolism, free-energy changes associated with, 222*t*
- Triple-stranded intermediate, **667**, 667*f*
- Trisaccharides, 1075
- tRNA. *See* Transfer RNA
- tRNA nucleotidyltransferase, 700-701
- tRNA^{Trp} synthetase, 811
- Tropomyosin, 55, 55*f*, 708, 708*f*, 948*t*, **952**
- Troponin, 948*t*, **952**
- C, **209**
 - subunits, **953**, 953*f*
 - as markers for myocardial infarction, 954cc
- Trypsin, **75**, 107*f*, **1071**, 1071*t*
- Trypsin inhibitor, 102*f*, **1071**
- Trypsinogen, 102*f*, **1071**
- Tryptophan, **25**, 474-476, 475*f*, **807**, 1121
- Tryptophan dioxygenase, **474**
- Tryptophan operon
- attenuation, model for, 811-812, 812*f*
 - attenuator site, 810*f*, 810-813
 - secondary structure, 811, 811*f*
 - control by repressor protein, 808-810
 - control elements, nucleotide sequence of, 809, 809*f*
 - control sites, 808-813
 - E. coli*, 807-813, 809*f*
- Tryptophan oxygenase. *See* Tryptophan dioxygenase
- Tryptophan pyrrolase. *See* Tryptophan dioxygenase
- TSH. *See* Thyroid-stimulating hormone
- Tuberculosis treatment, 450, 692cc
- d*-Tubocurarine, **203**
- Tubulin, **20**, **709**
- Tumor(s), clonal origins, determination using RFLP, 776cc
- Tumor cell(s)
- biochemical changes in, 513
 - metastasis, 99cc
- Tumor necrosis factor, TNF- α , **548**, **553**, 553cc
- Tumor suppressor protein p53, 701cc
- DNA, structure, 113*f*
- Tumor-promoting agents, **325**
- Tunicamycin, 737
- Turnover number, **136**
- Tus protein, **651**
- Tyrosinase, **468**, 468*f*
- Tyrosine, **25**, **463**, 463-469
- degradation, 466*f*
 - derivatives, 466-468
 - metabolism, 463-464
 - disorders, 467cc
 - in protein kinase pathways, 878
 - sulfated, **1062**
 - therapy with, 467
- Tyrosine aminotransferase, **465**, 466*f*
- deficiency, 467cc
 - Tyrosine hydroxylase, **466**
 - Tyrosinemia(s), 467cc
 - Tyrosine-specific kinases, **878**

U

U (units of enzyme activity), 136

UAA codon, **719**

UAG codon, **719**

Ubiquinone. *See* Coenzyme Q

Ubiquitin, **453, 751**, 751*f*, 751-752

UGA codon, **719**

Ultracentrifugation, 71

Ultraviolet light spectroscopy, 79, 79*f*

UMP. *See* Uridine 5'-monophosphate

Uncompetitive inhibitor, **149**

Uncouplers, **260**

Uncoupling protein, **205**

Undernutrition, **1088**

Unilamellar vesicles, 189

Uniport, **200**, 200*f*, 204, 212*r*

Unsaturated compounds, **1138**

Uracil, **493**, 510*f*, 679-680

Uracil DNA glycosylase, **635**, 635*f*

Urea, 211*t*, 453, 454*f*, 455, **540**.

See also Urea cycle

Urea cycle, **453-454**, 453-456, 455*f*

alternatives to, 456*f*

enzymes, 454, 455

deficiencies, 456, 457*cc*

metabolic disorders, 455-456

Ureagenesis, **245**

Urease-containing bacteria, **454**

Uric acid, **502**

elevation, in gout, 498*cc*.

See also Hyperuricemia

production, 501-503

Uridine 5'-monophosphate, **503**, 504-506, 505*f*

Uridine phosphorylase, **509**

Uridopropionase, **511**

Urine

acidity

titratable, **1045**

total, **1045**, 1045-1046

formation, 1043

volume, 1043

Urobilinogens, **1018**

Urobilins, **1018**

Uroporphyrinogen(s), **1011**, 1013-1014, 1016*f*

Uroporphyrinogen decarboxylase, 1014-1015

Uroporphyrinogen III cosynthase, **1014**

UTP

in CTP formation, 505*f*

formation from UMP, 505*f*

in glycogen synthesis, 219*f*, **220**

UV. *See* Ultraviolet

UvrA protein, **636**

UvrB protein, **636**

UvrC protein, **636**

UvrD protein, **636**

V

V class enzymes, **152**

V regions, **90**

Vacuolar proton pump, **927**

Valine, **25**, 26*f*, 448*f*, 453, 476-477, 478*f*.

See also Branched-chain amino acids

Valinomycin, 212, **212**, 212*f*, 212*t*, 213*f*

Valproic acid, **931**

van den Bergh reaction, **1018**

Van der Waals contact distance, **67**, 67*t*, 67*f*

Van der Waals dispersion forces, **66-67**, 67II+>*f*, 575-584, 1139

Variable (V) regions, **90**

Variable surface glycoprotein, **401**

Variagate porphyria, 1012*r*, **1016**

Vasoactive intestinal polypeptide, 932*r*, **1062**

actions, 848*t*

as secretagogue, 1061*r*, 1062

source, 848*t*

structure, 1062*t*

Vasoconstriction, in blood coagulation, 960

Vasopressin, 842, 844*r*

actions, 847*r*, 848*t*, 880-883, 882*f*, 883*r*, 884*t*

secretion, 881-882, 882*f*

source, 848*t*

structure, 858, 858*t*

synthesis, 851, 851*f*

Vectors, 780, 783

Vegetarian diet(s), **1091**

nutritional considerations with, 1133, 1134*cc*

and protein-energy requirements, 1091, 1091*cc*

serum cholesterol and, 1100

and vitamin B₁₂ (cobalamine) deficiency, 1126

Velocity profile of reaction. *See* Reaction(s), velocity

Versican, 356

Very low density lipoprotein(s), **58, 379**, 529.

See also Lipoproteins

in obesity, **1095**

Vesicle-associated membrane protein, 927

Vibrio cholerae, diarrhea caused by, 1068*cc*

Vibrio vulnificus, 1003*cc*

VIP. *See* Vasoactive intestinal polypeptide

Viruses, in expression vectors, 785

Vision, 932-946

genes for, chromosomal location, 944-945, 946*cc*

loss, 481*cc*

signal transduction in, 936-937

Visual cycle, 943, 943*f*, 944*r*

Visual pigments, 937, 944

absorption spectrum, 941*f*

amino acid sequences, 944, 945*f*

genes, 944-945

Visual proteins, **1110**

Vitamin(s)

A, **938**, 1109-1111

deficiency, **1111**

dietary sources, 1111

mechanism of action, 1111

metabolism, 1110, 1110*f*

structure, 1109, 1110*f*, 1145-1146

toxicity, **1111**

in vision, 1110-1111, 1111*f*

absorption, 1082

B₁ (thiamine), **1119**

deficiency, **1119-1120**

requirements, 1120-1121

structure, 1119, 1119*f*

therapy with, 479*cc*

B₆ (pyridoxine), 142, **1121**.

See also Pyridoxal phosphate

deficiency, 450, 476, **1122**

requirements, 1122

and anticonvulsant therapy, 1118*cc*

for oral contraceptive users, 1124*cc*

status, evaluation, 1122, 1124*cc*

structure, 1121, 1121*f*

B₁₂ (cobalamine), **1125**

deficiency, **1125, 1126**

dietary sources, 1126

metabolic role, in one-carbon metabolism, 1123*f*

metabolism, 1125-1126, 1126*f*

structure, 1125*f*, 1125-1126

C (ascorbic acid), 536, **1127**

and common cold, 1127-1128

deficiency, **1127**

functions, 1127-1128

megadoses, **1128**

precursors, 344

requirements, 1127

serum levels, factors affecting, 1127

transport, in mammalian cells, 211*t*

D

in calcium homeostasis, 1112-1114, 1115*f*

deficiency, **1114**

dietary sources, 1112, 1114

endocrine system, 906*f*, **907**

parathyroid hormone and, 1112-1114

requirements

and anticonvulsant therapy, 1118*cc*

in newborn, 1117*cc*

structure, 1113*f*

synthesis, 420, 1111-1114

toxicity, **1114**

D₁ (ergocalciferol), **420, 1112**

D₃ (cholecalciferol), **420**

actions, 907

metabolism, 894, **992**

photochemical conversion of 7-dehydrocholesterol to, 419*f*

structure, 1145

synthesis, 907-908, **1111**

deficiency, in alcoholism, 1120*cc*

E, **1114**

as antioxidant, **1116**

deficiency, 1114

requirements, 1116

structure, 1145-1146

supplementation, 1116

in newborn, 1117*cc*

tocopherols in, 1114-1116

toxicity, 1116

fat-soluble, 1109-1118

structure, 1145-1146

K (phytonadione), **1116**, 1116-1118

deficiency, **1117**, 1117*cc*, 1117-1118

epoxide, 971

function, 1116, 1116*f*

in protein glutamyl carboxylation reactions, 970*f*, 970-971

requirements

and anticonvulsant therapy, 1118*cc*

in newborn, 1117*cc*

synthesis, 1117

K₁ (phytylmenaquinone), **1116**

K₂ (multiprenylmenaquinone), **1116**, 1145-1146

requirements, anticonvulsants and, 1118*cc*, 1125

water-soluble, 1118-1119

coenzyme function, 1118

deficiencies, 1118

energy-releasing, 1118-1122

versus fat-soluble vitamins, 1118

hematopoietic, 1123-1126

Vitreous humor, **932**, 933

VLDL. *See* Very low density lipoprotein(s)

V_{max} , 137-138, 152

Voltage-gated channels, **201**, **921**, **922**, 923

disorders, 956cc-957cc

Von Gierke's disease, 317cc

von Willebrand factor, **967**

VSG. *See* Variable surface glycoprotein

vWF. *See* von Willebrand factor

W

Warfarin, **971**

Water, **4**, *4f*

in cellular environment, 4-12

diffusion, through membranes, 196

molecules, *4f*, 4-5

reactions with sodium lactate, *5f*

solvent properties, 5, **5**

as weak electrolyte, 6

Waxes, 1143

Wear and tear pigment (lipofuscin), **19**

Werner's syndrome, 639cc

Wernicke-Korsakoff syndrome, **1120**, 1120cc

WIC (Women and Infant Children) program, 1128, 1130

Wilson's disease, **1132**

Wobble hypothesis, 719, *719t*

Wolman's disease, 19cc

Women, nutritional considerations for, 1133

X

Xanthine, 492

Xanthine oxidase, **502**

Xenobiotic regulatory elements, **986**

Xenobiotic-metabolizing enzyme(s), 993, *994t*

Xenobiotics, 992, **992**, *994t*

Xeroderma pigmentosum, **636**, 638cc

X-linked spinal and bulbar muscular atrophy, 602cc

X-ray crystallography, *106t*, *109f*, 116, *897f*

X-ray diffraction, **76**, *102f*

XREs. *See* Xenobiotic regulatory elements

Xylitol dehydrogenase deficiency, 345cc

Xylose, UDP-, 344

Xylose 5-phosphate, **338**, 338-340

Xylulose, structure, 1140

Y

YAC. *See* Yeast artificial chromosomes

Yeast(s), 613, 821

Yeast artificial chromosomes, 780-781

Z

Z line, **948**

Z-DNA, *571f*, *573t*, **574**

ZDV (zidovudine). *See* Azidothymidine

Zellweger syndrome, and peroxisome function, 20cc

Zero-order reactions, **135**

Zinc

absorption, **1131**

as cofactor, **1131**

deficiency, **1131**

as Lewis acid, 144, 145, *145f*

Zinc finger(s), **108**, *109f*, *110f*, 913, *913f*

Zinc metalloenzymes, *1071t*, **1072**, 1131

Zinc proteases, **144**

Zona fasciculata cells, in steroid synthesis, 898

Zona glomerulosa cells, in steroid synthesis, 898

Zona reticularis cells, in steroid synthesis, 898

Zonal centrifugation, **585**, 585-586

Zwitterion form, **33**, 33-34, **1146**

Zymogen granules, **1060**

Zymogens, **98**, 743-744, **1060**, 1071-1072

NORMAL CLINICAL VALUES: BLOOD*

INORGANIC SUBSTANCES

Ammonia	12–55 $\mu\text{mol/L}$
Bicarbonate	22–26 meq/L
Calcium	8.5–10.5 mg/dl
Carbon dioxide	24–30 meq/L
Chloride	100–106 meq/L
Copper	100–200 $\mu\text{g/dl}$
Iron	50–150 $\mu\text{g/dl}$
Lead	10 $\mu\text{g/dl}$ or less
Magnesium	1.5–2.0 meq/L
Pco ₂	35–45 mmHg
pH	7.35–7.45
Phosphorus	3.0–4.5 mg/dl
Po ₂	75–100 mmHg
Potassium	3.5–5.0 meq/L
Sodium	135–145 meq/L

ORGANIC MOLECULES

Acetoacetate	negative
Ascorbic acid	0.4–15 mg/dl
Bilirubin	
Direct	0–0.4 mg/dl
Indirect	0.6 mg/dl
Carotenoids	0.8–4.0 $\mu\text{g/ml}$
Creatinine	0.6–1.5 mg/dl
Glucose	70–110 mg/dl
Lactic acid	0.5–2.2 meq/L
Lipids	
Total	450–1000 mg/dl
Cholesterol	120–220 mg/dl
Phospholipids	9–16 mg/dl as lipid P
Total fatty acids	190–420 mg/dl
Triglycerides	40–150 mg/dl
Phenylalanine	0–2 mg/dl
Pyruvic acid	0–0.11 meq/L
Urea nitrogen (BUN)	8–25 mg/dl
Uric acid	3.0–7.0 mg/dl
Vitamin A	0.15–0.6 $\mu\text{g/ml}$

PROTEINS

Total	6.0–8.4 g/dl
Albumin	3.1–4.3 g/dl
Ceruloplasmin	23–43 mg/dl
Globulin	2.6–4.1 g/dl
Insulin	0–29 $\mu\text{U/ml}$

ENZYMES

Aldolase	0–7 U/ml
Amylase	4–25 U/ml
Cholinesterase	0.5 pH U or more/h
Creatine kinase (CK)	40–150 U/L
Lactic dehydrogenase	110–210 U/L
Lipase	2 U/ml or less
Nucleotidase	1–11 U/L
Phosphatase (acid)	0.1–0.63 Sigma U/ml
Phosphatase (alkaline)	13–39 U/L
Transaminase (SGOT)	9–40 U/ml

PHYSICAL PROPERTIES

Blood pressure	120/80 mmHg
Blood volume	8.5–9.0% of body weight in kg
Iron binding capacity	250–410 $\mu\text{g/dl}$
Osmolality	280–296 mOsm/kg H ₂ O
Hematocrit	37–52%

NORMAL CLINICAL VALUES: URINE*

Acetoacetate (acetone)	0
Amylase	24–76 U/ml
Calcium	0–300 mg/d
Copper	0–60 $\mu\text{g/d}$
Coproporphyrin	50–250 $\mu\text{g/d}$
Creatine	under 0.75 mmol/d
Creatinine	15–25 mg/kg body weight/d
5-Hydroxyindoleacetic acid	2–9 mg/d
Lead	120 $\mu\text{g/d}$ or less
Phosphorus (inorganic)	varies; average 1 g/d
Porphobilinogen	0
Protein (quantitative)	less than 165 mg/d
Sugar	0
Titrateable acidity	20–40 meq/d
Urobilinogen	up to 1.0 Ehrlich U
Uroporphyrin	0–30 $\mu\text{g/d}$

*Selected values are taken from normal reference laboratory values in use at the Massachusetts General Hospital and published in the *New England Journal of Medicine* 314:39, 1986 and 327:718, 1992. The reader is referred to the complete list of reference laboratory values in the literature citation for references to methods and units. dl, deciliters (100 ml); d, day.